

LOAN COPY ONLY

**DEMONSTRATION OF A HIGH-PERFORMANCE,
LOW-COST AUTONOMOUS UNDERWATER VEHICLE**

J.G. Bellingham, J.W. Bales, D.K. Atwood, C. Chryssostomidis,
T.R. Consi, and C.A. Goudey

MITSG 93-28

CIRCULATING COPY

Sea Grant College Program
Massachusetts Institute of Technology
Cambridge, Massachusetts 02139

NURP Contract No. BA26RU016101

Project No: 92-MCII-FF-5

45 3

Related MIT Sea Grant College Program Publications

A Small, long-range autonomous vehicle for deep ocean exploration. J.G. Bellingham, C.A. Goudey, T.R. Consi and C. Chrysostomidis. MITSG 93-18J. \$2.

Economic ocean survey capability with AUVs. James G. Bellingham and C. Chrysostomidis. MITSG 93-17J. \$1.

MIT Sea Grant Underwater Vehicles Laboratory. MIT Sea Grant Program. MITSG 93-14. No charge.

Scientific and environmental data collection with autonomous underwater vehicles. MIT Sea Grant Program. MITSG 92-2. \$7.

Development of autonomous vehicles for long-term ocean eddy observation. Michael S. Triantafyllou and Knut Streitlien. MITSG 91-16. \$3.

Please add \$1 for shipping/handling and mail your check to :
MIT Sea Grant College Program, 292 Main Street, E38-300, Cambridge, MA 02139.

DEMONSTRATION OF A HIGH-PERFORMANCE, LOW-COST AUTONOMOUS UNDERWATER VEHICLE

J. G. Bellingham, J. W. Bales, D. K. Atwood, C. Chrysostomidis, T. R. Consi, and C. A. Goudey

M. I. T. Sea Grant College Program

Recent research successes have created the prototype of a new class of autonomous underwater vehicles (AUVs) capable of vastly extending human reach into the ocean in an economical manner. These results have been achieved by academic laboratories, industry, and military researchers. Research at the MIT Sea Grant Underwater Vehicles Laboratory over the last four years has been focused on developing the enabling technologies for low-cost, high-performance AUVs. There are still major research issues to be addressed. However, the technology has progressed to the point where small, long-range AUVs can economically execute missions that are impossible to perform with tethered vehicles (e.g. under-ice operations) or are expensive to carry out with conventional methods (e.g. deep-ocean survey). This paper presents operational results for tests of Odyssey, a prototype high-performance, low-cost AUV.

Background

Historically, most deep-water oceanographic data have been gathered from towed instrument platforms or sleds. Towed platforms are rugged and readily modified to carry different payloads, and place few constraints on payload size, power consumption, or data transmission rate. However, deploying the platform is difficult and time-consuming, and the cable and its handling equipment can cost as much as the instrument platform. The cable presents a hazard to propellers and steering gear, and it may break for a variety of reasons (metal fatigue, abrasion, kinking, sudden loads, etc.). For deep operations the drag from the cable dramatically reduces the towing speed, while constraining the platform trajectories to straight transects either at a fixed depth, or along a tow-yo that stays well above the bottom.

Another class of tethered platform, the remotely operated vehicle (ROV), has been widely recognized as holding the potential for reducing the cost of activities in the ocean. ROVs, commonly used in offshore oil activity, are teleoperated from the surface [Busby, 1987]. For detailed investigations of a local area, ROVs provide many of the advantages of manned submersibles at lower expense and significantly reduced risk. However, ROVs are not useful for large scale lateral surveys because the tether dominates the dynamics of a typical vehicle-tether system for tether lengths longer than 1000 meters. Consequently, elimination of the tether has been recognized as an essential step for improving economy and expanding the portion of the ocean accessible to such large-scale surveys. This is a primary motivation for the development of AUV technology.

Manned access to the abyssal ocean depths can be gained by using deep diving submersibles. Alvin, the deepest diving non-military US research submersible, is rated to 4000 meters and the Shinkai 6500, the deepest diving manned submersible in operation, is rated to 6500 meters depth. Manned submersible operations provide ocean researchers with unparalleled opportunities to observe the marine and benthic life forms, environments, and geology. However, manned submersibles are also expensive to operate and maintain. Operating Alvin typically costs \$21,000 to \$28,000 per day [Travis, 1993], giving an average bottom time of 3-4 hours. The amount of actual bottom time and distance traveled per dive is usually quite

limited, so routine geophysical or water column surveying by these submersibles, although possible, is generally not an efficient or economical use of their capabilities.

The efficiency of tetherless operations at abyssal depths has been well established. The Naval Ocean Systems Center in San Diego [Walton, 1991] estimates a three to four-fold increase in search rates of their AUV compared to deep-towed systems. This is because typical deep-tow speeds are on the order of 2 km/hr, which is easily exceeded by an untethered vehicle. Soviet operations with the *MT-88* demonstrated that, even with equal speeds, a 4 kilometer square area at a depth of 5000 meters can be surveyed two to three times more rapidly with an AUV than with a towed system; the problem faced by the towed system is that it requires 3.5 kilometers to execute a turn for successive passes at the survey area [Ageev, 1990]. Thus AUVs can increase the effectiveness of oceanographic research by a factor of two to ten, depending on the exact circumstances of the mission.

AUVs built for extended range abyssal survey operations include the Advanced Unmanned Search System, AUSS, built and operated by the Naval Ocean Systems Center [Mackelburg, 1991; Walton, 1991], the French vehicle, Epaulard [Grandvaux and Michel, 1979], and the Soviet *MT-88* [Ageev 1990]. Two new vehicles are the MIT Sea Grant vehicle *Odyssey* [Bellingham et. al, 1992a] and the Woods Hole Oceanographic Institution's Autonomous Benthic Explorer (ABE) [Yoerger et al., 1991]. Table 1 compares some critical parameters of these five AUVs. More extensive reviews of existing AUVs are given in [Blidberg, 1991].

Table 1: Comparison of Deep Ocean Extended Survey AUVs

Vehicle	Weight (Kilograms)	Depth Rating (Meters)	Range at Speed (km @ km hr-1)
AUSS	1300	6100	130 @ 13
Epaulard	2900	6000	22 @ 3.5
MT-88	1000	6000	6 @ 3.5
ABE	450	6000	100 @ 1.8
<i>Odyssey</i>	195	6000	180/795 @ 5 (*)

(*) range is 180 km with alkaline-manganese dioxide or silver-zinc batteries, or 795 km with lithium-thionyl chloride batteries given assumptions explained in Appendix B.

Our focus is motivated by a variety of advantages offered by small vehicles. Table 1 highlights the ability to obtain relatively high performance from a small vehicle. Achieving this performance requires custom engineering of the vehicle subsystems to reduce their cost, size, and power consumption. To a large degree, the effort has already been made to develop the base capability. In addition, small vehicles require less support equipment and can be operated off of smaller support vessels. Because of the simplified handling requirements, they can be deployed and recovered in rougher surface conditions. The potential exists for low costs (the cost of the hardware for *Odyssey* is on the order of \$50,000, not including sensors or sophisticated navigation systems). Small vehicles typically have higher thrust to vehicle mass ratios, providing more acceleration capability. This makes them attractive for operations in confined environments or for operations where obstacles cannot be detected reliably at large distances. As a result, small AUVs are likely to be much more robust and operations will be much less expensive than for large AUVs, leading to more economical missions. Furthermore, more dangerous missions can be attempted both because the ramifications of vehicle loss are minimized and because, under some circumstances, the chances for mission success are increased.

Odyssey

Odyssey is the prototype for a new class of autonomous underwater vehicle, designed as an intelligent mobile instrument platform with deep-water capability [Bellingham et. al, 1992a]. Comprised of a low-drag fairing with a single ducted propeller and cruciform control surfaces, Odyssey is 2.2 meters long, and has a maximum diameter of 0.6 meters (see Figure 1). The fairing is free-flooded, and contains the main pressure housings, which are glass spheres (the spheres are pressure tested by the manufacturer and are rated to 6,700 m). The vehicle can be configured with either two or three spheres. The third sphere is used to achieve maximum battery capacity or to provide additional payload volume. To the degree possible, Odyssey is constructed from off-the-shelf components to ease maintenance and minimize cost.

Two key features of Odyssey are its small size and its long range. Odyssey's small size is critical in reducing both the construction and operating costs of the vehicle. It is small enough to be deployed from almost any vessel of opportunity, and requires no specialized handling gear (a small hoist is sufficient). The surface electronics required are minimal - deck units for the acoustic tracking and the acoustic communications systems, a GPS receiver on the support vessel, and a laptop computer for programming the AUV. An extensive set of tools and spares is easily brought along, as are spare sets of batteries.

A typical configuration for Odyssey includes: standard control electronics, conductivity, temperature, and depth sensors (CTD), an acoustic modem, and an electronic imager with strobe. Given intermittent use of the last two items, Odyssey has a range of approximately 180 km (Figure 2), assuming the vehicle is carrying a maximum load of alkaline batteries, and traveling at 5 km/hr (see the Appendix for details). The long range of Odyssey arises from the hydrodynamic fairing and the fact that over one-quarter of the vehicle weight is batteries (50 kg out of 195 kg). The projected performance with lithium-thionyl chloride cells is also presented in Figure 2 to illustrate the potential capability. The vehicle range depends on other parameters as well, particularly the total non-propulsion power load. Factors affecting vehicle range are discussed in the Appendix.

General Electronics Description

The primary onboard computer is based on the Motorola 68020 microprocessor. In addition to the main computer, a network of small microcontrollers is used to distribute "intelligence" to sensors and actuators. The present vehicle state sensor complement includes a fluxgate compass, pitch and roll sensors, angular rate sensors on all three axes, a pressure transducer rated to 7,000 m depth, and a depth sounder. Odyssey also carries an acoustic modem capable of transmitting data at 1200 baud over a range of 5,000 m, opening the possibility of enhancing the vehicles autonomous operation with some form of supervisory control. The vehicle is launched with a drop weight attached to its nose which is released to force the vehicle to the surface at the end of a mission.

An acoustic transponder, a radio beacon, and a strobe have all been installed on Odyssey to aid in locating the vehicle. The radio beacon and strobe are used for locating the vehicle on the surface. An ultrashort-baseline tracking system is used from a support vessel to track the acoustic transponder. All three location aids operate off of power sources independent from each other and the rest of the vehicle electronics, ensuring operation even if vehicle batteries run low.

Odyssey's electronic subsystems are designed for reliability, low power consumption, and small size. To improve error detection, key subsystems have been instrumented with microcontrollers for self-diagnosis and error correcting capabilities. Systems for detecting a variety of failure modes have been installed in Odyssey (for example, a separate microprocessor monitors the health of the main vehicle computer). These systems operate as backups to the main computer, to ensure vehicle recovery when all else fails. Any of these failure-detection subsystems can trigger the vehicle drop weight and shut down power to all actuators, if required

Vehicle Navigation

To date, we have employed three forms of navigation with our AUVs at MIT Sea Grant: dead reckoning, long-baseline (LBL), and ultrashort-baseline navigation (USBL). The LBL system employed was designed and built at MIT Sea Grant specifically for multiple vehicle operations [Bellingham et al, 1992b]. It provides the vehicle with the ability to determine its position relative to an array of transponders, without having to interrogate the array. The system has been operated extensively on Sea Squirt [Di Massa, 1993], and is installed in Odyssey.

We have used a commercial ultrashort baseline system to track the vehicle from the surface. An LXT tracking system [ORE] is owned by MIT Sea Grant, but is useful only for relatively shallow water missions. A Trackpoint II [ORE], borrowed from the Naval Undersea Warfare Center, has been used to track the vehicle from a GPS equipped boat in Nahant bay (depths less than 30 meters) in joint operations with personnel from Florida Atlantic University. In this last test, the combination of GPS, USBL, and magnetic compass made it possible to reconstruct the vehicle track and generate a bathymetric map of the region of operation from vehicle altitude and depth data [Kloske, 1992].

For deep-ocean surveys, tracking the AUV from a surface vessel as described above is attractive for the following reasons.

- Scientists at the surface guiding the mission need to know the AUV's position
- Surface tracking enhances safe operation and recovery of the AUV
- Less expensive equipment is required on the vehicle
- Power consumption of AUV systems is minimized.
- Periodic position updates can be sent to the AUV over the acoustic modem.

Note that since the acoustic communication system requires minimal lateral separation from the vehicle, the USBL system will not impose additional operational constraints. Also, in creating the database of sensor measurements for the mission, some post-processing will be required to associate the sensor readings with the vehicle position, particularly for still images.

Robust and reliable navigation is a crucial component of any AUV technology development. The resolution requirements vary from mission to mission. Several missions, such as mapping the under-side of the Arctic ice, require very high resolution to satisfy the scientific requirements. Thus, the development of environmentally tolerant, high resolution, acoustic navigation systems is a cornerstone our effort. We are currently developing advanced LBL [Deffenbaugh 1993] and USBL [Tracey 1992] navigation systems for use by AUVs. These advanced systems use a model of the acoustic environment to take advantage of the full information contained in the multipath structure of the signals, while at the same time being robust to the fluctuations and stochastic variability of the real ocean environment. This work extends on existing acoustic navigation systems by eliminating the main deficiency of single arrival detection yielding both significantly improved resolution as well as environmental robustness. Current efforts are focused on developing and testing the algorithms for this task. Once the algorithms have been proven in the field, we will construct compact, low-power, navigation subsystems for use on the AUVs.

Mission Sensors - CTD and Optical Sensor Integration

The fundamental measurements for oceanography are water temperature and electrical conductivity of sea water as a function of depth (generally referred to as CTD measurements). The near homogeneity of the deep-ocean places stringent demands on accuracy in making these measurements. Therefore, to be of scientific use, CTD measurements must provide accuracies of order one millidegree in temperature, one meter in depth, and 0.001 S/m in conductivity.

The main concerns in integrating the CTD sensors into the vehicle are:

- preventing perturbation of the sample by the AUV

- controlling the flow dynamics through and around the sensors
- electronics interface to the sensors and signal conditioning
- providing for calibration of the sensors immediately before vehicle deployment and after vehicle recovery.

Oceanographic-grade temperature and conductivity sensors [Sea Bird Electronics] are being integrated into Odyssey. We are working closely with experienced oceanographers to ensure that the CTD system mounted onto Odyssey meets their standards for accuracy and reproducibility.

Another measurement of interest is the optical transmission of the water-column. This measurements has been shown to correlate well with the temperature anomaly of hydrothermal vent plumes [Nitchman et al., 1992]. The standard instrument for optical transmission is a beam-transmissometer with a 0.25 m path-length - a bulky device, difficult to integrate onto an AUV without significantly perturbing the vehicle hydrodynamics. Instead, we are investigating a new optical backscattering sensor built by Sea Tech, Inc.

Mission Sensors - Sea Floor Images

Many studies in marine biology, geology, and geophysics require images of the sea floor. Imaging the sea floor requires keeping the vehicle close to the bottom while maintaining vehicle stability. In the shallow water tests to date the vehicle has carried a Sony TR-7 palmcorder in a watertight housing. We are equipping Odyssey with a higher resolution imager and strobe lamp for taking images for use in the deep sea and under ice. For AUV operations, still images of the bottom are preferable to continuous video imagery because continuous video imagers require continuous lighting, which is an unacceptable power drain for a small AUV. Issues to be addressed include: altitude of the vehicle off of the bottom for image collection, electronic imager vs. photography, the location of the strobe and imager on the vehicle, and automatic adjustment of strobe intensity to correct for variations in the water column. One additional requirement is that the dive number and time into the mission must be recorded on each image taken by the AUV.

The optimal vehicle altitude for imaging will be determined by the water clarity, but a typical maximum altitude is 5 to 10 meters. At such altitudes, the absorption of sea water removes most of the red from the images, so a monochrome imager is sufficient. A simple fixed focal length imager with a wide angle lens is preferred to provide good coverage. Typical systems provide 400 lines resolution and can record onto hi-8mm tape. For such an imager, operating 5 to 10 meters off of the bottom, a 150 W-s strobe should suffice. A standard lens provides a 90° diagonal field of view, which, at 10m altitude, gives an image of the bottom roughly 14 m across, assuming the camera is pointed directly beneath the vehicle. For an AUV traveling at five kilometers per hour, one image every 8 seconds will give overlap between consecutive images (this is a maximum speed for bottom imaging; two to three km/hr is more typical). At this rate the average power consumption of the imaging system is about 28 W (19 W for the flash, 2 W for the camera, and 7 W for the recorder). This particular hardware combination has been analyzed in detail to demonstrate that it is possible to create a relatively compact, low-power, imaging system for a small AUV such as Odyssey.

Vehicle Communications

Establishing a bi-directional communication channel between an AUV and an operator provides a variety of capabilities. In terms of reliability, the acoustic communication system provides a method to back-up systems which would otherwise represent single-point failure modes for the vehicle. The acoustic link also provides a means by which mission level decisions, normally made by the mission planning software on the vehicle, can be made by a human operator. Thus, unanticipated circumstances beyond the expertise of the mission planner can be handled by a human. To provide this need an ATM-850 acoustic modem [Datasonics] is being integrated into Odyssey.

Vehicle Control

The control architecture for Odyssey uses a three tiered structure. The levels are: vehicle dynamic control, layered control, and mission management (see Figure 3). All of these reside in the main vehicle computer, which runs OS-9, a multitasking, real-time operating system [Perrier and Bellingham, 1992]. The main vehicle computer depends on a network of microcontroller instrumented subsystems, which provide a tool for distributing subsystem control and failure detection and increasing modularity of the vehicle.

The top level vehicle software is built around state-configured layered control [Bellingham and Consi, 1991], an architecture developed specifically to lend itself to ease of mission configuration and predictability of performance. This is achieved through providing the operator with mission building blocks which are employed as mission segments, for example "survey an area" or "home on an acoustic source". These building blocks are connected by transition rules, which define the conditions under which the mission phases change. State-configured layered control evolved out of extensive experimentation with layered control on underwater vehicles [Bellingham et al., 1990].

The building blocks of state-configured layered control are layered control structures, which are themselves composed of suites of behaviors. These behaviors encompass simple mission and survival related skills, such as survey, bottom following, and obstacle avoidance. Layered control is attractive in that it imposes low computational requirements, as well as encouraging the incremental assembly of a mission planner [Brooks, 1986]. However, the complexity of layered control increases rapidly with the number of behaviors active, providing a strong motivation to keep the number of behaviors to a minimum. State-configured layered control does this by only activating behaviors when they are needed.

A second feature of the top level mission management is the ability to accept commands from a human user via the acoustic link. Such supervisory control of a vehicle by a human during a mission has been demonstrated within the layered control architecture [Bellingham and Humphrey, 1990; Connell, 1990]. It has not been demonstrated on Odyssey yet. The following methods of human intervention will be supported:

- high level modification of vehicle objectives - e.g. trigger homing behavior
- modification of vehicle control parameters
- direct command of vehicle controller - i.e. heading, depth and speed
- ability to read/modify environmental descriptors

A variety of control systems for vehicle dynamics were tested on the Sea Squirt AUV, including classical control, sliding mode control [Wallar, 1989], adaptive classical control [Clauberg, 1991], adaptive sliding mode control [Clauberg, 1991], and H infinity control [Logan, 1993]. Presently a Masters thesis student is developing a sliding mode controller for Odyssey [Smith, 1993]. The parameter estimation technique employs a simplified hydrodynamic model of the vehicle in which the parameters of the model are determined from observed vehicle performance (this technique was used by Clauberg [1991] for Sea Squirt). Demonstration of the improvement of vehicle dynamic control obtained by this technique, using off-line parameter estimation, is illustrated in Figure 4 [Perrier and Bellingham, 1992].

Well engineered sensor and actuator systems are the foundation on which the higher level vehicle control and mission planning levels depend. In Odyssey, a large number of the vehicle subsystems have integrated microcontrollers, providing the critical distributed intelligence network. The microcontrollers are employed to endow subsystems with sufficient intelligence to be capable of limited diagnostics. One example of such a system is the watch-dog board, which controls power to the vehicle actuators, including the drop-weight. The watch-dog is initialized with a maximum mission time by the main computer at the outset of a mission. During the course of the mission, the watch-dog must be periodically interrogated by the main vehicle computer or the watch-dog will shut down the vehicle by jettisoning the drop weight and disabling power to the thruster and fins. Thus the watch-dog acts as a worst case backup to the main

vehicle computer, forcing the vehicle to the surface in the case of a fatal lockup. The second condition which will trigger shut-down is if the maximum mission time elapses without an "ok" command, which can only be given by the operator when electrically connected to the vehicle.

Results of Sea Trials

Odyssey began in-water tests in August 1992. A total of 24 days of operations have been accumulated in fresh- and salt-water locations in the greater Boston area. The highlight of these tests was the generation of a bathymetric map of Nahant Bay, Massachusetts (Figure 5). In joint operations with personnel from Florida Atlantic University, the vehicle was tracked from a GPS equipped boat that carried a Trackpoint II USBL system [ORE] on loan from the Naval Undersea Warfare Center. The combination of GPS, USBL, and magnetic compass made it possible to reconstruct the vehicle track. Figure 5a shows depth of the water column along the dead-reckoned vehicle track for one run. From a different run, the vehicle track as determined with the USBL system was used to create Figure 5b, a bathymetric map of the region of operation based on vehicle altitude and depth data [Kloske, 1992].

In December of 1992 and January of 1993 Odyssey and two of the authors (Atwood and Bellingham) participated in a six-week cruise on the NSF icebreaker, Nathaniel B. Palmer, off the coast of Antarctica. During this cruise, laboratory personnel obtained extensive experience in operating the vehicle in both the open ocean and in shallow coastal waters.

Bellingshausen Sea: The first operation of Odyssey from an oceanographic vessel (R.V. Nathaniel B. Palmer) was intended primarily to test deployment, recovery, and operational techniques. A secondary goal was to run tests of Odyssey from a Zodiac in open water. Both objectives were achieved, although vehicle operations were terminated prematurely when conditions worsened to sea state 5.

Our experience suggested an optimal deployment technique. The vehicle was deployed and recovered via an A-frame to a zodiac on the lee side of the ship. The vehicle nose lift point was used to raise the vehicle, with two people stabilizing the tail as vehicle came off the cradle. A bowline, also attached to the nose lift point, was passed to the crew of the zodiac. The vehicle was then lowered into the water, where the zodiac crew removed the A-frame hook and towed the vehicle a safe distance from the oceanographic vessel for initiation of vehicle tests. This procedure provided a simple means for deploying the vehicle with a minimum number of personnel (three on board the ship and three in the Zodiac).

The vehicle can be operated from a zodiac with minimal equipment. A laptop PC is required for downloading control software and the necessary mission commands into the vehicle computer. In addition, the zodiac carried a USBL tracking system and a radio direction finder to aid in locating the vehicle on the surface at the end of a mission.

Palmer Station - Anvers Island: Seven hours of vehicle operations were carried out in the shallow waters of Arthur Harbor, off of Palmer Station. The goal was to evaluate the dynamic control software through a series of yo-yos and zig-zags and to obtain video images of the bottom. Approximately 15 runs were made with the vehicle in bottom following mode within a depth and altitude envelope. To ease vehicle tracking in an unknown environment, a maximum depth was set prior to the run, typically 20 meters. The vehicle descended to its maximum prescribed depth and headed toward the shore, engaging in bottom-following behavior (two meter altitude) when the water became sufficiently shallow. When the water depth became less than the minimum operating depth, the vehicle shut down its thruster, ending the mission. The steep depth-gradient near shore lead to a number of minor collisions with the rocky bottom due to the forward momentum of the vehicle after the thruster cut-off. These results clearly demonstrate the need for a forward-looking sonar when operating near the bottom in rough terrain.

A video camera mounted in the bottom of Odyssey was used to obtain footage of the coastal environment yielding images of a rocky bottom with kelp and other marine life. The water visibility was less than 4 meters and the images were obtained with the ambient lighting. The USBL tracking system experienced difficulties in shallow water, presumably due to the severe multipath environment.

Drake Passage: Three missions were completed to a maximum depth of 30 meters. The most notable finding was the need to modify three aspects of the vehicle design in order to facilitate vehicle recovery after a deep mission. First, the LXT tracking system had difficulty in locating the vehicle once the vehicle had surfaced. We believe that this was due to a combination of large swells, a shallow hydrophone at the Zodiac and the placement of the transponder in the top half of the vehicle. Better placement of the vehicle transponder and deeper deployment of the zodiac hydrophone should result in improved signal return. Second, the vehicle was found to be extremely difficult to locate visually due to the white color of its fairing. A new, bright yellow, polyethylene fairing has been fabricated, which will heighten vehicle visibility in choppy seas. Third, the vehicle-mounted radio antenna should be optimized to improve transmission. The vehicle's radio signal was barely detectable by the ship's radio direction finder at a range of 500 m.

Anticipated Benefits

Many applications in ocean science and marine industry can benefit from the new developments in AUV technologies. In these efforts AUVs can enable missions that are currently impossible, remove people from hazardous environments, or significantly reduce the costs of operations. Our goal is to see that these potential benefits of AUVs are realized. We have identified several scientific and industrial applications which can directly benefit from AUV operations. They include:

- **Under-Ice Studies:** Our laboratory is receiving support for an under-ice mission as a part of a study of sea-ice mechanics in the Arctic. In addition, we have received significant interest in using an AUV to study the seafloor beneath the permanent Antarctic ice.
- **Rapid Response to Episodic Events:** We have received interest in two different missions that fall into this category. The first is to develop an AUV that can be rapidly deployed to an undersea ridge or hydrothermal vent in response to remotely sensed indications of seafloor activity. The second is to develop an instrument platform that can be deployed at the site of an oil spill and assess the damage to the stricken vessel and/or the spread of oil on the surface, in the water column, and on the bottom.
- **Offshore Oil Operations:** We have identified two areas where AUVs can provide real economic benefits to offshore oil operations. The first is the inspection of offshore pipelines (of order 100,000 km in the Gulf of Mexico alone [Fricke, 1992]). The second is to aid in collecting seismology data for oil exploration, with the goal of reducing the number of dry wells drilled and increasing oil recovery from existing wells.
- **Large-Scale Ocean Structures:** Currently, ocean structures such as large-scale eddies and loop-currents are significantly undersampled in space and time [Triantafyllou, 1992]. By deploying large numbers of small, inexpensive AUVs our understanding of these globally important structures can be increased.
- **Environmental and Pollution Monitoring:** AUVs can be used to monitor the outfall plume from a sewage-treatment plant, obtain depth-profiles of water-quality parameters. With the development of appropriate chemical sensors, an AUV can "sniff out" pollution sources and follow them to their sources. Similarly, radiological sensors can be incorporated into a small, inexpensive vehicle to locate, map, or photograph sites where radioactive materials have been dumped on the sea-bed.

We believe that an incremental approach is required to develop the technologies and infrastructure needed to carry out the missions described above. The autonomous deep-ocean and under-ice surveys are the drivers for the required technology development, as they have demands that only AUVs can economically meet. As more experience is gained with AUVs in the field, and their reliability is established and improved, AUVs will become cost-competitive for shallow-water applications as well. Ultimately, we expect that small AUVs, launched from shore, will become a standard tool for coastal applications ranging from pollution monitoring to offshore oil and gas exploration.

Acknowledgments

This work was supported by the M.I.T. Sea Grant College Program, the Office of Naval Research, the National Undersea Research Program, and the National Science Foundation: Polar Sciences. We gratefully acknowledge Benthos, Inc. of North Falmouth MA for their assistance. This work builds on the early control work of Dr. Michel Perrier, who spent a year at M.I.T. Sea Grant, courtesy of IFREMER, Toulon, France. We would like to thank NUWC for the loan of the USBL tracking system and are pleased to acknowledge the collaboration with Florida Atlantic University in the Nahant operation.

Appendix: Range and Endurance

The range of Odyssey is determined by three factors: the energy stored in the onboard batteries, the power required for propulsion, and the power used by non-propulsion subsystems (hotel load). Details of the range calculation are available [Bellingham and Bales, 1993; Bradley, 1992].

Up to 50 kilograms of batteries can be placed in Odyssey. Silver-zinc batteries are used in Odyssey now, but are not attractive in an operational setting because they are expensive and require a relatively long period to recharge (one day for the cells presently in the vehicle). Single-use alkaline-manganese dioxide batteries are an attractive, with low cost per watt-hour and, at the anticipated power levels, high energy density. Assuming Duracell D cells at 0° C, and maximum vehicle power levels, 50 kilograms of batteries provide 4.8 kilowatt-hours at a cost of \$400 per mission (\$0.60 per cell, at wholesale rates).

The Odyssey fairing is constructed using Gertler's series 4165 form [Gertler, 1950]. Gertler used a 2.7 meter long model for drag tests, very close to Odyssey's 2.2 meter length. Although the L/D for the vehicle is 3.7, slightly less than 4 (the low end of the range of applicability of Gertler's results), it is sufficiently close that Gertler's results can be applied with a high degree of confidence. After accounting for appended surfaces, the drag coefficient is 0.075. Measurements have been made of the Odyssey propulsion system. The overall efficiency is approximately 35% at a cruising speed of five km/hr.

The hotel load supports the main vehicle computer, the vehicle sensor suite, navigation systems, non-propulsion actuators, and the mission payload. A breakdown of power systems for Odyssey is given in Table 2. Range as a function of speed and hotel load is illustrated in Figure 2 for two different battery types, 35% propulsion efficiency and 50 kg of batteries

Table 2: Power Consumed by Subsystems

System	Power (W)
Main computer and mass storage	20.7
Attitude sensors, pressure sensor, sonar	8.7
Fin actuators	4.8
DC/DC Converters	7.5
Acoustic modem (20% duty cycle)	4.0
Camera and light (10% duty cycle)	2.8
Conductivity, temperature, and pump	2.9
Total (minimum / average / peak)	(44.6 / 51.4 / 92.6)

References

- Ageev, M.D., "The Use of Autonomous Unmanned Vehicles for Deep-water Search Operations", *Subnotes*, September/October 1990.
- Bellingham, J.G., and Bales, J.W., "Summary of Range Calculation for Odyssey", Sea Grant Underwater Vehicles Laboratory Internal Memo, 1993.
- Bellingham, J. G. and Consi, T.R., "State Configured Layered Control," *Proc. of Mobile Robots for SubSea Environments. Int. Advanced Robotics Programme*, Monterey CA, pg 75, 1991.
- Bellingham, J.G., Consi, T.R., Beaton, R., and Hall, W., "Keeping Layered Control Simple," *Proceedings AUV '90*, pg 3, 1990.
- Bellingham, J.G., Consi, T.R., Tedrow, U., and Di Massa, D., "Hyperbolic Acoustic Navigation for Underwater Vehicles: Implementation and Demonstration," *Proceedings AUV '92*, 1992b.
- Bellingham, J. G., Goudey, C. A., Consi, T. R., and Chryssostomidis, C., "A Small Long-Range Autonomous Vehicle for Deep Ocean Exploration," *Proceedings of the Second International Offshore and Polar Conference*, pp 461-467, 1992a.
- Bellingham, J. G. and Humphrey, D., "Using Layered Control for Supervisory Control of Underwater Vehicles," *Proceedings ROV '90*, pg 175, 1990.
- Blidberg, D.R., "Autonomous Underwater Vehicles: A Tool for the Ocean," *Unmanned Systems*, 2, pp 10-14, 1991
- Bradley, A. M., "Low Power Navigation and Control for Long Range Autonomous Underwater Vehicles," *Proc. of the Second Int. Offshore and Polar Conference*, pp 473-478, 1992.
- Brooks, R., "A Robust Layered Control System for a Mobile Robot," *IEEE Journal of Robotics and Automation*, Vol. 2, 1986.
- Busby, F., *Underwater Vehicle Directory - 1987*, Busby Associates, Arlington, VA, 1987.
- Clauberg, B., "Adaptive Control of a Small Autonomous Underwater Vehicle," Masters Thesis, M.I.T. Department Electrical Engineering and Computer Science, 1991.
- Connell, J., "Cooperative Control of a Semi-Autonomous Mobile Robot," *Proceedings of the IEEE Conference in Robotics and Automation '90*, 1990.
- Datasonics, Inc., Post Office Box 8, Cataumet, MA 02643
- Deffenbaugh, M., "Long Baseline Navigation in Non-Uniform Acoustic Environments," Submitted to the Student Paper Competition, *8th Int. Symp. on Unmanned Untethered Submersible Technology*, Univ. of New Hampshire, September, 1993
- Di Massa, D., "Navigation of an Autonomous Underwater Vehicle for Shallow Water Operations," *Meeting of the New England Section of The Society of Naval Architects*, 4 February, 1993.
- Fricke, J. R., "Applications of Autonomous Underwater Vehicles to the Offshore Oil and Gas Industry," *Scientific and Environmental Data Collection with Autonomous Underwater Vehicles*, M.I.T. Sea Grant Report 92-2, pp 45-48, 1992.

- Gertler, M., "Resistance Experiments on a Systematic Series of Streamlined Bodies of Revolution - for Application to the Design of High-Speed Submarines," DTMB Report C-297, 1950.
- Grandvaux, B., and Michel, J.-L., "Epaulard - An Acoustically Remote Controlled Vehicle for Deep Ocean Survey", *Proceedings Marine Technology '79*, pp 357-359, 1979.
- Kloske, John, private communication, December 2, 1992.
- Logan, C. L., "Robust Control Design and Evaluation for a Small Underwater Vehicle," Engineers Thesis, M.I.T. Department of Electrical Engineering and Computer Science, 1993.
- Mackelburg, G.R., "Acoustic Data Links for UUVs," *Proc. Oceans '91*, pp 1392-1399, 1991.
- Nitchman, C. A., Feely, R. A., Baker, E. T., Krogslund, K. A., Mortlock, R. A., Pashinski, D. J., Walker, S. L., and Lebon, G. T., "The Vents 1990 Cleft Segment Plume Monitoring Experiment: Physical and Chemical Data. NOAA Ship DISCOVERER, September 8-29, 1990". NOAA Data Report ERL PMEL-40, 1992.
- ORE International, Falmouth Heights Road, Falmouth Massachusetts, USA.
- Perner, M., and Bellingham, J. G., "Control Software for an Autonomous Survey Vehicle," *Proceedings International Advanced Robotics Programme*, Workshop on Underwater Robotics, Genoa, Italy, 1992.
- Sea Bird Electronics, 1808 136th Place NE, Bellevue, WA, 98005
- Smith, C., Masters Thesis, M.I.T. Dept. of Ocean Engineering, In Progress
- Tracey, B. H., "Design and Testing of an Acoustic Ultra-short Baseline Navigation System," *Master of Science in Oceanographic Engineering Thesis*, M.I.T. and W.H.O.I., 1992.
- Travis J., "Deep-Sea Debate Pits Alvin against Jason," *Science*, 259, pp 1534 - 1536, 1993.
- Triantafyllou, M. S., "Development of Autonomous Vehicles for Long Term Ocean Eddy Observation," *Proc. of the Second Int. Offshore and Polar Conference*, pp 455-460, 1992.
- Wallar, E. V., "Design and Full Scale Testing of a Sliding Mode Controller for a Small Underwater Vehicle", Masters Thesis, M.I.T. Department Aeronautics and Astronautics, 1989
- Walton, J.M., "Advanced Unmanned Search System," *Proc. Oceans '91*, pp 1392-1399, 1991.
- Yoerger, D.R., Bradley, A.M., and Walden, B.B., "The Autonomous Benthic Explorer (ABE): An AUV Optimized for Deep Seafloor Studies," *Proc. 7th Int. Symp. Unmanned Untethered Submersible Technology*, Univ. of New Hampshire Doc. 91-9-01, pp 60-70, 1991.

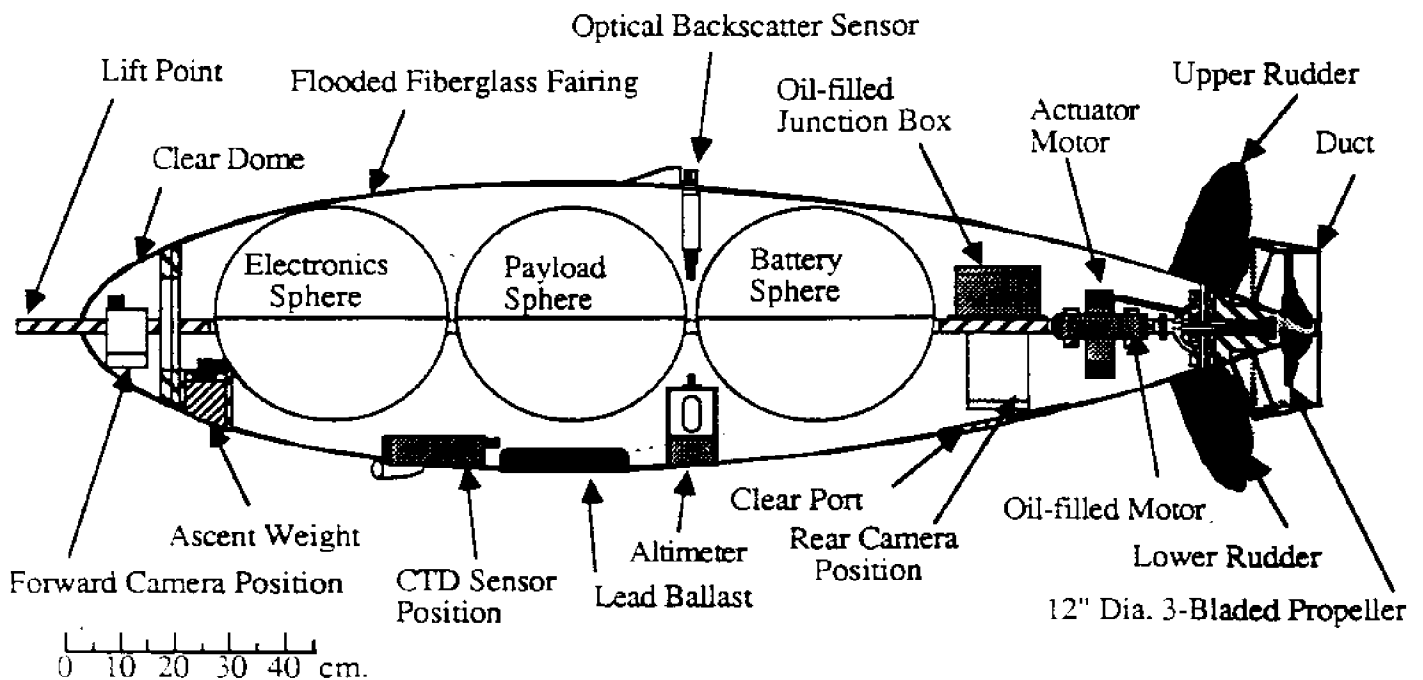

Figure 1: General arrangement of Odyssey. The outer faired surface is a low drag form. A ducted propeller is used to minimize the chance of fouling. Steering is provided by the cruciform control surfaces. To date, Odyssey has only been operated without the payload sphere as the increased buoyancy and dry volume it provides have not yet been needed.

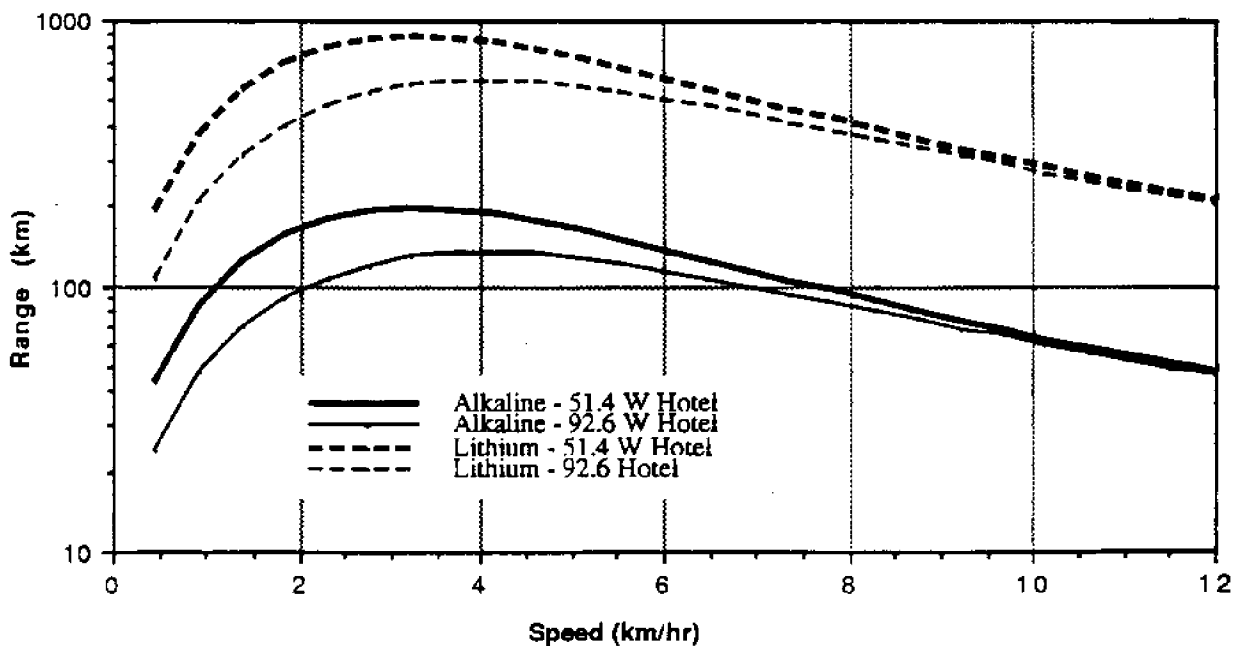

Figure 2: Odyssey range as a function of speed for two different hotel loads and 50 kg of a) alkaline-manganese dioxide batteries (Duracell D Cells) and b) lithium-thionyl chloride batteries (BEI type 64-152(#6)). Battery temperature is 0° C. A hotel load of 51.4 W typical, 92.6 W is the peak value.

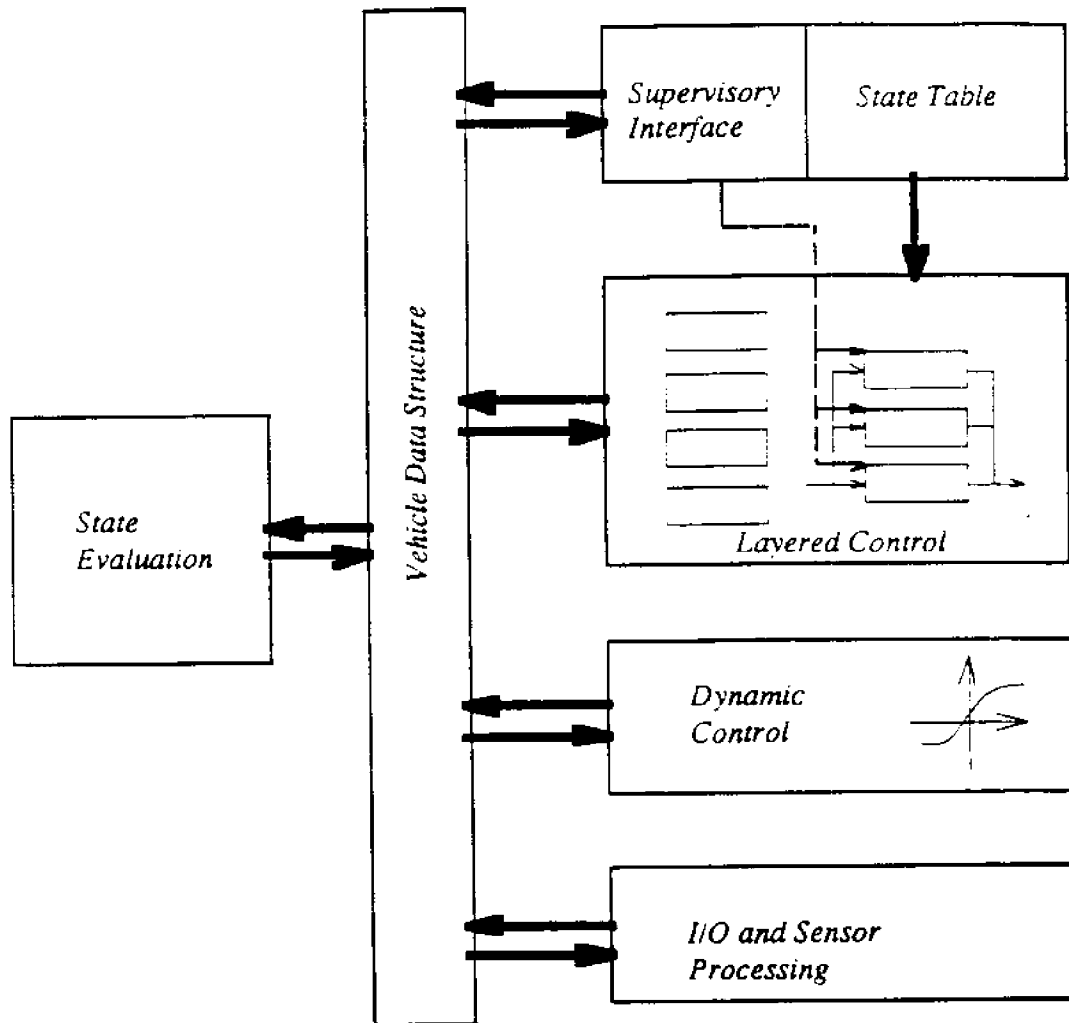
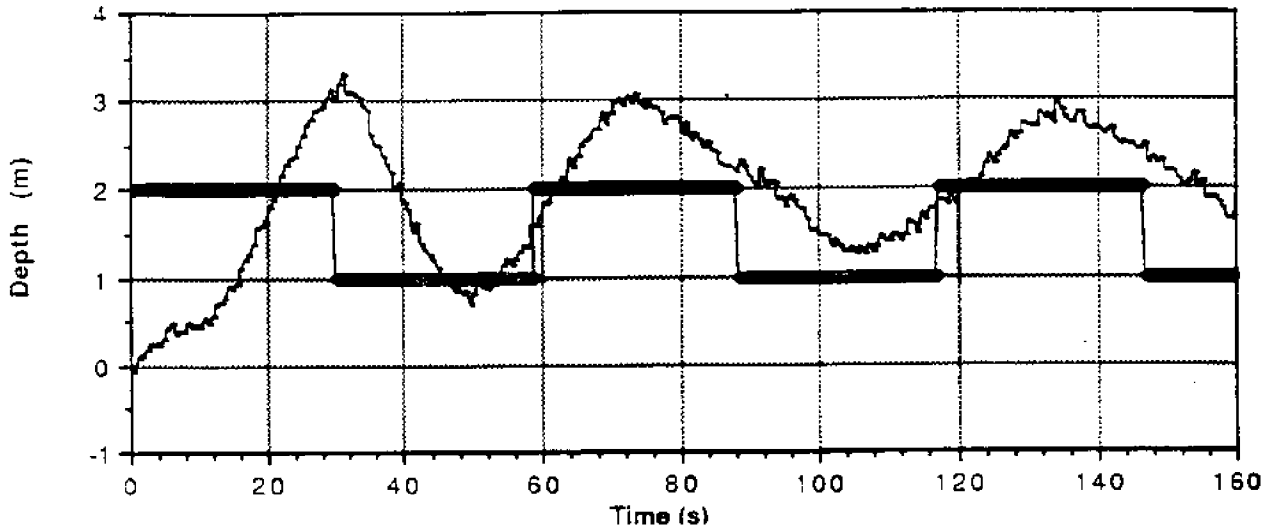
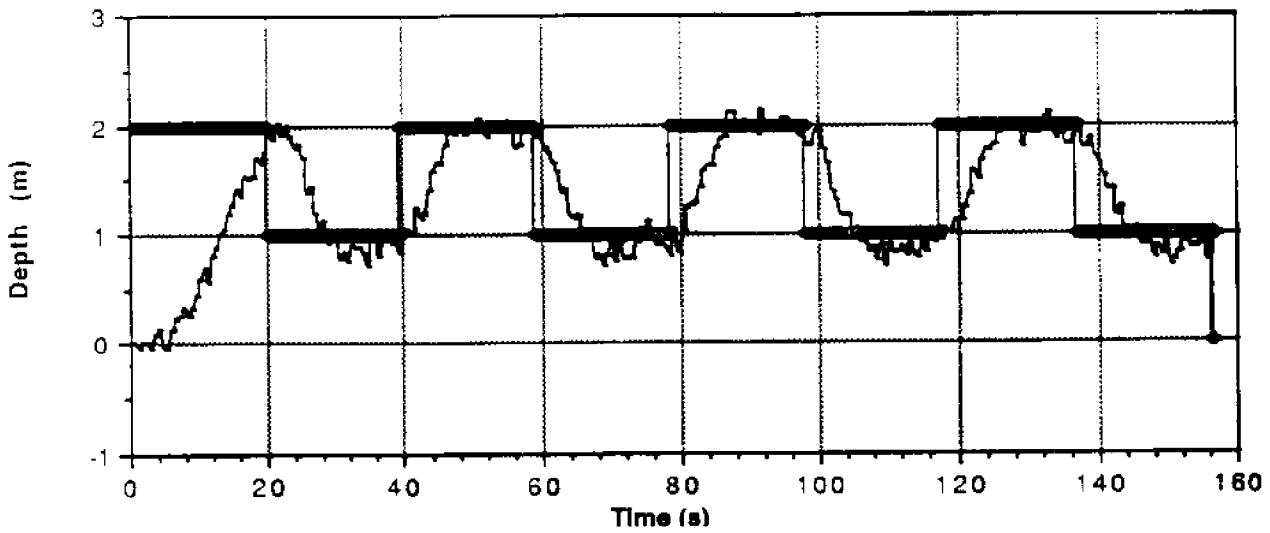

Figure 3: Software configuration of Odyssey. A detailed description of the architecture is presented in the text.



a)



b)

Figure 4: Comparison between two different control algorithms. a) Performance of a PID controller prior to parameter estimation. b) Depth control after the vehicle hydrodynamic parameters were estimated using data collected during the top run.

a)

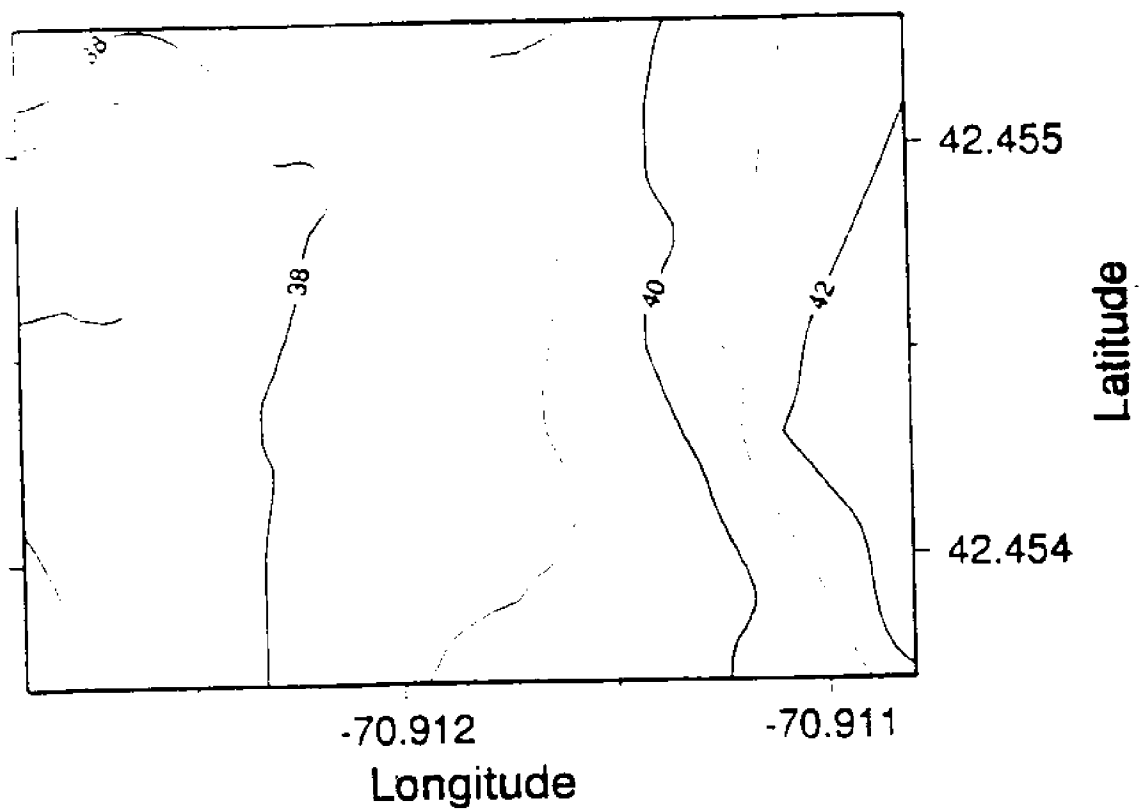
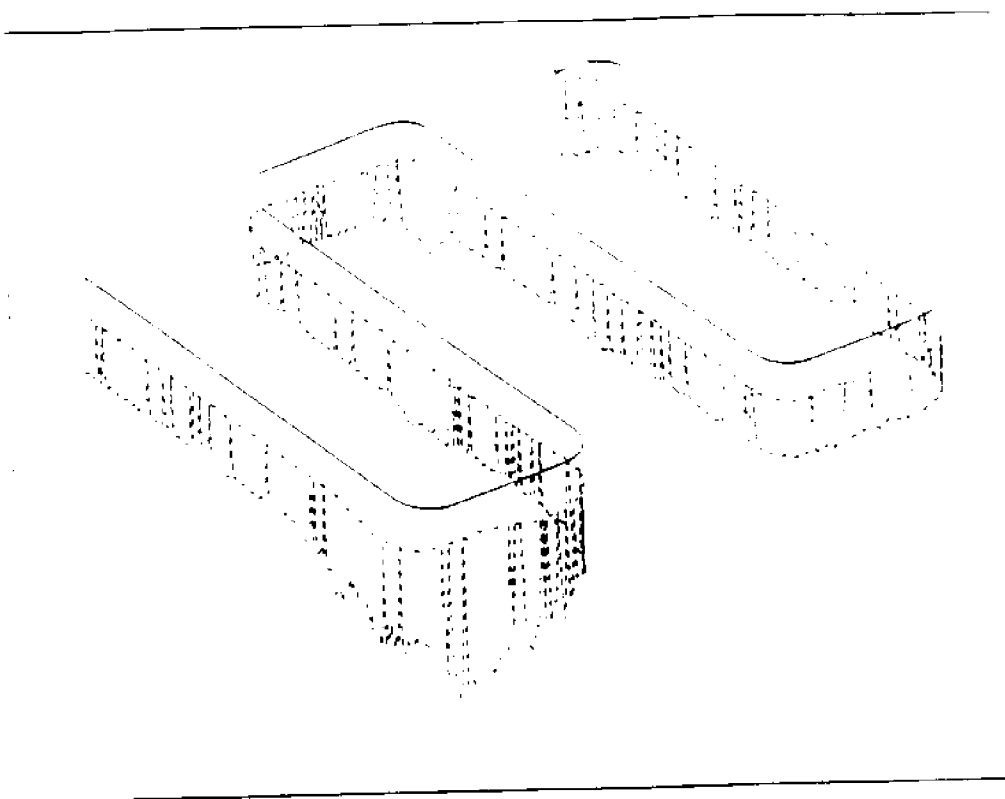

Figure 5: a) Depth of the water column along the dead-reckoned vehicle track for one run [Perrier and Bellingham, 1992]. b) Constructed bathymetric map of the region of operation. In generating this map, the vehicle track was determined with a USBL system, and the depth of the water column was computed from the altitude and depth recorded by the vehicle [Kloske, 1992].