

2
NATIONAL SHORELINE STUDY

Coastal Zone
Information
Center

↓
**SHORE
PROTECTION
GUIDELINES**

*U.S. Department of the Army
U.S. Army Corps of Engineers*



TC
330
.U55
1971

**COASTAL ZONE
INFORMATION CENTER**

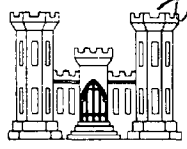

^{U.S.} DEPARTMENT OF THE ARMY
CORPS OF ENGINEERS
WASHINGTON, D.C.



The National _____ _____ *Shoreline Study*

How will the shore be used ?



SHORE MANAGEMENT GUIDELINES

What is its condition ?



REGIONAL INVENTORY REPORTS

What can be done ?

to preserve or enhance the shore,
by using—

- Engineering techniques



SHORE PROTECTION GUIDELINES

REGIONAL INVENTORY REPORTS

- Management techniques



SHORE MANAGEMENT GUIDELINES

TC 330. U55
1972
E.S.

SHORE PROTECTION GUIDELINES

**US Department of Commerce
NOAA Coastal Services Center Library
2234 South Hobson Avenue
Charleston, SC 29405-2413**

A PART OF THE NATIONAL SHORELINE STUDY
CONDUCTED BY THE CORPS OF ENGINEERS

August 1971

**US Department of Commerce
NOAA Coastal Services Center Library
2234 South Hobson Avenue
Charleston, SC 29405-2413**



**DEPARTMENT OF THE ARMY
CORPS OF ENGINEERS
WASHINGTON, D.C.**

FOREWORD

In 1968, the 90th Congress authorized this National appraisal of shore erosion and shore protection needs. This National Shoreline Study and the existing Federal shore protection programs recognize beach and shore erosion as problems for all levels of government and all citizens. To satisfy the purposes of the authorizing legislation, a family of 12 related reports has been published. All are available to concerned individuals and organizations in and out of government.

REGIONAL INVENTORY REPORTS (one for each of the 9 major drainage areas) assess the nature and extent of erosion; develop conceptual plans for needed shore protection; develop general order-of-magnitude estimates of cost for the selected shore protection; and identify shore owners.

SHORE PROTECTION GUIDELINES describe typical erosion control measures and present examples of shore protection facilities, and present criteria for planning shore protection programs.

SHORE MANAGEMENT GUIDELINES provide information to assist decision makers to develop and implement shore management programs.

REPORT ON THE NATIONAL SHORELINE STUDY, addressed to the Congress, summarizes the findings of the study and recommends priorities among serious problem areas for action to stop erosion.

CONTENTS

	Page		Page
INTRODUCTION	4	MANMADE EFFECTS ON THE SHORE	25
GENERAL NATURE OF THE PROBLEM	7	Encroachment on the Sea	25
Natural Beach Protection	7	Natural Protection	30
Dunes	7	Shore Protection Methods	30
Barrier Beaches, Lagoons, and Inlets	7	Comprehensive Protection	30
Origin and Movement of Beach Sands	7	Bulkheads, Seawalls and Revetments	30
Today's Beach Conditions	9	Breakwaters	33
FORCES OF THE SEA	13	Groins	41
Tides and Winds	13	Jetties	45
Waves	13	Beach Restoration and Nourishment	47
Currents and Surges	14	REGIONAL PROTECTIVE PRACTICES	55
Tidal Currents	15	General	55
THE BEHAVIOR OF BEACHES	16	New England Region	55
Beach Composition	16	Middle and South Atlantic and Gulf Regions	56
Beach Characteristics	17	Puerto Rico and Virgin Islands	56
Breakers	17	Pacific Coast Region	56
Effects of Wind Waves	17	Alaska Region	56
Littoral Transport	17	Hawaiian Islands	57
Formation of Deltas	19	Great Lakes Region	57
Effects of Inlets on Barrier Beaches	20	CONSERVATION OF SAND	58
Impact of Storms	21	CONCLUSION	59
Beach Stability	21		

ILLUSTRATIONS

ILLUSTRATIONS

Figure	Page
1 Research Facilities – Coastal Engineering Research Center	6
2 A. Sand Dunes along the South Shore of Lake Michigan	8
B. Sand Dune, Honeyman State Park, Oregon	8
3 Barrier Islands Separated by Tidal Inlets – Wrightsville Beach, N.C. About 1940	10
4 Barrier Beach Island Developed as Recreational Park – Jones Beach State Park, Long Island New York, 3 July 1955	11
5 Large Waves Breaking over a Breakwater	12
6 Wave Characteristics	14
7 Water Particle Movement under Wave Action	15
8 Beach Profile – Related Terms	16
9 Schematic Diagram of Storm Wave Attack on Beach and Dune	18
10 Longshore or Lateral Movement of Littoral Drift	20
11 River Delta at Mouth of San Juan Creek, California	22

Figure	Page
12 Unimproved Tidal Inlet Showing Barrier Beach and Pattern of Offshore Bar and Shoals – North Carolina	23
13 Residential Development Encroaching on Dune Areas and Resulting Backshore Damage to Townsends Inlet, N.J.	24
14 Backshore Damage at Sea Isle City, New Jersey, after March 1962 Storm	25
15 Backshore Damage at Ocean City, Maryland, after March 1962 Storm	26
16 A. Steel Sheet Pile Bulkhead	27
B. Timber Sheet Pile Bulkhead	28
17 Bulkhead of Precast Concrete Sheetpiles at Daytona Beach, Florida	29
18 Vertical-face Concrete Seawall Built 25 Years ago at Watch Hill, Rhode Island	29
19 Concrete Combination Stepped and Curved-Face Seawall, San Francisco, California	31

Figure	Page
20 Concrete Stepped-Face Seawall in Harrison and Hancock Counties, Mississippi	32
21 Seawall at Galveston, Texas	34
22 Stone Revetment – Cape Henry, Virginia	36
23 Interlocking Concrete Block Revetment at Benedict, Maryland	37
24 Interlocking Concrete-Block Revetment at Jupiter Island, Florida	38
25 Sand Bypassing at Santa Barbara, California	39
26 Sand Bypassing at Channel Islands Harbor, California	40
27 Groin System – Willoughby Spit, Virginia	42
28 Groin System at Miami Beach, Florida – April 1962	44

Figure

29 Jetties at Cold Spring Inlet, New Jersey, Entrance to Cape May Harbor	45
30 Shark River Inlet, New Jersey, where Sand Impounded at Jetty was Transported across Inlet by Truck	46
31 Fixed Bypassing Plant – South Lake Worth Inlet, Florida	48
32 A. Masonboro Inlet, North Carolina, July 1966	49
B. Weir Jetty at Masonboro Inlet, North Carolina, February 1966	50
33 Concrete Stepped-Face Seawall, Harrison and Hancock Counties, Mississippi (prior to placement of beach fill)	51
34 Restored Beach at Presque Isle Peninsula, Erie, Pennsylvania	52
35 Wrightsville Beach, North Carolina after Completion of Beach Restoration and Hurricane Protection Project	53
36 Dunes formed by trapping wind-blown sand with fences and grasses, Outer Banks, North Carolina	54
37 Weekday use of artificially nourished beach, north of Haverhill Avenue, Hampton Beach, New Hampshire	54

INTRODUCTION

SHORE PROTECTION GUIDELINES

These guidelines are for general use by those who are interested in suitable and economical methods of shore protection. They will be of value to those who may be knowledgeable in one or more of the shoreline processes but want additional information on the many forces that may affect a specific shore area. However, the general nature of this material precludes its use as a technical reference for preparing detailed design of protective measures.

The guidelines will be of particular interest to officials who want to avoid the pitfalls of approving inadequate or ineffective measures which may appear inexpensive, but would prove costly on a long-range basis. They will be able to better understand alternative proposals because this reference covers basic points which should be considered in any analysis that leads to the selection and recommendation of a specific type of shore protection.

The discussion of shore processes and natural protective features stresses the hazards which individual property owners face when they build within the zone of shoreline fluctuations. Examples show what happens when owners attempt to take advantage of the apparent full area of their shore lots by building out close to the high water line; when they level the dunes to obtain a better view of the ocean, or to permit easier passage to the beach.

Illustrations and text emphasize that a portion of the beach area belongs as much to the sea or lake as to the land, and that the beach area may be periodically inundated or eroded. The descriptions explain why the degree of inundation, which shorefront property owners and managers may anticipate, depends upon the dimensions of beach height and width relative to the intensity of water motion in the adjacent sea during severe storms; and that these dimensions depend largely on whether the shore has been eroding or is stable or accreting. The discussion is designed to help create acceptance of the fact that a beach erodes where the rate of littoral material (sand) supplied naturally to the shore is less than the rate at which natural forces of waves, currents, and winds are removing it from the shore.

The guidelines cover several ways to reduce shorefront damages, such as: a) conservation — preserving and enhancing natural protective features such as dunes, vegetation and natural sand supply; b) structural — preventing sea waves from reaching erodible shore formations by use of structures such as offshore breakwaters, seawalls, dune or bluff armoring; and c) also structural to restore or enhance natural processes — by restoring and maintaining protective beaches and dunes by direct placement of sand from inland or ocean sources, and either periodically augmenting a deficient natural sand supply or providing structures such as groins to reduce sand losses.

It is national policy that any beach protection works supported by the Federal Government must have a detailed assessment of its potential impact on the environment in the interests of avoiding adverse effects and restoring or enhancing environmental quality. Alternative actions must be explored and both long and short-range implications to man, including his physical and social surroundings, must be evaluated.

Part of the value of the guidelines is its combination of many basic findings from research, study and observation of the complex phenomena related to the coastal environment. While the discussion points out the limitations of available information, it contributes to a better understanding of why research will lead to continuing improvements in design for present or yet to be developed protective measures. It indicates what may be expected from continuing the quest for knowledge by the Corps of Engineers through research at its Coastal Engineering Research Center (CERC) in Washington, D.C., as called for by Federal statute (P.L. 88-172) and as an adjunct to its function of planning and construction of Federal projects for shore improvements (Figure 1).

A technical report for use by professional engineers or other technically trained persons involved with shore protection problems has resulted from this research effort. The title is "Shore Protection, Planning and Design", Technical Report No. 4, U.S. Army Coastal Engineering Research Center. This report is periodically updated to include current knowledge. The most recent edition (1966) is presently available from the U.S. Government Printing Office, Washington, D.C. 20402, for \$4.75.

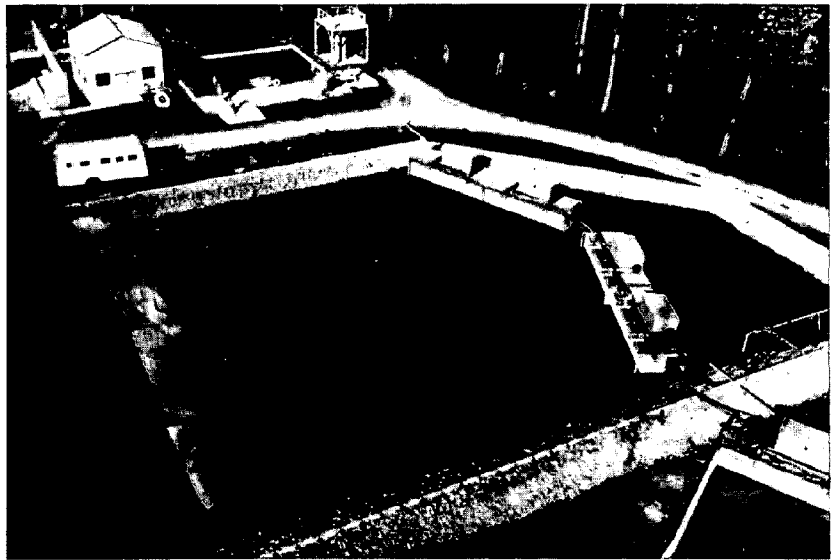
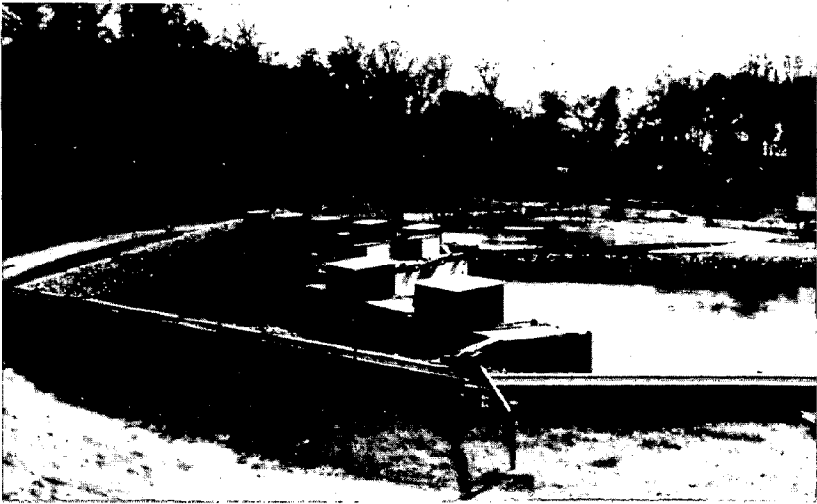

GENERAL NATURE OF THE PROBLEM

—Natural Beach Protection—

Many beaches of the United States, which have a high value as a natural resource, are being destroyed through erosion associated with manmade developments.

Where the land meets the ocean, nature has provided the shore with a natural defense against the attack of the waves. The first defense against the waves is the sloping near-shore bottom which dissipates the energy or weakens the force of the deepwater waves. Yet some waves continue toward the shore with force and energy still at tremendous levels until they near the beach. There they break, and unleash most of their destructive energy. This process of breaking often builds in front of the beach another defense in the form of an offshore bar which helps to trip following waves. The broken waves reform to break again and may do this several times more before finally rushing up the foreshore of the beach. At the top of wave uprush a ridge of sand is formed and serves as a defense against uprush of following waves. Beyond this ridge, or crest of the berm, lies the flat beach berm which is reached only by higher storm waves.

Figure 1. Research Facilities — Coastal Engineering Research Center

—Dunes—

Winds blowing inland over the foreshore and berm move sand behind the beach to form dunes (Figure 2). Grass, and sometimes bushes and trees, grow on the dunes, and the dunes become a natural levee against the sea attack. Dunes are the final protection line against the sea, and are also a savings bank for the storage of sand against a stormy day.

And stormy days do come. Strong winds blow high waves before them. These waves are so huge that the nearshore slope weakens them only slightly. The thrust of the wind and the waves toward shore raises the elevation of the sea and large waves pass over an offshore bar without breaking. If the storm occurs at high tide, the storm surge and the tide superelevate the waves and some of them may break high on the beach or even at the base of the dunes. After a storm or stormy season, the natural defenses are again reformed by normal wave and wind action.

—Barrier Beaches, Lagoons and Inlets—

Nature provides an additional protection for the mainland in the form of barrier beaches (Figures 3 and 4). Nearly all of the Atlantic Coast from Long Island to Mexico is comprised of barrier beaches. These are essentially long narrow islands or spits built parallel to the shoreline by wave action and changes in sea level. The barrier beaches thus formed and the entrapped shallow lagoons of varying widths separate the mainland from the sea. During severe storms these barrier beaches absorb the brunt of the seawave attack, and even when their dunes are breached, the major damage is the cutting of an inlet which permits sand to enter the lagoon; there is no major damage to the mainland from the sea waves.

—Origin and Movement of Beach Sands—

The sands of the beaches and nearshore slopes are small, resistant rock particles that

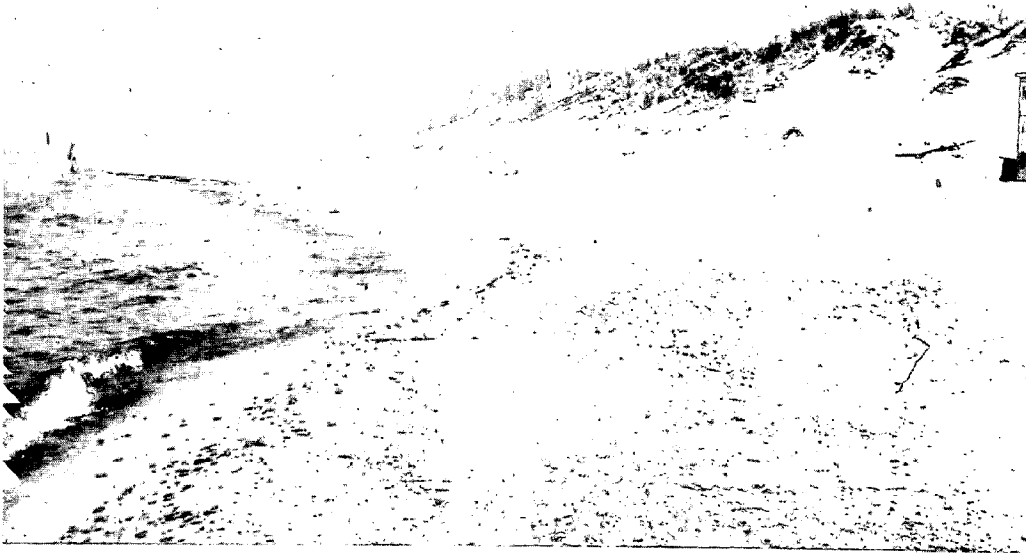

Figure 2-A. Sand Dunes along the South Shore of Lake Michigan.

Figure 2-B. Sand Dune, Honeyman State Park, Oregon



up the estuaries. Coastal villages were populated by fishermen. Few people had the time or the money to spend vacations at the beach.

As time progressed, and particularly after World War I, all of this changed rapidly. The technical revolution brought trains, the automobile, gasoline-powered pleasure boats, large ships with deep drafts, and the new leisure. Coupled with the population explosion, these developments resulted in hordes of people descending onto the shore.

Dunes were destroyed to make way for hotels, boardwalks, roads, and houses. Breakwaters and jetties were built to aid large and small craft to harbor. In nearly every instance, these harbor structures interrupted the along-shore movement of sand and starved adjacent downdrift beaches.

The rivers were dammed to provide the expanding population and industry with hydroelectric power, water supplies, and flood control. These dams have essentially stopped the supply of sand previously reaching the beaches from large parts of the major river basins.

In many places, dunes were bulldozed away merely to provide picturewindow views of the ocean.

—Today's Beach Conditions—

Today, we find that although there are still many beautiful beaches for outdoor enjoyment, in most areas there is less and less sand

have been carried to the oceans from eroding uplands. Some sand particles have traveled many miles from inland mountains. Other sand is derived from erosion along the shore. When the sand reaches the shore, it is moved along-shore by waves and littoral currents. This transport by littoral currents is a constant process and moves great volumes of sand alongshore. In most places this movement changes direction as the direction of wave attack changes.

The natural defenses of the land against the sea, the erosion by storm waves, and the littoral transport of the sand have shaped and reshaped the sandy beaches for millions of years.

From the beginning of recorded history through the early years of this century, man has met the sea at the shore with few problems. He has built ports and used the seas for commerce and warfare.

In the early days of settlement of this country, harbors were either landlocked or far



Figure 3, Barrier Islands Separated by Tidal Inlets – Wrightsville Beach, N.C., About 1940

reaching them and they erode. Causes for our shrinking beaches are in general the normal geologic changes and changes made by man. Considering a very long-term basis, the slow rise in sea level, if it continues, will submerge part of the present beaches. However, this rise is so slow that changes occurring in the course of a normal human lifetime will not be noticeable without measurement by precise gages. Changes which occur on a shorter-term basis, and which are of greater urgency, are those caused by development of the shore by man for various purposes. As shore areas are developed, attempts are made to stabilize the

beaches and stop erosion of the bluffs which would normally furnish sand to the beaches. Therefore, there is less material available for replenishment of the moving sands.

Flood control and water supply dams are necessary to the everyday life and safety of people, yet these dams often alter the flow of

water which brings sand from inland to the shore. They may in some instances trap sand that would move to the sea by the action of normal flows. Improvements of inlets and river mouths for navigation cause interruptions of the sand movement or shifting of the sand to

deeper water from where most of it may never return to the shores. Unless means are provided to overcome these losses of beach sand from the shore zone, or methods are devised to reduce the effects of development, stabilizing beaches will become an ever-increasing problem. In addition to sand losses and beach changes induced by works of man, there are natural coastal processes which produce sand losses, such as diversions into deep submarine canyons and accumulating shoals inside unimproved inlets and at major headlands.

*Figure 4. Barrier Beach Island Developed as Recreational Park
- Jones Beach State Park, Long Island, N. Y.
3 July 1955.*

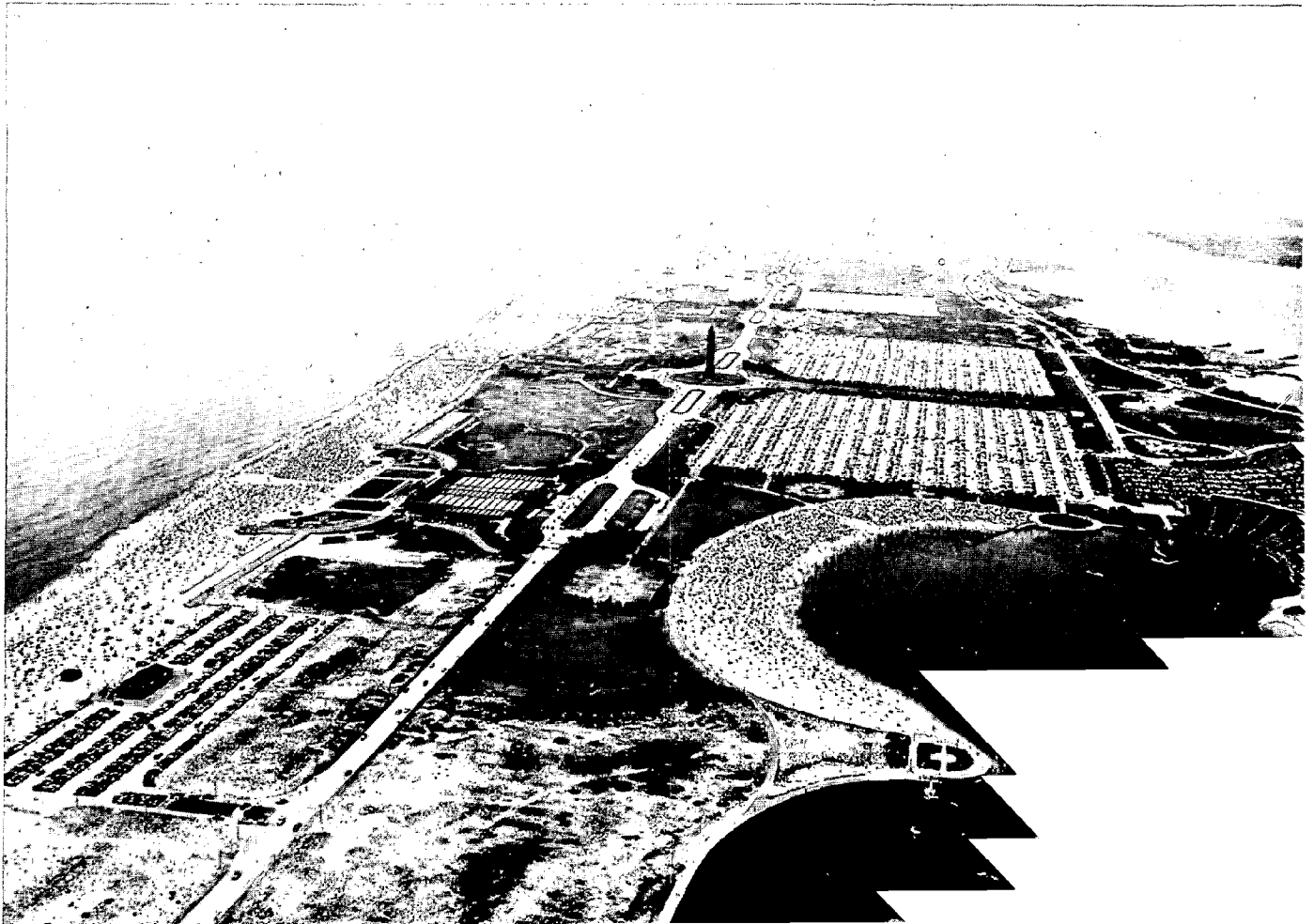

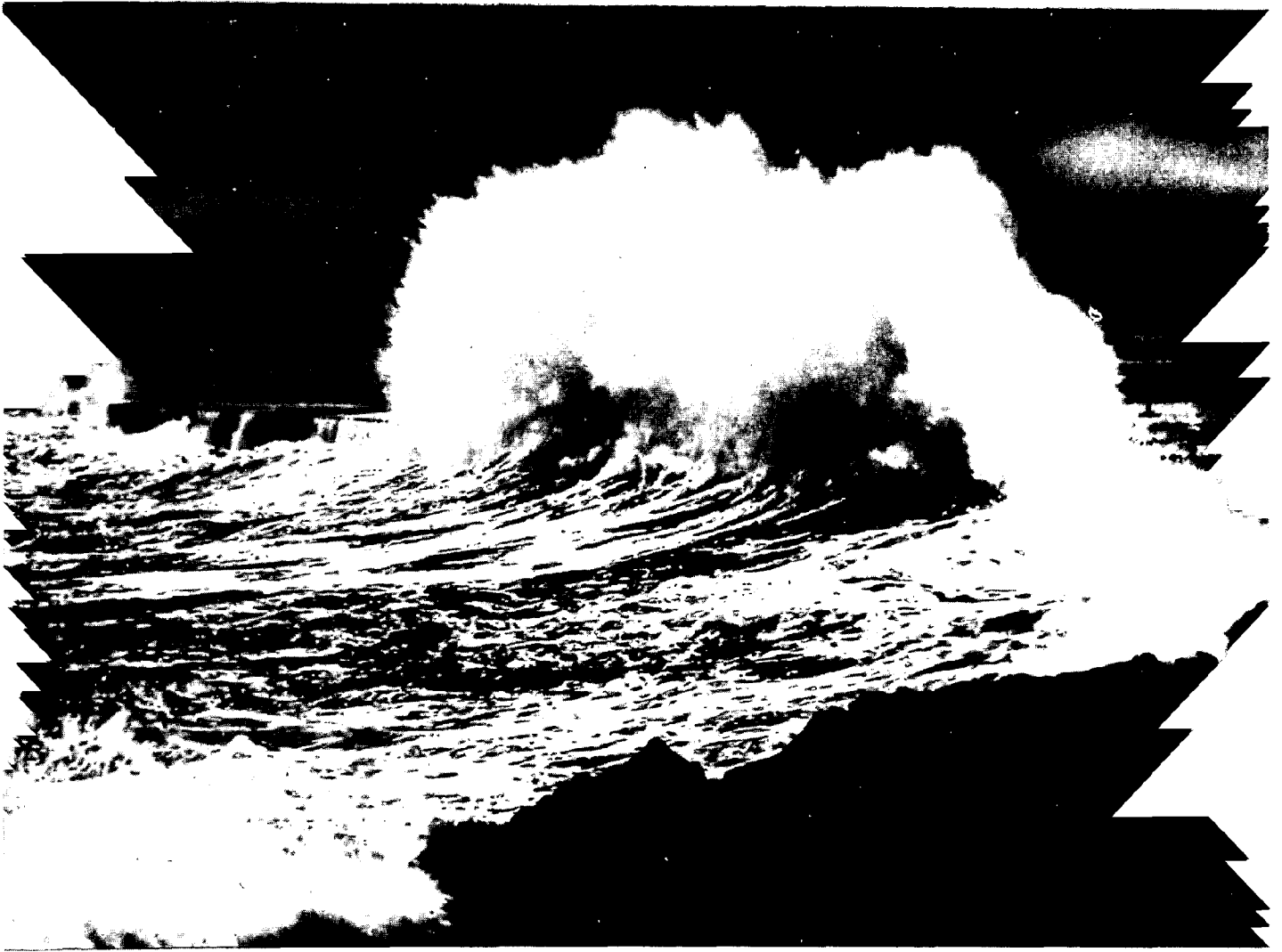

Figure 5. Large Waves Breaking over a Breakwater (Photo from Portland Cement Association)

FORCES OF THE SEA

—Tides and Winds—

The forces of the sea originate in the sun and the moon. The sun causes air movements or winds, and helps the moon create the tidal rise and fall of the ocean surface.

Air movements originate with temperature changes. The sun heats the earth, the waters of the earth, and the air around the earth, but this heating is not uniform. The air in some parts of the earth is heated more than that in other places. The warmer, lighter air rises, causing a zone of reduced pressure; winds result as colder, denser air moves into this zone.

The moon, and to a lesser extent the sun, creates the tides of the sea. Together they generate the tides because they attract the water masses of the earth in the same way that the earth attracts objects near its surface. Because of this gravitational force of attraction and the fact that the sun, moon, and earth are always in motion with relation to each other, the waters of the ocean basins are set in motion. Once the water masses of the oceans have been set in motion, they create the tides. The tidal motions of the water masses are a form of wave motion.

—Waves—

The familiar waves of the sea are "wind waves" generated by the winds blowing over the water. They may vary in size from ripples on a pond to giant waves in the oceans as high as 100 feet (see Figure 5). Wind waves cause most of the damage to our seacoasts. Another type of wave, the tsunami, is created by earthquakes or other large disturbances on the ocean bottom. Tsunamis have caused spectacular damage at times, but fortunately they do not occur frequently.

Wind waves are of the type known as oscillatory waves, and are usually defined by their height, length, and period (see Figure 6). Wave height is the vertical distance from the top of the crest to the bottom of the trough between crests. Wave length is the horizontal distance between successive crests. Wave period is the time between successive crests passing a given point.

When waves move over the water, only the form and energy of the waves move forward. Advance of the wave form causes oscillatory motions of the individual water particles (Figure 7).

These particles describe circular orbits in deep water with each particle returning to its original position after passage of the wave. The diameters of the circles decrease with depth from a diameter at the surface equal to the wave height. In shallow water the orbital movements become flattened, and at the bottom are merely horizontal oscillations to and fro as the wave form passes.

The height, length, and period of wind waves are determined by the fetch (the distance the wind blows over the sea in generating the waves), the speed of the wind, and the length of time that the wind blows. Generally, the longer the fetch, the stronger the wind, and the longer the time that the wind blows over the water, the larger the waves will be. The wind generates waves of many heights, lengths, and periods simultaneously as it blows over the sea.

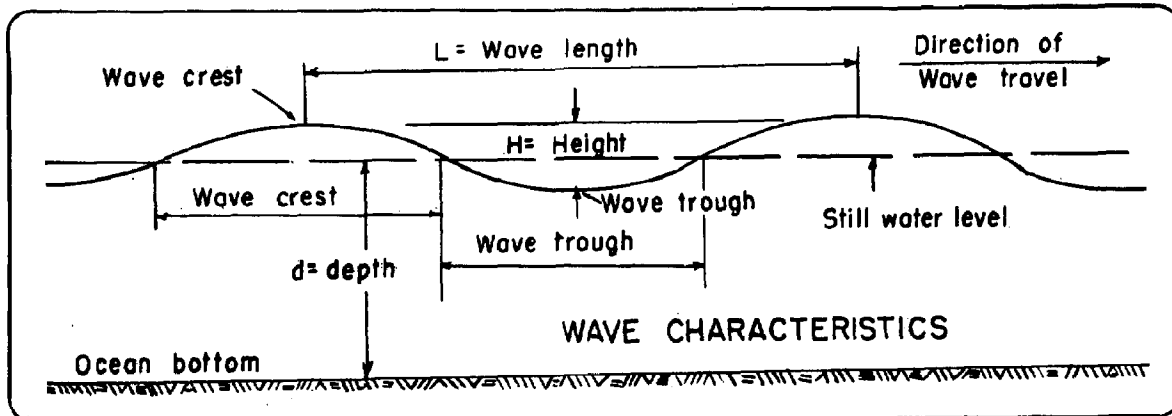

Figure 6. Wave Characteristics

If winds of a local storm blow toward the coast, the generated waves will reach the local beach in essentially the form in which they are generated. Under these conditions, the waves are rather steep, that is, the wave length is only from 7 to 20 times the wave height. If the waves are generated by a distant storm, they may travel through hundreds or even thousands of miles of calm areas before reaching the shore. Under these conditions the waves "decay" — the short, steep waves are eliminated, and only relatively long, low waves reach the shore. Such waves have lengths from 30 to 500 or more times the wave height and are called "swells" or "ground swells".

—Currents and Surges—

Currents are created in oceans and adjacent bays and lagoons when the water in one area becomes higher than the water in another area. The water in the higher area flows toward the lower area, creating a current. Some causes of differences in the elevation of the water in the oceans are the ordinary tides, the blowing wind, waves breaking on a beach, and streams which flow into the ocean. Changes in water temperature cause changes in water density and produce currents such as the Gulf Stream.

The wind creates currents because, as it blows over the surface of the water, it creates a "stress" on the surface water particles, and starts these particles moving in the direction in which the wind is blowing. Thus, a surface current is created. When such a current comes to a barrier, such as a coastline, the water tends to pile up against the land. In this way "wind tides" or "storm surges" are created by the wind. The amount of "storm surge" depends on the wind velocity and direction, the fetch, and the water depth. In violent storms this wind surge may raise the sea level as much as 20 feet. In the United States, the larger surges occur on the Gulf Coast because of the lesser depths on that coast compared to those on the Atlantic and Pacific Coasts. Storm surges may also be increased by the funneling effect in converging estuaries.

Waves create a current known as the "long-shore current" when they approach the beach at an angle. As they break on the beach they set up a current which moves parallel to the shore in shallow water. The longshore current is frequently noticeable to swimmers and bathers in the surf when they find themselves being moved slowly along the beach. This current, under certain conditions, may turn

and run out to sea in what is known as a "rip current". Rip currents are often referred to by bathers as "undertow", and when strong enough they may endanger swimmers by carrying them seaward to deeper water rather unexpectedly.

The rivers and streams which flow into the ocean are currents themselves, and they carry the sediments which have been eroded from the land.

particular place, then water must flow into and out of the area. The most important currents that the tides generate are those at inlets to lagoons and bays or at entrances to harbors. At most such places, the water flows in when the tide in the sea is rising (flood tide) and then flows out as the tide in the sea falls (ebb tide).

In addition to creating currents, the tides are constantly changing the level at which the waves attack the beach.

-Tidal Currents-

The tides are a rise and fall in the water level. If the water level is to rise and fall at any

Figure 7. Water Particle Movement under Wave Action

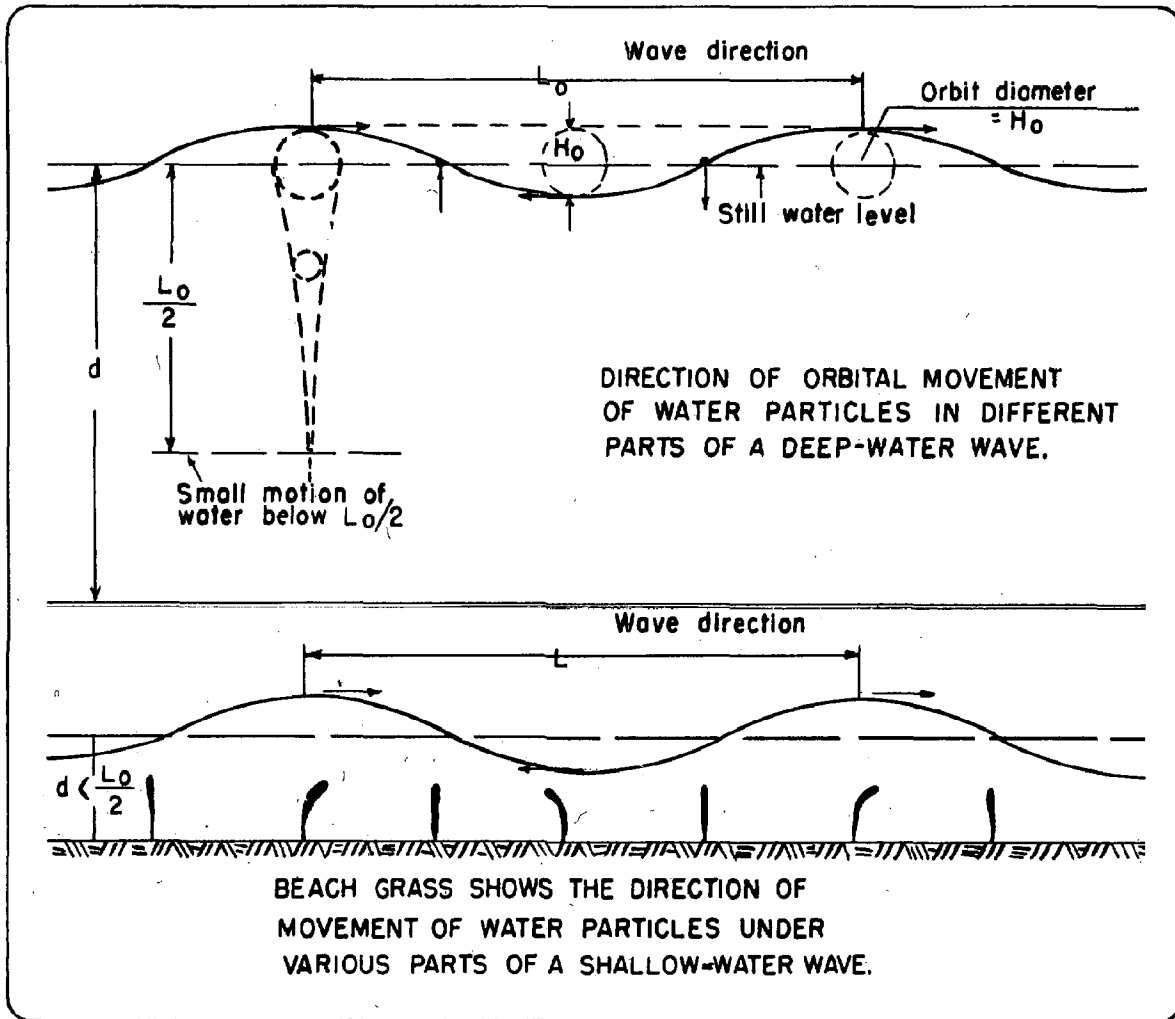

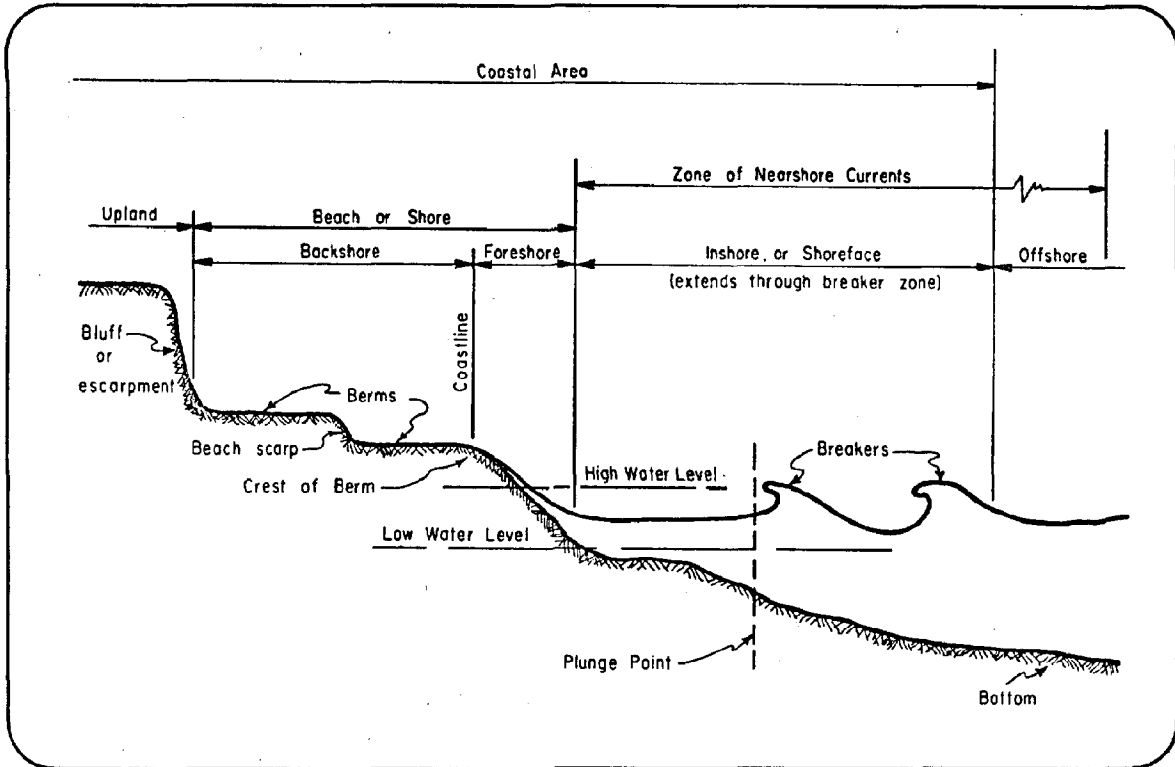

Figure 8. Beach Profile – Related Terms

–Beach Composition–

The sediments of a beach are determined by the forces to which the beach is exposed and the type of material available at the shore. Most beaches are composed of very fine to very coarse sand. This sand is supplied to the beaches by the streams, and by the erosion of the shores by waves and currents. Mud does not usually remain on beaches because the waves create much turbulence in the water along the shore and the fine materials which compose muds are kept in suspension in the shore area. It is only after moving away from the beaches into quieter or deeper water that these fine particles settle out and deposit on the bottom. Many beaches along the New England Coast are composed of rather large stones, frequently called "shingle" or "gravel". Some beaches on water bodies where wave action is very mild are composed of mud. Grasses usually grow in the mud, thus these shores are marshes.

THE BEHAVIOR
OF BEACHES

energy of the wave, which causes a great turbulence in the water, and stirs up the bottom materials. After breaking, the water travels forward as a foaming, turbulent mass, expending its remaining energy in a rush up the beach slope, then falling under the influence of the force of gravity, the water runs back down the beach slope to the sea.

—Effects of Wind Waves—

Wind waves affect the beaches in two major ways. Short steep waves, which usually occur during a storm near the coast, tend to tear the beach down (Figure 9). However, when the local weather is fair, the long swell which comes ashore from distant storms tends to rebuild the beaches. On most beaches, there is a constant change caused by the tearing away of the beach by local storms followed by gradual rebuilding by swells from distant storms. A series of violent local storms in a short time can result in severe erosion of the shore, if there is not enough time between them for swells to rebuild the beaches. Alternate erosion and accretion of beaches is seasonal on some beaches; the winter storms tear the beach away, and the summer swells rebuild it. Beaches may also follow longterm cyclic patterns. They may erode for several years, and then accrete for several years.

—Beach Characteristics—

The characteristics of a beach are usually described in terms of the average size of the sand particles that make up the beach, the range and distribution of sizes of those particles, the elevation and width of berm, the slope or steepness of the foreshore, and the general slope of the inshore zone fronting the beach (see Figure 8). Generally the larger the sand particles which make up the beach, the steeper the beach will be. Beaches with gently sloping foreshores and inshore zones usually have a preponderance of the finer or smaller sizes of sand.

—Breakers—

The primary agent causing onshore, offshore, and alongshore movement of sand is the breaking wave or "breaker". As a wave moves onto the shore, it finally reaches a depth of water which is so shallow that the wave collapses, or "breaks". This depth is equal to about 1.3 times the wave height. Thus a wave 3 feet high will break in a depth of about 4 feet. Breaking results in a sudden dissipation of the

—Littoral Transport—

The longshore current is very important in coastal processes because it carries sand which has been stirred into suspension by the turbulence of the breaking waves. The sand moved in this way is known as "littoral drift". Onshore and offshore sand movements are caused by low swells and steep waves respectively, and coupled with littoral drift help explain the major shoreline changes on the open coasts of the world. This onshore-offshore process associated with storm wave events is illustrated in Figure 9, while Figure 10 illustrates an onshore-offshore path for motion of sand particles associated with each individual wave.

The direction and violence of the wave attack determine the direction and magnitude of the littoral transport at a given time. For instance, on a coast facing to the east, violent

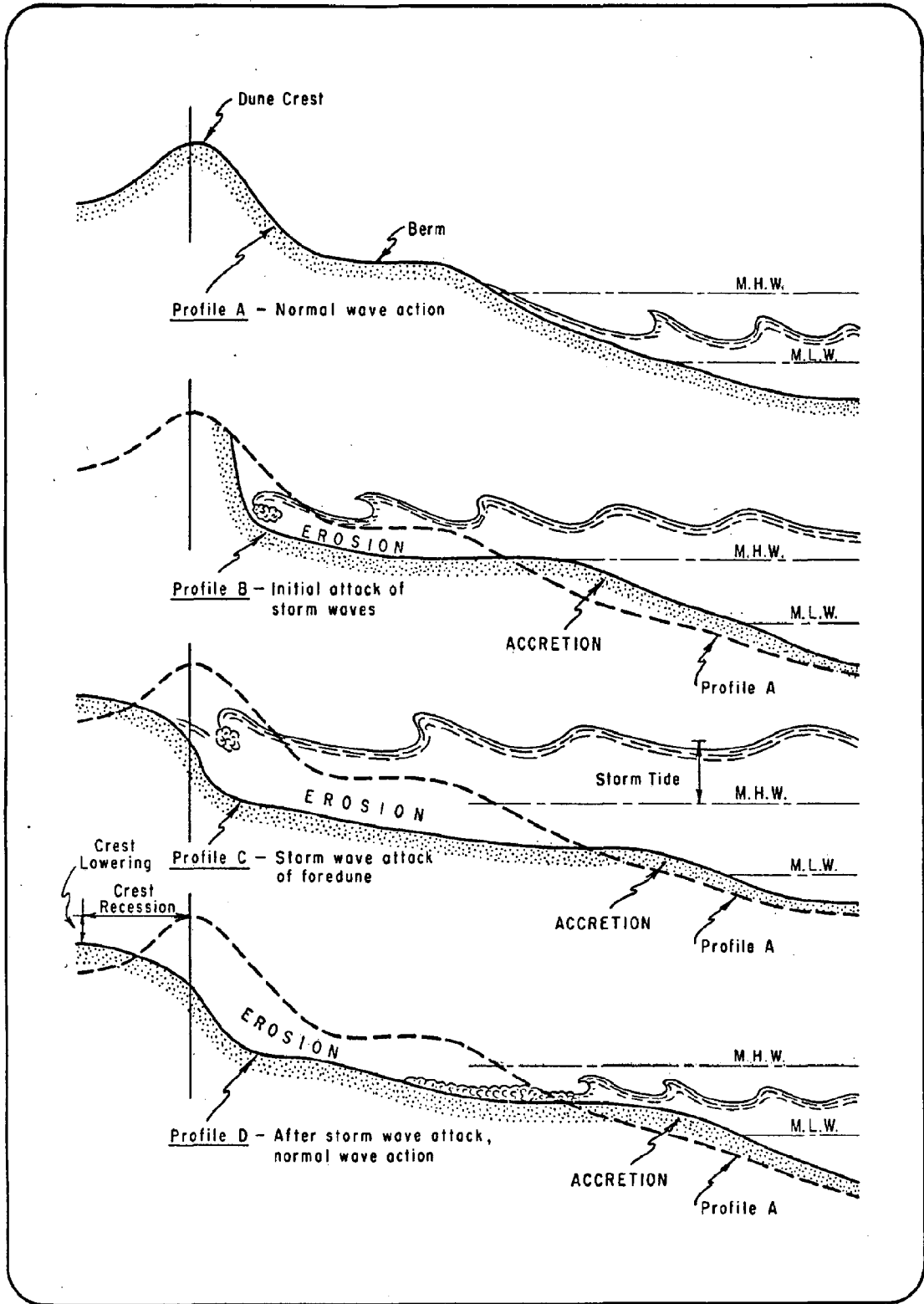

storm waves from the northeast would produce a high rate of littoral transport toward the south. Conversely, mild wave action out of the southeast would result in a much smaller rate of littoral transport to the north. However, if the southeast waves existed for a much longer time than did the northeast waves, the effect of the southeast waves might well be more important in moving sand than that of the northeast waves. In reality, most shores show changes in the direction of littoral transport as the weather patterns change. However, most shores consistently have a net annual littoral transport in one (same) direction. Determining the direction and the average net annual amount of the littoral drift is important in developing shore protection plans.

The average annual net rate of littoral transport at a given place is fairly regular from year to year unless man changes the shore, and eliminates or reduces the supply of sand. The average annual rate varies considerably from

place to place. In landlocked water of limited extent, such as the Great Lakes, the rate of littoral transport can normally be expected to be no more than about 150,000 cubic yards per year. For the open coasts of the oceans, the net rate of transport may be from 100,000 to 2 million or more cubic yards per year. The rate depends on the local shore conditions and alignment as well as the energy and direction of wave action in the area.

—Formation of Deltas—

The fresh water from rivers and upland streams flows to the sea, in some cases directly, and in other cases through estuaries, bays or lagoons. Sediments brought down by rivers flowing directly into the ocean are deposited at the river mouth in the form of a delta (Figure 11). Sand in these deltas is placed in suspension by the waves, and is carried onto the beaches toward which the longshore current is moving. In this way, sediments brought down by rivers and streams feed the ocean beaches. When the fresh water from the river flows through the estuary, bay or lagoon into the ocean, the river sediment is frequently deposited in the protected area and only the water reaches the ocean. In such cases, the sand is not supplied to the ocean beaches.

Figure 9. Schematic Diagram of Storm Wave Attack on Beach and Dune

-Effects of Inlets on Barrier Beaches-

Inlets have important effects on adjacent shores by interrupting littoral transport of sand and trapping the littoral drift. As littoral drift moves into the inlet, it narrows the inlet. Increased tidal currents caused by the constriction then pick up the littoral drift from the inlet. On the ebb current, the sand is carried a short distance out to sea and deposited on an outer bar (see Figure 3 and 12). When this bar becomes large enough, the waves begin to break on it, and this sand again begins to move along the bar toward the beach. However, on the flood tide, when the water flows through the inlet into the lagoon, the littoral drift in the inlet is carried a short distance into the lagoon and deposited. Such sand creates shoals in the landward end of the inlet known as "middle ground shoals" or "inner bars". Later ebb flows may bring some of the material in these shoals back to the ocean, but some is

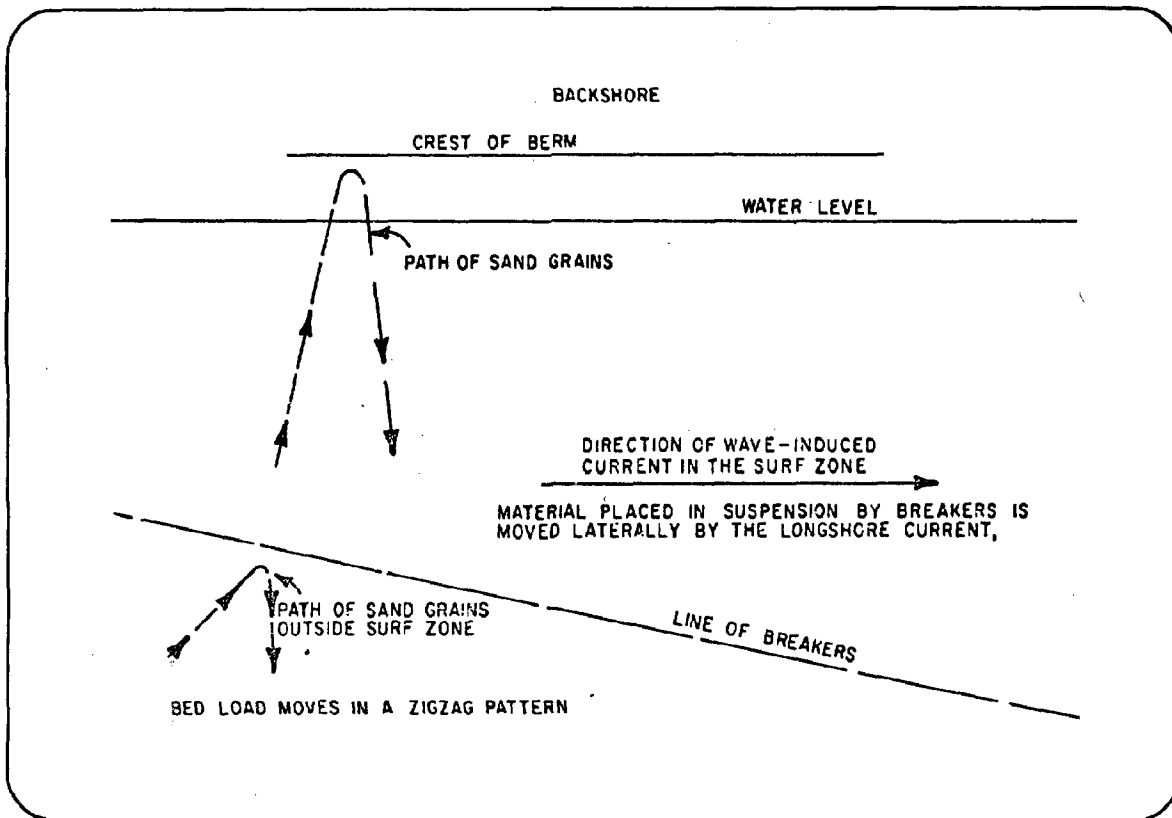

always lost from the littoral drift stream and thus from the downdrift beaches. In this way, inlets frequently store sand and cause narrower beaches by reducing the supply of sand to those beaches. Also, by temporarily interrupting transport of sand, inlets may cause alternate periods of erosion and accretion on the downdrift shores.

—Impact of Storms—

Hurricanes or other severe storms moving over the ocean near the coast will change beaches drastically. Such storms generate large, steep waves. These waves take sand from the beach and carry it offshore; they move much more sand than do ordinary waves. In addition, the strong winds of the storm often create a storm surge. This surge raises the water level and exposes higher parts of the beach not ordinarily vulnerable to waves. Structures, inadequately protected and located too close to

the water, are then subjected to the forces of the waves and are often completely destroyed. Low-lying areas next to the ocean or lagoons and bays are often flooded by such storm surge. Storm surges are especially damaging if they occur at the same time as high tide.

The berm, or berms of the beach are built naturally by waves to an elevation approximating the highest point reached by normal storm waves. While the berms tend to absorb the major forces of the waves, overtopping permits waves to reach the dunes or bluffs in back of the beach and damage unprotected manmade features.

When storm waves erode the berm and carry the sand offshore, the protective value of the berm is reduced and large waves can overtop the beach. The width of the berm at the time of a storm is thus an important factor in the amount of upland damage the storm can inflict.

In spite of the changes in the beach that result from storm-wave attack, a gently sloping beach of adequate width and height is nature's most effective method of dissipating wave energy.

—Beach Stability—

Although a beach may temporarily be eroded by storm waves and later restored by swells,

Figure 10. Longshore or Lateral Movement of Littoral Drift. Movement in all three zones is in a direction and at a rate dependent on the longshore component of wave energy.





Figure 12. Unimproved Tidal Inlet Showing Barrier Beach and Pattern of Offshore Bar and Shoals – North Carolina

and erosion and accretion patterns may occur seasonally, the long-range condition of the beach – whether eroding, stable or accreting – depends on the rates of supply and loss of littoral material. Erosion or recession of the shore occurs when the rate of loss exceeds the rate of supply. The shore is considered stable (even though subject to storm and seasonal changes) when the rates of supply and loss are equal. The shore accretes or progrades when the rate of supply exceeds the rate of loss.

Figure 11. River Delta at Mouth of San Juan Creek, California (March 1969)

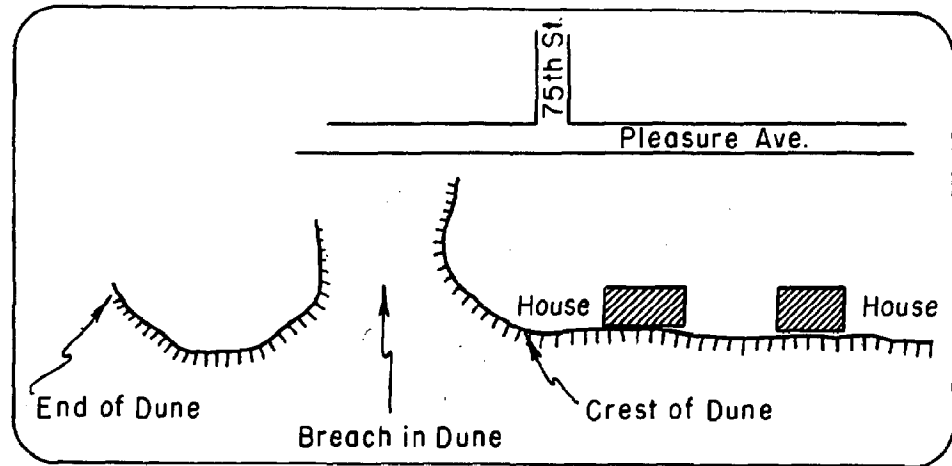

Figure 13. Residential Development Encroaching on Dune Areas and Resulting Backshore Damage (Townsend's Inlet, New Jersey, March 1962)

—Encroachment on the Sea—

During the early days of the United States, natural beach processes continued to mold the shore as in ages past. As the country developed, activity in the shore area was confined principally to harbor areas. Between the harbor areas, the shore developed slowly as small, isolated, fishing villages. As the national economy developed, improvements in transportation brought more people to the beaches. The fishing villages gave way to the massive and permanent type of resort such as Atlantic City and Miami Beach.

MANMADE
EFFECTS
ON THE
SHORE

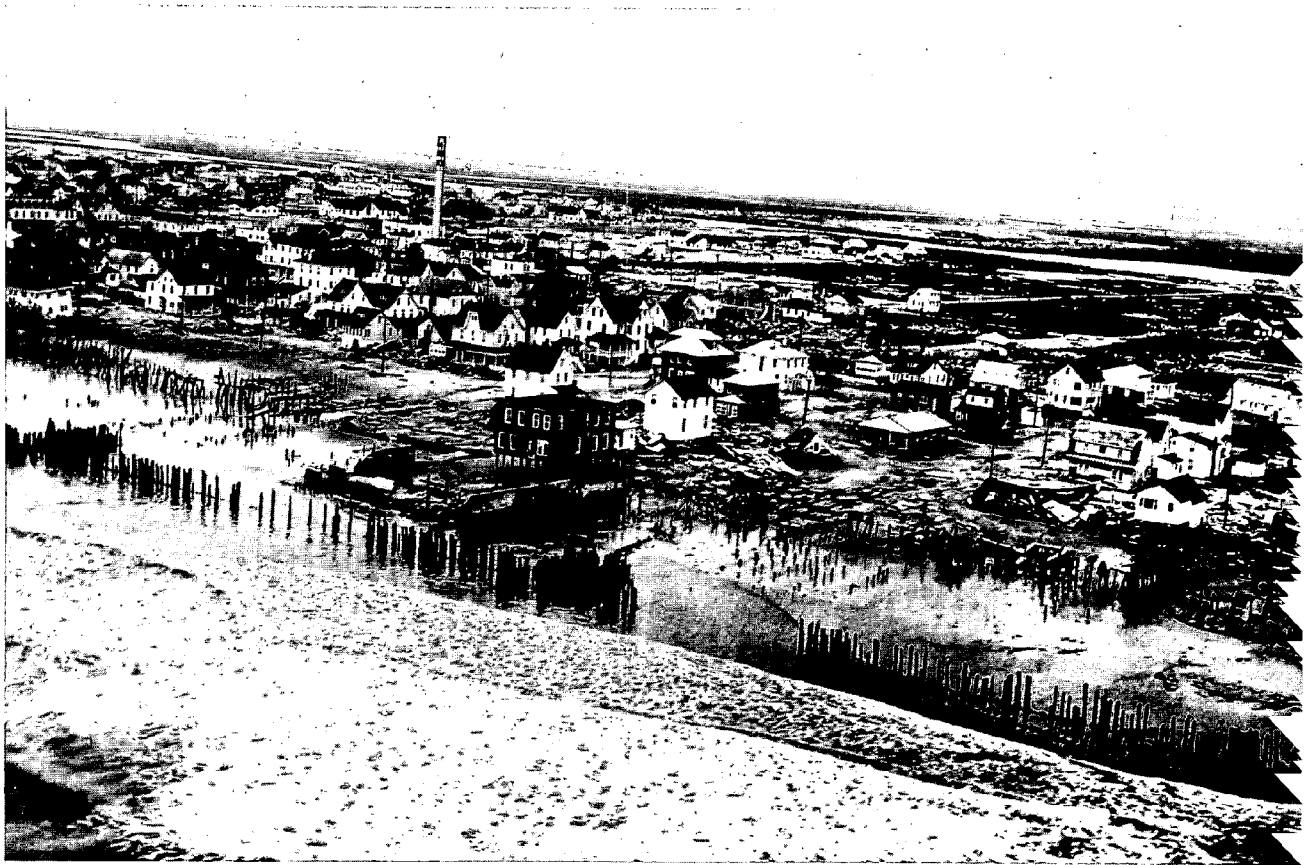

Figure 14. Backshore Damage at Sea Isle City, New Jersey, after March 1962 Storm



Numerous factors control the growth of development at beach areas, but undoubtedly the beach is the resort's basic asset. The desire of visitors, residents, and industries to find accommodations as close to the ocean as possible has resulted in man's encroachment on the sea. There are numerous places where the beach has been gradually widened by natural processes over the years; lighthouses and other structures which once stood on the beach now stand hundreds of feet inland. In their eagerness to be as close as possible to the water, developers and property owners often forget that land comes and goes, and that land which

Figure 15. Backshore Damage at Ocean City, Maryland, after March 1962 Storm. Note wave uprush in foreground reaching backshore development.

Figure 16A. Steel Sheet Pile Bulkhead

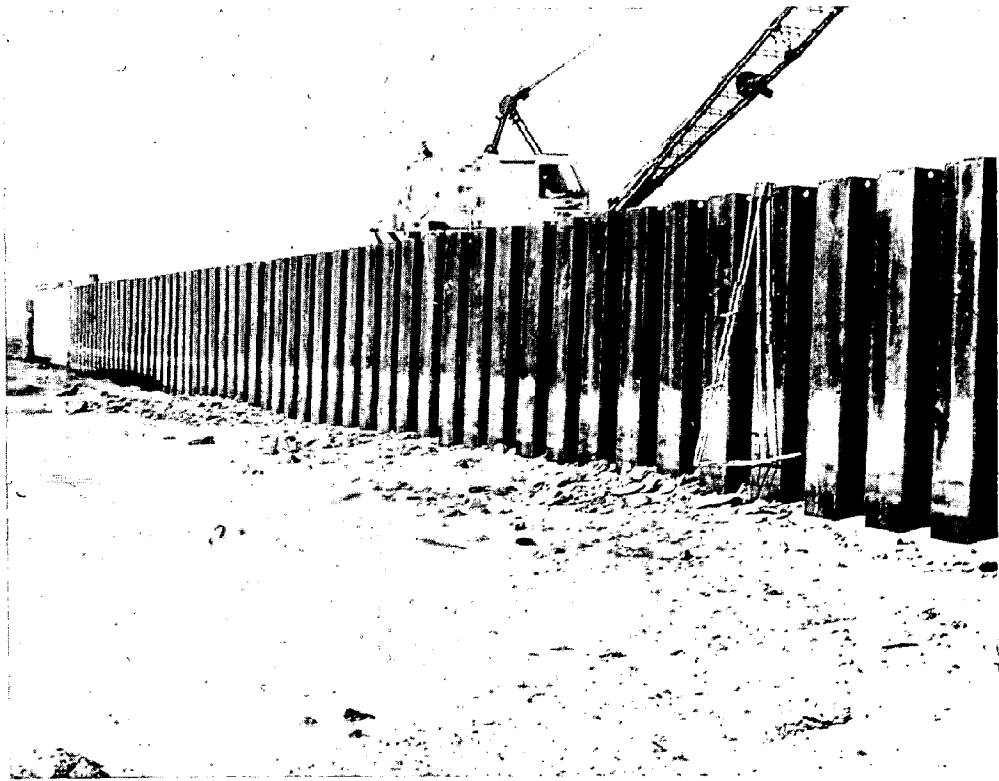

(DUNDALK DOCK, BALTIMORE, MARYLAND)

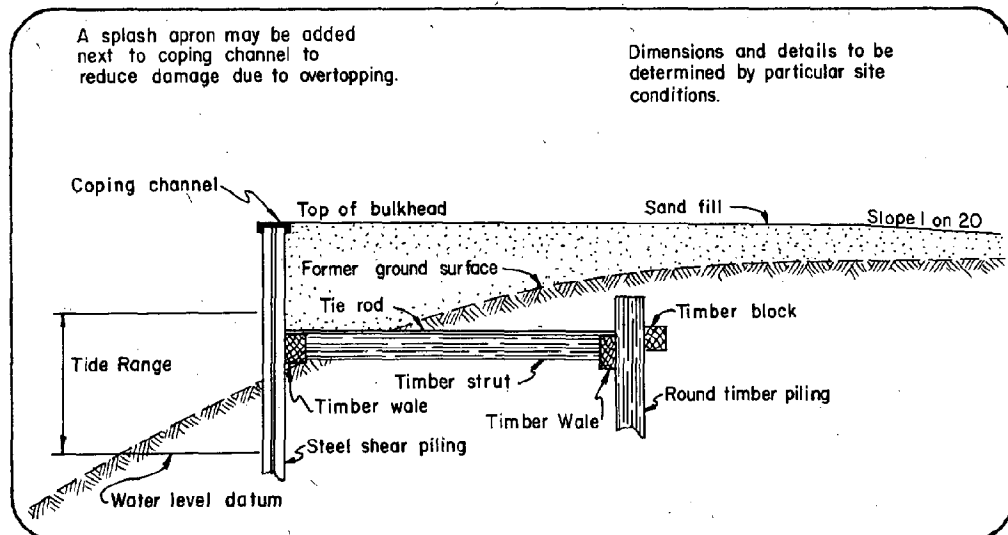

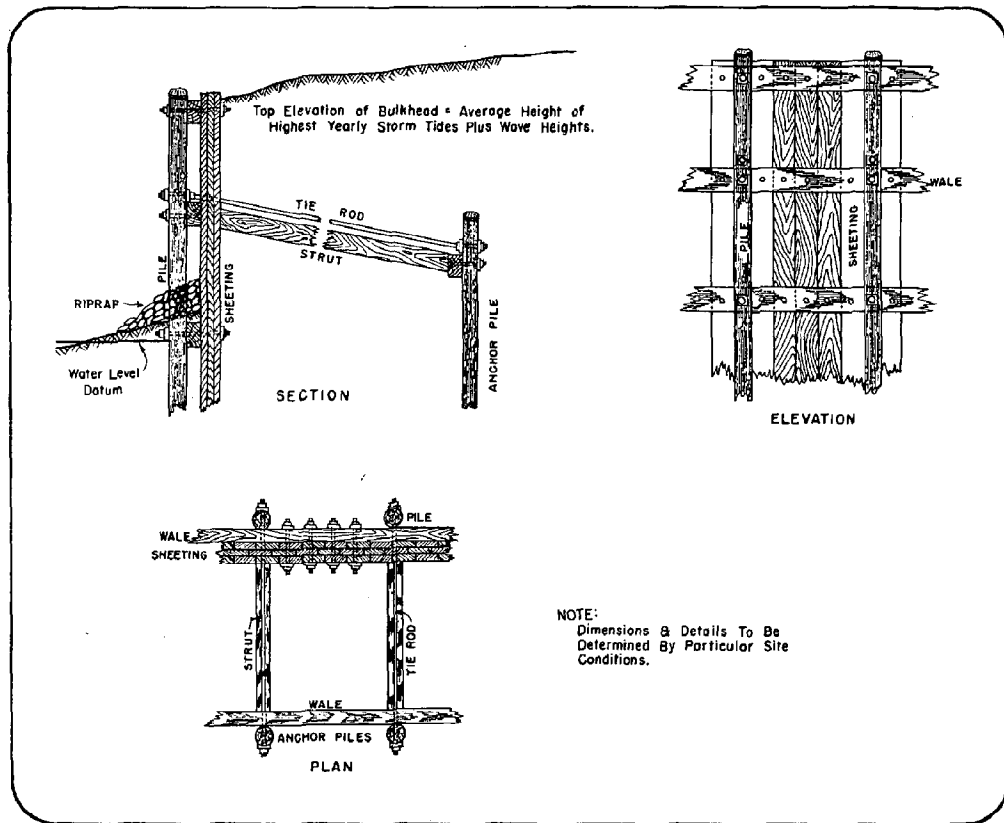
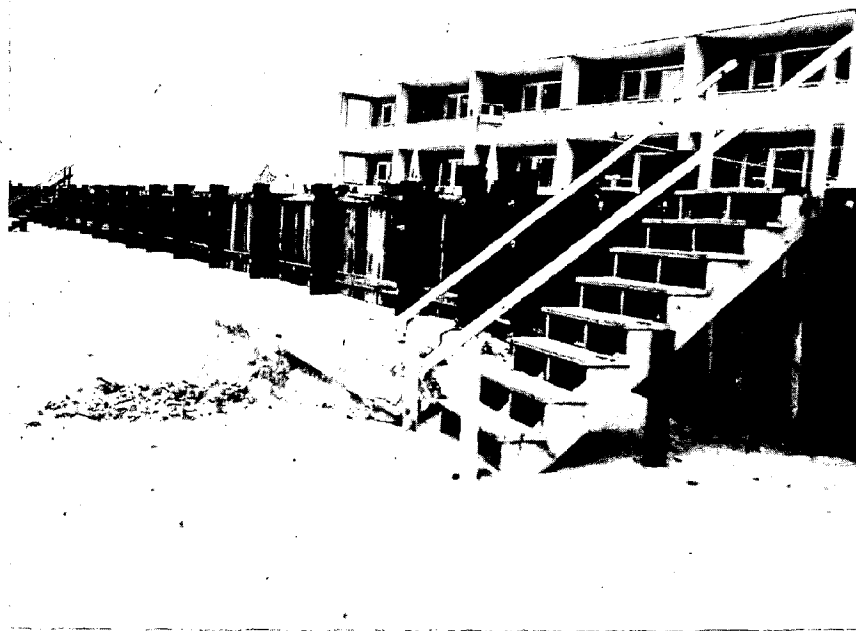

Figure 16B. Timber Sheet Pile Bulkhead

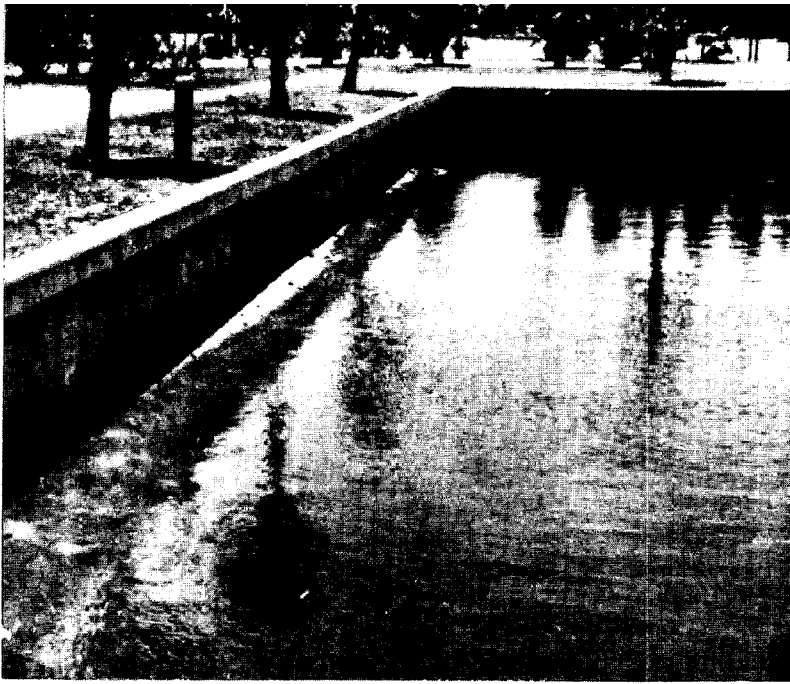

Figure 17. Precast Concrete Sheetpiles, Daytona Beach, Florida. The sheetpiles are 8 x 30 inches and 15 feet, 3 inches long. The concrete cap is 15 inches wide x 12 inches deep. Photo from Portland Cement Association

Figure 18. Vertical-face Concrete Seawall built 25 years ago at Watch Hill, Rhode Island. Seawall, combined with heavy rock riprap, protects the residence on hill at right. Photo from Portland Cement Association.



nature provides at one time may later be reclaimed by the sea. Yet once the seaward limit of a development is established, this line must be held if large investments are to be preserved. This type of encroachment has resulted in great monetary losses due to storm damage and ever-increasing costs of protection.

—Natural Protection—

While the sloping beach and beach berm are the outer line of defense to absorb most of the wave energy, dunes are the last zone of defense in absorbing the energy of storm waves that succeed in overtopping the berm. Although dunes erode during severe storms, they are very often substantial enough to afford complete protection to the land behind them. Even when breached by waves of an unusually severe storm, dunes gradually rebuild naturally to provide protection during future storms. Continuing encroachment on the sea with man-made development has very often taken place without proper regard for this protection provided by dunes. Great dune areas have been leveled for real estate developments, and because such developments were left unprotected, great damage has resulted during storms. Dunes are frequently lowered to permit easy access to the beach. This allows storm waters to flood the area behind the dunes (Figure 13). Where there is inadequate dune or similar protection against storm waves, the storm waters may wash over low-lying land, moving or destroying everything in their path, as illustrated by Figures 14 and 15. Sometimes those waters cut new inlets through barrier islands.

—Shore Protection Methods—

Where beaches and dunes serve to protect the shore developments, additional protective structures may not be required. However, in some localities where development encroaches

onto the beach and into the sea, storm waves overtop the beach and damage backshore structures. Measures designed to stabilize the shore fall into two general classes: a) a structure to prevent waves from reaching erodible materials; and b) an artificial supply of sand to the shore to make up for a deficiency in sand supply through natural processes, with or without structures such as groins to reduce the rate of loss of littoral material.

—Comprehensive Protection—

Separate protection for shore reaches of eroding shores (as an individual lot frontage) within a larger zone of eroding shore, is difficult and costly. Such protection often fails at the flanks as the adjacent unprotected shores continue to recede. Partial or inadequate protective measures may even accelerate erosion of adjacent shores. Coordinated action under a comprehensive plan which considers the erosion processes over the full length of the receding shore segment is much more effective and economical.

—Bulkheads, Seawalls and Revetments—

Protection on the upper part of the beach, fronting backshore development, is required as a partial substitute for the natural protection that is lost when the dunes are destroyed. Shorefront owners have resorted to armoring of the shore by wave-resistant walls of various types. A vertical wall in this location is sometimes known as a bulkhead, and serves as

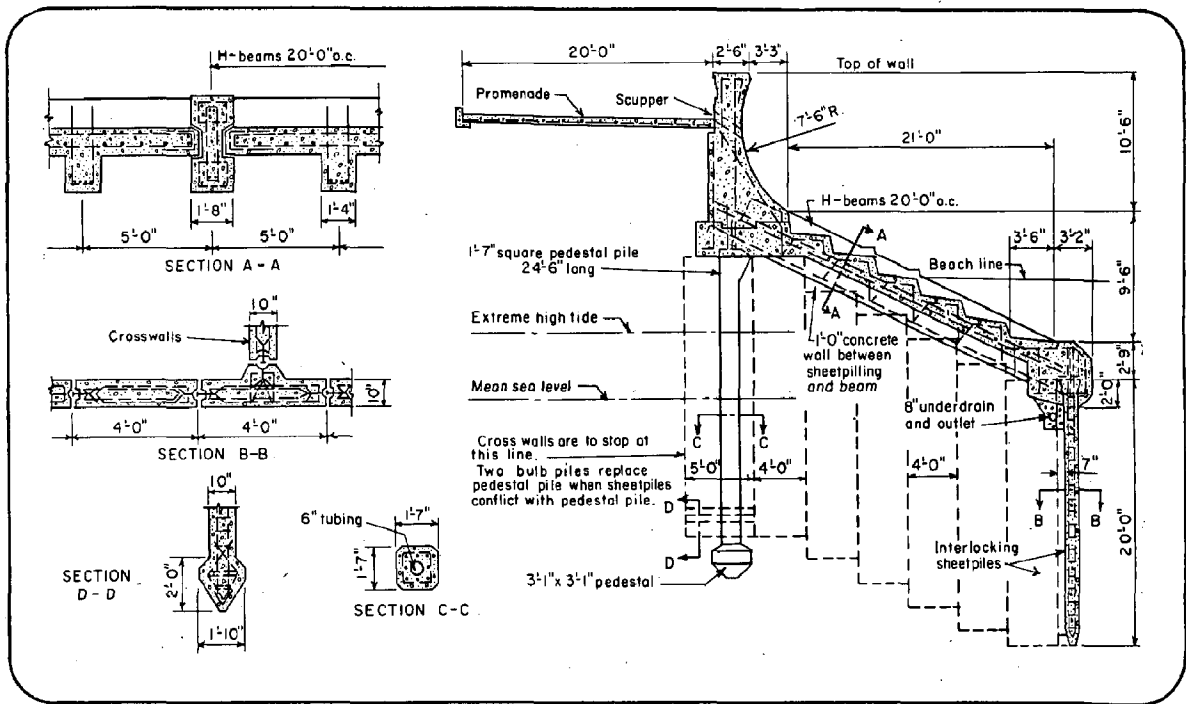
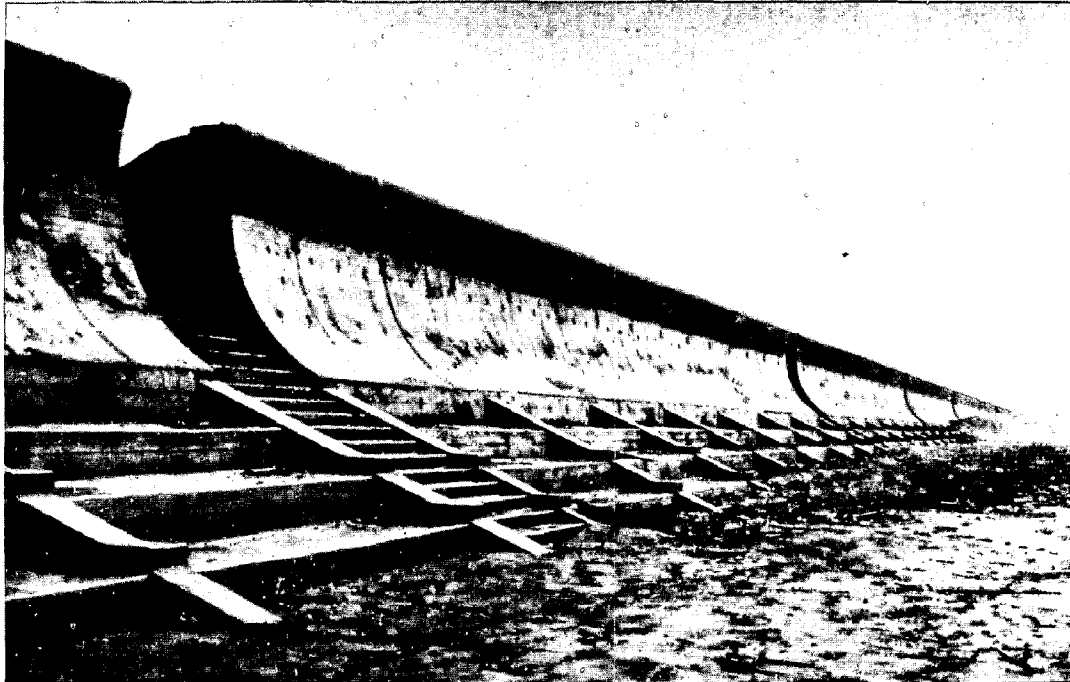
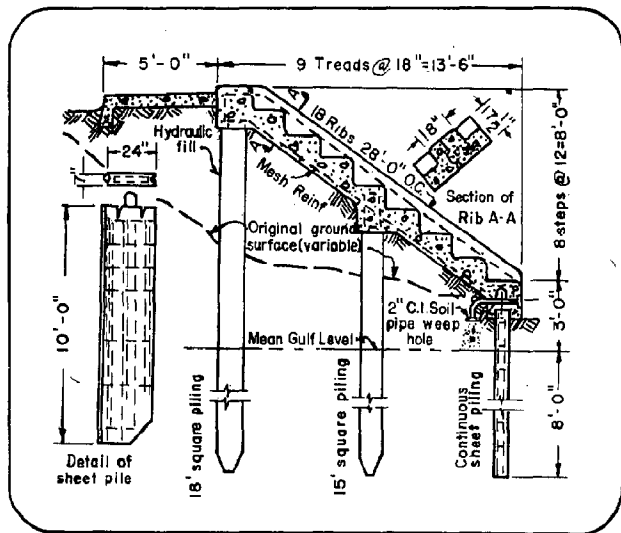
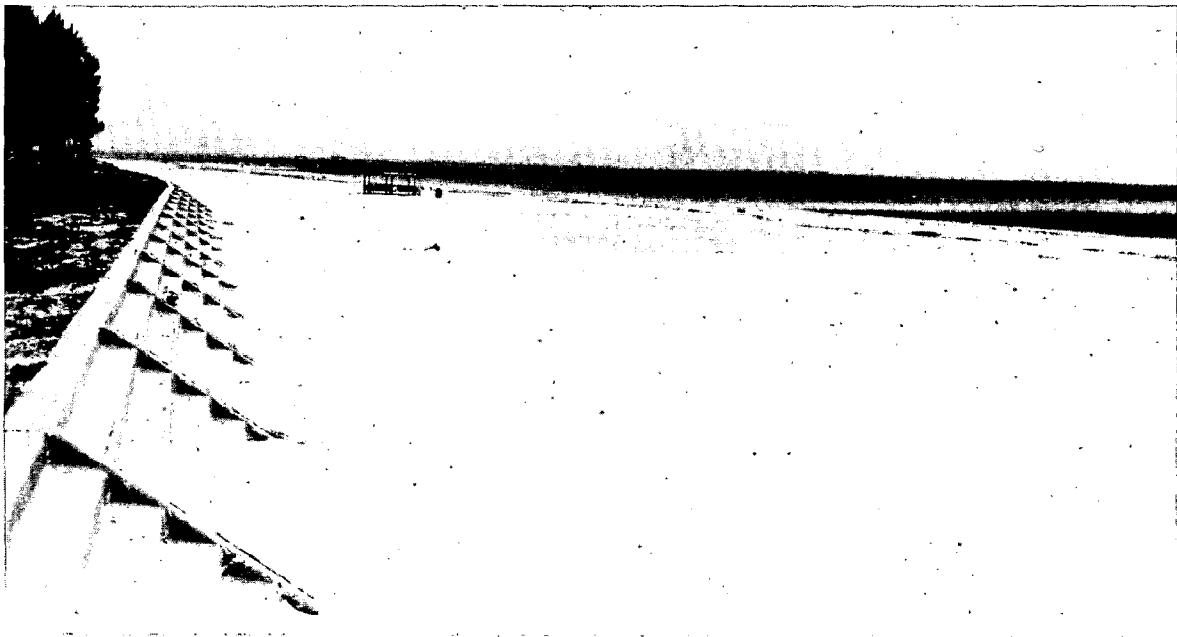

Figure 19. Concrete Combination Stepped and Curved-face Seawall San Francisco, California

a secondary line of defense in major storms. Bulkheads are constructed of steel, timber, or concrete piling. Typical steel and timber pile bulkheads are shown on Figures 16A and 16B, and a concrete pile bulkhead is shown on Figure 17. For ocean-exposed locations, bulkheads do not provide a long-lived permanent solution, because eventually a more substantial wall is required as the beach continues to recede and larger waves reach the structure. Unless combined with other types of protection, the bulkhead eventually evolves into the massive seawall capable of withstanding the direct onslaught of the waves. Extensive sea-



wall structures have been built principally in Massachusetts, Florida, Mississippi, Texas and California. Seawalls may have vertical, curved or stepped faces (see Figures 18, 19, 20 and 21). While seawalls may protect the upland, they do not hold or protect the beach which is the greatest asset of shorefront property. In some cases, the seawall may be detrimental to the beach in that the downward forces of water, created by the waves on striking the wall, rapidly remove sand from the beach. The Galveston seawall, shown on Figure 21, includes a stone apron to minimize scouring of the beach and undermining the wall.

A revetment armors the slope face of a dune or bluff with one or more layers of rock or concrete. This protection dissipates wave energy with less damaging effect on the beach than waves striking vertical walls. A rock revetment built at Cape Henry, Virginia, is shown on Figure 22. A light concrete-block revetment designed for a less exposed location in Chesapeake Bay is shown on Figure 23. A concrete-block revetment in a more exposed location fronting on the Atlantic Ocean at Jupiter Island, Florida, is shown on Figure 24.

Adequately designed bulkheads and revetments usually cost about \$75 to \$150 per foot of shore protected, depending upon exposure to wave action, total length, and proximity to sources of construction material. The cost of this type of protection might exceed \$400 per foot in some areas. Seawalls and breakwaters

(the latter discussed in the next section) are more expensive and are usually built only in the more openly exposed sites. Their estimated cost begins at, say, \$200 per foot and ranges considerably above \$500 per foot for massive structures far from rock sources.

—Breakwaters—

Beaches and bluffs or dunes can be protected by an offshore breakwater that prevents waves from reaching the shore. However, offshore breakwaters are more costly than onshore structures, and are seldom built solely for this purpose. Offshore breakwaters are constructed mainly for navigation purposes. A breakwater enclosing a harbor area provides shelter for boats. Breakwaters have both beneficial and detrimental effects on the shore. All breakwaters reduce or eliminate wave action

Figure 20. Concrete Stepped-face Seawall in Harrison and Hancock Counties, Mississippi



and thus protect the shore immediately behind them. Whether offshore or shore-connected, the elimination of wave action reduces littoral transport, obstructing the free flow of sand along the coast and starving the downstream beaches. At a harbor breakwater, the sand stream generally can be restored by pumping the sand through a pipeline from the side where sand accumulates to the starved side. This type of operation, in use for many years at Santa Barbara, California, is illustrated by Figure 25. Even without a shore arm, an offshore breakwater stops wave action and creates a quiet water area between it and the beach. In the absence of wave action to move the sand stream, the sand is deposited and builds the shore seaward toward the breakwater. The buildup actually serves as a barrier and completely dams the sand stream, depriving the downdrift beaches of sand. Although this type of construction is generally detrimental to downstream beaches, there is one case in which it may be used to aid the beach

processes. When placed on the updrift side of a navigation opening, the structure impounds sand, prevents it from entering the navigation channel, and affords shelter for a floating dredge to pump the impounded material across the navigation opening back into the stream of sand moving along the shore. This method is used at a harbor near Port Hueneme, California, shown on Figure 26.

Figure 21. Seawall at Galveston, Texas. Top elevation is 15.6 feet mean sea level. (Stone at toe and groins reduce loss of sand)

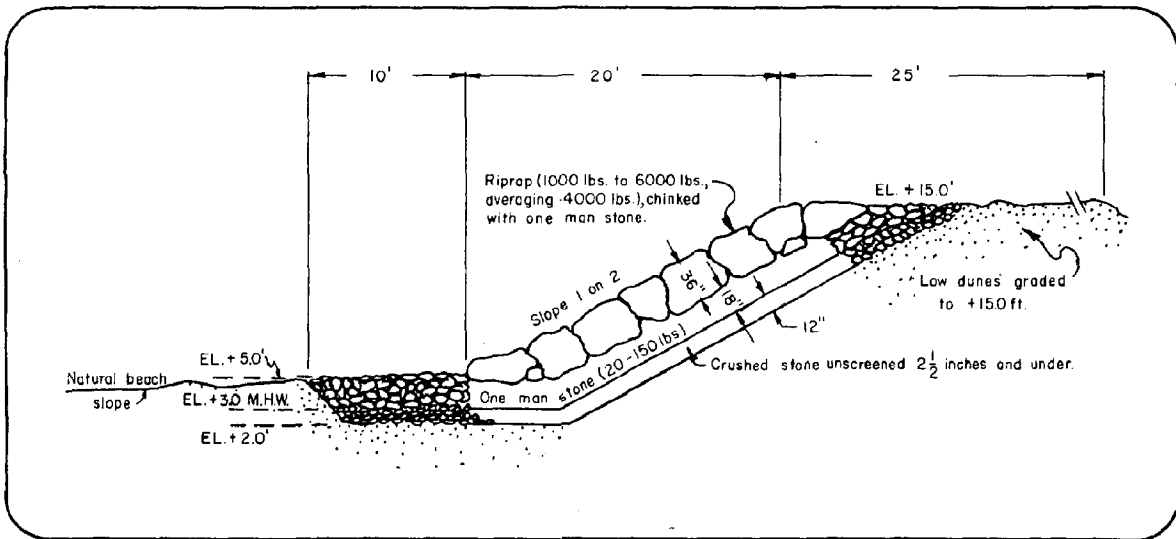
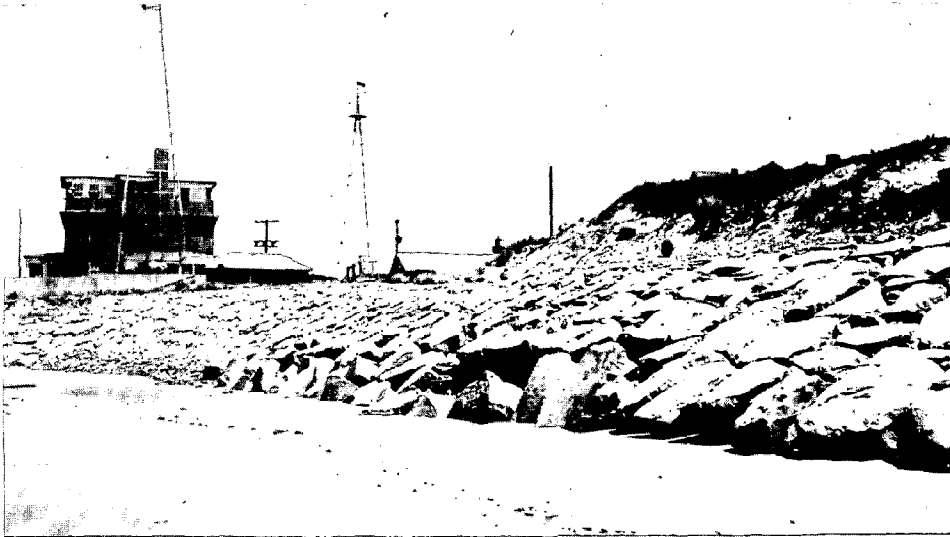

Figure 22. Stone Revetment at Cape Henry, Virginia

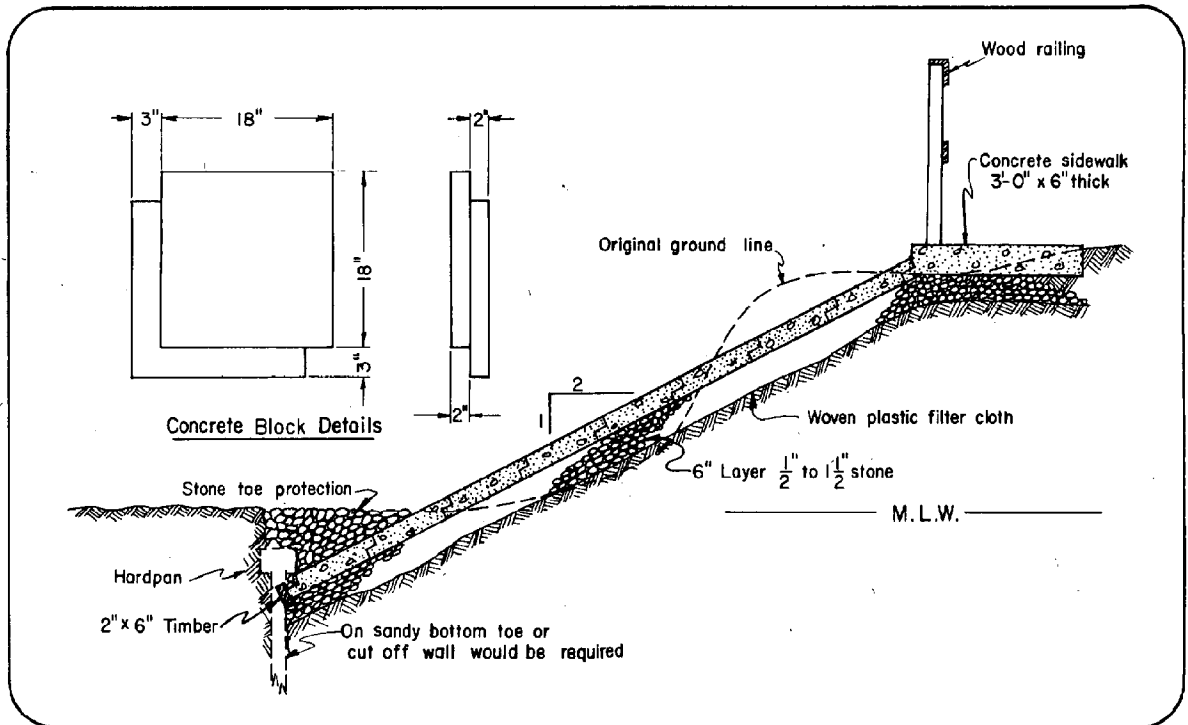
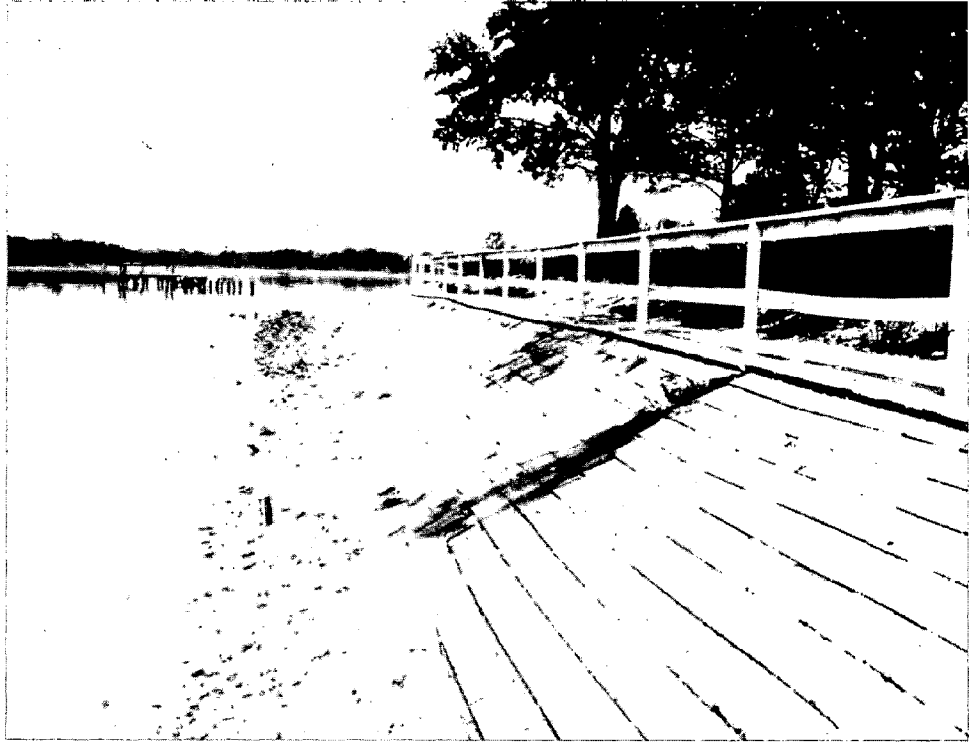

Figure 23. Interlocking Concrete-Block Revetment at Benedict, Maryland

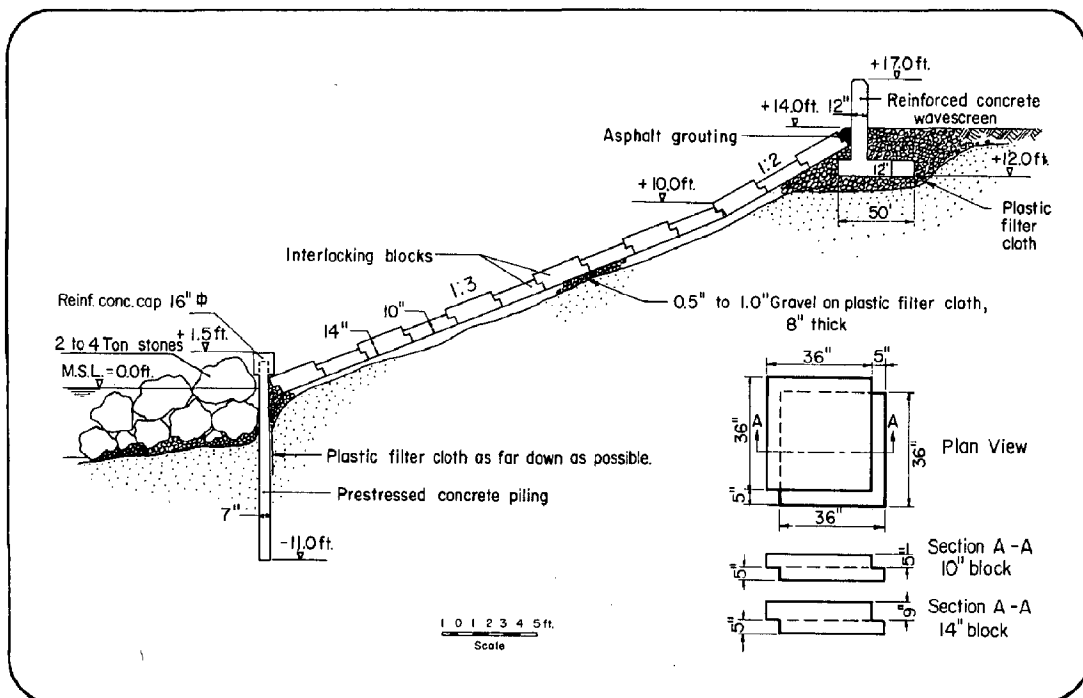

Figure 24. Interlocking Concrete-Block Revetment at Jupiter Island, Florida

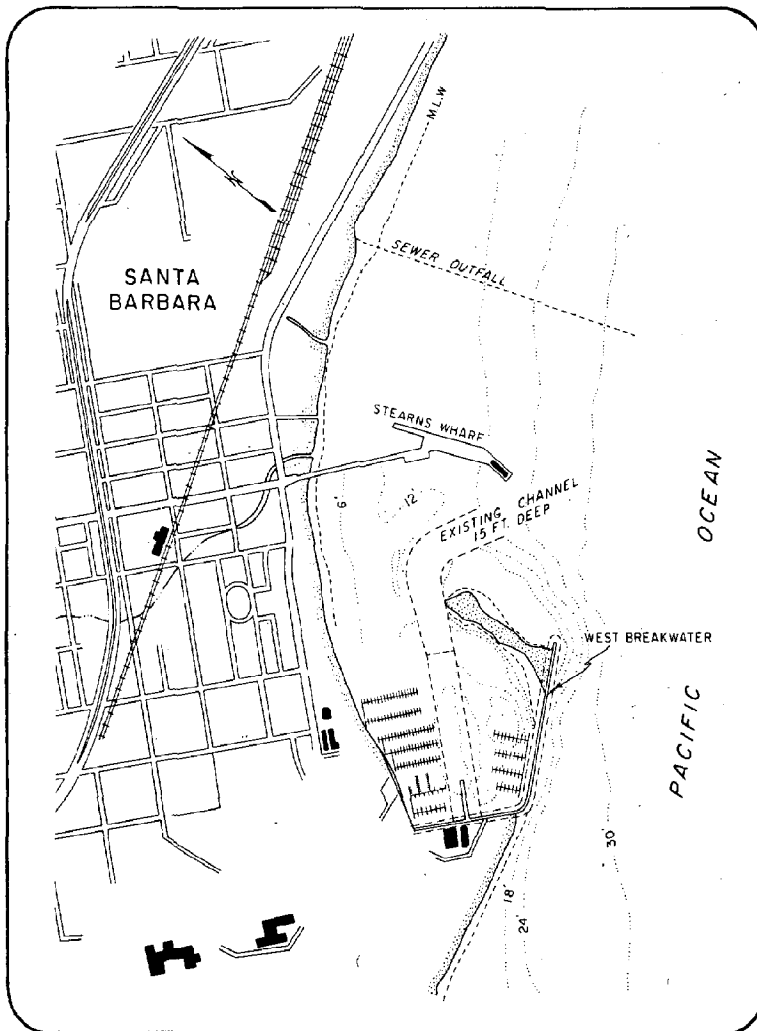
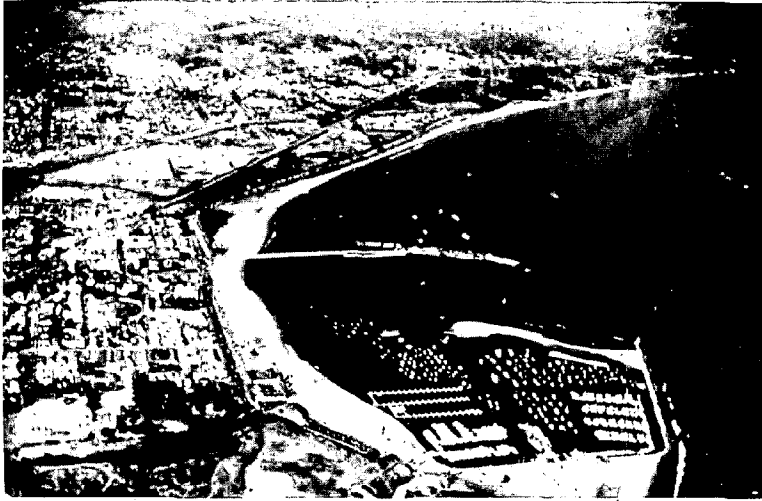
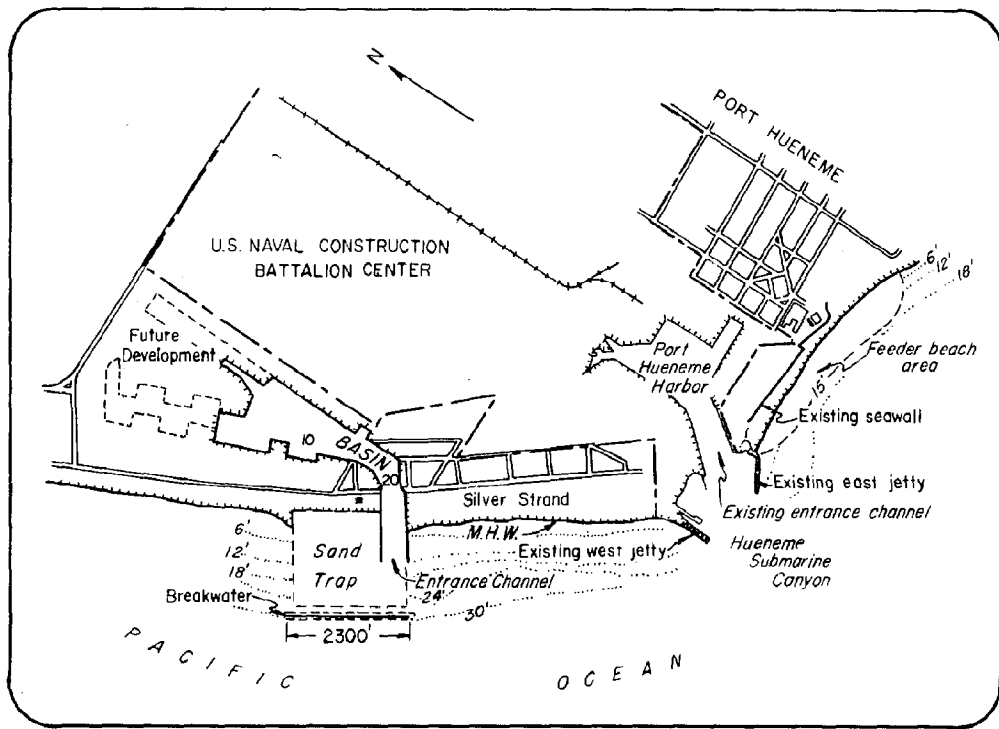
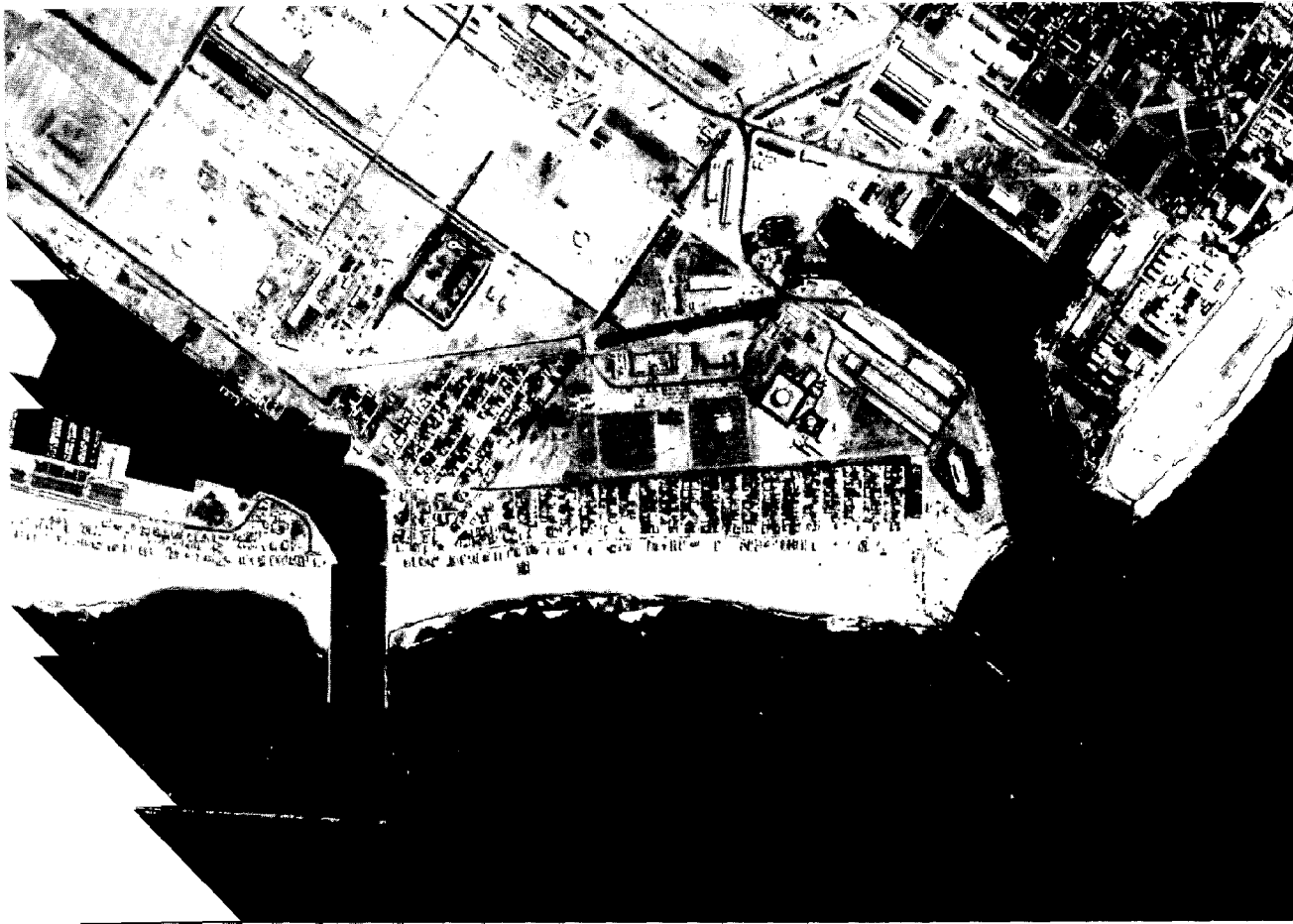

Figure 25. Sand Bypassing at Santa Barbara, California. Sand dredged from inside the breakwater is pumped to downdrift beach.



—Groins—

Long ago investigators noted that obstructions on a beach, such as logs or wrecks, would trap sand moving along the beach and cause the beach to widen. Such observations led naturally to devising the groin, a barrier-type structure which extends from the backshore into the littoral zone of sand movement. In earlier times, prior to the current extensive development of upstream river basins and major portions of the seacoast, the natural supply of beach sand was plentiful, and in many instances groins succeeded remarkably well. This led to further, excessive, and indiscriminate use of groins. They often were installed without considering all the factors pertaining to the particular problem. Figure 27 illustrates a successfully working groin system. The groin system shown in Figure 28 has had only marginal success at improving the beach because of an insufficient natural supply of sand. However, this system has presumably somewhat reduced the rate of loss of sand and the rate of shore recession.

The basic purpose of a groin is to interrupt alongshore sand movement to accumulate sand on the shore or to retard sand losses. Trapping of sand by a groin is done at the expense of the adjacent downdrift shore unless the groin or groin system is filled with sand to its entrapment capacity. To reduce the potential for damage to property downdrift of a groin, some limitation must be imposed on the amount of sand permitted to be naturally impounded on the updrift side. Since more and more shores are being protected, and less and less sand is available as natural supply, it is now desirable, and frequently necessary, to place sand artificially to fill the area between the groins, thereby ensuring a more-or-less uninterrupted sand supply to downdrift shores.

Groins have been constructed in many ways using timber, steel, concrete or rock, but can be classified into basic physical categories as high or low, long or short, and permeable and impermeable.

A high groin extending through the zone of breaking for ordinary or moderate storm waves initially entraps nearly all of the alongshore moving sand within that intercepted area until the areal pattern or surface profile of the accumulated sand mass allows sand to pass around the seaward end of the structure to the downdrift shores. Low groins (top profile no higher than that of desired reasonable beach dimensions) function like high groins, except that appreciable amounts of sand also pass over the top of the structure. Permeable groins permit some of the wave energy and moving sand to pass through the structure.

Figure 26. Sand Bypassing at Channel Islands Harbor, California. Sand is periodically dredged from trap and moved through a pipeline across both harbor entrances to the feeder beach on the far right. Photo was taken just after dredging.



Experience has shown that a short groin in heavy drift areas may fill quickly and have a limited effect on adjacent beaches. High groins, particularly if they extend beyond the breaker zone for most waves, adversely affect downdrift shores long after their updrift-side impounding capacity is reached. This is caused by diversion of littoral drift offshore beyond the end of the groin where its subsequent movement deprives downdrift beaches of an adequate supply of nourishment. The accreted sand adjacent to the updrift side of a long groin may result in such a different shore alignment from that of the natural ungroined shore that sand movement along that alignment by waves is retarded for many years. Short groins, and groins which have an appreciable degree of permeability, do not cause a pronounced setback in the shore immediately downdrift of the groin as the littoral transport of sand over and through these structures allows a more continuous supply to the downdrift area. Present knowledge of sediment transport by waves and currents does not permit satisfactory determination of the optimum degree of permeability for proper functioning of permeable groins. Impermeable groins can be more readily designed to serve the desired purpose, and they are more widely used. But groins of any type should not be built unless properly designed for the particular site. The effects of the contemplated groins on adjacent beaches should be studied by an experienced engineer.

Adequately designed protective groins may cost about \$100 to \$350 per foot of shore protected dependent upon such factors as exposure to wave action, range of tide, and accessibility of building materials. This is the cost range for groin structures only — where beach fill is also required to prevent adverse effect on downdrift shores, the cost increases accordingly.

Figure 27. Groin System — Willoughby Spit, Virginia

Figure 28. Groin System at Miami Beach, Florida (April 1962)



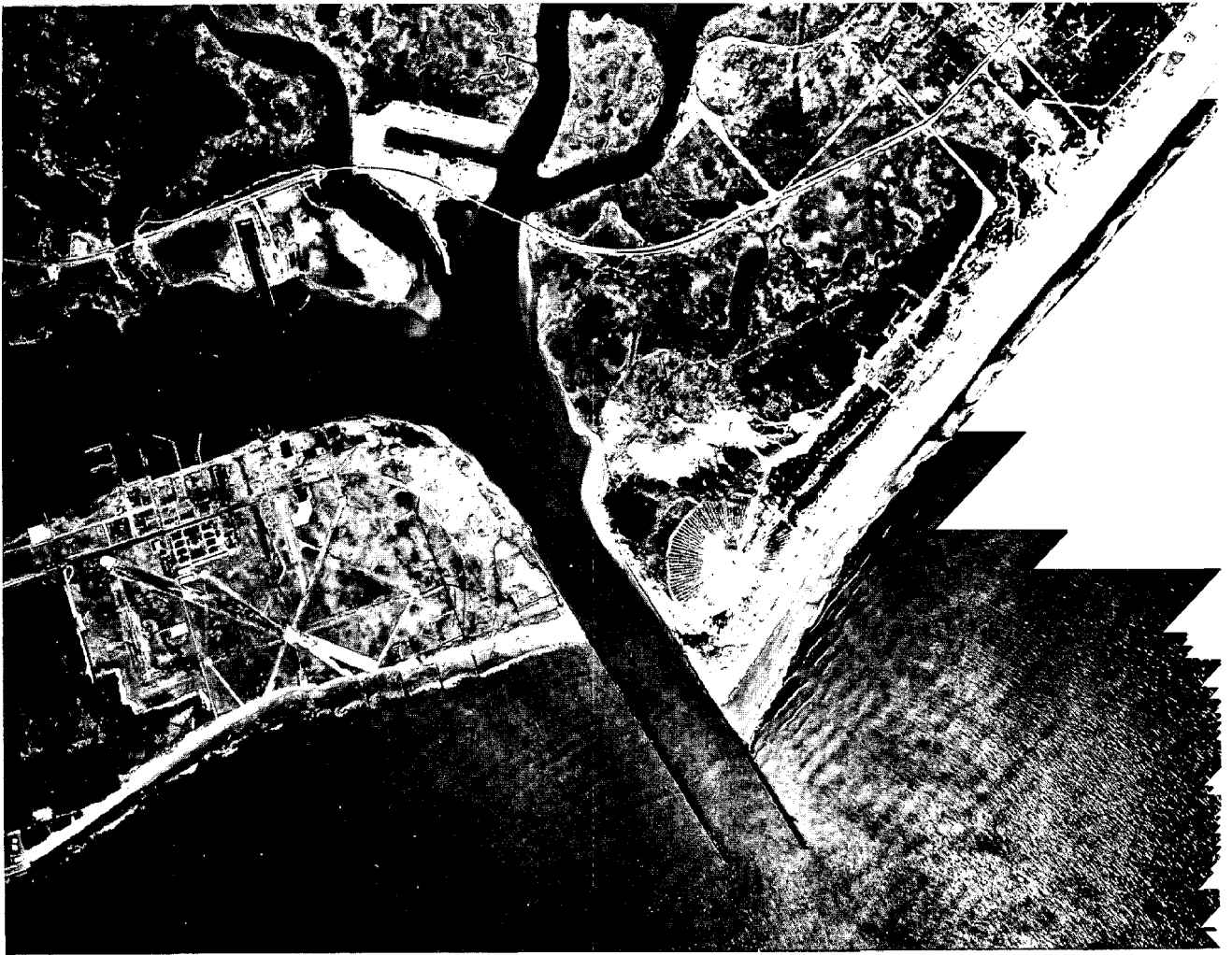

Figure 29. Jetties at Cold Spring Inlet, New Jersey, Entrance to Cape May Harbor. (Note widened beach adjacent to updrift jetty and eroded downdrift shore.)

—Jetties—

Another structure developed to modify or control sand movement is the jetty. This structure is generally employed at inlets in connection with navigation improvements (see Figure 29). When sand being transported along the coast by waves and currents arrives at an inlet, it flows inward on the flood tide to form an inner bar, and outward on the ebb tide to form an outer bar. Both formations are harmful to navigation through the inlet, and must be controlled to maintain an adequate navigation channel. The jetty is similar to the groin in that it dams the sand stream. Jetties are usually constructed of steel, concrete or rock. The type depends on foundation conditions, wave

climate, and economic considerations. Jetties are considerably larger than groins, since jetties sometimes extend from the shoreline seaward to a depth equivalent to the channel depth desired for navigation purposes. To be of maximum aid in maintaining the channel, the jetty must be high enough to completely obstruct the sand stream. Jetties aid navigation by reducing movement of sand into the



channel, by stabilizing the location of the channel, and by shielding vessels from waves. Adversely, sand is impounded at the updrift jetty as shown on Figures 29 and 30, and the supply of sand to the shore downdrift from the inlet is reduced thus causing erosion of that shore. Prior to the installation of a jetty, nature supplies sand by transporting it across the inlet intermittently along the outer bar to return to the downstream shore.

To eliminate undesirable downdrift erosion, some projects provide for dredging the sand impounded by the updrift jetty and pumping it through a pipeline to the eroding beach (see Figure 31). This ensures an uninterrupted flow of sand alongshore to nourish the downdrift beach, and also prevents shoaling of the entrance channel. At Shark River Inlet, New Jersey, shown on Figure 30, sand was transported across the inlet by truck with beneficial results.

A more recent development provides a low section or weir in the updrift jetty over which sand moves into a predredged deposition basin. By dredging the basin periodically, deposition in the channel is reduced or eliminated. The dredged material is normally pumped across the inlet to provide nourishment for the downdrift shore. A "weir-jetty" at Masonboro Inlet, North Carolina, is shown on Figures 32A and 32B.

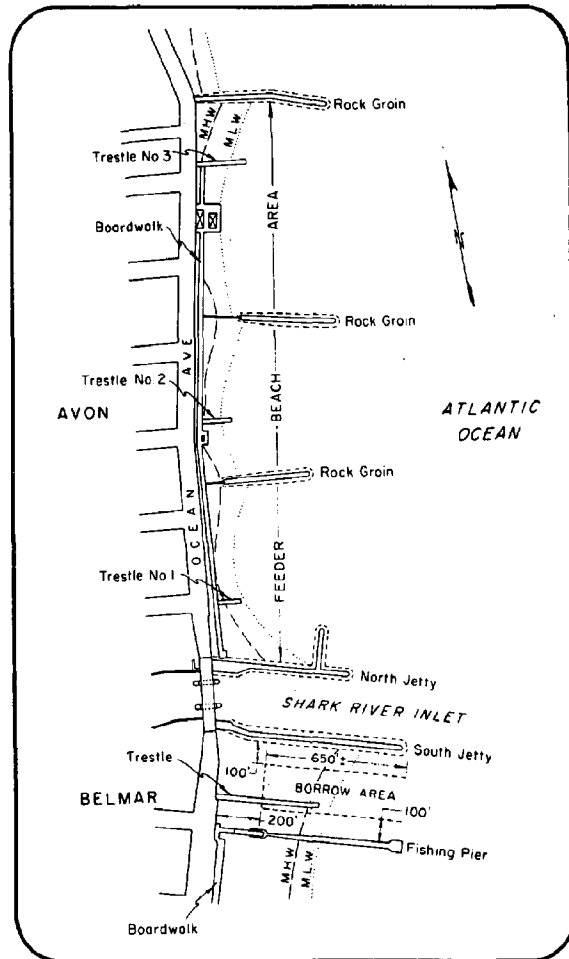

—Beach Restoration and Nourishment—

Beach structures, when properly used, have a place in shore protection. But research has shown that the best protection is afforded by using methods as similar as possible to natural ones. In other words, a greater degree of effectiveness is obtained by the type of protection provided by nature, which permits the natural processes to continue unhampered. To simulate natural protection, dunes and beaches are rebuilt artificially. Sand from sources behind the beach or offshore is placed on the shore. Figures 20 and 33 show views of Harrison County, Mississippi, after and before artificial restoration of the beach in front of the seawall with sand from the offshore bottom. This project was completed in 1952 and thus far has required minor maintenance. A restored beach at Presque Isle, Pennsylvania, is shown on Figure 34. To ensure continued stability of

the beach, material is placed periodically to make up deficiencies in the natural supply. This is most economical for long beaches as the increase of supply benefits the entire beach.

Coastal engineers can now determine required dune and beach dimensions to protect against storms of any given intensity. Dune heights sufficient to prevent overtopping by waves, and dune widths sufficient to withstand the erosion of a given storm can be determined. Also, beach dimensions, including height and width of berm and characteristics of sand required to maintain beach slopes, can be designed to withstand storms of a specified degree of severity. A project for beach restoration with an artificial dune for protection against hurricane wave action, completed at Wrightsville Beach, North Carolina, in 1965, is shown on Figure 35. Sometimes structures must be provided to protect dunes, to maintain a specific beach shape, or to reduce nourishment requirements. In each case, the cost of such structures must be weighed against the added benefits they would provide. Thus, measures to provide and keep a wider protective and recreational beach for a relatively short section of an eroding shore would require excessive nourishment without supplemental structures such as groins to reduce the rate of loss of material from the widened beach. A long, high terminal groin or jetty is frequently justified at the downdrift end of a beach restoration project to reduce losses of fill into an inlet and to stabilize the lip of the inlet.

Figure 30. Shark River Inlet, New Jersey, where Sand Impounded at Jetty was transported across Inlet by Truck.

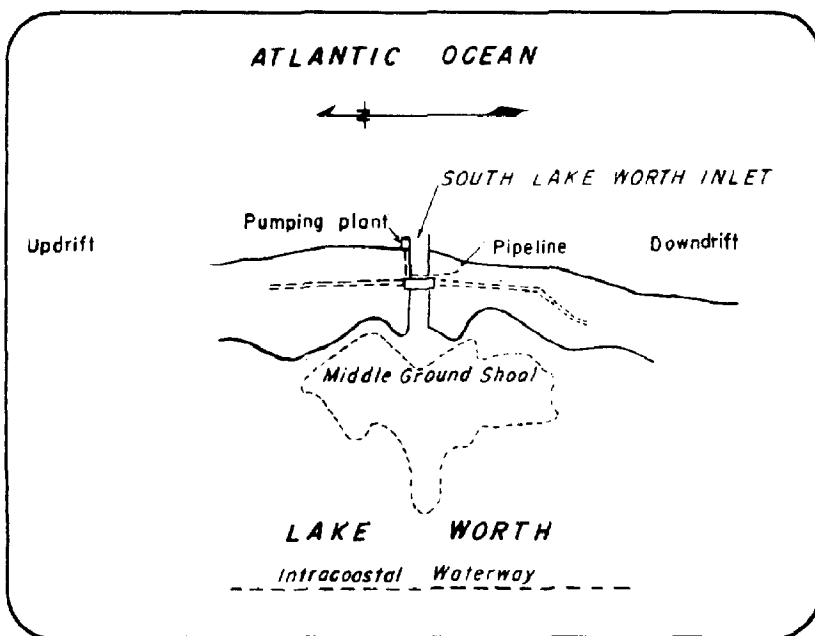
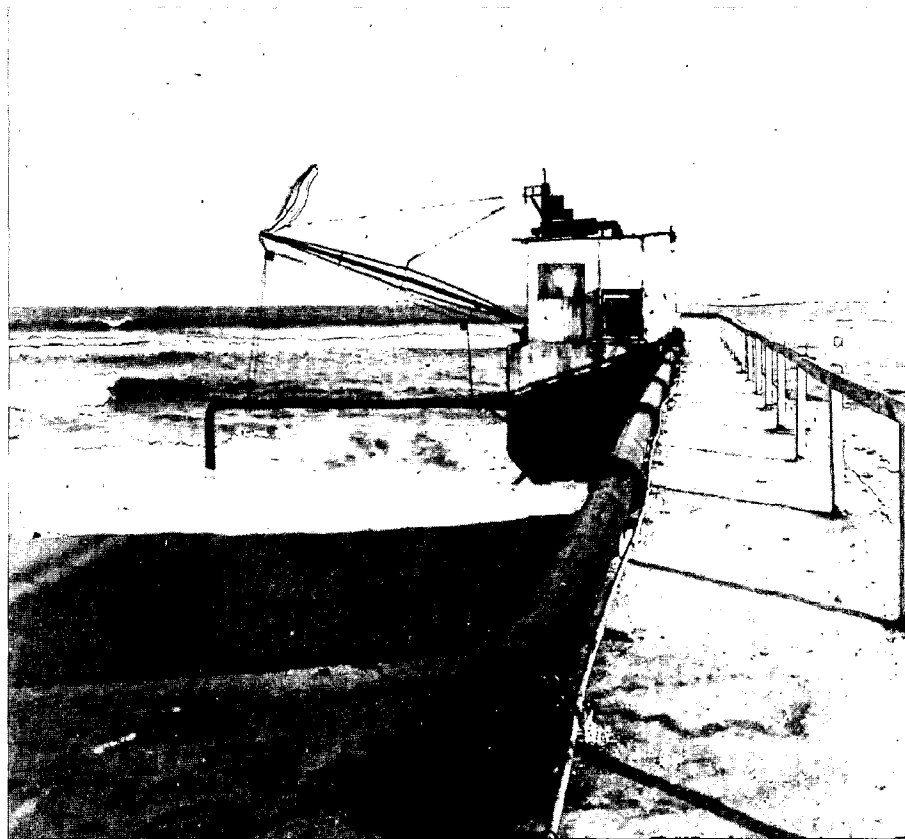

Figure 31. Fixed Bypassing Plant - South Lake Worth Inlet, Florida

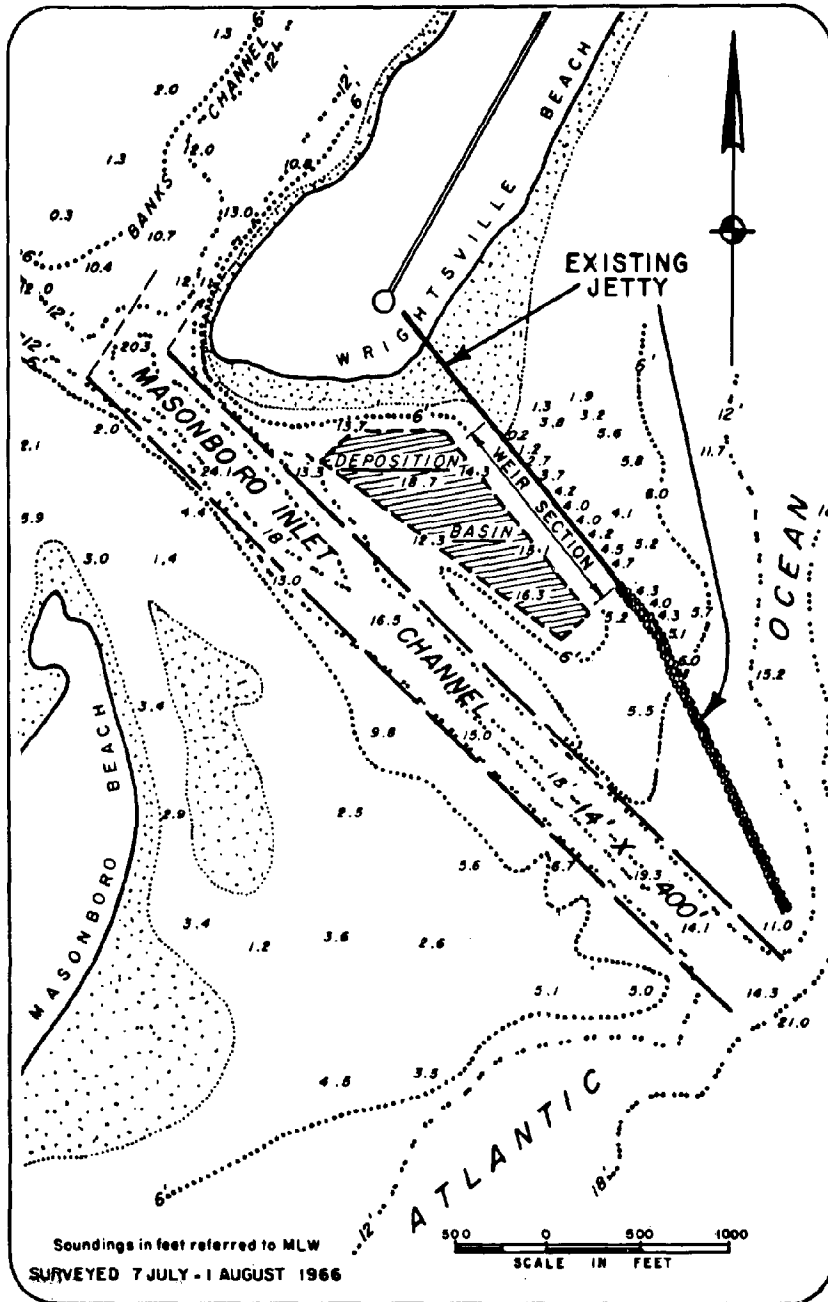

Figure 32A. Masonboro Inlet, North Carolina (July 1966)



*Figure 32B. Weir Jetty at Masonboro Inlet, North Carolina,
February 1966*

Figure 33. Concrete Stepped-face Seawall – Harrison and Hancock Counties, Mississippi. Figure 20 shows seawall after placement of beach fill.

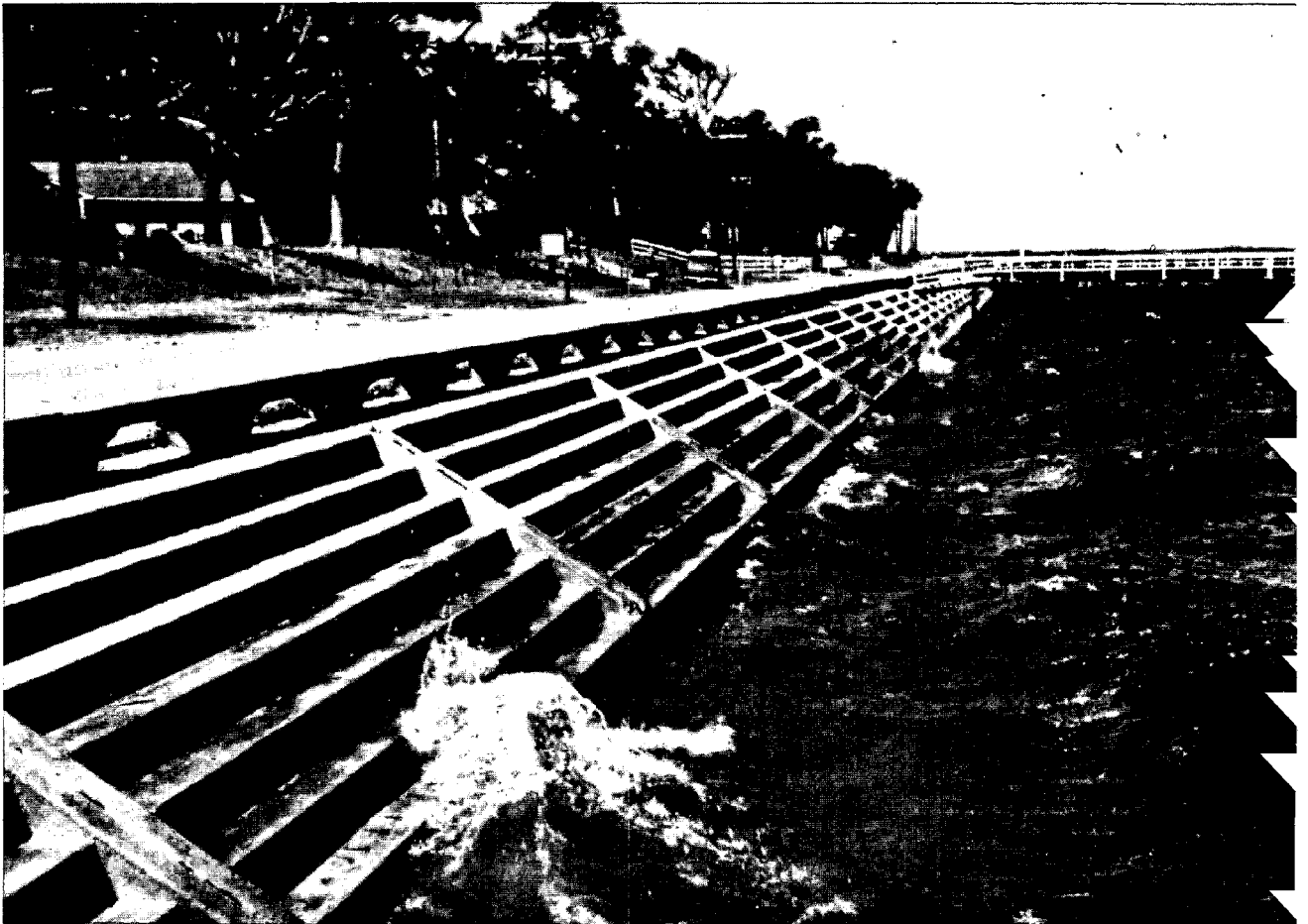



Figure 34. Restored Beach at Presque Isle Peninsula, Erie, Pennsylvania





Figure 35. Wrightsville Beach, North Carolina, after completion of Beach Restoration and Hurricane Protection Project

Beach fill for most beach widening or restoration can be expected to cost about \$50 to \$300 per foot of shore receiving the initial fill, depending on exposure, proximity of suitable fill borrow sites, length of beach, and degree of restoration required. Periodic nourishment may be required at intervals of 1 to 5 years at costs estimated to range from \$5 to \$15 per foot of shore per year, for straight beaches at least 2,000 feet long. It may be uneconomic, or even impracticable, to attempt nourishment of small segments of beach without retaining structures. The above estimates do not include dune rehabilitation and maintenance.



Figure 37. Dunes formed by trapping windblown sand with fences and grasses, Outer Banks, Nor. Carolina.

Figure 36. Weekday use of artificially nourished beach, north of Haverhill Avenue, Hampton Beach, New Hampshire.

—General—

Within the United States and its possessions there are many types of coast with a great variety of physical characteristics and activity of littoral processes. Under these conditions no one method of shore protection would be the most suitable and economical for all shores. The selection of a method of protection or improvement of a specific shore frontage must be based on adequate knowledge of the shore characteristics and littoral processes for the frontage.

—New England Region—

The States of Maine, New Hampshire, Massachusetts, Rhode Island and Connecticut have essentially the only shores of the Atlantic and Gulf coasts of the United States which include rocky headlands. These headlands are stable for all practical purposes and need no protection. However, there are also headlands and bluffs of glacial till and other erodible materials. These headlands and bluffs have in many cases been successfully protected by massive seawalls or revetments. Between the headlands there are frequently short stable pocket beaches, but in other cases, there are substantial lengths of sandy beaches attracting recreational users from great distances during seasonal months.

REGIONAL
PROTECTIVE
PRACTICES

accompanied by high storm surges, are a special problem in these regions. Dunes sufficiently high and massive to withstand the severe wave action at the high water stages surmounting a stabilized beach are normally the most economical type of protection. (See Figure 37 showing dune formation promoted by sand fences and grasses.)

—Puerto Rico and Virgin Islands—

The shores of these islands are similar to the New England Shores with rocky headlands and normally short reaches of sandy beach, and similar protective measures are usually indicated.

—Pacific Coast Region—

Although the shores of Washington, Oregon and California include many rocky headlands, there are also many long sandy beaches, such as those on both sides of the Columbia River in Washington and Oregon, and in Monterey Bay, on the Oxnard plain, near Santa Monica, from Long Beach to Newport Bay and south of San Diego Bay in California. As in New England, revetments are suitable for headland protection. Beach restoration and periodic nourishment have been used successfully for the sand beaches, accompanied by jetties or breakwaters and sand bypassing at inlets or harbors.

These include the shore segment from Old Orchard Beach to Saco, Maine, the reach from Hampton Beach, New Hampshire, to Annisquam, Massachusetts, the east shore of Cape Cod and the shores of Nantucket and Marthas Vineyard in Massachusetts, and the south shore of Rhode Island from Point Judith to Westerly. Many of the long beaches and even some of the shorter ones can be improved economically by artificial restoration and periodic nourishment. (See Figure 36 showing recreational use of restored and nourished beach.)

—Middle and South Atlantic, and Gulf Regions—

The east coast from New York to Florida and the Gulf coast from Florida to Texas consist generally of long, straight reaches of beach. Erodible headlands exist infrequently, as in northern and southern New Jersey. Much of the shore consists of barrier islands with the straight reaches of sandy shore interrupted by many inlets. Instability of the intervening beaches is usually associated with instability of the inlets. Under this condition, long reaches of shore can be most economically restored and stabilized by artificial placement of sand and periodic nourishment, accompanied by stabilization of the inlets by jetties with provision for bypassing the littoral drift. The bypassing may suffice to stabilize the downdrift problem area, but in some cases, supplemental nourishment from other sources is required. Hurricanes,

—Alaska Region—

The shores of Alaska are extremely diverse. Long stretches are similar to the New England,

Gulf and Pacific Coast regions. Normal daily tides of relatively large range occur on the Pacific Coast of Alaska. Although beaches may be restored or widened by artificial placement of sand and maintained by periodic nourishment; such treatment is frequently not justified due to the absence of recreational use. Thus, where stabilization of short reaches is justified by protective rather than recreational benefits, revetment is likely to prove the most suitable method of protection.

—Hawaiian Islands—

These islands have the usual characteristics of volcanic islands with rocky headlands and relatively short sandy beaches. The fringing offshore coral reef substantially reduces the severity of wave attack on some parts of the shore. However, the north shores are subject to very heavy wave action caused by North Pacific storms, as well as the tsunamis resulting from earthquakes in the North Pacific region. An economical method of tsunami protection has not as yet been devised. Possibly the removal of development from areas within reach of tsunami waves is the only feasible means of preventing damage from future tsunamis.

—Great Lakes Region—

Shore characteristics vary widely on the Great Lakes. Eroding bluffs, in many cases,

supply only a limited amount of sediment of sufficient size to remain on the beach. Thus, there is a general deficiency in sand supply. Beach restoration, nourishment, revetments and seawalls have all been used. The shore is also interrupted by many inlets and harbors so that erosion of downdrift shores is common. A special cause of shore problems is the cyclical variations in lake level. In addition to seasonal variations every year, there are major periods of high lake levels such as those of 1952 and 1969. These high stages inundate the beaches, and permit larger waves to reach and erode the bluffs. Protection of bluffs usually requires revetments or seawalls. On some of the beaches restoration and periodic nourishment would be feasible. In many cases, sand available for bypassing at inlets may be insufficient and the supply of sand must be augmented from other sources.

CONSERVATION OF SAND

Experience and study have demonstrated that sand, in our dunes, beaches and nearshore areas, is the principal material available naturally near the shore in suitable form to protect our seacoasts. Where sand is available in abundant quantities, protective measures are greatly simplified and reduced in cost. When dunes and broad, gently sloping beaches can no longer be provided, it is necessary to resort to alternative structures, and the recreational attraction of the seashore is lost or greatly diminished.

Sand is a rapidly diminishing natural resource. Although once carried to our shores in abundant supply by streams, rivers and glaciers, cultural development in the watershed areas has progressed to a stage where large areas of our coast now receive little or no sand through natural geological processes. Continued cultural development by man in inland areas tends to further reduce erosion of the upland with resulting reduction in sand supply to the shore. It thus becomes apparent that sand must be conserved. This does not mean local hoarding of beach sand at the expense of adjoining areas, but rather the elimination of wasteful practices and the prevention of losses from the shore zone whenever feasible.

Fortunately, nature has provided extensive storage of beach sand in bays, lagoons, estuaries and offshore areas which can be used as a source of beach and dune replenishment in those cases where the ecological balance will not be disrupted. Massive dune deposits are also available at some locations, though these must be used with caution to avoid exposing the area to flood hazard. These sources are not always located in the proper places for economic utilization, nor will they last forever. When they are gone, we must face increasing costs for the preservation of our shores. Offshore sources will probably become the most important source when means for economic recovery become available.

Mechanical bypassing of sand at coastal inlets is one means of conservation which will come into increasing practice. Mining of beach sand for commercial purposes, formerly a common procedure, is rapidly being reduced as coastal communities learn the need for regulating this practice. Modern hopper dredges, used for channel maintenance in coastal inlets, are being equipped with pump-out capability so that their loads can be discharged on the shore instead of being dumped at sea, and it is expected that this source of loss will ultimately be eliminated. On the California coast, where large volumes of sand are lost into deep submarine canyons near the shore, facilities are being considered which will trap the sand before it reaches the canyon and transport it mechanically to a point where it can resume normal beach transport.

Dune planting with appropriate grasses and shrubs reduces windborne losses landward and aids in dune preservation. Sand conservation is a very important factor in the preservation of our seacoasts, and it must not be neglected in long-range planning.

CONCLUSION

Protection of our seacoasts is not a simple problem; neither is it insurmountable. It is a task and a responsibility which has increased tremendously in importance in the past 50 years, and is destined to become a necessity in future years. While the cost will mount as time passes, it will be possible through careful planning, adequate control and sound engineering to do the job properly and within our means economically. Shore protection can no longer be regarded as an individual responsibility, but must be undertaken as a cooperative effort on a comprehensive basis, with all levels of government participating.

NOAA COASTAL SERVICES CENTER LIBRARY



3 6668 14102 5033