

Manual of Standards for

EROSION & SEDIMENT CONTROL MEASURES

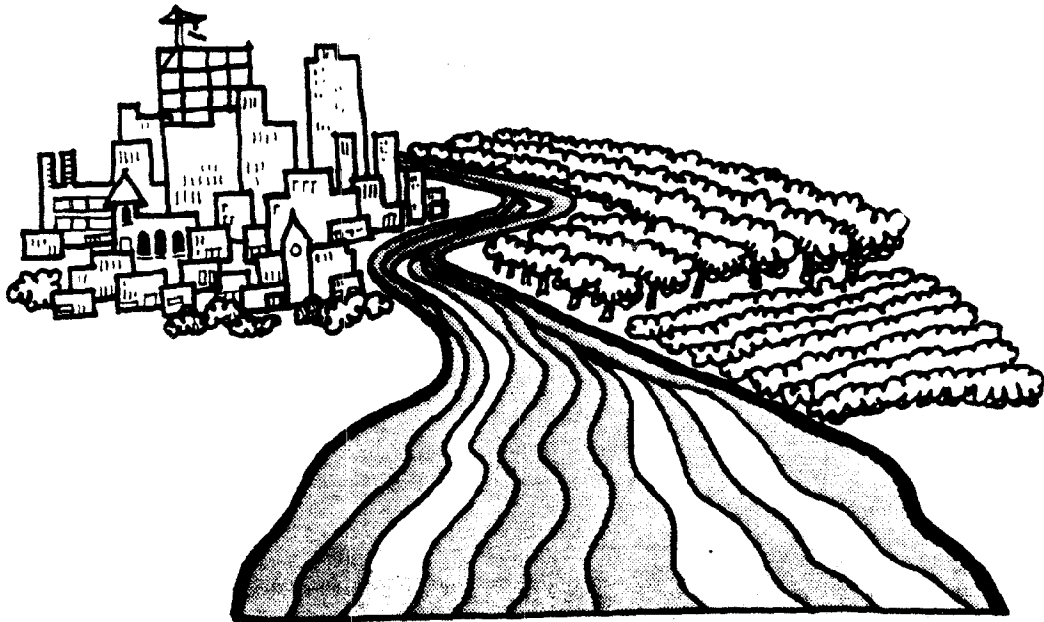

Association of Bay Area Governments

COASTAL ZONE
INFORMATION CENTER

S
623
.M3
1981

ASSOCIATION OF BAY AREA GOVERNMENTS

REVISED EDITION JUNE 1981

MANUAL OF STANDARDS

FOR

EROSION AND SEDIMENT CONTROL MEASURES

RECEIVED

MAY 10 1988

SAN FRANCISCO BAY CONSERVATION
& DEVELOPMENT COMMISSION

U. S. DEPARTMENT OF COMMERCE NOAA
COASTAL SERVICES CENTER
2234 SOUTH HOBSON AVENUE
CHARLESTON, SC 29405-2413

Property of CSC Library

June 1981

Association of Bay Area Governments

5623.M3.1981

8122961

SEP 4 1987

TABLE OF CONTENTS

| | <u>Page</u> |
|--|-------------|
| I. INTRODUCTION | 1 |
| II. MODEL ORDINANCES TO IMPROVE LOCAL CONTROLS OVER EROSION AND SEDIMENTATION FROM GRADING ACTIVITIES | 5 |
| III. EROSION AND SEDIMENT CONTROL PLANS | 9 |
| IV. CALCULATING SURFACE RUNOFF AND SOIL LOSS | 17 |
| V. STANDARDS AND SAMPLE SPECIFICATIONS FOR EROSION AND SEDIMENT CONTROL MEASURES | 25 |
| 1. Temporary and Permanent Planting of Exposed Soils | 31 |
| 2. Temporary and Permanent Grass Protection of Waterways, Swales and Dikes | 41 |
| 3. Temporary Dike | 50 |
| 4. Temporary Swale | 54 |
| 5. Temporary Grade Stabilization Structure | 58 |
| 6. Temporary Sediment Basin | 65 |
| 7. Temporary Sediment Trap | 77 |
| 8. Temporary Stabilized Construction Entrance | 86 |
| 9. Temporary Straw Bale Dike | 89 |
| 10. Temporary Silt Fence | 92 |
| 11. Temporary Check Dam | 98 |
| 12. Permanent Waterway | 104 |
| 13. Permanent Riprap | 113 |
| 14. Permanent Storm Drain Outlet Protection | 117 |
| 15. Permanent Subsurface Drain | 124 |
| 16. General Land Grading Practices for Minimizing Erosion | 130 |
| 17. Protective Materials for Channels and Steep Slopes | 136 |
| IV. ENFORCEMENT GUIDELINES FOR ON-SITE EROSION AND SEDIMENT CONTROL | 141 |
| APPENDICES | |
| A. Model Ordinance No. 1 | A-1 |
| B. Model Ordinance No. 2 | B-1 |
| C. Sample Determinations of Subsurface Drain Sizes | C-1 |
| D. Sediment Basin Design | D-1 |
| E. Sample Waterway Design | E-1 |
| F. Sample Design Procedure for Riprap-Lined Channels | F-1 |
| G. Sample Design of Outlet Protection | G-1 |

LIST OF TABLES AND FIGURES

| | <u>Page</u> |
|---|-------------|
| Table 1. Standard Symbols for Erosion and Sediment Control Measures | 10 |
| Table 2. Rational Method "C" Values. | 19 |
| Table 3. Precipitation Intensity ("i") Values San Francisco Bay Area | 20 |
| Table 4. Summary of Control Measure Applications | 27 |
| Table 5. Erosion Control Ratings of Plants Used in the Bay Area | 32 |
| Table 6. Plants Not Recommended For the Bay Area | 33 |
| Table 7. Plants Suitable for Bay Area Grassed Waterways, Swales and Dikes | 43 |
| Figure 1. Thresholds for Minor and Major Permits in Model Ordinance No. 1 | 6 |
| Figure 2. Mean Annual Rainfall San Francisco Bay Area | 21 |

I. INTRODUCTION

1. PURPOSE OF MANUAL

This manual provides guidance to Bay Area cities and counties in controlling water quality impacts of construction-related erosion. It suggests a framework for regulation and enforcement and describes technical standards and sample specifications for control measures.

The program outlined in these chapters is flexible. The various components can be used in their entirety or only in part. They are intended to be revised, amended, incorporated into existing regulations or otherwise adjusted to fit the needs of local jurisdictions in developing their own erosion and sediment control programs.

The standards and sample specifications for erosion and sediment control measures were largely adapted from California and national USDA, Soil Conservation Service standards and specifications, from Standards and Specifications for Erosion and Sediment Control in Developing Areas (USDA, Soil Conservation Service, College Park, Maryland, 1975) and from Virginia Erosion and Sediment Control Handbook, (Virginia Soil and Water Conservation Commission, Richmond, Virginia, 1980). Several, appropriately noted, were developed by ABAG after substantial research into Bay Area erosion and sediment control practices. Because of the variability of local and site-specific conditions such as rainfall and soil conditions, all standards and sample specifications should be reviewed by a qualified professional before they are adopted by a local jurisdiction.

2. PRINCIPLES OF EROSION AND SEDIMENT CONTROL

The denuded slopes of construction sites are a major source of surface runoff pollution in the Bay Area. Particles of nutrient-rich topsoil, displaced by the force of rain and runoff, are carried downslope into stream channels and water bodies. The resulting water quality problems include sediment buildup and blockage of channels, turbidity, increased algal growth and oxygen depletion.

The following are principles for controlling erosion and sediment on construction sites:

- fit development to the existing topography, soils, and vegetation as much as possible;
- minimize soil exposure during the rainy season by proper timing of grading and construction;
- retain natural vegetation whenever feasible;
- vegetate and mulch denuded areas to protect them from winter rains;

- divert runoff away from steep denuded slopes or other critical areas with barriers or ditches;
- minimize length and steepness of slopes by benching, terracing or constructing diversion structures;
- prepare drainageways to handle concentrated or increased runoff from disturbed areas by using riprap or other lining materials;
- trap sediment-laden runoff in basins to allow soil particles to settle out before flows are released to receiving waters;
- inspect sites frequently to ensure control measures are working properly, and correct problems as needed.

3. ELEMENTS OF LOCAL REGULATORY PROGRAMS

Local regulatory programs to implement and enforce such measures should include the following elements:

a. An Erosion and Sediment Control Ordinance

The ordinance would create a framework for regulation and provide the legal basis for enforcement. It should require applicants for grading permits to submit plans for erosion and sediment control and should define the process for reviewing, approving and enforcing those plans.

Because the ordinance must be applicable to a number of different conditions, it must be a flexible document. It therefore should not contain technical details likely to change over time or that are better determined on a case-by-case basis. These details should instead be included by reference to a manual of standards and specifications (see below).

b. Erosion and Sediment Control Plans

As required by the ordinance, a plan should be submitted for each project describing measures for erosion and sediment control on the construction site. The control measures specified must be of an appropriate type and size to accommodate predicted runoff and sediment yield from the site and should be designed according to the standards and specifications prescribed in the manual (see below).

c. A Manual of Standards and Specifications

The manual, referenced in the ordinance, should contain standards and specifications for proven, effective procedures for constructing, operating and maintaining control measures. It should be continuously revised to incorporate new data and technological developments, thereby enabling the ordinance to keep pace with technology without legislative revision.

d. Means of Enforcement

The ordinance, with the required erosion and sediment control plans, and referenced manual of standards and specifications, would provide the legal basis for enforcement. Failure to install the required measures or to meet standards would constitute a clear violation of permit requirements. The ordinance would also establish procedures for reporting violations and the fines and penalties that may be imposed. The job of the local site inspector would be to see that all requirements of the ordinance are enforced on the site. Guidelines should be established to help him or her obtain developer compliance and deal with violations.

The following chapters of this manual present models and descriptions of the elements of an effective regulatory program. They are intended to be used by Bay Area cities and counties in developing their own ordinances, standards and specifications, and enforcement guidelines. It should again be emphasized that these program elements are intended as guides.



II. MODEL ORDINANCES TO IMPROVE LOCAL CONTROLS OVER EROSION AND SEDIMENTATION FROM GRADING ACTIVITIES

Many communities in the Bay Area and throughout California have weak regulations governing erosion and sediment control. Two model ordinances have been developed by ABAG to assist local governments in improving the way their grading ordinances control erosion and sediment from construction sites. The model ordinances are included in the Appendices. They are based on an analysis of published model ordinances and existing ordinances in California and other states.

Model Ordinance No. 1 (Appendix A) is an ordinance to add erosion and sediment control provisions to an existing grading ordinance. It is designed to supplement, not replace, a community's grading regulations. This model was reviewed by ABAG's Water Quality Technical Advisory Committee and the Citizens Advisory Committee and revised pursuant to comments from committee members and other interested parties.

Model Ordinance No. 2 (Appendix B) is a combined grading and erosion and sediment control ordinance. It integrates standard grading provisions from a typical local grading ordinance with provisions for erosion and sediment control.

To be effective, any erosion and sediment control ordinance should contain certain key features. These basic features are described below. The numbers of the model ordinance sections that pertain to these key features are also provided. Both models in this Manual contain these key elements, although they sometimes differ in form.

Although the two models share similar provisions and goals, there are several important differences between them. Model No. 1 features a system of "minor" and "major" permits. Figure 1 highlights the major thresholds for the permits required under this ordinance. This minor and major permit system reduces the requirements for permittees who grade relatively small and flat sites. Model No. 2 features a single permit, but increases the discretion of the permit administrator to reduce requirements where appropriate.

Model No. 1 requires permittees to submit reports by specific dates. Inspections by the local jurisdiction are also required. Model No. 2 requires reports only when a specified event takes place. Inspections are completely discretionary. Review standards and procedures found in Model No. 1 (Article III) are largely omitted from Model No. 2.

These model ordinances and the list of key features can be used by local jurisdictions to evaluate the effectiveness of their present grading ordinances in controlling erosion and sediment from construction sites. The models can also be used to revise or amend local ordinances. Although it is possible for a jurisdiction to adopt either model in its entirety, adoption of any new or revised provisions should be tailored to a jurisdiction's specific problems and limitations. Local government legal counsel and grading officials should be consulted.

FIGURE 1. THRESHOLDS FOR MINOR AND MAJOR PERMITS IN MODEL ORDINANCE NO. 1

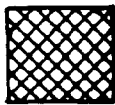
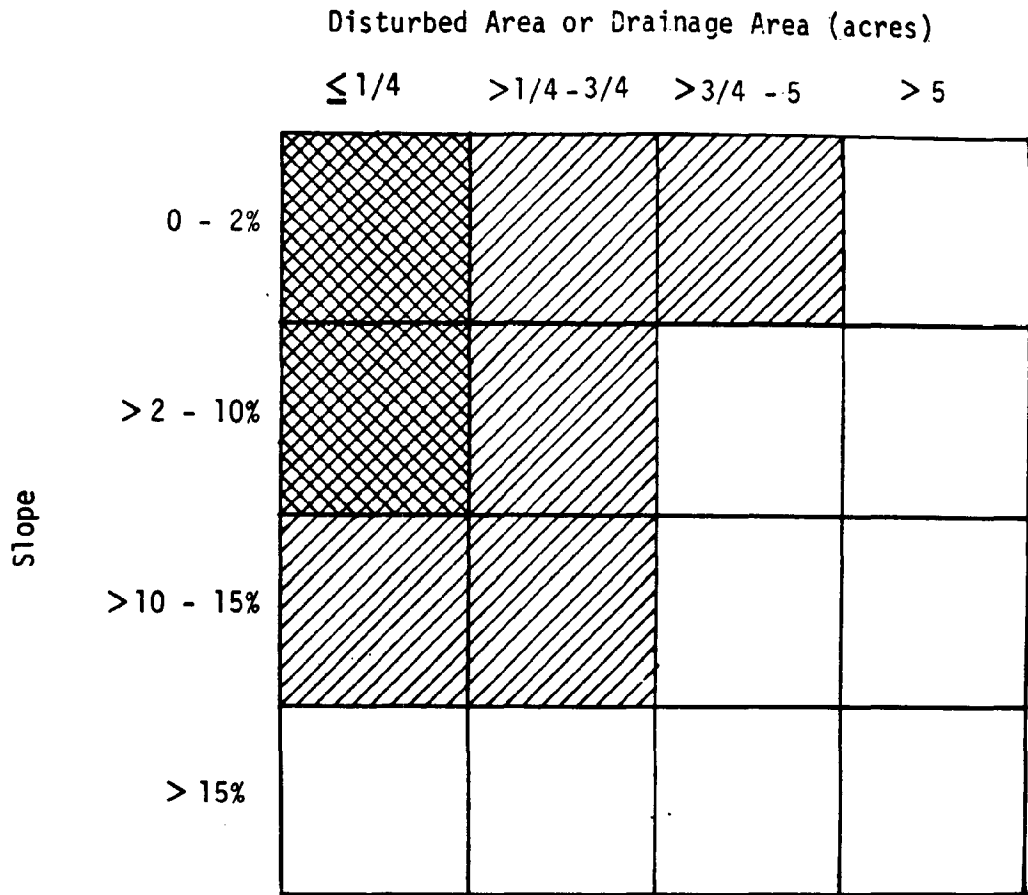

See Section 201.02 of Model Ordinance No. 1.

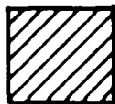

Minor permit: erosion and sediment control plans, spot inspections



Major permit: erosion and sediment control plans, scheduled reports, scheduled inspections

1. KEY FEATURES OF AN EFFECTIVE EROSION AND SEDIMENT CONTROL ORDINANCE

The numbers in parentheses refer to the sections of Model Ordinance Nos. 1 and 2 that contain each key feature.

a. Water Quality Is an Explicit Goal of the Ordinance

This provision specifically informs applicants proposing land-disturbing activities that one purpose and intent of the ordinance is protection of water quality. It also provides judicial guidance for adjudication of cases arising under the ordinance.

(Model No. 1: §101.01; Model No. 2: §2.)

b. Exemptions from the Permit Requirement Are Limited

All grading that may result in significant erosion and sedimentation (such as home sites on steep hillsides) should be regulated.

(Model No. 1: §201.02; Model No. 2: §§11, 12.)

c. Temporary and Permanent Erosion and Sediment Control Plans Meeting Minimum Standards Must Be Submitted

This provision provides a strong enforcement tool. Applicants must specify in writing how they will control erosion and sediment on a site. The responsible local agency can thus assess, in a timely manner, whether the plan makes sense, whether there are sufficient details and whether the specifications meet accepted standards (such as those in Chapter V of this Manual). If the measures shown on the plan are not installed or are implemented contrary to the plan specifications, there is a documentable violation.

(Model No. 1: §§202.03, 202.04; Model No. 2: §§17, 18.)

d. Approved Control Measures Must Be Installed before the Rainy Season

Installing measures before the rainy season greatly reduces the likelihood of erosion and sediment problems.

(Model No. 1: §202.06; Model No. 2: §21.)

e. Provisions for Reports by the Permittee and Inspections by the Local Agency Are Included

A scheme of reports and inspections is designed to inform the local agency whether the permittee has installed erosion and sediment control devices in a proper and timely manner. By requiring permittees to report to the local agency on project status, the burden on the local agency of monitoring projects is reduced.

(Model No. 1: §§402.01, 402.02(b); Model No. 2: §§31, 32(b).)

f. The Local Agency May Require Modification of an Erosion and Sediment Control Plan

Where an approved erosion and sediment control plan is later found to be inadequate, or the plan as implemented appears to be ineffective, modifications may be required. This provision is the legal basis for requiring plan changes after initial plan approval.

(Model No. 1: §402.02(a); Model No. 2: §32(a).)

g. Special Provisions Are Applied to Grading that Will Commence or Continue during the Rainy Season

Since grading during the rainy season is likely to cause serious erosion and sediment problems, additional safeguards are required.

(Model No. 1: §402.01(c); Model No. 2: §41.)

h. Enforcement Mechanisms Are Available to the Local Agency

Several provisions, such as suspension or revocation of permit, fines and penalties, are included to induce permittees to comply faithfully with the grading regulations. Where suspension or revocation of a permit is not a viable option, fines and penalties can be levied.

(Model No. 1: §§403.01, 403.02; Model No. 2: §§34, 35.)

i. Permittee Is Required to Provide Security

Where a permittee's failure to properly install appropriate erosion control devices causes a threat of erosion and sedimentation, security in the form of a deposit or bond is available to the local jurisdiction to finance remedial work. Security must be sufficiently large and available on short notice if excessive erosion is to be avoided or mitigated.

(Model No. 1: §§202.07, 403.03; Model No. 2: §§22, 36, 37.)

III. EROSION AND SEDIMENT CONTROL PLANS

An effective erosion and sediment control ordinance should require an erosion and sediment control plan. This plan should be submitted as part of a grading permit application. In this plan the applicant should describe how erosion and sediment will be controlled on the construction site. He or she should provide sufficient details so that the reviewing agency can evaluate whether the plan will work and whether the specifications meet accepted standards.

Two levels of erosion and sediment control plans may be appropriate, depending on the size of the project. For small developments on relatively flat land, simple, nonengineered erosion and sediment control plans may be submitted. For large or hillside developments, detailed, engineered plans should be required.

The guidelines for erosion and sediment control plans on the following pages are primarily for large or hillside projects. They are intended to be adopted by local planning and public works departments. They may be added to existing procedures manuals or incorporated into internal guidance memoranda for staff.

Following the guidelines is a sample erosion and sediment control plan that demonstrates how the guidelines may be applied to conditions of a particular project. The sample map from this plan uses a set of standard symbols for erosion and sediment control measures (see Table 1). To facilitate preparation and review of erosion and sediment control plans from jurisdiction to jurisdiction, the use of these standard symbols is recommended.

1. GUIDELINES FOR EROSION AND SEDIMENT CONTROL PLANS

a. Plan Preparer

The plan shall be prepared and signed by a person or firm qualified by training and experience to have expert knowledge of erosion and sediment control methods.













b. Content

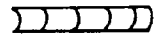



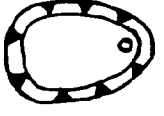

The plan shall consist of three parts:

(1) A narrative, containing:

- a brief description of the proposed land-disturbing activities, existing site conditions and adjacent areas (such as creeks and buildings) that might be affected by the land disturbance;
- a description of critical areas on the site--areas that have potential for serious erosion problems;

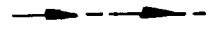
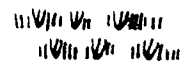
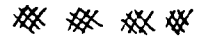
TABLE 1. STANDARD SYMBOLS FOR EROSION AND SEDIMENT CONTROL MEASURES

| | |
|---|--|
|  | STABILIZED CONSTRUCTION ENTRANCE |
|  | STRAW BALE DIKE |
|  | SILT FENCE |
|  | DIKE |
|  | UNLINED SWALE |
|  | PAVED SWALE |
|  | ROCK-LINED SWALE |
|  | UNLINED WATERWAY |
|  | GRASSED WATERWAY |
|  | PAVED WATERWAY |
|  | ROCK-LINED WATERWAY |
|  | SEDIMENT TRAP |
|  | SEDIMENT BASIN |
|  | PIPE SLOPE DRAIN |
|  | PAVED FLUME |

| | |
|--|-----------------------------------|
|  | STORM DRAIN OUTLET PROTECTION |
|  | RIPRAP |
|  | CHECK DAM |
|  | SUBSURFACE DRAIN |
|  | SEEDING |
|  | STRAW MULCHING |
|  | HYDRAULIC SEEDING AND MULCHING |
|  | PUNCHED STRAW |
|  | LIMITS OF CLEARING AND GRADING |

- the date grading will begin and the expected date of stabilization;
- a brief description of the measures that will be used to control erosion and sediment on the site, including both temporary and permanent measures;

(Note: Measures must meet or exceed all requirements in the erosion and sediment control ordinance and applicable standards and specifications. If grading is scheduled to be completed before the rainy season begins, the plan should specify contingency actions to winterize the site if construction should fall behind schedule.)

- a maintenance program, with provisions for frequency of inspection, reseeding of vegetated areas, repair or reconstruction of damaged structures, cleanout method and frequency, disposal of waste materials and disposition of control measures after they have served their purpose (see Sample Erosion and Sediment Control Plan).

This narrative is intended to summarize for the plan reviewer the project aspects important for erosion control. It is not intended to duplicate the requirements of project applications and Environmental Impact Reports. Applicable portions of those documents should be referenced in the narrative.

(2) A map showing:

- existing site contours at an interval and scale sufficient for distinguishing runoff patterns before and after disturbance;
- limits of clearing and grading;
- final contours;
- location of the project relative to highways, municipalities, major streams or other identifiable landmarks (vicinity map);
- existing vegetation (grassy areas, major groups of trees and unique species);
- surface extent of each soil type and relative erodibility;
- critical areas within or near the project area, such as streams, lakes and wetlands;

- location and types of both temporary and permanent control measures;
- dimensional details of facilities (see Sample Map).

(3) Plan details, including:

- detailed drawings of erosion and sediment control structures, showing key dimensions and other important details;
- design assumptions and calculations (for structural measures such as sediment basins, channels and outlet protection);
- seeding specifications;
- maintenance notes.

All of these details may be placed upon the erosion and sediment control plan map, space permitting.

2. SAMPLE EROSION AND SEDIMENT CONTROL PLAN

SAMPLE NARRATIVE

Description

The project site is 3.8 acres located on a natural knoll (see Sample Map). A total of 38 condominium units in 11 separate buildings will be built on either side of a street running through the center of the property, along the long axis. The site is gently sloping except on the southern, western and eastern edges where it is considerably steeper. There are no distinct natural swales or creeks on the property.

Soils and Vegetation

Surface soils are silty clays and are nearly uniform throughout the site. They have low erosion potential, except for the southern slope (see Critical Areas). Ground cover is mostly bunch grasses, except for a few clusters of oak trees.

Critical Areas

The slope on the south border of the property is unstable. Farfel Creek is located at the base of this slope. The creek drains into Lake Farfel, a regional recreation area, about 1 mile southwest of the site. Existing residences are located adjacent to the site at its northwest and southwest corners.

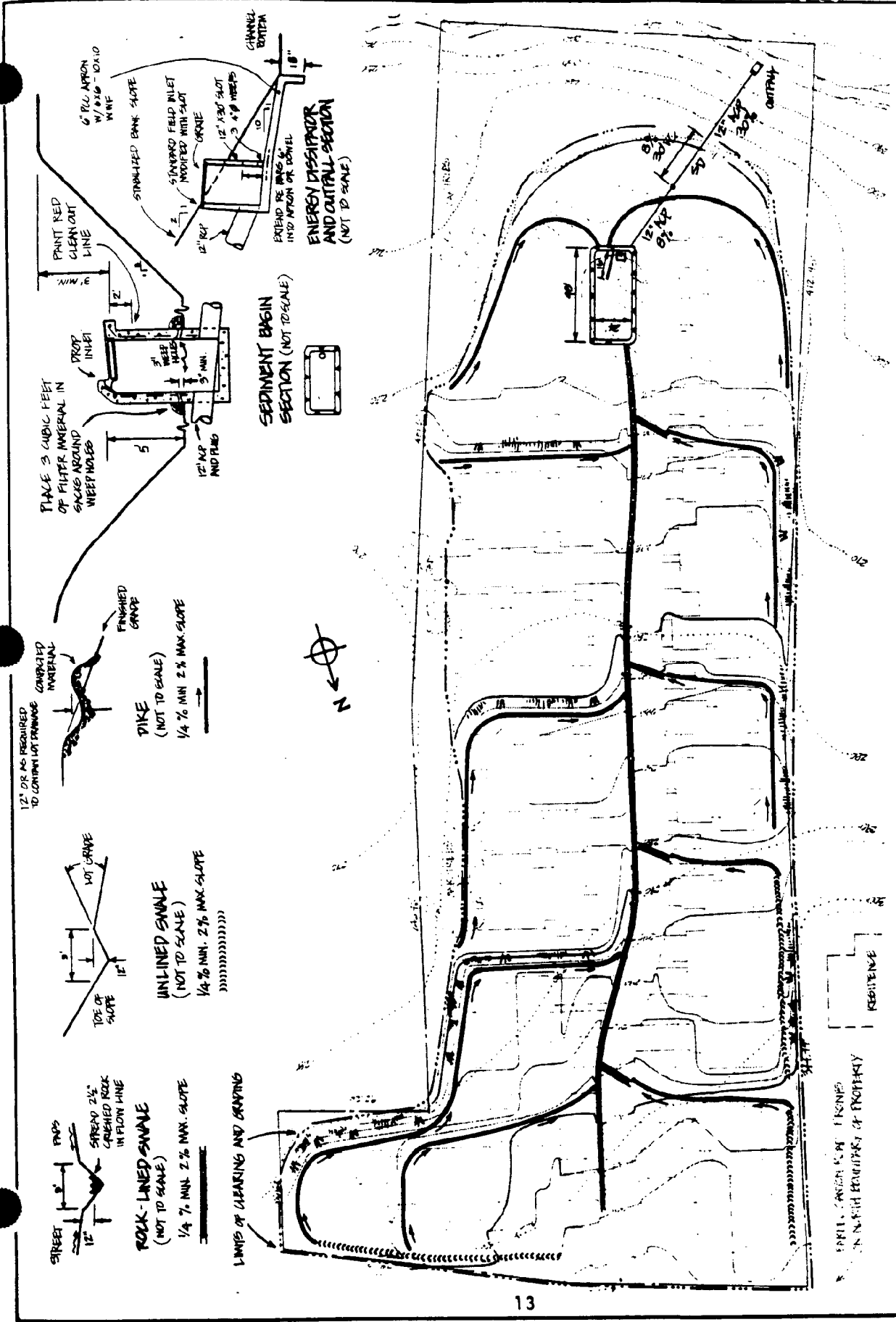

| | | | |
|--|---|-----------------------|--|
| <p>ASSOCIATION OF BAY AREA GOVERNMENTS OABAG Hotel Claremont • Berkeley, CA 94705 • (415) 841-9730</p> | <p>DATE <u>MARCH 1981</u> AND FOOT SCALE</p> | <p>APPROVED _____</p> | <p>SAMPLE MAP Erosion and Sediment Control Plan and Site Map Farfel Canyon Ranch</p> |
|--|---|-----------------------|--|

Schedule of Land-Disturbing Activities

In May 1981 the site will be stripped except for the trees and brought to rough finished grade. The topsoil will be stockpiled at the northeast corner of the property for later landscaping use. Dikes, swales and a sediment basin will be constructed in August 1981.

Erosion and Sediment Control Program

The site will be subdivided into small subcatchments by constructing dikes and swales around each group of pads. These dikes and swales will prevent runoff from crossing the steep slopes to the south, east and west of the site. Runoff from each subcatchment will be routed to a crushed rock-lined swale running down the center of the property, which will drain to a sediment basin at the south end of the developed area. The basin will be located where the cul-de-sac will eventually be. The slopes around the pads will be seeded with 'Blando' brome and annual ryegrass and mulched with punched straw by October 1, 1981. All measures will be designed and installed according to the county's recommended standards and specifications.

Maintenance Program

After October 1, all measures will be inspected daily and after each storm. After October 1, breaches in dikes and swales will be repaired at the close of each day and whenever rain is forecast. A red line will be painted on the drop inlet of the sediment basin 2 feet below the grate. The sediment basin will be cleaned out when the sediment level reaches this line. The spoil material removed from the basin will be deposited so that it will not directly re-enter the basin or cause sedimentation damage on- or off-site. Seeded areas will be repaired, reseeded and mulched as soon as possible after damaged.

SAMPLE PLAN DETAILS

(These details supplement the details shown on the Sample Map. If they will fit, all details can be shown on the erosion and sediment control plan map.)

Detailed Drawings

Drawings of a lined swale, an unlined swale, a dike, an energy dissipator, and a sediment basin are shown on the Sample Map.

Design Calculations

The design calculations have been omitted from this example.

Seeding Specifications

1. Seed and mulch will be applied by October 1 to all disturbed slopes steeper than 2% and higher than 3 feet, and to all cut and fill slopes within or adjacent to public rights-of-way as directed by the county.
2. Seed and fertilizer will be applied hydraulically or by hand at the rates specified below. On slopes, straw will be applied by blower or by hand and anchored in place by punching.

| <u>Item</u> | <u>Pounds per Acre</u> |
|--|------------------------|
| 'Blando' brome | 30 |
| Annual ryegrass | 20 |
| Fertilizer (16-20-0 and 15% sulfur) | 500 |
| Straw mulch | 4,000 |

(This seed mix is presented for sample purposes only.)

Maintenance Notes

1. During the rainy season (October 1 to April 15), all erosion and sediment control measures will be inspected and repaired at the end of each working day and, in addition, after each storm.
2. The sediment basin will be cleaned out to its original dimensions when sediment accumulates up to the red line on the inlet. The spoil material will be deposited so that it does not directly re-enter the basin or cause sedimentation damage on- or off-site. The spoil heap will be seeded when formed and whenever more deposits are added to it.
3. Seeded areas will be repaired, reseeded and mulched as soon as possible after damaged.

General Notes

1. A standard drop inlet, energy dissipator and outfall structure will be constructed by August 1981 and will remain as permanent tract improvements.
2. A construction entrance will be installed prior to commencement of grading. Location of the entrance may be adjusted by the contractor to facilitate grading operations. All construction traffic entering the paved road must cross the construction entrance.

3. The erosion and sediment control measures will be operable during the rainy season, October 1 to April 15. By October 1, grading and installation of storm drainage and erosion and sediment control facilities will be completed. No grading will occur between October 1 and April 15 unless authorized by the Director of Public Works.
4. Changes to this erosion and sediment control plan to meet field conditions will be made only with the approval of or at the direction of the Director of Public Works.
5. During the rainy season, all paved areas will be kept clear of earth material and debris. The site will be maintained so that a minimum of sediment-laden runoff enters the storm drainage system. This plan covers only the first winter following grading. Plans shall be resubmitted for approval prior to September 1 of each subsequent year until the tract improvements are accepted by the county.

Sources and References

1. Amimoto, Perry Y., Erosion and Sediment Control Handbook, California Department of Conservation, May 1978.
2. Fairfax County, Virginia, Public Facilities Manual, Volume 3, 1978.
3. Virginia Soil and Water Conservation Commission, Virginia Erosion and Sediment Control Handbook, 1980.

IV. CALCULATING SURFACE RUNOFF AND SOIL LOSS

An erosion and sediment control ordinance should require predictions of surface runoff and sediment yield as part of erosion and sediment control plans (see Appendix A, Sections 202.03(a) and (b) and 202.04(a) and (b); Appendix B, Sections 17(a) and 18(a)). The results of these calculations should be used by developers in determining the type, size and design of control structures and by local public works departments in evaluating the appropriateness of the measures to be used (see Appendix A, Sections 301.03(b)(3) and 301.04(b)(3)).

The techniques described are standard techniques in current use. Developers may choose to use other computational techniques which have been demonstrated to accurately model surface runoff and sediment yield.

1. CALCULATING SURFACE RUNOFF

Any proven method of calculating runoff may be used in the design of erosion control facilities. The Rational Method is simple and widely used in the Bay Area. Several other methods are mentioned later, following the discussion of the Rational Method.

a. The Rational Method

The Rational Method is a simple and commonly used method of predicting runoff. Presented for use in the San Francisco Bay Area by S.E. Rantz (9), this method computes the peak discharge from a watershed up to 200 acres in area. The equation used to compute runoff is:

$$Q = CiA,$$

where Q is the runoff rate, in cubic feet per second (cfs);

C is the runoff coefficient, a factor chosen to reflect watershed characteristics such as topography, soil type, vegetation and land use;

i is the average precipitation intensity, in inches per hour;

A is the watershed area, in acres.

At the beginning of a storm, runoff from distant parts of a watershed will not have reached the discharge point where the watershed's runoff (Q) is monitored. After a period determined to be specific to each watershed, a steady-state flow will occur. This is the Q predicted by the Rational Method. The initial period is known as the "time of concentration." The "time of concentration" is the longest time required for water to flow from the most remote part of a watershed to the mouth of the watershed.

The "C" value, the runoff coefficient used in the Rational Method, is chosen to reflect site conditions. Table 2 presents ranges of "C" values for various land uses.

The "i" value, precipitation intensity, is derived from three factors:

- mean annual precipitation;
- storm recurrence interval;
- rainfall duration.

Table 3 shows "i" values for the Bay Area as a function of these three factors.

The mean annual precipitation may be determined from Rantz's map of regionwide precipitation (Figure 2), the Department of Water Resources' Rainfall Analysis for Drainage Design (2) or another reliable reference.

A storm recurrence interval should be chosen that provides a sufficient margin of safety from failure of temporary control measures without undue expense for larger-than-necessary structures. Because erosion and sediment control facilities generally do not have emergency back-up systems to carry flows in case of failure, a recurrence interval of at least 10 years is recommended for designing these measures. This design criterion should provide adequate protection for storm drain systems and natural waterways.

The discharge predicted by the Rational Method can be used to size erosion and sediment control measures. For water conveyance structures, the peak Q for a rainfall intensity with a duration corresponding to the time of concentration would be used to establish needed capacity. The procedure for this calculation is described in Rantz (9). For detention structures, such as sediment basins or sediment traps, the Q corresponding to an intensity averaged over a longer duration storm may be more appropriate.

b. Other Methods

Rantz (9) describes the use of synthetic unit hydrographs for ungauged watersheds. The synthetic hydrographs are derived from unit hydrographs of gauged watersheds in a similar region. The unit hydrograph is more useful for a complete watershed than for a small subwatershed such as a typical construction site.

Hydrologic basin models may be used to simulate runoff. The USGS Watershed Model (4) and the Stanford Watershed Model (3) use precipitation and pan evaporation as inputs. An engineering firm may have a sophisticated watershed-specific model available for some locations. However, it is not practical to develop a model simply to compute a peak discharge when the Rational Method provides an adequate estimate.

TABLE 2. RATIONAL METHOD "C" VALUES (13)

| Land use | C | Land use | C |
|----------------------------|-----------|---------------------------|-----------|
| Business: | | Lawns: | |
| Downtown areas | 0.70-0.95 | Sandy soil, flat, 2% | 0.05-0.10 |
| Neighborhood areas | 0.50-0.70 | Sandy soil, average, 2-7% | 0.10-0.15 |
| Residential: | | Sandy soil, steep, 7% | 0.15-0.20 |
| Single-family areas | 0.30-0.50 | Heavy soil, flat, 2% | 0.13-0.17 |
| Multi units, detached | 0.40-0.60 | Heavy soil, average, 2-7% | 0.18-0.22 |
| Multi units, attached | 0.60-0.75 | Heavy soil, steep, 7 % | 0.25-0.35 |
| Suburban | 0.25-0.40 | Agricultural land: | |
| Industrial: | | Bare packed soil | |
| Light areas | 0.50-0.80 | Smooth | 0.30-0.60 |
| Heavy areas | 0.60-0.90 | Rough | 0.20-0.50 |
| Parks, cemeteries | | Cultivated rows | |
| | 0.10-0.25 | Heavy soil no crop | 0.30-0.60 |
| Playgrounds | | Heavy soil with crop | 0.20-0.50 |
| | 0.20-0.35 | Sandy soil no crop | 0.20-0.40 |
| Railroad yard areas | | Sandy soil with crop | 0.10-0.25 |
| | 0.20-0.40 | Pasture | |
| Unimproved areas | | Heavy soil | 0.15-0.45 |
| | 0.10-0.30 | Sandy soil | 0.05-0.25 |
| Streets: | | Woodlands | 0.05-0.25 |
| Asphaltic | 0.70-0.95 | | |
| Concrete | 0.80-0.95 | | |
| Brick | 0.70-0.85 | | |
| Drives and walks | | | |
| | 0.75-0.85 | | |
| Roofs | | | |
| | 0.75-0.95 | | |

Note: The designer must use judgement to select the appropriate C value within the range. Generally, larger areas with permeable soils, flat slopes and dense vegetation should have lowest (C) values. Smaller areas with dense soils, moderate to steep slopes, and sparse vegetation should be assigned highest (C) values.

TABLE 3. PRECIPITATION INTENSITY ("I") VALUES
SAN FRANCISCO BAY AREA (10)

| Duration | P _{MA} Recur- rence interval (years) | Storm precipitation, in inches, corresponding to indicated values of mean annual precipitation (P _{MA}), in inches | | | | | | | | | | | |
|------------|---|---|------|------|------|------|------|------|------|------|------|-------|------|
| | | 10 | 12 | 14 | 16 | 18 | 20 | 30 | 40 | 50 | 60 | 70 | 80 |
| 5 minutes | 2 | 0.08 | 0.10 | 0.11 | 0.12 | 0.13 | 0.14 | 0.16 | 0.19 | 0.21 | 0.23 | 0.26 | 0.28 |
| | 5 | .12 | .14 | .15 | .16 | .17 | .18 | .21 | .24 | .27 | .30 | .33 | .36 |
| | 10 | .15 | .17 | .18 | .19 | .20 | .21 | .24 | .28 | .31 | .35 | .38 | .41 |
| | 25 | .17 | .19 | .21 | .23 | .24 | .25 | .29 | .32 | .36 | .40 | .44 | .48 |
| | 50 | .19 | .21 | .23 | .24 | .26 | .27 | .31 | .35 | .39 | .43 | .47 | .51 |
| 100 | .21 | .23 | .25 | .26 | .28 | .29 | .33 | .38 | .42 | .46 | .51 | .55 | |
| 10 minutes | 2 | .13 | .15 | .17 | .18 | .20 | .22 | .25 | .29 | .32 | .36 | .40 | .43 |
| | 5 | .19 | .21 | .23 | .25 | .26 | .27 | .32 | .37 | .41 | .46 | .51 | .56 |
| | 10 | .23 | .26 | .28 | .30 | .32 | .33 | .38 | .43 | .49 | .54 | .58 | .64 |
| | 25 | .27 | .30 | .33 | .35 | .37 | .39 | .45 | .50 | .56 | .62 | .68 | .74 |
| | 50 | .30 | .33 | .36 | .38 | .40 | .42 | .48 | .54 | .61 | .67 | .73 | .80 |
| 100 | .32 | .36 | .38 | .41 | .43 | .45 | .52 | .58 | .65 | .72 | .79 | .86 | |
| 15 minutes | 2 | .16 | .19 | .21 | .23 | .26 | .27 | .32 | .36 | .41 | .46 | .50 | .55 |
| | 5 | .25 | .27 | .29 | .31 | .33 | .35 | .41 | .47 | .52 | .59 | .65 | .71 |
| | 10 | .30 | .32 | .35 | .38 | .40 | .42 | .48 | .55 | .62 | .68 | .74 | .81 |
| | 25 | .34 | .38 | .42 | .44 | .47 | .49 | .56 | .64 | .71 | .79 | .86 | .93 |
| | 50 | .38 | .42 | .45 | .48 | .51 | .53 | .61 | .69 | .77 | .85 | .93 | 1.01 |
| 100 | .41 | .45 | .48 | .52 | .55 | .57 | .66 | .74 | .83 | .91 | 1.00 | 1.08 | |
| 30 minutes | 2 | .22 | .26 | .29 | .32 | .36 | .38 | .44 | .51 | .57 | .63 | .70 | .76 |
| | 5 | .34 | .37 | .40 | .43 | .46 | .48 | .57 | .65 | .73 | .81 | .90 | .98 |
| | 10 | .41 | .45 | .49 | .52 | .55 | .58 | .66 | .76 | .85 | .94 | 1.03 | 1.12 |
| | 25 | .47 | .53 | .58 | .62 | .65 | .68 | .78 | .88 | .99 | 1.09 | 1.19 | 1.30 |
| | 50 | .52 | .58 | .62 | .66 | .70 | .73 | .85 | .96 | 1.07 | 1.18 | 1.29 | 1.40 |
| 100 | .57 | .62 | .67 | .72 | .76 | .79 | .91 | 1.03 | 1.15 | 1.26 | 1.38 | 1.50 | |
| 1 hour | 2 | .28 | .33 | .37 | .41 | .45 | .48 | .56 | .64 | .72 | .80 | .88 | .96 |
| | 5 | .43 | .47 | .51 | .55 | .58 | .61 | .72 | .82 | .92 | 1.03 | 1.14 | 1.24 |
| | 10 | .52 | .57 | .62 | .66 | .70 | .73 | .84 | .96 | 1.08 | 1.19 | 1.30 | 1.42 |
| | 25 | .60 | .67 | .73 | .78 | .82 | .86 | .99 | 1.12 | 1.25 | 1.38 | 1.51 | 1.64 |
| | 50 | .66 | .73 | .79 | .84 | .89 | .93 | 1.07 | 1.21 | 1.35 | 1.49 | 1.63 | 1.77 |
| 100 | .72 | .79 | .85 | .91 | .96 | 1.00 | 1.15 | 1.30 | 1.45 | 1.60 | 1.75 | 1.90 | |
| 2 hours | 2 | .45 | .51 | .56 | .61 | .66 | .70 | .85 | 1.00 | 1.15 | 1.30 | 1.45 | 1.60 |
| | 5 | .67 | .72 | .76 | .80 | .84 | .88 | 1.07 | 1.26 | 1.45 | 1.64 | 1.83 | 2.02 |
| | 10 | .74 | .79 | .84 | .89 | .93 | .97 | 1.18 | 1.39 | 1.60 | 1.81 | 2.02 | 2.23 |
| | 25 | .90 | .94 | .99 | 1.03 | 1.08 | 1.12 | 1.34 | 1.56 | 1.78 | 2.00 | 2.22 | 2.44 |
| | 50 | .98 | 1.03 | 1.07 | 1.12 | 1.16 | 1.21 | 1.44 | 1.67 | 1.90 | 2.13 | 2.36 | 2.59 |
| 100 | 1.05 | 1.10 | 1.15 | 1.20 | 1.25 | 1.30 | 1.55 | 1.80 | 2.05 | 2.30 | 2.55 | 2.80 | |
| 3 hours | 2 | .63 | .68 | .72 | .77 | .81 | .86 | 1.09 | 1.32 | 1.55 | 1.78 | 2.01 | 2.24 |
| | 5 | .78 | .84 | .89 | .95 | 1.00 | 1.06 | 1.34 | 1.62 | 1.90 | 2.18 | 2.46 | 2.74 |
| | 10 | .91 | .97 | 1.03 | 1.10 | 1.16 | 1.22 | 1.53 | 1.84 | 2.15 | 2.46 | 2.77 | 3.08 |
| | 25 | 1.03 | 1.10 | 1.16 | 1.23 | 1.29 | 1.36 | 1.69 | 2.02 | 2.35 | 2.68 | 3.01 | 3.34 |
| | 50 | 1.14 | 1.21 | 1.28 | 1.34 | 1.41 | 1.48 | 1.82 | 2.16 | 2.50 | 2.84 | 3.18 | 3.52 |
| 100 | 1.25 | 1.32 | 1.39 | 1.46 | 1.53 | 1.60 | 1.95 | 2.30 | 2.65 | 3.00 | 3.35 | 3.70 | |
| 6 hours | 2 | .91 | .99 | 1.07 | 1.16 | 1.24 | 1.32 | 1.73 | 2.14 | 2.55 | 2.96 | 3.37 | 3.78 |
| | 5 | 1.14 | 1.25 | 1.36 | 1.46 | 1.57 | 1.68 | 2.22 | 2.76 | 3.30 | 3.84 | 4.38 | 4.92 |
| | 10 | 1.30 | 1.42 | 1.54 | 1.66 | 1.78 | 1.90 | 2.50 | 3.10 | 3.70 | 4.30 | 4.90 | 5.50 |
| | 25 | 1.46 | 1.59 | 1.72 | 1.86 | 1.99 | 2.12 | 2.78 | 3.44 | 4.10 | 4.76 | 5.42 | 6.08 |
| | 50 | 1.60 | 1.74 | 1.88 | 2.02 | 2.16 | 2.30 | 3.00 | 3.70 | 4.40 | 5.10 | 5.80 | 6.50 |
| 100 | 1.73 | 1.88 | 2.02 | 2.17 | 2.31 | 2.46 | 3.19 | 3.92 | 4.65 | 5.38 | 6.11 | 6.84 | |
| 12 hours | 2 | 1.04 | 1.18 | 1.33 | 1.47 | 1.62 | 1.76 | 2.48 | 3.20 | 3.92 | 4.64 | 5.36 | 6.08 |
| | 5 | 1.44 | 1.61 | 1.78 | 1.94 | 2.11 | 2.28 | 3.12 | 3.96 | 4.80 | 5.64 | 6.48 | 7.32 |
| | 10 | 1.70 | 1.88 | 2.06 | 2.24 | 2.42 | 2.60 | 3.50 | 4.40 | 5.30 | 6.20 | 7.10 | 8.00 |
| | 25 | 1.90 | 2.10 | 2.30 | 2.50 | 2.70 | 2.90 | 3.90 | 4.90 | 5.90 | 6.90 | 7.90 | 8.90 |
| | 50 | 2.15 | 2.36 | 2.57 | 2.78 | 2.99 | 3.20 | 4.25 | 5.30 | 6.35 | 7.40 | 8.45 | 9.50 |
| 100 | 2.35 | 2.57 | 2.79 | 3.01 | 3.23 | 3.45 | 4.55 | 5.65 | 6.75 | 7.85 | 8.95 | 10.05 | |

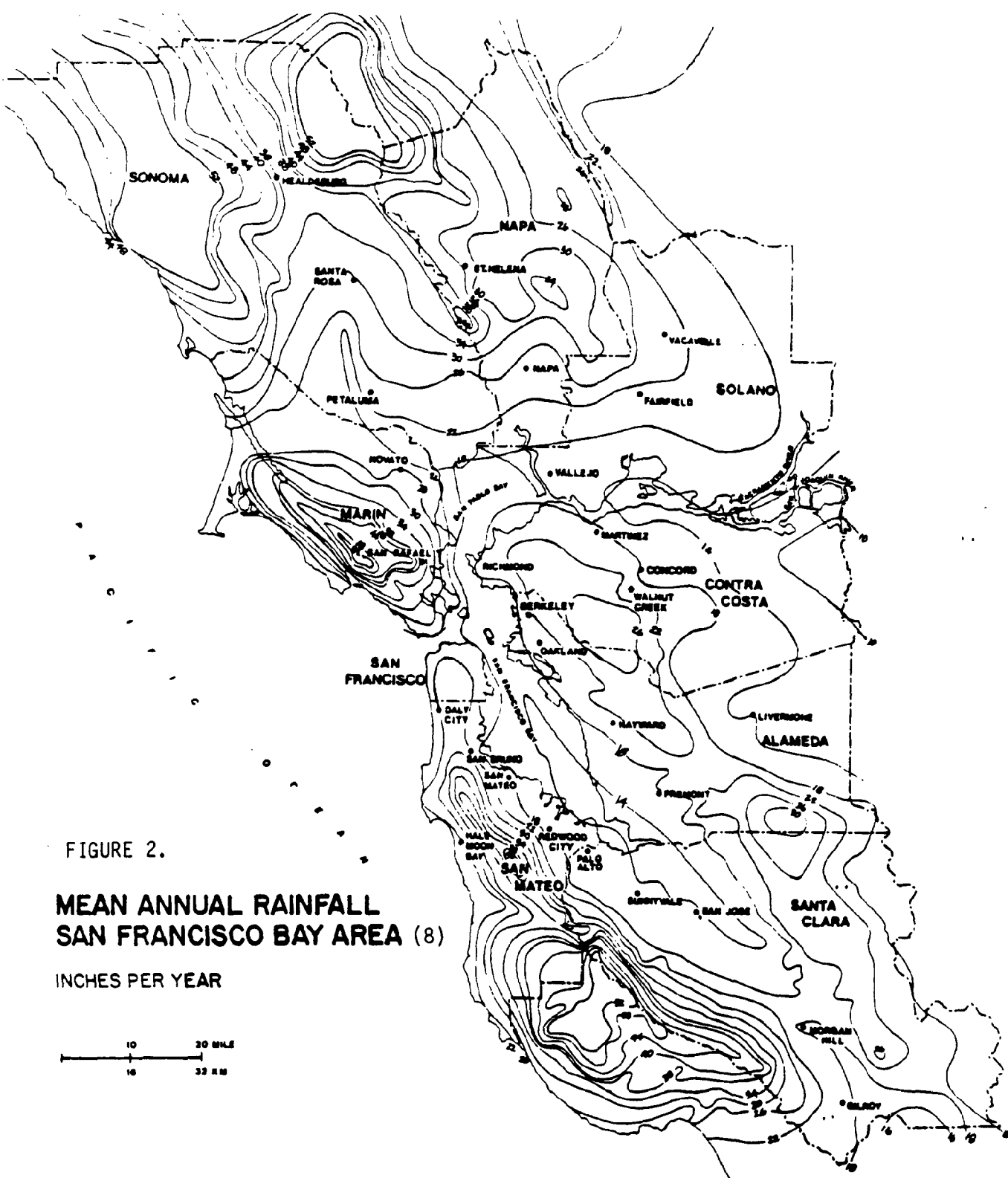
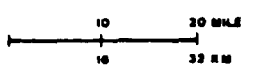

FIGURE 2.
MEAN ANNUAL RAINFALL
SAN FRANCISCO BAY AREA (8)
 INCHES PER YEAR



The USDA, Soil Conservation Service (SCS) takes the unit hydrograph method one step further in its Method for Estimating Volume and Rate of Runoff in Small Watersheds (12). The SCS method involves determining:

- a runoff curve number based on a given set of watershed land use characteristics;
- the rainfall time distribution;
- the drainage area.

Runoff from areas of 2,000 acres or less with slopes less than 30% can be obtained directly from graphs published by the SCS. Still, the Rational Method is better adapted to urbanizing areas and, more importantly, allows use of more detailed storm data than the SCS method.

2. ESTIMATING SOIL LOSS

Several methods have been developed for estimating soil loss. Generally, each method has been designed for a specific use. Most often, sediment yield prediction methods were derived from studies of large, undisturbed grasslands or forested areas. The Universal Soil Loss Equation has the most applications for construction sites. The Universal Soil Loss Equation is discussed below, followed by a brief section on several other methods.

a. Universal Soil Loss Equation

The Universal Soil Loss Equation (USLE) was developed to predict soil losses from agricultural lands (15). Recent adaptation of several of the equation's factors to construction site conditions allows use of the USLE to estimate erosion from building sites and to evaluate the effects of erosion control practices (7,14).

The general form of the equation is:

$$A = RKLSCP,$$

where

- A is the sediment yield, in tons per acre;
- R is the rainfall factor;
- K is the soil erodibility factor;
- LS is the slope length and steepness factor;
- C is the vegetative cover factor;
- P is the erosion control practice factor.

To apply the equation, each of the parameters is assigned a numerical value using tables and charts developed by Wischmeier and Smith (14). The five factors are multiplied together to produce an estimate of soil lost from the site in tons per acre averaged over a 1 year period. The references cited above should be consulted for details on applying the equation.

The USLE reasonably approximates soil loss from a construction site unless severe erosion occurs from poor erosion control practices. The equation does not account for soil loss due to gully erosion. Based on 12 sites in the San Francisco Bay Area observed during the 1980-81 winter season, the soil loss from areas that were not severely eroded were within 30% of the predicted value.

The sediment yield prediction obtained by careful use of the Universal Soil Loss Equation can be used to estimate the required storage volume of a sediment basin. The equation can also be used to compare the effects of different combinations of erosion control and grading practices to find the most desirable combination of control measures.

b. Other Methods

The Pacific Southwest Interagency Committee (8) produced a table with 12 variables used to provide a qualitative estimate of sediment loss from large forested watersheds. Flaxman (6) and Dendy and Bolton (5) derived equations from reservoir sediment deposition data gathered in rural areas. None of these methods allows assessment of the individual effects of vegetative cover, soil characteristics, and erosion and sediment control measures.

Another group of methods has been designed to estimate sediment yield from roadways. These methods vary from very simple techniques, such as graphs of road density versus sediment loss with an assumption of the depth of soil eroded (1), to very complex computer models (11). None of these methods provides both ease of application and sufficient accuracy to be useful.

Sources and References

1. Amimoto, Perry Y., Erosion and Sediment Control Handbook, California Department of Conservation, May 1978.
2. California Department of Water Resources, Rainfall Analysis for Drainage Design, Volumes 1 and 2, Bulletin No. 195, October 1976.
3. Crawford, N.H., and R.K. Linsley, Digital Simulation in Hydrology, Stanford Watershed Model IV, Stanford University Department of Civil Engineering Technical Report No. 39, 1966.
4. Dawdy, D.R., R.W. Lichty and J.M. Bergmann, A Rainfall-Runoff Simulation Model for Estimation of Flood Peaks for Small Drainage Basins - A Progress Report, U.S. Geological Survey Open-File Report, 1970.
5. Dendy, F.E. and G.C. Bolton, "Sediment Yield-Runoff Drainage Area Relationships in the United States," Journal of Soil and Water Conservation, 31(6): 264-266, 1976.

6. Flaxman, E.M., "Predicting Sediment Yield in the Western United States," Journal, Hydraulics Division, ASCE, 98 (HY 12): 2073-2085. 1972.
7. National Research Council, Transportation Research Board, Erosion Control during Highway Construction - Manual on Principles and Practices, National Cooperative Highway Research Program Report No. 221, 1980.
8. Pacific Southwest Interagency Committee, Factors Affecting Sediment Yield and Measures for the Reduction of Erosion and Sediment Yield, U.S. Forest Service, Berkeley, California, October 1978.
9. Rantz, S.E., Suggested Criteria for Hydrologic Design of Storm Drainage Facilities in the San Francisco Bay Region, California, U.S. Geological Survey, 1971.
10. Rantz, S.E., Precipitation Depth-Duration-Frequency Relations for the San Francisco Bay Region, California, U.S. Geological Survey, Basic Data Contribution No. 25, 1971.
11. Simons, D.B., R.M. Li and T.J. Ward, "Estimation of Sediment Yield for a Proposed Roadway Design," Proceedings, International Symposium on Urban Stormwater Management, Lexington, Kentucky, 1978.
12. U.S. Department of Agriculture, Soil Conservation Service, A Method for Estimating Volume and Rate of Runoff in Small Watersheds, SCS Technical Paper No. 149, 1973.
13. Virginia Soil and Water Conservation Commission, Virginia Erosion and Sediment Control Handbook, 1980.
14. Wischmeier, W.H. and D.D. Smith, Predicting Rainfall Erosion Losses--A Guide to Conservation Planning, Agriculture Handbook No. 537. U.S. Department of Agriculture, 1978.
15. Wischmeier, W.H. and D.D. Smith, Predicting Rainfall Erosion Losses from Cropland East of the Rocky Mountains, Agriculture Handbook No. 282, U.S. Department of Agriculture, 1965.

V. STANDARDS AND SAMPLE SPECIFICATIONS FOR EROSION AND SEDIMENT CONTROL MEASURES

This chapter contains standards and sample specifications for measures to control erosion and sediment on construction sites. They are intended to guide Bay Area cities and counties in developing their own standards and specifications, which should be adopted as a manual and referenced in the local erosion and sediment control ordinance.

Such a manual would have two uses. First, it would provide developers, design professionals and contractors with technical information needed to design and construct erosion and sediment control measures. Second, it would serve as a benchmark for staff of local planning and public works departments in assessing the adequacy of control measures proposed in the erosion and sediment control plans. When control measures different than those in the manual are described in an erosion and sediment control plan for a project, the developer should be asked to justify his or her measures or to make them consistent with the manual.

Table 4 summarizes the erosion and sediment control measures and identifies common situations in which each of these measures is appropriate. The presence of a dot in a column opposite a control measure does not mean that the control measure can always be used to mitigate the problem shown. Conversely, the absence of a dot does not imply that the control measure can never be used for that problem. The table merely highlights typical applications.





As used in this chapter, a temporary control measure is installed during construction but is not intended to be part of the finished development. A permanent control measure is installed during construction and is, in addition, planned to be part of the finished development.

When noted, the following standards and sample specifications were adapted from California and nationwide USDA, Soil Conservation Service standards and specifications, from Standards and Specifications for Erosion and Sediment Control in Developing Areas (USDA, Soil Conservation Service, College Park, Maryland, 1975) and from Virginia Erosion and Sediment Control Handbook (Virginia Soil and Water Conservation Commission, Richmond, Virginia, 1980). Otherwise, the standards and sample specifications were prepared by ABAG based upon monitoring of construction sites in the Bay Area. Because of the variability of local and site-specific conditions (such as rainfall and soil conditions), all standards and sample specifications should be reviewed by a qualified professional before they are adopted by a local jurisdiction.

Several of the standards and sample specifications contained in the 1980 edition of this manual have been modified for this edition. Changes in terminology have been made for simplification. Other changes have been made based on analysis of control measure performance in the Bay Area. The following are the major changes:



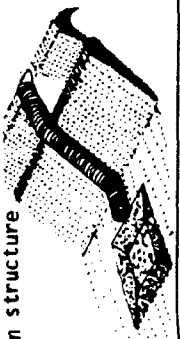

- Temporary Diversion Dike and Perimeter Dike has been replaced by Temporary Dike;
- Permanent Diversion has been replaced by Permanent Waterway;
- Temporary Perimeter Swale and Temporary Interceptor Swale have been replaced by Temporary Swale;
- the rule-of-thumb sizing criteria for Temporary Sediment Basin and Temporary Sediment Trap have been replaced by a design method based on the surface area of the basin or trap;
- Temporary Check Dam has been added;
- Permanent Grassed Waterway has been replaced by Temporary and Permanent Grass Protection of Waterways, Swales and Dikes;
- Permanent Lined Waterway or Outlet has been deleted.

TABLE 4. SUMMARY OF CONTROL MEASURE APPLICATIONS

| CONTROL MEASURE | PURPOSE | CONDITION NEEDING CONTROL | | | | | |
|--|---|---------------------------|-------------|-------------------------------------|--------------------|---------------|---------------------------------|
| | | CUT SLOPES | FILL SLOPES | DENUDED GENTLY SLOPING OR FLAT AREA | ERODING STREAMBANK | ERODING SWALE | PROTECTION OF ADJACENT PROPERTY |
| Temporary and permanent planting of exposed soils  | To stabilize soils by absorbing the impact of raindrops, reducing velocity of runoff, and allowing precipitation to enter the soil. | ● | ● | ● | | | ● |
| Temporary and permanent grass protection of waterways, swales and dikes  | To protect drainageways by lowering water velocity over the soil surface and by binding soil particles with roots. | | | | ● | ● | ● |
| Temporary dike  | To intercept storm runoff from small upland areas and divert it to an outlet, or to prevent runoff from entering a disturbed area and sediment-laden runoff from leaving the disturbed area. | ○ | ● | ● | | | ● |
| Temporary swale  | To intercept storm runoff and divert it to a stable outlet or sediment-trapping device, or to prevent runoff from entering a disturbed area and to direct sediment-laden runoff leaving the disturbed area. | ○ | ● | ● | | | ● |
| Temporary grade stabilization structure  | To convey concentrated, high-velocity runoff down slopes without causing erosion. | ● | ● | | | | |

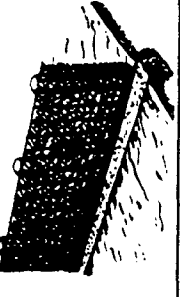

KEY: ● Preferred control measure ○ Alternative but less effective control measure.

TABLE 4. (Cont'd) SUMMARY OF CONTROL MEASURE APPLICATIONS

| CONTROL MEASURE | PURPOSE | CONDITION NEEDING CONTROL | | | | | |
|--|---|---------------------------|-------------|-------------------------------------|--------------------|---------------|---------------------------------|
| | | CUT SLOPES | FILL SLOPES | DENUDED GENTLY SLOPING OR FLAT AREA | ERODING STREAMBANK | ERODING SWALE | PROTECTION OF ADJACENT PROPERTY |
| Temporary sediment basin  | To collect and hold runoff to allow suspended sediment to settle out. | ● | ● | ● | | | ● |
| Temporary sediment trap  | To intercept small quantities of sediment-laden runoff and trap the sediment. | ○ | ○ | ● | | | ● |
| Temporary stabilized construction entrance  | To reduce the tracking or flowing of sediment onto public rights-of-way. | | | | | | ● |
| Temporary straw bale dike  | To intercept and detain small amounts of sediment from small unprotected areas. | | | ○ | | | ○ |
| Temporary silt fence  | To intercept and detain the sediment in runoff from small erodible areas while decreasing the velocity of the runoff. | | | ○ | | | ○ |

Preferred control measure
 Alternative but less effective control measure

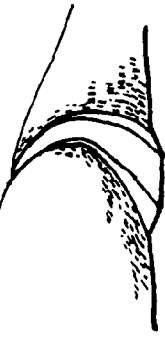
TABLE 4. (Cont'd) SUMMARY OF CONTROL MEASURE APPLICATIONS

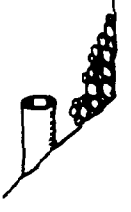
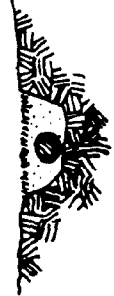
| CONTROL MEASURE | PURPOSE | CONDITION NEEDING CONTROL | | | | | |
|--|---|---------------------------|-------------|-------------------------------------|--------------------|---------------|---------------------------------|
| | | CUT SLOPES | FILL SLOPES | DENUDED GENTLY SLOPING OR FLAT AREA | ERODING STREAMBANK | ERODING SWALE | PROTECTION OF ADJACENT PROPERTY |
| Temporary check dam  | To reduce the velocity of concentrated stormwater flows in swales or ditches draining small areas. | | | | | ● | ● |
| Permanent waterway  | To intercept runoff and convey it to a stable outlet. | ○ | ○ | | ● | ● | |
| Permanent riprap  | To protect a soil surface, drainageway or outlet from the erosive forces of water. | ○ | | | ● | ● | |
| Permanent storm drain outlet protection  | To convert pipe flow to channel flow and reduce water velocity where storm drain outlets discharge into streams or other drainage channels. | | | | ● | ● | ○ |
| Permanent subsurface drain  | To remove runoff from and prevent water movement into a wet area, to regulate the water table and groundwater flow to improve plant growth and to dewater a sediment basin. | ○ | ○ | ○ | | | ○ |

KEY: ● Preferred control measure ○ Alternative but less effective control measure

TABLE 4. (Cont'd) SUMMARY OF CONTROL MEASURE APPLICATIONS

| CONTROL MEASURE | PURPOSE | CONDITION NEEDING CONTROL | | | | | |
|--|--|---------------------------|-------------|-------------------------------------|--------------------|---------------|---------------------------------|
| | | CUT SLOPES | FILL SLOPES | DENUDED GENTLY SLOPING OR FLAT AREA | ERODING STREAMBANK | ERODING SWALE | PROTECTION OF ADJACENT PROPERTY |
| General land grading practices for minimizing erosion  | To provide for erosion control and plant establishment on areas where topography is to be re-shaped by grading | ● | ● | ● | | | ● |

KEY: ● Preferred control measure ○ Alternative but less effective control measure

1. TEMPORARY AND PERMANENT PLANTING OF EXPOSED SOILS

STANDARDS

Definition

The planting of fast-growing vegetation, such as grasses, on erodible or eroding areas.

Purpose

Vegetation stabilizes the soil by absorbing the impact of raindrops, reducing velocity of runoff and allowing precipitation to enter the soil. It provides both short- and long-term protection from erosion and should be used in all areas where vegetation has been removed or disturbed due to construction activities. Examples of applicable areas are cuts, fills, spoil heaps, and denuded or gullied areas. Exceptions, requiring special treatment, are swales, permanent waterways and the upslope toes of dikes over which concentrated runoff flows (see Standard and Sample Specifications for Grass Protection of Waterways, Swales and Dikes). Vegetative stabilization is recommended for all sites because it substantially improves the effectiveness of other control measures.

Design Considerations

1. The following should be considered when selecting the plants for seeding exposed areas:
 - erosion control effectiveness--fast growth, complete ground coverage, fibrous root mat;
 - commercial availability;
 - drought tolerance;
 - fire hazard;
 - fertilizer requirements;
 - application and maintenance costs.
2. Several types of plants are available for erosion control. The best are annual grasses because they provide fast establishment, are inexpensive and are widely available. Legumes are an excellent supplement to grass mixes because they fix atmospheric nitrogen, making it available to other plants. Flowers and shrubs generally provide poor erosion control protection, but they are sometimes used on less erodible sites for color and variety. Table 5 rates plants for their erosion control effectiveness in the Bay Area when seeded at the typical rates shown in the table.
3. The plants listed in Table 6 should not be used for erosion control in the Bay Area. They compete with native vegetation and degrade wildlife habitat. They have the propensity to spread rapidly and

TABLE 5. EROSION CONTROL RATINGS OF PLANTS USED IN THE BAY AREA

| Plant Species | Height | Erosion Rating | | Fuel Volume | Typical Seeding Rates ^a (lbs/ac) | Comments |
|---------------------------------------|--------|----------------|-----------------|-------------|---|--|
| | | First Year | Following Years | | | |
| ANNUAL GRASSES | | | | | | |
| Brome, 'Blando' | 1-2½' | Exc. | Good | Med. | 40-60 | Establishes on compact soils better than barley. |
| Fescue, 'Zorro' annual | 10-12" | Exc. | Good | Low | 10-20 | Best adapted to shallow soils. |
| Ryegrass, Italian or annual | 1-3' | Exc. | Poor | Med. | 40-60 | Much fertilizer required. Turns gray-black and inhibits reseeding of other species. |
| Ryegrass, 'Wimmera 62' | 1-3' | Exc. | Poor | Med. | 40-60 | Pros and cons similar to annual ryegrass; matures earlier. |
| Barley | 2-3' | Exc. | Poor | Med. | 300 | Good for early erosion control, but requires high seeding rate. |
| Oats | 3-4' | Good | Poor | High | 300 | Requires high seeding rate, blends with range landscape. |
| PERENNIAL GRASSES | | | | | | |
| Fescue, creeping red | 1-1½' | Good | Good | Low | 15-30 | Irrigation required. |
| Fescue, tall | 3-6' | Good | Good | Low | 15-30 | Irrigation required; widely adaptable, grows very tall unless mowed. |
| Hardinggrass | 3-4' | Fair | Good | Low | 10-20 | Min. 20" rainfall; bunchy growth can block view. |
| Orchardgrass, 'Berber' or 'Palestine' | 2-4' | Good | Good | Low | 15-30 | Min. 20" rainfall; compatible with wildflowers. 'Berber' has better winter growth, better adapted than wheatgrass. |
| Perlagrass ('Perla' kniegrass) | 3-4' | Good | Good | Low | 10-20 | Min. 20" rainfall; bunchy growth can block view. |
| Ryegrass, penennial | 1-3' | Good | Poor | Low | 15-30 | Cannot tolerate drought; may be useful short-term cover. |
| Wheatgrass, 'Luna' pubescent | 24-40" | Fair | Good | Low | 10-40 | Best performing wheatgrass variety; plant on fill slopes only. |
| ANNUAL LEGUMES | | | | | | |
| Clover, bur | ½-1' | Fair | Good | Low | 5-20 | Basic soils only. |
| Clover, crimson | 1-2' | Fair | Poor | Low | 5-20 | Compatible with grasses; has colorful red flowers. |
| Clover, rose | 1-1½' | Fair | Good | Low | 5-20 | Compatible with grasses; has colorful pink flowers. |
| Subclover | ½-1' | Poor | Fair | Low | 3-10 | Poor grass competitor; requires grazing or mowing to maintain stand |
| Vetch, 'Lana' woolypod | 1-3' | Good | Fair | High | 10-75 | Vigorous growth but difficult to mow. |
| PERENNIAL LEGUMES | | | | | | |
| Clover, strawberry | 1-2' | Poor | Poor | Low | 5-20 | Irrigation required; better performance in moist climate. |
| Trefoil, broadleaf | 1-2' | Poor | Poor | Low | 5-20 | Irrigation preferred; does best in wet areas. |
| Trefoil, narrowleaf | 1-2' | Poor | Poor | Low | 5-20 | Similar to broadleaf; tolerates slightly drier conditions |
| FLOWERS | | | | | | |
| California poppy | 1-2' | Fair | Poor | Low | 2-10 | CA native with colorful orange flowers; does not persist well with grasses or where heavily fertilized. |
| Lupine, valley | 1-3' | Poor | Poor | Low | 5-15 | CA native with purple flowers. |
| Lupine, 'Gedling' Golden | 1-3' | Poor | Poor | Low | 1-5 | CA native with showy golden flowers. |
| Lupine, spider | 1-3' | Poor | Poor | Low | 1-5 | CA native with light to deep blue flowers. |
| Lupine, foothill | 1-3' | Poor | Poor | Low | 1-5 | CA native with purple flowers. |
| SHRUBS | | | | | | |
| Australian saltbush | 1' | Fair | Good | Low | 6-12 | Blue-green colored shrubs; good on fill slopes, competes poorly with grasses. |
| California buckwheat | 1-3' | Poor | Fair | Low | 5-10 | CA native with brown flowers; competes poorly with grasses. |

a. Varies due to number of seeds per pound and germination.

create weed problems on other properties. Use of these species should be restricted to controlled residential and commercial landscaping. Wild oats, an agricultural weed, cannot be legally planted in California.

Table 6. PLANTS NOT RECOMMENDED FOR THE BAY AREA

| | |
|--------------|--|
| Algerian ivy | <u>Hedera canariensis</u> |
| English ivy | <u>Hedera helix</u> |
| French broom | <u>Cytisus monspessulanus</u> |
| Pampas grass | <u>Cortaderia jubata</u> |
| Periwinkle | <u>Vinca major</u> and <u>V. minor</u> |
| Scotch broom | <u>Cytisus scoparius</u> |
| Wild oats | <u>Avena fatua</u> |

4. Seeds should be planted in time to:
 - o germinate with the normally occurring light, early-season rains (0.5 to 1.0-inch storms);
 - o establish a root mat capable of resisting the erosive force of a 2.0-inch storm approximately 30 days after germination);
 - o germinate and grow while temperatures are mild and daylight is relatively long (before November).
5. Optimum time for planting is before October 1. Planting by October 1 provides a 90% probability that seeds will be in the ground before the first rainfall great enough to cause germination, and a 90% probability that the first erosive rain will not occur for over 30 days.
6. The surface to be seeded should be roughened or broken up so that it can hold seed and permit germination. If a graded area is to be seeded later, it should not be smoothed by grading equipment, but left in a rough or serrated condition. Roughening the soil surface by "track-walking" provides an excellent seedbed and reduces the erosive effects of surface water runoff.
7. The key factor in seeding is to cover the seeds with soil to the proper depth. Other factors to consider are slope, size of area to be seeded and soil depth.
 - (a) Handseeding is best on small areas. Breast seeders ("belly-grinders") are inexpensive. Labor effort is 2 to 3 hours per acre.
 - (b) A seed drill works best on level areas. It should not be used on slopes greater than 3:1. When seed is drilled, seed requirements may be reduced up to 50%.

(c) Hydroseeding is most efficient for seeding steep slopes and shallow soils (such as cut slopes and slopes steeper than 2:1). "Hydroseeding," as used in this standard, is the simultaneous application of seed, fertilizer and mulch in a slurry.

8. Factors to consider for irrigating a planted area include:

- time of year;
- water availability;
- steepness of slope;
- cost;
- size of area;
- equipment and technique;
- frequency;
- drought tolerance of planted vegetation.

Irrigation is expensive (about \$1,000 per acre per month). It is generally not necessary unless the:

- seeded area is particularly critical (such as a steep, erodible slope above a water supply reservoir);
- plant species used are not drought tolerant;
- seeds are planted at the wrong time of year.

Once begun, irrigation should be continued until plant cover is fully established. Ceasing irrigation after germination leaves seedlings vulnerable to destruction by drought. Excessive irrigation or other improper irrigation practices can be harmful.

9. Application of mulch increases percentage of plant establishment and protects a disturbed site from erosive forces. Mulch helps hold fertilizer, seed and topsoil in place in the presence of wind, rain and runoff, and maintains moisture near the soil surface. Commonly used mulches include straw, wood fiber, wood chips or bark, fabric or mats, soil and gravel.

The choice of mulch should be based on:

- effectiveness of materials;
- size of area;
- steepness of slope;
- soil depth and surface hardness;
- wind conditions;
- availability of materials;
- cost;
- access to roadway and slope orientation (uphill or downhill);
- fire hazard;
- weed growth;
- maintenance and repair costs.

Straw is the preferred mulch material:

- on slopes of less than 2:1;
- in large areas accessible within 50 feet of straw-blowing equipment;
- on fill slopes;
- in nonwindy areas;
- in downhill or downwind applications;
- where fire hazard and weed growth are not critical factors;
- where repair and revegetation would be costly (straw mulch is highly effective and should not require maintenance if properly applied).

Wood fiber mulch, applied hydraulically, is the preferred mulch material:

- in areas more than 50 feet from road access;
- on slopes steeper than 2:1;
- on cut slopes with shallow soil cover;
- in windy areas;
- where straw is not available;
- where fire hazard or weed growth are critical factors.

While initial costs of applying wood fiber mulch hydraulically may be lower than costs of applying straw mulch, repair and maintenance requirements are often greater with wood fiber because wood fiber provides less immediate protection than straw.

10. Fertilizer is necessary for rapid growth of grasses or legumes. It is important because construction activities generally result in the exposure of infertile parent material. Ammonium phosphate sulfate, 16-20-0, at the rate of 500 pounds per acre adequately replenishes soil nutrients during the critical first year and allows rapid plant cover establishment.
11. Slopes should be repaired and/or reseeded if the following conditions are observed:
 - sheet or rill erosion;
 - sediment buildup at toe of slope.

If seeding is done long before September, seed loss caused by birds and wind may be significant. Thus, planting during September may improve results.

Unit Cost Guide

\$500-\$1,000 per acre (as of fall 1979).

Sources and References

This standard was prepared by ABAG based on the following sources:

1. Crowell, Robert, Cagwin and Dorward Landscape Contractors and Engineers, San Rafael, California.
2. Kay, Burgess L., Wildland Seeding Specialist, Department of Agronomy and Range Science, University of California, Davis.
3. U.S. Department of Agriculture, Soil Conservation Service.
4. U.S. Department of Commerce, National Weather Service.

June 1981

SAMPLE SPECIFICATIONS FOR TEMPORARY AND PERMANENT PLANTING OF EXPOSED SOILS

Before seeding, necessary drainage controls such as dikes at tops of slopes and swales on slope benches shall be installed to prevent runoff from eroding slopes before grass is established. Temporary drainage controls shall remain in place until permanent drainage facilities are installed or until slopes are stabilized and temporary controls are no longer necessary for continued slope stability.

1. The soil on the site shall meet the following criteria:
 - (a) The soil shall contain no more than 70% sand (as defined by USDA, Soil Conservation Service). This is to provide enough available water-holding capacity to support plant growth.
 - (b) The soil shall have sufficient porous base (greater than 30%) to permit adequate root penetration and provide for exchange of gases and water.
 - (c) The soil shall be free from any material harmful to plant growth.
 - (d) Top soil that has been graded from the site shall be stockpiled, whenever possible, for reapplication on exposed graded slopes during the final grading stage. The soil shall be disked into the existing soil to provide for a good bond.
2. The area to be seeded shall have a firm seedbed that has previously been roughened by scarifying, disking, harrowing, chiseling or track-walking, or otherwise worked to a depth of 2 to 4 inches unless a roughened condition already exists. No implement shall be used that will create an excessive amount of downward movement of soil or clods on sloping areas. The seedbeds may be prepared at the time of completion of earth-moving work.
3. Seeding, fertilizing and mulching shall be done by October 1 of any year.
4. Slopes above critical areas, such as a water supply reservoir or an existing residence, shall be stabilized by October 15 of any year. Irrigation shall be used if rainfall is insufficient to establish protection by this date.
5. The following seed mix shall be applied at or above the minimum rate specified below:

| <u>Seed Type</u> | <u>Minimum Application Rate (pounds per acre)</u> |
|------------------|---|
| 'Blando' brome | 30 |
| Annual ryegrass | 20 |

(Note: This is only one of several possible mixes. It is provided for illustrative purposes.)

All seed shall be delivered to the site tagged and labeled in accordance with the California Agricultural Code and shall be acceptable to the County Agricultural Commissioner.

Seed shall be distributed uniformly over the seedbed by hand broadcasting, hydroseeding or other approved method. Seed shall be covered to a depth of one-quarter to one-half inch except when seed is hydraulically applied with a mulch. Seed shall not have a soil cover greater than 1 inch.

6. Fertilizer shall be distributed uniformly over the seedbed at a rate of not less than 500 pounds per acre. Fertilizer shall be applied in any way that will result in uniform distribution. Fertilizer shall be incorporated into the soil if possible. Incorporation may be as part of the seedbed preparation or as part of the seeding operation.

The fertilizer shall contain a minimum of 16% nitrogen, 20% available phosphoric acid, 0% water soluble potash and 15% sulfur. It shall be uniform in composition, dry and free flowing, pelleted or granular.

All fertilizer shall be delivered in unbroken or unopened containers, labeled in accordance with the applicable state regulations, and bearing the warranty of the producer for the grade furnished.

Fertilizer may also be applied as a mix with seed and fiber in a slurry (see No. 8 below).

7. A mulch covering shall be distributed uniformly over the surface of the seeded area. Mulching shall follow immediately after seeding.

- (a) For slopes flatter than 2:1 and within a 50-foot access of a straw blower, the following procedure shall be used:

Straw mulch shall be of unrotted small grain straw and shall be applied at the rate of 4,000 pounds per acre. Mulch materials shall be relatively free of all noxious weeds. The mulch shall be applied by hand, blower or other suitable equipment. If the straw is applied with a blower, it shall be chopped in lengths not shorter than 6 inches.

The mulch shall be anchored in place using hand tools, mulching rollers, disks, nets, chemical tackifiers or other suitable means.

- (b) For slopes steeper than 2:1, mulch shall be applied hydraulically as specified in No. 8.

8. "Hydroseeding" is defined as the simultaneous application of seed, fertilizer and mulch in a slurry.

The hydroseeder shall be equipped with a built-in continuous agitation system of sufficient operating capacity to produce a homogeneous slurry and with a discharge system that applies the slurry to the slopes at a continuous and uniform rate. Seed shall not remain in the slurry longer than 30 minutes. The slurry shall contain the required fertilizer (see No. 6 above) and shall also contain wood fiber to be applied at the rate of 1,500 pounds of wood fiber per acre.

The water used shall be potable water or Class 1 or 2 agricultural irrigation water.

The slurry shall be continuously mixed and shall be mixed for at least 5 minutes after the last addition before application starts. The slurry shall be applied at a rate that is nonerosive and minimizes runoff.

9. Irrigation is optional, except on critical areas (see No. 4 above). If irrigation is required or desired, the following procedure shall be used. The top 1 inch of soil of all seeded areas shall be kept moist for the first 21 days after seeding. Moisture needs will be determined by visual observation. After 21 days the top 6 inches of soil shall be kept moist until the first major rainstorm (minimum 1.0 inch per 24 hour period). The moisture level shall not be allowed to drop below 50% available moisture capacity.

Irrigation applications shall not exceed:

- 0.5 inch of water applied per acre per irrigation on sandy soils;
- 1.0 inch of water applied per acre per irrigation on loamy and clayey soils.

Irrigation water shall be potable or Class 1 or 2 agricultural irrigation water. Water shall be applied by sprinklers or similar devices at a nonerosive rate using the above criteria as a guide.

10. Seeded areas shall be inspected no more than 30 days after planting and no more than 30 days after the first rain. Follow-up inspections shall be done between 60 and 90 days after the first inspection and once again in the spring. The spring inspection shall establish any corrective measures necessary before the next rainy season.

If at the 90-day inspection the vegetation is not established and severe erosion is expected to continue, slopes shall be reseeded and/or repaired. Eroded slopes shall be smoothed over, including the filling of rills and/or gullies, before reseeding starts. The reseeding operation shall follow the specifications given above.

Sources and References

These sample specifications were prepared by ABAG based on the following sources:

1. Crowell, Robert, Cagwin and Dorward Landscape Contractors and Engineers, San Rafael, California.
2. Kay, Burgess L., Wildland Seeding Specialist, Department of Agronomy and Range Science, University of California, Davis.
3. U.S. Department of Agriculture, Soil Conservation Service.

June 1981

2. TEMPORARY AND PERMANENT GRASS PROTECTION OF WATERWAYS, SWALES AND DIKES

STANDARD

Definition

Vegetation lining a natural or constructed waterway, swale or dike to protect it from erosion.

Purpose

Grass protection of drainageways reduces erosion by lowering water velocity over the soil surface and by binding soil particles with roots. A drainageway, as used in this standard, is any ground surface over which concentrated runoff travels. It is typically a manmade waterway, swale or ditch. It may also be the upslope side of a dike or berm, which intercepts overland flow of water and directs the concentrated flow along the surface of the barrier. Grassed drainageways should not be used:

- where the drainageway gradient must be steeper than 10%;
- below high sediment-producing areas unless measures (such as sediment basins) are installed to prevent sediment from reaching the drainageway;
- above slopes where infiltration of water may cause soil slumping or slope failure.

This standard supplements those for Permanent Waterway, Temporary Dike, and Temporary Swale.

Design Considerations

1. The placement of a grassed drainageway must be carefully considered. Its design should be based on a comprehensive evaluation of the surface contours and, for permanent waterways, on estimated peak surface runoff from the design storm. Natural subsurface drainage conditions should be evaluated to determine whether drainage from a grassed drainageway will adversely affect the subsurface drainage system.
2. Water velocity in grassed drainageways will be slower than in concrete or earth-lined drainageways. Therefore, grassed drainageways may need to be larger. If space does not permit the design of a wide or gently sloping channel, then other linings must be used.
3. Outlets should function with a minimum of erosion.

4. Grassed drainageways should be periodically inspected during the rainy season to see that debris is not obstructing the drainage path. Permanent grassed waterways should be seasonally maintained by mowing or irrigating depending on the type of vegetation selected. Grassed swales requiring mowing should be designed to accommodate a minimum bottom width to allow for mowing access.
5. Factors to consider in the selection of plants include:
 - plants tolerant of temporary or seasonally high moisture and waterlogged soil conditions;
 - plants that establish extensive fibrous roots or rhizomes to bind the soil mass and prevent erosion;
 - plants that have low biomass and that do not mat excessively or cause flow to channelize;
 - plants that develop and establish rapidly following the normally occurring light, early-season rains;
 - plants that reseed and develop well from seed or provide continuous vegetative growth.

Plants that meet these criteria are listed in Table 7.

6. Seeding rates for plants should be sufficiently high to provide a dense grass stand. The seeds should be uniformly distributed to reduce patchy growth effects and soil exposure, especially when seeding bunching or nonspreading grasses.
7. Seeding, mulching, fertilizing and irrigating considerations are the same as those discussed in the Standard for Planting of Exposed Soils. However, hydraulically applied seed and mulch should be used only if grass is established before the rainy season by irrigating.
8. Stabilization of a grassed drainageway should be accomplished before the first erosive rains of the season. Seeding should be completed by September 15 to maximize the chances of intercepting the light, early-season rains and the chances of grass establishment by October 15. A good indicator of stabilization is the absence of exposed soil in the drainageway.

Germinating rains do not always come before erosive rains. In addition, early season rains are often insufficient to establish adequate grass cover before the period of heavy winter rains (December to February). Therefore, a contingency plan is advised to ensure either grass establishment or another form of drainageway protection. Temporary irrigation measures can be used to establish grass. Measures such as straw mulching at the time of seeding can provide temporary protection until grass is established.

TABLE 7. PLANTS SUITABLE FOR BAY AREA GRASSED WATERWAYS, SWALES AND DIKES

| Common Name | Scientific Name | Persistence/ Growth Form | Maintenance Requirements | Comments | Recommended Seeding Rates ^a | Rating ^b | Maximum Permissible Velocity (fps) %Gradient |
|-----------------------------|------------------------------|---|--|--|---|---------------------|---|
| Annual ryegrass | <u>Lolium multiflorum</u> | Annual, poor re-seeding capacity/ Bunchgrass | - | One year channel protection; common erosion control grass. | 50 lbs./acre | *** | 5 4 |
| Barley | <u>Hordeum vulgare</u> | Annual, no re-seeding capacity/ Bunchgrass | - | One year channel protection; common erosion control grass. | 300 lbs./acre | * | 5 |
| Oats | <u>Avena sativa</u> | Annual, no re-seeding capacity/ Bunchgrass | - | One year channel protection; common erosion control grass. | 300 lbs./acre | * | 4 |
| Redtop | <u>Agrostis alba</u> | Perennial/ Sodforming | Summer irrigation | One year channel protection advised; becomes coarse & stemmy. | 15 lbs./acre | *** | 5 |
| 'Blando' brome | <u>Bromus mollis</u> | Annual, good reseed-ing capacity/ Bunchgrass | Mowing or heading seasonally | Common erosion control grass. | 50 lbs./acre | *** | 5 4 |
| Perennial ryegrass | <u>Lolium perenne</u> | Perennial/ Bunchgrass | Summer irrigation, mowing or heading seasonally | Common turfgrass. | 30 lbs./acre | *** | 5 4 |
| Tall fescue | <u>Festuca arundinacea</u> | Perennial/ Bunchgrass | Summer irrigation, mowing or heading seasonally | Common turfgrass; supports machine traffic; may use with-out other grass species. | 500 lbs./acre | **** | 6 5 |
| Orchardgrass | <u>Dactylis glomeris</u> | Perennial/ Bunchgrass | Mowing or heading seasonally | Use with other grasses, otherwise channeling may occur. | 20 lbs./acre | * | 5 |
| 'Kentucky' bluegrass | <u>Poa pratensis</u> | Perennial/ Sodforming | Summer irrigation, mowing or heading seasonally | Common turfgrass. | 20 lbs./acre | *** | 5 |
| Reed canarygrass | <u>Phalaris arundinacea</u> | Perennial/ Sodforming | Summer irrigation, mowing or heading seasonally | Tolerates excessive flooding. | 20 lbs./acre | *** | 5 4 |
| Bermudagrass | <u>Cynodon dactylon</u> | Perennial/ Sodforming | Requires temporary irrigation until grass is established | Develops slowly from seed; may use without other grass species. Do not use next to lawns; vigorous spreading nature may create a nuisance. | 30 bu./acre | **** | 6 5 |
| 'Luna' pubescent wheatgrass | <u>Agropyron tricophorum</u> | Perennial/ Sodforming | Mowing or heading seasonally | | 40 lbs./acre | *** | 5 4 |

a. Recommended seeding rates for mixtures of two or more grasses.

b. Drainage protection capacity ratings are as follows: Fair = *; Good = **; Excellent = ***; Superior = ****

Specialized erosion control liners can be installed at the time of seeding or as part of a contingency plan to be implemented if grass is not established by October 15. However, these liners vary in cost and effectiveness and should only be used within the manufacturer's limits.

If the area downstream from the drainageway is a critical area or warrants increased protection, the grass should be established in the drainageway by artificial means before the rainy season begins (before October 1).

Unit Cost Guide

Grass establishment: \$1.00 - \$1.50 per square yard (as of fall, 1979).

Sources and References

This standard was prepared by ABAG based on the following sources:

1. Kay, Burgess L., Wildland Seeding Specialist, Department of Agronomy and Range Science, University of California, Davis.
2. U.S. Department of Agriculture, Soil Conservation Service.
3. U.S. Department of Commerce, National Weather Service.

June 1981

SAMPLE SPECIFICATIONS FOR TEMPORARY AND PERMANENT GRASS PROTECTION OF WATERWAYS, SWALES AND DIKES

(These sample specifications supplement those for Permanent Waterway.)

Design Specifications

1. The drainageway cross-section may be parabolic or trapezoidal. The drainageway shall be designed to have stable side slopes, shall not be steeper than 2:1 and shall be flat enough to ensure ease of maintenance of the structure and its protective vegetative cover. The minimum cross-section shall meet the specified dimensions. A minimum of 0.3 foot freeboard will be provided.
2. Drainageway grades may be uniform or variable. The drainageway shall be designed within the maximum permissible flow velocities given below:

| Plant Cover | Channel Gradient (percent) | Maximum Velocity (feet per second) |
|---|----------------------------|------------------------------------|
| a. Annual ryegrass, 'Blando' brome and barley or oats | { 0-5 5-10 | 5 4 |
| b. 'Blando' brome, barley or oats and 'Luna' pubescent wheatgrass | { 0-5 5-10 | 5 4 |
| c. Tall fescue | { 0-5 5-10 | 6 5 |

3. If a high potential exists for sediment accumulation in the drainageway, a vegetated filter strip or sediment-trapping structure shall be installed to trap the sediment before it can enter the drainageway.

Grass Establishment Specifications

1. The soil and seedbed preparation shall be according to the Sample Specifications for Planting of Exposed Soils.
2. Seed shall be applied according to the use and rates given below:

Minimum Application Rate
(pounds per acre)

Temporary Swale or Dike Protection
(Nonirrigated mix)

| | |
|-----------------|-----|
| Annual ryegrass | 50 |
| 'Blando' brome | 50 |
| Barley or oats | 300 |

Permanent Waterway Protection
(Nonirrigated mix)

| | |
|-----------------------------|-----|
| 'Blando' brome | 50 |
| Barley or oats | 300 |
| 'Luna' pubescent wheatgrass | 40 |

Permanent Waterway Protection
(Irrigated mix)

| | |
|--------------------|-----|
| Tall fescue (turf) | 500 |
|--------------------|-----|

(Note: Other grasses from Table 7 may substitute for those above, at the recommended seeding rates. The seeding rates in Table 7 apply for mixtures of two or more grasses. Only tall fescue and bermudagrass may be used by themselves.)

3. Seed and fertilizer shall be applied according to the Sample Specifications for Planting of Exposed Soils, except as modified by No.'s 4, 5 and 6 below.
4. "Hydroseeding" is defined as the simultaneous application of seed, fertilizer and mulch in a slurry. Hydroseeding may be done only when grass is to be fully established in the drainageway before October 1. Hydroseeded grass shall be irrigated until established. Hydroseeding shall be done as specified in No. 8 of the Sample Specifications for Planting of Exposed Soils.
5. Except when grass is established as specified in No. 4 above, a straw mulch covering shall be distributed uniformly over the surface of the seeded area. Mulch shall be applied immediately after seeding. Straw mulch shall be of unrotted small grain straw and shall be applied at the rate of 4,000 pounds per acre. Mulch materials shall be relatively free of all noxious weeds. The mulch shall be applied by hand, blower or other suitable equipment. If the straw is applied with a blower, it shall be chopped in lengths not shorter than 6 inches.

The mulch shall be anchored in place anchored using hand tools, mulching rollers, disks, nets, chemical tackifiers or other suitable equipment.

6. The drainageway shall be seeded by September 15 and be sufficiently stabilized by October 15 to provide nonerosive drainage. The criterion for channel stabilization shall be the absence of exposed soil in the drainage path.

If grass slopes of less than 5% are not or will not be established by October 15, one of the following contingency measures shall be implemented by that date:

- (a) Seed and straw mulch shall be applied and covered with jute matting according to the Standard and Specifications for Protective Materials for Channels and Steep Slopes.
- (b) Seed and straw mulch shall be applied and anchored with erosion control netting according to the manufacturer's specifications.

In drainageways with slopes of 5 to 10%, grass shall be established by October 15 by using irrigation according to the Sample Specifications for Planting of Exposed Soils.

For drainageways in critical areas where failure of the grass lining must be avoided, irrigation is recommended to ensure stabilization by October 15.

7. When base flows of extended duration and of other than immediate storm runoff origin are expected, structural protection shall be according to one of the following:

- (a) Stone centers for base flow shall be constructed as shown in the sample drawing.

The stone center portion shall be stabilized with riprap according to the Standard and Sample Specifications for Riprap.

- (b) A subsurface drain for the base flow shall be constructed as shown on the sample drawing and as specified in the Standard and Sample Specifications for Subsurface Drain.

- (c) Gabion mattress channel liners may be used for base flow, design flow and subsurface drainage.

8. Grassed drainageways shall be inspected at the time of seeding and after each major storm. The drainage capacity of a permanent waterway shall be restored to its original capacity before October 15 of any year (except the first year of seeding) by mowing or other grass-cutting practices. Drainageways damaged by erosion, rodents, vehicles or other causes shall be repaired.

Source and References

These sample specifications were prepared by ABAG based on the following sources:

1. Kay, Burgess L., Wildland Seeding Specialist, Department of Agronomy and Range Science, University of California, Davis.
2. U.S. Department of Agriculture, Soil Conservation Service, College Park, Maryland, Standards and Specifications for Soil Erosion and Sediment Control in Developing Areas, July 1975.

Sample Drawing: Grassed Waterway With Stone Center

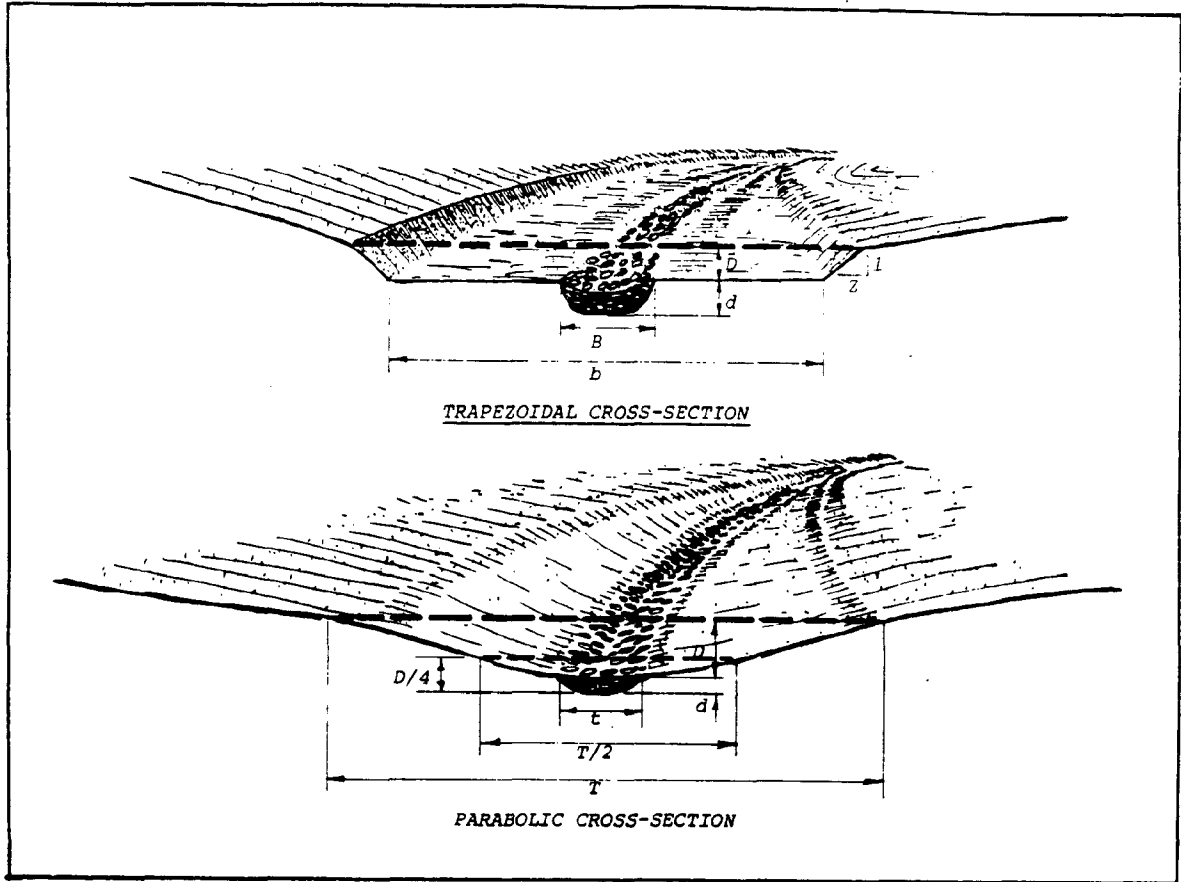

(adapted from USDA, Soil Conservation Service, College Park, Maryland. Standards and Specifications for Soil Erosion and Sediment Control in Developing Areas. July 1975.)

3. TEMPORARY DIKE

STANDARD

Definition

A temporary ridge of compacted soil installed immediately above a new cut or fill slope or around the perimeter of a disturbed area.

Purpose

A dike performs either of two functions. When located above an exposed slope, it intercepts storm runoff from small upland areas and diverts it to an acceptable outlet. When located around the perimeter of a disturbed area, it prevents runoff from entering this area and also prevents sediment-laden runoff from leaving the disturbed area. A dike remains in place until permanent drainage features are installed and/or slopes are stabilized.

This standard applies to all earth-fill structures constructed according to Earth Dams and Reservoirs (USDA, Soil Conservation Service, Technical Release No. 60, June 1976).

Design Considerations

Design considerations should include the following:

- drainage area;
- top width and height;
- side slopes and grade;
- quantity of water diverted;
- velocity of water diverted;
- stabilization against erosion;
- outlet.

Unit Cost Guide

\$2.00-\$3.00 per linear foot (as of fall 1979).

Source and Reference

This standard was prepared by ABAG based on materials furnished by staff of the USDA, Soil Conservation Service.

SAMPLE SPECIFICATIONS FOR TEMPORARY DIKE

Design and Construction Specifications

1. The drainage area shall be less than 5 acres (for larger drainage areas see Standard and Sample Specifications for Permanent Waterway).
2. The top width shall be a minimum of 2 feet.
3. The height (compacted fill) shall be a minimum of 18 inches measured from the existing ground at the upslope toe to the top of the dike. The maximum height shall be 30 inches.
4. The side slopes shall be 2:1 or flatter.
5. The grade along the face of the dike (flow area) shall be dependent on topography, but shall be a minimum of 1% (sufficient grade to drain) to an adequate outlet. Drainage must be positive. The "flow area" of the dike is defined as the upslope portion of the dike face and adjacent ground surface over which diverted runoff water flows.
6. The flow area shall be stabilized:
 - (a) where the slope of the flow area exceeds 5%; or
 - (b) where the slope of the flow area is 1% to 5% and the maximum flow velocity from the 10-year frequency storm is exceeded as specified below:

| <u>Flow Area Surface</u> | <u>Maximum Velocity (feet per second)</u> |
|--|---|
| Sand and sandy loam | 2.5 |
| Silt loam | 3.0 |
| Sandy clay loam | 3.5 |
| Clay loam | 4.0 |
| Clay, fine gravel and graded loam to gravel | 5.0 |
| Graded silt to cobbles | 5.5 |
| Shale, hardpan and coarse gravels | 6.0 |

7. Stabilization, when required by No. 6 above, shall be:
 - (a) in accordance with the Standard and Sample Specifications for Grass Protection of Waterways, Swales and Dikes, when the dike intercepts runoff from a protected or stabilized area; or
 - (b) by lining the flow area with stone that meets MSHA size No. 2 or AASHTO M43 size No. 2 or 24 in a layer at least 3 inches thick and pressed into the soil. The lining shall extend up the upslope side of the dike to a height of at least 8 inches measured vertically from the upslope toe and shall extend upslope from the upslope toe a distance sufficient to include the flow area.
8. Diverted runoff from:
 - (a) a protected or stabilized area shall outlet directly to a grade stabilization structure and/or receiving water channel;
 - (b) a disturbed or exposed upland area shall outlet to a sediment trap or a sediment basin or to an area protected by these practices.
9. All dikes shall be machine-compacted with the tires or tracks going over at least 90% of the surface. There shall be a maximum of 6 inches of lift between each compaction.
10. The dike shall be inspected periodically and maintained as required.

Source and Reference

These sample specifications were prepared by ABAG based on U.S. Department of Agriculture, Soil Conservation Service, College Park, Maryland, Standards and Specifications for Soil Erosion and Sediment Control in Developing areas, July 1975.

Sample Drawing: Dike*

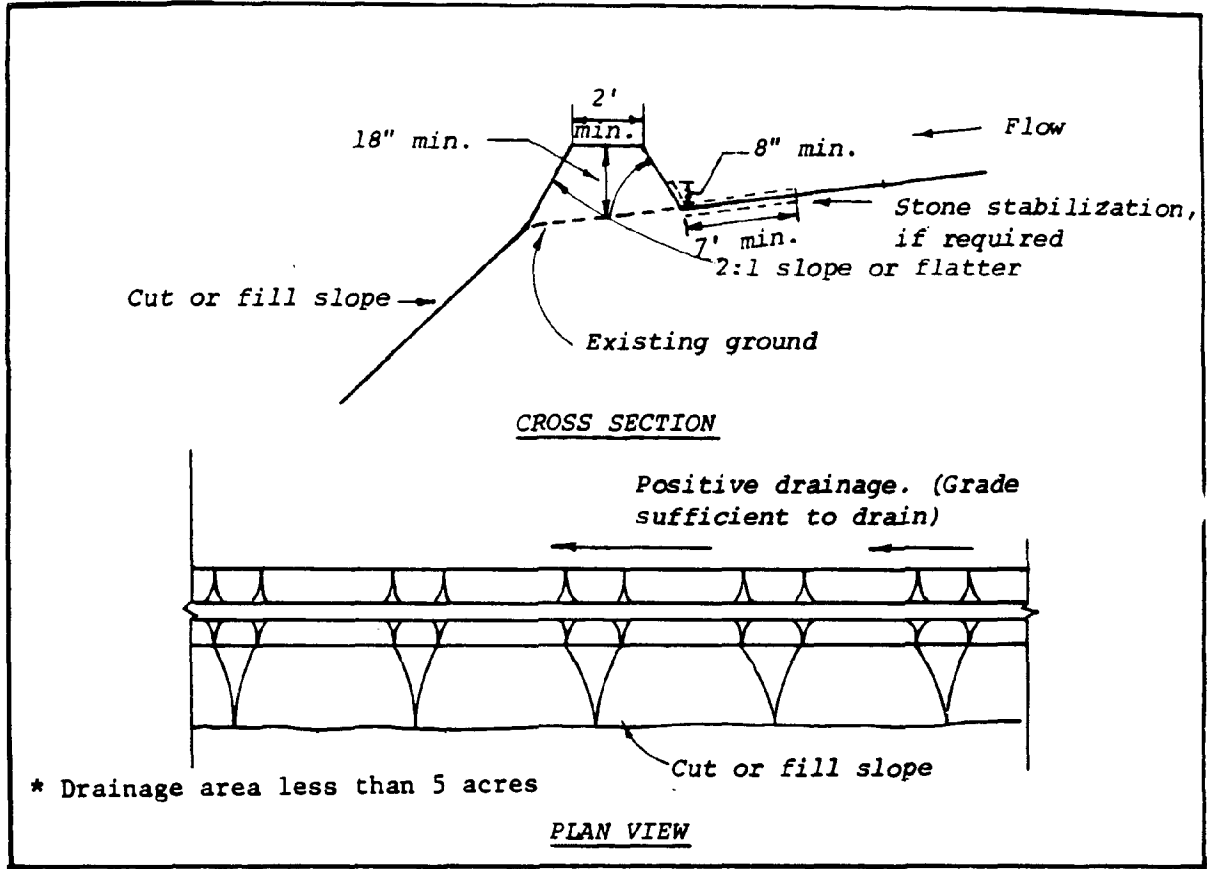

(adapted from USDA, Soil Conservation Service, College Park, Maryland. Standards and Specifications for Soil Erosion and Sediment Control in Developing Areas. July 1975.)

4. TEMPORARY SWALE

STANDARD

Definition

A temporary ditch or drainageway constructed across or around disturbed areas of less than 5 acres, such as building pads or rights-of-way for pipelines and streets.

Purpose

A swale performs either of two functions. When located on a slope bench, it reduces the potential for erosion by intercepting storm runoff and diverting it to a stabilized outlet or sediment-trapping device. When located around the perimeter of a disturbed area, it prevents storm runoff from entering this disturbed area or directs sediment-laden runoff leaving this disturbed area. Runoff carried by a swale should be adequately handled to prevent flooding or erosion damage to adjacent property. A swale remains in place until permanent drainage features are installed and/or slopes are stabilized.

Design Considerations

Design considerations should include the following:

- location;
- drainage area;
- quantity and velocity of water being conveyed;
- bottom width;
- depth;
- side slope;
- grade;
- stabilization;
- outlet;
- traffic crossings;
- spacing between swales.

Unit Cost Guide

\$8.00-\$15.00 per cubic yard (as of fall 1979), depending on the base material.

Source and Reference

This standard was prepared by ABAG based on materials furnished by staff of the USDA, Soil Conservation Service.

June 1981

SAMPLE SPECIFICATIONS FOR TEMPORARY SWALE

Design and Construction Specifications

1. The drainage area shall be less than 5 acres (for larger drainage areas, see Standard and Sample Specifications for Permanent Waterway).
2. The bottom width shall be a minimum of 7 feet and the bottom shall be level.
3. The depth shall be a minimum of 1 foot.
4. The side slope shall be 2:1 or flatter (flat enough to allow construction traffic to cross if desired).
5. The grade shall be dependent on topography, but shall be a minimum of 1% (sufficient grade to drain) to an adequate outlet. Drainage must be positive.
6. The swale shall be stabilized:
 - (a) where the slope of the swale bottom exceeds 5%; or
 - (b) where the slope of the swale bottom is 1% to 5% and the maximum flow velocity from the 10-year frequency storm is exceeded as specified below:

| <u>Swale Surface</u> | <u>Maximum Velocity (feet per second)</u> |
|--|---|
| Sand and sandy loam | 2.5 |
| Silt loam | 3.0 |
| Sandy clay loam | 3.5 |
| Clay loam | 4.0 |
| Clay, fine gravel and graded loam to gravel | 5.0 |
| Graded silt to cobbles | 5.5 |
| Shale, hardpan and coarse gravels | 6.0 |

7. Stabilization, when required by No. 6 above, shall be:
 - (a) in accordance with the Standard and Sample Specifications for Grass Protection of Waterways, Swales and Dikes when the swale receives runoff from a stabilized area; or

- (b) by lining the flow area with stone that meets MSHA No. 2 or AASHTO M43 size No. 2 or 24 in a layer at least 3 inches thick and pressed into the soil. The lining shall extend across the bottom and up both sides of the channel to a height at least 8 inches vertically above the bottom.
- 8. At all points where the swale will be crossed by vehicles several times a day, the swale shall be stabilized according to 7(b) above, except that the stone lining shall be at least 6 inches thick for the whole width of the traffic crossing.
- 9. Diverted runoff from:
 - (a) a protected or stabilized upland area shall outlet directly to a grade stabilization structure and/or a receiving water channel;
 - (b) a disturbed or exposed upland area shall be conveyed to a sediment trap or basin or to an area protected by these practices.
- 10. The swale shall be located to take advantage of the most suitable outlet. The swale shall discharge without causing erosion at its outlet.
- 11. All trees, brush, stumps, obstructions and other objectionable material shall be removed and disposed of so as not to interfere with the proper functioning of the swale.
- 12. The swale shall be excavated and/or shaped to line, grade and cross-section as required to meet the criteria specified herein, and be free of bank projections or other irregularities that will impede normal flow.
- 13. Fills shall be compacted as needed to prevent unequal settlement that would cause damage in the completed swale.
- 14. All earth removed and not needed in construction shall be spread or disposed of so it will not interfere with the functioning of the swale.
- 15. The swale shall be inspected periodically and maintained as required.

Source and Reference

These sample specifications were prepared by ABAG based on U.S. Department of Agriculture, Soil Conservation Service, College Park, Maryland, Standards and Specifications for Soil Erosion and Sediment Control in Developing Areas, July 1975.

Sample Drawing: Swale

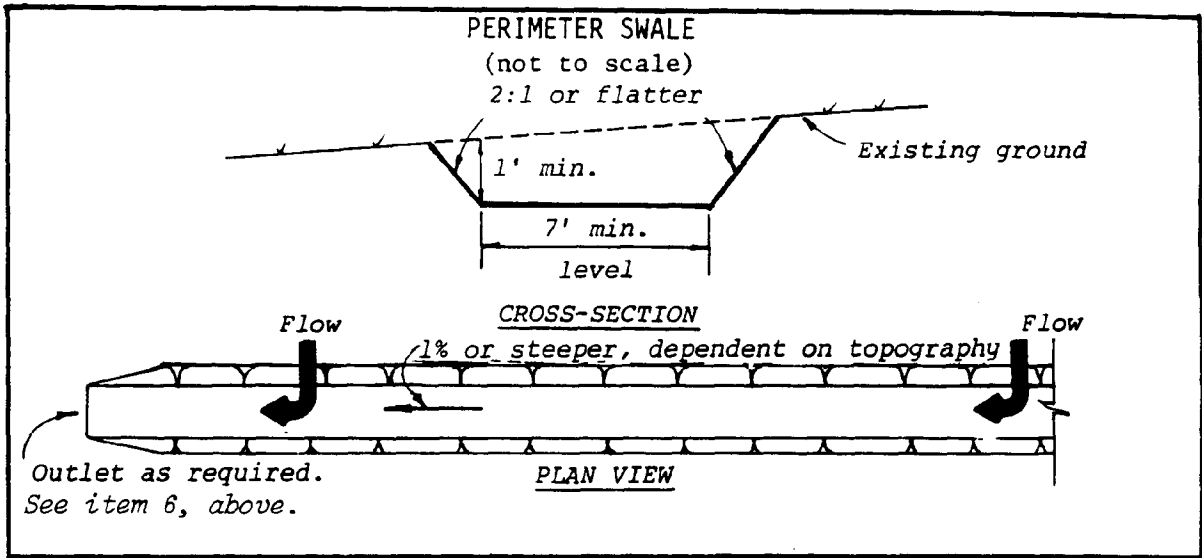

(adapted from USDA, Soil Conservation Service, College Park, Maryland.
Standards and Specifications for Soil Erosion and Sediment Control in
Developing Areas. July 1975.)

5. TEMPORARY GRADE STABILIZATION STRUCTURE

STANDARD

Definition

A temporary pipe or chute constructed of nonerrodible material extending from the top to the bottom of a slope.

Purpose

In areas with a concentrated, high velocity surface runoff flow, a temporary pipe or chute conveys the runoff down slopes without causing erosion.

This standard and sample specifications applies to all types of grade stabilization structures up to a maximum drainage area of 36 acres. (For drainage areas of less than 5 acres, see Sample Specifications for Pipe Slope Drain. For drainage areas between 5 and 36 acres, see Sample Specifications for Paved Chute or Flume.)

Design Considerations

Design considerations should include the following:

- drainage area;
- slope;
- capacity;
- material (rigid pipe, flexible pipe or paved chute);
- pipe or chute dimensions;
- dike at entrance to pipe or chute;
- outlet protection;
- erosion potential downstream.

Unit Cost Guide

Variable, depending on materials, local topography and size.

Source and Reference

This standard was prepared by ABAG based on materials furnished by staff of the USDA, Soil Conservation Service.

SAMPLE SPECIFICATIONS FOR TEMPORARY GRADE STABILIZATION STRUCTURE

Design Specifications

The quality of the materials shall be adequate to provide the stability and durability required to achieve the planned objective with appropriate safety factors. A pipe slope drain or a paved chute or flume shall be used to convey surface runoff down slopes without causing erosion. The maximum allowable drainage area shall be 5 acres for a pipe slope drain, and shall be 36 acres for a paved chute or flume.

Pipe Slope Drain -

1. Pipe slope drains are to be used as follows:

| <u>Size</u> | <u>Pipe/Tubing Diameter, D, (inches)</u> | <u>Maximum Drainage Area (acres)</u> |
|-------------|--|--------------------------------------|
| PSD-12 | 12 | 0.5 |
| PSD-18 | 18 | 1.5 |
| PSD-21 | 21 | 2.5 |
| PSD-24 | 24 | 3.5 |
| PSD-30 | 30 | 5.0 |

(Note: These pipe size specifications are examples only. The pipe dimensions for each project should be calculated by a qualified engineer based on local conditions.)

2. The height of the earth dike at the entrance to the pipe slope drain shall be equal to or greater than the diameter of the pipe plus 12 inches (see sample drawings).
3. The pipe slope drain shall outlet onto a riprap apron and then into a stabilized area or stable water course. A sediment-trapping device shall be used to trap sediment from any sediment-laden water conveyed by the pipe slope drain.

Paved Chute or Flume -

1. Size Group A

The height (H) of the dike at the entrance is at least 1.5 feet.
 The depth (D) of the chute down the slope is at least 8 inches.
 The length (L) of the inlet and outlet sections is 5 feet.

Size Group B

The height (H) of the dike at the entrance is at least 2 feet.
The depth (D) of the chute down the slope is at least 10 inches.
The length (L) of the inlet and outlet sections is 6 feet.

Each size group has various bottom widths and allowable drainage areas as shown below:

| <u>Size*</u> | <u>Bottom Width B, (feet)</u> | <u>Maximum Drainage Area (acres)</u> | <u>Size*</u> | <u>Bottom Width B, (feet)</u> | <u>Maximum Drainage Area (acres)</u> |
|--------------|-----------------------------------|--|--------------|-----------------------------------|--|
| A-2 | 2 | 5 | B-4 | 4 | 14 |
| A-4 | 4 | 8 | B-6 | 6 | 20 |
| A-6 | 6 | 11 | B-8 | 8 | 25 |
| A-8 | 8 | 14 | B-10 | 10 | 31 |
| A-10 | 10 | 18 | B-12 | 12 | 36 |

(Note: These chute and flume size specifications are examples only. The chute or flume dimensions for each project should be calculated by a qualified engineer based on local conditions.)

*The size is designated with a letter and a number, such as A-6, which means a chute or flume is size group A with a 6-foot bottom width. The selected size shall be shown on the plans.

2. When a paved chute or flume of size group B is used, the velocity at its outfall shall be checked for erosion potential downstream.

Construction Specifications

Rigid Pipe Slope Drain -

1. The inlet pipe shall have a slope of 3% or steeper.
2. The top of the earth dike over the inlet pipe, and those dikes carrying water to the pipe, shall be at least 1 foot higher at all points than the top of the inlet pipe.
3. The pipe shall be corrugated metal pipe with watertight connecting bands.
4. A riprap apron shall be provided at the outlet. This shall consist of 6-inch diameter stone placed as shown on the sample drawing.
5. The soil around and under the inlet pipe and entrance section shall be hand-tamped in 4-inch lifts to the top of the earth dike.
6. Follow up inspection and any needed maintenance shall be performed after each storm.

Flexible Pipe Slope Drain -

1. The inlet pipe shall have a slope of 3% or steeper.
2. The top of the earth dike over the inlet pipe, and those dikes carrying water to the pipe, shall be at least 1 foot higher at all points than the top of the inlet pipe.
3. The inlet pipe shall be corrugated metal pipe with watertight connecting bands.
4. The flexible tubing shall be the same diameter as the inlet pipe and shall be constructed of durable material with hold-down grommets spaced no more than 10 feet on centers.
5. The flexible tubing shall be securely fastened to the corrugated metal pipe with metal strapping or watertight collars.
6. The flexible tubing shall be securely anchored to the slope by staking at grommets provided.
7. A riprap apron shall be provided at the outlet. This shall consist of 6-inch diameter stone placed as shown on the sample drawings.
8. The soil around and under the inlet pipe and entrance section shall be hand-tamped in 4-inch lifts to the top of the earth dike.
9. Follow-up inspection and any needed maintenance shall be performed after each storm.

Paved Chute or Flume -

1. The structure shall be placed on undisturbed soil or on well compacted fill.
2. The cut or fill slope shall not be steeper than 2:1 and shall not be flatter than 20:1.
3. The top of the earth dike at the entrance, and those dikes carrying water to it, shall not be lower at any point than the top of the lining at the entrance of the structure.
4. The lining at the entrance to the structure shall extend the distance H above the lining crest shown on the sample drawings.
5. The lining shall be placed beginning at the lower end and proceeding up the slope to the upper end. The lining shall be well compacted and free of voids. The lining surface shall be reasonably smooth.
6. The entrance floor at the upper end of the structure shall have a slope toward the outlet of one-quarter to one-half inch per foot.

aprons shall be continuous with the lining.

8. The lining shall consist of Type 2 Portland cement concrete (3,000 psi), bituminous concrete or comparable nonerrodible material.
9. An energy dissipator of adequate design shall be used to prevent erosion at the outlet.

Source and Reference

These sample specifications were prepared based on materials furnished by staff of the USDA, Soil Conservation Service and modified by ABAG for simplification and clarity.

Sample Drawing: Grade Stabilization Structure*

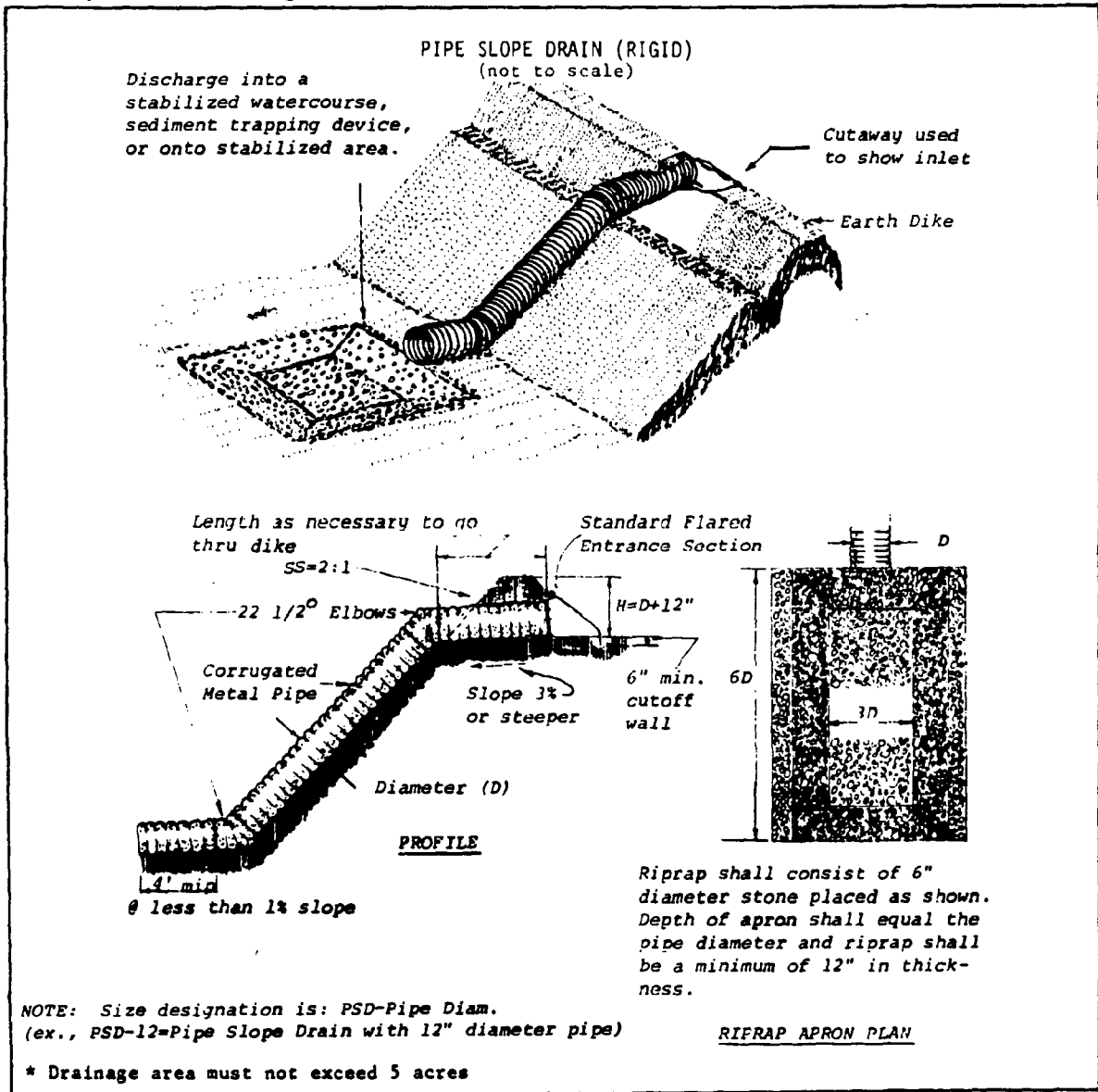

(adapted from USDA, Soil Conservation Service, College Park, Maryland. Standards and Specifications for Soil Erosion and Sediment Control in Developing Areas. July 1975.)

Sample Drawing: Grade Stabilization Structure*

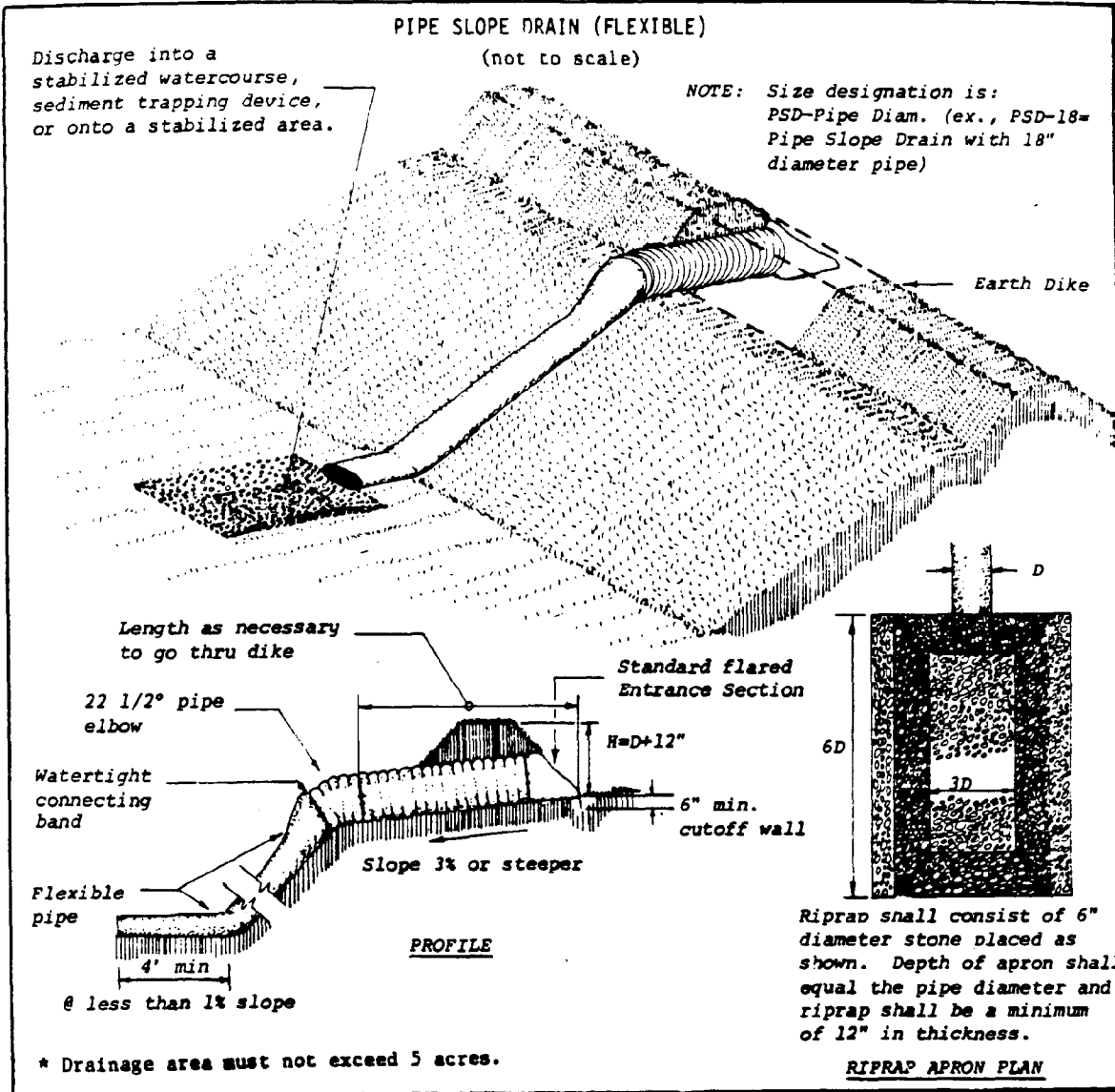

(adapted from USDA, Soil Conservation Service, College Park, Maryland. Standards and Specifications for Soil Erosion and Sediment Control in Developing Areas. July 1975.)

Sample Drawing: Grade Stabilization Structure

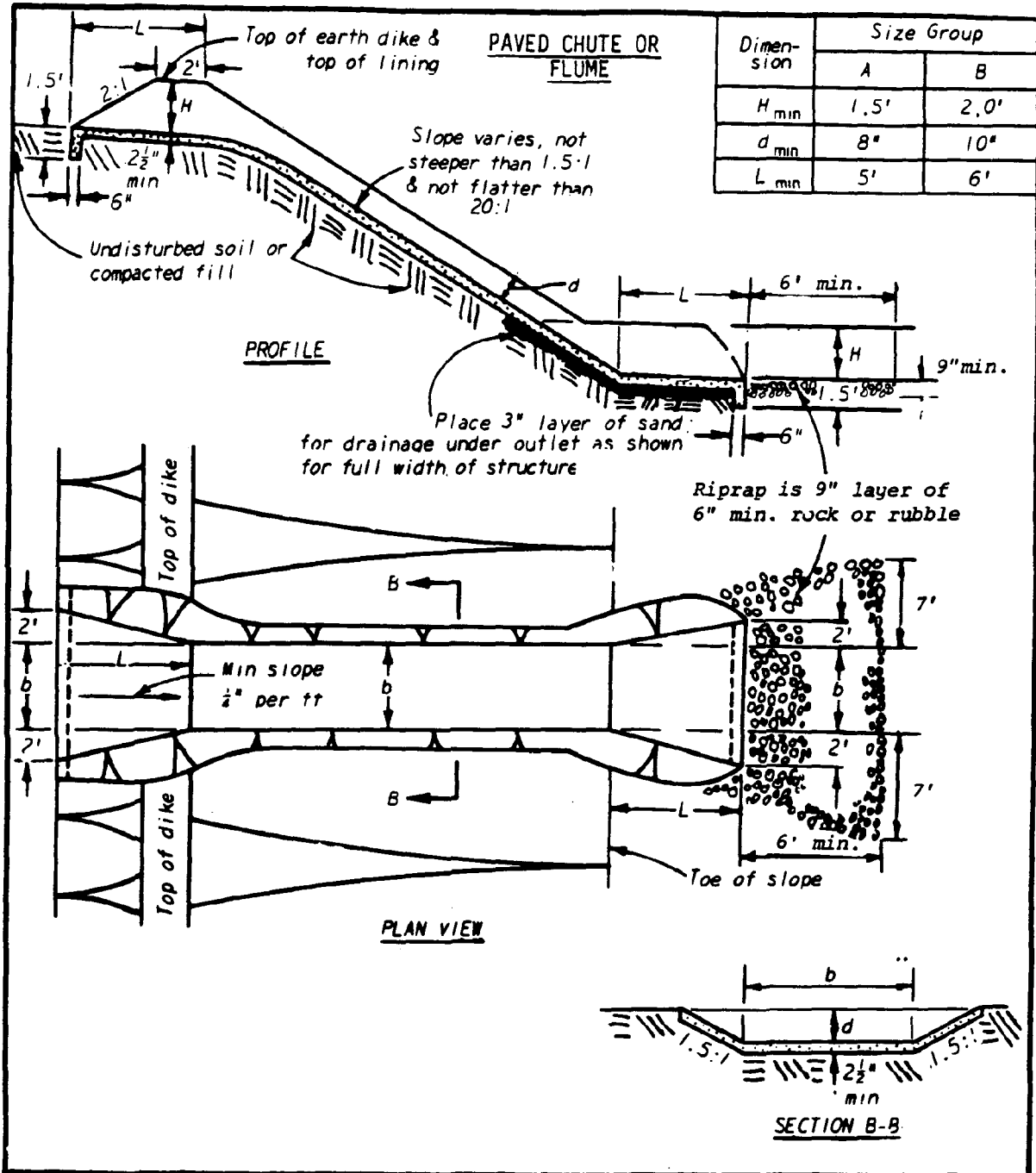

(adapted from USDA, Soil Conservation Service, College Park, Maryland. Standards and Specifications for Soil Erosion and Sediment Control in Developing Areas. July 1975.)

6. TEMPORARY SEDIMENT BASIN

STANDARD

Definition

A temporary basin constructed to collect and store sediment or debris.

Purpose

A sediment basin collects and holds runoff to allow suspended sediment to settle out. A number of small basins are preferable to one large basin. They are used in conjunction with other measures to control runoff, erosion and sedimentation. They are particularly useful below construction operations that expose soil to erosion. Sediment basins remain in place until the disturbed area is permanently stabilized and serve to:

- preserve the capacity of reservoirs, ditches, canals, waterways and streams;
- abate or reduce pollution;
- prevent undesirable deposition on bottomland and developed areas.

This standard establishes the minimum acceptable standards for the design and construction of sediment basins where:

- the effective height of the basin dam is less than 10 feet. (The effective height is the difference in elevation measured from the emergency spillway crest to the lowest point in the cross-section taken along the centerline of the dam. If there is no emergency spillway, the top of the dam is the upper limit.) For basin dams exceeding 10 foot height, consult a qualified civil engineer;
- the earth-fill structure is constructed according to Earth Dams and Reservoirs (USDA, Soil Conservation Service, Technical Release No. 60, June 1976) and all local codes and regulations;
- the basin is to be removed within 12 months after the completion of construction on the site.

For sediment basins that exceed the limits of this standard and for alternate methods of design, consult a qualified civil engineer.

Plans and specifications should comply with the rules and regulations of the California Division of Dam Safety, the California Department of Fish and Game and other state or local agencies.

Design Considerations

Design considerations should include the following:

- state and local laws, rules and regulations;
- drainage area;
- design capacity;
- cleanout frequency;
- embankment and/or excavation specifications;
- principal spillway;
- emergency spillway;
- compatibility with existing topography;
- risk of basin failure;
- soil erodibility, settleability, accumulation rate and particle size;
- controlled access for safety.

It is permissible to have a number of small sediment basins rather than one large basin. Small basins may be easier to locate, cheaper to build and easier to maintain. In addition, property damage risk is generally much lower with small basins. However, no basin should discharge to a lower basin unless the lower basin is designed to handle the runoff from the entire drainage area.

This standard and sample specifications describes a method to size sediment basins according to a surface area criterion. The surface area is determined by the expected flow and the settling velocity of the particle size to be captured.

The basin volume consists of a settling zone and a storage zone. The settling zone should be a minimum of 2 feet deep. The storage volume is estimated using the Universal Soil Loss Equation. Storage requirements will vary considerably depending primarily on local rainfall. Sediment storage volumes in the Bay Area can range from 30 to 120 cubic yards per acre, based on annual cleanout, 10% slopes, no other erosion control practices and typical rainfall values.

Ideally a basin designed to this specification will attain a maximum practical sediment capture of approximately 60 to 70%. However, the fine particles common in Bay Area soils are very difficult to contain in a settling basin. Thus, sediment basins alone are not sufficient protection against soil loss. Erosion and sediment control plans that include vegetative cover of exposed slopes and nonerosive channeling of runoff greatly reduce the expected sediment yield. With such measures included in the plan, the storage volume of sediment basins can be significantly smaller than the figures quoted above and performance will be maximized.

Due to the nature of Bay Area soils, it is strongly recommended that, in the Bay Area, sediment basins be supplemented with other erosion control measures.

The Universal Soil Loss Equation can also be used to estimate the effect of vegetation and other erosion control measures on sediment loss. For example, established vegetation reduces soil loss by an approximate factor of 10. If this reduced figure is used to calculate the required storage volume of a basin, an inspection schedule should be implemented to ensure that vegetation does become established. In addition, unexpected high-intensity storms can generate more sediment than predicted. Therefore, sediment basins should be inspected for cleanout after every major storm, regardless of vegetative cover.

Unit Cost Guide

\$500.00-\$15,000 (as of fall 1979), depending on size, local topography and site conditions.

Source and Reference

This standard was prepared from materials furnished by staff of the USDA, Soil Conservation Service and modified by ABAG to reflect the surface area of the basin as a principal design criterion.

SAMPLE SPECIFICATIONS FOR TEMPORARY SEDIMENT BASIN

Design Specifications

Plans and specifications shall comply with rules and regulations as set forth by the California Division of Dam Safety, California Department of Fish and Game, and other state or local agencies.

1. For the purpose of these specifications, sediment basins are classified as follows:

CLASSIFICATION OF TEMPORARY SEDIMENT BASINS

| Size | Max. Drainage Area, acres | Max. Height* of Dam, ft. | Min. Embankment Top Width, ft. | Embankment Side Slopes | Anti-Seep Collar Req'd. |
|------|---------------------------|--------------------------|--------------------------------|------------------------|-------------------------|
| 1 | 100 | 10 | 8 | 2:1 or flatter | See item 12 |
| 2** | 100 | 15 | 10 | 2-1/2:1 or flatter | Yes |

*Height is measured from the low point of original ground along the centerline of dam to top of the dam.

**ABAG recommends that for dam heights exceeding 10 feet, a civil engineer be consulted for basin design.

2. The sediment basin shall be located to obtain the maximum storage benefit from the terrain and for ease of cleanout of the trapped sediment. It shall be located to minimize interference with construction activities and construction of utilities.
3. The volume of the sediment basin shall consist of two portions: a sediment storage zone and a settling zone.

SEDIMENT BASIN VOLUME REQUIREMENTS
(not to scale)

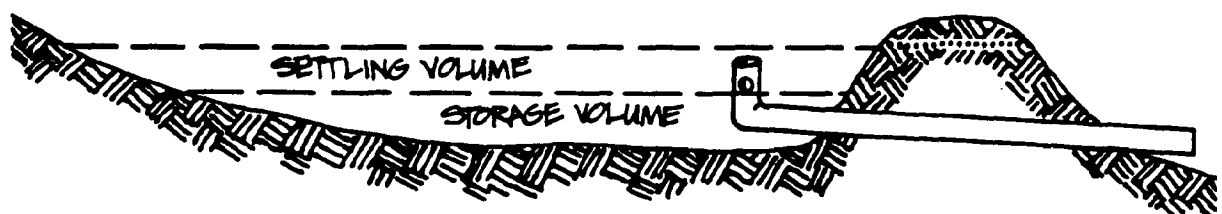

4. The sediment storage zone shall consist of sufficient volume to retain sediment expected to be captured by the basin between maintenance cleanouts. For a once-per-year cleaning, storage for an entire season's soil capture shall be provided. This volume is in addition to the settling zone volume of the basin and may be estimated using the Universal Soil Loss Equation for incoming sediment and assuming basin efficiency for retaining sediment.
5. The sediment settling zone shall always be kept free of sediment. Within it, particles of sediment settle to the storage zone. The sediment settling volume shall be based upon a minimum 2-foot depth to the storage zone.
6. The surface area of the sediment basin shall be calculated at the height of the rim of the riser as follows:

$$A \text{ (sq. ft.)} = \frac{K Q \text{ (cfs)}}{V_s \text{ (ft/sec)}}$$

- where:
- A is the surface area of the sediment basin, in square feet;
 - Q is the design overflow rate at the riser or spillway, in cubic feet per second;
 - V_s is the settling velocity of the selected particle size, expressed in feet per second. (All soil particles greater than or equal to the selected particle size are to be retained in the basin.)
 - K is an adjustment factor for nonideal settling basins, equal to 1.2.

7. The design overflow rate at the riser, Q, shall be calculated by the Rational Method, or other approved method, and shall be based upon a minimum rainfall intensity of the 10-year-frequency, 6-hour duration rainfall total, averaged over 6 hours, for the site in question. Runoff computation shall be based upon the soil cover conditions expected to prevail in the contributing drainage area during the anticipated effective life of this sediment basin.
8. The settling velocity, V_s, which shall be for the 0.02-millimeter particle, is 0.00096 feet per second. (This particle size is recommended. The local jurisdiction may select another particle size based upon the efficiency desired.)
9. The basin configuration shall be such that the length is greater than or equal to the width.

Basins constructed with length-to-width ratios ranging from 1:1 to 9:1 shall have a baffle constructed anywhere from near the inlet to the basin to mid-way to the riser. This baffle shall divert the inflow evenly across the width of the basin. The basin dimensions necessary to obtain the required volume and configuration shall be clearly shown on the plans. (See Appendix D for further details.)

10. The combined capacities of the riser or principal spillway and the emergency spillway shall be sufficient to pass the peak rate of runoff from a storm size commensurate with the degree of protection desired.
11. Sediment basins shall be cleaned out when the storage volume is full. Unexpected high-intensity storms can generate higher quantities of sediment than predicted by the Universal Soil Loss Equation. Therefore, sediment basins shall be inspected for cleanout after every major storm.

This cleanout shall restore the sediment basin to its original design volume. The elevation corresponding to the maximum allowable sediment level shall be determined, shall be stated in the design data as a distance below the top of riser, and shall be clearly marked on the riser. In no case shall this sediment level be less than 2 feet below the top of the riser.

12. The principal spillway shall consist of a vertical pipe or box-type riser joined with a watertight connection to a pipe extending through the embankment and outlet beyond the downstream toe of the fill. The principal spillway shall meet the following specifications:
 - a. The minimum capacity of the principal spillway shall be equal to the peak flow expected from the design storm. For those basins with no emergency spillway, the principal spillway shall have the capacity to handle the peak flow from a rainfall event commensurate with the degree of hazard involved. The minimum diameter of the pipe shall be 8 inches. (See Appendix D for principal spillway sizes and capacities.)
 - b. When used in combination with an emergency spillway, the crest elevation of the riser shall be 1 foot below the elevation of the control section of the emergency spillway.
 - c. The riser shall be completely watertight and shall not have any holes, leaks, rips or perforations, except for the inlet opening at the top and a dewatering opening.
 - d. Means for dewatering the settling zone shall be included in the sediment basin plans submitted for approval, and shall be installed during construction of the basin.

Dewatering shall be done in such a manner as to remove the relatively clean water without removing any of the sediment that has settled out and without removing any appreciable quantities of floating debris. Usually the settling zone may be dewatered by making a hole in the riser unless otherwise required by the approving agency. This hole shall not be larger than 4 inches in diameter and the lower edge of the hole shall not be lower than the required sediment-cleanout elevation. (For other methods of automatically dewatering the settling zone see Appendix D.)

The sediment itself will have a high water content, to the point of being "soupy." Dewatering the sediment is not required but does facilitate cleanout of the basin and provides a public safety factor. The only practical means of dewatering the sediment is by the use of an underdrain. (Details of an acceptable underdrain system are given in Appendix D.)

- e. A concentric anti-vortex device and trash rack shall be securely installed on top of the riser (see Appendix D).
- f. A base with sufficient weight to prevent flotation of the riser shall be attached to the rise with a watertight connection. Two approved bases for risers 10 feet or less in height are:
 - concrete base 18 inches thick with the riser imbedded 6 inches in the base;
 - 1/4-inch minimum thickness steel plate attached to the riser by a continuous weld around the circumference of the riser to form a watertight connection. The plate shall have 2.5 feet of stone, gravel or tamped earth placed on it to prevent flotation.

In either case, each side of the square base shall be twice the riser diameter. For risers higher than 10 feet, computations shall be made to check flotation. The minimum safety factor shall be 1.25 (downward forces = 1.25 x upward forces).

- g. Anti-seep collars shall be installed around the pipe conduit within the normal saturation zone to increase the seepage length at least 10% when any of the following conditions exist:
 - the settled height of dam exceeds 10 feet;
 - the embankment material has a low silt-clay content (Unified Soil Classes SM or GM) and the pipe diameter is 10 inches or greater.

The phreatic line may be approximated with a line drawn downward on a 4:1 slope from the intersection of the normal pool (corresponding to the top of the riser and the upstream face of the embankment.) The seepage length is the length of the flow path of a particle of water along the conduit from the riser to the point of intersection between the approximate phreatic line and the invert of the pipe conduit. When anti-seep collars are used, the equation for revised seepage length becomes:

$$L_s + 2nV \geq 1.1 L_s \quad \text{or} \quad n \geq \frac{.05 L_s}{V}$$

where: L_s is the saturated length of pipe between the riser and the intersection of the phreatic line and the pipe invert, in feet;

n is the number of anti-seep collars;

V is the vertical projection of the collar from the pipe, in feet.

(See Appendix D for anti-seep collar design.)

The anti-seep collar and its connection to the pipe shall be watertight. The anti-seep collar(s) shall be located below the phreatic line in the embankment and should be equally spaced. The maximum spacing, in feet, between collars shall be 14 times the minimum projection of the collar measured perpendicular to the pipe. Collars shall not be located closer than 2 feet to a pipe joint. There shall be sufficient distance between collars to allow passage of hauling and compacting equipment.

- h. An outlet shall be provided, including a means of conveying the discharge in an erosion-free manner to an existing stable stream. Drainage easements shall be obtained if this discharge crosses the property line before reaching the stream. These easements shall be in writing, shall be referenced on the erosion and sediment control plan, and shall be submitted for review along with the erosion and sediment control plan. Protection against scour at the discharge end of the pipe spillway shall be provided. Measures may include impact basin, riprap, revetment, excavated plunge pools, or other approved methods (see Standard and Sample Specifications for Storm Drain Outlet Protection).
13. Emergency spillways shall not be constructed on fill. The emergency spillway cross-section shall be trapezoidal with a minimum bottom width of 8 feet. Emergency spillways shall meet the following specifications:

- (a) The minimum capacity of the emergency spillway shall be that required to pass the peak rate of runoff from a 10-year-frequency storm, or one commensurate with the degree of hazard involved. Emergency spillway dimensions may be determined by using the method in Appendix D.
 - (b) Erosion protection shall be provided by vegetation or other suitable means such as riprap, asphalt or concrete.
 - (c) The velocity of flow in the exit channel shall not exceed 6 feet per second for vegetated channels. For channels with erosion protection other than vegetation, velocities shall be within the nonerosive range for the type of protection used.
 - (d) The freeboard shall be at least 1 foot. Freeboard is the difference between the design high-water elevation in the emergency spillway and the top of the settled embankment. If there is no emergency spillway, it is the difference between the water surface elevation required to pass the design flow through the pipe and the top of the settled embankment.
14. Embankment cross-sections shall be as follows:
- (a) Size 1 basins: The minimum top width shall be 8 feet. The side slopes shall not be steeper than 2:1.
 - (b) Size 2 basins: The minimum top width shall be 10 feet. The side slopes shall not be steeper than 2-1/2:1.
15. Points of entrance of surface runoff into excavated sediment basins shall be protected to prevent erosion. Dikes, swales, grade stabilization structures or other water control devices shall be installed as necessary to ensure direction of runoff and to protect points of entry into the basin. Points of entry should be located so as to ensure maximum travel distance of entering runoff to point of exit from the basin.
16. The sediment basin plans shall indicate the method(s) of disposing of the sediment removed from the basin. The sediment shall be placed in such a manner that it will not erode from the site. The sediment shall not be deposited downstream from the basin or in or adjacent to a stream or flood plain.
- The sediment basin plans shall also show the method of disposing of the sediment basin after the drainage area is stabilized, and shall include the stabilizing of the sediment basin site. Water lying over the trapped sediment shall be removed from the basin by pumping, cutting the top of the riser or other appropriate method prior to removing or breaching the embankment. Sediment shall not be allowed to flush into a stream or drainageway.
17. Sediment basins are attractive to children and can be very dangerous. Therefore they shall be fenced or otherwise made inaccessible to persons or animals unless this is deemed unnecessary due to the remoteness of the site or other circumstances. In any case, local ordinances and regulations regarding health and safety shall be adhered to.

Construction Specifications

1. Areas under the embankment and any structural works shall be cleared, grubbed and stripped of any vegetation and rootmat. In order to facilitate cleanout and restoration, the basin area shall be cleared also.
2. A cut-off trench shall be excavated along the centerline of earth-fill embankments. The minimum depth shall be 2 feet. The cut-off trench shall extend up both abutments to the riser crest elevation. The bottom width shall be wide enough to permit operation of excavation and compaction equipment and a minimum of 4 feet. The side slopes shall be no steeper than 1:1. Compaction requirements shall be the same as those for the embankment. The trench shall be dewatered during the backfilling-compacting operations.
3. Fill material for the embankment shall be taken from approved borrow areas. It shall be clean mineral soil free of roots, woody vegetation, oversized stones, rocks or other objectionable material. Relatively pervious materials such as sand or gravel (Unified Soil Classes GW, GP, SW and SP) shall not be placed in the embankment. Areas on which fill is to be placed shall be scarified prior to placement of fill. The fill material shall contain sufficient moisture so that it can be formed by hand into a ball without crumbling. If water can be squeezed out of the ball, it is too wet for proper compaction. Fill material shall be placed in 6 to 8-inch thick continuous layers over the entire length of the fill. Compaction shall be obtained by routing the hauling equipment over the fill so that the entire surface of each layer of the fill is traversed by at least one wheel or tread track of the equipment, or by the use of a compactor. The embankment shall be constructed to an elevation 10% higher than the design height to allow for settlement if compaction is obtained with hauling equipment. If compactors are used for compaction, the overbuild may be reduced to not less than 5%.
4. The principal spillway riser shall be securely attached to the discharge pipe by welding all around and all connections shall be watertight. The pipe and riser shall be placed on a firm, smooth soil foundation. The connection between the riser and the riser base shall be watertight. Pervious materials such as sand, gravel, or crushed stone shall not be used as backfill around the pipe or anti-seep collars. The fill material around the pipe spillway shall be placed in 4-inch layers and compacted under the shoulders and around the pipe to at least the same density as the adjacent embankment. A minimum of 2 feet of hand-compacted backfill shall be placed over the pipe spillway before crossing it with construction equipment. Steel base plates shall have at least 2-1/2 feet of compacted earth, stone or gravel placed over them to prevent flotation.

5. The emergency spillway shall not be installed in fill. Elevations, design width, and entrance and exit channel slopes are critical to the successful operation of the emergency spillway.
6. Baffles shall be constructed of 4 x 4-inch posts and 4 x 8-feet x 1/2-inch exterior plywood. The posts shall be set at least 3 feet into the ground, no further apart than 8 feet center to center, and shall reach a height 6 inches below the riser crest elevation. The plywood shall be securely fastened to the upstream side of the posts.
7. The embankment and emergency spillway shall be stabilized with vegetation immediately following construction (see Standard and Sample Specifications for Planting of Exposed Soils).
8. Construction operations shall be carried out in such a manner that erosion and water pollution will be minimized. State and local laws concerning pollution abatement shall be complied with.
9. State and local requirements shall be met concerning fencing and signs warning the public of hazards of soft sediment and floodwater.
10. Maintenance and repairs shall be carried out as follows:
 - (a) All damages caused by soil erosion or construction equipment shall be repaired before the end of each working day.
 - (b) Sediment shall be removed from the basin when it reaches the specified distance below the top of the riser. This sediment shall be placed in such a manner that it will not erode from the site. The sediment shall not be deposited downstream from the embankment or in or adjacent to a stream or floodplain.
11. When temporary structures have served their intended purpose and the contributing drainage area has been properly stabilized, the embankment and resulting sediment deposits shall be leveled or otherwise disposed of in accordance with the approved erosion and sediment control plan.

Information To Be Submitted For Approval

Sediment basin designs and construction plans submitted to the reviewing agency shall include the following:

- specific location of the dam;
- plan view of dam, storage basin and emergency spillway;

- cross-section of dam, principal spillway and emergency spillway;
- profile of emergency spillway;
- details of pipe connections, riser-to-pipe connection, riser base, anti-seep collars, trash rack and anti-vortex device.
- runoff calculations for 10-year-frequency storm.
- storage calculations including total volume required, total volume available, and level of sediment at which cleanout shall be required (stated as a distance from the riser crest to the sediment surface);
- calculations showing design of pipe and emergency spillway.

(Note: Runoff, storage and design calculations may be submitted using the design data sheet shown in Appendix D.)

Sources and References

1. These sample specifications were based on U.S. Department of Agriculture, Soil Conservation Service, Standards and Specifications for Soil Erosion and Sediment Control in Developing Areas, July 1975. Modifications were made by ABAG for simplification and clarity and to reflect the surface area of the basin as a principal design criterion.
2. U.S. Environmental Protection Agency, Erosion and Sediment Control, Surface Mining in the Eastern U.S., Technology Transfer Series, October 1976.

7. TEMPORARY SEDIMENT TRAP

STANDARD

Definition

A small temporary basin formed by excavation and/or construction of an embankment.

Purpose

A sediment trap can be installed in a drainageway, at a storm drain inlet or at points of discharge from a disturbed area to intercept sediment-laden runoff and trap the sediment. It thus protects downstream drainageways, properties and rights-of-way from sedimentation.

This standard applies to all temporary sediment traps with a drainage area of less than 5 acres. (For traps that exceed the limits of this standard, see the Standard and Sample Specifications for Sediment Basins.)

Design Considerations

Design considerations should include the following:

- drainage area;
- design capacity;
- cleanout intervals;
- embankment and/or excavation specifications;
- outlet;
- compatibility with existing topography;
- soil erodibility, settleability and accumulation rate.

The fundamental difference between sediment traps and sediment basins is the size of the contributing drainage area. Sediment traps serve a small area, under five acres, and can be adequately sized using the criteria of 260 square feet of surface area per acre of watershed. The savings that may accrue from constructing a smaller sediment trap may not be large enough to justify the engineering needed to substantiate the smaller size. On a small construction site, a larger, designed sediment basin is not likely to achieve significantly more sediment capture than a sediment trap. However, even for a small site, if the capture of fine soil particles is essential, a carefully designed sediment basin should be used.

Unit Cost Guide

\$500.00-\$2,000.00 (as of fall 1979), depending on size, local topography and the base material.

Source and Reference

This standard was prepared from materials furnished by staff of the USDA, Soil Conservation Service and modified by ABAG to reflect the surface area of the basin as a principal design criterion.

SAMPLE SPECIFICATIONS FOR TEMPORARY SEDIMENT TRAP

Design Specifications

1. The drainage area for a sediment trap shall be less than 5 acres.

The sediment trap should be located to obtain the maximum storage benefit from the terrain, for ease of cleanout of the trapped sediment, and to minimize interference with construction activities.
2. The surface area of a sediment trap as measured at the elevation of the crest of the outlet shall be at least 260 square feet per acre of drainage area with a minimum trap depth of 2 feet. For deeper traps accommodating more sediment storage, the surface area requirement shall not be decreased.
3. Sediment shall be removed and the trap restored to its original dimensions when the sediment has accumulated to within one foot of the outlet elevation. Sediment removed from the trap shall be deposited in a suitable area and in such manner that it will not erode.
4. All embankments for sediment traps shall not exceed 5 feet in height as measured at the low point of the original ground along the centerline of the embankment. The top width of the embankments shall be a minimum of 4 feet, and the side slopes shall be 2:1 or flatter. The embankment shall be compacted by traversing with equipment while it is being constructed. Equipment shall compact at least 90% of the surface area.
5. All excavation operations shall be carried out in such a manner that erosion and water pollution shall be minimal. Any excavated portion of the sediment trap shall have 2:1 or flatter slopes.
6. Outlets shall be designed, constructed and maintained in such a manner that settled sediment does not leave the trap and that erosion of the outlet does not occur. A trap may have several different outlets with each outlet conveying part of the flow. The combined outlet capacity shall meet the criteria in No.'s 7, 8 and 9 below. For example, an earth outlet 12 feet wide (adequate for 2 acres) and a 12-inch pipe outlet (adequate for 1 acre) could be used for a 3-acre drainage area.
7. If the sediment trap uses an earth outlet, the outlet width (feet) shall be equal to six times the drainage area (acres). If an embankment is used, the outlet crest shall be at least 1 foot below the top of the embankment. The outlet shall be free of any restriction to flow. (See sample drawing of earth outlet sediment trap for details.)

8. If the sediment trap uses a pipe outlet, the outlet pipe and riser shall be made of corrugated metal. The riser diameter shall be greater than or equal to the pipe diameter. The top of the embankment shall be at least 1-1/2 feet above the crest of the riser. At least the top two-thirds of the riser shall be perforated with 1/2-inch diameter holes spaced 8 inches vertically and 10 to 12 inches horizontally. All pipe connections shall be watertight.

Pipe diameter shall be selected from the following table:

| <u>Min. Pipe Diameter (inches)</u> | <u>Max. Drainage Area (acres)</u> |
|--|---------------------------------------|
| 12 | 1 |
| 18 | 2 |
| 21 | 3 |
| 24 | 4 |
| 30 | 5 |

(Note: These pipe size specifications are examples only. The pipe dimensions for each project should be calculated by a qualified engineer based on local conditions.)

(See sample drawing of pipe outlet sediment trap for details.)

9. If the sediment trap uses a crushed stone outlet, the outlet will be over a level stone section. The stone outlet for a sediment trap differs from that for a stone outlet structure because of the intentional ponding of water in the trap. To provide for a ponding area, a relatively impervious core, such as timber, concrete block or straw bales is placed in the stone. The core shall be covered by 6 inches of stone.

The minimum length (feet) of a stone outlet shall be equal to six times the drainage area (acres). The crest of the outlet, at the top of the stone, shall be at least 1 foot below the top of the embankment. The crushed stone used in the outlet shall meet AASHTO M43, size No. 2 or 24, or its equivalent such as MSHA No. 2. Gravel meeting the above gradation may be used if crushed stone is not available. (See sample drawing of stone outlet sediment trap for details.)

10. If the sediment trap uses a storm drain inlet as its outlet, the storm drain and inlet should be placed so as not to interfere with construction activities. (See sample drawing of storm drain inlet sediment trap for details.)

Construction Specifications

1. The area under the embankment shall be cleared, grubbed and stripped of any vegetation and root mat. The pool area shall be cleared.
2. The fill material for the embankment shall be free of roots or other woody vegetation as well as oversized stones, rocks, organic material or other objectionable material. The embankment shall be compacted by traversing with equipment while it is being constructed.
3. Sediment shall be removed and the trap restored to its original dimensions when the sediment has accumulated to within one foot of the outlet elevation. Removed sediment shall be deposited in a suitable area and in such a manner that it will not erode.
4. The structure shall be inspected after each rain and repairs made as needed.
5. Construction operations shall be carried out in such a manner that erosion and water pollution are minimized.
6. The structure shall be removed and the area stabilized when the remaining drainage area has been properly stabilized.
7. All cut-and-fill slopes shall be 2:1 or flatter.
8. When a riser is used, all pipe joints shall be watertight.
9. When a riser is used, at least the top two-thirds of the riser shall be perforated with 1/2-inch-diameter holes spaced 8 inches vertically and 10 to 12 inches horizontally.
10. When a pipe outlet is used, fill material around the pipe spillway shall be hand-compacted in 4-inch layers. A minimum of 1.5 feet of hand-compacted backfill shall be placed over the pipe spillway. At least 2 feet of backfill shall be placed if construction equipment will cross over the pipe spillway.
11. When an earth or stone outlet is used, outlet crest elevation shall be at least 1 foot below the top of the embankment. Pipe outlets shall be at least 1.5 feet below the top of the embankment.
12. When a crushed stone outlet is used, the crushed stone used in the outlet shall meet AASHTO M43, size No. 2 or 24, or its equivalent such as MSHA No. 2. Gravel meeting the above gradation may be used if crushed stone is not available. Crusher run is not acceptable.

Source and Reference

These sample specifications were prepared from materials furnished by staff of the USDA, Soil Conservation Service and modified by ABAG to reflect the surface area of the trap as a principal design criterion.

Sample Drawing: Earth Outlet Sediment Trap*

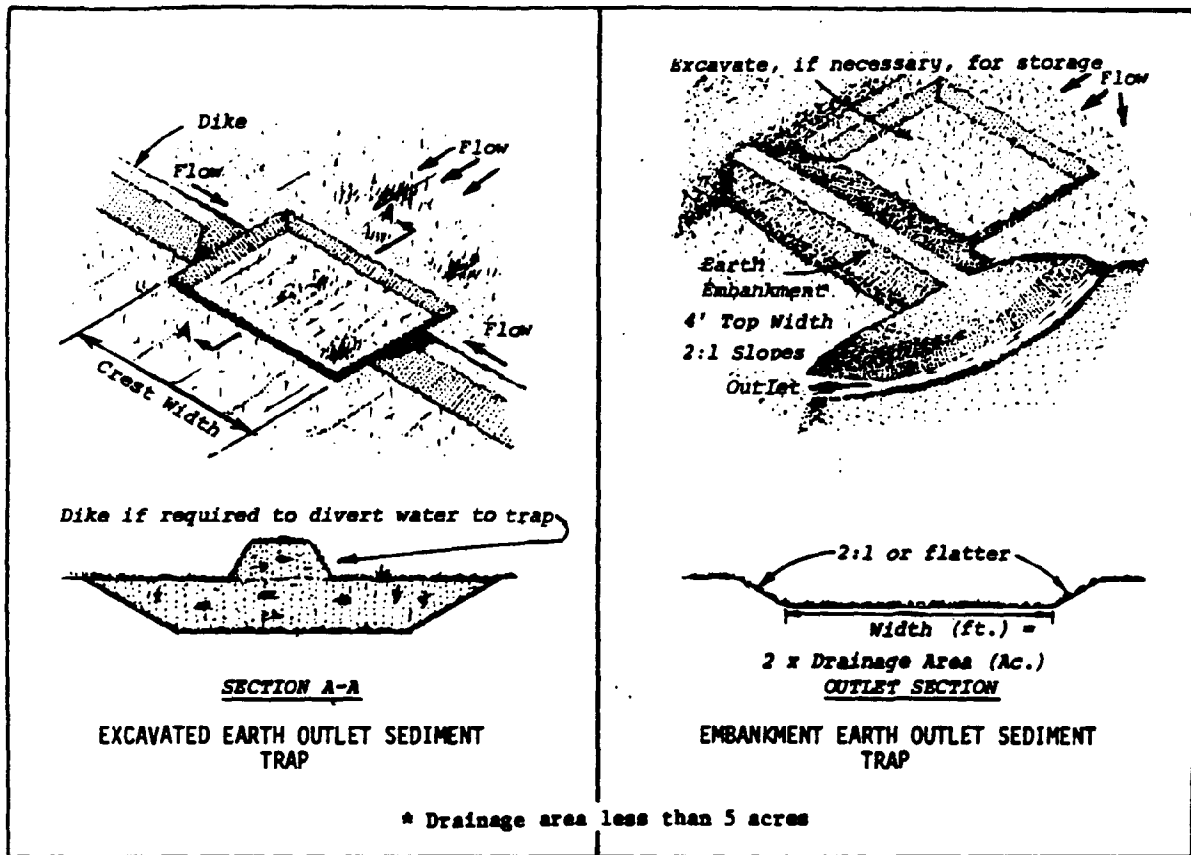

(adapted from USDA, Soil Conservation Service, College Park, Maryland. Standards and Specifications for Soil Erosion and Sediment Control in Developing Areas. July 1975.)

Sample Drawing: Pipe Outlet Sediment Trap*

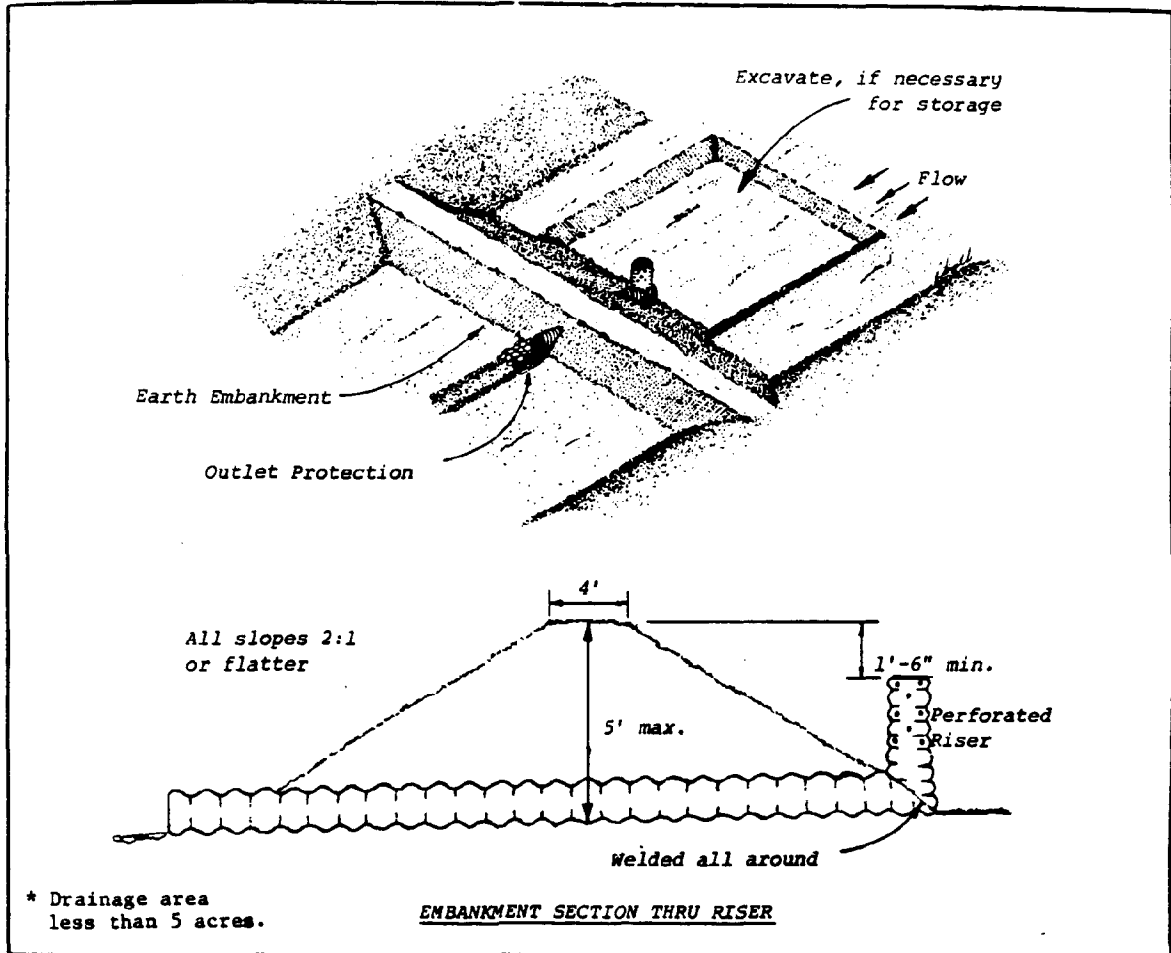

(adapted from USDA, Soil Conservation Service, College Park, Maryland. Standards and Specifications for Soil Erosion and Sediment Control in Developing Areas. July 1975.)

Sample Drawing: Stone Outlet Sediment Trap*

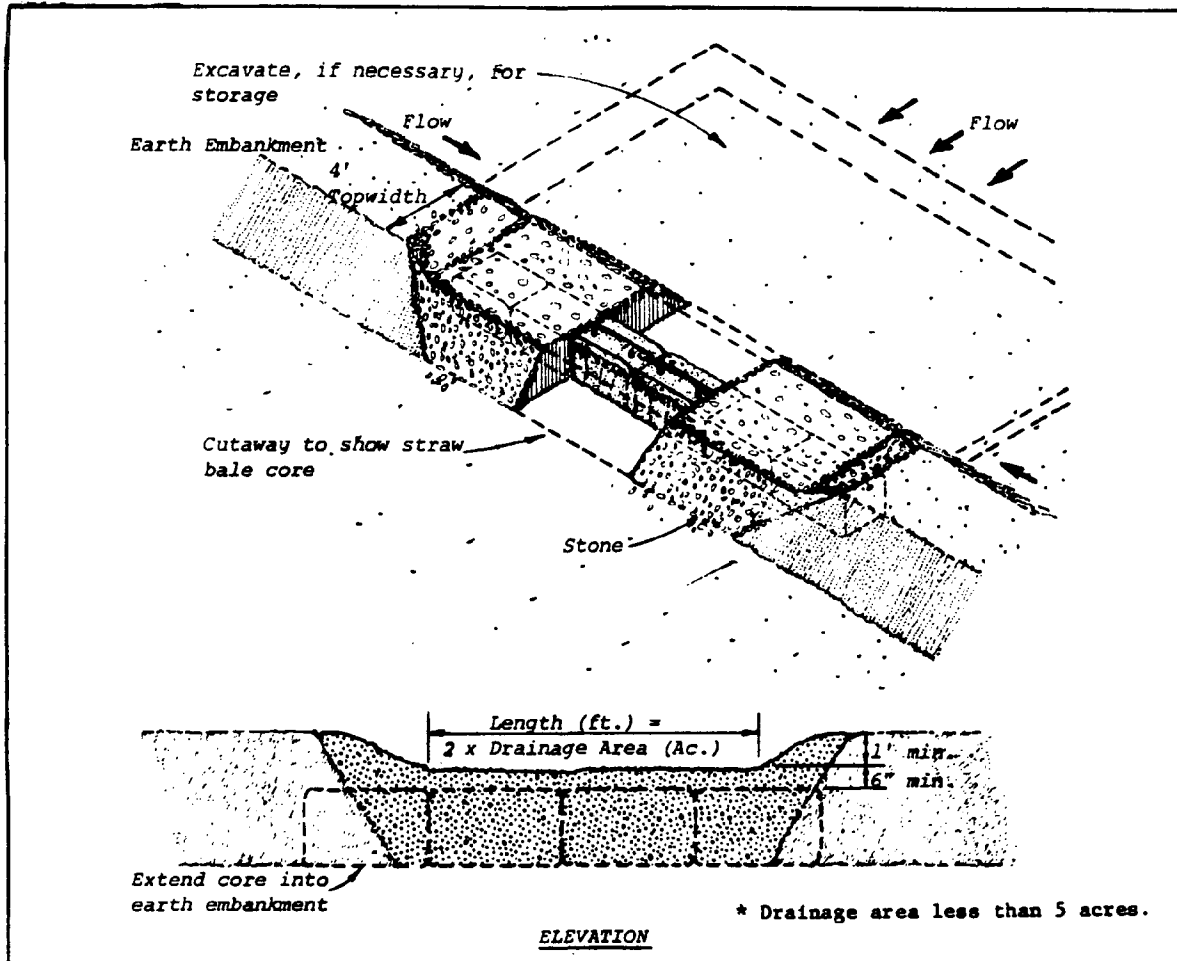

(adapted from USDA, Soil Conservation Service, College Park, Maryland. Standards and Specifications for Soil Erosion and Sediment Control in Developing Areas. July 1975.)

Sample Drawing: Storm Inlet Sediment Trap*

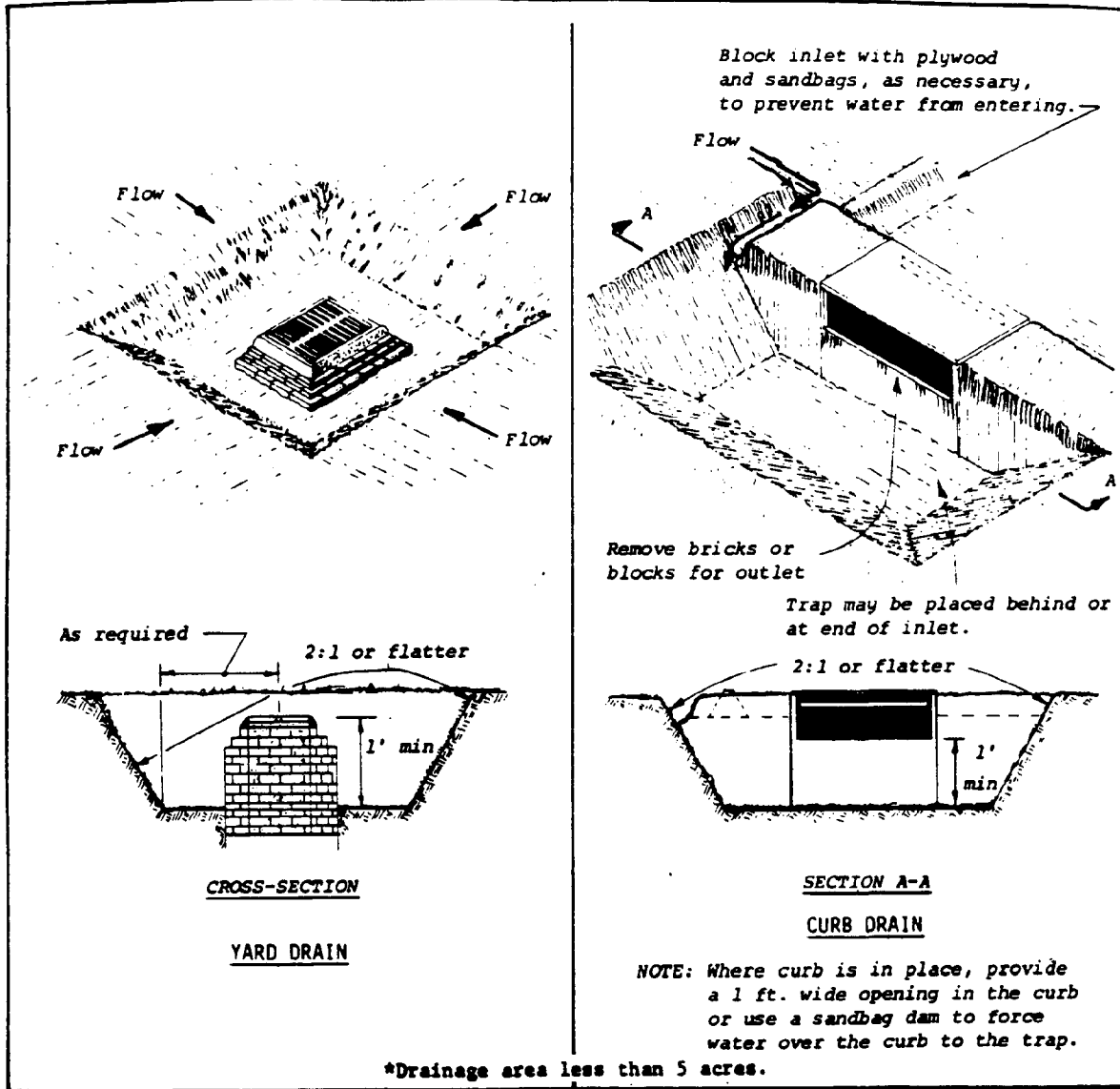

(adapted from USDA, Soil Conservation Service, College Park, Maryland. Standards and Specifications for Soil Erosion and Sediment Control in Developing Areas. July 1975.)

July 1980

8. TEMPORARY STABILIZED CONSTRUCTION ENTRANCE

STANDARD

Definition

A stabilized pad of crushed stone located at any point where traffic enters or leaves a construction site at a public right-of-way, street, alley, sidewalk or parking area.

Purpose

A construction entrance reduces or eliminates the tracking or flowing of sediment onto public rights-of-way.

This standard applies to all temporary stabilized construction entrances that are to be removed within 12 months after the completion of construction.

Design Considerations

Design considerations should include the following:

- materials;
- dimensions of the pad;
- maintenance requirements.

Unit Cost Guide

\$4,000-\$5,000 (as of fall 1979).

Source and Reference

This standard was prepared by ABAG, based on materials furnished by staff of the USDA, Soil Conservation Service.

SAMPLE SPECIFICATIONS FOR TEMPORARY STABILIZED CONSTRUCTION ENTRANCE

Design and Construction Specifications

1. The material for construction of the pad shall be 2 to 3 inch stone.
2. The thickness of the pad shall not be less than 8 inches.
3. The width of the pad shall not be less than the full width of all points of ingress or egress.
4. The length of the pad shall be as required, but not less than 50 feet.
5. The entrance shall be maintained in a condition that will prevent tracking or flowing of sediment onto public rights-of-way. This may require periodic top dressing with additional stone as conditions demand, and repair and/or cleanout of any measures used to trap sediment. All sediment spilled, dropped, washed or tracked onto public rights-of-way shall be removed immediately.
6. When necessary, wheels shall be cleaned to remove sediment prior to entrance onto public rights-of-way. When washing is required, it shall be done on an area stabilized with crushed stone that drains into an approved sediment trap or sediment basin. All sediment shall be prevented from entering any storm drain, ditch or watercourse through use of sand bags, gravel, boards or other approved methods.

Source and Reference

These sample specifications were prepared based on materials furnished by staff of the USDA, Soil Conservation Service and modified by ABAG for simplification and clarity.

Sample Drawing: Stabilized Construction Entrance

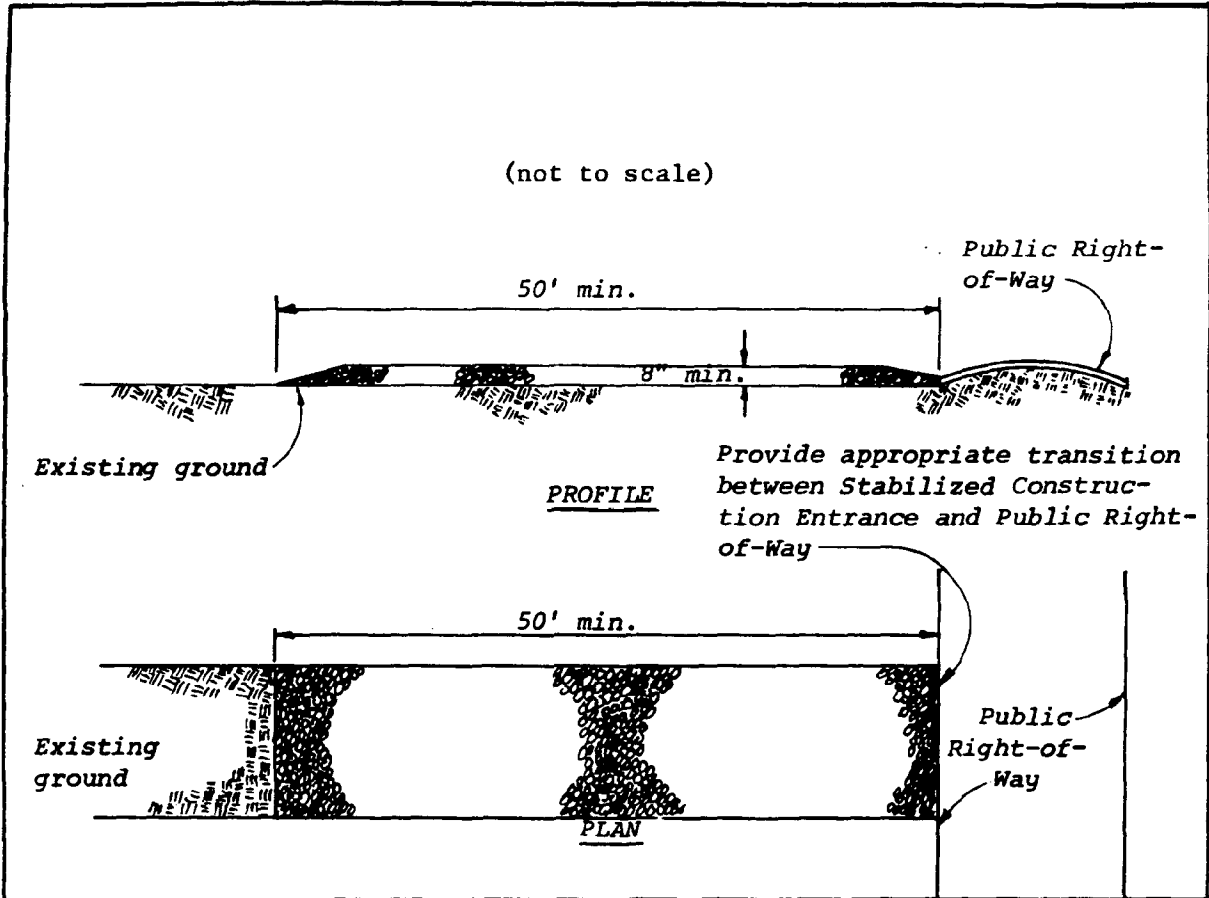

(adapted from USDA, Soil Conservation Service, College Park, Maryland. Standards and Specifications for Soil Erosion and Sediment Control in Developing Areas. July 1975.)

9. TEMPORARY STRAW BALE DIKE

STANDARD

Definition

A temporary barrier consisting of straw bales installed across or at the toe of a slope.

Purpose

A straw bale dike intercepts and detains small amounts of sediment from limited exposed areas. It is used where all of the following conditions apply:

- the contributing drainage area is less than 1 acre;
- the maximum slope length behind the barrier is 100 feet;
- the maximum slope gradient behind the barrier is 2:1;
- sheet and rill erosion would occur;
- there is, above the barrier, no concentration of water in a channel or swale draining an area in excess of 2 acres (in this instance, a straw bale dike may serve as a check dam and the bales must be properly staked to the ground);
- no other practice is feasible.

This standard applies to all straw bale dikes that are to be removed within three months after the completion of construction.

Design Considerations

A formal design is not required. Bales are placed on the contour and are either wire-bound or nylon string-tied and staked in place (see the sample drawing for details). The life expectancy of straw bale dikes, normally three months or less, can be extended when used with filter fabric.

Unit Cost Guide

\$2.00 per linear foot (as of fall 1979).

Source and Reference

This standard was prepared by ABAG based on Virginia Soil and Water Conservation Commission, Virginia Erosion and Sediment Control Handbook, 1980.

June 1981

SAMPLE SPECIFICATIONS FOR TEMPORARY STRAW BALE DIKE

Construction Specifications

1. Bales shall be placed in a row with ends tightly abutting.
2. Each bale shall be embedded in the soil a minimum of 4 inches.
3. Bales shall be securely anchored in place by two stakes or re-bars driven through the bales. The first stake in each bale shall be driven toward the previously laid bale to force bales together.
4. The dike shall be inspected after each storm, and repair or replacement shall be made promptly as needed.
5. Bales shall be removed when they have served their purpose so as not to block or impede storm flow or drainage.

Source and Reference

These sample specifications were prepared based on materials furnished by staff of the USDA, Soil Conservation Service and modified by ABAG for simplification and clarity.

Sample Drawing: Straw Bale Dike*

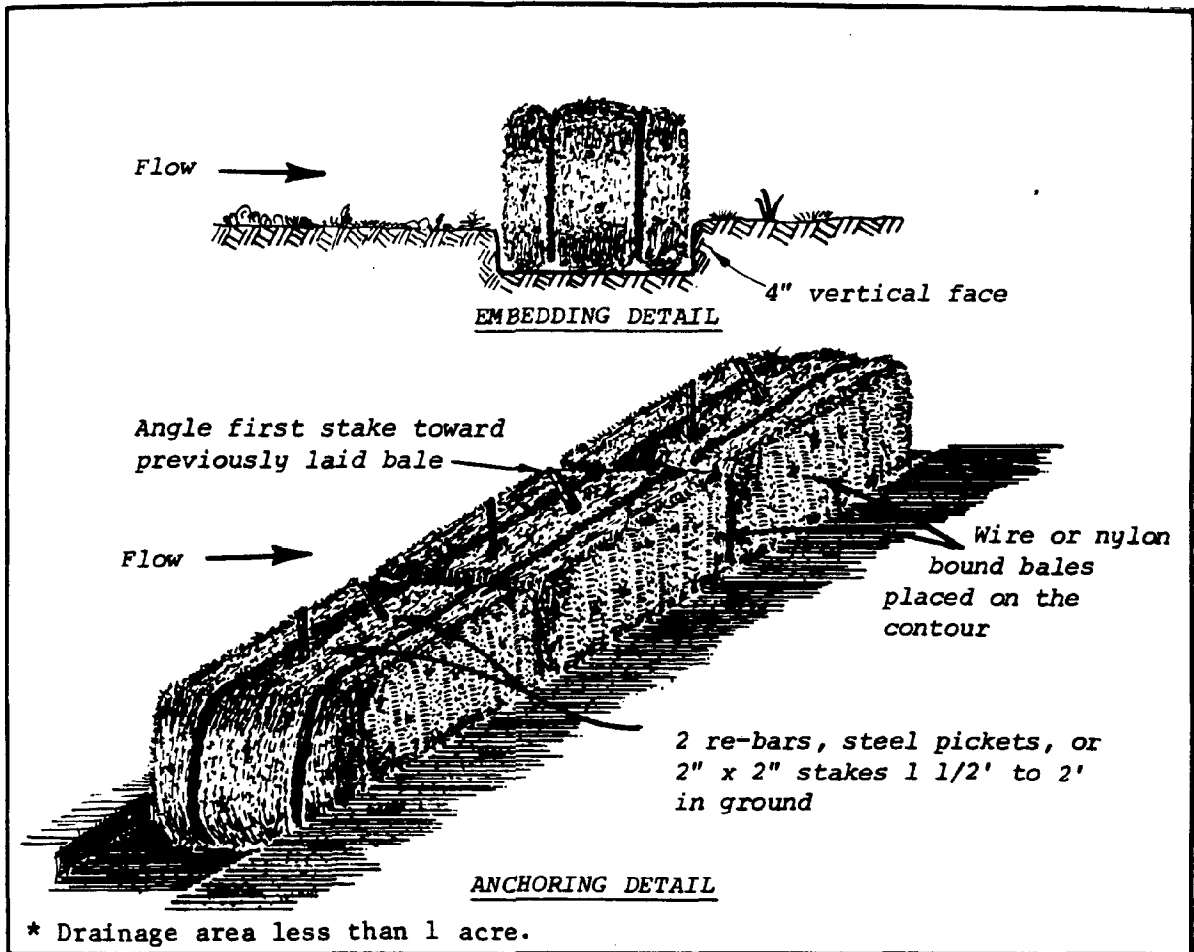

(adapted from USDA, Soil Conservation Service, College Park, Maryland. Standards and Specifications for Soil Erosion and Sediment Control in Developing Areas. July 1975.)

10. TEMPORARY SILT FENCE

STANDARD

Definition

A temporary sediment barrier consisting of filter fabric and wire mesh attached to supporting posts and entrenched.

Purpose

A silt fence intercepts and detains sediment while decreasing the velocity of runoff. Its principal mode of action is to slow the water and allow particles to settle. It can be used where:

- sheet and rill erosion would occur;
- protection of adjacent property or areas beyond the limits of grading is needed;
- the size of the drainage area is no more than 1 acre;
- the maximum slope length behind the barrier is 100 feet;
- the maximum slope gradient behind the barrier is 2:1;
- small swales or ditches are carrying silt, flows do not exceed 1 cubic foot per second and the drainage area is no greater than 2 acres;
- no practice other than a silt fence is feasible.

Design Considerations

No formal design is required. Silt fences have a useful life of one season. Their use is limited to situations in which sheet or overland flows are expected. They normally cannot filter the volumes generated by channel flows. When installed across a concentrated flow path, undercutting of the fence often occurs. Design considerations include:

- type, size and spacing of fence posts;
- type of filter cloth;
- size of woven wire support fence;
- method of anchoring filter cloth.

Unit Cost Guide

\$4.00-\$6.00 per linear foot (as of fall 1979).

Sources and References

This standard was prepared by ABAG based on the following sources:

1. Abel, Phillip E., Landscape Architect, Martinez, California.
2. Sherwood, W. Cullen and David C. Wyant, Installation of Straw and Fabric Filter Barriers for Sediment Control (a paper prepared for the Annual Meeting of the Transportation Research Board, Washington, D.C.), January 1979.
3. U.S. Department of Agriculture, Soil Conservation Service, College Park, Maryland.
4. Virginia Soil and Water Conservation Commission, Virginia Erosion and Sediment Control Handbook, 1980.

SAMPLE SPECIFICATIONS FOR SILT FENCE

Materials

1. Filter fabric shall be a pervious sheet of synthetic polymer composed of at least 85% by weight ethylene, propylene, amide, ester or vinylidene yarn, woven or non-woven, and shall contain stabilizers and/or inhibitors to resist deterioration by heat, water and ultra-violet light. The fabric shall conform to the following criteria:
 - (a) The Equivalent Opening Size (U.S. Standard Sieve) shall be within the range 70-100.
 - (b) The tensile strength (ASTM D1682G) shall be at least 120 pounds. The strength of fabric required depends on the wire support fence. The strength given is the minimum for a 6-inch square mesh wire support fence. If extra-strength fabric is used without a support fence, the strength required shall be 200 pounds minimum with posts spaced on 6 foot centers.
2. Posts for silt fences shall be either 4-inch-diameter wood or 1.33-pounds-per linear foot steel with a minimum length of 5 feet. Steel posts shall have projections for fastening wire to them.
3. Wire fence reinforcement for silt fences shall be a minimum of 42 inches in height, shall be a minimum of 14-gauge, and shall have a maximum mesh spacing of 6 inches.

Construction Specifications

1. The height of a silt fence shall not exceed 36 inches. On slopes, the fence line shall follow the contour as closely as possible. In small swales, the fence line shall be curved upstream at the sides to direct the flow toward the middle of the fence.
2. If possible, the filter fabric shall be cut from a continuous roll to avoid the use of joints. When joints are necessary, filter cloth shall be spliced only at a support post, with a minimum 6-inch overlap and both ends securely fastened to the post.
3. Posts shall be spaced a maximum of 10 feet apart and driven securely into the ground (minimum of 12 inches). When extra-strength fabric is used without the wire support fence, post spacing shall not exceed 6 feet.
4. A trench shall be excavated approximately 4 inches wide and 4 inches deep along the line of posts and upslope from the barrier.

5. When standard-strength filter fabric is used, a wire mesh support fence shall be fastened securely to the upslope side of the posts using heavy duty wire staples at least 1 inch long, tie wires or hog rings. The wire shall extend into the trench a minimum of 2 inches and shall not extend more than 36 inches above the original ground surface.
6. The standard-strength filter fabric shall be stapled or wired to the fence, and 8 inches of the fabric shall extend into the trench. The fabric shall not extend more than 36 inches above the original ground surface. Filter fabric shall not be stapled to existing trees.
7. When extra-strength filter fabric and closer post spacing are used, the wire mesh support fence may be eliminated. In such a case, the filter fabric is stapled or wired directly to the posts with all other provisions of No. 6 above applying.
8. The trench shall be backfilled and the soil compacted over the toe of the filter fabric.
9. Silt fences shall be removed when they have served their useful purpose, but not before the upslope area has been permanently stabilized.

Maintenance

1. Silt fences and filter barriers shall be inspected immediately after each rainfall and at least daily during prolonged rainfall. Any required repairs shall be made immediately.
2. Should the fabric on a silt fence or filter barrier decompose or become ineffective prior to the end of the barrier's expected usable life and the barrier still be necessary, the fabric shall be replaced promptly.
3. Sediment deposits should be removed when deposits reach approximately one-half the height of the barrier.
4. Any sediment deposits remaining in place after the silt fence or filter barrier is no longer required shall be dressed to conform with the existing grade, prepared and seeded.

Sources and References

These sample specification were prepared by ABAG based on the following sources:

1. Abel, Phillip E., Landscape Architect, Martinez, California.
2. McMillian, Michael, Selection of Filter Fabric for Use in Silt Fences, ABAG Water Quality Technical Memorandum No. 63, 1981.

3. Ruggeri, Peter, Bissell and Karn Civil Engineers, 1981.
4. Sherwood, W. Cullen and David C. Wyant, Installation of Straw and Fabric Filter Barriers for Sediment Control, (a paper prepared for the Annual Meeting of the Transportation Research Board, Washington, D.C.), January 1979.
5. U.S. Army, Corps of Engineers Civil Works Construction Guide Specification for Plastic Filter Fabrics, 1977.
6. U.S. Department of Agriculture, Soil Conservation Service, College Park, Maryland.
7. Virginia Soil and Water Conservation Commission, Virginia Soil Erosion and Sediment Control Handbook, 1980.

Sample Drawing: Silt Fence

1. Set posts and excavate a 4"x4" trench upslope along the line of posts.

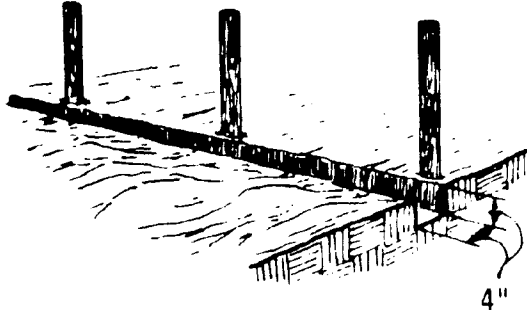

2. Staple wire fencing to the posts.

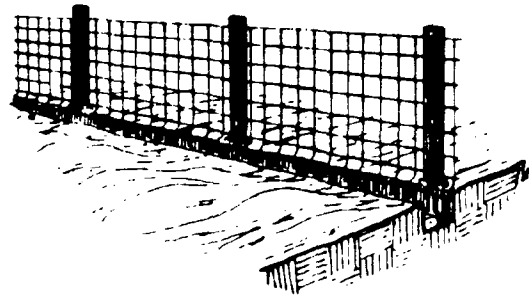

3. Attach the filter fabric to the wire fence and extend it into the trench.

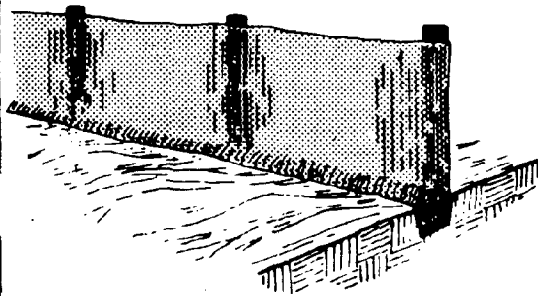

4. Backfill and compact the excavated soil.

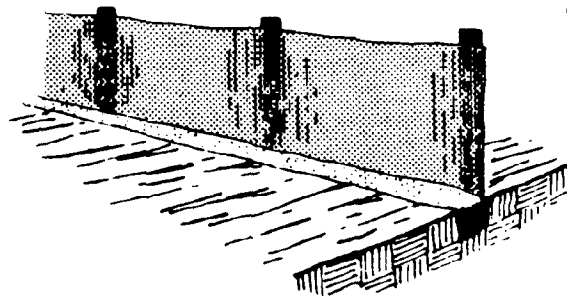

Extension of fabric and wire into the trench.

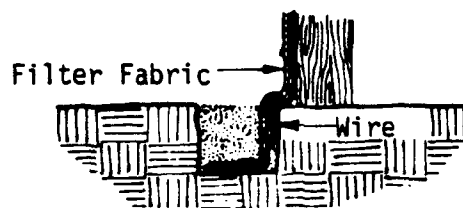

CONSTRUCTION OF A SILT FENCE

(Adapted from Virginia Soil and Water Conservation Commission, Virginia Erosion and Sediment Control Handbook, 1980.)

11. TEMPORARY CHECK DAM

STANDARD

Definition

A small temporary dam constructed across a swale, drainage ditch or other small water flow area.

Purpose

A check dam reduces the velocity of concentrated stormwater flows and thus reduces erosion of the swale or ditch. It also traps small amounts of sediment flowing in the ditch. However, a check dam is not a sediment-trapping device and should not be used for this purpose.

Check dams are used in small, open channels that drain 10 acres or less. They should not be used in perennial streams. Some specific applications include:

- temporary ditches or swales that, because of their short length of service, cannot receive a nonerodible lining but that still need some protection to reduce erosion;
- permanent waterways that for some reason cannot receive a permanent nonerodible lining for an extended period of time;
- either temporary or permanent swales or waterways that need protection during the establishment of grass linings.

Design Considerations

An engineered design is not required for check dams. The following criteria should be considered:

- materials (check dams can be constructed of stone, sand bags, straw bales, logs and other materials);
- drainage area;
- height;
- sediment removal;
- maintenance;
- dam removal.

Check dams must be removed when their useful life has been completed. In temporary ditches and swales, check dams should be removed and the ditch filled in when it is no longer needed. In permanent structures, check dams should be removed when a permanent lining can be installed. In grass-lined ditches, check dams should be removed when the grass has matured sufficiently to protect the ditch or swale. The area beneath

the check dams should be seeded and mulched immediately after they are removed. If stone check dams are used in grass-lined drainageways that will be mowed, care should be taken to remove all the stone from the dam when the dam is removed, including any stone that has washed downstream.

Unit Cost Guide

Variable, depending on material used and availability of material on the site.

Source and Reference

This standard was prepared by ABAG based on Virginia Soil and Water Conservation Commission, Virginia Erosion and Sediment Control Handbook, 1980.

SAMPLE SPECIFICATIONS FOR CHECK DAM

Design Specifications

No formal design is required for a check dam; however, the following criteria shall be adhered to when using check dams:

1. The drainage area of the ditch or swale being protected shall not exceed 2 acres for straw bale check dams and 10 acres for all other check dams. The maximum height of the check dam shall be 2 feet. The center of the check dam shall be at least 6 inches lower than its outer edges. The cross-section of the dam shall be as shown in the sample drawings for log and stone check dams. The maximum spacing between the dams shall be such that the toe of the upstream dam is at the same elevation as the top of the downstream dam, as illustrated below.

SPACING BETWEEN CHECK DAMS

L = The distance such that points
A and B are of equal elevation

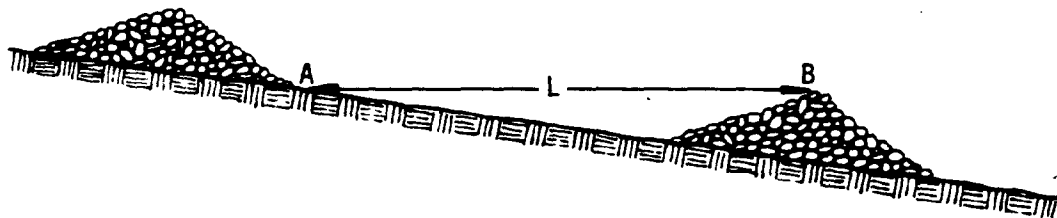

(adapted from Virginia Soil and Water Conservation Commission, Virginia Erosion and Sediment Control Handbook, Richmond, Virginia, 1980.)

2. Stone check dams shall be constructed of 2- to 3-inch stone. The stone shall be placed according to the configuration in the sample drawing. Hand or mechanical placement will be necessary to achieve complete coverage of the ditch or swale and to insure that the center of the dam is lower than the edges.

3. Log check dams shall be constructed of 4- to 6-inch logs salvaged from clearing operations on site, if possible. The logs shall be embedded into the soil at least 18 inches. The 6-inch lower height required at the center can be achieved either by careful placement of the logs or by cutting the logs after they are in place.
4. Straw bale check dams shall be constructed as follows:
 - (a) Bales shall be placed in a single row, lengthwise, oriented perpendicular to the contour, with ends of adjacent bales tightly abutting one another.
 - (b) The barrier shall be extended to such a length that the bottoms of the end bales are higher in elevation than the top of the lowest middle bale to assure that sediment-laden runoff will flow either through or over the barrier but not around it.
 - (c) Except as stated in (a) and (b) above, straw bale check dams shall be constructed according to the Sample Specifications for Straw Bale Dike.

Proper placement of a straw bale check dam is illustrated below:

PROPER PLACEMENT OF STRAW BALE CHECK DAM IN DRAINAGEWAY

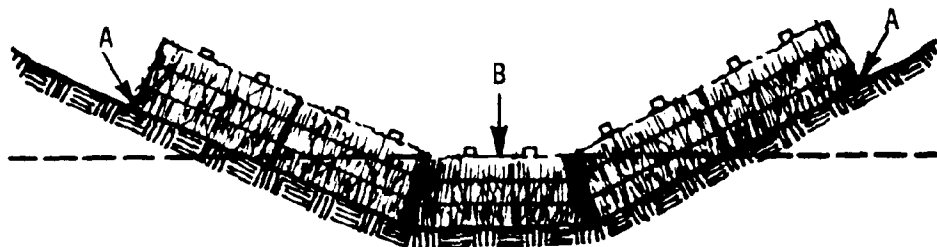

Points A should be higher than point B

(adapted from Virginia Soil and Water Conservation Commission, Virginia Erosion and Sediment Control Handbook, Richmond, Virginia, 1980.)

5. Check dams shall be checked for sediment accumulation after each significant rainfall. Sediment shall be removed from behind the check dams when it has accumulated to one-half of the original dam height.

6. Regular inspections shall be made to ensure that the center of the dam is lower than the edges. Erosion caused by high flows around the edges of the dam shall be corrected immediately.

Source and Reference

These sample specifications were prepared by ABAG based on Virginia Soil and Water Conservation Commission, Virginia Erosion and Sediment Control Handbook, 1980.

Sample Drawing: Log Check Dam

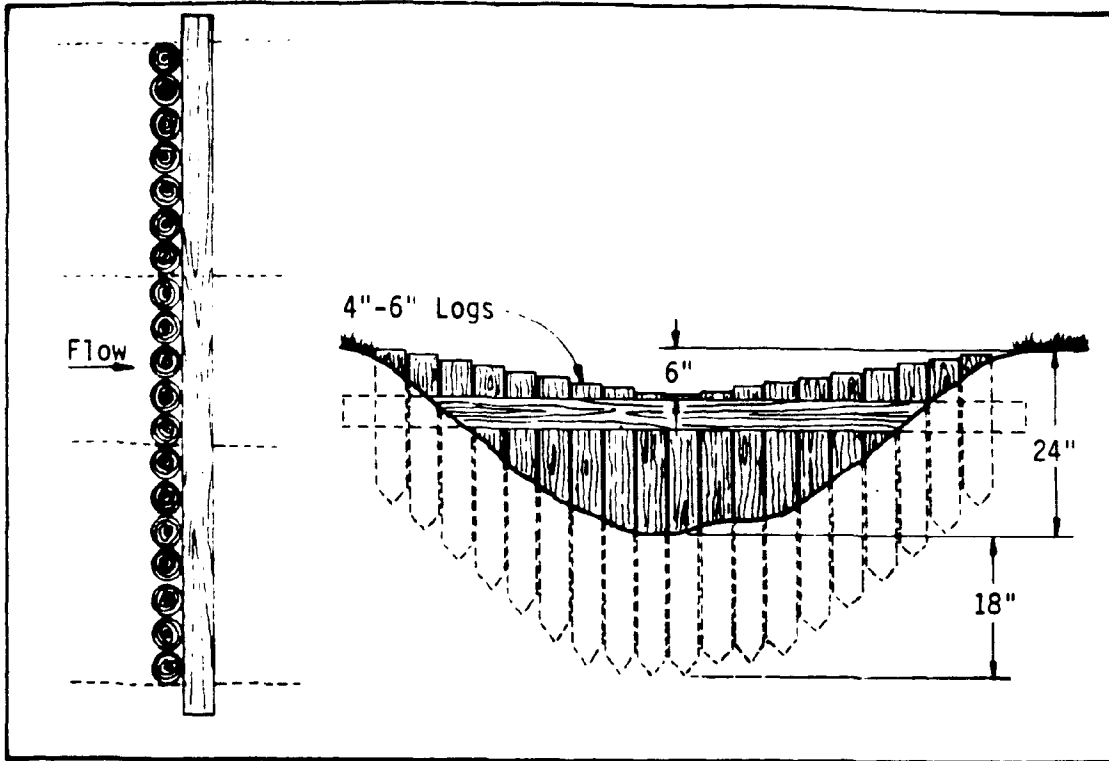

Sample Drawing: Rock Check Dam

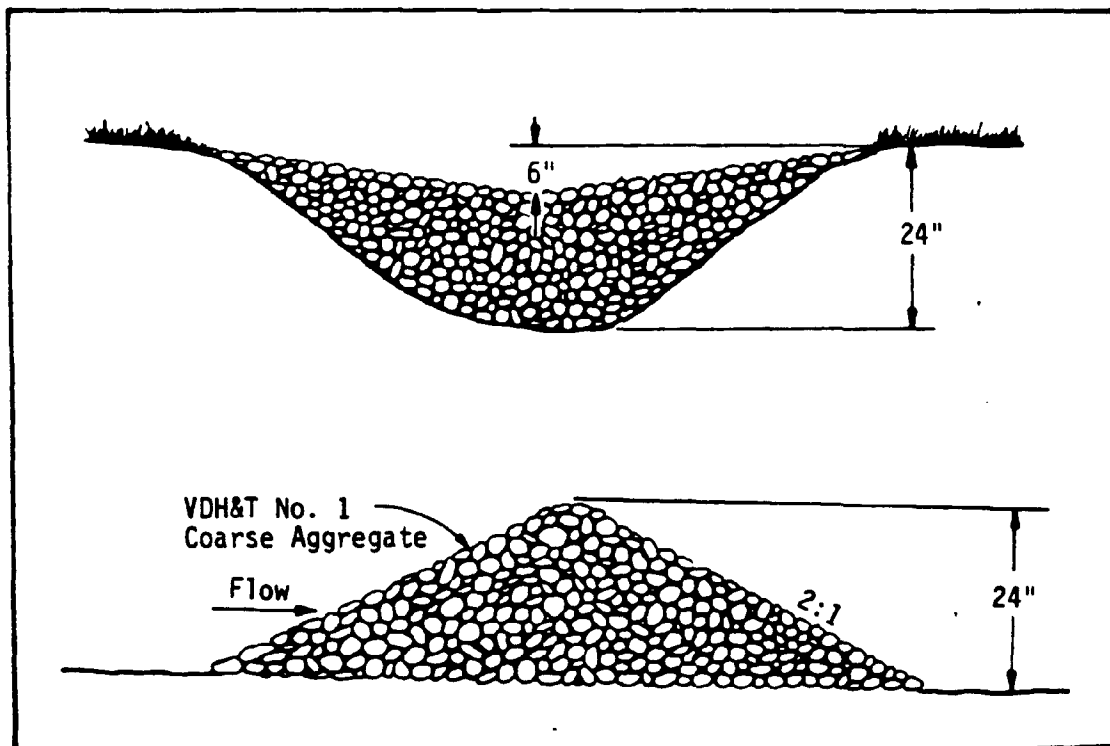

(From Virginia Soil and Water Conservation Commission, Virginia Erosion and Sediment Control Handbook, Richmond, Virginia, 1980.)

12. PERMANENT WATERWAY

STANDARD

Definition

A permanent, designed, drainage channel with a ridge on the lower side when constructed across a slope.

Purpose

A waterway intercepts and conveys runoff to a stable outlet. It is used where:

- runoff from higher areas can cause erosion or prevent vegetation from establishing on lower areas;
- slope length must be shortened to reduce soil loss potential;
- more channel capacity or stabilization is required to control erosion from increased or concentrated runoff due to construction.

Waterways should not substitute for terraces on slopes that require terracing for erosion control, nor should they be used on slopes greater than 15%. Waterways should be used with caution on soils subject to slippage.

Design Considerations

The design of a waterway cross-section and lining is based primarily upon the volume and velocity of flow expected in the waterway. If conditions are appropriate, waterways lined with grass or riprap are preferable to those lined with concrete. While concrete-lined waterways are efficient and easy to maintain, they remove runoff so quickly that channel erosion and flooding often result downstream. Grass- or riprap-lined waterways reduce this problem by more closely duplicating a natural system.

Design considerations should include the following:

1. Unless otherwise specified in local or state regulations, the waterway should be designed to carry, as a minimum, the peak discharge from a 10-year-frequency storm. Where the consequences of overflow are serious, the capacity of the waterway should be increased commensurate with the hazard.

2. The cross-section of the waterway may be V-shaped, parabolic or trapezoidal. V-shaped waterways are generally used where the quantity of water to be handled is relatively small, such as along roadsides. A grass or sod lining will suffice where velocities in the waterway are low. For waterways with steeper slopes and higher velocities, a concrete lining may be appropriate.

Parabolic waterways are often used where the quantity of water to be handled is larger and where space is available for a wide, shallow channel with low velocity flow. Riprap linings should be used where higher velocities are expected and where some dissipation of energy is desired. Combinations of grass and riprap are also useful where there is a continuous flow in the waterway.

Trapezoidal waterways are often used where the quantity of water to be carried is large and conditions require that it be carried at a relatively high velocity. Trapezoidal waterways are generally lined with concrete or riprap.

3. The waterway must be designed so that the expected velocity from the design storm does not exceed the maximum velocity for the channel lining used. Permissible velocities are as follows:

- (a) Unlined waterways. Permissible velocities for unlined waterways are shown in the Sample Specifications for Storm Drain Outlet Protection. Unlined waterways should be lined as soon as practical.
- (b) Grass-lined waterways. Permissible velocities for grass-lined waterways are shown in the Sample Specifications for Grass Protection of Waterways, Swales and Dikes.
- (c) Riprap-lined waterways. Riprap linings can be designed to withstand most flow velocities by choosing a stable stone size. The procedure for selecting a stable stone size for waterways is discussed in the Sample Specifications for Riprap.
- (d) Concrete - and asphalt-lined waterways. Velocity is usually not a limiting factor in the design of paved waterways. However, the flow velocity at the outlet of the paved section must not exceed the permissible velocity in the receiving channel.

It is recommended that some form of lining always be used for permanent waterways and that bare earth not be exposed longer than necessary. (Section 7012 of Chapter 70 of the Uniform Building Code recommends that waterways on terraces have a minimum gradient of 5%, a minimum depth of 1 foot, a minimum width of 5 feet, and be paved with reinforced concrete at least 3 inches thick or an approved equal paving.)

4. For grass-lined waterways, the type of grass chosen should be appropriate for the site conditions (see Standard and Sample Specifications for Grass Protection of Waterways, Swales and Dikes).
5. The outlets of all waterways must be protected from erosion (see Standard and Sample Specifications for Storm Drain Outlet Protection).
6. Where a channel receives water from a tributary waterway the design water surface elevation of the receiving channel must be equal to or less than the design water surface elevation of the discharging waterway.
7. Sediment can damage grass linings and impede flow. Protective measures, such as planting vegetative filter strips, seeding exposed soils and installing sediment traps, should be implemented in disturbed areas that drain to waterways.
8. Unlined waterways require gentle gradients and wider channels than lined waterways. They must be located where there is sufficient space to accommodate such a design. Unlined or grass-lined waterways should not be placed above slopes prone to slippage.
9. Grassed waterways may require mowing or irrigation. Waterways should be designed to allow access for channel maintenance and repair.
10. Access control for public safety should be considered.

Unit Cost Guide

\$20.00-\$25.00 per linear foot (as of fall 1979).

Source and Reference

This standard was prepared by ABAG based on the following sources:

1. U.S. Department of Agriculture, Soil Conservation Service, College Park, Maryland, Standards and Specifications for Soil Erosion and Sediment Control in Developing Areas, July 1975.
2. Virginia Soil and Water Conservation Commission, Virginia Erosion and Sediment Control Handbook, 1980.

SAMPLE SPECIFICATIONS FOR PERMANENT WATERWAY

Design Specifications

1. The constructed waterway shall have the capacity to carry, as a minimum, the peak discharge from a 10-year-frequency rainfall event with a freeboard not less than 0.3 foot. Waterways designed to protect urban areas, buildings and roads, and those designed to function in connection with other structures shall have enough capacity to carry the peak runoff expected from a storm frequency commensurate with the hazard involved.
2. The waterway cross-section may be parabolic, V-shaped or trapezoidal. The waterway shall be designed to have stable side slopes, not steeper than 2:1, and shall be flat enough to ensure ease of maintenance of the structure and any protective vegetative cover. The ridge height shall include a reasonable settlement factor. The ridge shall have a minimum top width of 4 feet at the design elevation. The minimum cross-section shall meet the specified dimensions. The top of the constructed ridge shall not be lower at any point than the design elevation plus specified overfill for settlement. A minimum of 0.3 foot freeboard will be provided.
3. Waterway grades may be uniform or variable. Channel velocity shall not exceed that considered nonerosive for the soil and planned lining.
4. The location of the waterway shall be determined by outlet conditions, topography, land use, cultural operations, soil type, seep planes (when seepage is a problem) and length of slope in the development layout.
5. If movement of sediment into the waterway is a significant problem, a vegetated filter strip shall be used except where soil and/or climate preclude the use of such strips. Then, the design shall include extra capacity for sediment and be supported by supplemental structures, cultural or tillage practices, or special maintenance measures.
6. Each waterway shall have an adequate outlet. The outlet may be a grassed waterway, a vegetated or paved area, a grade stabilization structure, a stable watercourse or an underground outlet. The outlet shall convey runoff to a point where outflow will not cause damage. Vegetated outlets shall be installed before the waterway construction to ensure establishment of vegetative cover in the outlet channel. Underground outlets consist of inlet and underground conduit, and the release rate shall be such that the design storm will not overtop the waterway ridge.

To prevent ponding in the waterway, the design water surface elevation in the waterway shall not be lower than the design water surface elevation in the outlet at their junction when both are operating at design flow.

7. The design water surface elevation of a waterway receiving water from a tributary channel shall be equal to or less than the design water surface elevation in the tributary channel.
8. The top width of parabolic waterways shall not exceed 30 feet, and the bottom width of trapezoidal waterways shall not exceed 15 feet unless multiple or divided waterways, stone centers or other means are provided to control meandering of low flows.

The design procedures for parabolic and trapezoidal waterways are given in Appendix E. (See sample drawings for details.)

Construction Specifications

1. The foundation area for the embankment or ridge shall be stripped of all vegetation, brush or other objectionable material. Small gullies, ditches or depressions within the foundation area shall be filled and compacted.
2. The waterway shall be excavated to the neat lines and grades shown on the plans and/or as staked in the field. Excavated materials shall be used in the earth embankment or wasted to selected locations. Borrow shall be obtained at locations specified or shown on the drawings.
3. If underground conduits are located under waterway ridges, mechanical compaction, water packing, and installation and backfill of conduit trenches shall be made in advance to allow adequate settlement. Materials used for the inlet and conduit shall be suitable for the purpose intended and shall meet the Standard and Sample Specifications for Subsurface Drain.
4. Fill material shall meet the following criteria:
 - (a) All satisfactory fill material obtained from the excavated waterway will be used to construct the embankment. Fill material containing brush, roots, or other perishable or unsuitable materials shall not be used. Cobbles and rock fragments having a maximum dimension of more than 6 inches will be removed from the material. Gravel and sand will not be used to construct the fill unless mixed with clay material approved by a qualified engineer.
 - (b) The soil moisture of fill material shall be such that the material will form a firm ball when squeezed in the hand.

Compaction may be accomplished by the passage of the excavating equipment. The wheels or tracks of the excavating equipment must pass over 90% of the surface of each lift. Each lift shall not exceed 6 inches before compaction. Waterway ridges constructed across gullies or depressions shall also be compacted in the above-stated manner. The surface of the finished waterway shall be reasonably smooth and present a workmanlike appearance.

5. Grass shall be established as soon as practicable in all disturbed areas that drain to the waterway, according to the Sample Specifications for Planting of Exposed Soils. Care shall be taken during construction to avoid disturbance of vegetation outside the channel or embankment area. If it is necessary, top soil shall be stockpiled and spread over the excavations and other areas to facilitate revegetation.
6. Waterways shall be stabilized as soon as practicable with grass, riprap, asphalt, concrete or other suitable material. Grass and riprap stabilization shall be according to the Sample Specifications for Grass Protection of Waterways, Swales and Dikes and for Riprap, respectively. The use of unlined, permanent waterways is not permitted.
7. A maintenance program shall be established to maintain waterway capacity, storage, ridge height and the outlets. Any hazards must be brought to the attention of the responsible person.

Source and Reference

These sample specifications were prepared by ABAG, based on materials furnished by staff of the USDA, Soil Conservation Service.

Sample Drawing: Typical Waterway Cross-sections

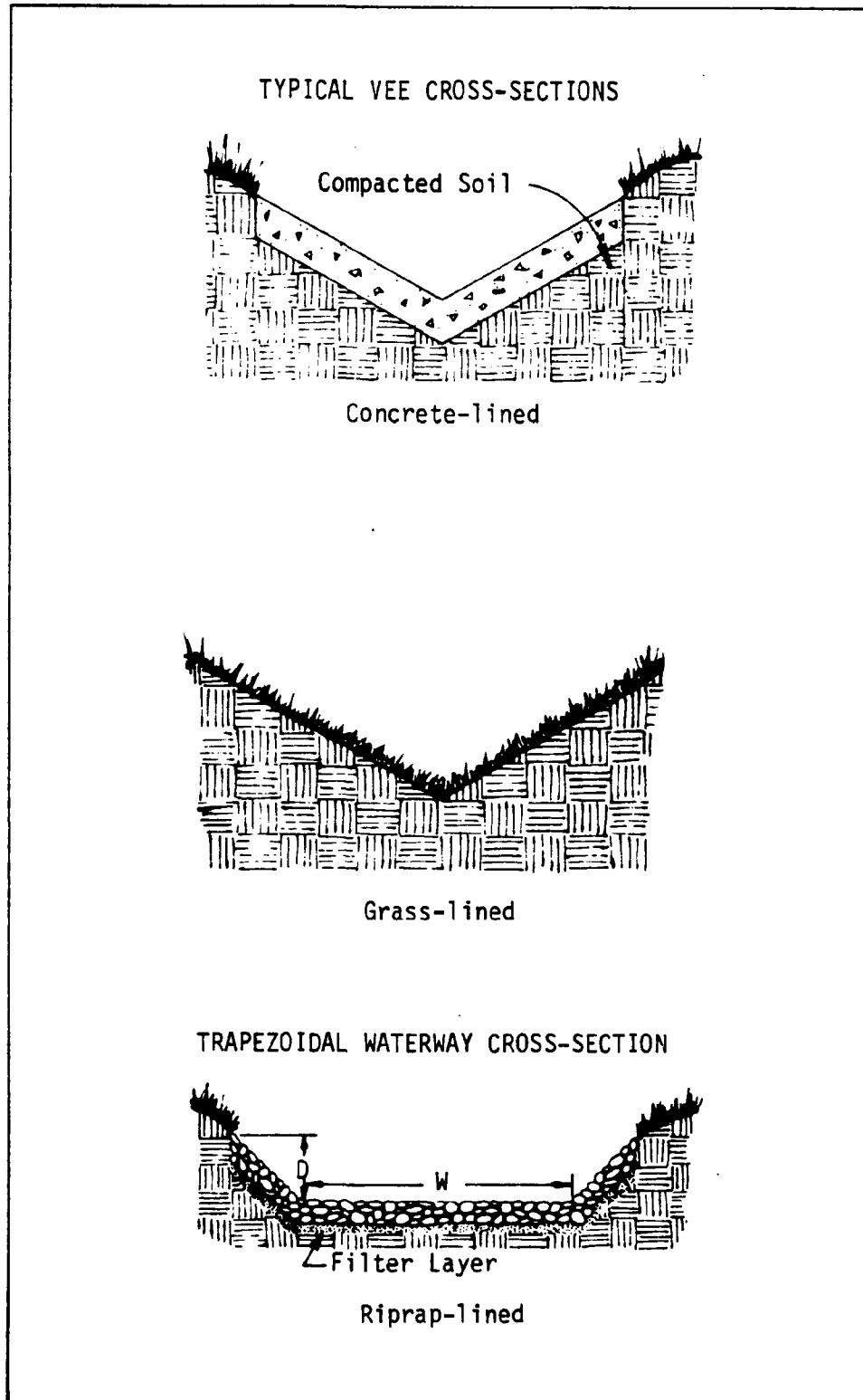

(Adapted from Virginia Soil and Water Conservation Commission, Virginia Erosion and Sediment Control Handbook, 1980;)

Sample Drawing: Waterway

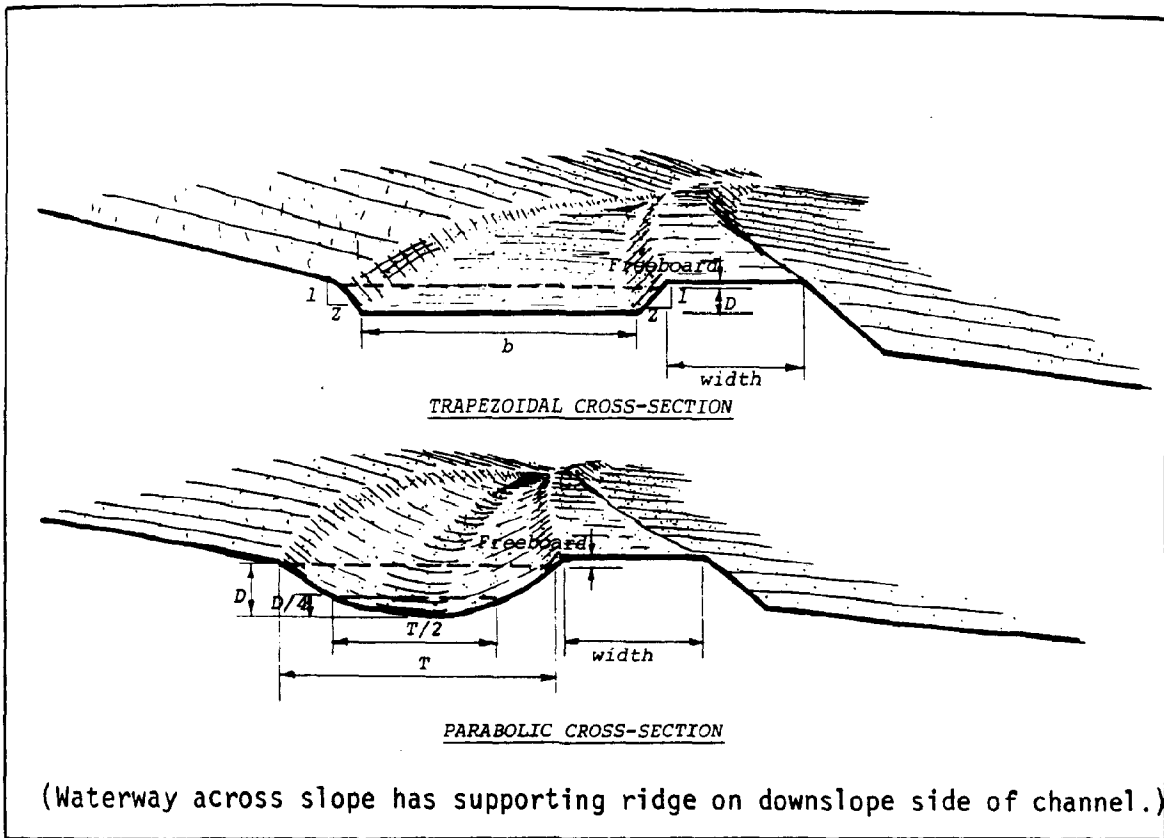

(adapted from USDA, Soil Conservation Service, College Park, Maryland. Standards and Specifications for Soil Erosion and Sediment Control in Developing Areas. July 1975.)

Sample Drawing: Grassed Waterway

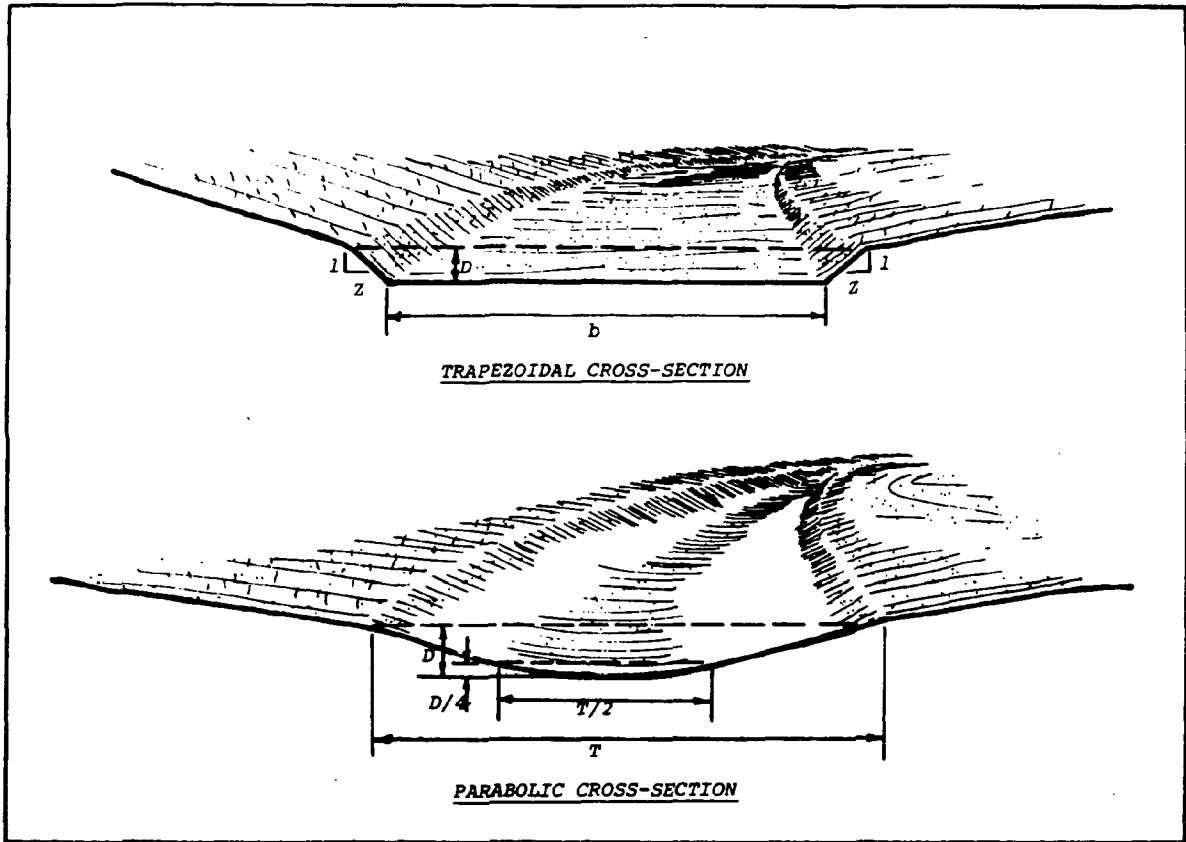

(adapted from USDA, Soil Conservation Service, College Park, Maryland. Standards and Specifications for Soil Erosion and Sediment Control in Developing Areas. July 1975.)

13. PERMANENT RIPRAP

STANDARD

Definition

A layer of loose rock or aggregate placed over an erodible soil surface.

Purpose

Riprap protects soil from the erosive forces of water. It is used on storm drain outlets, channel banks and bottoms, roadside ditches, drop structures, shorelines and any other place where soil may erode under the design flow conditions because of:

- soil conditions;
- water turbulence and velocity;
- lack of vegetative cover;
- groundwater conditions.

This standard applies to the design and placement of all nongROUTED riprap where the slopes are 2:1 or flatter. (For design and placement of grouted riprap on slopes steeper than 2:1, consult a qualified engineer.)

Design Considerations

Design considerations should include the following:

- peak discharge from the design storm that the riprap will be expected to carry;
- erosive forces of flowing water;
- slope and placement;
- size and quality of material;
- placement and quality of bedding;
- maintenance requirements.

Unit Cost Guide

\$5.50-\$9.00 per cubic yard (as of fall 1979), depending on size of riprap and distance from quarry.

Source and Reference

This standard was prepared by ABAG based on materials furnished by staff of the USDA, Soil Conservation Service.

SAMPLE SPECIFICATIONS FOR PERMANENT RIPRAP

Design Specifications

1. The minimum design discharge for channels and ditches shall be the peak discharge from a 10-year-frequency rainfall based on maximum watershed development during the life of the structure. The roughness coefficient "n", used for determining flow on the constructed riprap surface, shall be as given by curve 1 in Appendix F.

The design stone size used in these specifications is the d50 or median stone diameter, which is defined as the stone size such that 50% of the mixture, by weight, is larger than that size. Appendix F presents a procedure for determining a design stone size that will be stable under the design flow conditions with a reasonable safety factor.

Erosive forces of flowing water are greater in bends than in straight channels. Riprap size for bends in the channel shall be computed according to the procedure in Appendix F. If the riprap size (d50) computed for bends is less than 10% greater than the riprap size (d50) for straight channels, then the riprap size for straight channels shall be considered to be adequate size; otherwise the larger riprap size shall be used in the bend. This allowance is made in order to minimize the number of riprap sizes required. No more than two riprap sizes shall be used on any single contract in order to minimize construction problems caused by too many sizes. The riprap size to be used in a bend shall extend upstream from the point of curvature and downstream from the point of tangency a distance equal to 5 times the channel bottom width (length = 5b).

2. The riprap shall be composed of a well-graded mixture down to the 1-inch size particle such that 50% of the mixture by weight shall be larger than the d50 size as determined from the design procedure. A well-graded mixture as used herein is defined as a mixture composed primarily of the larger stone sizes but with a sufficient mixture of other sizes to fill the progressively smaller voids between the stones. The diameter of the largest stone size in such a mixture shall be considered to be 1.5 times the d50 size. The riprap size as shown on the plans and specifications or for other construction purposes shall be the size of the largest stone in the mixture, i.e., 1.5 x d50. The minimum thickness of the riprap layer shall be 1.5 times the maximum stone diameter, but not less than 6 inches. The riprap shall extend up the banks to a height equal to the maximum depth of flow or to a point where vegetation can be established to adequately protect the channel.

In channels where there is no riprap or paving in the bottom, the toe of the bank riprap shall extend below the channel bottom a distance at least 1.5 times the maximum stone size, but in no case less than 1 foot. The only exception to this would be in the event that there is a nonerodible hard-rock bottom. The channel bank shall not be steeper than 2:1.

The designer, after determining the riprap size that will be stable under the flow conditions, shall consider that size to be a minimum size and then, based on riprap gradations actually available in the area, shall select the size or sizes that equal or exceed the minimum size.

3. Stone for riprap shall consist of field stone or rough unhewn quarry stone of approximately rectangular shape. The stone shall be hard and angular and of such quality that it will not disintegrate on exposure to water or weathering, and it shall be suitable in all other respects for the purpose intended. The specific gravity of the individual stones shall be at least 2.5.

Rubble concrete may be used provided it has a density of at least 150 pounds per cubic foot and otherwise meets the requirements of this standard and specifications.

4. Riprap shall have a filter placed under it when either of the following conditions exist:
 - (a) The riprap is not well-graded down to the 1-inch size particle.
 - (b) Riprap is placed on the side slopes of a channel, and the soil is sand-size or finer with a plasticity index of less than 10. This requirement applies to slopes having this soil in lenses or layers greater than 3 inches in thickness.

A filter can be of two general forms. One is a single layer of plastic filter cloth manufactured for that express purpose. The plastic filter cloth shall meet the strength criteria presented in U.S. Army, Corp of Engineers, Civil Works Construction Guide Specification for Plastic Filter Fabrics (see Sample Specifications for Temporary Silt Fence). Riprap that is 12 inches and larger shall not be dumped directly onto the plastic filter cloth, as it may tear or displace the filter cloth. Instead, a 4-inch-thick (minimum) blanket of gravel shall be placed over the filter cloth. Side slopes shall be 2:1 or flatter in order for the gravel not to slide down the filter cloth before the riprap is put in place. Alternatively, the riprap shall be placed directly on the filter cloth by hand or by the bucket of the equipment used.

The other form of filter is a properly graded layer of sand, gravel or stone. The criteria for the design of an aggregate filter is as follows:

$$\frac{d_{15} \text{ Riprap}}{d_{85} \text{ Filter}} \leq 5 \qquad \frac{d_{15} \text{ Filter}}{d_{85} \text{ Base}} \leq 5$$

in which d15 and d85 are the sizes of base, filter or riprap material, of which 15% and 85% respectively is finer. The base means the soil layer underneath the filter. The filter shall be graded down to sand-size particles.

5. Soil sizes given herein are according to the Unified Soil Classification System as shown below.

| <u>Soil</u> | <u>Sieve Size</u> |
|-------------|---|
| Gravel | Smaller than 3 inches and larger than No. 4 sieve (approximately 1/4 inch) |
| Sand | Smaller than No. 4 sieve and larger than No. 200 sieve (0.074 millimeter) |

Construction Specifications

1. The subgrade for the riprap or filter shall be prepared to the required lines and grades. Any fill required in the subgrade shall be compacted to a density approximating that of the surrounding undisturbed material.
2. The rock or gravel shall conform to the specified grading limits when installed respectively in the riprap or filter.
3. Plastic filter cloth shall be protected from punching, cutting or tearing. Any damage other than an occasional small hole shall be repaired by placing another piece of cloth over the damaged part or by completely replacing the cloth. All overlaps whether for repairs or for joining two pieces of cloth shall be a minimum of 1 foot.
4. The stone for the filter and riprap may be placed by equipment. Both filter and riprap shall each be constructed to the full course thickness in one operation and in such a manner as to avoid displacement of the underlying materials. The stone for filter and riprap shall be delivered and placed in a manner that will ensure that the filter and riprap shall be reasonably homogeneous, with the smaller stones and spalls filling the voids between the larger stones. Riprap shall be placed in a manner to prevent damage to the filter blanket. Hand-placing will be required to the extent necessary to prevent damage to the permanent works.

Source and Reference

These sample specifications were prepared based on materials furnished by staff of the USDA, Soil Conservation Service and modified by ABAG for simplification and clarity.

14. PERMANENT STORM DRAIN OUTLET PROTECTION

STANDARD

Definition

De-energizing devices and erosion-resistant channel sections between storm drain outlets and stable downstream channels.

Purpose

These protection measures convert pipe flow to channel flow and reduce water velocity. They are used where storm drain outlets, road culverts, paved channel outlets, etc., discharge into natural or constructed channels that in turn discharge into existing streams or drainage systems. The entire length of the channel from the end of the structure to the stream or drainage system is protected by rock-lining, vegetation, concrete paving or other erosion-resistant material.

Design Considerations

Design considerations should include the following:

- depth of flow, roughness, gradient, side slopes, bottom width, discharge rate and velocity of each channel reach between the storm drain outlet and the existing publicly-maintained system or natural stream channel. (A channel reach is defined as a length of channel throughout which the hydraulic characteristics do not change);
- maximum allowable water velocity through each channel reach;
- type of storm drain outlet protection (aprons, lined waterways, riprap or grass protection);
- compliance with local and state regulations and requirements;
- maintenance requirements.

For alternative methods of design and more information, consult a qualified engineer.

Unit Cost Guide

Grass-lined channels: \$0.50-\$ 1.00 per square foot.
Riprap construction: \$6.00-\$15.00 per linear foot.
Concrete construction: \$7.50-\$20.00 per linear foot.

Variability in costs is due to size of outlet, topography and availability of materials (as of fall 1979).

Source and Reference

This standard was prepared by ABAG based on materials furnished by staff of the USDA, Soil Conservation Service.

SAMPLE SPECIFICATIONS FOR PERMANENT STORM DRAIN OUTLET PROTECTION

Design Specifications - Pipe Outlets

All pipe outlets shall have a structurally-lined apron or other suitable de-energizing device immediately downstream from the outlet where the water can change from pipe flow to channel flow. The structurally-lined apron shall meet the following criteria:

1. The bottom grade shall be 0.0%.
2. The side slopes shall be 2:1 or flatter.
3. The top of the sidewall shall extend at least 1 foot above maximum tailwater, but no lower than two-thirds of the vertical conduit dimension above the conduit invert.
4. The downstream end of the invert shall be equal to or lower than the lowest elevation on the cross-section immediately downstream from the end of the apron so that there is no overfall at the end of the apron.
5. Size of riprap and length of apron shall meet the criteria given in the Sample Design of Outlet Protection (Appendix G), and riprap shall meet the Standard and Sample Specifications for Riprap. Concrete paving may be substituted for the riprap. Fifty percent (50%) of the riprap mixture, by weight, shall be larger than the median stone diameter.
6. Where there is no well-defined channel immediately downstream from the apron, the width (W) of the end of the apron shall be as follows:

- (a) For tailwater elevation greater than or equal to the elevation of the center of the pipe:

$$W = \text{diameter} + 0.4 L_a,$$

where L_a is the length of apron determined from the curves in Appendix G.

- (b) For tailwater elevation less than the elevation of the center of the pipe:

$$W = \text{diameter} + L_a,$$

Where there is a well-defined channel immediately downstream from the apron, the width of the end of the apron shall be equal to the width of that channel.

7. There shall be no bends or curves in the horizontal alignment of the pipe and the apron unless the structure is designed to handle the flow.
8. Tailwater shall be determined by computing depth of flow in the channel reach immediately downstream from the apron by the use of Manning's equation.

Design Specifications - Paved Channel Outlets

Paved channel sections shall meet the following criteria:

1. Velocity in the end of the paved section is no greater than the allowable velocity for the succeeding downstream section.
2. The downstream end of the invert of the paved section shall be no higher than the lowest point in the channel immediately downstream from the end of the paved section so that there is no overfall at the end of the apron.
3. The end of a paved channel shall merge smoothly with the next downstream channel section, and this transition shall be accomplished within the paved channel. The bottom width of the end of the paved channel shall be at least as wide as the bottom width of the downstream channel. The maximum side divergence of a transition shall be 1 in 3F, where the Froude number $F = V / \sqrt{gd}$; where V equals velocity in feet per second, d equals depth of flow in feet at the beginning of the transition and g is acceleration due to gravity (32.2 feet per second squared).
4. Bends or curves in the horizontal alignment of paved channels are not acceptable unless the Froude number F is 1.0 or less, or the channel is specifically designed to contain the turbulent flow.

Design Specifications - Riprap or Grass Protection

Each channel reach having a natural, grass-or riprap-lined bottom shall be checked for stability by calculating the flow velocity using Manning's equation and ensuring that the channel will handle that velocity without eroding.

Design Specifications - Channel Roughness

For the purpose of design, the roughness coefficient "n" used in calculations shall be as follows:

| <u>Channel Lining</u> | <u>"n" Value</u> |
|--|---|
| Asphaltic concrete - Machine finished | 0.018 |
| Hand finished | 0.022 |
| Concrete - Float finish | 0.015 |
| Unfinished | 0.017 |
| Shotcrete, unfinished | 0.022 |
| Natural channels not completely lined with vegetation | 0.025 |
| Gabion mattresses | 0.028 |
| Fabriform - Filter point (waffled surface) | 0.025 |
| Riprap | See Standard and Sample Specifications for Riprap |
| Vegetation | See Standard and Sample Specifications for Grass Protection of Waterways, Swales and Dikes |

Design Specifications - Velocities

Maximum flow velocities at design capacity shall be as follows:

| <u>Channel Lining</u> | <u>Maximum Velocity (feet per second)</u> |
|--|---|
| Natural channels not completely lined with vegetation | |
| Sand and sandy loam | 2.5 |
| Silt loam | 3.0 |
| Sandy clay loam | 3.5 |
| Clay loam | 4.0 |
| Clay, fine gravel and graded loam to gravel | 5.0 |
| Graded silt to cobbles | 5.5 |
| Shale, hardpan and coarse gravels | 6.0 |
| Riprap | See Standard and Sample Specifications for Riprap |
| Vegetation | See Standard and Sample Specifications for Grass Protection of Waterways, Swales and Dikes |

Construction Specifications - Permanent Storm Drain Outlet Protection

1. For natural or vegetated channels, see Standard and Sample Specifications for Grass Protection of Waterways, Swales and Dikes.
2. For riprap construction, see Standard and Sample Specifications for Riprap.
3. Aprons at the end of pipe or lined channel outlets shall meet the following criteria:
 - (a) The bottom grade shall be 0.0%.
 - (b) The side slopes shall be 2:1 or flatter.
 - (c) The sidewalls shall extend up as shown on the plans but not less than two-thirds of the pipe diameter.
 - (d) There shall be no overfall from the end of the apron to the surface of the receiving channel. The area to be paved or riprapped shall be undercut so that the invert of the apron shall be at the same grade (flush) with the surface of the receiving channel. The apron shall have a cutoff or toe wall at the downstream end.
 - (e) Apron dimensions and riprap size or concrete thickness shall be as shown on the plans.
 - (f) The width of the receiving end of the apron shall be equal to the bottom width of the receiving channel.
 - (g) Fill, either loose or compacted, shall not be placed in the receiving channel.
 - (h) There shall be no bends or curves in the horizontal alignment of the apron.
4. Paved channel sections shall meet the following criteria:
 - (a) Side slopes, dimensions, grades, etc., shall be as shown on the plans.
 - (b) There shall be no overfall from the end of the paving to the surface of the receiving channel.
 - (c) Riprap size or concrete thickness, joint details, etc., shall be as shown on the plans.
 - (d) The end of paved sections shall be as wide as the receiving channel and the transition between the two channels shall be smooth.

- (e) Fill, either loose or compacted, shall not be placed in the receiving channel.
- (f) Bends or curves in the horizontal alignment of paved channels are not acceptable unless shown on the plans, and the radius of curvature shall be the same as shown on the plans.

Source and Reference

These sample specifications were prepared based on materials furnished by staff of the USDA, Soil Conservation Service and modified by ABAG for simplification and clarity.

15. PERMANENT SUBSURFACE DRAIN

STANDARD

Definition

A conduit, such as tile, pipe or tubing, installed beneath the ground to collect and/or convey drainage water.

Purpose

In areas with a high water table where the benefits of lowering or controlling groundwater or surface runoff justify installing such a system, subsurface drains:

- improve the soil environment for vegetative growth by regulating the water table and groundwater flow;
- intercept and prevent water movement into a wet area;
- remove surface runoff;
- relieve artesian pressure;
- facilitate leaching of saline and alkaline soils;
- serve as outlets for other subsurface drains;
- serve to dewater sediment basins.

Soil should have enough depth and permeability to permit installation of an effective and economically feasible system. Where soils are saline or alkaline, their ability to drain should be considered. The outlet should be adequate for the quantity and quality of effluent to be disposed of. Consideration should be given to possible damages above or below the point of discharge that might involve legal actions under state or local laws.

Design Considerations

Design considerations should include the following:

- required capacity;
- size;
- depth and spacing;
- minimum velocity and grade;
- materials;
- maximum loading rates;
- envelopes and envelope material;
- auxiliary structure and subsurface drain protection.

For alternative design methods and more information, consult a qualified engineer.

Unit Cost Guide

Variable, depending on size and design.

Source and Reference

This standard was prepared from materials furnished by staff of the USDA, Soil Conservation Service and modified by ABAG for simplification and clarity.

SAMPLE SPECIFICATIONS FOR PERMANENT SUBSURFACE DRAIN

Design Specifications

1. The required capacity shall be determined by one or more of the following:

- (a) Where subsurface drainage is to be uniform over an area through a systematic pattern of drains, a drainage coefficient of 1 inch to be removed in 24 hours shall be used. Appendix C contains drain capacity charts and sample determinations of subsurface drain sizes;
- (b) Where subsurface drainage is to be by a random system, a minimum inflow rate of 1.5 cfs per 1,000 feet of line shall be used to determine required capacity.

For interceptor subsurface drains on sloping land, the inflow rate shall be increased as follows:

| <u>Land Slopes (Percent)</u> | <u>Inflow Rate Increased by (Percent)</u> |
|----------------------------------|---|
| 2- 5 | 10 |
| 5-12 | 20 |
| over 12 | 30 |

- (c) Additional design capacity must be provided if surface water is allowed to enter the system.
2. The size of subsurface drains shall be determined from the drain capacity charts in Appendix C. All subsurface drains shall have a diameter that equals or exceeds 4 inches.
3. The minimum depth of cover of subsurface drains shall be 24 inches where possible. The minimum depth of cover may be reduced to a minimum of 12 inches where it is not possible to attain the 24-inch depth and where the drain is not subject to damage by equipment loading or frost action. Roots from some types of vegetation can plug drains as the drains get closer to the surface.

The spacing of drain laterals shall be dependent on the permeability of the soil, the depth of installation of the drains and the degree of drainage required. Generally, drains installed 36 inches deep and spaced 50 feet from center to center will be adequate.

4. The minimum grade for subsurface drains shall be 0.10%. Where surface water enters the system, a velocity of not less than 2 feet per second shall be used to establish the minimum grades. Provisions shall be made for preventing debris or sediment from entering the system by means of filters or collection, and for periodic removal of sediment from installed traps.
5. Acceptable subsurface drain materials include perforated, continuous, closed-joint conduits of polyethylene plastic, concrete, corrugated metal, asbestos-cement, bituminized fiber and poly-vinyl chloride.

The conduit shall meet strength and durability requirements of the site.
6. The allowable loads on subsurface drain conduits shall be based on the trench and bedding conditions specified for the job. A safety factor of not less than 1.5 shall be used in computing the maximum allowable depth of cover for a particular type of conduit.
7. The conduit shall be placed and bedded in a sand-gravel envelope. A minimum depth of 3 inches of envelope material shall be placed on the bottom of a conventional trench. The conduit shall be placed on this, and the trench completely filled with envelope material to a minimum depth of 3 inches above the conduit.

Not less than 3 inches of envelope material shall be used for sand-gravel envelopes. Where necessary to improve the characteristics of flow of groundwater into the conduit, more envelope material may be required.

Envelope material shall be placed to the height of the uppermost seepage strata. Behind bulkhead and retaining walls, it shall go to within 12 inches of the top of the structure. This does not cover the design of filter materials where needed.

Materials used for envelopes shall not contain materials that will cause an accumulation of sediment in the conduit or render the envelope unsuitable for bedding of the conduit. Envelope materials shall consist of sand-gravel material, of which all shall pass a 1.5-inch sieve, 90% to 100% shall pass a 0.75-inch sieve, and not more than 10% shall pass a No. 60 sieve.

Soft or yielding soils under the drain shall be stabilized where required, and lines shall be protected from settlement by adding gravel or other suitable material to the trench, by placing the conduit on a plank or other rigid support or by using a long section of pipe with adequate strength to ensure satisfactory subsurface drain performance.

8. The outlet shall be protected against erosion and undermining of the conduit, against damaging periods of submergence and against entry of rodents or other animals into the subsurface drain (see drawing for animal guard in Appendix C.)

A continuous 10-foot section of corrugated metal, cast iron, or steel pipe without perforations shall be used at the outlet end of the line and shall outlet above the normal elevation of low flow in the outlet ditch or above mean high tide in tidal areas. No envelope material shall be used around the 10-foot section of pipe. Two-thirds of the pipe shall be buried in the ditch bank, and the cantilevered section shall extend to a point above the toe of the ditch side slope, or the side slope shall be protected from erosion.

Conduits under roadways and embankments shall be watertight and designed to withstand the expected loads.

Where surface water is to be admitted to subsurface drains, inlets shall be designed to exclude debris and prevent sediment from entering the conduit. Lines flowing under pressure shall be designed to withstand the resulting pressures and velocity of flow (see surface water inlet drawing in Appendix C.) Surface waterways shall be used where feasible.

The upper end of each subsurface drain line shall be capped with a tight-fitting cap of the same material as the conduit or other durable material, unless connected to a structure.

Construction Specifications

1. Deformed, warped or otherwise damaged pipe or tubing shall not be used.
2. All subsurface drains shall be laid to a uniform line and covered with envelope material. The pipe or tubing shall be laid with the perforations down and oriented symmetrically about the vertical centerline. Connections shall be made with manufactured functions comparable in strength with the specific pipe or tubing unless otherwise specified. The method of placement and bedding shall be as specified on the drawing in the erosion and sediment control plan.
3. Envelope material shall be a sand-gravel material, of which all shall pass the 1.5-inch sieve, 90% to 100% shall pass the 0.75 inch sieve, and not more than 10% shall pass the No. 60 sieve.
4. The upper end of each subsurface drain line shall be capped with a tight-fitting cap of the same material as the conduit or other durable material, unless connected to a structure.

5. A continuous 10-foot section of corrugated metal, cast iron or steel pipe without perforations shall be used at the outlet end of the line. No envelope material shall be used around the 10-foot section of pipe. An animal guard shall be installed on the outlet end of the pipe.
6. Earth backfill material shall be placed in the trench in such a manner that displacement of the drain will not occur.

Source and Reference

These sample specifications were prepared from materials furnished by staff of the USDA, Soil Conservation Service and modified by ABAG for simplification and clarity.

16. GENERAL LAND GRADING PRACTICES FOR MINIMIZING EROSION

STANDARD

Definition

Reshaping of the existing topography in accordance with a grading plan.

Purpose

Where land grading is necessary for road or building construction, these land grading practices minimize erosion potential and facilitate plant establishment.

Design Considerations

Design considerations should include the following:

- existing contours;
- land use;
- vegetation;
- soil;
- drainage;
- slope stability;
- slope length;
- slope angle;
- space limitations;
- erosion potential of land disturbance;
- erosion and sediment control measure implementability.

Development should fit existing topography as much as possible so that land disturbance is minimized.

Slope gradients and lengths should be kept to a minimum, and benches should be installed on long slopes. A bench should be graded back towards the slope and drain with a gentle gradient to a stable outlet.

Drainage from upland areas should be diverted away from exposed slopes.

The surfaces of cut and fill slopes should be left rough or should be serrated so that they hold seeds well and allow for good plant establishment.

Unit Cost Guide

Variable, depending on local topography and characteristics of earth to be graded.

Source and Reference

This standard was prepared by ABAG based on materials furnished by staff of the USDA, Soil Conservation Service.

July 1980

SAMPLE SPECIFICATIONS FOR PERMANENT LAND GRADING TO MINIMIZE EROSION

Design Specifications

The grading plan shall be based upon building designs and street layout that fit and utilize existing topography and desirable natural surroundings and avoid extreme grade modifications. Information submitted shall include sufficient topographic surveys and soil investigations to determine grading limitations related to slope stability, effect on adjacent properties and drainage patterns, measures for drainage, water removal, vegetative treatment, etc.

The plan shall show the existing and proposed contours of the area or areas to be graded. The plan shall also include practices for erosion control, slope stabilization, safe disposal of runoff water and drainage (such as waterways, lined ditches and reverse slope benches (including grade and cross-section)), grade stabilization structures, retaining walls, and surface and subsurface drains. The plan shall also include scheduling and phasing of these practices. The following shall be incorporated into the plan:

1. Provisions shall be made to conduct surface runoff safely to storm drains, protected outlets or stable watercourses to ensure that surface runoff will not damage slopes or other graded areas (see Standard and Sample Specifications for Permanent Waterway, and Temporary Grade Stabilization Structure).
2. Cut and fill slopes shall not be steeper than 2:1. Where the slope is to be mowed, the slope shall be no steeper than 3:1 (4:1 is preferred because of safety factors related to mowing steep slopes).
3. Reverse slope benches or diversions shall be provided whenever the height of any 2:1 through 5:1 slope exceeds 15 feet. Benches shall be located so as to divide the slope face as equally as possible and shall convey the water to a stable outlet. Soils, seeps, rock outcrops, etc., shall also be taken into consideration when designing benches.
 - (a) Benches shall be wide enough to accommodate the construction equipment in use and provide for ease of maintenance.
 - (b) Benches shall be designed with a reverse slope of 5:1 or flatter to the toe of the upper slope. The outer edge of the bench shall be at least 1 foot higher than the inner edge. Bench gradient to the outlet shall be between 1% and 2%.
 - (c) The surface flow across a bench shall not exceed a linear distance of 800 feet (see Standard and Sample Specifications for Permanent Waterway).

4. Surface water shall be diverted from the face of all cut-and-fill slopes by a dike, swale or waterway, or conveyed downslope by a grade stabilization structure, except that:
- The length of overland flow (in feet) to the crest of the slope shall not exceed the distance A given below for any combination of side slopes and vertical intervals.
 - The face of the slope is or shall be stabilized and the face of all graded slopes shall be protected from surface runoff until they are stabilized.
 - The face of the slope shall not be subjected to any concentrated flows of surface water from natural drainageways, graded swales, downspouts, etc.

The maximum total horizontal overland-flow-plus-slope distance B shall not exceed 15 times the side slope X of the cut or fill slope. Maximum allowable overland flow distance (in feet) to the top of the slope with no diversion of surface water will be determined by use of the formula

$$A = X (15 - Y),$$

where A is the maximum overland flow distance to the slope crest, in feet;

B is the maximum horizontal distance (not to exceed 15X), in feet;

X is the side slope given as the ratio of the horizontal distance in feet to 1 foot vertical;

Y is the height of the cut or fill slope measured vertically from the bottom elevation of the slope to the slope crest, in feet.

If maximum allowable overland flow is exceeded, surface water shall be diverted from the slope face and carried to a stable outlet, or conveyed downslope with a grade stabilization structure.

TYPICAL SECTION OF A SLOPE

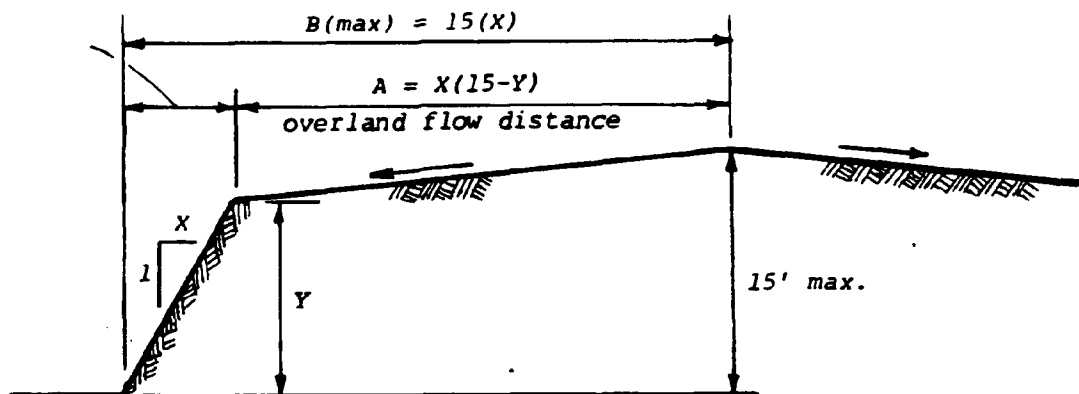

(from USDA, Soil Conservation Service, College Park, Maryland, Standards and Specifications, for Soil Erosion and Sediment Control in Developing Areas, July 1975.)

5. Serrated cut slopes shall be constructed so as to facilitate long-lasting vegetative stabilization. These serrations shall be made in rippable rock with conventional equipment as the excavation is made. Each step or serrate shall be constructed on the contour and shall have steps cut at approximately 2-foot intervals with approximately 3-foot horizontal shelves. These steps may vary depending on the slope ratio of the cut slope. The normal slope line is 1-1/2:1. Overland flow shall be diverted from the top of all serrated cut slopes and carried to a suitable outlet.

TYPICAL SECTION OF SERRATED CUT SLOPE

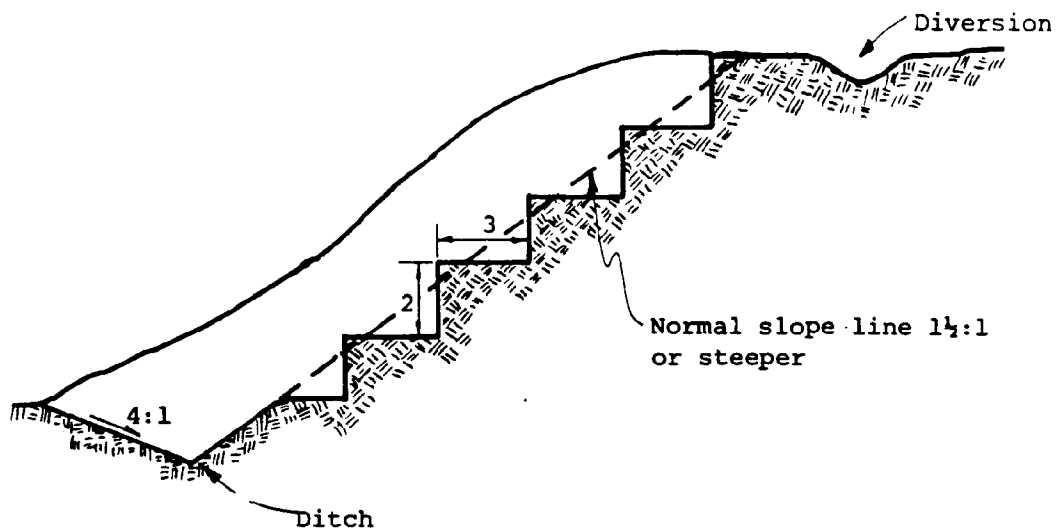

(from USDA, Soil Conservation Service, College Park, Maryland, Standards and Specifications for Soil Erosion and Sediment Control in Developing Areas, July 1975.)

6. Subsurface drainage shall be provided where necessary to intercept seepage that would otherwise adversely affect slope stability or create excessively wet site conditions that would hinder or prohibit vegetative establishment (see Standard and Sample Specifications for Subsurface Drain).
7. Slopes shall not be created so close to property lines as to endanger adjoining properties without adequately protecting such properties against erosion, slippage, settlement, subsidence or other related damages.

8. Material for earth fills shall be obtained from designated areas. Except for approved landfills, the fill material shall be free of brush, rubbish, rocks, logs, stumps, building debris and other objectionable material that would interfere with or prevent construction of satisfactory fills. It should be free of stones over 2 inches in diameter where fills are compacted by hand or mechanical tampers, or over 6 inches in diameter where fills are compacted by rollers or other equipment.
9. Stockpiles, borrow areas and spoil areas shall be shown on the plans and shall be subject to the provisions of this standard and sample specifications.
10. All disturbed areas shall be stabilized structurally or vegetatively in compliance with the standard and specifications for the appropriate practices.

Construction Specifications

1. All graded or disturbed areas including slopes shall be protected during clearing and construction in accordance with the approved erosion and sediment control plan until they are permanently stabilized.
2. All sediment control measures shall be constructed and maintained in accordance with the approved erosion and sediment control plan and the standards and specifications for the appropriate erosion control practices.
3. If topsoil is required for the establishment of vegetation, it shall be stockpiled in the amount necessary to complete finished grading of all exposed areas.
4. Areas to be filled shall be cleared, grubbed to remove trees, vegetation, roots and other objectionable material, and stripped of topsoil.
5. Areas to be topsoiled shall be scarified to a minimum depth of 3 inches prior to placement of topsoil.
6. All fills shall be compacted as required to reduce erosion, slippage, settlement, subsidence and other related problems. Fill intended to support buildings, structures, conduits, etc., shall be compacted in accordance with local requirements or codes.
7. All fill shall be placed and compacted in layers not to exceed 8 inches per lift.
8. Except for approved landfills, fill material shall be free of brush, rubbish, rocks, logs, stumps, building debris and other objectionable materials that would interfere with or prevent construction of satisfactory fills.

9. Soft, mucky or highly compressible materials shall not be incorporated into fills.
10. All benches shall be kept free of sediment during all phases of development.
11. Seeps or springs encountered during construction shall be handled in accordance with the Standard and Sample Specifications for Subsurface Drain or other approved methods.
12. All graded areas shall be permanently stabilized immediately following finished grading.
13. Stockpiles, borrow areas and spoil areas shall be shown on the plans and shall be subject to the provisions of this standard and sample specifications.

Source and Reference

These sample specifications were prepared based on materials furnished by staff of the USDA, Soil Conservation Service and modified by ABAG for simplification and clarity.

Sample Drawing: Landgrading

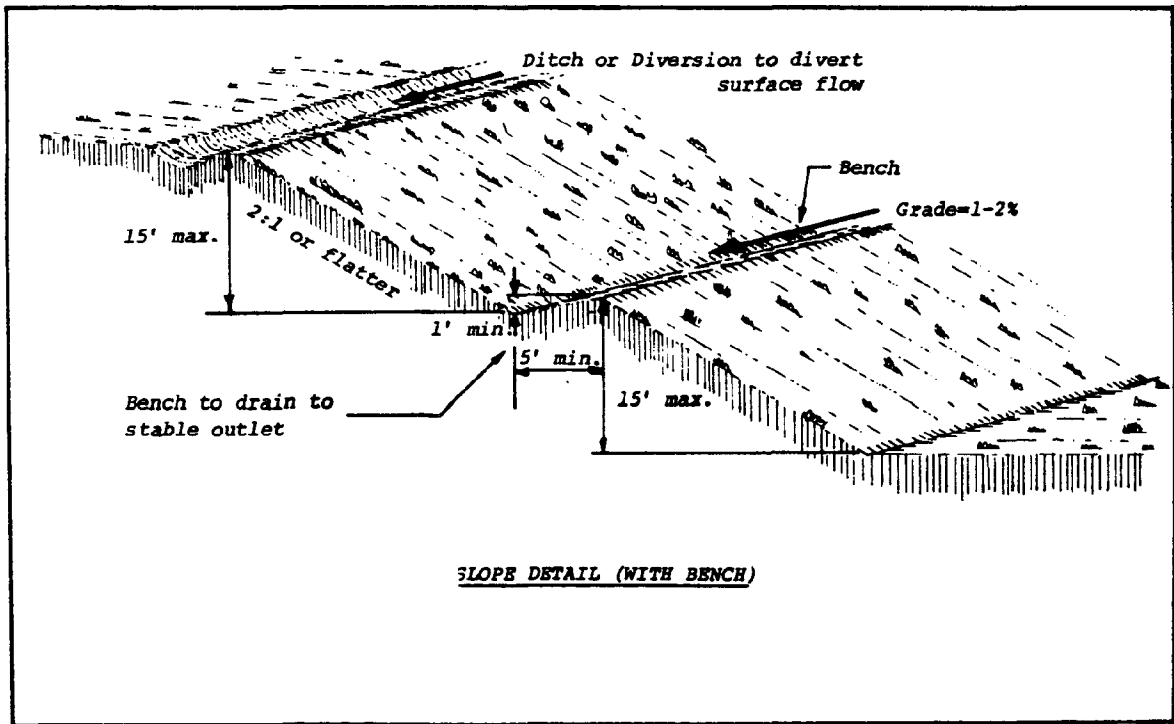

(adapted from USDA, Soil Conservation Service, College Park, Maryland, Standards and Specifications for Soil Erosion and Sediment Control in Developing Areas, July 1975.)

17. PROTECTIVE MATERIALS FOR CHANNELS AND STEEP SLOPES

July 1975

STANDARD AND SPECIFICATIONS FOR PROTECTIVE MATERIALS FOR CHANNELS AND STEEP SLOPES*

Definition

Installing jute or excelsior mattings on a prepared seed - or planting - bed of a channel or steep slope to be stabilized with vegetation.

Purpose

As an aid to controlling erosion on critical sites during establishment period of protective vegetation.

Conditions Where Practice Applies

In channels where designed flow exceeds 3.5 feet per second; on short, steep slopes where erosion hazard is high and planting is likely to be slow to establish adequate protective cover; on tidal - or stream - banks where moving water is likely to wash out new vegetative plantings.

MATERIALS

- A. Jute mat shall be cloth of a uniform plain weave of undyed and unbleached single jute yarn, 48 inches in width plus or minus 1 inch and weighing an average of 1.2 pounds per linear yard of cloth with a tolerance of plus or minus 5 percent, with approximately 78 warp ends per width of cloth and 41 weft ends per linear yard of cloth. The yarn shall be of a loosely twisted construction having an average twist of not less than 1.6 turns per inch and shall not vary in thickness by more than one half its normal diameter.
- B. Excelsior mat shall be wood excelsior, 48 inches in width plus or minus 1 inch and weighing 0.8 pounds per square yard plus or minus 10 percent. The excelsior material shall be covered with a netting to facilitate handling and to increase strength.
- C. Glass fiber matting of bonded textile glass fibers with an average fiber diameter of 8 to 12 microns, 2 to 4 inch strands of fiber bonded with phenol formaldehyde resin. Mat shall be roll type, water permeable, minimum thickness 1/4 inch, maximum thickness 1/2 inch, density not less than 3 pounds per cubic foot.
- D. Staples - staples for anchoring soil stabilizing materials shall be no. 11 gauge wire or heavier. Their length shall be 6 to 10 inches, with the longer staples used on loose, unstable soils.

*from USDA, Soil Conservation Service, College Park, Maryland. Standards and Specifications for Soil Erosion and Sediment Control in Developing Areas. July 1975.

INSTALLATION REQUIREMENTS

Site Preparation: After site has been shaped and graded to approved design, prepare a friable seedbed relatively free from clods and rocks more than 1-1/2 inches in diameter, and any foreign material that will prevent contact of the protective mat with the soil surface.

Planting: Lime, fertilize, and seed in accordance with seeding or other type of planting plan, except when using jute matting on a seeded area, apply approximately one-half the seed after laying the mat. The protective matting can be laid over sprigged areas where small grass plants have been planted. Where ground covers are to be planted, lay the protective matting first and then plant through the matting according to design of planting.

Erosion Stops: (For use on steep, highly erodible watercourses) Erosion stops are made of glass fiber strips, excelsior matting strips or tight-folded jute matting blanket or strips. They are placed in narrow trenches 6 to 12 inches deep across the channel and left flush with the soil surface. They are to cover the full cross-section of designed flow.

How Used: Under jute or excelsior matting.

Location:

1. Approximately 3 feet down channel from point of entry of a concentrated flow such as from culverts, tributary channels or diversions.
2. At points where change in gradient or course of channel occurs.
3. Spacing of erosion stops on long slopes will vary from 20 to 100 feet depending upon the erodibility of the soil and velocity and volume of flow.

Installation:

Erosion stops should extend beyond the channel liner to full design cross-section of the channel to check any rills that might form outside the channel lining.

The trench may be dug with a spade or a mechanical trencher making sure that the down slope face of the trench is flat; it should be uniform and perpendicular to line of flow to permit proper placement and stapling of the glass fiber matting.

The erosion stop should be deep enough to penetrate solid material or below level of rilling in sandy soils. In general, erosion stops will vary from 6 to 12 inches in depth.

The erosion stop mat should be wide enough to allow a minimum of 2 inch turnover at bottom of trench for stapling while maintaining the top edge flush with channel surface.

Tamp back fill firmly and to a uniform gradient of channel.

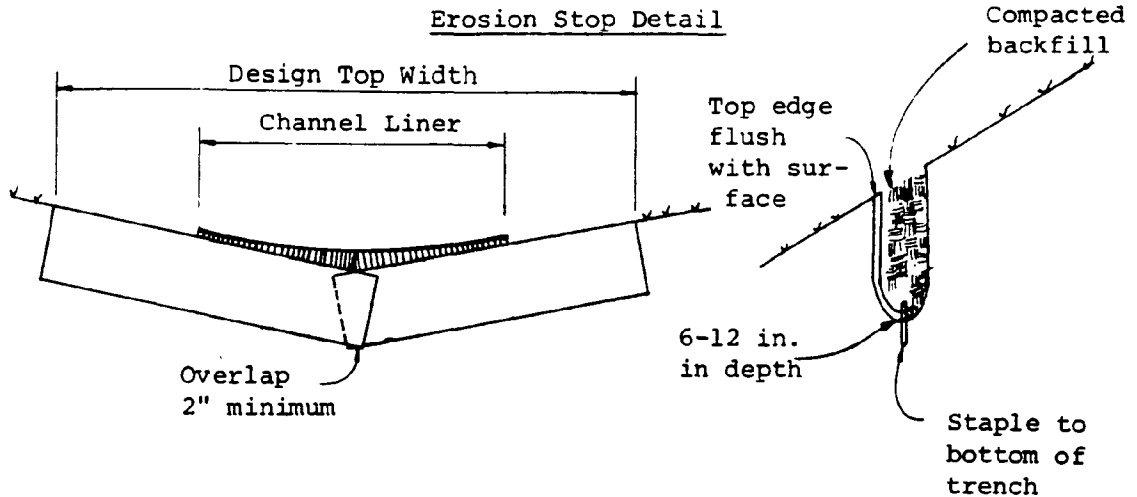

If seeding has been done prior to installation of erosion stops, reseed disturbed areas prior to placement of channel liner.

Laying Jute Matting: (If instructions have been followed, all needed erosion stops will have been installed, and the jute matting will be laid on a friable seedbed free from clods, rocks, roots, etc., that might cause bridging.)

Most channels will require multiple widths of jute matting, two widths being the most commonly used. Unroll matting starting at the upper end of the channel allowing a 4 inch overlap of mattings along center of channel.

Securing Jute Matting: Bury the top ends of jute matting in a narrow trench, minimum of 6 inch depth, similar to that used for erosion stops. Backfill trench and tamp firmly to conform to channel cross-section. Secure with a row of staples about 4 inches down slope from the trench. Spacing between staples is 6 inches.

Next, staple the 4 inch overlap in channel center using an 18 inch spacing between staples. Before stapling the outer edges of the matting, make sure the matting is smooth and in firm contact with the soil in its entirety, staples shall be placed 2 feet apart along the outer edge of matting.

Where one roll of jute matting ends and another begins, the end of the top strip shall overlap the upper end of the lower strip by 4 inches, shiplap fashion.

Where matting crosses erosion stops, reinforce with a double row of staples 6 inch spacing, staggered pattern on either side of erosion stop. Likewise, overlaps, joining the length of matting together and the discharge end of the matting liner should be similarly secured with 2 double rows of staples.

Laying and Securing Excelsior Matting: Same seedbed preparation as for jute matting with the exception that all seeding must be completed before laying excelsior matting.

Bury top ends of excelsior matting in a slit trench as described for jute matting. As the blankets are unrolled down slope, the matting must be on top with the wood fibers in contact with the soil. Butt snugly at ends and sides before stapling.

Using 2 foot spacing between staples, excelsior matting shall be secured with three rows for each strip, with one row along each edge and one alternating parallel rows down the center. The stapling over erosion stops, entrance and discharge ends of matting and butted end joints shall be the same as described for jute matting.

Final Check

1. Make sure matting is uniformly in contact with the soil.
2. All lap joints are secure.
3. All staples are flush with the ground.
4. All disturbed areas seeded.

DETAIL FOR STABILIZING WATERWAYS WITH JUTE THATCHING

A. Bury the top end of the jute strips in a trench 6 inches or more in depth.

B. Tamp the trench full of soil. Secure with row of staples, 6 inch spacing, 4 inches down from the trench

C. Overlap--Bury upper end of lower strip as in 'A' and 'B'. Overlap end of top strip 4 inches and staple.

D. Erosion stop--Fold of jute buried in slit trench and tamped; double row of staples.

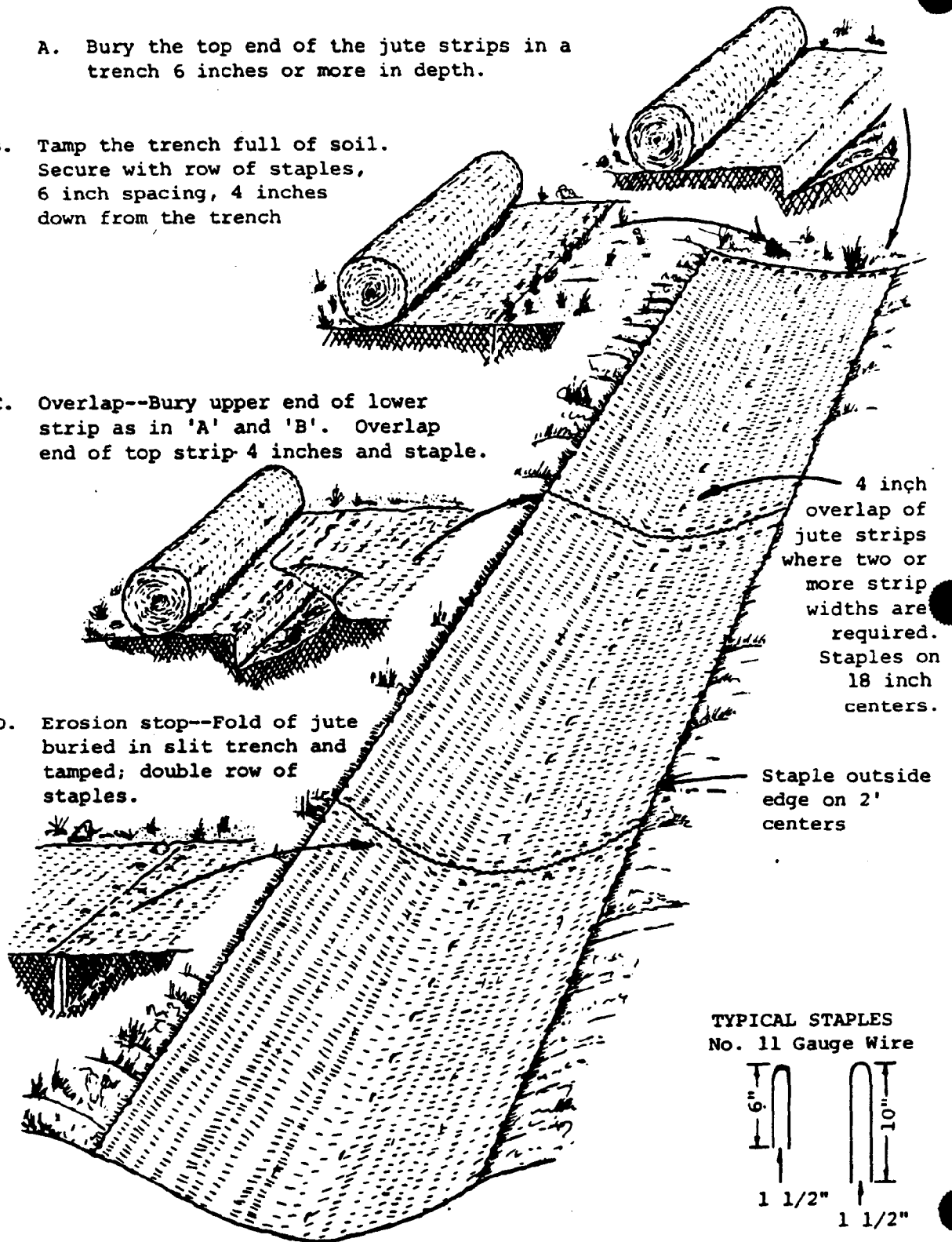

TYPICAL STAPLES
No. 11 Gauge Wire

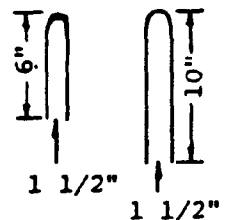

VI. ENFORCEMENT GUIDELINES FOR ON-SITE EROSION AND SEDIMENT CONTROL

An ordinance, a manual of standards and specifications, and erosion and sediment control plan guidelines are the written requirements of an ideal regulatory program. Once these are in place, it should then be the responsibility of the site inspector to see that erosion and sediment are controlled on the site.

The following guidelines, based on current practices in Alameda County and other areas, are presented as a checklist for plan reviewers and site inspectors to help them obtain compliance with regulations and deal with violations. It is recommended that local cities and counties adopt these or similar enforcement guidelines as official planning department and public works procedures.

1. PRE-WINTERIZING MEETING

Well before the expected onset of the rainy season (or before the site has been disturbed if startup is to be during the rainy season), a site meeting is strongly recommended to ensure that everyone concerned understands and will carry out the erosion and sediment control plan during the ensuing winter.

a. Scheduling

For projects already under construction, hold the pre-winterizing meeting about a month before the date erosion control measures are expected to be in place. Allow more lead time for large, difficult sites; less time for small, easily controlled sites. For work starting during the rainy season, hold the meeting any time before start of work but plan some lead time. Hold the pre-winterizing meeting every year during which the grading and construction permits are active, unless the agency has determined that the site is and will remain stable.

b. Attendance

Hold the meeting on-site and have the following people attend:

- the developer or a representative authorized to commit him to action;
- the developer's on-site superintendent;
- the grading contractor's on-site superintendent;
- the consulting civil engineer and/or landscape architect responsible for development of the erosion and sediment control plan;

- the consulting soils engineer if his or her input affected the erosion and sediment control plan in any important way;
- the chief inspector from the city or county;
- the inspector for the site from the city or county;
- the plan reviewer who checked the erosion and sediment control plan for the city or county.

Many of these people can be eliminated at any particular meeting if it is foreseen that their input will not be needed but, at a minimum, the city or county inspector for the project and the developer or his or her on-site superintendent must be there.

c. Preparation

Before the meeting, the city or county job inspector should go over the plan in detail with the plan checker to be sure he understands it. The developer's and contractor's on-site superintendents should meet with the consultant responsible for development of the erosion and sediment control plan to be sure they understand it. The latter group should also prepare a realistic updated schedule of activities affecting the plan through the winter, such as completion of grading, storm drainage, paving, etc., and a schedule of implementation of erosion and sediment control measures. Several copies of these schedules, the grading plans and the erosion and sediment control plans should be brought to the meeting.

d. At the Meeting

The pre-winterizing meeting should result in a mutual understanding of the erosion and sediment control plan. Critical measures and sensitive areas, how runoff will be managed (what goes where), and dates when key activities will be started or finished should all be identified. Modify the erosion and sediment control plan as necessary at this time to reflect site conditions and scheduling. Modifications should appear on all copies of the plan.

2. INSPECTIONS

The following inspections are recommended as a minimum:

a. Initial Inspection

Inspect when the site is staked for grading but grading has not begun.

b. Rough Grading Inspections

Inspect at key points during rough grading, including stripping, keying, compaction and installation of subsurface drains.

c. Erosion Control Compliance Inspection

This inspection applies if final stabilization inspection has not been passed before the beginning of the rainy season.

Inspect when the erosion and sediment control plan or ordinance requires completion of vegetative and structural measures (generally by October 1). It is strongly recommended that an inspector be present at the construction site when seeding is done to review the seed tags and guarantee the application of the seed, fertilizer and mulch according to the composition and rate given in the specifications.

d. Final Grading Inspection

Inspect when all grading, drainage, paving, planting and permanent erosion and sediment control structures are complete.

e. Final Stabilization Inspection

Inspect when the site is presumed stable.

For erosion and sediment control purposes, make additional inspections on large or difficult (erosion-prone) sites during the rainy season as follows:

- during or immediately after all major rain storms to check on performance of facilities and to correct problems;
- at key points in the construction of major facilities such as sediment basins.

In addition, check the site when grading is occurring near sensitive features, such as watercourses, lakes and trees to be saved.

During any inspection, the inspector should watch for:

- facilities that are incomplete, damaged or inadequately maintained, such as dikes cut through by tire tracks;
- grading or drainage control situations that direct runoff to slopes or to facilities not designed to accept it;
- unnecessary removal of vegetative cover, for example, in areas not to be graded;
- debris or soil deposits in or on the banks of watercourses or lakes;

- sediment basins or traps needing cleanout;
- runoff from graded areas reaching storm drains, flowing off-site or flowing into watercourses without benefit of filtration or settlement of sediment;
- situations developing that are not adequately covered by the erosion and sediment control plan;
- evidence of sediment deposition in storm drains, watercourses or adjacent properties;
- erosion occurring on finished slopes.

3. REPORTS

Under some circumstances, an inspection may not be necessary when a site presents no problems or is well stabilized. In such cases a written report from the developer may suffice. This will conserve staff time for the agency and money for the developer. One way to handle such reports is to use standard forms, perhaps in the form of a checklist. In this manner, all the necessary information will be received by the agency with a minimum of time expended. Such forms must be tailored to the specific ordinance and procedural requirements of each agency. Reports should certify the conditions found and be signed by a representative of the developer with the authority and expertise to make such certification (see Sample Permittee Report Form).

4. VIOLATIONS

When routine enforcement actions are not sufficient to achieve compliance with regulations, the following procedure is recommended:

a. Oral Notice

First inform the superintendent and developer orally that they are not in compliance.

b. Written Notice

If action is not taken within the specified time (a practical time for making necessary corrections), issue a written violation notice to the developer. The violation notice should contain the following:

- citation of the pertinent ordinance;
- description of what the violation is and what must be done to correct it;

SAMPLE PERMITTEE REPORT FORM

Status of Erosion Control Activities

1. Date:
2. Project Name: Permit No.
3. Location:
4. Name and title of person preparing this report:
5. Is the project on schedule as specified in the approved Grading Plan? Yes _____ No _____
If no, explain:
6. Are there any other departures from the approved Site Map and Grading Plan which may affect implementation of the Interim or Final Erosion and Sediment Control Plans as scheduled?
Yes _____ No _____
If no, explain:
7. Indicate possible delays in obtaining materials, machinery, services or manpower necessary to implement the Interim or Final Plans as scheduled.
8. Describe the progress of or delays in the implementation of the Interim or Final Plans (including installation of each planned sediment basin or trap and application of seed and mulch to specified slopes).
9. Describe any other departures from the implementation of the Interim or Final Plans.

- deadline for correction;
- signature of inspector.

Submit one copy to the department supervisor and one copy to the developer. (To eliminate criticism from developers, it is advisable for the inspector or his supervisor to give notice of the violation to the superintendent on-site the same day the violation is written. This procedure gives the developer the benefit of the full amount of time granted for correction.)

c. Follow-Up Inspection

Inspect the site on the last day allowed for correction in the violation notice or one or two days thereafter. Fill out a violation status report either releasing the violation if the work has been done, or indicating that the work has not been done and making a recommendation for further action. Submit copies of the violation status report to both the department supervisor and the developer.

The department supervisor should then take appropriate action pursuant to the erosion and sediment control ordinance.

APPENDICES

APPENDIX A

MODEL ORDINANCE NO. 1

(An Erosion and Sediment Control Ordinance to Supplement Existing Grading Regulations)

In the text of the model, passages or blanks enclosed in brackets are intended to be filled in by local jurisdictions. Substantive changes to other parts of the model may undermine the effectiveness of the erosion and sedimentation control program.

Article I

Title, Purpose and General Provisions

- 101.00 Title. This ordinance shall be known as the "[City/County] Erosion and Sediment Control Ordinance" and may be so cited.
- 101.01 Purpose. The purpose of this Chapter is to promote and protect the public interest by regulating land disturbances, land fill and soil storage in connection with the clearing and grading of land for construction. The intent of this ordinance is to establish administrative procedures, minimum standards of review and implementation and enforcement procedures for the protection and enhancement of the water quality of watercourses, water bodies and wetlands, natural and man-made, by controlling erosion, sedimentation, increases in surface runoff and related environmental damage caused by construction-related activities.
- 101.02 Definitions. When used in this Chapter, the following words shall have the meanings ascribed to them in this Section:
- (a) Administrator: the Director of [] and duly authorized agents and employees of [].
 - (b) Applicant: any person, corporation, partnership, association of any type, public agency or any other legal entity who submits an application to the Administrator for a permit pursuant to this Chapter.

- (c) Best Management Practice (BMP): a technique or series of techniques which, when utilized in a designated manner, is proven to be effective in controlling construction-related runoff, erosion and sedimentation (see §101.02(j)).
- (d) Chapter: this ordinance in its entirety.
- (e) Erosion: the action or process of wearing away of earth or soil by the action of water.
- (f) Final Erosion and Sediment Control Plan: a set of measures designed to control surface runoff and erosion and to retain sediment on a particular site after all other planned final structures and permanent improvements have been erected or installed.
- (g) Interim Erosion and Sediment Control Plan: a set of measures designed to control surface runoff and erosion and to retain sediment on a particular site during the period in which pre-construction and construction-related land disturbances, fills and soil storage occur.
- (h) Land disturbance/land disturbing activities: any human activity moving or removing the soil mantle or top 6 inches of soil whichever is shallower.
- (i) Land fill: any human activity depositing soil or other earth materials.
- (j) Manual of Standards (Manual): a compilation of technical application standards and design specifications adopted by the Administrator as being proven methods of controlling construction-related surface runoff, erosion and sedimentation (see §101.02(c)).
- (k) Permittee: the applicant in whose name a valid permit is duly issued pursuant to this Chapter and his/her/its agents, employees and others acting under his/her/its direction.
- (l) Sediment: material deposited by water.
- (m) Site: a parcel or parcels of real property owned by one or more than one person which is being or is capable of being developed as a single project.
- (n) Wet season: the period from [October 15 to April 15].
- (o) Watercourse: [to be defined and designated by the local jurisdiction].

101.03 Severability and Validity. If any part of this ordinance is found not valid, the remainder of this ordinance shall remain in effect.

101.04 Nuisance Abatement. Neither this Chapter, nor any administrative ruling made under it, limits:

- (a) The power of the [City/County] to declare, prohibit and abate a nuisance; or
- (b) The right of any person to maintain, at any time, any appropriate action for relief against any private nuisance, or for relief against any contamination or pollution.

Article II

Permit Application Procedures

- 201.01 Scope. No person may grade, fill, excavate, store or dispose of soil and earthen materials or perform any other land-disturbing or land-filling activity without first obtaining a Permit as set forth in this Chapter.
- 201.02 Exemptions. All land-disturbing or land-filling activities or soil storage shall be undertaken in a manner designed to minimize surface runoff, erosion and sedimentation.
- (a) General Exemptions: A person performing such activities need not apply for a Permit pursuant to this Chapter, if all the following criteria are met:
- (1) The land area disturbed or filled is 1/4 acre or less;
 - (2) Natural and finished slopes are less than 10%;
 - (3) Volume of soil or earth materials stored is 50 cubic yards or less;
 - (4) Rainwater runoff is diverted, either during or after construction, by the activities from an area smaller than 5,000 square feet;
 - (5) An impervious surface, if any, of less than 5,000 square feet is created;
 - (6) No drainageway is blocked or has its stormwater carrying capacities or characteristics modified;
 - (7) No land-disturbing or filling activities occur within 100 feet of a watercourse.
- (b) Specific Exemptions: Section (a) notwithstanding, a person performing the following activities need not apply for a Permit pursuant to this Chapter:
- (1) Routine agricultural crop management practices;
 - (2) Work to correct or remedy emergencies posing an immediate danger to life or property, or substantial flood or fire hazards.

202.00 Application. The application for a Permit must include all of the following items:

- (a) Application form;
- (b) Site Map and Grading Plan;
- (c) Interim Erosion and Sediment Control Plan;
- (d) Final Erosion and Sediment Control Plan, where required (see §301.07);
- (e) Soils and Geological Reconnaissance Report, where required (see §301.05);
- (f) Work schedule;
- (g) Application fees;
- (h) Performance bond or other acceptable security (see §202.07);
- (i) Any supplementary material required by the Administrator.

202.01 Application Form. The following information is required on the application form:

- (a) Name, address and telephone number of the Applicant;
- (b) Names, addresses and telephone numbers of any and all contractors, subcontractors or persons actually doing the land-disturbing activity and their respective tasks;
- (c) Name(s), address(es) and telephone number(s) of the person(s) responsible for the preparation of the Site Map and Grading Plan;
- (d) Name(s), address(es) and telephone number(s) of the person(s) responsible for the preparation of the Interim and/or Final Erosion and Sediment Control Plan;
- (e) Name, address and telephone number of the registered [Geologist] responsible for the preparation of the Soils and Geological Reconnaissance Report, where required (see §301.05);
- (f) A vicinity map showing the location of the site in relationship to the surrounding area's watercourses, water bodies and other significant geographic features, and roads and other significant structures;

- (g) Date of the application;
- (h) Signature(s) of the owner(s) of the site or of an authorized representative.

202.02 Site Map and Grading Plan. The Site Map and Grading Plan shall contain all the following information:

- (a) Existing and proposed topography of the site taken at not more than a [x-foot] contour interval over the entire site. Ninety percent (90%) of the contours shall be plotted within one contour interval of the true location;
- (b) Two contour intervals that extend a minimum of [100 feet off-site, or sufficient to show on- and off-site drainage];
- (c) Site's property lines shown in true location with respect to the plan's topographic information;
- (d) Location and graphic representation of all existing and proposed natural and man-made drainage facilities;
- (e) Location and graphic representation of proposed excavations and fills, of on-site storage of soil and other earthen material, and of on-site disposal;
- (f) Location of existing vegetation types and the location and type of vegetation to be left undisturbed;
- (g) Location of surface runoff, erosion and sediment control measures as required under §202.03(d);
- (h) Quantity of soil or earthen materials in tons and cubic yards to be excavated, filled, stored or otherwise utilized on-site;
- (i) Outline of the methods to be used in clearing vegetation, and in storing and disposing of the cleared vegetative matter;
- (j) Proposed sequence and schedule of excavation, filling and other land-disturbing and filling activities, and soil or earthen material storage and disposal.

202.03 Interim Erosion and Sediment Control Plan (Interim Plan). All the following information shall be provided with respect to conditions existing on the site during land-disturbing or filling activities or soil storage:

- (a) Maximum surface runoff from the site shall be calculated using the method approved by the Administrator and maintained in the Manual, or any other method proven to the Administrator to be as or more accurate;
- (b) Sediment yield shall be calculated using the method approved by the Administrator and maintained in the Manual, or any other method proven to the Administrator to be as or more accurate;
- (c) The Interim Plan shall also contain the following information:
 - (1) a delineation and brief description of the measures to be undertaken to retain sediment on the site, including, but not limited to, the designs and specifications for berms and sediment detention basins, and a schedule for their maintenance and upkeep,
 - (2) a delineation and brief description of the surface runoff and erosion control measures to be implemented, including, but not limited to, types and method of applying mulches, and designs and specifications for diverters, dikes and drains, and a schedule for their maintenance and upkeep,
 - (3) a delineation and brief description of the vegetative measures to be taken, including, but not limited to, seeding methods, the type, location and extent of pre-existing and undisturbed vegetation types, and a schedule for maintenance and upkeep;
- (d) The location of all the measures listed by the Applicant under Subsection (c) above, shall be depicted on the Site Map and Grading Plan (see §202.02 (f)-(g));
- (e) An estimate of the cost of implementing and maintaining all interim erosion and sediment control measures must be submitted in a form acceptable to the Administrator.

202.04 Final Erosion and Sediment Control Plan (Final Plan). All the following information shall be provided with respect to conditions existing on the site after final structures and improvements (except those required under this Section) have been completed and where these final structures have not been covered by an Interim Plan, (see §301.07):

- (a) Maximum runoff from the site shall be calculated using the method approved by the Administrator and maintained in the Manual, or any other method proven to the Administrator to be as or more accurate;
- (b) Sediment yield shall be calculated using the method approved by the Administrator and maintained in the Manual, or any other method proven to the Administrator to be as or more accurate;
- (c) The Final Plan shall also contain the following information:
 - (1) a description of and specifications for sediment retention devices,
 - (2) a description of and specifications for surface runoff and erosion control devices,
 - (3) a description of vegetative measures,
 - (4) a graphic representation of the location of all items in Subsections (1)-(3) above;
- (d) An estimate of the costs of implementing all final erosion and sediment control measures must be submitted in a form acceptable to the Administrator.

202.05 Soils and Geological Reconnaissance Report (Soils Report). A Soils Report, when required by the Administrator (see §301.05), shall be based on adequate test borings, as necessary, and shall contain all the following information:

- (a) Data regarding the nature, distribution and erodibility of existing soils;
- (b) Data regarding the nature, distribution and erodibility of soil to be placed on the site, if any;
- (c) Conclusions and recommendations for grading procedures;
- (d) Conclusions and recommended designs for interim soil stabilization devices and measures and for permanent soil stabilization after construction is completed.

202.06 Work Schedule. The Applicant must submit a master work schedule showing the following information:

- (a) Proposed grading schedule;

- (b) Proposed conditions of the site on each [July 15, August 15, September 15, October 1 and October 15] during which the Permit is in effect;
- (c) Proposed schedule for installation of all interim erosion and sediment control measures including, but not limited to, the stage of completion of erosion and sediment control devices and vegetative measures on each of the dates set forth in Subsection (b);
- (d) Schedule for construction, if any;
- (e) Schedule for installation of permanent erosion and sediment control devices where required (see §301.07).

202.07 Security

- (a) The Applicant shall provide security for the performance of the work described and delineated on the approved Grading Plan in an amount to be set by the Administrator [but not to exceed 100%] of the approved estimated cost of the grading. The form of security shall be one or a combination of the following to be determined by the Administrator:
 - (1) bond or bonds issued by one or more duly authorized corporate sureties. The form of the bond or bonds shall be subject to the approval of the [City Attorney/County Counsel],
 - (2) deposit, either with the city or a responsible escrow agent or trust company at the option of the [City/County], of money, negotiable bonds of the kind approved for securing deposits of public monies, or other instrument of credit from one or more financial institutions subject to regulation by the State or Federal government wherein said financial institution pledges funds are on deposit and guaranteed for payment.
- (b) The Applicant shall provide security for the performance of the work described and delineated in the Interim Plan in an amount to be determined by the Administrator but not less than 100% of the approved estimated cost of performing said work. The form of the security shall be as set forth in Subsections (a)(1) and (2).
- (c) The Applicant shall provide security for the performance of the work described and delineated in the Final Plan in an amount to be determined by the Administrator but not less than 100% of the approved estimated cost of

performing said work. The form of the security shall be as set forth in Subsections (a)(1) and (2).

- 203.01 Fees. The following fees are to be paid pursuant to a schedule of fees adopted, and amended from time to time by the [City Council/Board of Supervisors] upon recommendation by the Administrator:
- (a) A permit processing fee, to be paid at the time the permit application is submitted;
 - (b) An inspection fee to be paid at the completion of the work described in the Interim Plan;
 - (c) An inspection fee to be paid at the completion of the work described in the Final Plan;
 - (d) The Administrator may at his option require partial payment of the fees set forth in Subsections (b) and (c) of this Section before issuing a permit.
- 204.01 Decision on a Permit. The Administrator shall review all documents submitted pursuant to this Chapter and, if necessary, request additional data, clarification of submitted data or correction of defective submissions within 10 working days after the date of submission. The Administrator shall notify Applicant of his decision on the permit within 20 working days of the initial submission or of the corrected submissions, whichever is later.
- 204.02 Permit Issuance. Approval of an application by the Administrator shall be issued, if at all, within [3] working days.
- 204.03 Permit Duration. Permits issued under this Chapter shall be valid for the period during which the proposed land-disturbing or filling activities and soil storage takes place or is scheduled to take place, whichever is shorter. Permittee shall commence permitted activities within 60 days of the scheduled commencement date for grading or the Permittee shall resubmit all required application forms, maps, Plans, schedules and security to the Administrator. The Administrator may require additional fees.
- 204.04 Permit Denial. The Applicant may request a hearing before the [City Council/Board of Supervisors] within [5] working days of notification of a permit denial. The hearing shall be held within [15] working days.

204.05

Assignment of Permit. A Permit issued pursuant to this Chapter may be assigned, provided:

- (a) The Permittee notifies the Administrator of the proposed assignment;
- (b) The proposed assignee:
 - (1) submits an application form pursuant to §202.01, and
 - (2) agrees in writing to all the conditions and duties imposed by the Permit, and
 - (3) agrees in writing to assume responsibility for all work performed prior to the assignment, and
 - (4) provides security pursuant to §202.07, and
 - (5) agrees to pay all applicable fees pursuant to §203.01;
- (c) The Administrator approves the assignment.

The Administrator shall set forth in writing the reasons for his/her approval or disapproval of an assignment.

Article III

Review Standards and Procedures

- 301.01 Review Policy. The Administrator shall issue a Permit provided he/she finds that the plans submitted in application for a Permit individually and in the aggregate:
- (a) Protect the quality of receiving waters;
 - (b) Minimize surface runoff, erosion and off-site sedimentation:
 - (1) to the extent feasible, or
 - (2) in the case where the work site is situated in a §201.02(a)(7) area, to the extent possible.
- 301.02 Site Map and Grading Plan. Before approving the Site Map and Grading Plan, the Administrator shall find as required by §301.01.
- (a) The review process shall include, but is not limited to, examination of the Site Map and Grading Plan for:
 - (1) adherence to the requirements set forth in §202.02,
 - (2) signature(s) by a [Civil Engineer, or other qualified persons],
 - (3) internal coherence.
 - (b) Where the Site Map and Grading Plan cannot be approved as submitted, the Administrator may require the Applicant to adopt one or all of the following measures:
 - (1) reduce the area of land to be disturbed,
 - (2) restrict land-disturbing or filling activities or soil storage to the dry season (see also §402.01(c)),
 - (3) revise and resubmit Site Map and Grading Plan.
 - (c) The Site Map and Grading Plan, if approved, either as submitted or as modified under Subsection (b), is part of the Permit.

301.03 Interim Plan. Before approving the Interim Plan, the Administrator shall find as required by §301.01.

- (a) The Applicant may propose the use of any erosion and sediment control techniques in the Interim Plan provided such techniques are proven to be as or more effective than the equivalent BMP contained in the Manual.
- (b) The review process shall include, but is not limited to, examination of each proposed technique, individually or in the aggregate, for:
 - (1) suitability to and effectiveness under the anticipated conditions at the work site both at the onset of and throughout the wet season,
 - (2) location(s) on the work site,
 - (3) size(s), carrying or holding capacity(ies) and design(s) for controlling the predicted surface runoff and sediment yield,
 - (4) allotted time(s) for full installation and implementation,
 - (5) sequencing, both among themselves and in concert with land-disturbing activities, especially when land-disturbing and filling activities and soil storage will commence either at the onset of or during the wet season,
 - (6) proposed maintenance method(s) and schedule(s).
- (c) The Administrator shall require the Applicant to change the proposed technique or BMP, or any facet thereof, where he/she deems necessary.
- (d) The Interim Plan, as approved or as modified under §402.02(a), is a part of the Permit.

301.04 Final Plan. Before approving the Final Plan, the Administrator shall find as required under §301.01.

- (a) The Applicant may propose the use of any erosion and sediment control techniques in the Final Plan provided such techniques are proven to be as or more effective than the equivalent BMP contained in the Manual.
- (b) The review process shall include, but is not limited to, examination of each proposed technique, individually and in the aggregate, for:

- (1) suitability to and effectiveness under the anticipated conditions at the work site throughout the period during which the Final Plan is to be implemented and in effect,
 - (2) location(s) on the work site,
 - (3) adequacy of the proposed size(s), carrying and holding capacity(ies) and design(s) for controlling the predicted surface runoff and sediment yield,
 - (4) allotted time(s) for full installation and implementation,
 - (5) proposed maintenance method(s) and schedule(s).
- (c) The Administrator shall require the Applicant to change the proposed technique or BMP, or any facet thereof, where he/she deems necessary.
- (d) The Final Plan, as approved or as modified under §402.02(a), is a part of the Permit.

301.05 Soils Report. A Soils Report meeting the criteria set forth in §202.05 shall be required for all Major Permits. A Soils Report shall also be required for a Minor Permit unless the Administrator determines that all of the following apply:

- (a) The soil type for the region in which the work site is situated is recorded in the Manual, an official survey by local state or federal agencies or other widely recognized authority in the field of [];
- (b) The soil type, as recorded, is sufficiently precise to be utilized in the equations, referenced in §§202.03(b) and 202.04(b);
- (c) The soil on the work site is representative of the region surveyed by the literature of Subsection (a);
- (d) The site is not in a §201.02(a)(7) area.

301.06 Work Schedule. The Administrator shall review the work schedule for overall coherence. Any modifications to the Site Map and Grading Plan, Interim Plan and Final Plan shall be noted on the work schedule and the schedule modified, as necessary.

301.07

Coordination with Other Permits. Where a person applies to the Administrator for a Permit pursuant to this Chapter and either does not apply for the necessary permits to make improvements on the same site or applies for the permits necessary to make only a portion of the prospective improvements on the same site, the Applicant need not submit a Final Plan for the site or those portions of the site wherein Applicant does not plan to make improvements, and this Section shall apply.

- (a) The Interim Plan shall be adequate to control surface runoff and sedimentation from the unimproved areas of the site for the period of time between termination of the Permit and implementation of a Final Plan, pursuant to Subsection (c) of this Section.
- (b) The security for the Interim Plan shall be retained until a Final Plan(s) has been implemented. The security may be released on a pro rata basis where a Final Plan or series of Final Plans is/are implemented for a portion or portions of the site.
- (c) No [building permit, permit of occupancy, etc.] shall be issued until the Applicant for such a permit has presented to the permitting agency certification from the Administrator that:
 - (1) a Final Plan has been filed with and approved by the Administrator pursuant to this Chapter,
 - (2) security for the Final Plan has been posted in accordance with §202.07(c),
 - (3) Applicant presenting such certification has agreed in writing to implement the Final Plan pursuant to the requirements and enforcement procedures of this Chapter,
 - (4) Applicant has paid all pertinent fees.

Article IV
Implementation and Enforcement

401.01 Minor Permit.

(a) The Administrator shall issue a Minor Permit only if:

- (1) total area of disturbed or filled land is [1/4] acre or less, and the natural and/or finished slopes are greater than 10%, and are also 15%, or less, or
- (2) rainwater runoff is diverted from a total area of [1/4] acre or less, or a total area of [1/4] acre or less is made impervious, and the natural and/or finished slopes are greater than 10% and are also 15% or less, or
- (3) total area of disturbed or filled land is [3/4] acre or less and greater than [1/4], and the natural and/or finished slopes are 15%, or less, or
- (4) rainwater runoff is diverted from a total area of [3/4] acre or less and the natural and/or finished slopes are 15%, or less, or
- (5) total area of disturbed or filled land is greater than [3/4] acre but less than [5] acres, and the natural and finished slopes are 2%, or less, or
- (6) rainwater runoff is diverted from a total area greater than [3/4] acre but less than [5] acres, and the natural and/or finished slopes are 2%.

Provided, in all of the situations defined in (a)(1)-(6), above:

- (7) total volume of stored soil is [1,200 cubic yards] or less, and
 - (8) none of the activity is in a §201.02(a)(7) area.
- (b) The Minor Permit is issued subject only to the conditions set forth in §401.03.

- (c) The Administrator shall enforce a Minor Permit only through the procedures set forth in §403.01, or by inspections at the discretion of the Administrator, or by any other means available at law or in equity.

401.02 Major Permit.

- (a) All permits other than Minor Permits issued under this Chapter are Major Permits.
- (b) The Major Permit is issued subject to the conditions set forth in §§401.03 and 402.01-02.
- (c) The Administrator shall enforce a Major Permit through any procedures set forth in this Article or by any other means available at law or in equity.

401.03 Issuance of Major and Minor Permits. Administrator shall issue a Major or Minor Permit upon approval of a Site Map and Grading Plan, Interim Plan, Final Plan, where required (see §301.07), Soil Report, where required (see §301.05), deposit of appropriate security and payment of fees. The Major and Minor Permits shall be issued subject to the following conditions:

- (a) The Permittee shall maintain a copy of the Permit, approved plans and, for Major Permits only, reports required under §402.01, on the work site and available for public inspection during all working hours;
- (b) The Permittee shall, at all times, be in conformity with approved Site Map and Grading Plan, Interim and Final Plans.

402.01 Implementation of Major Permits--Permittee's Duties. In addition to performing as required under §401.03, Permittee shall:

- (a) Notify the Administrator, at least forty-eight (48) hours beforehand, of the beginning of land-disturbing or filling activities or soil storage;
- (b) Submit to the Administrator, reports on:
 - (1) the progress of or delays in land-disturbing or filling activities or soil storage,
 - (2) any other departures from the approved Site Map and Grading Plan which may affect implementation of the Interim or Final Plans as scheduled,

- (3) possible delays in obtaining materials, machinery, services or manpower necessary to the implementation of the Interim or Final Plans as scheduled,
- (4) the progress of or delays in the implementation of the Interim or Final Plans,
- (5) any other departures from implementation of the Interim or Final Plans,
- (6) according to the schedule set forth below:
 - (i) for the period from [April 15] to July 31, monthly;
 - (ii) for the period from August 1 to September 30, weekly;
 - (iii) for the period from October 1 to October 15, twice a week;
 - (iv) for the period from [October 16 to April 14], weekly;

(c) When Permittee proposes to commence land-disturbing or filling activities or soil storage during the wet season, Permittee shall demonstrate that land disturbance is relatively minor and that erosion can be easily controlled, or is a necessary and integral part of an Interim Plan for previously-initiated project phases. Where such activities are approved, Permittee shall submit:

- (1) a report seventy-two (72) hours prior to and, again, at the start of land-disturbing or filling activities or soil storage,
- (2) a report seventy-two (72) hours prior to and, again, at the start of implementing the Interim Plan,
- (3) a report upon completion of the Interim Plan,
- (4) any other reports required under subsection (b) of this Section.

Each report shall contain, where pertinent, the elements described in Subsections (b)(1)-(5) of this Section;

(d) Submit to the Administrator, upon termination of the Permit:

- (1) a report on and graphic representation of the Final Plan, as implemented, and
 - (2) a copy of the instructions to be given to the new owners of the improved property by the Permittee or his/her agent regarding the maintenance of the surface runoff, erosion and sediment control measures and devices implemented under the Final Plan,

or,
 - (3) for those areas where no Final Plan is required, a report and graphic representation of the Interim Plan, as implemented, and
 - (4) contracts for the maintenance and upkeep of the surface runoff, erosion and sediment control measures and devices implemented under the Interim Plan, for the period during which the site will remain unimproved;
- (e) Have an authorized representative of each contractor or subcontractor actually performing the land-disturbing or filling activities or soil storage, or actually procuring the materials, machinery, services or manpower for the implementation of Interim or Final Plans, sign each report pertinent to him or her, and certify the contents thereof as true. The Permittee shall sign all reports submitted to the Administrator and shall attest that each is true and accurate to the best of his or her knowledge.

402.02 Implementation of Major Permits--Administrator's Duties.

- (a) The Administrator shall review all reports submitted by Permittee. Where the Administrator finds:
- (1) delays in implementing or departures from the approved Site Map and Grading Plan, Interim or Final Plans,
 - (2) problems with or breakdowns in any technique provided for by the Interim or Final Plan which are attributable to:
 - (i) the Plans themselves,
 - (ii) their maintenance methods or schedules,
 - (iii) any other causes,

which may have a deleterious effect on the quality of receiving waters, or increase surface runoff, erosion or off-site sedimentation, the Administrator shall require the Site Map and Grading Plan, Interim or Final Plans, and maintenance methods and schedules be modified so as to achieve the same level of water quality and surface runoff, erosion and sediment control as would have been achieved had these problems not arisen. The Administrator shall notify the Permittee in writing of the requirement. Permittee shall comply with the order to modify within [x] working days.

- (b) The Administrator shall inspect the work site for compliance with conditions set forth in §401.03, for verification of reports submitted under §402.01, and for the quality of the work being performed under the Interim or Final Plan. Said inspections shall take place:
 - (1) [within five (5) working days of July 15],
 - (2) [within five (5) working days of September 1],
 - (3) [within five (5) working days of September 15],
 - (4) [weekly from October 1 through 15],
 - (5) [within three (3) working days of] or during, the first major rainfall of the wet season,
 - (6) under circumstances described in §402.01(c),
 - (i) at the onset of implementation of the Interim Plan, and
 - (ii) at the onset of land-disturbing or filling activities or soil storage,
 - (7) after notification to the Permittee of an order to modify under Subsection(a) of this Section,
 - (8) at any other time, at the Administrator's discretion.
- (c) The inspector shall file a written memorandum on:
 - (1) the conditions of the work site,
 - (2) whether Permittee is in compliance with approved plans,

- (3) whether Permittee is in conformity with filed reports,
- (4) whether Permittee is in conformity with the Interim or Final Plan,
- (5) whether Permittee is effectively controlling surface runoff, erosion and off-site sedimentation.

403.01 Suspension or Revocation of Permit. The Administrator shall first have resort to the procedures set forth in this Section before any other enforcement procedure set forth in this Article.

- (a) The Administrator shall suspend the Permit and issue a stop work order, and Permittee shall cease all work on the work site, except work necessary to remedy the cause of the suspension, upon notification of such suspension when:
 - (1) Permittee fails to submit reports timely and in accordance with §402.01,
 - (2) inspection by the Administrator under §402.02(b)(1)-(8) reveals that the work or the work site:
 - (i) is not in compliance with the conditions set forth in §401.03, or
 - (ii) is not in conformity with the Site Map and Grading Plan, Interim or Final Plan as approved or as modified under §402.02(a), or
 - (iii) is at variance with reports submitted under §402.01(a)-(e), or
 - (iv) is not in compliance with an order to modify under §402.02(a),
 - (3) Permittee fails to comply with an order to modify within the time limits imposed by the Administrator (see §402.02(a)).
- (b) The Administrator shall revoke the Permit and issue a stop work order, and Permittee shall cease work upon the occurrence of any of the following conditions:

(1) Permittee fails or refuses to cease work, as required under (a) above, after suspension of the Permit and receipt of a stop work order and notification thereof,

(2) any of the conditions set forth in Subsection (a) of this Section occurs in a §201.02(a)(7) area.

(c) The Administrator shall reinstate a suspended Permit upon Permittee's correction of the cause of the suspension.

(d) The Administrator shall not reinstate a revoked Permit.

403.02 Fines and Penalties. It shall be a misdemeanor for any person to perform work in violation of a stop work order issued pursuant to §403.01(a)-(b). The [City/County] may impose a fine of \$500 and/or a prison term of thirty (30) days for each day that:

(a) Permittee continues working in violation of a stop work order;

(b) Permittee is not in compliance with the Interim Plan or Final Plan at the onset of the wet season.

403.03 Action against/Release of the Security. The Administrator may request the [City Attorney/District Attorney] to commence an action against the pertinent security if:

(a) The Permittee ceases land-disturbing activities and abandons the work site prior to completion of the Site Map and Grading Plan;

(b) The Permittee fails to conform to the Interim Plan as approved or as modified under §402.02(a);

(c) The Permittee fails to comply with the Final Plan or an Interim Plan as approved or modified under §402.02(a); or the techniques utilized under either Plan fail within one (1) year of installation, or a Final Plan is implemented for the site or portions of the site, whichever is later;

The monies obtained from a successful action against the Security shall be used to finance remedial work undertaken by the [City/County] or a private contractor under contract to the [City/County], and to reimburse the [City/County] for the cost of litigation;

- (e) Securities held against the successful completion of the Site Map and Grading Plan and the Interim Plan, except for Interim Plans described in §301.07, shall be released to the Permittee at the termination of the Permit, provided no action against such security is filed prior to that date;
- (f) Securities held against the successful completion of the Final Plan and an Interim Plan described in §301.07 shall be released to the Permittee either one (1) year after termination of the Permit or when a Final Plan is submitted for the unimproved site, whichever is later, provided no action against such security has been filed prior to that date.

403.04 Cumulative Enforcement Procedures. The procedures for enforcement of a Permit, as set forth in this Article, are cumulative and not exclusive.

APPENDIX B

MODEL ORDINANCE NO. 2

(A Combined Grading and Erosion and Sediment Control Ordinance)

This model ordinance integrates the key erosion and sediment control features from Chapter II, Section 1 of this Manual into a typical existing grading ordinance. Chapter 70 of the Uniform Building Code (UBC) was selected because it is widely used by cities in the San Francisco Bay Area. Portions of Model Ordinance No. 2 were reproduced from Chapter 70 of the 1979 edition of the UBC with permission of the publisher, the International Conference of Building Officials. Some modification of Chapter 70 was necessary to fit the format of this model.

ABAG does not make any representations regarding the validity, engineering or otherwise, of the grading provisions of Chapter 70 of the UBC. Further, ABAG does not make any representations regarding the validity, engineering or otherwise, of the grading provisions of Model Ordinance No. 2, whether quoted or derived from Chapter 70 of the UBC or any other source. Each jurisdiction considering adoption of Model Ordinance No. 2 should consult a registered engineer at least with regard to the grading provisions.

In the text of the model, passages or blanks enclosed in brackets are intended to be filled in by local jurisdictions. Provisions noted as "optional" may be deleted. Substantive changes to other parts of the model may undermine the effectiveness of the erosion and sediment control program.

Article I

Title, Purpose and General Provisions

- 1 Title. This ordinance shall be known as the "[City/Town/County of _____] Grading and Erosion and Sediment Control Ordinance" and may be so cited.
- 2 Purpose. The purpose of this ordinance is to provide for safe grading operations, to safeguard life, limb and property, and to preserve and enhance the natural environment, including but not limited to water quality, by regulating clearing and grading on private property.
- 3 Scope. This chapter sets forth rules and regulations to control land disturbances, land fill, soil storage, and erosion and sedimentation resulting from such activities. This chapter establishes procedures for issuance, administration and enforcement of a permit.

Definitions. When used in this chapter, the following words shall have the meanings ascribed to them in this Section:

- (a) Applicant: any person, corporation, partnership, association of any type, public agency or any other legal entity who submits an application to the Director for a permit pursuant to this Chapter.
- (b) As-Graded: the surface conditions extant on completion of grading.
- (c) Bedrock: in-place solid rock.
- (d) Bench: a relatively level step excavated into earth material on which fill is to be placed.
- (e) Best Management Practices: a technique or series of techniques which, when used in an erosion control plan, is proven to be effective in controlling construction-related runoff, erosion and sedimentation.
- (f) Borrow: earth material acquired from an off-site location for use in grading on a site.
- (g) Building Official: [the Public Works Director of the City/Town/County of _____, or the person responsible for the administrative and operational control of grading activities in the City/Town/County of _____] and his/her duly authorized designees.
- (h) Chapter: this ordinance in its entirety.
- (i) Civil Engineer: a professional engineer registered in the State of California to practice in the field of civil works.
- (j) Civil Engineering: the application of the knowledge of the forces of nature, principles of mechanics and the properties of materials to the evaluation, design and construction of civil works for the beneficial uses of mankind.
- (k) Compaction: the densification of a fill by mechanical means.
- (l) Drainageway: a natural or manmade channel which collects and intermittently or continuously conveys stormwater runoff.
- (m) Earth Material: any rock, natural soil or fill and/or combination thereof.
- (n) Engineering Geologist: a geologist experienced and knowledgeable in engineering geology and certified by the State of California to practice engineering geology.

- (o) Engineering Geology: the application of geologic knowledge and principles in the investigation and evaluation of naturally occurring rock and soil for use in the design of civil works.
- (p) Erosion: the wearing away of the ground surface as a result of the movement of wind, water and/or ice.
- (q) Final Erosion and Sediment Control Plan (Final Plan): a set of best management practices or equivalent measures designed to control surface runoff and erosion and to retain sediment on a particular site after all other planned final structures and permanent improvements have been erected or installed.
- (r) Grade: the vertical location of the ground surface.
 - Existing Grade - the grade prior to grading.
 - Rough Grade - the stage at which the grade approximately conforms to the approved plan.
 - Finish Grade - the final grade of the site which conforms to the approved plan.
- (s) Grading: any land disturbance or land fill, or combination thereof.
- (t) Interim Erosion and Sediment Control Plan (Interim Plan): a set of best management practices or equivalent measures designed to control surface runoff and erosion and to retain sediment on a particular site during the period in which pre-construction and construction-related land disturbances, fills and soil storage occur, and before final improvements are completed.
- (u) Key: a designed compacted fill placed in a trench excavated in earth material beneath the toe of a proposed fill slope.
- (v) Land Disturbance/Land-Disturbing Activities: any moving or removing by manual or mechanical means of the soil mantle or top 6 inches of soil whichever is shallower, including but not limited to excavations.
- (w) Land Fill: any human activity depositing soil or other earth materials.
- (x) Manual of Standards: a compilation of technical standards and design specifications adopted by the building official as being proven methods of controlling construction-related surface runoff, erosion and sedimentation.
- (y) Permittee: the applicant in whose name a valid permit is duly issued pursuant to this chapter and his/her agents, employees and others acting under his/her direction.

- (z) Sediment: earth material deposited by water or wind.
- (aa) Site: a parcel or parcels of real property owned by one or more than one person which is being or is capable of being developed as a single project.
- (bb) Slope: an inclined ground surface the inclination of which is expressed as a ratio of horizontal distance to vertical distance.
- (cc) Soil: naturally occurring superficial deposits overlying bed rock.
- (dd) Soil Engineer: a civil engineer experienced and knowledgeable in the practice of soil engineering.
- (ee) Soil Engineering: the application of the principles of soil mechanics in the investigation, evaluation and design of civil works involving the use of earth materials and the inspection and testing of the construction thereof.
- (ff) Wet Season: the period from October 15 to April 15.

5 Hazards. Whenever the building official determines that any existing excavation or embankment or fill on private property has become a hazard to life and limb, or endangers property, or adversely affects the safety, use or stability of a public way or drainage channel, the owner of the property upon which the excavation or fill is located, or other person or agency in control of said property, upon receipt of notice in writing from the building official, shall within the period specified therein repair or eliminate such excavation or embankment so as to eliminate the hazard and be in conformance with the requirements of this code.

6 Other Laws. Neither this ordinance nor any administrative decision made under it:

- (a) Exempts the Permittee from procuring other required permits or complying with the requirements and conditions of such a permit; or
- (b) Limits the right of any person to maintain, at any time, any appropriate action, at law or in equity, for relief or damages against the Permittee arising from the permitted activity.

7 Severability and Validity. If any part of this ordinance is found not valid, the remainder of this ordinance shall remain in effect.

8-9 Reserved.

Article II

Permit Application Procedures

10 Scope. No person may grade, fill, excavate, store or dispose of soil and earth materials or perform any other land-disturbing or land-filling activity without first obtaining a Permit as set forth in this chapter.

11 General Exemptions. All land-disturbing or land-filling activities or soil storage shall be undertaken in a manner designed to minimize surface runoff, erosion and sedimentation and to safeguard life, limb, property, and the public welfare. A person performing such activities need not apply for a Permit pursuant to this chapter, if all the following criteria are met:

- (a) The site upon which land area is disturbed or filled is 10,000 square feet or less.
- (b) Natural and finished slopes are less than 10%.
- (c) Volume of soil or earth materials stored is 50 cubic yards or less.
- (d) Rainwater runoff is diverted, either during or after construction, from an area smaller than 5,000 square feet.
- (e) An impervious surface, if any, of less than 5,000 square feet is created.
- (f) No drainageway is blocked or has its stormwater carrying capacities or characteristics modified.
- (g) The activity does not take place within 100 feet by horizontal measurement from the top of the bank of a watercourse, the mean high watermark (line of vegetation) of a body of water or within the wetlands associated with a watercourse or water body, whichever distance is greater.

12 Categorical Exemptions. Sections 10 and 11(a)-(f) notwithstanding, the following activities are exempt from the permit requirements:

- (a) An excavation below finished grade for basements and footings of a building, retaining wall or other structure authorized by a valid building permit. This shall not exempt any fill made with the material from such excavation nor exempt any excavation having an unsupported height greater than 5 feet after the completion of the structure.

- (b) Cemetery graves.
- (c) Refuse disposal sites controlled by other regulations.
- (d) Excavations for wells or tunnels.
- (e) Mining, quarrying, excavating, processing, stockpiling of rock, sand, gravel, aggregate or clay where established and provided for by law, provided such operations do not affect the lateral support or increase the stresses in or pressure upon any adjacent or contiguous property.
- (f) Exploratory excavations under the direction of soil engineers or engineering geologists.
- (g) Routine agricultural crop management practices.
- (h) Emergencies posing an immediate danger to life or property, or substantial flood or fire hazards.
- (i) Any activity where total volume of material disturbed, stored, disposed of or used as fill does not exceed 50 cubic yards and which does not obstruct a drainage course.
- (j) Sections 10 and 11(a)-(g) notwithstanding, any activity where total volume of material disturbed, stored, disposed of or used as fill does not exceed 5 cubic yards is always exempt from the permit requirements.

13 Reserved.

14 Application. The application for a Permit must include all of the following items:

- (a) Application form.
- (b) Site Map and Grading Plan.
- (c) Interim Erosion and Sediment Control Plan.
- (d) Final Erosion and Sediment Control Plan, where required.
- (e) Soil Engineering Report, where required.
- (f) Engineering Geology Report, where required.
- (g) Work schedule.
- (h) Application fees.

- (i) Performance bond or other acceptable security (see § 22).
- (j) Any supplementary material required by the building official.

15 Application Form. The following information is required on the application form:

- (a) Name, address and telephone number of the Applicant.
- (b) Names, addresses and telephone numbers of any and all contractors, subcontractors or persons actually doing the land-disturbing and land-filling activities and their respective tasks.
- (c) Name(s), address(es) and telephone number(s) of the person(s) responsible for the preparation of the Site Map and Grading Plan.
- (d) Name(s), address(es) and telephone number(s) of the person(s) responsible for the preparation of the Interim and/or Final Erosion and Sediment Control Plan.
- (e) Name(s), address(es) and telephone number(s) of the registered engineer(s) responsible for the preparation of the soil engineering and engineering geology reports, where required.
- (f) A vicinity map showing the location of the site in relationship to the surrounding area's watercourses, water bodies and other significant geographic features, and roads and other significant structures.
- (g) Date of the application.
- (h) Signature(s) of the owner(s) of the site or of an authorized representative.

16 Site Map and Grading Plan (Grading Plan). The Site Map and Grading Plan shall contain all the following information:

- (a) Existing and proposed topography of the site taken at a contour interval sufficiently detailed to define the topography over the entire site. Ninety percent (90%) of the contours shall be plotted within one contour interval of the true location.
- (b) Two contour intervals that extend a minimum of [100 feet off-site, or sufficient to show on- and off-site drainage].
- (c) Site's property lines shown in true location with respect to the plan's topographic information.

- (d) Location and graphic representation of all existing and proposed natural and manmade drainage facilities.
- (e) Detailed plans of all surface and subsurface drainage devices, walls, cribbing, dams and other protective devices to be constructed with or as a part of the proposed work, together with a map showing the drainage area and the estimated runoff of the area served by any drain.
- (f) Location and graphic representation of proposed excavations and fills, of on-site storage of soil and other earth material, and of on-site disposal.
- (optional)(g) [Location of existing vegetation types and the] location and type of vegetation to be left undisturbed.
- (h) Location of proposed final surface runoff, erosion and sediment control measures.
- (optional)(i) Quantity of soil or earth material in tons and cubic yards to be excavated, filled, stored or otherwise utilized on-site.
- (optional)(j) Outline of the methods to be used in clearing vegetation, and in storing and disposing of the cleared vegetative matter.
- (k) Proposed sequence and schedule of excavation, filling and other land-disturbing and filling activities, and soil or earth material storage and disposal.
- (l) Location of any buildings or structures on the property where the work is to be performed and the location of any buildings or structures on land of adjacent owners which are within 15 feet of the property or which may be affected by the proposed grading operations.

Specifications shall contain information covering construction and material requirements.

17 Interim Erosion and Sediment Control Plan (Interim Plan). All the following information shall be provided with respect to conditions existing on the site during land-disturbing or filling activities or soil storage:

- (a) Maximum surface runoff from the site shall be calculated using the method approved by the building official and maintained in the Manual of Standards, or any other method proven to the building official to be as or more accurate.
- (b) The Interim Plan shall also contain the following information:

- (1) a delineation and brief description of the measures to be undertaken to retain sediment on the site, including, but not limited to, the designs and specifications for sediment detention basins and traps, and a schedule for their maintenance and upkeep;
 - (2) a delineation and brief description of the surface runoff and erosion control measures to be implemented, including, but not limited to, types and method of applying mulches, and designs and specifications for diverters, dikes and drains, and a schedule for their maintenance and upkeep;
 - (3) a delineation and brief description of the vegetative measures to be used, including, but not limited to, types of seeds and fertilizer and their application rates, the type, location and extent of pre-existing and undisturbed vegetation types, and a schedule for maintenance and upkeep.
- (c) The location of all the measures listed by the Applicant under Subsection (b) above, shall be depicted on the Grading Plan, or on a separate plan at the discretion of the building official.
 - (d) An estimate of the cost of implementing and maintaining all interim erosion and sediment control measures must be submitted in a form acceptable to the building official.
 - (e) The Applicant may propose the use of any erosion and sediment control techniques in the Interim Plan provided such techniques are proven to be as or more effective than the equivalent best management practices contained in the Manual of Standards.

18

Final Erosion and Sediment Control Plan (Final Plan). All the following information shall be provided with respect to conditions existing on the site after final structures and improvements (except those required under this Section) have been completed and where these final structures have not been covered by an Interim Plan (see § 29):

- (a) Maximum runoff from the site shall be calculated using the method approved by the building official and maintained in the Manual of Standards, or any other method proven to the building official to be as or more accurate.
- (b) The Final Plan shall also contain the following information:
 - (1) a description of and specifications for sediment retention devices;

- (2) a description of and specifications for surface runoff and erosion control devices;
 - (3) a description of vegetative measures;
 - (4) a graphic representation of the location of all items in Subsections (1)-(3) above (see § 16(h));
- (c) An estimate of the costs of implementing all final erosion and sediment control measures must be submitted in a form acceptable to the building official.
- (d) The Applicant may propose the use of any erosion and sediment control techniques in the Final Plan provided such techniques are proven to be as or more effective than the equivalent best management practices contained in the Manual of Standards.

19 Soil Engineering Report. A soil engineering report, when required by the building official, shall be based on adequate and necessary test borings, and shall contain all the following information:

- (a) Data regarding the nature, distribution, strength, and erodibility of existing soils.
- (b) Data regarding the nature, distribution, strength and erodibility of soil to be placed on the site, if any.
- (c) Conclusions and recommendations for grading procedures.
- (d) Conclusions and recommended designs for interim soil stabilization devices and measures and for permanent soil stabilization after construction is completed.
- (e) Design criteria for corrective measures when necessary.
- (f) Opinions and recommendations covering adequacy of sites to be developed by the proposed grading.

Recommendations included in the report and approved by the building official shall be incorporated in the grading plans or specifications.

20 Engineering Geology Report. An engineering geology report, when required by the building official, shall be based on adequate and necessary test borings and shall contain the following information:

- (a) An adequate description of the geology of the site.
- (b) Conclusions and recommendations regarding the effect of geologic conditions on the proposed development.

- (c) Opinions and recommendations covering the adequacy of sites to be developed by the proposed grading.

Recommendations included in the report and approved by the building official shall be incorporated in the grading plans or specifications.

21 Work Schedule. The Applicant must submit a master work schedule showing the following information:

- (a) Proposed grading schedule.
- (b) Proposed conditions of the site on each July 15, August 15, September 15, October 1 and October 15 during which the Permit is in effect.
- (c) Proposed schedule for installation of all interim erosion and sediment control measures including, but not limited to, the stage of completion of erosion and sediment control devices and vegetative measures on each of the dates set forth in Subsection (b).
- (d) Schedule for construction of final improvements, if any.
- (e) Schedule for installation of permanent erosion and sediment control devices where required.

22 Security.

- (a) The Applicant shall provide security for the performance of the work described and delineated on the approved Grading Plan in an amount to be set by the building official. The form of security shall be one or a combination of the following to be determined by the building official.
 - (1) bond or bonds issued by one or more duly authorized corporate sureties. The form of the bond or bonds shall be subject to the approval of the City Attorney;
 - (2) deposit, either with the City or a responsible escrow agent or trust company at the option of the City, of money, negotiable bonds of the kind approved for securing deposits of public monies, or other instrument of credit from one or more financial institutions subject to regulation by the State or Federal government wherein said financial institution pledges funds are on deposit and guaranteed for payment;
 - (3) cash in U.S. currency.

(b) The Applicant shall provide security for the performance of the work described and delineated in the Interim Plan in an amount to be determined by the building official but not less than 100% of the approved estimated cost of performing said work. The form of the security shall be as set forth in Subsections (a)(2) and (3).

(c) The Applicant shall provide security for the performance of the work described and delineated in the Final Plan in an amount to be determined by the building official but not less than 100% of the approved estimated cost of performing said work. The form of the security shall be as set forth in Subsections (a)(2) and (3).

23 Fees. Fees are to be paid pursuant to a schedule of fees adopted, and amended from time to time by separate resolution of the [Council/Supervisors].

24 Decision on a Permit. The building official shall review all documents submitted pursuant to this chapter and, if necessary, request additional data, clarification of submitted data or correction of defective submissions within 10 working days after the date of submission. The building official shall notify Applicant of his/her decision on the Permit within 20 working days of the initial submission or of the corrected submissions, whichever is later.

25 Notice. Applicant shall be notified of building official's decision on the application within 3 working days of the decision.

26 Permit Duration. Permits issued under this chapter shall be valid for the period during which the proposed land-disturbing or filling activities and soil storage takes place or is scheduled to take place, whichever is shorter. Permittee shall commence permitted activities within 60 days of the scheduled commencement date for grading or the Permittee shall resubmit all required application forms, maps, plans, schedules and security to the building official except where an item to be resubmitted is waived by the building official. The building official may require additional fees.

27 Permit Denial. The Applicant may request a hearing before the City Council within 5 working days of notification of a permit denial. The hearing shall be held at the next regularly scheduled City Council meeting following the date of the request for a hearing.

28 Assignment of Permit. A Permit issued pursuant to this chapter may be assigned, provided:

(a) The Permittee notifies the building official of the proposed assignment.

- (b) The proposed assignee:
 - (1) submits an application form pursuant to Section 15; and
 - (2) agrees in writing to all the conditions and duties imposed by the Permit; and
 - (3) agrees in writing to assume responsibility for all work performed prior to the assignment; and
 - (4) provides security pursuant to Section 22; and
 - (5) agrees to pay all applicable fees.

(c) The building official approves the assignment.

The building official shall set forth in writing the reasons for his/her approval or disapproval of an assignment.

29

No Improvements Planned. Where an Applicant does not plan to construct permanent improvements on the site, or plans to leave portions of the site graded but unimproved, Applicant must:

- (a) Meet all the requirements of this chapter except that an Interim Plan designed to control runoff and erosion on the site for the period of time during which the site, or portions thereof, remain unimproved must be submitted in lieu of a Final Plan; and
- (b) Submit executed contract(s) as defined in Section 33(a) after completion of grading.

Article III

Implementation and Enforcement

- 30 Issuance of Permits. Building official shall issue a Permit upon approval of a Grading Plan, Interim Plan, and where required, Final Plan, soil engineering report, and engineering geology report, deposit of appropriate security and payment of fees. Permit shall be issued subject to the following conditions:
- (a) The Permittee shall maintain a copy of the Permit, approved plans and reports required under Section 31 on the work site and available for public inspection during all working hours.
 - (b) The Permittee shall, at all times, be in conformity with approved Grading Plan, Interim and Final Plans.
- 31 Implementation of Permits--Permittee's Duties. In addition to performing as required under Section 30:
- (a) Unless this requirement is waived by the building official, Permittee shall notify the building official within 72 hours of:
 - (1) the beginning of the permitted activity;
 - (2) the completion of rough grading;
 - (3) the completion of finished grading;
 - (4) the installation of all erosion control devices and the completion of planting requirements;
 - (5) readiness of the site for final inspection, including, but not limited to, finished grading, installation of drainage devices and final erosion control measures.
 - (b) Permittee shall submit to the building official, reports if:
 - (1) there are delays in obtaining materials, machinery, services or manpower necessary to the implementation of the Grading, Interim or Final Plans as scheduled;
 - (2) there are any delays in land-disturbing or filling activities or soil storage;
 - (3) the work is not being done in conformance with the approved Grading, Interim or Final Plans;

- (4) there are any departures from the approved Grading Plan which may affect implementation of the Interim or Final Plans as scheduled;
 - (5) there are any delays in the implementation of the Interim or Final Plans;
 - (6) there are any other departures from implementation of the Interim or Final Plans;
- (c) Unless this requirement is waived by the building official, Permittee shall submit recommendations for corrective measures, if necessary and appropriate, with the reports made under Subsection (b).

32

Implementation of Permits.

- (a) The building official shall review all reports submitted by Permittee. The building official may require Permittee to modify the Grading Plan, Interim or Final Plans, and maintenance methods and schedules. The building official shall notify the Permittee in writing of the requirement and specify a reasonable period of time within which Permittee must comply. All modifications are subject to building official's approval.
- (b) The building official may inspect the site:
 - (1) upon receipt of a report by Permittee under provisions of Section 31(a) and (b);
 - (2) to verify completion of modifications required under Section 32(a);
 - (3) during and following any rainfall;
 - (4) at any other time, at the building official's discretion.
- (c) Upon completion of the rough grading work and at the final completion of the work, the building official may require the following reports and drawings and supplements thereto:
 - (1) an as-graded grading plan prepared by the civil engineer including original ground surface elevations, as-graded ground surface elevations, lot drainage patterns and locations and elevations of all surface and subsurface drainage facilities. He/she shall provide approval that the work was done in accordance with the final approved Grading Plan.

- (2) a soil grading report prepared by the soil engineer including locations and elevations of field density tests, summaries of field and laboratory tests and other substantiating data and comments on any changes made during grading and their effect on the recommendations made in the soil engineering investigation report. He/she shall provide approval as to the adequacy of the site for the intended use.
- (3) a geologic grading report prepared by the engineering geologist including a final description of the geology of the site including any new information disclosed during the grading and the effect of same on recommendations incorporated in the approved Grading Plan. He/she shall provide approval as to the adequacy of the site for the intended use as affected by geologic factors.

33 Post-Grading Procedures: Upon completion of final grading and permanent improvements, where such permanent improvements are planned at the time grading is performed, Permittee shall submit:

- (a) Executed contract(s) for maintenance and upkeep of Final Plan runoff and erosion control measures for an [x] year(s) period.

[Less desirable alternatives: deed restrictions requiring maintenance; instructions on maintenance provided subsequent owners.]

34 Suspension or Revocation of Permit. The building official shall first have resort to the procedures set forth in this Section before any other enforcement procedure set forth in this Article.

- (a) The building official shall suspend the Permit and issue a stop work order, and Permittee shall cease all work on the work site, except work necessary to remedy the cause of the suspension, upon notification of such suspension when:
 - (1) the building official determines that the permit was issued in error or on the basis of incorrect information supplied, or in violation of any ordinance or regulation or the provisions of this ordinance;
 - (2) Permittee fails to submit reports when required under Sections 31 and 32(c);
 - (3) inspection by the building official under Section 32(b) reveals that the work or the work site:

- (i) is not in compliance with the conditions set forth in Section 30, or
 - (ii) is not in conformity with the Grading Plan, Interim or Final Plan as approved or as modified under Section 32(a), or
 - (iii) is not in compliance with an order to modify under Section 32(a);
- (4) Permittee fails to comply with an order to modify within the time limits imposed by the building official (see § 32(a));
 - (5) Permittee fails to obtain permission for wet season activity under Section 41.
- (b) The building official shall revoke the Permit and issue a stop work order, and Permittee shall cease work if Permittee fails or refuses to cease work, as required under Section 34(a) above, after suspension of the Permit and receipt of a stop work order and notification thereof.
 - (c) The building official shall reinstate a suspended Permit upon Permittee's correction of the cause of the suspension.
 - (d) The building official shall not reinstate a revoked Permit.

35 Fines and Penalties. Any person, firm, corporation or agency acting as principal agent, employee or otherwise, who fails to comply with the provisions of this ordinance shall be guilty of a misdemeanor and upon conviction thereof shall be punishable by a fine of not less than One Hundred Dollars (\$100.00) and not more than Five Hundred Dollars (\$500.00), or by imprisonment in the county jail for not more than 30 days, or by both, for each separate offense. Each day any violation of this chapter shall continue shall constitute a separate offense.

36 Action against the Security. The building official may act against the appropriate security if any of the conditions listed in Subsections (a)-(d) below exists. The building official shall use funds from the appropriate security to finance remedial work undertaken by the city or a private contractor under contract to the city, and to reimburse the city for all direct costs incurred in the process of the remedial work.

- (a) The Permittee ceases land-disturbing activities and/or filling and abandons the work site prior to completion of the Grading Plan.

- (b) The Permittee fails to conform to the Interim Plan or Final Plan as approved or as modified under Section 32(a) and has had his/her permit revoked under Section 34.
- (c) The techniques utilized under the Interim or Final Plan fail within 1 year of installation, or before a Final Plan is implemented for the site or portions of the site, whichever is later.
- (d) The building official determines that action by the city is necessary to prevent excessive erosion from occurring on the site.

37 Release of Security. Security deposited with the city for faithful performance of the grading and erosion control work and to finance necessary remedial work shall be released according to the following schedule:

- (a) Securities held against the successful completion of the Grading Plan and the Interim Plan, except for Interim Plans described in Section 29, shall be released to the Permittee at the termination of the Permit, provided no action against such security is filed prior to that date.
- (b) Securities held against the successful completion of the Final Plan and an Interim Plan described in Section 29 shall be released to the Permittee either 1 year after termination of the Permit or when a Final Plan is submitted for the unimproved site, whichever is later, provided no action against such security has been filed prior to that date.

38 Cumulative Enforcement Procedures. The procedures for enforcement of a Permit, as set forth in this Article, are cumulative and not exclusive.

39 Reserved.

Article IV

Special Circumstances

40

Grading Designation. All grading in excess of 5,000 cubic yards shall be performed in accordance with the approved Grading Plan prepared by a civil engineer, and shall be designated as "engineered grading." Grading involving less than 5,000 cubic yards shall be designated "regular grading" unless the Permittee, with the approval of the building official, chooses to have the grading performed as "engineered grading."

- (a) Engineered Grading Requirements. For engineered grading, it shall be the responsibility of the civil engineer who prepares the approved Grading Plan to incorporate all recommendations from the soil engineering and engineering geology reports into the Grading Plan. He/she also shall be responsible for the professional inspection and approval of the grading within his/her area of technical specialty. This responsibility shall include, but need not be limited to, inspection and approval as to the establishment of line, grade and drainage of the development area. The civil engineer shall act as the coordinating agent in the event the need arises for liaison between the other professionals, the contractor and the building official. The civil engineer also shall be responsible for the preparation of revised plans and the submission of as-graded grading plans upon completion of the work. The grading contractor shall submit in a form prescribed by the building official a statement of compliance to said as-built plan.

Soil engineering and engineering geology reports shall be required at the discretion of the building official. During grading all necessary reports, compaction data and soil engineering and engineering geology recommendations shall be submitted to the civil engineer and the building official by the soil engineer and the engineering geologist.

The soil engineer's area of responsibility shall include, but need not be limited to, the professional inspection and approval concerning the preparation of ground to receive fills, testing for required compaction, stability of all finish slopes and the design of buttress fills, where required, incorporating data supplied by the engineering geologist.

The engineering geologist's area of responsibility shall include, but need not be limited to, professional inspection and approval of the adequacy of natural ground for receiving fills and the stability of cut slopes with respect to geological matters and the need for subdrains or other ground water drainage devices. He/she shall report his/her findings to the soil engineer and the civil engineer for engineering analysis.

The building official shall inspect the project as required under Section 32 and at any more frequent intervals necessary to determine that adequate control is being exercised by the professional consultants.

- (b) Regular Grading Requirements. The building official may require inspection and testing by an approved testing agency.

The testing agency's responsibility shall include, but need not be limited to, approval concerning the inspection of cleared areas and benches to receive fill, and the compaction of fills.

When the building official has cause to believe that geologic factors may be involved, the grading operation will be required to conform to "engineered grading" requirements.

- (c) If, in the course of fulfilling their responsibility under this chapter, the civil engineer, the soil engineer, the engineering geologist or the testing agency finds that the work is not being done in conformance with this chapter or the approved Grading Plans, the discrepancies shall be reported immediately in writing to the person in charge of the grading work and to the building official (see § 31).
- (d) If the civil engineer, the soil engineer, the engineering geologist or the testing agency of record is changed during the course of the work, the work shall be stopped until the replacement has agreed to accept the responsibility within the area of their technical competence for approval upon completion of the work.

41

Wet Season Work.

- (a) For commencement of land-disturbing or filling activity during the wet season, Applicant shall demonstrate that land disturbance is relatively minor and that erosion and sedimentation can be controlled.
- (b) For continuation of land-disturbing or filling activities, other than installation, maintenance or repair of measures in the Interim or Final Plans, during the wet season, Permittee must apply for and receive, every 5 working days, special permission to proceed.

- (c) The building official shall grant permission under this section on the basis of weather forecasts, experience and other pertinent factors which indicate the activity may commence or continue without excessive erosion occurring.
- (d) Applicant/Permittee's failure to obtain permission for wet season activity shall result in the imposition of suspension/revocation, and action against the security or criminal penalties as described in Sections 34-36.

42-49

Reserved.

Article V

Additional Requirements

50 Cuts.

- (a) General. Unless otherwise recommended in the approved soil engineering and/or engineering geology report, cuts shall conform to the provisions of this Section.
- (b) Slope. The slope of cut surfaces shall be no steeper than is safe for the intended use. Cut slopes shall be no steeper than two horizontal to one vertical.
- (c) Drainage and Terracing. Drainage and terracing shall be provided as required by Section 53.

51 Fills.

- (a) General. Unless otherwise recommended in the approved soil engineering report, fills shall conform to the provisions of this Section.

In the absence of an approved soil engineering report, these provisions may be waived for minor fills not intended to support structures.

- (b) Fill Location. Fill slopes shall not be constructed on natural slopes steeper than two to one.
- (c) Preparation of Ground. The ground surface shall be prepared to receive fill by removing vegetation, noncomplying fill, top-soil and other unsuitable materials, scarifying to provide a bond with the new fill, and, where slopes are steeper than five to one, and the height is greater than 5 feet, by benching into sound bedrock or other competent material as determined by the soil engineer. The bench under the toe of a fill on a slope steeper than five to one shall be at least 10 feet wide. The area beyond the toe of fill shall be sloped for sheet overflow or a paved drain shall be provided. Where fill is to be placed over a cut, the bench under the toe of fill shall be at least 10 feet wide but the cut must be made before placing fill and approved by the soil engineer and engineering geologist as suitable foundation for fill. Unsuitable soil is soil which, in the opinion of the building official or the civil engineer or the soil engineer or the geologist, is not competent to support other soil or fill, to support structures or to satisfactorily perform the other functions for which the soil is intended.

- (d) Fill Material. Detrimental amounts of organic material shall not be permitted in fills. Except as permitted by the building official, no rock or similar irreducible material with a maximum dimension greater than 12 inches shall be buried or placed in fills.

EXCEPTION: The building official may permit placement of larger rock when the soil engineer properly devises a method of placement, continuously inspects its placement and approves the fill stability. The following conditions shall also apply:

- (i) prior to issuance of the grading permit, potential rock disposal areas shall be delineated on the Grading Plan,
 - (ii) rock sizes greater than 12 inches in maximum dimension shall be 10 feet or more below grade, measured vertically,
 - (iii) rocks shall be placed so as to assure filling of all voids with fines.
- (e) Compaction. All fills shall be compacted to a minimum of 90% of maximum density as determined by UBC Standard No. 70-1. Field density shall be determined in accordance with UBC Standard No. 70-2 or equivalent as approved by the building official.
- (f) Slope. The slope of fill surfaces shall be no steeper than is safe for the intended use. Fill slopes shall be no steeper than two horizontal to one vertical.
- (g) Drainage and Terracing. Drainage and terracing shall be provided and the area above fill slopes and the surfaces of terraces shall be graded and paved as required by Section 53.

52

Setbacks.

- (a) General. The setbacks and other restrictions specified by this Section are minimum and may be increased by the building official or by the recommendations of a civil engineer, soil engineer or engineering geologist, if necessary for safety and stability, or to prevent damage of adjacent properties from deposition or erosion, or to provide access for slope maintenance and drainage. Retaining walls may be used to reduce the required setbacks when approved by the building official.

- (b) Setbacks from Property Lines. The tops of cuts and toes of fill slopes shall be set back from the outer boundaries of the permit area, including slope-right areas and easements, in accordance with Figure B-1 and Table B-1.

FIGURE B-1

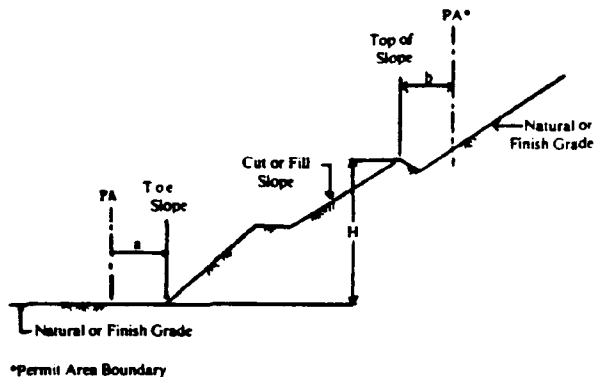

TABLE B-1. REQUIRED SETBACKS FROM PERMIT AREA BOUNDARY (FEET)

| H | SETBACKS | |
|---------|----------|-----|
| | a | b |
| Under 5 | 0 | 1 |
| 5 - 30 | H/2 | H/5 |
| Over 30 | 15 | 6 |

*Additional width may be required for interceptor drain.

- (c) Design Standards for Setbacks. Setbacks between graded slopes (cut or fill) and structures shall be provided in accordance with Figure B-2.

FIGURE B-2

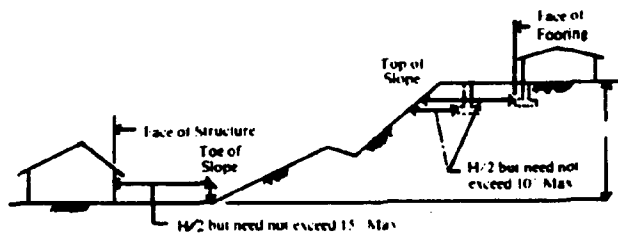

Drainage and Terracing.

- (a) General. Unless otherwise indicated on the approved Grading Plan, drainage facilities and terracing shall conform to the provision of this Section.
- (b) Terrace. Terraces at least 6 feet in width shall be established at not more than 30-foot vertical intervals on all cut or fill slopes to control surface drainage and debris except that where only one terrace is required, it shall be at mid-height. For cut or fill slopes greater than 60 feet and up to 120 feet in vertical height, one terrace at approximately mid-height shall be 12 feet in width. Terrace widths and spacing for cut and fill slopes greater than 120 feet in height shall be designed by the civil engineer and approved by the building official. Suitable access shall be provided to permit proper cleaning and maintenance.

Swales or ditches on terraces shall have a minimum gradient of 5% and must be paved with reinforced concrete not less than 3 inches in thickness or an approved equal paving. They shall have a minimum depth at the deepest point of 1 foot and a minimum paved width of 5 feet.

A single run of swale or ditch shall not collect runoff from a tributary area exceeding 13,500 square feet (projected) without discharging into a downdrain.

- (c) Subsurface Drainage. Cut and fill slopes shall be provided with subsurface drainage as necessary for stability.
- (d) Disposal. All drainage facilities shall be designed to carry waters to the nearest practicable drainageway approved by the building official and/or other appropriate jurisdiction as a safe place to deposit such waters. Erosion of ground in the area of discharge shall be prevented by installation of nonerosive downdrains or other devices.

Building pads shall have a drainage gradient of 2% toward approved drainage facilities, unless waived by the building official.

EXCEPTION: The gradient from the building pad may be 1% if all the following conditions exist throughout the permit area:

- (i) no proposed fills are greater than 10 feet in maximum depth,

- (ii) no proposed finish cut or fill slope faces have a vertical height in excess of 10 feet,
 - (iii) no existing slope faces, which have a slope face steeper than 10 horizontally to 1 vertically, have a vertical height in excess of 10 feet.
- (e) **Interceptor Drains.** Paved interceptor drains shall be installed along the top of all cut slopes where the tributary drainage area above slopes towards the cut and has a drainage path greater than 40 feet measured horizontally. Interceptor drains shall be paved with a minimum of 3 inches of concrete or gunite and reinforced. They shall have a minimum depth of 12 inches and a minimum paved width of 30 inches measured horizontally across the drain. The slope of drain shall be approved by the building official.

APPENDIX C*

Sample Determinations of Subsurface Drain Sizes

Subsurface drains ordinarily are not designed to flow under pressure and the hydraulic gradient is considered to be parallel with the grade line. The flow in the subsurface drain is considered to be open-channel flow. The size of subsurface drain required for a given capacity is dependent on the hydraulic gradient and the roughness coefficient -- "n" value -- of the subsurface drain.

The "n" values for the different materials is as follows:

| <u>Description of Pipe or Tubing</u> | <u>"n" value</u> |
|--------------------------------------|------------------|
| Plastic, smooth | 0.011 |
| Asbestos Cement | 0.013 |
| Bituminized Fiber | 0.013 |
| Concrete | 0.015 |
| Corrugated Plastic | 0.015 |
| Corrugated Metal | 0.025 |

The Standard and Specifications for Subsurface Drain states that for a systematic pattern of drains, a drainage coefficient of 1 inch to be removed in 24 hours shall be used. This coefficient is equal to 0.042 cfs. per acre of area to be drained.

Where subsurface drainage is to be by a random system, a minimum inflow rate of 1.5 cfs. per 1,000 feet of line shall be used to determine the required capacity.

If surface water is allowed to enter the system, additional capacity must be provided for and the minimum design velocity shall be 2 feet per second.

The charts are set up for different "n" values. The abscissa of the chart is the hydraulic gradient in feet per foot and the ordinate is the capacity in cubic feet per second. On the chart are plotted the full flow capacity for different pipe diameters and a velocity line for 2 feet per second. The charts are used by going to the next higher pipe diameter line from the point of intersection of the hydraulic gradient and the capacity for the required pipe size since the design is for open-channel flow. Any point to the right or below the 2 feet per second line will have a velocity of less than 2 feet per second.

Examples using the charts are as follows:

* from USDA, Soil Conservation Service, College Park, Maryland. Standards and Specifications for Soil Erosion and Sediment Control in Developing Areas. July 1975.

Example 1

A random subsurface drain is to be installed. This drain will be 700 feet in length and will be installed at a grade of 0.20%. Bituminized fiber pipe will be used. Determine the size and capacity of the drain.

Solution

From the standard, capacity required = 1.5 cfs per 1000 feet of length.

$$\text{Capacity} = \frac{700'}{1000'} \times 1.5 \text{ cfs per } 1000' = 1.05 \text{ cfs}$$

Using Subsurface Drain Capacity Chart for $n = 0.013$, capacity required = 1.05 cfs, and a gradient of 0.002 ft./ft., the size required is 12" and the actual capacity will be 1.58 cfs.

Example 2

A systematic pattern of subsurface drains is to be installed. There will be eight (8) laterals installed that will be spaced at fifty (50) feet center-to-center and each lateral will be 600 feet in length. The grade of the laterals will be 0.10%. The main will pick up these laterals and will be 400 feet in length. The grade of the main will be 0.10%. Determine the size and capacity of the laterals and the main at the outlet if corrugated plastic tubing is used.

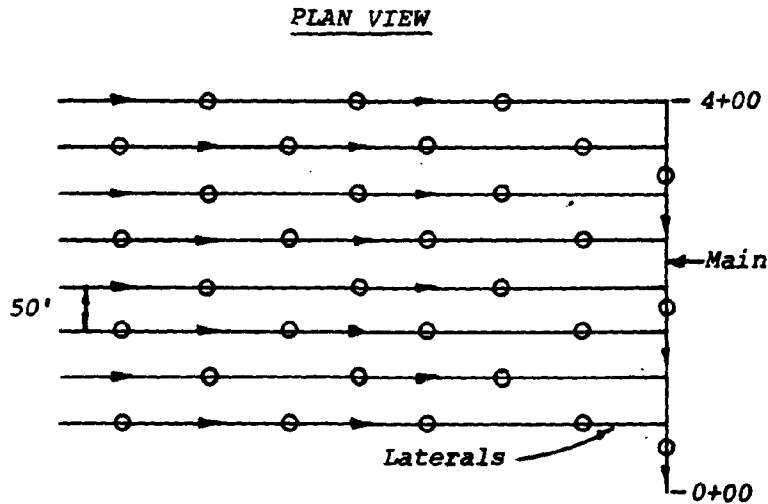

Solution

a. Size and capacity of laterals.

Each lateral will drain for a distance of 25 feet on each side of the line since the spacing is at 50 feet center-to-center. Therefore, each lateral will drain

$$\frac{600' \text{ (length)} \times 50' \text{ (width)}}{43,560} = 0.69 \text{ acre}$$

Capacity required = 0.69 acre x 0.042 cfs/acre = 0.029 cfs. Using Subsurface Drain Capacity Chart for n = 0.015, capacity required = 0.029 cfs, and a gradient of 0.001 ft./ft., the size required is 4" and the actual capacity will be 0.052 cfs. (Note: Minimum size allowed is 4")

b. Size and capacity of the main at the outlet.

For the first 25 feet of the main from the outlet, the main will drain for a distance of 25 feet on each side. For the remaining 375 feet, the main will drain only 25 feet on the one side since the other side is included in the drainage area for the laterals. The main will also drain the laterals. Therefore:

Drainage area from laterals:

$$= 8 \times 0.69 \text{ acre} = 5.52 \text{ acres}$$

Drainage area from main:

$$= \frac{25' \text{ (length)} \times 50' \text{ (width)}}{43,560} + \frac{375' \text{ (length)} \times 25' \text{ (width)}}{43,560} = 0.24 \text{ acre}$$

$$\text{Total} = 5.76 \text{ acres}$$

Capacity required:

$$= 5.76 \text{ acres} \times 0.042 \text{ cfs/acre} = 0.24 \text{ cfs.}$$

Using Subsurface Drain Capacity Chart for n = 0.015, capacity required = 0.24 cfs, and a gradient of 0.001 ft./ft., the size required at the outlet is 8" and the actual capacity will be 0.33 cfs.

SUBSURFACE DRAIN CAPACITY CHART - $n = 0.011$ (14)

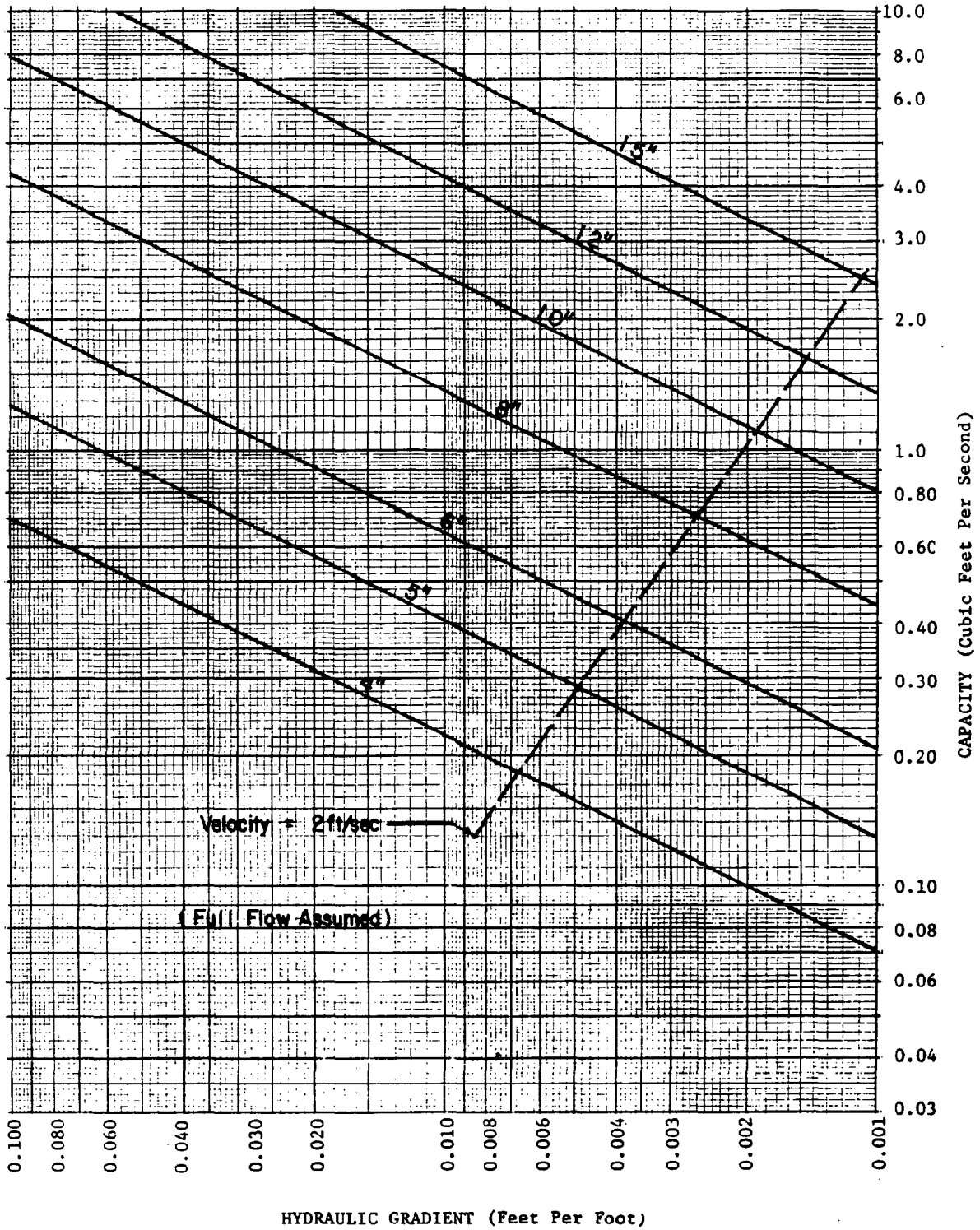

SUBSURFACE DRAIN CAPACITY CHART - $n = 0.013$

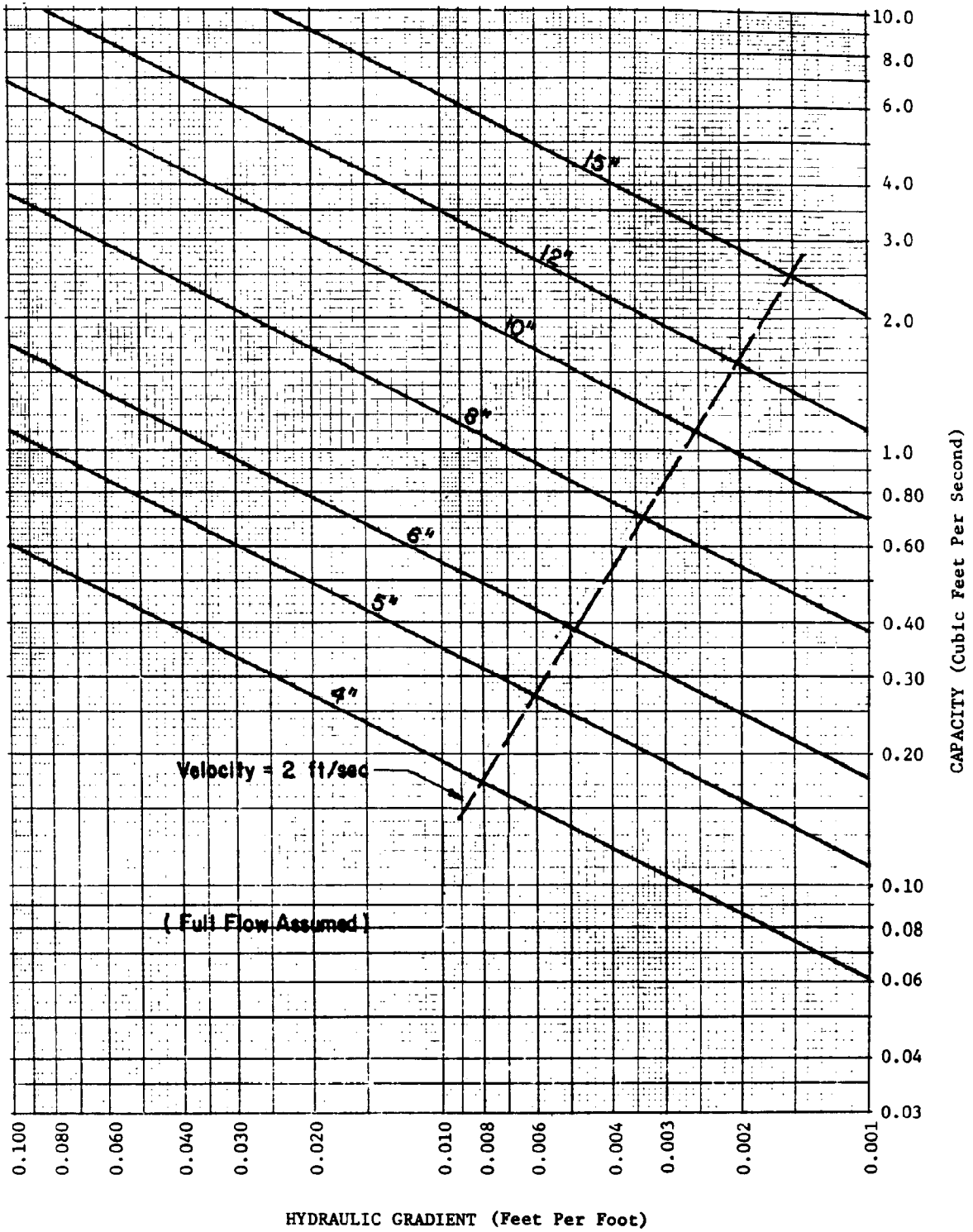

SUBSURFACE DRAIN CAPACITY CHART - n = 0.015

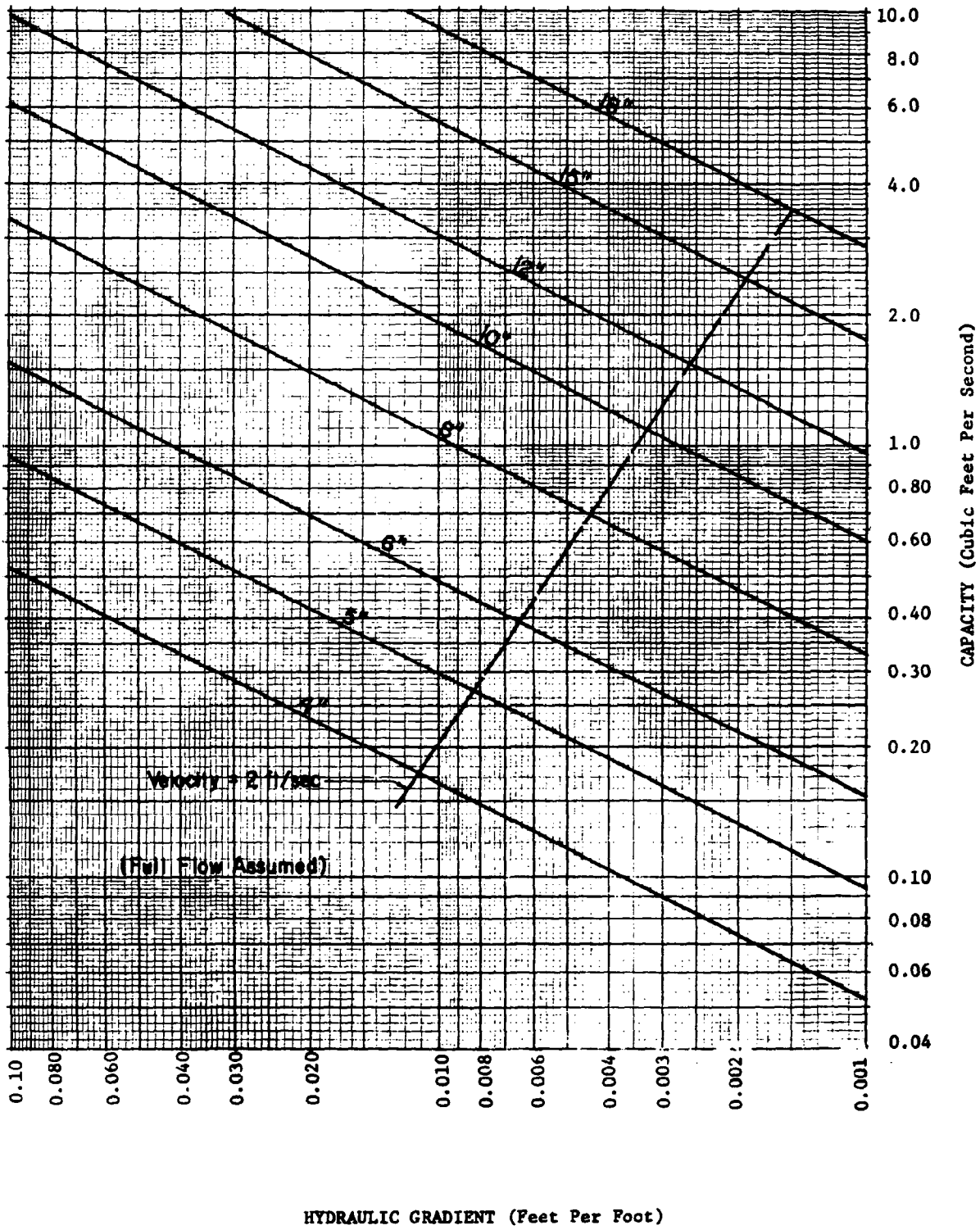

SUBSURFACE DRAIN CAPACITY CHART - $n = 0.025$

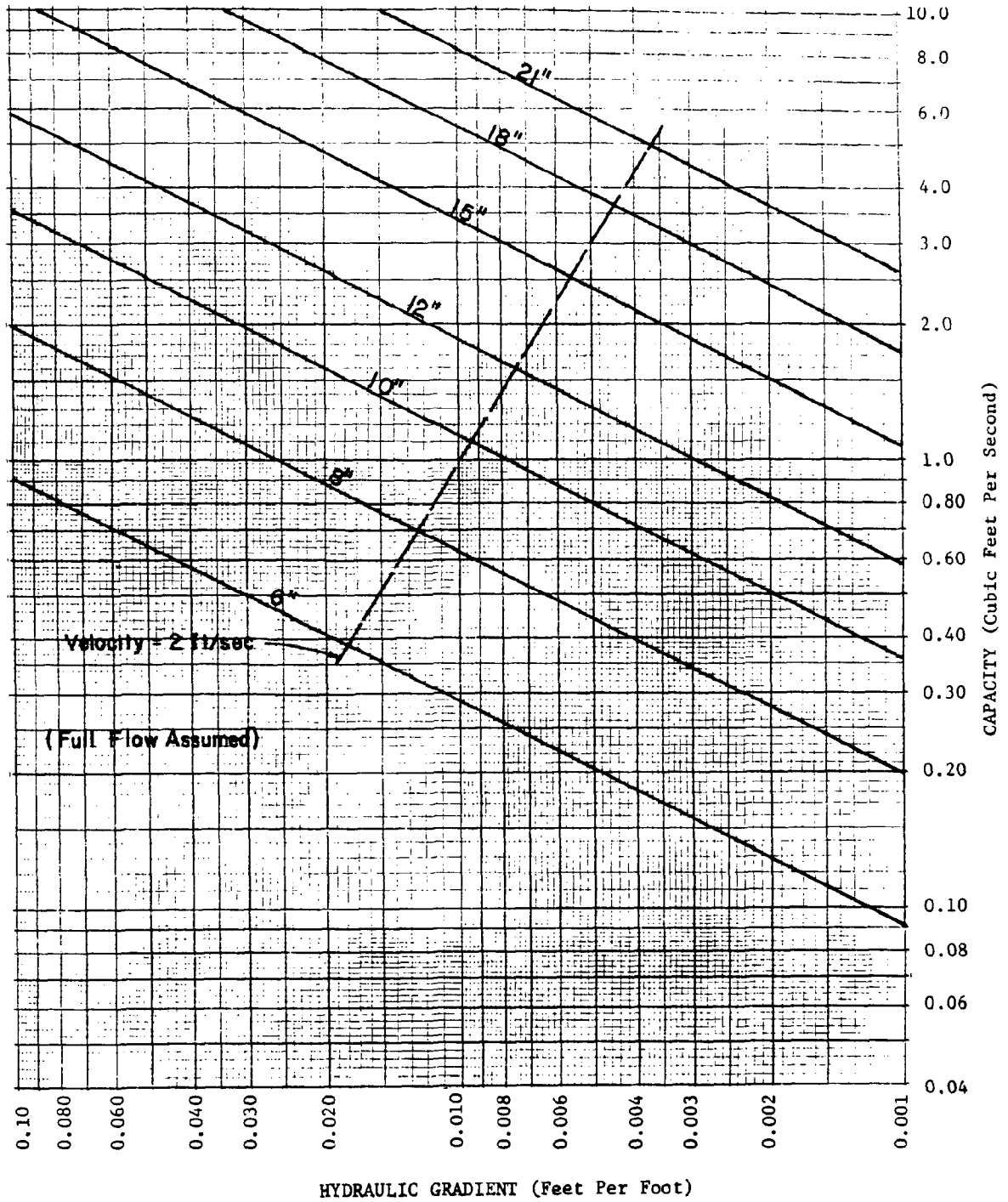

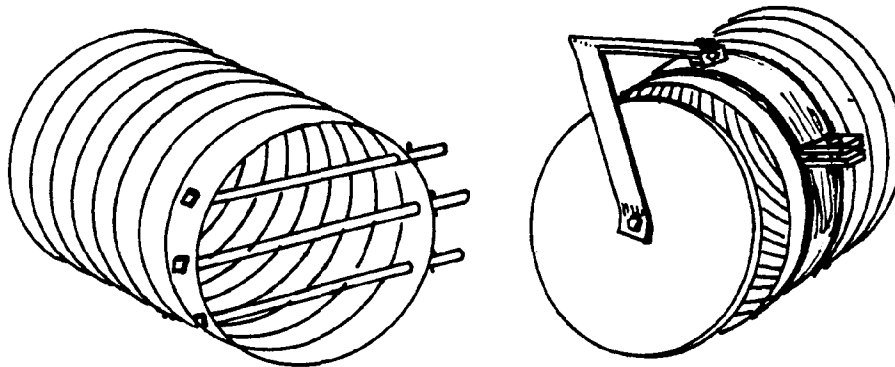

RODENT PROTECTION FOR OUTLET PIPE

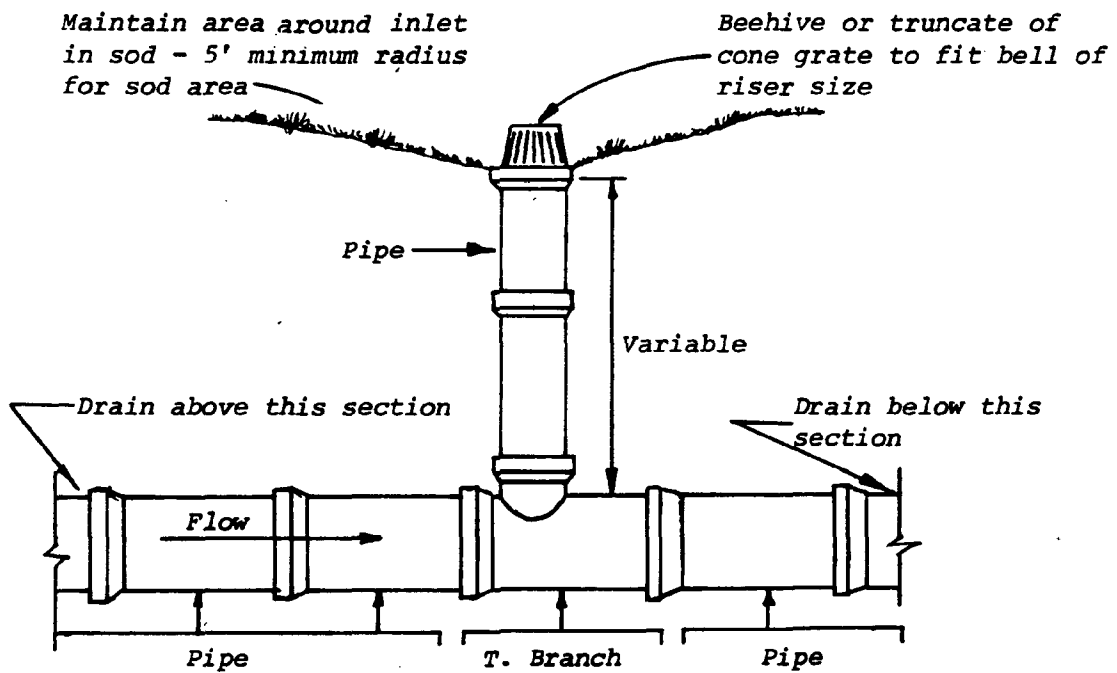

SURFACE WATER INLET TO SUBSURFACE DRAIN

APPENDIX D *

SEDIMENT BASIN DESIGN

TEMPORARY SEDIMENT BASIN DESIGN DATA SHEET

BASIN DESIGN

- 1a. Runoff: $Q = CiA = \underline{\hspace{2cm}}$ cfs (use average hourly rainfall of 10-year, 6-hour storm)
- 1b. Sieve analysis of construction site soil shows percent (E) by weight of soil is greater than or equal to the mm size.
- 1c. Settling velocity of mm particle is feet per sec (v_s)
2. Minimum required surface area:

$$A_s = \frac{Q \text{ (cfs)} \cdot 1.2}{v_s}$$

3. Minimum settling depth: 2 feet
4. Minimum storage depth (d_{st}): Using USLE,
Soil Loss = $RKLSCP \times A$ (acreage) = tons/year \cong cubic yards/year (CY)
CY $\times 27 \times E \div \underline{\hspace{2cm}}$ sq. ft. surface area $\cong \underline{\hspace{2cm}}$ ft. depth.
5. Required volume of basin = $A_s \times (2 + d_{st})$
Excavate cu. yds. to obtain required capacity.
Elevation corresponding to need for cleanout is equal to 2 feet below top of riser: ft.

DESIGN OF SPILLWAYS

6. Peak Runoff: $Q_{peak} = \underline{\hspace{2cm}}$ cfs (using 50% in one hour of 10-year, 6-hour rainfall, calculate peak runoff by Rational or other approved method)

Pipe Spillway Design

7. Min. pipe spillway capacity, $Q_{ps} = Q_{peak} = \underline{\hspace{2cm}}$ cfs.
8. $H = \underline{\hspace{2cm}}$ ft. Barrel length = ft.
9. Barrel: Diam. inches; $Q_{ps} = (Q) \underline{\hspace{2cm}} \times (\text{cor. fac.}) \underline{\hspace{2cm}} = \underline{\hspace{2cm}}$ cfs.
10. Riser: Diam. inches; Length ft.; $h = \underline{\hspace{2cm}}$.
11. Trash Rack: Diam. inches; $H = \underline{\hspace{2cm}}$ inches.

Emergency Spillway Design

12. Emergency Spillway Flow, $Q_{es} \geq Q_{peak} =$ _____ cfs.
(Using maximum storm to be handled for hydraulic purposes)
13. Width _____ ft. H_p _____ ft.
Entrance channel slope _____ %
Exit channel slope _____ %

ANTI-SEEP COLLAR DESIGN (If Required)

14. $y =$ _____ ft.; $z =$ _____ : 1; pipe slope = _____ %, $L_s =$ _____ ft.
Use _____ collars, _____' - _____" square; projection = _____ ft.

DESIGN ELEVATIONS

15. Riser Crest = _____ Design High Water = _____
Em. Spwy. Crest = _____ Top of Dam = _____

* adapted from USDA, Soil Conservation Service, College Park, Maryland. Standards and Specifications for Soil Erosion and Sediment Control in Developing Areas. July 1975, and modified by ABAG to reflect the surface area design criterion. Additional references include: USDA-Soil Conservation Service, Guides for Erosion and Sediment Control, Davis, California, 1977 and Fair, G.M., Geyer, J.C. and Okun, D.A., Water and Wastewater Engineering, J. Wiley & Sons, New York, 1968.

TEMPORARY SEDIMENT BASIN DESIGN DATA SHEET

INSTRUCTIONS

- 1.a Calculate runoff for the average hourly rainfall from the 10-year, 6-hour storm, by the Rational Method or other approved method.
- 1.b Particle size analysis can be performed by the engineering firm providing the geotechnical report. Choose a design particle size to obtain a desired efficiency (E percent of the soil is larger than or equal to the chosen particle size and approximates ideal basin capture efficiency) or follow local guidelines, rules and regulations. ABAG recommends designing the basin to capture the 0.02 mm particle.
- 1.c Obtain settling velocity versus particle size from charts or graphs such as those given in Water and Wastewater Engineering (1968) or other engineering handbooks.
2. The minimum surface area, to capture particles of selected diameter and larger, is the inverse of the particle settling velocity multiplied by 1.2 and by the average runoff in cfs. (For 0.02 mm diameter particles the surface area is 1250 sq. ft. per cfs of runoff.)
3. The minimum settling depth is 2 ft.
4. For the required storage depth, estimate the soil loss in cubic yards using the USLE. (Average dry unit weight of sediment eroded and deposited in reservoirs is approximately 75 lb/cubic feet and 1 ton/cubic yard.)* Convert to cubic feet (x 27). Multiply by E from step 1b. (E approximates the capture efficiency of a properly designed basin). Divide by the surface area to obtain the required depth of storage in feet.
5. The required volume of the basin is the surface area times the sum of the storage and settling depths.

The volume of a naturally shaped (no excavation in basin) basin may be approximated by the formula $V = 0.4A d$, where V is in cubic feet, A is the surface area of the basin, in square feet, and d is the maximum depth of the basin, in feet. Volume may be computed from contour information or other suitable methods.

If volume of basin is not adequate, excavate to obtain the required volume.

Unobstructed basin settling depth must be maintained. Therefore cleanout is required when sediment accumulates within 2 feet of the top of the riser.

6. Calculate peak runoff by applying 50% in one hour of the 10-year, 6-hour total rainfall to the Rational Method or other approved method.
7. Design the pipe spillway to carry the peak runoff.
8. Determine value of "H" from field conditions; "H" is interval between the centerline of the outlet pipe and the emergency spillway crest or if there is no emergency spillway, to the design high water.

9. See Pipe Spillway Design Charts, beginning on p. D-5.
10. See Riser Inflow Curves, p. D-6.
11. See Trash Rack and Anti-Vortex Device Design, p. D-9.
12. Design the emergency spillway to carry at least the peak runoff from the 10 year 6-hour storm. Preferably a larger design storm should be used, one commensurate with the degree of risk associated with failure of the structure.
13. Use appropriate tables to obtain values of H_p , bottom width, and actual Q_{es} . See p. D-11 - 12 for design of earth spillways.
14. See Anti-Seep Collar Design, p. D-13 - 17.
15. Fill in design elevations. The emergency spillway crest must be set no closer to riser crest than value of h which causes pipe spillway to carry the minimum required Q . Therefore, the elevation difference between spillways shall be equal to the value of h , or one foot, whichever is greater. Design high water is the elevation of the emergency spillway crest plus the value of H_p , or if there is no emergency spillway, it is the elevation of the riser crest plus h required to handle the 10-year storm. Minimum top of dam elevation requires 1.0 ft. of freeboard above design high water.

* L. Jackson, ABAG, Water Quality Technical Memorandum No. 55, 1980.

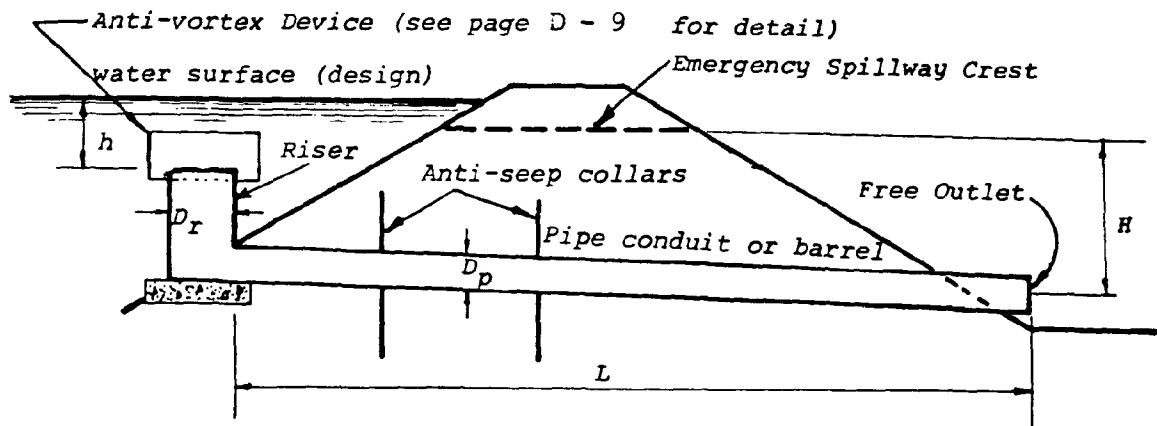
PIPE SPILLWAY DESIGN

H = Head on pipe spillway (pipe flow), ft. (centerline of outlet to emergency spillway crest or to design high water if no emergency spillway)

h = Head over riser crest, ft.

L = Length of pipe in ft.

D_p = Diameter of pipe conduit (barrel)

D_r = Diameter of riser

To use charts:

Enter chart, page D - 7, or D - 8 with H and required discharge.

Find diameter of pipe conduit that provides equal or greater discharge.

Enter chart, page D - 6, with actual pipe discharge. Read across to select smallest riser that provides discharge within weir flow portion of rating curve. Read down to find corresponding h required.

Example

Given: Q (required) = 5.8 cfs

L = 60'

H = 9' to centerline of pipe = Free outlet

Find: Pipe size, actual Q and size of riser.

Q of 12" pipe = 6.0 cfs x (correction factor) 1.07 = 6.4 cfs from the Pipe Flow Chart.

From Riser Inflow Curves, smallest riser = 18" (@ h = 0.6)

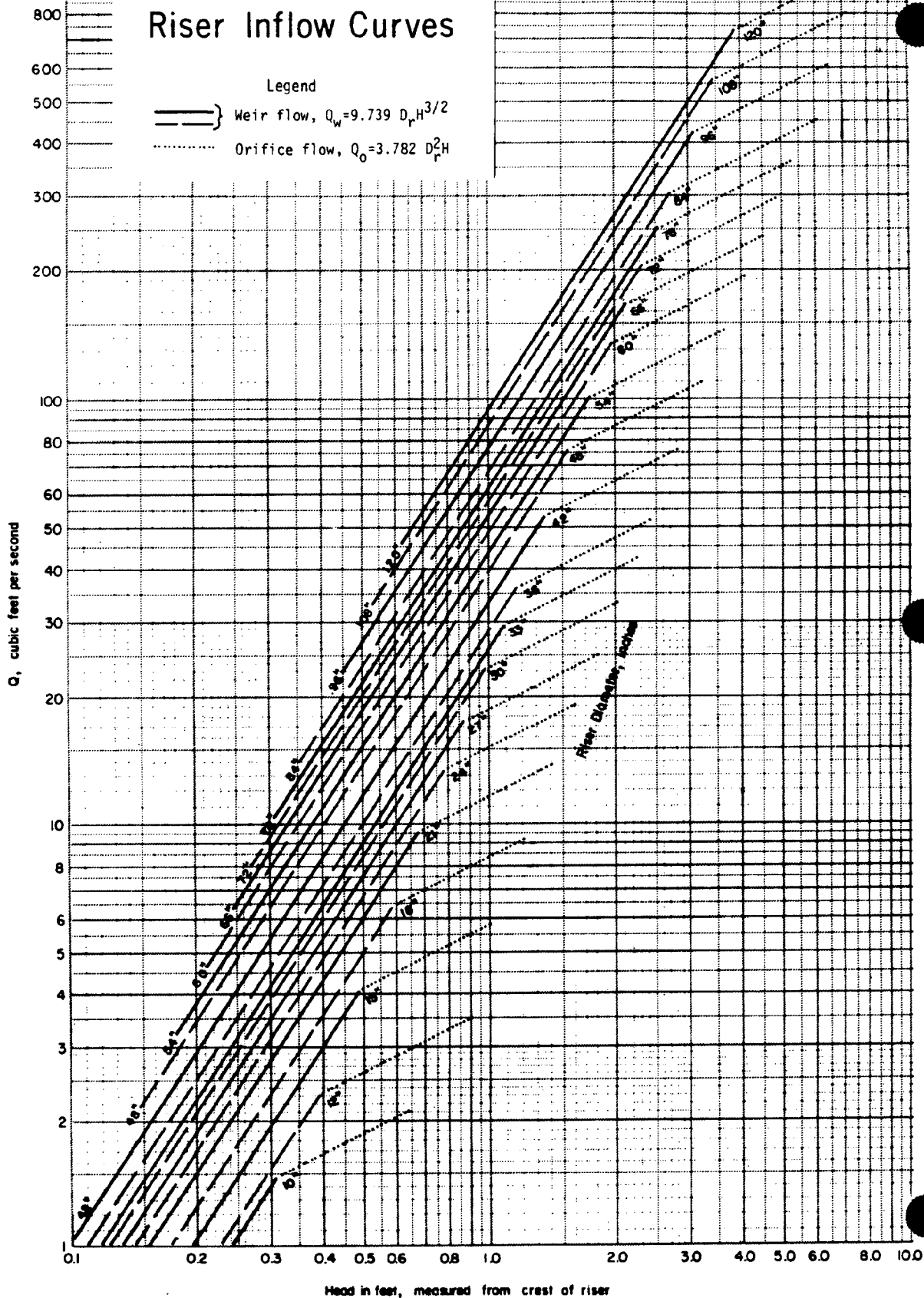

PIPE FLOW CHART $n = 0.013$
 FOR REINFORCED CONCRETE PIPE INLET $K_m = K_e + K_b = 0.65$ AND 70 FEET OF REINFORCED CONCRETE PIPE CONDUIT (full flow assumed)
 Note correction factors for pipe lengths other than 70 feet
 diameter of pipe in inches

| H, in feet | 12" | 15" | 18" | 21" | 24" | 30" | 36" | 42" | 48" | 54" | 60" | 66" | 72" | 78" | 84" | 90" | 96" | 102" |
|---------------|------|------|------|------|------|------|------|------|------|------|-----|-----|-----|------|------|------|------|------|
| 1 | 3.22 | 5.44 | 8.29 | 11.8 | 15.9 | 26.0 | 38.6 | 53.8 | 71.4 | 91.5 | 114 | 139 | 167 | 197 | 229 | 264 | 302 | 342 |
| 2 | 4.55 | 7.69 | 11.7 | 16.7 | 22.5 | 36.8 | 54.6 | 76.0 | 101 | 129 | 161 | 197 | 236 | 278 | 324 | 374 | 427 | 483 |
| 3 | 5.57 | 9.42 | 14.4 | 20.4 | 27.5 | 45.0 | 66.9 | 93.1 | 124 | 159 | 208 | 241 | 289 | 341 | 397 | 458 | 523 | 592 |
| 4 | 6.43 | 10.9 | 16.6 | 23.5 | 31.8 | 52.0 | 77.3 | 108 | 143 | 183 | 238 | 278 | 334 | 394 | 459 | 529 | 604 | 683 |
| 5 | 7.19 | 12.2 | 18.5 | 26.3 | 35.5 | 58.1 | 86.4 | 120 | 160 | 205 | 255 | 311 | 373 | 440 | 513 | 591 | 675 | 764 |
| 6 | 7.88 | 13.3 | 20.3 | 28.8 | 38.9 | 63.7 | 94.6 | 132 | 175 | 224 | 280 | 341 | 409 | 482 | 562 | 647 | 739 | 837 |
| 7 | 8.51 | 14.4 | 21.9 | 31.1 | 42.0 | 68.8 | 102 | 142 | 189 | 242 | 302 | 368 | 441 | 521 | 607 | 699 | 798 | 904 |
| 8 | 9.10 | 15.4 | 23.5 | 33.3 | 44.9 | 73.5 | 109 | 152 | 202 | 259 | 323 | 394 | 472 | 557 | 645 | 748 | 854 | 966 |
| 9 | 9.65 | 16.3 | 24.9 | 35.3 | 47.7 | 78.0 | 116 | 161 | 214 | 275 | 342 | 418 | 500 | 590 | 688 | 793 | 905 | 1025 |
| 10 | 10.2 | 17.2 | 26.2 | 37.2 | 50.2 | 82.2 | 122 | 170 | 226 | 289 | 361 | 440 | 527 | 622 | 725 | 836 | 954 | 1080 |
| 11 | 10.7 | 18.0 | 27.5 | 39.0 | 52.7 | 86.2 | 128 | 178 | 237 | 304 | 379 | 462 | 553 | 653 | 761 | 877 | 1001 | 1133 |
| 12 | 11.1 | 18.9 | 28.7 | 40.8 | 55.0 | 90.1 | 134 | 186 | 247 | 317 | 395 | 482 | 578 | 682 | 794 | 916 | 1045 | 1184 |
| 13 | 11.6 | 19.6 | 29.9 | 42.4 | 57.3 | 93.7 | 139 | 194 | 257 | 330 | 411 | 502 | 601 | 710 | 827 | 953 | 1088 | 1232 |
| 14 | 12.0 | 20.4 | 31.0 | 44.1 | 59.4 | 97.3 | 145 | 201 | 267 | 342 | 427 | 521 | 624 | 736 | 858 | 989 | 1129 | 1278 |
| 15 | 12.5 | 21.1 | 32.1 | 45.6 | 61.5 | 101 | 150 | 208 | 277 | 354 | 442 | 539 | 646 | 762 | 888 | 1024 | 1169 | 1323 |
| 16 | 12.9 | 21.8 | 33.2 | 47.1 | 63.5 | 104 | 155 | 215 | 286 | 366 | 457 | 557 | 667 | 787 | 917 | 1057 | 1207 | 1367 |
| 17 | 13.3 | 22.4 | 34.2 | 48.5 | 65.5 | 107 | 159 | 222 | 294 | 377 | 471 | 574 | 688 | 812 | 946 | 1090 | 1244 | 1409 |
| 18 | 13.7 | 23.1 | 35.2 | 49.9 | 67.4 | 110 | 164 | 228 | 303 | 388 | 484 | 591 | 708 | 835 | 973 | 1121 | 1280 | 1450 |
| 19 | 14.0 | 23.7 | 36.1 | 51.3 | 69.2 | 113 | 168 | 234 | 311 | 399 | 497 | 607 | 727 | 858 | 1000 | 1152 | 1315 | 1489 |
| 20 | 14.4 | 24.3 | 37.1 | 52.6 | 71.0 | 116 | 173 | 240 | 319 | 409 | 510 | 623 | 746 | 880 | 1026 | 1182 | 1350 | 1528 |
| 21 | 14.7 | 24.9 | 38.0 | 53.9 | 72.8 | 119 | 177 | 246 | 327 | 419 | 523 | 638 | 764 | 902 | 1051 | 1211 | 1383 | 1566 |
| 22 | 15.1 | 25.5 | 38.9 | 55.2 | 74.5 | 122 | 181 | 252 | 335 | 429 | 535 | 653 | 782 | 923 | 1076 | 1240 | 1415 | 1603 |
| 23 | 15.4 | 26.1 | 39.8 | 56.5 | 76.2 | 125 | 186 | 258 | 342 | 439 | 547 | 668 | 800 | 944 | 1100 | 1268 | 1447 | 1639 |
| 24 | 15.8 | 26.7 | 40.6 | 57.7 | 77.8 | 127 | 189 | 263 | 350 | 448 | 559 | 682 | 817 | 964 | 1123 | 1295 | 1478 | 1674 |
| 25 | 16.1 | 27.2 | 41.5 | 58.9 | 79.4 | 130 | 193 | 269 | 357 | 458 | 571 | 696 | 834 | 984 | 1147 | 1322 | 1509 | 1708 |
| 26 | 16.4 | 27.7 | 42.3 | 60.0 | 81.0 | 133 | 197 | 274 | 364 | 467 | 582 | 710 | 850 | 1004 | 1169 | 1348 | 1539 | 1742 |
| 27 | 16.7 | 28.3 | 43.1 | 61.2 | 82.5 | 135 | 201 | 279 | 371 | 476 | 593 | 723 | 867 | 1023 | 1192 | 1373 | 1568 | 1775 |
| 28 | 17.0 | 28.8 | 43.9 | 62.3 | 84.1 | 138 | 204 | 285 | 378 | 484 | 604 | 737 | 883 | 1041 | 1214 | 1399 | 1597 | 1808 |
| 29 | 17.3 | 29.3 | 44.7 | 63.4 | 85.5 | 140 | 208 | 290 | 384 | 493 | 615 | 750 | 898 | 1060 | 1235 | 1423 | 1625 | 1840 |
| 30 | 17.6 | 29.8 | 45.4 | 64.5 | 87.0 | 142 | 212 | 294 | 391 | 501 | 625 | 763 | 913 | 1078 | 1256 | 1448 | 1653 | 1871 |

Correction Factors For Other Pipe Lengths

| L, in feet | 1.30 | 1.24 | 1.18 | 1.15 | 1.12 | 1.12 | 1.10 | 1.08 | 1.07 | 1.06 | 1.05 | 1.05 | 1.04 | 1.04 | 1.03 | 1.03 | 1.03 | 1.03 | 1.03 |
|---------------|------|------|------|------|------|------|------|------|------|------|------|------|------|------|------|------|------|------|------|
| 20 | 1.30 | 1.24 | 1.18 | 1.15 | 1.12 | 1.12 | 1.10 | 1.08 | 1.07 | 1.06 | 1.05 | 1.05 | 1.04 | 1.04 | 1.03 | 1.03 | 1.03 | 1.03 | 1.03 |
| 30 | 1.22 | 1.18 | 1.13 | 1.12 | 1.09 | 1.09 | 1.08 | 1.06 | 1.05 | 1.05 | 1.04 | 1.04 | 1.03 | 1.03 | 1.02 | 1.02 | 1.02 | 1.02 | 1.02 |
| 40 | 1.15 | 1.13 | 1.10 | 1.08 | 1.07 | 1.07 | 1.05 | 1.05 | 1.04 | 1.03 | 1.03 | 1.03 | 1.02 | 1.02 | 1.01 | 1.01 | 1.01 | 1.01 | 1.01 |
| 50 | 1.09 | 1.08 | 1.06 | 1.05 | 1.04 | 1.04 | 1.04 | 1.03 | 1.03 | 1.02 | 1.02 | 1.02 | 1.01 | 1.01 | 1.01 | 1.01 | 1.01 | 1.01 | 1.01 |
| 60 | 1.04 | 1.03 | 1.03 | 1.03 | 1.02 | 1.02 | 1.02 | 1.02 | 1.01 | 1.01 | 1.01 | 1.01 | 1.01 | 1.01 | 1.01 | 1.01 | 1.01 | 1.01 | 1.01 |
| 70 | 1.00 | 1.00 | 1.00 | 1.00 | 1.00 | 1.00 | 1.00 | 1.00 | 1.00 | 1.00 | 1.00 | 1.00 | 1.00 | 1.00 | 1.00 | 1.00 | 1.00 | 1.00 | 1.00 |
| 80 | .96 | .97 | .97 | .98 | .98 | .98 | .98 | .99 | .99 | .99 | .99 | .99 | .99 | .99 | .99 | .99 | .99 | .99 | .99 |
| 90 | .93 | .94 | .94 | .95 | .96 | .96 | .97 | .97 | .98 | .98 | .98 | .98 | .98 | .98 | .98 | .98 | .98 | .98 | .98 |
| 100 | .90 | .91 | .92 | .93 | .95 | .95 | .95 | .96 | .97 | .97 | .97 | .98 | .98 | .98 | .98 | .98 | .98 | .98 | .98 |
| 120 | .84 | .86 | .87 | .89 | .91 | .91 | .93 | .94 | .94 | .95 | .96 | .96 | .96 | .97 | .97 | .97 | .97 | .97 | .97 |
| 140 | .80 | .82 | .83 | .85 | .86 | .88 | .90 | .91 | .92 | .93 | .94 | .94 | .95 | .95 | .96 | .96 | .96 | .96 | .96 |
| 160 | .76 | .78 | .80 | .82 | .83 | .86 | .88 | .89 | .90 | .91 | .92 | .93 | .94 | .94 | .95 | .95 | .95 | .95 | .95 |

PIPE FLOW CHART $n = 0.025$
 FOR CORRUGATED METAL PIPE INLET $K_m = K_e + K_D = 1.0$ AND 70 FEET OF CORRUGATED METAL PIPE CONDUIT (full flow assumed)
 Note correction factors for pipe lengths other than 70 feet
 diameter of pipe in inches

| H, in feet | 6" | 8" | 10" | 12" | 15" | 18" | 21" | 24" | 30" | 36" | 42" | 48" | 54" | 60" | 66" | 72" | 78" | 84" | 90" | 96" | 102" |
|---------------|------|------|------|------|------|------|------|------|------|------|------|------|------|------|-----|-----|-----|------|------|------|------|
| 1 | 0.33 | 0.70 | 1.25 | 1.98 | 3.48 | 5.47 | 7.99 | 11.0 | 18.8 | 28.8 | 41.1 | 55.7 | 72.6 | 91.8 | 113 | 137 | 163 | 191 | 222 | 255 | 290 |
| 2 | 0.47 | 0.99 | 1.76 | 2.80 | 4.92 | 7.74 | 11.3 | 15.6 | 26.6 | 40.8 | 58.2 | 78.8 | 103 | 130 | 160 | 194 | 231 | 271 | 314 | 360 | 410 |
| 3 | 0.58 | 1.22 | 2.16 | 3.43 | 6.02 | 9.48 | 13.8 | 19.1 | 32.6 | 49.9 | 71.2 | 96.5 | 126 | 159 | 196 | 237 | 282 | 331 | 384 | 441 | 502 |
| 4 | 0.67 | 1.40 | 2.49 | 3.97 | 6.96 | 10.9 | 16.0 | 22.1 | 37.6 | 57.7 | 82.3 | 111 | 145 | 184 | 226 | 274 | 326 | 383 | 444 | 510 | 580 |
| 5 | 0.74 | 1.57 | 2.79 | 4.43 | 7.78 | 12.2 | 17.9 | 24.7 | 42.1 | 64.5 | 92.0 | 125 | 162 | 205 | 253 | 306 | 365 | 428 | 496 | 570 | 648 |
| 6 | 0.82 | 1.72 | 3.05 | 4.86 | 8.52 | 13.4 | 19.6 | 27.0 | 46.1 | 70.6 | 101 | 136 | 178 | 225 | 277 | 336 | 399 | 469 | 544 | 624 | 710 |
| 7 | 0.88 | 1.86 | 3.30 | 5.25 | 9.20 | 14.5 | 21.1 | 29.2 | 49.8 | 76.3 | 109 | 147 | 192 | 243 | 300 | 362 | 431 | 506 | 587 | 674 | 767 |
| 8 | 0.94 | 1.99 | 3.53 | 5.61 | 9.84 | 15.5 | 22.6 | 31.2 | 53.2 | 81.5 | 116 | 158 | 205 | 260 | 320 | 388 | 461 | 541 | 628 | 721 | 820 |
| 9 | 1.00 | 2.11 | 3.74 | 5.95 | 10.4 | 16.4 | 24.0 | 33.1 | 56.4 | 86.5 | 123 | 167 | 218 | 275 | 340 | 411 | 489 | 574 | 666 | 764 | 870 |
| 10 | 1.05 | 2.22 | 3.94 | 6.27 | 11.0 | 17.3 | 25.3 | 34.9 | 59.5 | 91.2 | 130 | 176 | 230 | 290 | 358 | 433 | 516 | 605 | 702 | 806 | 917 |
| 11 | 1.10 | 2.33 | 4.13 | 6.58 | 11.5 | 18.2 | 26.5 | 36.6 | 62.4 | 95.6 | 136 | 185 | 241 | 304 | 376 | 454 | 541 | 635 | 736 | 845 | 962 |
| 12 | 1.15 | 2.43 | 4.32 | 6.87 | 12.1 | 19.0 | 27.7 | 38.2 | 65.2 | 99.9 | 142 | 193 | 252 | 318 | 392 | 475 | 565 | 663 | 769 | 883 | 1004 |
| 13 | 1.20 | 2.53 | 4.49 | 7.15 | 12.6 | 19.7 | 28.8 | 39.8 | 67.8 | 104 | 148 | 201 | 262 | 331 | 408 | 494 | 588 | 690 | 800 | 919 | 1045 |
| 14 | 1.25 | 2.63 | 4.66 | 7.42 | 13.0 | 20.5 | 29.9 | 41.3 | 70.4 | 108 | 154 | 208 | 272 | 343 | 424 | 513 | 610 | 716 | 830 | 953 | 1085 |
| 15 | 1.29 | 2.72 | 4.83 | 7.68 | 13.5 | 21.2 | 30.9 | 42.8 | 72.8 | 112 | 159 | 216 | 281 | 355 | 439 | 531 | 631 | 741 | 860 | 987 | 1121 |
| 16 | 1.33 | 2.81 | 4.99 | 7.93 | 13.9 | 21.9 | 32.0 | 44.2 | 75.2 | 115 | 165 | 223 | 290 | 367 | 453 | 548 | 652 | 765 | 888 | 1019 | 1160 |
| 17 | 1.37 | 2.90 | 5.14 | 8.18 | 14.3 | 22.6 | 32.9 | 45.5 | 77.5 | 119 | 170 | 230 | 299 | 379 | 467 | 565 | 672 | 789 | 915 | 1051 | 1195 |
| 18 | 1.41 | 2.98 | 5.29 | 8.41 | 14.8 | 23.2 | 33.9 | 46.8 | 79.8 | 120 | 174 | 236 | 308 | 389 | 480 | 581 | 692 | 812 | 942 | 1081 | 1230 |
| 19 | 1.45 | 3.06 | 5.43 | 8.64 | 15.2 | 23.9 | 34.8 | 48.1 | 82.0 | 126 | 179 | 243 | 316 | 400 | 494 | 597 | 711 | 834 | 967 | 1111 | 1264 |
| 20 | 1.49 | 3.14 | 5.57 | 8.87 | 15.6 | 24.5 | 35.7 | 49.4 | 84.1 | 129 | 184 | 249 | 325 | 410 | 506 | 613 | 729 | 856 | 993 | 1139 | 1297 |
| 21 | 1.53 | 3.22 | 5.71 | 9.09 | 15.9 | 25.1 | 36.6 | 50.6 | 86.2 | 132 | 188 | 255 | 333 | 421 | 519 | 628 | 747 | 877 | 1017 | 1168 | 1329 |
| 22 | 1.56 | 3.29 | 5.85 | 9.30 | 16.3 | 25.7 | 37.5 | 51.8 | 88.2 | 135 | 193 | 261 | 341 | 430 | 531 | 643 | 765 | 898 | 1041 | 1195 | 1360 |
| 23 | 1.60 | 3.37 | 5.98 | 9.51 | 16.7 | 26.2 | 38.3 | 53.0 | 90.2 | 138 | 197 | 267 | 348 | 440 | 543 | 657 | 782 | 918 | 1064 | 1222 | 1390 |
| 24 | 1.63 | 3.44 | 6.11 | 9.72 | 17.0 | 26.8 | 39.1 | 54.1 | 92.1 | 141 | 201 | 273 | 356 | 450 | 555 | 671 | 799 | 937 | 1087 | 1248 | 1420 |
| 25 | 1.66 | 3.51 | 6.23 | 9.92 | 17.4 | 27.4 | 39.9 | 55.2 | 94.0 | 144 | 206 | 279 | 363 | 459 | 566 | 685 | 815 | 957 | 1110 | 1274 | 1450 |
| 26 | 1.70 | 3.58 | 6.36 | 10.1 | 17.7 | 27.9 | 40.7 | 56.3 | 95.9 | 147 | 210 | 284 | 370 | 468 | 577 | 699 | 831 | 976 | 1132 | 1299 | 1478 |
| 27 | 1.73 | 3.65 | 6.48 | 10.3 | 18.1 | 28.4 | 41.5 | 57.4 | 97.7 | 150 | 214 | 290 | 377 | 477 | 588 | 712 | 847 | 994 | 1153 | 1324 | 1507 |
| 28 | 1.76 | 3.72 | 6.60 | 10.5 | 18.4 | 29.0 | 42.3 | 58.4 | 99.5 | 153 | 218 | 295 | 384 | 486 | 599 | 725 | 863 | 1013 | 1174 | 1348 | 1534 |
| 29 | 1.79 | 3.78 | 6.71 | 10.7 | 18.7 | 29.5 | 43.0 | 59.5 | 101 | 155 | 221 | 300 | 391 | 494 | 610 | 738 | 878 | 1030 | 1195 | 1372 | 1561 |
| 30 | 1.82 | 3.85 | 6.83 | 10.9 | 19.1 | 30.0 | 43.7 | 60.5 | 103 | 158 | 225 | 305 | 398 | 503 | 620 | 750 | 893 | 1048 | 1216 | 1396 | 1588 |

| L, in feet | 20 | 30 | 40 | 50 | 60 | 70 | 80 | 90 | 100 | 120 | 140 | 160 |
|---------------|------|------|------|------|------|------|------|------|------|------|------|------|
| 20 | 1.69 | 1.63 | 1.58 | 1.53 | 1.47 | 1.42 | 1.37 | 1.34 | 1.28 | 1.24 | 1.16 | 1.14 |
| 30 | 1.44 | 1.41 | 1.39 | 1.36 | 1.32 | 1.29 | 1.27 | 1.24 | 1.21 | 1.18 | 1.12 | 1.11 |
| 40 | 1.28 | 1.27 | 1.25 | 1.23 | 1.21 | 1.20 | 1.18 | 1.17 | 1.14 | 1.12 | 1.09 | 1.08 |
| 50 | 1.16 | 1.16 | 1.15 | 1.14 | 1.13 | 1.12 | 1.11 | 1.10 | 1.09 | 1.08 | 1.06 | 1.05 |
| 60 | 1.07 | 1.07 | 1.07 | 1.06 | 1.06 | 1.05 | 1.05 | 1.05 | 1.04 | 1.04 | 1.03 | 1.02 |
| 70 | 1.00 | 1.00 | 1.00 | 1.00 | 1.00 | 1.00 | 1.00 | 1.00 | 1.00 | 1.00 | 1.00 | 1.00 |
| 80 | .94 | .94 | .95 | .95 | .95 | .95 | .96 | .96 | .96 | .97 | .97 | .98 |
| 90 | .89 | .89 | .90 | .90 | .91 | .91 | .91 | .92 | .92 | .94 | .95 | .96 |
| 100 | .85 | .85 | .86 | .86 | .87 | .88 | .89 | .90 | .91 | .92 | .93 | .94 |
| 120 | .78 | .79 | .79 | .80 | .81 | .82 | .83 | .85 | .86 | .87 | .89 | .90 |
| 140 | .72 | .73 | .74 | .75 | .76 | .77 | .78 | .79 | .81 | .82 | .84 | .85 |
| 160 | .68 | .69 | .69 | .70 | .71 | .73 | .74 | .75 | .77 | .79 | .80 | .82 |

Correction Factors For Other Pipe Lengths

Top stiffener (if required) is $\frac{x}{x}$ x $\frac{x}{x}$ angle welded to top and oriented perpendicular to corrugations.

Top is $\frac{x}{x}$ gage corrugated metal or 1/8" steel plate. Pressure relief holes may be omitted, if ends of corrugations are left fully open when corrugated top is welded to cylinder.

Cylinder is $\frac{x}{x}$ gage corrugated metal pipe or fabricated from 1/8" steel plate.

- Notes:
- 1) The cylinder must be firmly fastened to the top of the riser.
 - 2) Support bars are welded to the top of the riser or attached by straps bolted to top of riser.

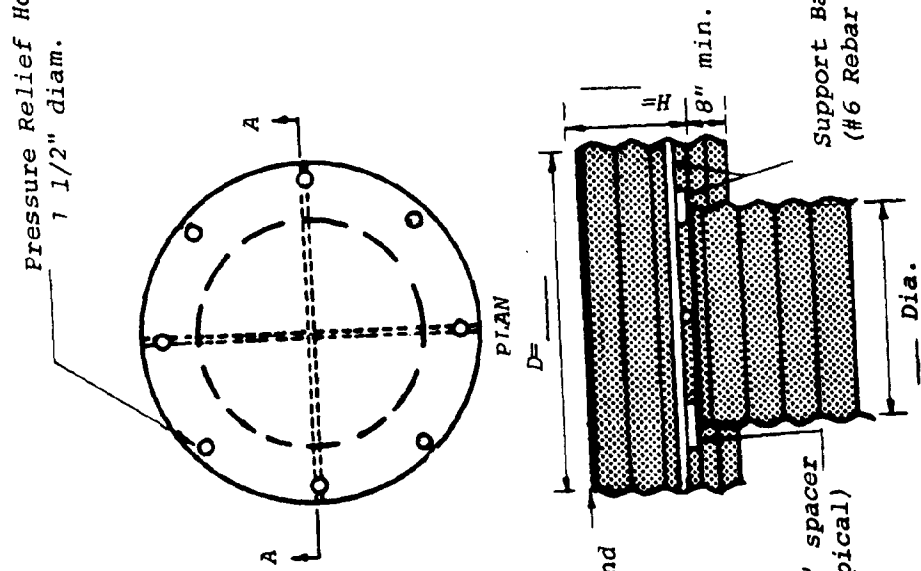
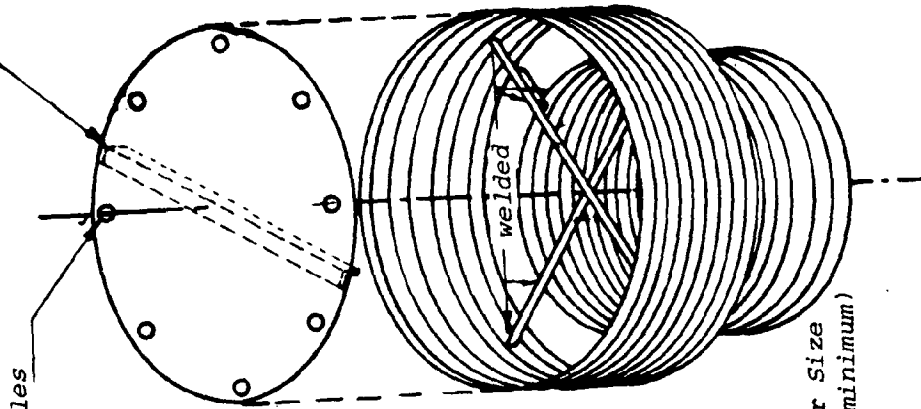

CONCENTRIC TRASH RACK AND ANTI-VORTEX DEVICE
(not to scale)

SECTION A-A

CONCENTRIC TRASH RACK AND ANTI-VORTEX DEVICE

DESIGN TABLE

| Riser Diam., in. | Cylinder | | H, in. | Minimum Size Support Bar | Minimum Top | |
|---------------------|-----------|-----------------|--------|--|-----------------------|----------------------------|
| | Diam. in. | Thick., gage | | | Thickness | Stiffener |
| 12 | 18 | 16 | 6 | #6 Rebar | 16 ga. | - |
| 15 | 21 | 16 | 7 | " | " | - |
| 18 | 27 | 16 | 8 | " | " | - |
| 21 | 30 | 16 | 11 | " | " | - |
| 24 | 36 | 16 | 13 | " | 14 ga. | - |
| 27 | 42 | 16 | 15 | " | 14 ga. | - |
| 36 | 54 | 14 | 17 | #8 Rebar | 12 ga. | - |
| 42 | 60 | 14 | 19 | " | " | - |
| 48 | 72 | 12 | 21 | 1-1/4" pipe or 1-1/4x1-1/4x1/4 angle | 10 ga. | - |
| 54 | 78 | 12 | 25 | " | " | - |
| 60 | 90 | 12 | 29 | 1-1/2" pipe or 1-1/2x1-1/2x1/4 angle | 8 ga. | - |
| 66 | 96 | 10 | 33 | 2" pipe or 2x2x3/16 angle | 8 ga., w/stiffener | 2x2x1/4 angle |
| 72 | 102 | 10 | 36 | " | " | 2-1/2x2-1/2x 1/4 angle |
| 78 | 114 | 10 | 39 | 2-1/2" pipe or 2x2x1/4 angle | " | " |
| 84 | 120 | 10 | 42 | 2-1/2" pipe or 2-1/2x2-1/2x1/4 angle | " | 2-1/2x2-1/2x 5/16 angle |

Note: The criteria for sizing the cylinder is that the area between the inside of the cylinder and the outside of the riser is equal to or greater than the area inside the riser. Therefore, the above table is invalid for use with concrete pipe risers.

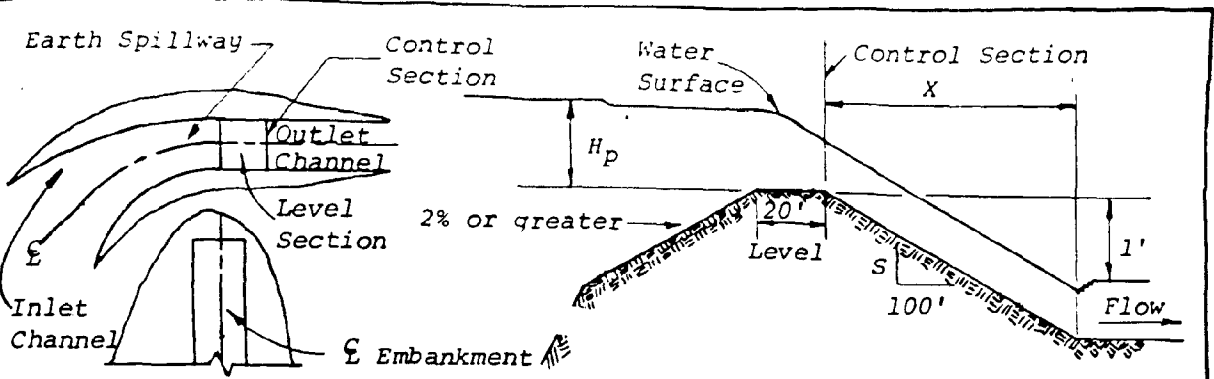

PLAN OF EARTH SPILLWAY

PROFILE ALONG E OF EARTH SPILLWAY

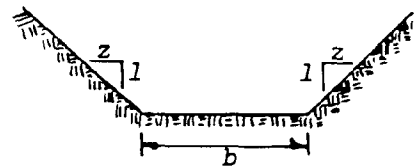

CROSS SECTION OF EARTH SPILLWAY AT CONTROL SECTION

LEGEND

- n = Manning's Coefficient of Roughness.
- H_p = Difference in Elevation between Crest of Earth Spillway at the Control Section and Water Surface in Reservoir, in feet.
- b = Bottom Width of Earth Spillway at the Control Section, in feet.
- Q = Total Discharge, in cfs.
- V = Velocity, in feet per second, that will exist in Channel below Control Section, at Design Q, if constructed to slope (S) that is shown.
- S = Flattest Slope (S), in %, allowable for Channel below Control Section.
- X = Minimum Length of Channel below Control Section, in feet.
- z = Side Slope Ratio.

NOTES:

- 1) For a given H_p a decrease in the exit slope from S as given in the table decreases spillway discharge but increasing the exit slope from S does not increase discharge. If an exit slope (S_e) steeper than S is used, then velocity (V_e) in the exit channel will increase according to the following relationship:

$$V_e = V \left(\frac{S_e}{S} \right)^{0.3}$$
- 2) Data to right of heavy vertical lines on drawings should be used with caution, as the resulting sections will be either poorly proportioned or have velocities in excess of 6 ft/sec.

U. S. DEPARTMENT OF AGRICULTURE
SOIL CONSERVATION SERVICE
College Park, Md.

DESIGN DATA FOR
EARTH SPILLWAYS

Ref: Engineering
Field Manual

DESIGN DATA FOR EARTH SPILLWAYS

SIDE SLOPE 2:1
VEGETATED n=0.040

Table with columns: STAGE (Hft) IN FEET, SPILLWAY CHARACTERISTICS, and BOTTOM WIDTH (b) IN FEET. Rows are categorized by stage (0.5 to 2.4) and spillway characteristics (Q, V, S, X). The table provides numerical values for various flow and velocity parameters across different bottom widths from 8 to 40 feet.

REFERENCE: Engineering Field Manual; U. S. DEPARTMENT OF AGRICULTURE SOIL CONSERVATION SERVICE; ENGINEERING & WATERSHED PLANNING UNIT, UPPER DARBY, PENNSYLVANIA; RTSC-NE-ENG. 1110; SHEET 4 OF 11

ANTI-SEEP COLLAR DESIGN

This procedure provides the anti-seep collar dimensions for only temporary sediment basins to increase the seepage length by 10% for various pipe slopes, embankment slopes and riser heights. This does not apply to permanent structures, which must have an increase of 15% in the seepage length.

The first step in designing anti-seep collars is to determine the length of pipe within the saturated zone of the embankment. This can be done graphically or by the following equation, assuming that the upstream slope of the embankment intersects the invert of the pipe at its upstream end. (See embankment-invert intersection on the drawing below:

$$L_s = y (z + 4) \left[1 + \frac{\text{pipe slope}}{0.25\text{-pipe slope}} \right]$$

where: L_s = length of pipe in the saturated zone (ft.)

y = distance in feet from upstream invert of pipe to highest normal water level expected to occur during the life of the structure, usually the top of the riser.

z = slope of upstream embankment as a ratio of z ft. horizontal to one ft. vertical.

pipe slope = slope of pipe in feet per foot.

This procedure is based on the approximation of the phreatic line as shown in the drawing below:

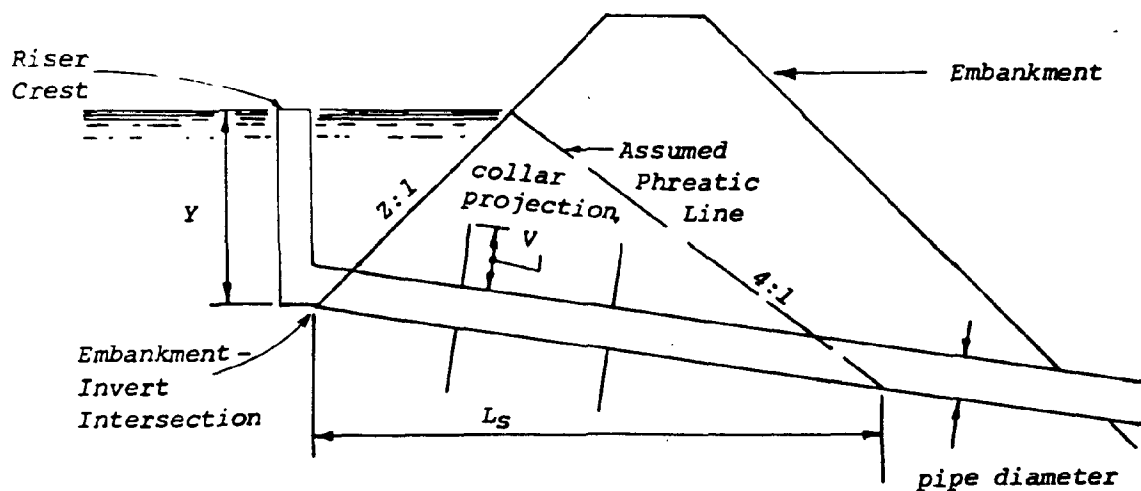

The solution to this equation is given by the chart on the following page for a range of sediment basin configurations. The anti-seep collar size can then be found from the chart on the succeeding page.

Example - Given: $y = 8$ ft., embankment slope = 2.5:1, pipe slope = 10%,
pipe diameter = 36".

Find: number and size of anti-seep collars.

On page D - 15 of this Appendix, read saturated length, $L_s = 87$ ft. On page D - 16 for two collars, the size would be 7.3', and for three collars, 5.9'. Select the two collars since they would be less expensive and easier to install. Collar sizes should be given in feet and inches, therefore, use 2 collars 7'-4" x 7'-4". From page D - 16 the projection is 2.15'. Therefore, maximum collar spacing is $(14) (2.15) = 30.1$ ft.

PIPE LENGTH IN SATURATED ZONE

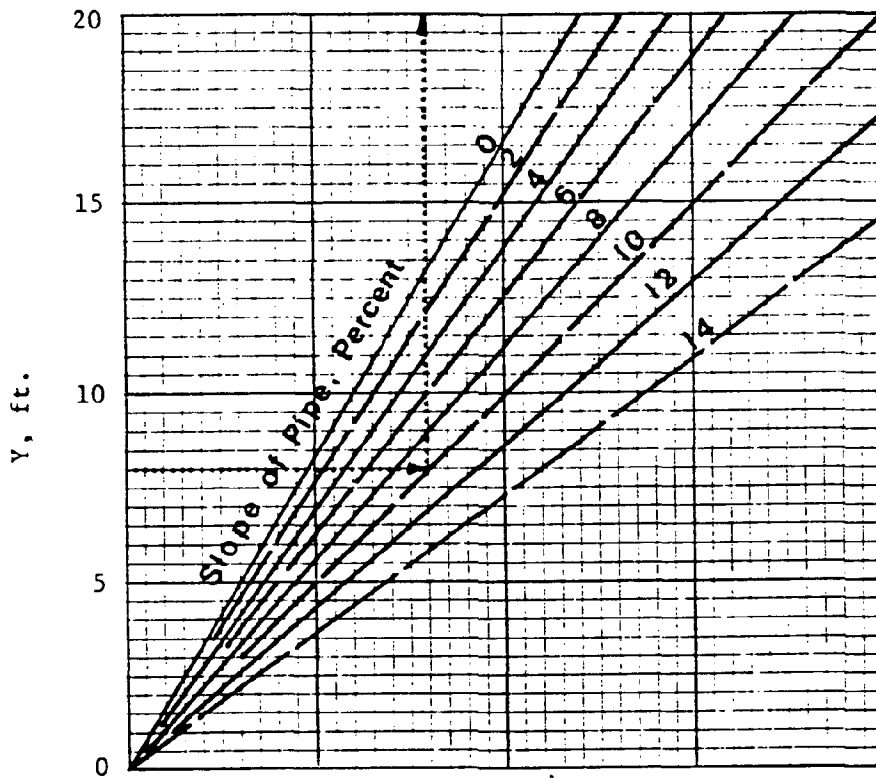
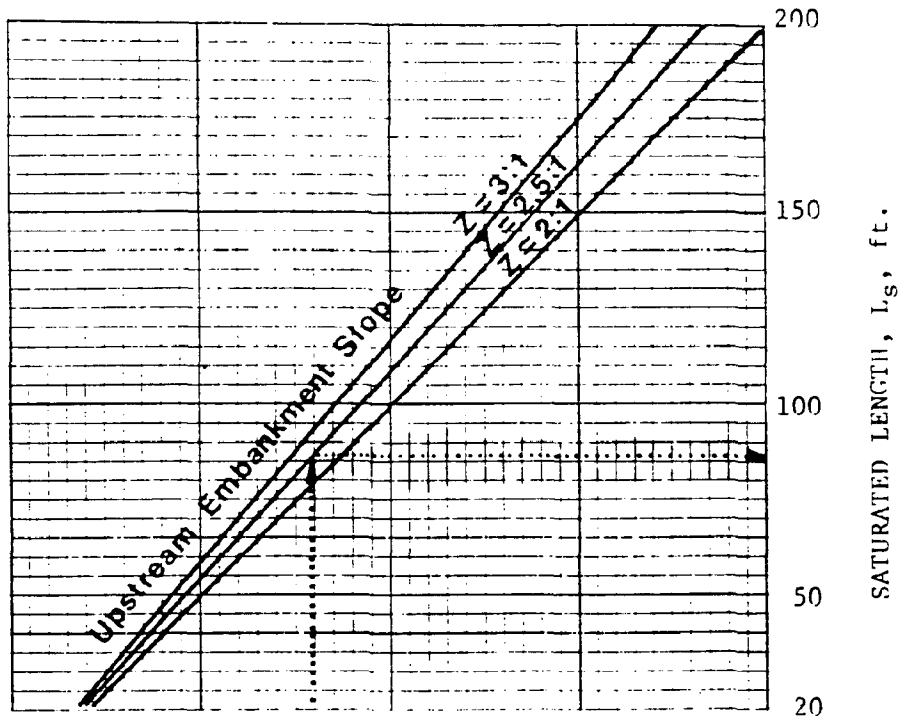

ANTI-SEEP COLLAR DESIGN

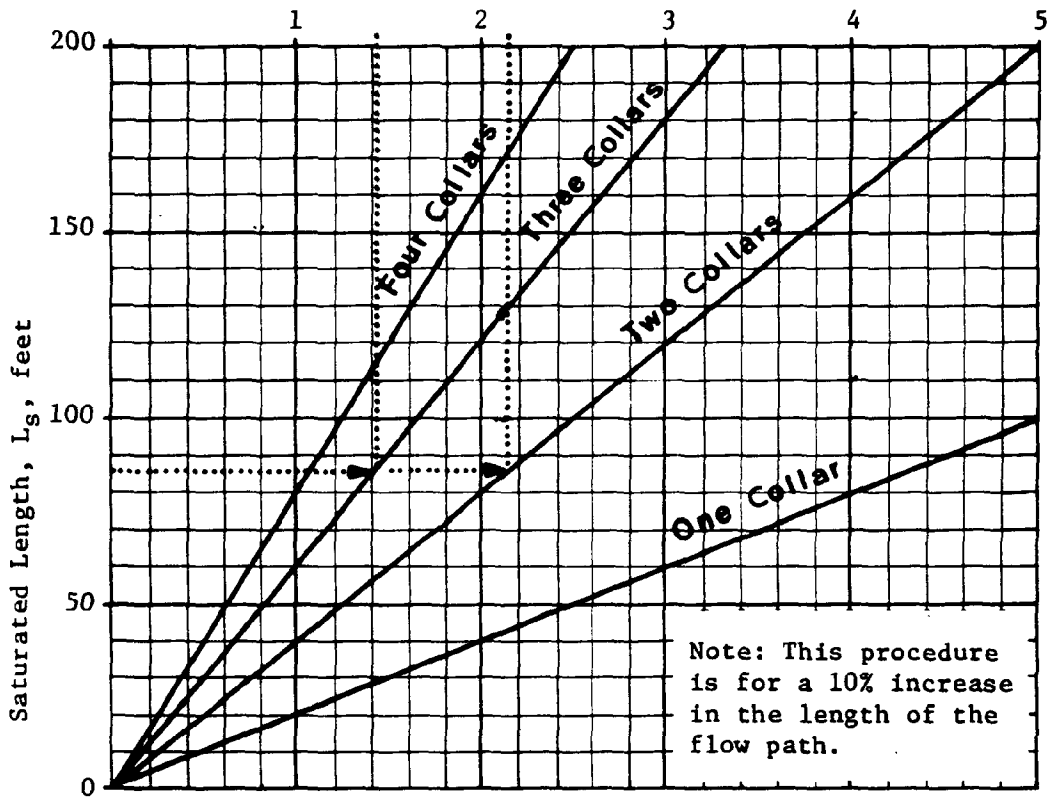
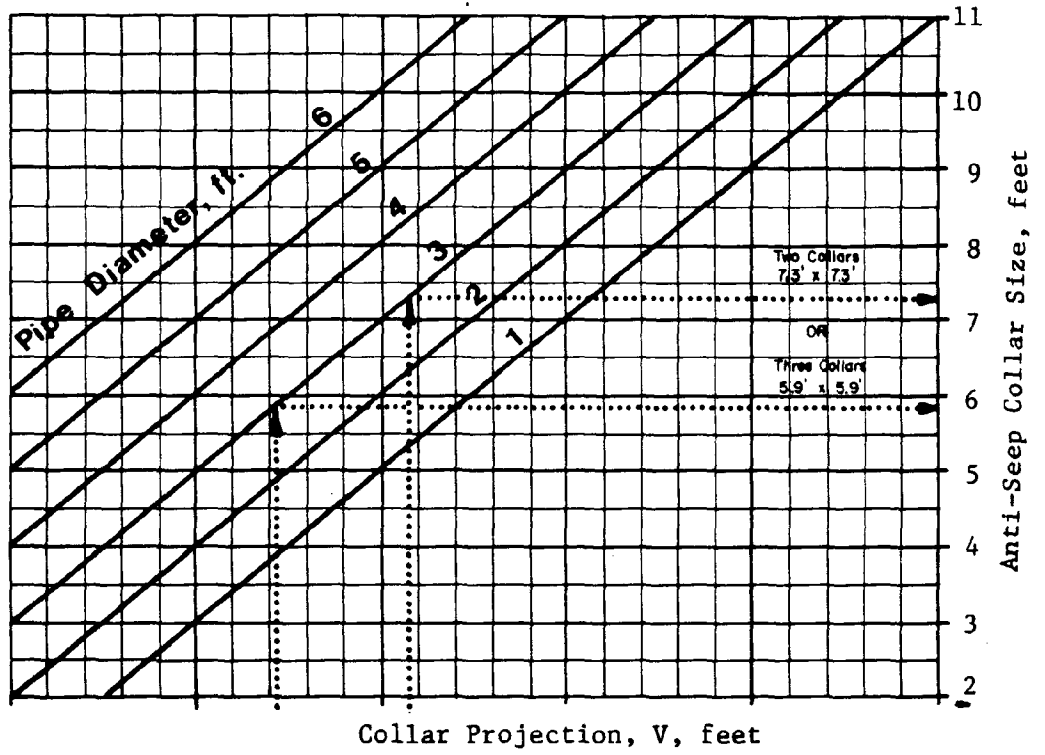

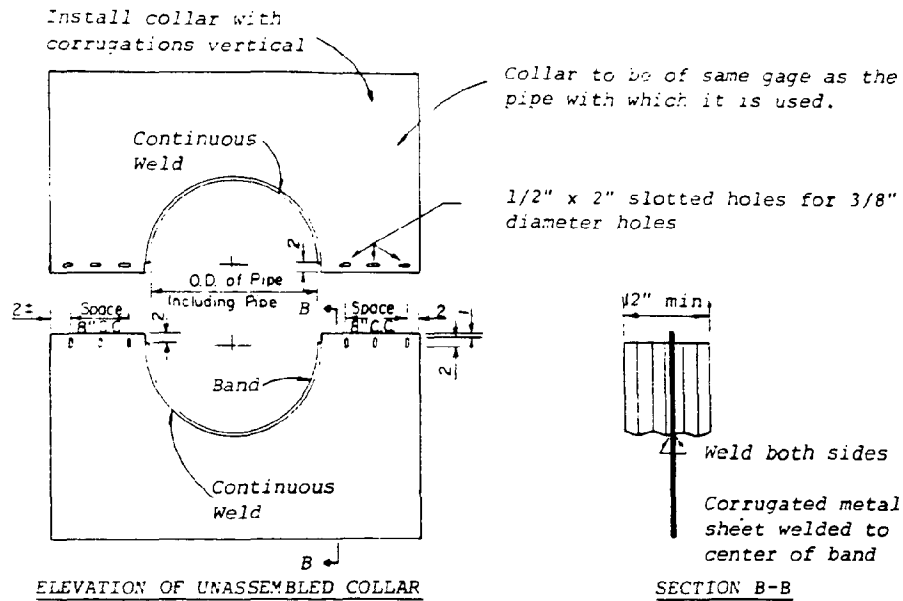

ELEVATION OF UNASSEMBLED COLLAR

SECTION B-B

NOTES FOR COLLARS:

1. All materials to be in accordance with construction and construction material specifications.
2. When specified on the plans, coating of collars shall be in accordance with construction and construction material specifications.
3. Unassembled collars shall be marked by painting or tagging to identify matching pairs.
4. The lap between the two half sections and between the pipe and connecting band shall be caulked with asphalt mastic at time of installation.
5. Each collar shall be furnished with two 1/2" diameter rods with standard tank lugs for connecting collars to pipe.

DETAILS OF CORRUGATED METAL ANTI-SEEP COLLAR

Size and spacing of slotted openings shall be the same as shown for CM collar

Use rods and lugs to clamp bands securely to pipe

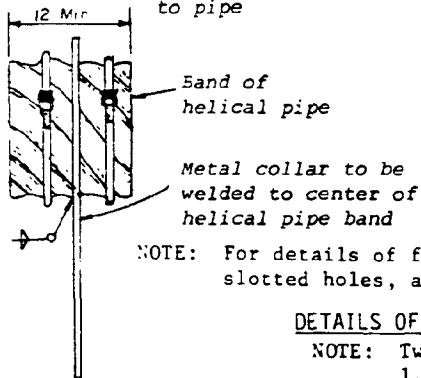

PARTIAL ELEVATION

Ref: Engr. Field Manual

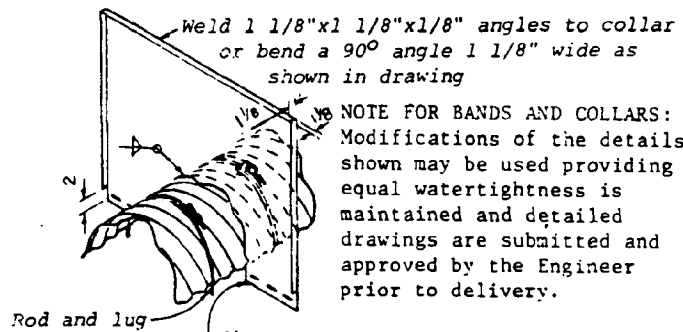

NOTE FOR BANDS AND COLLARS: Modifications of the details shown may be used providing equal watertightness is maintained and detailed drawings are submitted and approved by the Engineer prior to delivery.

Sheet metal collar shall be cut to fit corrugations of helical band, and welded with a continuous weld.

ISOMETRIC VIEW

NOTE: For details of fabrication dimensions, minimum gages, slotted holes, and notes, see detail above.

DETAILS OF HELICAL PIPE ANTI-SEEP COLLAR

NOTE: Two other types of anti-seep collars are:

1. Corrugated metal, similar to upper detail, except shop welded to a short (4 ft.) section of the pipe and connected with connecting bands to the pipe.
2. Concrete, six inches thick formed around the pipe with #3 rebar spaced 15" horizontally and vertically.

DEWATERING SEDIMENT BASIN WITH SUBSURFACE DRAIN

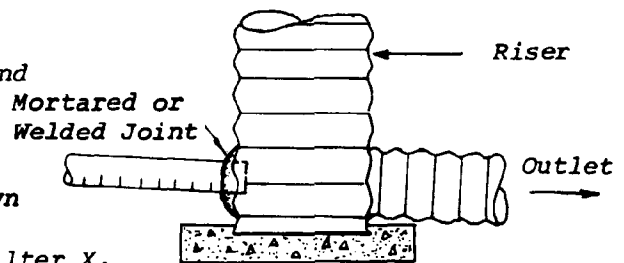
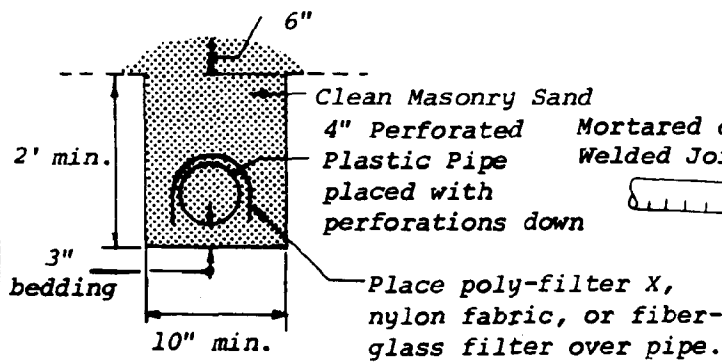
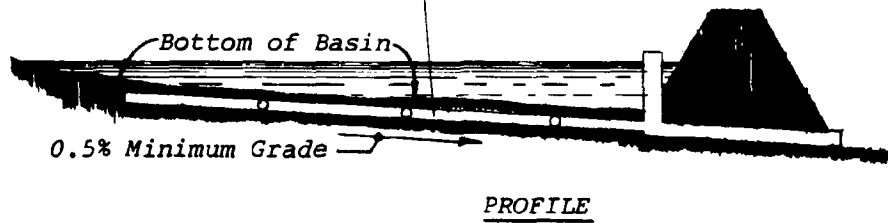
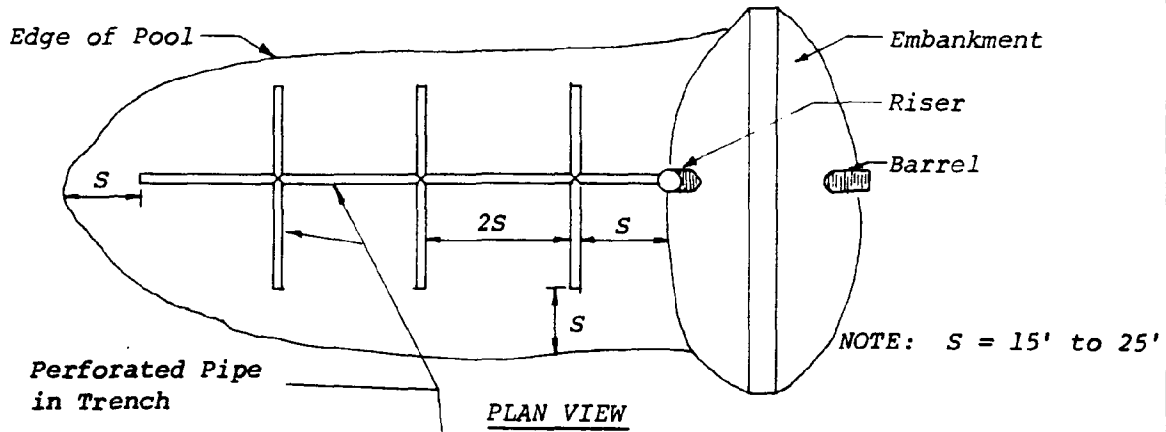

U. S. DEPARTMENT OF AGRICULTURE
SOIL CONSERVATION SERVICE
College Park, Md.

DEWATERING SEDIMENT
BASIN WITH
SUBSURFACE DRAIN

METHODS OF DEWATERING SEDIMENT BASIN DETENTION POOLS

The dewatering methods shown here are inexpensive and operate automatically. Other methods, such as pumping, may also be used.

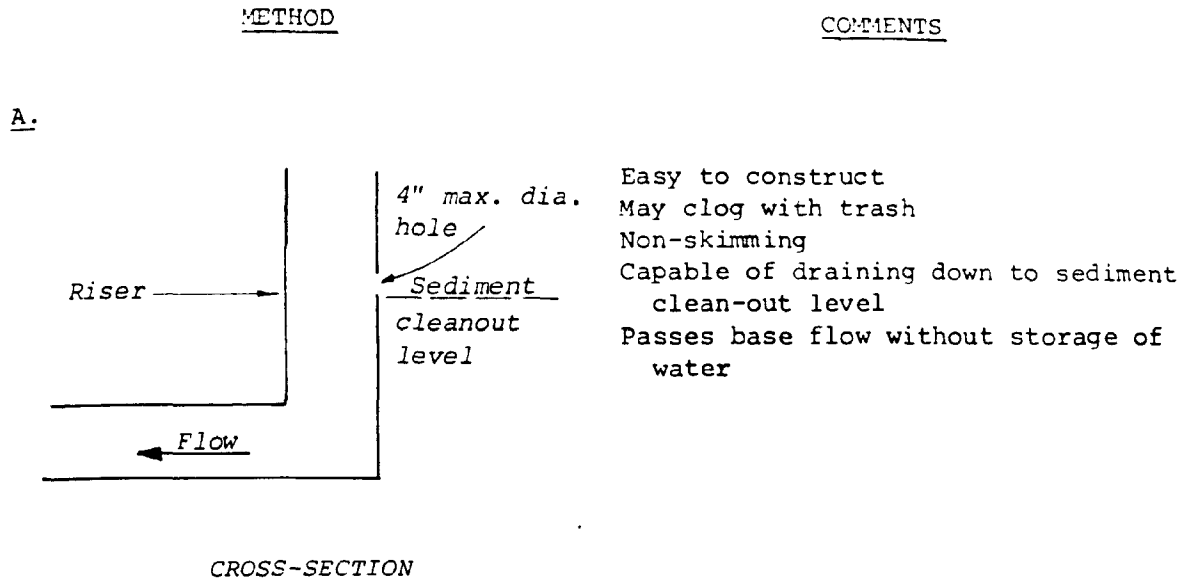

B. Same as "A" except for skimming device, detailed below:

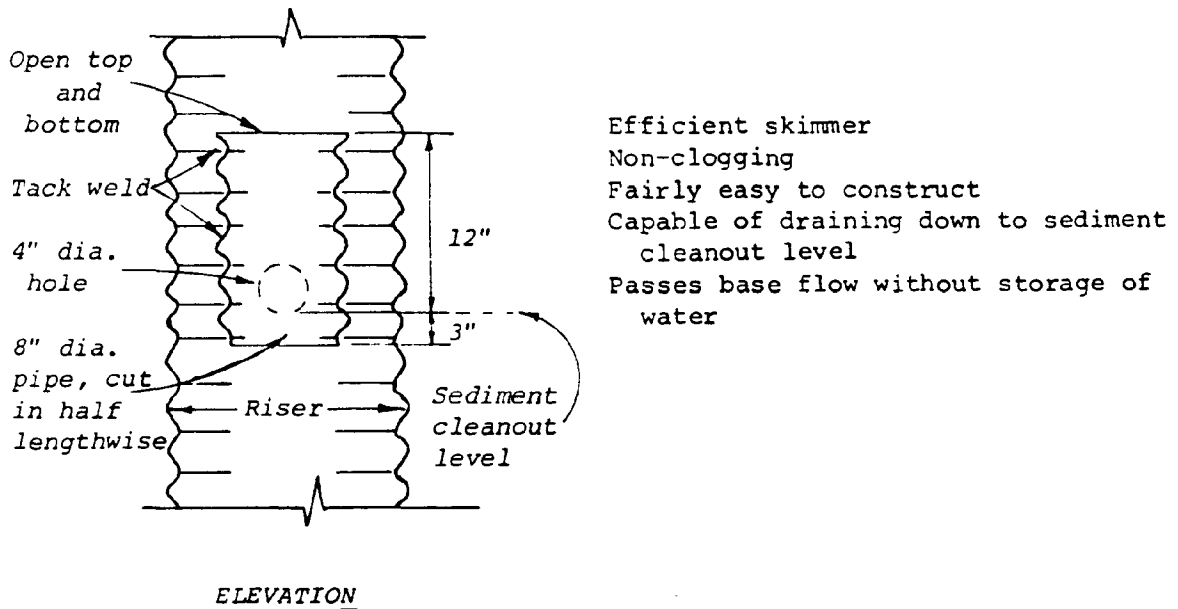

Efficient skimmer
 Non-clogging
 Fairly easy to construct
 Capable of draining down to sediment cleanout level
 Passes base flow without storage of water

METHOD

COMMENTS

C.

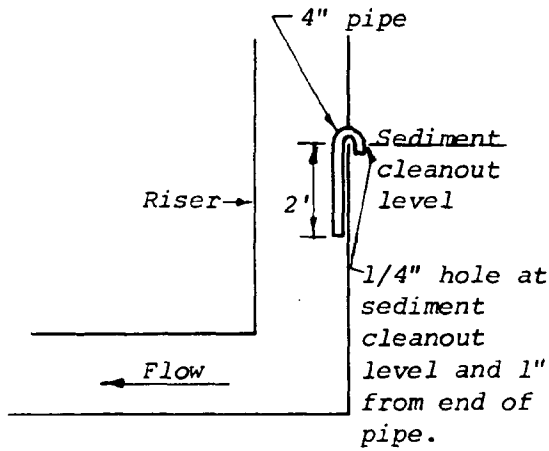

CROSS-SECTION

Efficient skimmer
 Capable of always draining down to sediment cleanout level
 Passes base flow without storage of water
 Higher discharge rate than "A" or "B".

D.

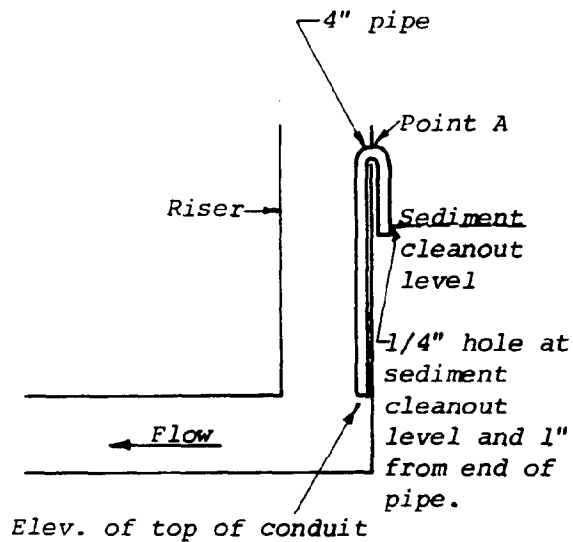

CROSS-SECTION

Efficient skimmer
 Water must inundate point A to prime siphon. Therefore, small storms or low base flow rates will not prime siphon and drain pool.
 Passes base flow (but with storage of water)
 Higher discharge rate than "C"

PROCEDURE FOR DETERMINING OR ALTERING SEDIMENT BASIN SHAPE*

As specified in the Standard & Specification, the pool area at the elevation of crest of the principal spillway shall have a length to width ratio (L:W) of at least 1 to 1. For L:W ranging from 1:1 to 9:1 a baffle must be inserted. For L:W of 10:1 or greater, no baffle is necessary. The purpose of this requirement is to minimize the "short-circuiting" effect of the sediment laden inflow to the riser and thereby allow the effectiveness of the sediment basin to approach ideal performance. The purpose of this procedure is to prescribe the parameters, procedures and methods of determining and modifying the shape of the basin.

The length of the flow path (L) is the distance from the point of inflow to the riser (outflow point). The point of inflow is the point that the stream enters the normal pool (pool level at the riser crest elevation). The pool area (A) is the area of the normal pool. The effective width (W_e) is found by the equation:

$$W_e = \frac{A}{L}$$

$$\text{and L:W ratio} = \frac{L}{W_e}$$

In the event there is more than one inflow point, any inflow point at L:W less than 10:1 which conveys more than 30 percent of the total peak inflow rate shall be baffled.

The required basin shape may be obtained by proper site selection, by excavation or by constructing a baffle in the basin. The purpose of the baffle is to increase the effective flow length from the inflow point to the riser. Baffles shall be placed from near the inflow to mid-way between the inflow point and the riser. The baffle length shall be as required to effectively distribute inflow across the entire width of the basin. The effective length (L_e) shall be the shortest distance the water must flow from the inflow point around the end of the baffle to the outflow point.

Three examples of irregularly-shaped basins are shown on the following page. The drawings are not to scale. Baffles have been placed to increase the effective flow length. In Basin B, an alternative riser location is suggested that does not require a baffle.

* Adapted from USDA, Soil Conservation Service, College Park, Maryland. Standards and Specifications for Soil Erosion and Sediment Control in Developing Areas, 1975.

SEDIMENT BASIN BAFFLES

Example A.

(plan views, not to scale)

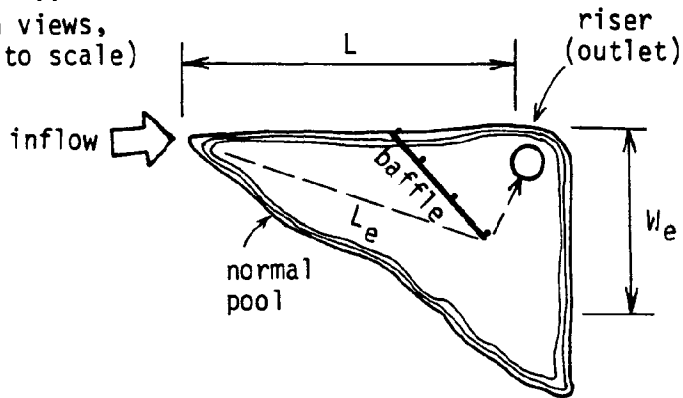

L_e = total distance from the point of inflow around the baffle to the riser

Example B.

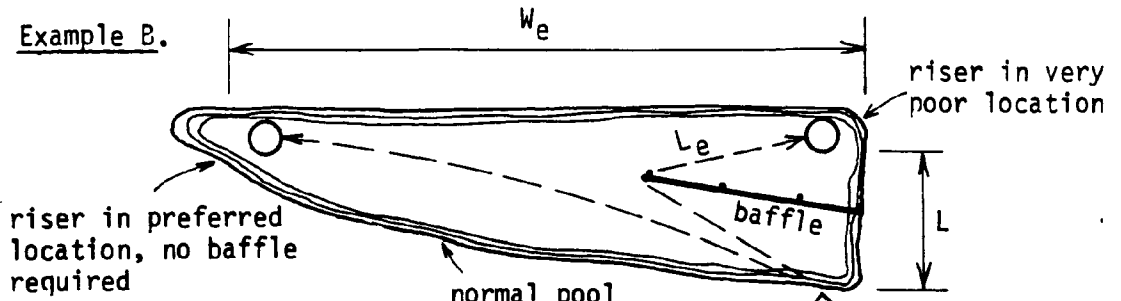

riser in preferred location, no baffle required

riser in very poor location

Example C.

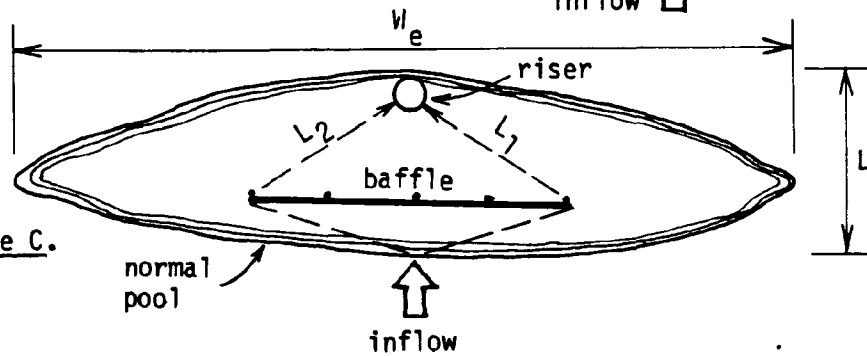

Baffle detail (elevation)

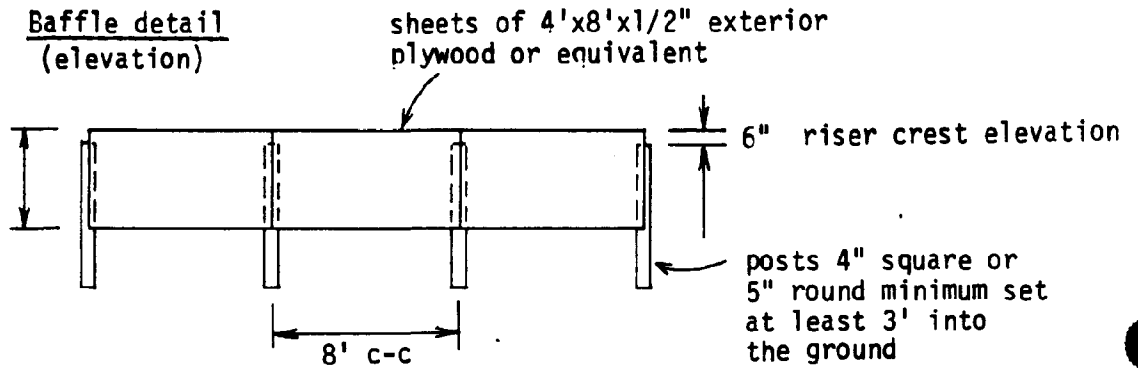

APPENDIX E *

Sample Waterway Design

The following material is provided to assist in the design of grassed waterways and diversions:

1. Graph of the Product of Velocity and Hydraulic Radius versus Mannings "n" for different degrees of vegetal retardance.
2. Table giving classification of vegetal cover based on degree of flow retardance by the vegetation.
3. Parabolic Waterway Design Tables for various grades and velocities for retardance "D", and top width and depth for retardance "C".
4. Trapezoidal Channel Design Tables for various grades, velocities and depths for retardance "C".

The use of these tables and graphs can best be shown by example problems, which are as follows:

Problem 1

Determine the non-erosive velocity and dimensions for stability and capacity for a waterway with parabolic cross-section.

| | | |
|--------|----------------------------|------------------------|
| Given: | Runoff | Q = 55 cfs |
| | Grade | = 5.1 percent |
| | Vegetative cover | Kentucky bluegrass |
| | Condition of vegetation | |
| | Good stand-mowed (3"-4") | = "D" curve retardance |
| | Good stand-headed (6"-12") | = "C" curve retardance |
| | Permissible velocity | = 4 ft./sec. |

Solution: Horizontally opposite 55 cfs on the Parabolic Waterway Design Table for Grade = 5.0 percent (slope table that is nearest 5.1%) and the columns headed V = 4.0 ft./sec., find T = 33 feet and D = 0.8 feet.

Therefore, a waterway with parabolic cross section, a top width of 33 feet, and a depth of 0.8 feet will carry 55 cfs at a maximum velocity of 4 feet per second when the vegetative lining is short (3" to 4" in height). This complies with the requirement for non-erosive velocity when vegetation is short ("D" retardance) and for capacity when vegetation is tall ("C" retardance).

Reference: USDA, Soil Conservation Service, National Engineering Handbook, Section 5, Hydraulics

*from USDA, Soil Conservation Service, College Park, Maryland. Standards and Specifications for Soil Erosion and Sediment Control in Developing Areas. July 1975.

Problem 2

Determine the non-erosive velocity and dimensions for a waterway with trapezoidal cross-section.

Given: Runoff $Q = 55$ cfs
 Grade = 2 percent
 Side slopes = 2:1
 Vegetative cover Kentucky bluegrass
 Condition of vegetation
 Good stand-headed (6"-12") = "C" curve retardance
 Permissible velocity = 5 ft./sec.

Solution: Horizontally opposite 55 cfs on the Trapezoidal Channel Design Table for Grade = 2.0 percent, read across to the column for bottom width = 6 feet and read the $D = 1.3$ feet and $V = 4.9$ ft./sec.

Therefore, a waterway with trapezoidal cross-section, 2:1 side slope, bottom width of 6 feet, and a depth of 1.3 feet will carry 55 cfs at a maximum velocity of 4.9 feet per second for "C" curve retardance.

Problem 3

Determine the safe velocity and dimensions for a waterway with trapezoidal cross-section that does not fit the Trapezoidal Channel Design Tables.

Given: Runoff $Q = 55$ cfs
 Grade = 3 percent
 Side slope = 3:1
 Vegetative cover Kentucky bluegrass
 Condition of vegetation
 Good stand-mowed (3"-4") = "D" curve retardance
 Good stand-headed (6"-12") = "C" curve retardance
 Permissible velocity = 5 ft./sec.

Solution: The solution is a trial and error process. The first step is to design for stability when the vegetation is short ("D" retardance) and the second step is to design for capacity when the vegetation is tall ("C" retardance).

Step 1 - Stability

$$Q = 55 \text{ cfs.}$$

$$V_{\max} = 5 \text{ ft./sec.}$$

$$A = \frac{Q}{V_{\max}} = \frac{55}{5} = 11 \text{ sq.ft.}$$

Try Bottom Width = 12 feet

$$A = bd + zd^2$$

$$11 = 12d + 3d^2$$

Note: Solve for d by use of the quadratic equation.

$$ax^2 + bx + c = 0$$

$$x = \frac{-b \pm \sqrt{b^2 - 4ac}}{2a}$$

$$3d^2 + 12d - 11 = 0$$

$$d = \frac{-12 \pm \sqrt{12^2 - 4(3)(-11)}}{2(3)}$$

$$d = \frac{-12 + 16.61}{6} = \frac{4.61}{6}$$

$$d = 0.77 \text{ feet}$$

Hydraulic Radius

$$r = \frac{\text{area}}{\text{wetted perimeter}} = \frac{bd + zd^2}{b + 2d\sqrt{z^2 + 1}}$$

$$r = \frac{12(0.77) + 3(0.77^2)}{12 + 2(0.77)\sqrt{3^2 + 1}}$$

$$r = \frac{9.24 + 1.78}{12 + 4.87}$$

$$r = \frac{11.02}{16.87} = 0.65$$

$$Vr = 5(0.65) = 3.25$$

From graph, page A-36.15 for Vr=3.25 and "D" retardance, read n = 0.04

$$v = \frac{1.486}{n} r^{2/3} s^{1/2}$$

$$= \frac{1.486}{0.04} (0.65^{2/3}) (.03^{1/2}) = 4.83 \text{ ft./sec.}$$

Okay, but less than V_{\max} - try slightly smaller channel.

Try bottom width = 10 feet

$$A = bd + zd^2$$

$$11 = 10d + 3d^2$$

$$d = \frac{-b \pm \sqrt{b^2 - 4ac}}{2a} = 0.87$$

$$r = \frac{bd + zd^2}{b + 2d\sqrt{z^2 + 1}} = 0.71$$

$$Vr = 3.55$$

$n = 0.040$ from page A-36.15

$$V = \frac{1.486}{n} r^{2/3} s^{1/2} = 5.15 \text{ which is greater than } V_{\max}$$

Therefore, select design bottom width = 12 feet

Velocity = 4.83 feet/sec. for "D" retardance

$$d = 0.8'$$

Step 2 - Capacity check using "C" curve retardance.
Determine additional depth needed to offset the increase retardance and decreased velocity.

Try $d = 0.9$ feet

$$A = bd + zd^2 = (12)(0.9) + 3(.9^2) = 13.23$$

$$r = \frac{A}{P} = \frac{13.23}{b + 2d\sqrt{z^2 + 1}} = \frac{13.23}{12 + 2(.9)\sqrt{3^2 + 1}} = 0.75$$

Assume $V = 4.4$ ft./sec.

$$Vr = (4.4)(0.75) = 3.30$$

From graph, page A-36.15 for $Vr \approx 3.30$ and "C" retardance, read $n = 0.046$.

$$V = \frac{1.486}{0.046} (0.75^{2/3}) (.03^{1/2}) = 4.62 \text{ ft./sec.}$$

which is greater than assumed value

Assume $V = 4.6$ ft./sec.

$$V_r = (4.6)(0.75) = 3.45$$

From graph, $n = 0.046$

$$V = \frac{1.486}{.046} (0.75^{2/3}) (.03^{1/2}) = 4.62 \text{ ft./sec.}$$

which is close enough

Therefore, dimensions and velocities are as follows:

Bottom width = 12 feet

Side slopes = 3:1

For "D" retardance - $V = 4.83$ ft./sec.

$$d = 0.8 \text{ feet}$$

For "C" retardance - $V = 4.62$ ft./sec.

$$d = 0.9 \text{ feet} + \text{freeboard.}$$

GRASSED WATERWAY AND DIVERSION

DESIGN TABLE

| <u>Retardance</u> | <u>Cover</u> | <u>Stand</u> | <u>Condition and Height</u> |
|-------------------|---|--------------|-----------------------------|
| A | Reed canarygrass | Excellent | Tall (Average 36") |
| | Kentucky 31 tall fescue | Excellent | Tall (Average 36") |
| B | Tufcote, Midland and Coastal bermudagrass | Good | Tall (Average 12") |
| | Reed canarygrass | Good | Mowed (Avg. 12 to 15") |
| | Kentucky 31 tall fescue | Good | Unmowed (Avg. 18") |
| | Red fescue | Good | Unmowed (Avg. 16") |
| | Kentucky bluegrass | Good | Unmowed (Avg. 16") |
| | Redtop | Good | Average 22" |
| C | Kentucky bluegrass | Good | Headed (6 to 12") |
| | Red fescue | Good | Headed (6 to 12") |
| | Tufcote, Midland and Coastal bermudagrass | Good | Mowed (Average 6") |
| | Redtop | Good | Headed (15 to 20") |
| D | Tufcote, Midland and Coastal bermudagrass | Good | Mowed (2 1/2") |
| | Red fescue | Good | Mowed (2 1/2") |
| | Kentucky bluegrass | Good | Mowed (2 - 5") |

Classification of vegetal cover in waterways and diversions based on degree of flow retardance.

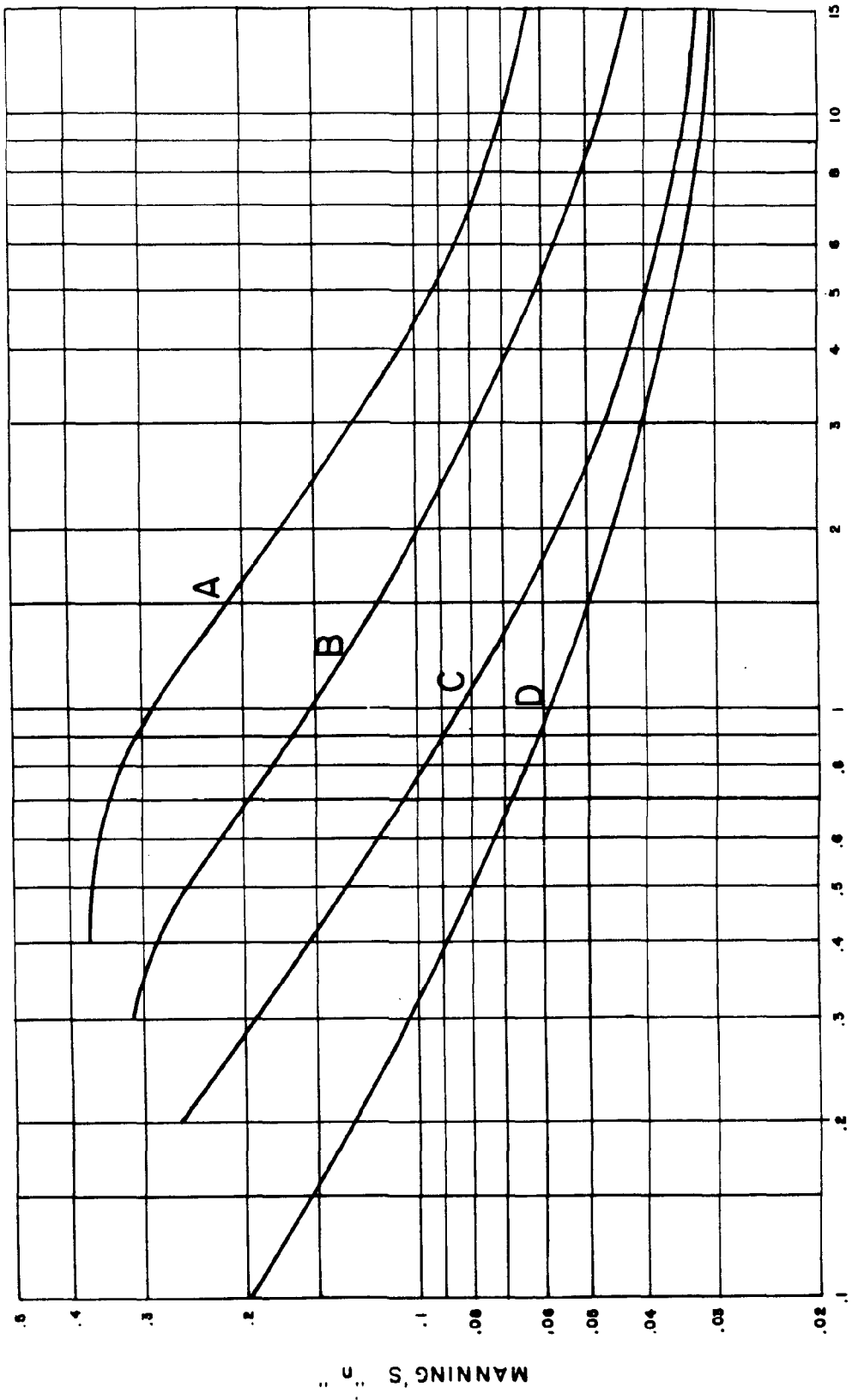

VR, PRODUCT OF VELOCITY AND HYDRAULIC RADIUS
Manning's "n" related to velocity, hydraulic radius, and vegetal retardance. (15)

V for Retardance "D",
 T and D for Retardance "C"
 Parabolic Waterway Design
 Grade 0.25 Percent(14)

Sheet 1 of 14

| Q | V = 2.0 | | V = 2.5 | | V = 3.0 | | V = 3.5 | | V = 4.0 | | V = 4.5 | | V = 5.0 | | V = 5.5 | | V = 6.0 | | |
|-----|---------|-----|---------|-----|---------|-----|---------|-----|---------|-----|---------|---|---------|---|---------|---|---------|---|--|
| cfs | T | D | T | D | T | D | T | D | T | D | T | D | T | D | T | D | T | D | |
| 15 | | | | | | | | | | | | | | | | | | | |
| 20 | | | | | | | | | | | | | | | | | | | |
| 25 | 10 | 2.4 | | | | | | | | | | | | | | | | | |
| 30 | 11 | 2.3 | | | | | | | | | | | | | | | | | |
| 35 | 13 | 2.3 | | | | | | | | | | | | | | | | | |
| 40 | 15 | 2.3 | 10 | 2.7 | | | | | | | | | | | | | | | |
| 45 | 17 | 2.2 | 12 | 2.6 | | | | | | | | | | | | | | | |
| 50 | 19 | 2.2 | 13 | 2.6 | | | | | | | | | | | | | | | |
| 55 | 20 | 2.2 | 14 | 2.6 | | | | | | | | | | | | | | | |
| 60 | 22 | 2.2 | 15 | 2.5 | | | | | | | | | | | | | | | |
| 65 | 24 | 2.2 | 17 | 2.5 | | | | | | | | | | | | | | | |
| 70 | 26 | 2.2 | 18 | 2.5 | 13 | 3.1 | | | | | | | | | | | | | |
| 75 | 28 | 2.2 | 19 | 2.5 | 13 | 3.0 | | | | | | | | | | | | | |
| 80 | 29 | 2.2 | 20 | 2.5 | 14 | 3.0 | | | | | | | | | | | | | |
| 90 | 33 | 2.2 | 23 | 2.5 | 16 | 3.0 | | | | | | | | | | | | | |
| 100 | 38 | 2.2 | 25 | 2.5 | 18 | 3.0 | | | | | | | | | | | | | |
| 110 | 40 | 2.2 | 28 | 2.5 | 19 | 2.9 | | | | | | | | | | | | | |
| 120 | 44 | 2.2 | 30 | 2.5 | 21 | 2.9 | 15 | 3.6 | | | | | | | | | | | |
| 130 | 48 | 2.2 | 33 | 2.5 | 23 | 2.9 | 16 | 3.6 | | | | | | | | | | | |
| 140 | 51 | 2.2 | 35 | 2.5 | 25 | 2.9 | 18 | 3.5 | | | | | | | | | | | |
| 150 | 55 | 2.2 | 37 | 2.5 | 26 | 2.9 | 19 | 3.5 | | | | | | | | | | | |
| 160 | 58 | 2.2 | 40 | 2.5 | 28 | 2.9 | 20 | 3.5 | | | | | | | | | | | |
| 170 | 62 | 2.2 | 42 | 2.5 | 30 | 2.9 | 21 | 3.5 | 17 | 4.0 | | | | | | | | | |
| 180 | 66 | 2.2 | 45 | 2.5 | 31 | 2.9 | 22 | 3.5 | 18 | 4.0 | | | | | | | | | |

Q = Flow in Cubic Feet per Second, V = Velocity in Feet per Second, T = Top Width in Feet
 D = Depth in Feet

V for Retardance "D",
T and D for Retardance "C"

Parabolic Waterway Design

Grade 0.50 Percent

Sheet 2 of 14

| Q cfs | V = 2.0 | | V = 2.5 | | V = 3.0 | | V = 3.5 | | V = 4.0 | | V = 4.5 | | V = 5.0 | | V = 5.5 | | V = 6.0 | |
|----------|---------|-----|---------|-----|---------|-----|---------|-----|---------|-----|---------|-----|---------|-----|---------|---|---------|---|
| | T | D | T | D | T | D | T | D | T | D | T | D | T | D | T | D | T | D |
| 15 | 9 | 1.6 | | | | | | | | | | | | | | | | |
| 20 | 11 | 1.6 | | | | | | | | | | | | | | | | |
| 25 | 14 | 1.6 | 9 | 1.9 | | | | | | | | | | | | | | |
| 30 | 17 | 1.6 | 11 | 1.9 | 8 | 2.2 | | | | | | | | | | | | |
| 35 | 20 | 1.6 | 12 | 1.9 | 9 | 2.1 | | | | | | | | | | | | |
| 40 | 22 | 1.6 | 14 | 1.8 | 11 | 2.1 | | | | | | | | | | | | |
| 45 | 25 | 1.5 | 16 | 1.8 | 12 | 2.0 | | | | | | | | | | | | |
| 50 | 28 | 1.5 | 18 | 1.8 | 13 | 2.0 | 10 | 2.4 | | | | | | | | | | |
| 55 | 31 | 1.5 | 19 | 1.8 | 15 | 2.0 | 11 | 2.4 | | | | | | | | | | |
| 60 | 33 | 1.5 | 21 | 1.8 | 16 | 2.0 | 11 | 2.4 | | | | | | | | | | |
| 65 | 36 | 1.5 | 23 | 1.8 | 17 | 2.0 | 12 | 2.4 | | | | | | | | | | |
| 70 | 39 | 1.5 | 24 | 1.8 | 18 | 2.0 | 13 | 2.3 | | | | | | | | | | |
| 75 | 42 | 1.5 | 26 | 1.8 | 20 | 2.0 | 14 | 2.3 | 11 | 2.7 | | | | | | | | |
| 80 | 44 | 1.5 | 28 | 1.8 | 21 | 2.0 | 15 | 2.3 | 12 | 2.7 | | | | | | | | |
| 90 | 50 | 1.5 | 31 | 1.8 | 24 | 2.0 | 17 | 2.3 | 13 | 2.7 | | | | | | | | |
| 100 | 55 | 1.5 | 35 | 1.8 | 26 | 2.0 | 19 | 2.3 | 15 | 2.6 | 12 | 3.0 | | | | | | |
| 110 | 61 | 1.5 | 38 | 1.8 | 29 | 2.0 | 21 | 2.3 | 16 | 2.6 | 13 | 3.0 | | | | | | |
| 120 | 66 | 1.5 | 42 | 1.8 | 31 | 2.0 | 22 | 2.3 | 18 | 2.6 | 14 | 2.9 | | | | | | |
| 130 | 72 | 1.5 | 45 | 1.8 | 34 | 2.0 | 24 | 2.3 | 19 | 2.6 | 15 | 2.9 | | | | | | |
| 140 | 77 | 1.5 | 48 | 1.8 | 36 | 2.0 | 26 | 2.3 | 20 | 2.6 | 16 | 2.9 | | | | | | |
| 150 | 83 | 1.5 | 52 | 1.8 | 39 | 2.0 | 28 | 2.3 | 22 | 2.6 | 18 | 2.9 | 14 | 3.3 | | | | |
| 160 | 88 | 1.5 | 55 | 1.8 | 41 | 2.0 | 30 | 2.3 | 23 | 2.6 | 19 | 2.9 | 15 | 3.3 | | | | |
| 170 | 93 | 1.5 | 59 | 1.8 | 44 | 2.0 | 32 | 2.3 | 25 | 2.6 | 20 | 2.9 | 16 | 3.3 | | | | |
| 180 | 99 | 1.5 | 62 | 1.8 | 47 | 2.0 | 33 | 2.3 | 26 | 2.6 | 21 | 2.9 | 17 | 3.3 | | | | |

Q = Flow in Cubic Feet per Second, V = Velocity in Feet per Second, T = Top Width in Feet
D = Depth in Feet

V for Retardance "D",
T and D for Retardance "C"

Parabolic Waterway Design

Grade 0.75 Percent

Sheet 3 of 14

| Q cfs | V = 2.0 | | V = 2.5 | | V = 3.0 | | V = 3.5 | | V = 4.0 | | V = 4.5 | | V = 5.0 | | V = 5.5 | | V = 6.0 | |
|----------|---------|-----|---------|-----|---------|-----|---------|-----|---------|-----|---------|-----|---------|-----|---------|-----|---------|-----|
| | T | D | T | D | T | D | T | D | T | D | T | D | T | D | T | D | T | D |
| 15 | 12 | 1.3 | 7 | 1.6 | | | | | | | | | | | | | | |
| 20 | 16 | 1.3 | 9 | 1.5 | | | | | | | | | | | | | | |
| 25 | 19 | 1.3 | 11 | 1.5 | 8 | 1.7 | | | | | | | | | | | | |
| 30 | 23 | 1.3 | 13 | 1.5 | 10 | 1.7 | 8 | 1.9 | | | | | | | | | | |
| 35 | 27 | 1.3 | 15 | 1.5 | 11 | 1.7 | 9 | 1.9 | | | | | | | | | | |
| 40 | 31 | 1.3 | 18 | 1.5 | 13 | 1.7 | 10 | 1.9 | | | | | | | | | | |
| 45 | 35 | 1.3 | 20 | 1.5 | 14 | 1.7 | 11 | 1.8 | | | | | | | | | | |
| 50 | 38 | 1.3 | 22 | 1.5 | 16 | 1.6 | 13 | 1.8 | 9 | 2.2 | | | | | | | | |
| 55 | 42 | 1.3 | 24 | 1.5 | 18 | 1.6 | 14 | 1.8 | 10 | 2.1 | | | | | | | | |
| 60 | 46 | 1.3 | 26 | 1.5 | 19 | 1.6 | 15 | 1.8 | 11 | 2.1 | | | | | | | | |
| 65 | 50 | 1.3 | 28 | 1.5 | 21 | 1.6 | 16 | 1.8 | 12 | 2.1 | 10 | 2.4 | | | | | | |
| 70 | 53 | 1.3 | 30 | 1.5 | 22 | 1.6 | 17 | 1.8 | 13 | 2.1 | 11 | 2.4 | | | | | | |
| 75 | 57 | 1.3 | 33 | 1.5 | 24 | 1.6 | 19 | 1.8 | 14 | 2.1 | 11. | 2.3 | | | | | | |
| 80 | 61 | 1.3 | 35 | 1.5 | 25 | 1.6 | 20 | 1.8 | 15 | 2.1 | 12 | 2.3 | | | | | | |
| 90 | 68 | 1.3 | 39 | 1.5 | 28 | 1.6 | 22 | 1.8 | 16 | 2.1 | 13 | 2.3 | 11 | 2.6 | | | | |
| 100 | 76 | 1.3 | 43 | 1.5 | 32 | 1.6 | 25 | 1.8 | 18 | 2.1 | 15 | 2.3 | 12 | 2.6 | | | | |
| 110 | 83 | 1.3 | 48 | 1.5 | 35 | 1.6 | 27 | 1.8 | 20 | 2.0 | 16 | 2.3 | 13 | 2.6 | | | | |
| 120 | 91 | 1.3 | 52 | 1.5 | 38 | 1.6 | 30 | 1.8 | 22 | 2.1 | 18 | 2.3 | 15 | 2.5 | 12 | 2.9 | | |
| 130 | 98 | 1.3 | 56 | 1.5 | 41 | 1.6 | 32 | 1.8 | 23 | 2.1 | 19 | 2.2 | 16 | 2.5 | 13 | 2.8 | | |
| 140 | 106 | 1.3 | 60 | 1.5 | 44 | 1.6 | 34 | 1.8 | 25 | 2.0 | 21 | 2.3 | 17 | 2.5 | 14 | 2.8 | | |
| 150 | 113 | 1.3 | 65 | 1.5 | 47 | 1.6 | 37 | 1.8 | 27 | 2.0 | 22 | 2.2 | 18 | 2.5 | 15 | 2.8 | | |
| 160 | 121 | 1.3 | 69 | 1.5 | 50 | 1.6 | 39 | 1.8 | 29 | 2.0 | 24 | 2.2 | 19 | 2.5 | 16 | 2.8 | 13 | 3.1 |
| 170 | 128 | 1.3 | 73 | 1.5 | 53 | 1.6 | 42 | 1.8 | 30 | 2.0 | 25 | 2.2 | 20 | 2.5 | 17 | 2.8 | 14 | 3.1 |
| 180 | 135 | 1.3 | 77 | 1.5 | 56 | 1.6 | 44 | 1.8 | 32 | 2.0 | 27 | 2.2 | 22 | 2.5 | 18 | 2.8 | 15 | 3.1 |

Q = Flow in Cubic Feet per Second, V = Velocity in Feet per Second, T = Top Width in Feet
D = Depth in Feet

Sheet 4 of 14

Parabolic Waterway Design
Grade 1.0 Percent

V for Retardance "D",
T and D for Retardance "C"

| Q cfs | V = 2.0 | | V = 2.5 | | V = 3.0 | | V = 3.5 | | V = 4.0 | | V = 4.5 | | V = 5.0 | | V = 5.5 | | V = 6.0 | | |
|----------|---------|-----|---------|-----|---------|-----|---------|-----|---------|-----|---------|-----|---------|-----|---------|-----|---------|-----|--|
| | T | D | T | D | T | D | T | D | T | D | T | D | T | D | T | D | T | D | |
| 15 | 13 | 1.1 | 8 | 1.3 | | | | | | | | | | | | | | | |
| 20 | 18 | 1.1 | 11 | 1.3 | 8 | 1.5 | | | | | | | | | | | | | |
| 25 | 22 | 1.1 | 14 | 1.3 | 9 | 1.5 | 8 | 1.6 | | | | | | | | | | | |
| 30 | 27 | 1.1 | 17 | 1.3 | 11 | 1.5 | 9 | 1.6 | | | | | | | | | | | |
| 35 | 31 | 1.1 | 19 | 1.3 | 13 | 1.5 | 11 | 1.6 | 8 | 1.8 | | | | | | | | | |
| 40 | 35 | 1.1 | 22 | 1.3 | 15 | 1.4 | 12 | 1.6 | 9 | 1.8 | | | | | | | | | |
| 45 | 40 | 1.1 | 25 | 1.3 | 17 | 1.5 | 13 | 1.6 | 10 | 1.8 | | | | | | | | | |
| 50 | 44 | 1.1 | 28 | 1.3 | 19 | 1.4 | 15 | 1.6 | 11 | 1.8 | 9 | 2.0 | | | | | | | |
| 55 | 48 | 1.1 | 30 | 1.3 | 20 | 1.4 | 16 | 1.5 | 12 | 1.8 | 10 | 2.0 | | | | | | | |
| 60 | 53 | 1.1 | 33 | 1.3 | 22 | 1.4 | 18 | 1.5 | 14 | 1.7 | 10 | 2.0 | | | | | | | |
| 65 | 57 | 1.1 | 36 | 1.3 | 24 | 1.4 | 19 | 1.5 | 15 | 1.7 | 11 | 2.0 | 9 | 2.2 | | | | | |
| 70 | 61 | 1.1 | 38 | 1.3 | 26 | 1.4 | 21 | 1.5 | 16 | 1.7 | 12 | 2.0 | 10 | 2.2 | | | | | |
| 75 | 66 | 1.1 | 41 | 1.3 | 28 | 1.4 | 22 | 1.5 | 17 | 1.7 | 13 | 2.0 | 11 | 2.2 | | | | | |
| 80 | 70 | 1.1 | 44 | 1.3 | 29 | 1.4 | 24 | 1.5 | 18 | 1.7 | 14 | 2.0 | 11 | 2.2 | | | | | |
| 90 | 79 | 1.1 | 49 | 1.3 | 33 | 1.4 | 27 | 1.5 | 20 | 1.7 | 15 | 1.9 | 13 | 2.2 | 11 | 2.4 | | | |
| 100 | 87 | 1.1 | 55 | 1.3 | 37 | 1.4 | 29 | 1.5 | 22 | 1.7 | 17 | 1.9 | 14 | 2.2 | 12 | 2.4 | | | |
| 110 | 96 | 1.1 | 60 | 1.3 | 40 | 1.4 | 32 | 1.5 | 24 | 1.7 | 19 | 1.9 | 15 | 2.1 | 13 | 2.4 | 11 | 2.6 | |
| 120 | 104 | 1.1 | 65 | 1.3 | 44 | 1.4 | 35 | 1.5 | 27 | 1.7 | 20 | 1.9 | 17 | 2.1 | 14 | 2.4 | 12 | 2.6 | |
| 130 | 113 | 1.1 | 71 | 1.3 | 47 | 1.4 | 38 | 1.5 | 29 | 1.7 | 22 | 1.9 | 18 | 2.1 | 15 | 2.4 | 13 | 2.6 | |
| 140 | 121 | 1.1 | 76 | 1.3 | 51 | 1.4 | 41 | 1.5 | 31 | 1.7 | 24 | 1.9 | 20 | 2.1 | 16 | 2.3 | 14 | 2.6 | |
| 150 | 130 | 1.1 | 81 | 1.3 | 55 | 1.4 | 44 | 1.5 | 33 | 1.7 | 25 | 1.9 | 21 | 2.1 | 17 | 2.4 | 15 | 2.6 | |
| 160 | 138 | 1.1 | 87 | 1.3 | 58 | 1.4 | 47 | 1.5 | 35 | 1.7 | 27 | 1.9 | 22 | 2.1 | 19 | 2.3 | 16 | 2.5 | |
| 170 | 147 | 1.1 | 92 | 1.3 | 62 | 1.4 | 50 | 1.5 | 38 | 1.7 | 29 | 1.9 | 24 | 2.1 | 20 | 2.3 | 17 | 2.5 | |
| 180 | 155 | 1.1 | 97 | 1.3 | 65 | 1.4 | 53 | 1.5 | 40 | 1.7 | 30 | 1.9 | 25 | 2.1 | 21 | 2.3 | 18 | 2.5 | |

Q = Flow in Cubic Feet per Second, V = Velocity in Feet per Second, T = Top Width in Feet
D = Depth in Feet

V for Retardance "D",
T and D for Retardance "C"

Parabolic Waterway Design

Grade 1.25 Percent

Sheet 5 of 14

| Q cfs | V = 2.0 | | V = 2.5 | | V = 3.0 | | V = 3.5 | | V = 4.0 | | V = 4.5 | | V = 5.0 | | V = 5.5 | | V = 6.0 | |
|----------|---------|-----|---------|-----|---------|-----|---------|-----|---------|-----|---------|-----|---------|-----|---------|-----|---------|-----|
| | T | D | T | D | T | D | T | D | T | D | T | D | T | D | T | D | T | D |
| 15 | 15 | 1.0 | 10 | 1.2 | 7 | 1.4 | | | | | | | | | | | | |
| 20 | 20 | 1.0 | 13 | 1.1 | 9 | 1.3 | 7 | 1.5 | | | | | | | | | | |
| 25 | 25 | 1.0 | 16 | 1.1 | 11 | 1.3 | 8 | 1.5 | 7 | 1.6 | | | | | | | | |
| 30 | 31 | 1.0 | 19 | 1.1 | 13 | 1.3 | 10 | 1.4 | 8 | 1.6 | | | | | | | | |
| 35 | 36 | 1.0 | 23 | 1.1 | 15 | 1.3 | 11 | 1.4 | 9 | 1.6 | 7 | 1.8 | | | | | | |
| 40 | 41 | 1.0 | 26 | 1.1 | 17 | 1.3 | 13 | 1.4 | 11 | 1.6 | 8 | 1.8 | | | | | | |
| 45 | 46 | 1.0 | 29 | 1.1 | 19 | 1.3 | 14 | 1.4 | 12 | 1.5 | 9 | 1.7 | | | | | | |
| 50 | 50 | 1.0 | 32 | 1.1 | 21 | 1.3 | 16 | 1.4 | 13 | 1.5 | 10 | 1.7 | 8 | 2.0 | | | | |
| 55 | 55 | 1.0 | 35 | 1.1 | 23 | 1.3 | 18 | 1.4 | 14 | 1.5 | 11 | 1.7 | 9 | 1.9 | | | | |
| 60 | 60 | 1.0 | 38 | 1.1 | 26 | 1.3 | 19 | 1.4 | 16 | 1.5 | 12 | 1.7 | 10 | 1.9 | | | | |
| 65 | 65 | 1.0 | 41 | 1.1 | 28 | 1.3 | 21 | 1.4 | 17 | 1.5 | 13 | 1.7 | 11 | 1.9 | 9 | 2.2 | | |
| 70 | 70 | 1.0 | 45 | 1.1 | 30 | 1.3 | 22 | 1.4 | 18 | 1.5 | 14 | 1.7 | 11 | 1.9 | 9 | 2.2 | | |
| 75 | 75 | 1.0 | 48 | 1.1 | 32 | 1.3 | 24 | 1.4 | 19 | 1.5 | 15 | 1.7 | 12 | 1.9 | 10 | 2.1 | | |
| 80 | 80 | 1.0 | 51 | 1.1 | 34 | 1.3 | 25 | 1.4 | 21 | 1.5 | 16 | 1.7 | 13 | 1.9 | 11 | 2.1 | 9 | 2.3 |
| 90 | 90 | 1.0 | 57 | 1.1 | 38 | 1.3 | 29 | 1.4 | 23 | 1.5 | 18 | 1.7 | 15 | 1.9 | 12 | 2.1 | 10 | 2.3 |
| 100 | 100 | 1.0 | 63 | 1.1 | 42 | 1.3 | 32 | 1.4 | 26 | 1.5 | 20 | 1.7 | 16 | 1.9 | 13 | 2.1 | 11 | 2.3 |
| 110 | 109 | 1.0 | 70 | 1.1 | 46 | 1.3 | 35 | 1.4 | 28 | 1.5 | 22 | 1.7 | 18 | 1.9 | 14 | 2.1 | 12 | 2.2 |
| 120 | 119 | 1.0 | 76 | 1.1 | 51 | 1.3 | 38 | 1.4 | 31 | 1.5 | 24 | 1.7 | 19 | 1.8 | 16 | 2.1 | 14 | 2.2 |
| 130 | 129 | 1.0 | 82 | 1.1 | 55 | 1.3 | 41 | 1.4 | 33 | 1.5 | 26 | 1.7 | 21 | 1.8 | 17 | 2.1 | 15 | 2.2 |
| 140 | 139 | 1.0 | 88 | 1.1 | 59 | 1.3 | 44 | 1.4 | 36 | 1.5 | 28 | 1.7 | 23 | 1.8 | 18 | 2.1 | 16 | 2.2 |
| 150 | 148 | 1.0 | 94 | 1.1 | 63 | 1.3 | 47 | 1.4 | 38 | 1.5 | 30 | 1.7 | 24 | 1.8 | 19 | 2.0 | 17 | 2.2 |
| 160 | 158 | 1.0 | 101 | 1.1 | 67 | 1.3 | 50 | 1.4 | 41 | 1.5 | 32 | 1.7 | 26 | 1.8 | 21 | 2.1 | 18 | 2.2 |
| 170 | 168 | 1.0 | 107 | 1.1 | 71 | 1.3 | 54 | 1.4 | 43 | 1.5 | 34 | 1.7 | 27 | 1.8 | 22 | 2.1 | 19 | 2.2 |
| 180 | 177 | 1.0 | 113 | 1.1 | 75 | 1.3 | 57 | 1.4 | 46 | 1.5 | 36 | 1.7 | 29 | 1.8 | 23 | 2.1 | 20 | 2.2 |

E-12

Q = Flow in Cubic Feet per Second, V = Velocity in Feet per Second, T = Top Width in Feet
D = Depth in Feet

V for Retardance "D",
T and D for Retardance "C"

Parabolic Waterway Design

Grade 1.50 Percent

Sheet 6 of 14

| Q cfs | V = 2.0 | | V = 2.5 | | V = 3.0 | | V = 3.5 | | V = 4.0 | | V = 4.5 | | V = 5.0 | | V = 5.5 | | V = 6.0 | |
|----------|---------|-----|---------|-----|---------|-----|---------|-----|---------|-----|---------|-----|---------|-----|---------|-----|---------|-----|
| | T | D | T | D | T | D | T | D | T | D | T | D | T | D | T | D | T | D |
| 15 | 17 | 0.9 | 11 | 1.1 | 8 | 1.2 | | | | | | | | | | | | |
| 20 | 23 | 0.9 | 15 | 1.0 | 10 | 1.2 | 7 | 1.4 | 6 | 1.5 | | | | | | | | |
| 25 | 28 | 0.9 | 19 | 1.0 | 12 | 1.2 | 9 | 1.4 | 7 | 1.5 | | | | | | | | |
| 30 | 34 | 0.9 | 22 | 1.0 | 15 | 1.2 | 10 | 1.3 | 8 | 1.5 | 7 | 1.6 | | | | | | |
| 35 | 40 | 0.9 | 26 | 1.0 | 17 | 1.1 | 12 | 1.3 | 10 | 1.4 | 8 | 1.6 | | | | | | |
| 40 | 45 | 0.9 | 30 | 1.0 | 20 | 1.2 | 14 | 1.3 | 11 | 1.4 | 9 | 1.6 | 7 | 1.8 | | | | |
| 45 | 51 | 0.9 | 33 | 1.0 | 22 | 1.1 | 15 | 1.3 | 12 | 1.4 | 10 | 1.5 | 8 | 1.8 | | | | |
| 50 | 56 | 0.9 | 37 | 1.0 | 25 | 1.1 | 17 | 1.3 | 14 | 1.4 | 11 | 1.5 | 9 | 1.8 | | | | |
| 55 | 62 | 0.9 | 41 | 1.0 | 27 | 1.1 | 19 | 1.3 | 15 | 1.4 | 12 | 1.5 | 10 | 1.7 | 8 | 1.9 | | |
| 60 | 67 | 0.9 | 44 | 1.0 | 30 | 1.1 | 20 | 1.3 | 16 | 1.4 | 14 | 1.5 | 11 | 1.7 | 9 | 1.9 | | |
| 65 | 73 | 0.9 | 48 | 1.0 | 32 | 1.1 | 22 | 1.3 | 18 | 1.4 | 15 | 1.5 | 11 | 1.7 | 10 | 1.9 | | |
| 70 | 78 | 0.9 | 51 | 1.0 | 34 | 1.1 | 24 | 1.3 | 19 | 1.4 | 16 | 1.5 | 12 | 1.7 | 10 | 1.9 | 9 | 2.1 |
| 75 | 83 | 0.9 | 55 | 1.0 | 37 | 1.1 | 25 | 1.3 | 21 | 1.4 | 17 | 1.5 | 13 | 1.7 | 11 | 1.9 | 9 | 2.1 |
| 80 | 89 | 0.9 | 59 | 1.0 | 39 | 1.1 | 27 | 1.3 | 22 | 1.4 | 18 | 1.5 | 14 | 1.7 | 12 | 1.9 | 10 | 2.1 |
| 90 | 100 | 0.9 | 66 | 1.0 | 44 | 1.1 | 30 | 1.3 | 25 | 1.4 | 20 | 1.5 | 16 | 1.7 | 13 | 1.9 | 11 | 2.0 |
| 100 | 111 | 0.9 | 73 | 1.0 | 49 | 1.1 | 33 | 1.3 | 27 | 1.4 | 22 | 1.5 | 17 | 1.7 | 15 | 1.9 | 12 | 2.0 |
| 110 | 121 | 0.9 | 80 | 1.0 | 54 | 1.1 | 37 | 1.3 | 30 | 1.4 | 25 | 1.5 | 19 | 1.7 | 16 | 1.8 | 14 | 2.0 |
| 120 | 132 | 0.9 | 87 | 1.0 | 58 | 1.1 | 40 | 1.3 | 33 | 1.4 | 27 | 1.5 | 21 | 1.7 | 18 | 1.9 | 15 | 2.0 |
| 130 | 143 | 0.9 | 95 | 1.0 | 63 | 1.1 | 43 | 1.3 | 35 | 1.4 | 29 | 1.5 | 22 | 1.7 | 19 | 1.8 | 16 | 2.0 |
| 140 | 154 | 0.9 | 102 | 1.0 | 68 | 1.1 | 47 | 1.3 | 38 | 1.4 | 31 | 1.5 | 24 | 1.7 | 20 | 1.8 | 17 | 2.0 |
| 150 | 164 | 0.9 | 109 | 1.0 | 73 | 1.1 | 50 | 1.3 | 41 | 1.4 | 33 | 1.5 | 26 | 1.7 | 22 | 1.8 | 18 | 2.0 |
| 160 | 175 | 0.9 | 116 | 1.0 | 78 | 1.1 | 53 | 1.3 | 43 | 1.4 | 36 | 1.5 | 27 | 1.7 | 23 | 1.8 | 20 | 2.0 |
| 170 | 186 | 0.9 | 123 | 1.0 | 82 | 1.1 | 57 | 1.3 | 46 | 1.4 | 38 | 1.5 | 29 | 1.7 | 25 | 1.8 | 21 | 2.0 |
| 180 | 196 | 0.9 | 130 | 1.0 | 87 | 1.1 | 60 | 1.3 | 49 | 1.4 | 40 | 1.5 | 31 | 1.7 | 26 | 1.8 | 22 | 2.0 |

F-13

Q = Flow in Cubic Feet per Second, V = Velocity in Feet per Second, T = Top Width in Feet
D = Depth in Feet

V for Retardance "D",
T and D for Retardance "C"

Parabolic Waterway Design

Sheet 7 of 14

Grade 1.75 Percent

| Q cfs | V = 2.0 | | V = 2.5 | | V = 3.0 | | V = 4.5 | | V = 4.0 | | V = 4.5 | | V = 5.0 | | V = 5.5 | | V = 6.0 | |
|----------|---------|-----|---------|-----|---------|-----|---------|-----|---------|-----|---------|-----|---------|-----|---------|-----|---------|-----|
| | T | D | T | D | T | D | T | D | T | D | T | D | T | D | T | D | T | D |
| 15 | 19 | 0.9 | 12 | 1.0 | 9 | 1.1 | 6 | 1.3 | | | | | | | | | | |
| 20 | 25 | 0.9 | 16 | 1.0 | 11 | 1.1 | 8 | 1.3 | 7 | 1.3 | | | | | | | | |
| 25 | 31 | 0.9 | 20 | 1.0 | 14 | 1.1 | 10 | 1.2 | 8 | 1.3 | 7 | 1.5 | | | | | | |
| 30 | 37 | 0.9 | 24 | 1.0 | 17 | 1.1 | 12 | 1.2 | 10 | 1.3 | 8 | 1.4 | | | | | | |
| 35 | 43 | 0.9 | 28 | 1.0 | 20 | 1.1 | 13 | 1.2 | 11 | 1.3 | 9 | 1.4 | 7 | 1.6 | | | | |
| 40 | 49 | 0.9 | 32 | 1.0 | 22 | 1.1 | 15 | 1.2 | 13 | 1.3 | 10 | 1.4 | 8 | 1.6 | | | | |
| 45 | 55 | 0.9 | 36 | 1.0 | 25 | 1.1 | 17 | 1.2 | 14 | 1.3 | 12 | 1.4 | 9 | 1.6 | 8 | 1.7 | | |
| 50 | 61 | 0.9 | 40 | 1.0 | 28 | 1.1 | 19 | 1.2 | 16 | 1.3 | 13 | 1.4 | 10 | 1.5 | 8 | 1.7 | | |
| 55 | 67 | 0.9 | 44 | 1.0 | 31 | 1.1 | 21 | 1.2 | 17 | 1.3 | 14 | 1.4 | 11 | 1.5 | 9 | 1.7 | 8 | 1.9 |
| 60 | 73 | 0.9 | 48 | 1.0 | 33 | 1.1 | 23 | 1.2 | 19 | 1.3 | 15 | 1.4 | 12 | 1.5 | 10 | 1.7 | 8 | 1.9 |
| 65 | 78 | 0.9 | 52 | 1.0 | 36 | 1.1 | 25 | 1.2 | 21 | 1.3 | 17 | 1.4 | 13 | 1.5 | 11 | 1.7 | 9 | 1.9 |
| 70 | 84 | 0.9 | 56 | 1.0 | 39 | 1.1 | 27 | 1.2 | 22 | 1.3 | 18 | 1.4 | 14 | 1.5 | 12 | 1.7 | 10 | 1.9 |
| 75 | 90 | 0.9 | 59 | 1.0 | 42 | 1.1 | 29 | 1.2 | 24 | 1.3 | 19 | 1.4 | 15 | 1.5 | 12 | 1.7 | 10 | 1.9 |
| 80 | 96 | 0.9 | 63 | 1.0 | 44 | 1.1 | 30 | 1.2 | 25 | 1.3 | 20 | 1.4 | 16 | 1.5 | 13 | 1.7 | 11 | 1.9 |
| 90 | 108 | 0.9 | 71 | 1.0 | 50 | 1.1 | 34 | 1.2 | 28 | 1.3 | 23 | 1.4 | 18 | 1.5 | 15 | 1.7 | 12 | 1.9 |
| 100 | 120 | 0.9 | 79 | 1.0 | 55 | 1.1 | 38 | 1.2 | 31 | 1.3 | 25 | 1.4 | 20 | 1.5 | 16 | 1.7 | 13 | 1.9 |
| 110 | 131 | 0.9 | 87 | 1.0 | 61 | 1.1 | 42 | 1.2 | 34 | 1.3 | 28 | 1.4 | 22 | 1.5 | 18 | 1.7 | 15 | 1.8 |
| 120 | 143 | 0.9 | 94 | 1.0 | 66 | 1.1 | 45 | 1.2 | 38 | 1.3 | 30 | 1.4 | 24 | 1.5 | 20 | 1.7 | 16 | 1.8 |
| 130 | 155 | 0.9 | 102 | 1.0 | 71 | 1.1 | 49 | 1.2 | 41 | 1.3 | 33 | 1.4 | 26 | 1.5 | 21 | 1.7 | 17 | 1.8 |
| 140 | 166 | 0.9 | 110 | 1.0 | 77 | 1.1 | 53 | 1.2 | 44 | 1.3 | 35 | 1.4 | 28 | 1.5 | 23 | 1.6 | 19 | 1.8 |
| 150 | 178 | 0.9 | 117 | 1.0 | 82 | 1.1 | 56 | 1.2 | 47 | 1.3 | 38 | 1.4 | 30 | 1.5 | 24 | 1.6 | 20 | 1.8 |
| 160 | 189 | 0.9 | 125 | 1.0 | 88 | 1.1 | 60 | 1.2 | 50 | 1.3 | 40 | 1.4 | 31 | 1.5 | 26 | 1.6 | 21 | 1.8 |
| 170 | 201 | 0.9 | 132 | 1.0 | 93 | 1.1 | 64 | 1.2 | 53 | 1.3 | 43 | 1.4 | 33 | 1.5 | 28 | 1.6 | 23 | 1.8 |
| 180 | 212 | 0.9 | 140 | 1.0 | 98 | 1.1 | 67 | 1.2 | 56 | 1.3 | 45 | 1.4 | 35 | 1.5 | 29 | 1.6 | 24 | 1.8 |

Q = Flow in Cubic Feet per Second, V = Velocity in Feet per Second, T = Top Width in Feet
D = Depth in Feet

Parabolic Waterway Design
 Sheet 8 of 14

Grade 2.0 Percent

V for Retardance "D",
 T and D for Retardance "C"

| Q cfs | V = 2.0 | | V = 2.5 | | V = 3.0 | | V = 3.5 | | V = 4.0 | | V = 4.5 | | V = 5.0 | | V = 5.5 | | V = 6.0 | |
|----------|---------|-----|---------|-----|---------|-----|---------|-----|---------|-----|---------|-----|---------|-----|---------|-----|---------|-----|
| | T | D | T | D | T | D | T | D | T | D | T | D | T | D | T | D | T | D |
| 15 | 21 | 0.8 | 13 | 0.9 | 9 | 1.0 | 7 | 1.2 | | | | | | | | | | |
| 20 | 28 | 0.8 | 17 | 0.9 | 12 | 1.0 | 9 | 1.1 | 7 | 1.3 | 5 | 1.4 | | | | | | |
| 25 | 35 | 0.8 | 21 | 0.9 | 15 | 1.0 | 11 | 1.1 | 8 | 1.3 | 7 | 1.4 | | | | | | |
| 30 | 41 | 0.8 | 26 | 0.9 | 18 | 1.0 | 13 | 1.1 | 10 | 1.2 | 8 | 1.3 | 7 | 1.5 | | | | |
| 35 | 48 | 0.8 | 30 | 0.9 | 22 | 1.0 | 15 | 1.1 | 11 | 1.2 | 9 | 1.3 | 8 | 1.5 | | | | |
| 40 | 55 | 0.8 | 34 | 0.9 | 25 | 1.0 | 18 | 1.1 | 13 | 1.2 | 11 | 1.3 | 9 | 1.5 | 7 | 1.7 | | |
| 45 | 62 | 0.8 | 38 | 0.9 | 28 | 1.0 | 20 | 1.1 | 14 | 1.2 | 12 | 1.3 | 10 | 1.4 | 8 | 1.6 | | |
| 50 | 68 | 0.8 | 42 | 0.9 | 31 | 1.0 | 22 | 1.1 | 16 | 1.2 | 13 | 1.3 | 11 | 1.4 | 9 | 1.6 | 8 | 1.7 |
| 55 | 75 | 0.8 | 46 | 0.9 | 34 | 1.0 | 24 | 1.1 | 17 | 1.2 | 14 | 1.3 | 12 | 1.4 | 10 | 1.6 | 8 | 1.7 |
| 60 | 82 | 0.8 | 51 | 0.9 | 37 | 1.0 | 26 | 1.1 | 19 | 1.2 | 16 | 1.3 | 13 | 1.4 | 11 | 1.6 | 9 | 1.7 |
| 65 | 88 | 0.8 | 55 | 0.9 | 40 | 1.0 | 28 | 1.1 | 21 | 1.2 | 17 | 1.3 | 14 | 1.4 | 11 | 1.6 | 10 | 1.7 |
| 70 | 95 | 0.8 | 59 | 0.9 | 43 | 1.0 | 30 | 1.1 | 22 | 1.2 | 18 | 1.3 | 15 | 1.4 | 12 | 1.6 | 10 | 1.7 |
| 75 | 101 | 0.8 | 63 | 0.9 | 46 | 1.0 | 32 | 1.1 | 24 | 1.2 | 20 | 1.3 | 16 | 1.4 | 13 | 1.6 | 11 | 1.7 |
| 80 | 108 | 0.8 | 67 | 0.9 | 48 | 1.0 | 35 | 1.1 | 25 | 1.2 | 21 | 1.3 | 17 | 1.4 | 14 | 1.6 | 12 | 1.7 |
| 90 | 121 | 0.8 | 75 | 0.9 | 54 | 1.0 | 39 | 1.1 | 28 | 1.2 | 23 | 1.3 | 19 | 1.4 | 16 | 1.6 | 13 | 1.7 |
| 100 | 134 | 0.8 | 83 | 0.9 | 60 | 1.0 | 43 | 1.1 | 31 | 1.2 | 26 | 1.3 | 21 | 1.4 | 17 | 1.6 | 15 | 1.7 |
| 110 | 147 | 0.8 | 92 | 0.9 | 66 | 1.0 | 47 | 1.1 | 34 | 1.2 | 28 | 1.3 | 23 | 1.4 | 19 | 1.5 | 16 | 1.7 |
| 120 | 160 | 0.8 | 100 | 0.9 | 72 | 1.0 | 52 | 1.1 | 38 | 1.2 | 31 | 1.3 | 26 | 1.4 | 21 | 1.5 | 18 | 1.7 |
| 130 | 173 | 0.8 | 108 | 0.9 | 78 | 1.0 | 56 | 1.1 | 41 | 1.2 | 34 | 1.3 | 28 | 1.4 | 23 | 1.5 | 19 | 1.7 |
| 140 | 186 | 0.8 | 116 | 0.9 | 84 | 1.0 | 60 | 1.1 | 44 | 1.2 | 36 | 1.3 | 30 | 1.4 | 24 | 1.5 | 21 | 1.7 |
| 150 | 199 | 0.8 | 124 | 0.9 | 90 | 1.0 | 64 | 1.1 | 47 | 1.2 | 39 | 1.3 | 32 | 1.4 | 26 | 1.5 | 22 | 1.7 |
| 160 | 212 | 0.8 | 132 | 0.9 | 96 | 1.0 | 69 | 1.1 | 50 | 1.2 | 41 | 1.3 | 34 | 1.4 | 28 | 1.5 | 23 | 1.7 |
| 170 | 225 | 0.8 | 140 | 0.9 | 102 | 1.0 | 73 | 1.1 | 53 | 1.2 | 44 | 1.3 | 36 | 1.4 | 29 | 1.5 | 25 | 1.7 |
| 180 | 238 | 0.8 | 148 | 0.9 | 108 | 1.0 | 77 | 1.1 | 56 | 1.2 | 46 | 1.3 | 38 | 1.4 | 31 | 1.5 | 26 | 1.7 |

Q = Flow in Cubic Feet per Second, V = Velocity in Feet per Second, T = Top Width in Feet
 D = Depth in Feet

Sheet 9 of 14

Parabolic Waterway Design

Grade 3.0 Percent

V for Retardance "D",
T and D for Retardance "C"

| Q cfs | V = 2.0 | | V = 2.5 | | V = 3.0 | | V = 3.5 | | V = 4.0 | | V = 4.5 | | V = 5.0 | | V = 5.5 | | V = 6.0 | |
|----------|---------|-----|---------|-----|---------|-----|---------|-----|---------|-----|---------|-----|---------|-----|---------|-----|---------|-----|
| | T | D | T | D | T | D | T | D | T | D | T | D | T | D | T | D | T | D |
| 15 | 24 | 0.7 | 16 | 0.8 | 11 | 0.8 | 9 | 0.9 | 7 | 1.0 | 5 | 1.2 | | | | | | |
| 20 | 31 | 0.7 | 22 | 0.8 | 15 | 0.8 | 12 | 0.9 | 9 | 1.0 | 7 | 1.1 | 6 | 1.2 | | | | |
| 25 | 39 | 0.7 | 27 | 0.8 | 19 | 0.8 | 15 | 0.9 | 11 | 1.0 | 8 | 1.1 | 7 | 1.2 | 6 | 1.3 | | |
| 30 | 47 | 0.7 | 32 | 0.8 | 23 | 0.8 | 17 | 0.9 | 13 | 1.0 | 10 | 1.1 | 9 | 1.2 | 7 | 1.2 | 6 | 1.4 |
| 35 | 55 | 0.7 | 38 | 0.8 | 26 | 0.8 | 20 | 0.9 | 15 | 1.0 | 11 | 1.1 | 10 | 1.1 | 8 | 1.2 | 7 | 1.4 |
| 40 | 62 | 0.7 | 43 | 0.8 | 30 | 0.8 | 23 | 0.9 | 17 | 1.0 | 13 | 1.1 | 12 | 1.1 | 9 | 1.2 | 8 | 1.4 |
| 45 | 70 | 0.7 | 48 | 0.8 | 34 | 0.8 | 26 | 0.9 | 19 | 1.0 | 15 | 1.1 | 13 | 1.1 | 11 | 1.2 | 9 | 1.3 |
| 50 | 77 | 0.7 | 54 | 0.8 | 38 | 0.8 | 29 | 0.9 | 21 | 1.0 | 16 | 1.1 | 14 | 1.1 | 12 | 1.2 | 9 | 1.3 |
| 55 | 85 | 0.7 | 59 | 0.8 | 41 | 0.8 | 32 | 0.9 | 23 | 1.0 | 18 | 1.1 | 16 | 1.1 | 13 | 1.2 | 10 | 1.4 |
| 60 | 93 | 0.7 | 64 | 0.8 | 45 | 0.8 | 35 | 0.9 | 26 | 1.0 | 19 | 1.1 | 17 | 1.1 | 14 | 1.2 | 11 | 1.3 |
| 65 | 100 | 0.7 | 70 | 0.8 | 49 | 0.8 | 37 | 0.9 | 28 | 1.0 | 21 | 1.1 | 19 | 1.1 | 15 | 1.2 | 12 | 1.3 |
| 70 | 107 | 0.7 | 74 | 0.8 | 52 | 0.8 | 40 | 0.9 | 30 | 1.0 | 22 | 1.1 | 20 | 1.1 | 16 | 1.2 | 13 | 1.3 |
| 75 | 115 | 0.7 | 79 | 0.8 | 56 | 0.8 | 43 | 0.9 | 32 | 1.0 | 24 | 1.1 | 21 | 1.1 | 18 | 1.2 | 14 | 1.3 |
| 80 | 122 | 0.7 | 85 | 0.8 | 59 | 0.8 | 46 | 0.9 | 34 | 1.0 | 26 | 1.1 | 23 | 1.1 | 19 | 1.2 | 15 | 1.3 |
| 90 | 137 | 0.7 | 95 | 0.8 | 67 | 0.8 | 51 | 0.9 | 38 | 1.0 | 29 | 1.1 | 26 | 1.1 | 21 | 1.2 | 17 | 1.3 |
| 100 | 152 | 0.7 | 105 | 0.8 | 74 | 0.8 | 57 | 0.9 | 42 | 1.0 | 32 | 1.1 | 28 | 1.1 | 23 | 1.2 | 19 | 1.3 |
| 110 | 167 | 0.7 | 116 | 0.8 | 81 | 0.8 | 63 | 0.9 | 46 | 1.0 | 35 | 1.1 | 31 | 1.1 | 26 | 1.2 | 21 | 1.3 |
| 120 | 181 | 0.7 | 126 | 0.8 | 89 | 0.8 | 68 | 0.9 | 51 | 1.0 | 38 | 1.1 | 34 | 1.1 | 28 | 1.2 | 22 | 1.3 |
| 130 | 196 | 0.7 | 136 | 0.8 | 96 | 0.8 | 74 | 0.9 | 55 | 1.0 | 41 | 1.1 | 37 | 1.1 | 30 | 1.2 | 24 | 1.3 |
| 140 | 211 | 0.7 | 146 | 0.8 | 103 | 0.8 | 79 | 0.9 | 59 | 1.0 | 44 | 1.1 | 39 | 1.1 | 32 | 1.2 | 26 | 1.3 |
| 150 | 225 | 0.7 | 156 | 0.8 | 110 | 0.8 | 85 | 0.9 | 63 | 1.0 | 47 | 1.1 | 42 | 1.1 | 35 | 1.2 | 28 | 1.3 |
| 160 | 239 | 0.7 | 166 | 0.8 | 117 | 0.8 | 90 | 0.9 | 67 | 1.0 | 50 | 1.1 | 45 | 1.1 | 37 | 1.2 | 30 | 1.3 |
| 170 | 254 | 0.7 | 176 | 0.8 | 124 | 0.8 | 96 | 0.9 | 71 | 1.0 | 54 | 1.1 | 48 | 1.1 | 39 | 1.2 | 32 | 1.3 |
| 180 | 268 | 0.7 | 186 | 0.8 | 131 | 0.8 | 101 | 0.9 | 75 | 1.0 | 57 | 1.1 | 50 | 1.1 | 41 | 1.2 | 33 | 1.3 |

Q = Flow in Cubic Feet per Second, V = Velocity in Feet per Second, T = Top Width in Feet
D = Depth in Feet

V for Retardance "D",
T and D for Retardance "C"

Parabolic Waterway Design

Sheet 10 of 14

Grade 4.0 Percent

| Q cfs | V = 2.0 | | V = 2.5 | | V = 3.0 | | V = 3.5 | | V = 4.0 | | V = 4.5 | | V = 5.0 | | V = 5.5 | | V = 6.0 | |
|----------|---------|-----|---------|-----|---------|-----|---------|-----|---------|-----|---------|-----|---------|-----|---------|-----|---------|-----|
| | T | D | T | D | T | D | T | D | T | D | T | D | T | D | T | D | T | D |
| 15 | 28 | 0.6 | 20 | 0.7 | 14 | 0.7 | 10 | 0.8 | 8 | 0.9 | 6 | 0.9 | 5 | 1.1 | | | | |
| 20 | 37 | 0.6 | 27 | 0.7 | 19 | 0.7 | 14 | 0.8 | 11 | 0.8 | 8 | 0.9 | 6 | 1.0 | 6 | 1.1 | | |
| 25 | 46 | 0.6 | 33 | 0.7 | 23 | 0.7 | 17 | 0.8 | 13 | 0.8 | 11 | 0.9 | 8 | 1.0 | 7 | 1.1 | 6 | 1.2 |
| 30 | 55 | 0.6 | 40 | 0.7 | 28 | 0.7 | 20 | 0.8 | 16 | 0.8 | 13 | 0.9 | 10 | 1.0 | 8 | 1.1 | 7 | 1.2 |
| 35 | 64 | 0.6 | 46 | 0.7 | 32 | 0.7 | 24 | 0.8 | 18 | 0.8 | 15 | 0.9 | 11 | 1.0 | 10 | 1.1 | 8 | 1.2 |
| 40 | 73 | 0.6 | 52 | 0.7 | 37 | 0.7 | 27 | 0.8 | 21 | 0.8 | 17 | 0.9 | 13 | 1.0 | 11 | 1.0 | 9 | 1.1 |
| 45 | 82 | 0.6 | 59 | 0.7 | 41 | 0.7 | 30 | 0.8 | 23 | 0.8 | 19 | 0.9 | 14 | 1.0 | 12 | 1.1 | 10 | 1.1 |
| 50 | 91 | 0.6 | 65 | 0.7 | 46 | 0.7 | 34 | 0.8 | 26 | 0.8 | 21 | 0.9 | 16 | 1.0 | 14 | 1.1 | 11 | 1.1 |
| 55 | 100 | 0.6 | 72 | 0.7 | 50 | 0.7 | 37 | 0.8 | 29 | 0.8 | 23 | 0.9 | 17 | 1.0 | 15 | 1.0 | 12 | 1.1 |
| 60 | 109 | 0.6 | 78 | 0.7 | 55 | 0.7 | 40 | 0.8 | 31 | 0.8 | 25 | 0.9 | 19 | 1.0 | 16 | 1.0 | 13 | 1.1 |
| 65 | 117 | 0.6 | 84 | 0.7 | 59 | 0.7 | 44 | 0.8 | 34 | 0.8 | 27 | 0.9 | 20 | 1.0 | 18 | 1.1 | 14 | 1.1 |
| 70 | 126 | 0.6 | 90 | 0.7 | 63 | 0.7 | 47 | 0.8 | 36 | 0.8 | 29 | 0.9 | 22 | 1.0 | 19 | 1.0 | 15 | 1.1 |
| 75 | 135 | 0.6 | 97 | 0.7 | 68 | 0.7 | 50 | 0.8 | 39 | 0.8 | 31 | 0.8 | 24 | 1.0 | 20 | 1.0 | 17 | 1.1 |
| 80 | 143 | 0.6 | 103 | 0.7 | 72 | 0.7 | 53 | 0.8 | 41 | 0.8 | 33 | 0.9 | 25 | 1.0 | 21 | 1.0 | 18 | 1.1 |
| 90 | 161 | 0.6 | 115 | 0.7 | 81 | 0.7 | 60 | 0.8 | 46 | 0.8 | 37 | 0.9 | 28 | 1.0 | 24 | 1.0 | 20 | 1.1 |
| 100 | 178 | 0.6 | 128 | 0.7 | 90 | 0.7 | 66 | 0.8 | 51 | 0.8 | 41 | 0.9 | 31 | 1.0 | 27 | 1.0 | 22 | 1.1 |
| 110 | 195 | 0.6 | 140 | 0.7 | 99 | 0.7 | 73 | 0.8 | 56 | 0.8 | 45 | 0.9 | 34 | 1.0 | 29 | 1.0 | 24 | 1.1 |
| 120 | 213 | 0.6 | 153 | 0.7 | 107 | 0.7 | 79 | 0.8 | 61 | 0.8 | 49 | 0.9 | 37 | 1.0 | 32 | 1.0 | 26 | 1.1 |
| 130 | 230 | 0.6 | 165 | 0.7 | 116 | 0.7 | 86 | 0.8 | 66 | 0.8 | 53 | 0.9 | 40 | 1.0 | 35 | 1.0 | 28 | 1.1 |
| 140 | 247 | 0.6 | 177 | 0.7 | 125 | 0.7 | 92 | 0.8 | 71 | 0.8 | 57 | 0.9 | 43 | 1.0 | 37 | 1.0 | 31 | 1.1 |
| 150 | 264 | 0.6 | 189 | 0.7 | 133 | 0.7 | 99 | 0.8 | 76 | 0.8 | 61 | 0.9 | 47 | 1.0 | 40 | 1.0 | 33 | 1.1 |
| 160 | 280 | 0.6 | 201 | 0.7 | 142 | 0.7 | 105 | 0.8 | 81 | 0.8 | 65 | 0.9 | 50 | 1.0 | 42 | 1.0 | 35 | 1.1 |
| 170 | 297 | 0.6 | 213 | 0.7 | 150 | 0.7 | 112 | 0.8 | 86 | 0.8 | 69 | 0.9 | 53 | 1.0 | 45 | 1.0 | 37 | 1.1 |
| 180 | 314 | 0.6 | 225 | 0.7 | 159 | 0.7 | 118 | 0.8 | 91 | 0.8 | 73 | 0.9 | 56 | 1.0 | 48 | 1.0 | 39 | 1.1 |

Q = Flow in Cubic Feet per Second, V = Velocity in Feet per Second, T = Top Width in Feet
D = Depth in Feet

V for Retardance "D", Parabolic Waterway Design
 T and D for Retardance "C" Sheet 11 of 14
 Grade 5.0 Percent

| Q cfs | V = 2.0 | | V = 2.5 | | V = 3.0 | | V = 3.5 | | V = 4.0 | | V = 4.5 | | V = 5.0 | | V = 5.5 | | V = 6.0 | |
|----------|---------|-----|---------|-----|---------|-----|---------|-----|---------|-----|---------|-----|---------|-----|---------|-----|---------|-----|
| | T | D | T | D | T | D | T | D | T | D | T | D | T | D | T | D | T | D |
| 15 | 29 | 0.6 | 21 | 0.6 | 15 | 0.7 | 12 | 0.7 | 9 | 0.8 | 7 | 0.8 | 6 | 0.9 | 5 | 1.0 | | |
| 20 | 39 | 0.6 | 28 | 0.6 | 20 | 0.7 | 16 | 0.7 | 12 | 0.8 | 10 | 0.8 | 8 | 0.9 | 6 | 1.0 | 5 | 1.1 |
| 25 | 49 | 0.6 | 35 | 0.6 | 25 | 0.7 | 20 | 0.7 | 15 | 0.8 | 12 | 0.8 | 10 | 0.9 | 8 | 1.0 | 7 | 1.0 |
| 30 | 58 | 0.6 | 42 | 0.6 | 30 | 0.7 | 24 | 0.7 | 18 | 0.8 | 14 | 0.8 | 11 | 0.9 | 9 | 1.0 | 8 | 1.0 |
| 35 | 68 | 0.6 | 49 | 0.6 | 35 | 0.7 | 28 | 0.7 | 21 | 0.8 | 17 | 0.8 | 13 | 0.9 | 11 | 0.9 | 9 | 1.0 |
| 40 | 77 | 0.6 | 56 | 0.6 | 40 | 0.7 | 32 | 0.7 | 24 | 0.8 | 19 | 0.8 | 15 | 0.9 | 12 | 0.9 | 10 | 1.0 |
| 45 | 86 | 0.6 | 63 | 0.6 | 44 | 0.7 | 36 | 0.7 | 27 | 0.8 | 21 | 0.8 | 17 | 0.9 | 14 | 0.9 | 12 | 1.0 |
| 50 | 96 | 0.6 | 69 | 0.6 | 49 | 0.7 | 40 | 0.7 | 30 | 0.8 | 24 | 0.8 | 19 | 0.9 | 15 | 0.9 | 13 | 1.0 |
| 55 | 105 | 0.6 | 76 | 0.6 | 54 | 0.7 | 44 | 0.7 | 33 | 0.8 | 26 | 0.8 | 21 | 0.9 | 17 | 0.9 | 14 | 1.0 |
| 60 | 114 | 0.6 | 83 | 0.6 | 59 | 0.7 | 48 | 0.7 | 36 | 0.8 | 28 | 0.8 | 22 | 0.9 | 18 | 0.9 | 15 | 1.0 |
| 65 | 123 | 0.6 | 89 | 0.6 | 63 | 0.7 | 52 | 0.7 | 38 | 0.8 | 31 | 0.8 | 24 | 0.9 | 19 | 0.9 | 17 | 1.0 |
| 70 | 132 | 0.6 | 96 | 0.6 | 68 | 0.7 | 56 | 0.7 | 41 | 0.8 | 33 | 0.8 | 26 | 0.9 | 21 | 0.9 | 18 | 1.0 |
| 75 | 142 | 0.6 | 102 | 0.6 | 73 | 0.7 | 59 | 0.7 | 44 | 0.8 | 35 | 0.8 | 28 | 0.9 | 22 | 0.9 | 19 | 1.0 |
| 80 | 151 | 0.6 | 109 | 0.6 | 78 | 0.7 | 63 | 0.7 | 47 | 0.8 | 37 | 0.8 | 30 | 0.9 | 24 | 0.9 | 20 | 1.0 |
| 90 | 169 | 0.6 | 122 | 0.6 | 87 | 0.7 | 71 | 0.7 | 53 | 0.8 | 42 | 0.8 | 33 | 0.9 | 27 | 0.9 | 23 | 1.0 |
| 100 | 187 | 0.6 | 136 | 0.6 | 97 | 0.7 | 79 | 0.7 | 59 | 0.8 | 47 | 0.8 | 37 | 0.9 | 30 | 0.9 | 26 | 1.0 |
| 110 | 205 | 0.6 | 149 | 0.6 | 106 | 0.7 | 86 | 0.7 | 64 | 0.8 | 51 | 0.8 | 41 | 0.9 | 33 | 0.9 | 28 | 1.0 |
| 120 | 223 | 0.6 | 162 | 0.6 | 115 | 0.7 | 94 | 0.7 | 70 | 0.8 | 56 | 0.8 | 44 | 0.9 | 35 | 0.9 | 31 | 1.0 |
| 130 | 241 | 0.6 | 175 | 0.6 | 125 | 0.7 | 102 | 0.7 | 76 | 0.8 | 60 | 0.8 | 48 | 0.9 | 38 | 0.9 | 33 | 1.0 |
| 140 | 259 | 0.6 | 188 | 0.6 | 134 | 0.7 | 109 | 0.7 | 81 | 0.8 | 65 | 0.8 | 52 | 0.9 | 41 | 0.9 | 36 | 1.0 |
| 150 | 276 | 0.6 | 201 | 0.6 | 143 | 0.7 | 117 | 0.7 | 87 | 0.8 | 69 | 0.8 | 55 | 0.9 | 44 | 0.9 | 38 | 1.0 |
| 160 | 294 | 0.6 | 213 | 0.6 | 152 | 0.7 | 124 | 0.7 | 93 | 0.8 | 74 | 0.8 | 59 | 0.9 | 47 | 0.9 | 40 | 1.0 |
| 170 | 311 | 0.6 | 226 | 0.6 | 162 | 0.7 | 132 | 0.7 | 98 | 0.8 | 78 | 0.8 | 62 | 0.9 | 50 | 0.9 | 43 | 1.0 |
| 180 | 329 | 0.6 | 239 | 0.6 | 171 | 0.7 | 139 | 0.7 | 104 | 0.8 | 83 | 0.8 | 66 | 0.9 | 53 | 0.9 | 45 | 1.0 |

Q = Flow in Cubic Feet per Second, V = Velocity in Feet per Second, T = Top Width in Feet
 D = Depth in Feet

Sheet 12 of 14

Parabolic Waterway Design

Grade 6.0 Percent

V for Retardance "U",
T and D for Retardance "C"

| Q cfs | V = 2.0 | | V = 2.5 | | V = 3.0 | | V = 3.5 | | V = 4.0 | | V = 4.5 | | V = 5.0 | | V = 5.5 | | V = 6.0 | |
|----------|---------|-----|---------|-----|---------|-----|---------|-----|---------|-----|---------|-----|---------|-----|---------|-----|---------|-----|
| | T | D | T | D | T | D | T | D | T | D | T | D | T | D | T | D | T | D |
| 15 | 35 | 0.5 | 22 | 0.6 | 17 | 0.6 | 13 | 0.7 | 10 | 0.7 | 8 | 0.8 | 7 | 0.8 | 5 | 0.9 | 4 | 1.0 |
| 20 | 46 | 0.5 | 30 | 0.6 | 22 | 0.6 | 17 | 0.7 | 13 | 0.7 | 11 | 0.7 | 9 | 0.8 | 7 | 0.9 | 6 | 1.0 |
| 25 | 57 | 0.5 | 37 | 0.6 | 28 | 0.6 | 21 | 0.7 | 17 | 0.7 | 13 | 0.7 | 11 | 0.8 | 9 | 0.9 | 7 | 0.9 |
| 30 | 69 | 0.5 | 45 | 0.6 | 33 | 0.6 | 25 | 0.7 | 20 | 0.7 | 16 | 0.7 | 13 | 0.8 | 10 | 0.9 | 8 | 0.9 |
| 35 | 80 | 0.5 | 52 | 0.6 | 38 | 0.6 | 29 | 0.7 | 23 | 0.7 | 19 | 0.7 | 15 | 0.8 | 12 | 0.9 | 10 | 0.9 |
| 40 | 91 | 0.5 | 59 | 0.6 | 44 | 0.6 | 33 | 0.7 | 26 | 0.7 | 21 | 0.7 | 17 | 0.8 | 14 | 0.9 | 11 | 0.9 |
| 45 | 102 | 0.5 | 67 | 0.6 | 49 | 0.6 | 37 | 0.7 | 30 | 0.7 | 24 | 0.7 | 19 | 0.8 | 16 | 0.9 | 13 | 0.9 |
| 50 | 113 | 0.5 | 74 | 0.6 | 54 | 0.6 | 42 | 0.7 | 33 | 0.7 | 26 | 0.7 | 22 | 0.8 | 17 | 0.9 | 14 | 0.9 |
| 55 | 123 | 0.5 | 81 | 0.6 | 60 | 0.6 | 45 | 0.7 | 36 | 0.7 | 29 | 0.7 | 24 | 0.8 | 19 | 0.8 | 15 | 0.9 |
| 60 | 134 | 0.5 | 88 | 0.6 | 65 | 0.6 | 50 | 0.7 | 39 | 0.7 | 32 | 0.7 | 26 | 0.8 | 21 | 0.8 | 17 | 0.9 |
| 65 | 145 | 0.5 | 95 | 0.6 | 70 | 0.6 | 54 | 0.7 | 42 | 0.7 | 34 | 0.7 | 28 | 0.8 | 22 | 0.9 | 18 | 0.9 |
| 70 | 155 | 0.5 | 102 | 0.6 | 75 | 0.6 | 58 | 0.7 | 45 | 0.7 | 37 | 0.7 | 30 | 0.8 | 24 | 0.9 | 19 | 0.9 |
| 75 | 166 | 0.5 | 109 | 0.6 | 81 | 0.6 | 62 | 0.7 | 49 | 0.7 | 39 | 0.7 | 32 | 0.8 | 26 | 0.8 | 21 | 0.9 |
| 80 | 176 | 0.5 | 116 | 0.6 | 86 | 0.6 | 65 | 0.7 | 52 | 0.7 | 42 | 0.7 | 34 | 0.8 | 27 | 0.9 | 22 | 0.9 |
| 90 | 198 | 0.5 | 130 | 0.6 | 96 | 0.6 | 73 | 0.7 | 58 | 0.7 | 47 | 0.7 | 38 | 0.8 | 31 | 0.8 | 25 | 0.9 |
| 100 | 219 | 0.5 | 144 | 0.6 | 107 | 0.6 | 81 | 0.7 | 64 | 0.7 | 52 | 0.7 | 42 | 0.8 | 34 | 0.9 | 28 | 0.9 |
| 110 | 240 | 0.5 | 158 | 0.6 | 117 | 0.6 | 89 | 0.7 | 71 | 0.7 | 57 | 0.7 | 47 | 0.8 | 37 | 0.8 | 30 | 0.9 |
| 120 | 261 | 0.5 | 172 | 0.6 | 127 | 0.6 | 97 | 0.7 | 77 | 0.7 | 62 | 0.7 | 51 | 0.8 | 41 | 0.8 | 33 | 0.9 |
| 130 | 282 | 0.5 | 185 | 0.6 | 138 | 0.6 | 105 | 0.7 | 83 | 0.7 | 67 | 0.7 | 55 | 0.8 | 44 | 0.8 | 36 | 0.9 |
| 140 | 302 | 0.5 | 199 | 0.6 | 148 | 0.6 | 113 | 0.7 | 89 | 0.7 | 72 | 0.7 | 59 | 0.8 | 47 | 0.8 | 38 | 0.9 |
| 150 | 323 | 0.5 | 213 | 0.6 | 158 | 0.6 | 121 | 0.7 | 96 | 0.7 | 77 | 0.7 | 63 | 0.8 | 50 | 0.8 | 41 | 0.9 |
| 160 | 343 | 0.5 | 226 | 0.6 | 168 | 0.6 | 129 | 0.7 | 102 | 0.7 | 82 | 0.7 | 67 | 0.8 | 54 | 0.9 | 44 | 0.9 |
| 170 | 363 | 0.5 | 240 | 0.6 | 178 | 0.6 | 136 | 0.7 | 108 | 0.7 | 87 | 0.7 | 71 | 0.8 | 57 | 0.8 | 46 | 0.9 |
| 180 | 383 | 0.5 | 253 | 0.6 | 188 | 0.6 | 144 | 0.7 | 114 | 0.7 | 92 | 0.7 | 75 | 0.8 | 60 | 0.9 | 49 | 0.9 |

Q = Flow in Cubic Feet per Second, V = Velocity in Feet per Second, T = Top Width in Feet
D = Depth in Feet

V for Retardance "D",
T and D for Retardance "C"

Parabolic Waterway Design

Grade 8.0 Percent

Sheet 13 of 14

| Q cfs | V = 2.0 | | V = 2.5 | | V = 3.0 | | V = 3.5 | | V = 4.0 | | V = 4.5 | | V = 5.0 | | V = 5.5 | | V = 6.0 | |
|----------|---------|-----|---------|-----|---------|-----|---------|-----|---------|-----|---------|-----|---------|-----|---------|-----|---------|-----|
| | T | D | T | D | T | D | T | D | T | D | T | D | T | D | T | D | T | D |
| 15 | 37 | 0.5 | 27 | 0.5 | 19 | 0.5 | 15 | 0.6 | 12 | 0.6 | 9 | 0.7 | 8 | 0.7 | 6 | 0.7 | 5 | 0.8 |
| 20 | 49 | 0.5 | 35 | 0.5 | 25 | 0.5 | 20 | 0.6 | 16 | 0.6 | 13 | 0.7 | 10 | 0.7 | 9 | 0.7 | 7 | 0.8 |
| 25 | 61 | 0.5 | 44 | 0.5 | 31 | 0.5 | 25 | 0.6 | 19 | 0.6 | 16 | 0.7 | 13 | 0.7 | 11 | 0.7 | 9 | 0.8 |
| 30 | 73 | 0.5 | 53 | 0.5 | 37 | 0.5 | 30 | 0.6 | 23 | 0.6 | 19 | 0.7 | 16 | 0.7 | 13 | 0.7 | 11 | 0.8 |
| 35 | 85 | 0.5 | 61 | 0.5 | 43 | 0.5 | 35 | 0.6 | 27 | 0.6 | 22 | 0.6 | 18 | 0.7 | 15 | 0.7 | 12 | 0.8 |
| 40 | 97 | 0.5 | 70 | 0.5 | 49 | 0.5 | 40 | 0.6 | 31 | 0.6 | 25 | 0.6 | 21 | 0.7 | 17 | 0.7 | 14 | 0.8 |
| 45 | 109 | 0.5 | 78 | 0.5 | 55 | 0.5 | 45 | 0.6 | 35 | 0.6 | 28 | 0.6 | 23 | 0.7 | 19 | 0.7 | 16 | 0.8 |
| 50 | 120 | 0.5 | 87 | 0.5 | 61 | 0.5 | 50 | 0.6 | 38 | 0.6 | 31 | 0.7 | 26 | 0.7 | 21 | 0.7 | 17 | 0.8 |
| 55 | 132 | 0.5 | 95 | 0.5 | 67 | 0.5 | 55 | 0.6 | 42 | 0.6 | 34 | 0.7 | 28 | 0.7 | 23 | 0.7 | 19 | 0.8 |
| 60 | 143 | 0.5 | 103 | 0.5 | 73 | 0.5 | 60 | 0.6 | 46 | 0.6 | 37 | 0.7 | 31 | 0.7 | 25 | 0.7 | 21 | 0.8 |
| 65 | 155 | 0.5 | 111 | 0.5 | 79 | 0.5 | 65 | 0.6 | 50 | 0.6 | 40 | 0.7 | 33 | 0.7 | 27 | 0.7 | 23 | 0.8 |
| 70 | 166 | 0.5 | 120 | 0.5 | 85 | 0.5 | 69 | 0.6 | 53 | 0.6 | 43 | 0.6 | 36 | 0.7 | 29 | 0.7 | 24 | 0.8 |
| 75 | 177 | 0.5 | 128 | 0.5 | 91 | 0.5 | 74 | 0.6 | 57 | 0.6 | 46 | 0.7 | 38 | 0.7 | 31 | 0.7 | 26 | 0.8 |
| 80 | 188 | 0.5 | 136 | 0.5 | 96 | 0.5 | 79 | 0.6 | 61 | 0.6 | 49 | 0.6 | 41 | 0.7 | 33 | 0.7 | 28 | 0.8 |
| 90 | 211 | 0.5 | 152 | 0.5 | 108 | 0.6 | 88 | 0.6 | 68 | 0.6 | 55 | 0.7 | 46 | 0.7 | 37 | 0.7 | 31 | 0.8 |
| 100 | 234 | 0.5 | 168 | 0.5 | 120 | 0.6 | 98 | 0.6 | 75 | 0.6 | 61 | 0.7 | 51 | 0.7 | 41 | 0.7 | 34 | 0.8 |
| 110 | 256 | 0.5 | 185 | 0.5 | 131 | 0.6 | 108 | 0.6 | 83 | 0.6 | 67 | 0.7 | 57 | 0.7 | 46 | 0.7 | 38 | 0.8 |
| 120 | 278 | 0.5 | 201 | 0.5 | 143 | 0.6 | 117 | 0.6 | 90 | 0.6 | 73 | 0.7 | 61 | 0.7 | 50 | 0.7 | 41 | 0.8 |
| 130 | 300 | 0.5 | 217 | 0.5 | 154 | 0.6 | 126 | 0.6 | 97 | 0.6 | 78 | 0.7 | 65 | 0.7 | 54 | 0.7 | 44 | 0.8 |
| 140 | 322 | 0.5 | 233 | 0.5 | 166 | 0.6 | 136 | 0.6 | 104 | 0.6 | 84 | 0.7 | 70 | 0.7 | 58 | 0.7 | 48 | 0.8 |
| 150 | 344 | 0.5 | 248 | 0.5 | 177 | 0.6 | 145 | 0.6 | 112 | 0.6 | 90 | 0.7 | 75 | 0.7 | 62 | 0.7 | 51 | 0.8 |
| 160 | 366 | 0.5 | 264 | 0.5 | 188 | 0.6 | 154 | 0.6 | 119 | 0.6 | 96 | 0.7 | 80 | 0.7 | 66 | 0.7 | 54 | 0.8 |
| 170 | 387 | 0.5 | 280 | 0.5 | 199 | 0.6 | 164 | 0.6 | 126 | 0.6 | 102 | 0.7 | 85 | 0.7 | 70 | 0.7 | 58 | 0.8 |
| 180 | 408 | 0.5 | 295 | 0.5 | 210 | 0.6 | 173 | 0.6 | 133 | 0.6 | 107 | 0.7 | 90 | 0.7 | 74 | 0.7 | 61 | 0.8 |

Q = Flow in Cubic Feet per Second, V = Velocity in Feet per Second, T = Top Width in Feet
D = Depth in Feet

V for Retardance "D",
 T and D for Retardance "C"
 Parabolic Waterway Design
 Grade 10.0 Percent
 Sheet 14 of 14

| Q cfs | V = 2.0 | | V = 2.5 | | V = 3.0 | | V = 3.5 | | V = 4.0 | | V = 4.5 | | V = 5.0 | | V = 5.5 | | V = 6.0 | |
|----------|---------|-----|---------|-----|---------|-----|---------|-----|---------|-----|---------|-----|---------|-----|---------|-----|---------|-----|
| | T | D | T | D | T | D | T | D | T | D | T | D | T | D | T | D | T | D |
| 15 | 45 | 0.4 | 33 | 0.5 | 23 | 0.5 | 17 | 0.5 | 13 | 0.6 | 11 | 0.6 | 9 | 0.6 | 7 | 0.7 | 6 | 0.7 |
| 20 | 60 | 0.4 | 43 | 0.5 | 30 | 0.5 | 22 | 0.5 | 18 | 0.6 | 14 | 0.6 | 12 | 0.6 | 10 | 0.7 | 8 | 0.7 |
| 25 | 75 | 0.4 | 54 | 0.5 | 38 | 0.5 | 28 | 0.5 | 22 | 0.6 | 18 | 0.6 | 15 | 0.6 | 12 | 0.7 | 10 | 0.7 |
| 30 | 89 | 0.4 | 64 | 0.5 | 45 | 0.5 | 33 | 0.5 | 27 | 0.6 | 21 | 0.6 | 18 | 0.6 | 15 | 0.6 | 12 | 0.7 |
| 35 | 104 | 0.4 | 75 | 0.5 | 53 | 0.5 | 38 | 0.5 | 31 | 0.6 | 25 | 0.6 | 21 | 0.6 | 17 | 0.7 | 14 | 0.7 |
| 40 | 118 | 0.4 | 85 | 0.5 | 60 | 0.5 | 44 | 0.5 | 35 | 0.6 | 28 | 0.6 | 24 | 0.6 | 20 | 0.7 | 16 | 0.7 |
| 45 | 132 | 0.4 | 95 | 0.5 | 67 | 0.5 | 49 | 0.5 | 40 | 0.6 | 32 | 0.6 | 27 | 0.6 | 22 | 0.7 | 18 | 0.7 |
| 50 | 146 | 0.4 | 105 | 0.5 | 74 | 0.5 | 54 | 0.5 | 44 | 0.6 | 35 | 0.6 | 30 | 0.6 | 24 | 0.7 | 20 | 0.7 |
| 55 | 160 | 0.4 | 115 | 0.5 | 82 | 0.5 | 60 | 0.5 | 48 | 0.6 | 39 | 0.6 | 32 | 0.6 | 27 | 0.6 | 22 | 0.7 |
| 60 | 174 | 0.4 | 125 | 0.5 | 87 | 0.5 | 65 | 0.5 | 52 | 0.6 | 42 | 0.6 | 35 | 0.6 | 29 | 0.7 | 24 | 0.7 |
| 65 | 188 | 0.4 | 135 | 0.5 | 96 | 0.5 | 70 | 0.5 | 57 | 0.6 | 45 | 0.6 | 38 | 0.6 | 32 | 0.7 | 26 | 0.7 |
| 70 | 201 | 0.4 | 145 | 0.5 | 103 | 0.5 | 75 | 0.5 | 61 | 0.6 | 49 | 0.6 | 41 | 0.6 | 34 | 0.7 | 28 | 0.7 |
| 75 | 215 | 0.4 | 155 | 0.5 | 110 | 0.5 | 80 | 0.5 | 65 | 0.6 | 52 | 0.6 | 44 | 0.6 | 36 | 0.7 | 30 | 0.7 |
| 80 | 228 | 0.4 | 164 | 0.5 | 116 | 0.5 | 85 | 0.5 | 69 | 0.6 | 55 | 0.6 | 47 | 0.6 | 39 | 0.7 | 32 | 0.7 |
| 90 | 255 | 0.4 | 184 | 0.5 | 131 | 0.5 | 96 | 0.5 | 76 | 0.6 | 62 | 0.6 | 52 | 0.6 | 43 | 0.7 | 36 | 0.7 |
| 100 | 282 | 0.4 | 204 | 0.5 | 145 | 0.5 | 106 | 0.5 | 86 | 0.6 | 69 | 0.6 | 58 | 0.6 | 48 | 0.7 | 40 | 0.7 |
| 110 | 309 | 0.4 | 223 | 0.5 | 158 | 0.5 | 116 | 0.5 | 94 | 0.6 | 76 | 0.6 | 64 | 0.6 | 53 | 0.7 | 44 | 0.7 |
| 120 | 336 | 0.4 | 242 | 0.5 | 172 | 0.5 | 126 | 0.5 | 103 | 0.6 | 82 | 0.6 | 69 | 0.6 | 57 | 0.7 | 48 | 0.7 |
| 130 | 362 | 0.4 | 262 | 0.5 | 186 | 0.5 | 137 | 0.5 | 111 | 0.6 | 89 | 0.6 | 75 | 0.6 | 62 | 0.7 | 52 | 0.7 |
| 140 | 388 | 0.4 | 281 | 0.5 | 200 | 0.5 | 147 | 0.5 | 119 | 0.6 | 95 | 0.6 | 81 | 0.6 | 67 | 0.7 | 56 | 0.7 |
| 150 | 414 | 0.4 | 299 | 0.5 | 213 | 0.5 | 157 | 0.5 | 127 | 0.6 | 102 | 0.6 | 86 | 0.6 | 71 | 0.7 | 60 | 0.7 |
| 160 | 440 | 0.4 | 318 | 0.5 | 227 | 0.5 | 166 | 0.5 | 135 | 0.6 | 108 | 0.6 | 92 | 0.6 | 76 | 0.7 | 64 | 0.7 |
| 170 | 466 | 0.4 | 337 | 0.5 | 240 | 0.5 | 176 | 0.5 | 143 | 0.6 | 115 | 0.6 | 97 | 0.6 | 80 | 0.7 | 67 | 0.7 |
| 180 | 491 | 0.4 | 355 | 0.5 | 253 | 0.5 | 186 | 0.5 | 151 | 0.6 | 121 | 0.6 | 103 | 0.6 | 85 | 0.7 | 71 | 0.7 |

Q = Flow in Cubic Feet per Second, V = Velocity in Feet per Second, T = Top Width in Feet
 D = Depth in Feet

Trapezoidal Channel Design
 "C" Retardance
 Grade 0.25 Percent
 Side Slope = 2:1

| Q cfs | Bottom Width, b, in Feet | | | | | | | | | | | | | | | |
|----------|--------------------------|-----|-------|-----|-------|-----|--------|-----|--------|-----|--------|-----|--------|-----|-----|-----|
| | b = 2 | | b = 1 | | b = 8 | | b = 10 | | b = 12 | | b = 14 | | b = 16 | | | |
| | D | V | D | V | D | V | D | V | D | V | D | V | D | V | | |
| 15 | 2.1 | 1.1 | 1.8 | 1.1 | 1.6 | 1.0 | 1.5 | 1.0 | 1.3 | 0.9 | 1.3 | 0.8 | 1.2 | 0.8 | 1.2 | 0.7 |
| 20 | 2.3 | 1.3 | 1.9 | 1.3 | 1.7 | 1.2 | 1.5 | 1.2 | 1.4 | 1.1 | 1.4 | 1.0 | 1.3 | 0.9 | 1.2 | 0.9 |
| 25 | 2.4 | 1.5 | 2.1 | 1.5 | 1.8 | 1.4 | 1.7 | 1.3 | 1.5 | 1.2 | 1.4 | 1.2 | 1.4 | 1.1 | 1.3 | 1.0 |
| 30 | 2.5 | 1.7 | 2.2 | 1.6 | 1.9 | 1.6 | 1.7 | 1.5 | 1.6 | 1.4 | 1.5 | 1.3 | 1.4 | 1.2 | 1.4 | 1.2 |
| 35 | 2.7 | 1.8 | 2.3 | 1.8 | 2.0 | 1.7 | 1.8 | 1.6 | 1.7 | 1.5 | 1.6 | 1.5 | 1.5 | 1.4 | 1.4 | 1.3 |
| 40 | 2.8 | 1.9 | 2.4 | 1.9 | 2.1 | 1.8 | 1.9 | 1.8 | 1.8 | 1.7 | 1.7 | 1.6 | 1.6 | 1.5 | 1.5 | 1.4 |
| 45 | 2.9 | 2.0 | 2.5 | 2.0 | 2.2 | 1.9 | 2.0 | 1.9 | 1.8 | 1.8 | 1.7 | 1.7 | 1.6 | 1.6 | 1.6 | 1.5 |
| 50 | 2.9 | 2.1 | 2.6 | 2.1 | 2.3 | 2.1 | 2.1 | 2.0 | 1.9 | 1.9 | 1.8 | 1.8 | 1.7 | 1.7 | 1.6 | 1.6 |
| 55 | 3.0 | 2.2 | 2.7 | 2.2 | 2.4 | 2.2 | 2.2 | 2.1 | 2.0 | 2.0 | 1.9 | 1.9 | 1.8 | 1.8 | 1.7 | 1.7 |
| 60 | 3.1 | 2.3 | 2.8 | 2.3 | 2.5 | 2.2 | 2.2 | 2.2 | 2.0 | 2.1 | 1.9 | 2.0 | 1.8 | 1.9 | 1.7 | 1.8 |
| 65 | 3.2 | 2.4 | 2.8 | 2.4 | 2.5 | 2.3 | 2.3 | 2.2 | 2.1 | 2.2 | 2.0 | 2.2 | 1.9 | 2.0 | 1.8 | 1.9 |
| 70 | 3.3 | 2.5 | 2.9 | 2.4 | 2.6 | 2.4 | 2.4 | 2.3 | 2.2 | 2.2 | 2.0 | 2.2 | 1.9 | 2.1 | 1.8 | 2.0 |
| 75 | 3.4 | 2.5 | 3.0 | 2.5 | 2.7 | 2.5 | 2.4 | 2.4 | 2.2 | 2.3 | 2.1 | 2.2 | 1.9 | 2.1 | 1.8 | 2.1 |
| 80 | 3.4 | 2.6 | 3.1 | 2.6 | 2.7 | 2.5 | 2.5 | 2.5 | 2.3 | 2.4 | 2.1 | 2.3 | 2.0 | 2.2 | 1.9 | 2.1 |
| 90 | 3.6 | 2.7 | 3.2 | 2.7 | 2.9 | 2.7 | 2.6 | 2.6 | 2.4 | 2.5 | 2.2 | 2.4 | 2.1 | 2.3 | 2.0 | 2.3 |
| 100 | 3.7 | 2.8 | 3.3 | 2.8 | 3.0 | 2.8 | 2.7 | 2.7 | 2.5 | 2.7 | 2.3 | 2.6 | 2.2 | 2.5 | 2.1 | 2.4 |
| 110 | 3.9 | 2.9 | 3.5 | 2.9 | 3.1 | 2.9 | 2.8 | 2.8 | 2.6 | 2.8 | 2.4 | 2.7 | 2.3 | 2.6 | 2.2 | 2.5 |
| 120 | 4.0 | 3.1 | 3.5 | 3.0 | 3.2 | 3.0 | 2.9 | 2.9 | 2.6 | 2.9 | 2.5 | 2.8 | 2.4 | 2.7 | 2.2 | 2.6 |
| 130 | 4.1 | 3.1 | 3.7 | 3.1 | 3.3 | 3.1 | 3.0 | 3.0 | 2.7 | 2.9 | 2.5 | 2.9 | 2.5 | 2.8 | 2.3 | 2.7 |
| 140 | 4.2 | 3.2 | 3.8 | 3.2 | 3.4 | 3.2 | 3.1 | 3.1 | 2.8 | 3.0 | 2.6 | 2.9 | 2.5 | 2.9 | 2.4 | 2.8 |
| 150 | 4.3 | 3.3 | 3.9 | 3.3 | 3.5 | 3.3 | 3.2 | 3.2 | 3.0 | 3.1 | 2.7 | 3.0 | 2.5 | 2.9 | 2.5 | 2.9 |
| 160 | 4.4 | 3.4 | 4.0 | 3.4 | 3.6 | 3.4 | 3.3 | 3.3 | 3.1 | 3.2 | 2.8 | 3.1 | 2.6 | 3.0 | 2.5 | 3.0 |
| 170 | 4.5 | 3.5 | 4.1 | 3.5 | 3.7 | 3.4 | 3.4 | 3.4 | 3.1 | 3.3 | 2.9 | 3.2 | 2.7 | 3.1 | 2.5 | 3.0 |
| 180 | 4.6 | 3.6 | 4.1 | 3.6 | 3.8 | 3.5 | 3.5 | 3.5 | 3.2 | 3.4 | 3.0 | 3.3 | 2.8 | 3.2 | 2.6 | 3.1 |
| 190 | 4.6 | 3.6 | 4.2 | 3.6 | 3.9 | 3.6 | 3.6 | 3.5 | 3.3 | 3.5 | 3.1 | 3.4 | 2.9 | 3.3 | 2.7 | 3.2 |
| 200 | 4.7 | 3.7 | 4.3 | 3.7 | 3.9 | 3.7 | 3.6 | 3.6 | 3.4 | 3.5 | 3.2 | 3.5 | 3.0 | 3.4 | 2.8 | 3.3 |
| 220 | 4.9 | 3.8 | 4.5 | 3.8 | 4.1 | 3.8 | 3.8 | 3.7 | 3.5 | 3.7 | 3.3 | 3.6 | 3.1 | 3.5 | 2.9 | 3.4 |
| 240 | 5.0 | 3.9 | 4.5 | 3.9 | 4.2 | 3.9 | 3.9 | 3.8 | 3.6 | 3.8 | 3.4 | 3.7 | 3.2 | 3.6 | 3.0 | 3.6 |
| 260 | 5.2 | 4.0 | 4.8 | 4.0 | 4.4 | 4.0 | 4.1 | 4.0 | 3.8 | 3.9 | 3.5 | 3.8 | 3.3 | 3.8 | 3.2 | 3.7 |
| 280 | 5.3 | 4.1 | 4.9 | 4.1 | 4.5 | 4.1 | 4.2 | 4.1 | 3.9 | 4.0 | 3.7 | 4.0 | 3.6 | 3.9 | 3.3 | 3.8 |
| 300 | 5.5 | 4.2 | 5.0 | 4.2 | 4.7 | 4.2 | 4.3 | 4.2 | 4.0 | 4.1 | 3.8 | 4.1 | 3.6 | 4.0 | 3.4 | 3.9 |

Q = Flow, Cubic feet per Second, V = velocity, Feet per Second, b = Bottom Width, Feet, D = Depth, Feet.

Sheet 2 of 8

Trapezoidal Channel Design
Grade 0.5 Percent

Side Slope = 2:1

"C" Retardance

Bottom Width, b, in Feet

| Q cfs | b = 2 | | b = 4 | | b = 6 | | b = 8 | | b = 10 | | b = 12 | | b = 14 | | b = 16 | |
|----------|-------|-----|-------|-----|-------|-----|-------|-----|--------|-----|--------|-----|--------|-----|--------|-----|
| | D | V | D | V | D | V | D | V | D | V | D | V | D | V | D | V |
| 15 | 1.7 | 1.6 | 1.5 | 1.5 | 1.3 | 1.4 | 1.1 | 1.1 | 1.1 | 1.1 | 1.0 | 1.0 | 1.0 | 1.0 | 0.9 | 0.9 |
| 20 | 1.9 | 1.8 | 1.6 | 1.8 | 1.4 | 1.7 | 1.2 | 1.2 | 1.1 | 1.1 | 1.1 | 1.1 | 1.0 | 1.0 | 1.0 | 1.1 |
| 25 | 2.0 | 2.1 | 1.7 | 2.0 | 1.5 | 1.9 | 1.3 | 1.3 | 1.2 | 1.2 | 1.2 | 1.1 | 1.1 | 1.1 | 1.0 | 1.3 |
| 30 | 2.1 | 2.3 | 1.8 | 2.2 | 1.6 | 2.1 | 1.4 | 1.4 | 1.3 | 1.3 | 1.2 | 1.2 | 1.2 | 1.2 | 1.1 | 1.5 |
| 35 | 2.2 | 2.5 | 1.9 | 2.4 | 1.6 | 2.3 | 1.5 | 1.5 | 1.4 | 1.4 | 1.3 | 1.3 | 1.2 | 1.2 | 1.2 | 1.7 |
| 40 | 2.3 | 2.6 | 2.0 | 2.5 | 1.7 | 2.5 | 1.6 | 1.6 | 1.4 | 1.4 | 1.3 | 1.3 | 1.3 | 1.3 | 1.2 | 1.8 |
| 45 | 2.4 | 2.8 | 2.0 | 2.7 | 1.8 | 2.6 | 1.6 | 1.6 | 1.5 | 1.5 | 1.4 | 1.4 | 1.3 | 1.3 | 1.2 | 2.0 |
| 50 | 2.5 | 2.9 | 2.1 | 2.8 | 1.9 | 2.7 | 1.7 | 1.7 | 1.5 | 1.5 | 1.4 | 1.4 | 1.3 | 1.3 | 1.2 | 2.1 |
| 55 | 2.6 | 3.0 | 2.2 | 2.9 | 1.9 | 2.9 | 1.8 | 1.8 | 1.6 | 1.6 | 1.5 | 1.5 | 1.4 | 1.4 | 1.3 | 2.2 |
| 60 | 2.6 | 3.1 | 2.3 | 3.1 | 2.0 | 2.9 | 1.8 | 1.8 | 1.7 | 1.7 | 1.5 | 1.5 | 1.4 | 1.4 | 1.3 | 2.2 |
| 65 | 2.7 | 3.2 | 2.4 | 3.1 | 2.1 | 3.1 | 1.9 | 1.9 | 1.7 | 1.7 | 1.6 | 1.6 | 1.5 | 1.5 | 1.4 | 2.3 |
| 70 | 2.8 | 3.3 | 2.4 | 3.3 | 2.1 | 3.2 | 2.0 | 2.0 | 1.8 | 1.8 | 1.6 | 1.6 | 1.5 | 1.5 | 1.4 | 2.4 |
| 75 | 2.8 | 3.4 | 2.5 | 3.4 | 2.2 | 3.3 | 2.0 | 2.0 | 1.8 | 1.8 | 1.6 | 1.6 | 1.5 | 1.5 | 1.4 | 2.6 |
| 80 | 2.9 | 3.5 | 2.5 | 3.4 | 2.3 | 3.4 | 2.0 | 2.0 | 1.9 | 1.9 | 1.7 | 1.7 | 1.6 | 1.6 | 1.5 | 2.7 |
| 90 | 3.0 | 3.6 | 2.7 | 3.6 | 2.4 | 3.5 | 2.1 | 2.1 | 2.0 | 2.0 | 1.8 | 1.8 | 1.7 | 1.7 | 1.6 | 2.9 |
| 100 | 3.1 | 3.8 | 2.8 | 3.8 | 2.5 | 3.7 | 2.2 | 2.2 | 2.1 | 2.1 | 1.9 | 1.9 | 1.8 | 1.8 | 1.7 | 3.1 |
| 110 | 3.3 | 4.0 | 2.9 | 3.9 | 2.6 | 3.8 | 2.3 | 2.3 | 2.1 | 2.1 | 2.0 | 2.0 | 1.9 | 1.9 | 1.8 | 3.2 |
| 120 | 3.4 | 4.1 | 3.0 | 4.0 | 2.7 | 4.0 | 2.4 | 2.4 | 2.2 | 2.2 | 2.1 | 2.1 | 2.0 | 2.0 | 1.8 | 3.4 |
| 130 | 3.5 | 4.2 | 3.1 | 4.1 | 2.8 | 4.1 | 2.5 | 2.5 | 2.3 | 2.3 | 2.2 | 2.2 | 2.1 | 2.1 | 1.9 | 3.5 |
| 140 | 3.6 | 4.3 | 3.2 | 4.3 | 2.8 | 4.2 | 2.6 | 2.6 | 2.4 | 2.4 | 2.3 | 2.3 | 2.2 | 2.2 | 1.9 | 3.6 |
| 150 | 3.7 | 4.4 | 3.3 | 4.4 | 2.9 | 4.3 | 2.7 | 2.7 | 2.4 | 2.4 | 2.3 | 2.3 | 2.2 | 2.2 | 2.0 | 3.7 |
| 160 | 3.7 | 4.5 | 3.3 | 4.5 | 3.0 | 4.4 | 2.7 | 2.7 | 2.5 | 2.5 | 2.3 | 2.3 | 2.2 | 2.2 | 2.1 | 3.9 |
| 170 | 3.8 | 4.6 | 3.4 | 4.6 | 3.1 | 4.5 | 2.8 | 2.8 | 2.6 | 2.6 | 2.4 | 2.4 | 2.2 | 2.2 | 2.1 | 4.0 |
| 180 | 3.9 | 4.7 | 3.5 | 4.7 | 3.1 | 4.6 | 2.9 | 2.9 | 2.7 | 2.7 | 2.5 | 2.5 | 2.3 | 2.3 | 2.2 | 4.1 |
| 190 | 4.0 | 4.8 | 3.6 | 4.8 | 3.2 | 4.7 | 2.9 | 2.9 | 2.7 | 2.7 | 2.5 | 2.5 | 2.4 | 2.4 | 2.2 | 4.2 |
| 200 | 4.1 | 4.9 | 3.6 | 4.9 | 3.3 | 4.8 | 3.0 | 3.0 | 2.8 | 2.8 | 2.6 | 2.6 | 2.4 | 2.4 | 2.3 | 4.2 |
| 220 | 4.2 | 5.1 | 3.8 | 5.0 | 3.4 | 5.0 | 3.1 | 3.1 | 2.9 | 2.9 | 2.7 | 2.7 | 2.5 | 2.5 | 2.4 | 4.4 |
| 240 | 4.3 | 5.2 | 3.9 | 5.2 | 3.6 | 5.1 | 3.3 | 3.3 | 3.0 | 3.0 | 2.8 | 2.8 | 2.6 | 2.6 | 2.5 | 4.6 |
| 260 | 4.4 | 5.4 | 4.0 | 5.3 | 3.7 | 5.3 | 3.4 | 3.4 | 3.1 | 3.1 | 2.9 | 2.9 | 2.7 | 2.7 | 2.6 | 4.8 |
| 280 | 4.6 | 5.5 | 4.1 | 5.5 | 3.8 | 5.4 | 3.5 | 3.5 | 3.2 | 3.2 | 3.0 | 3.0 | 2.8 | 2.8 | 2.7 | 4.9 |
| 300 | 4.7 | 5.6 | 4.3 | 5.6 | 3.9 | 5.6 | 3.6 | 3.6 | 3.3 | 3.3 | 3.1 | 3.1 | 2.9 | 2.9 | 2.8 | 5.1 |

Q = Flow, Cubic Feet per Second, V = Velocity, Feet per Second, b = Bottom Width, Feet, D = Depth, Feet.

Trapezoidal Channel Design
Sheet 3 of 8

"C" Retardance Grade 1.0 Percent Side Slope 2:1

Bottom Width, b, in Feet

| Q cfs | b = 2 | | b = 4 | | b = 6 | | b = 8 | | b = 10 | | b = 12 | | b = 14 | | b = 16 | |
|----------|-------|-----|-------|-----|-------|-----|-------|-----|--------|-----|--------|-----|--------|-----|--------|-----|
| | D | V | D | V | D | V | D | V | D | V | D | V | D | V | D | V |
| 15 | 1.4 | 2.2 | 1.2 | 2.0 | 1.0 | 1.8 | 0.9 | 1.7 | 0.9 | 1.5 | 0.8 | 1.4 | 0.8 | 1.2 | 0.7 | 1.1 |
| 20 | 1.5 | 2.5 | 1.3 | 2.4 | 1.1 | 2.2 | 1.0 | 2.0 | 0.9 | 1.8 | 0.9 | 1.7 | 0.8 | 1.5 | 0.8 | 1.4 |
| 25 | 1.7 | 2.8 | 1.4 | 2.7 | 1.2 | 2.5 | 1.1 | 2.3 | 1.0 | 2.1 | 0.9 | 2.0 | 0.9 | 1.8 | 0.8 | 1.7 |
| 30 | 1.8 | 3.1 | 1.5 | 3.0 | 1.3 | 2.8 | 1.1 | 2.6 | 1.0 | 2.4 | 1.0 | 2.2 | 0.9 | 2.0 | 0.9 | 1.9 |
| 35 | 1.9 | 3.3 | 1.6 | 3.2 | 1.3 | 3.0 | 1.2 | 2.8 | 1.1 | 2.6 | 1.0 | 2.4 | 1.0 | 2.3 | 0.9 | 2.1 |
| 40 | 1.9 | 3.5 | 1.6 | 3.4 | 1.4 | 3.2 | 1.3 | 3.0 | 1.1 | 2.8 | 1.1 | 2.6 | 1.0 | 2.5 | 1.0 | 2.3 |
| 45 | 2.0 | 3.7 | 1.7 | 3.6 | 1.5 | 3.4 | 1.3 | 3.2 | 1.2 | 3.0 | 1.1 | 2.8 | 1.1 | 2.7 | 1.0 | 2.5 |
| 50 | 2.1 | 3.9 | 1.8 | 3.7 | 1.5 | 3.6 | 1.4 | 3.4 | 1.3 | 3.2 | 1.2 | 3.0 | 1.1 | 2.8 | 1.0 | 2.7 |
| 55 | 2.2 | 4.0 | 1.8 | 3.9 | 1.6 | 3.7 | 1.4 | 3.5 | 1.3 | 3.3 | 1.2 | 3.2 | 1.1 | 3.0 | 1.1 | 2.8 |
| 60 | 2.2 | 4.2 | 1.9 | 4.1 | 1.7 | 3.9 | 1.5 | 3.7 | 1.3 | 3.5 | 1.3 | 3.3 | 1.2 | 3.1 | 1.1 | 3.0 |
| 65 | 2.3 | 4.3 | 1.9 | 4.2 | 1.7 | 4.0 | 1.5 | 3.9 | 1.4 | 3.6 | 1.3 | 3.5 | 1.2 | 3.3 | 1.1 | 3.1 |
| 70 | 2.4 | 4.4 | 2.0 | 4.3 | 1.8 | 4.2 | 1.6 | 4.0 | 1.4 | 3.8 | 1.3 | 3.6 | 1.2 | 3.4 | 1.2 | 3.3 |
| 75 | 2.4 | 4.5 | 2.1 | 4.5 | 1.8 | 4.3 | 1.6 | 4.1 | 1.5 | 3.9 | 1.4 | 3.7 | 1.3 | 3.5 | 1.2 | 3.4 |
| 80 | 2.5 | 4.6 | 2.1 | 4.5 | 1.9 | 4.4 | 1.7 | 4.2 | 1.5 | 4.0 | 1.4 | 3.9 | 1.3 | 3.7 | 1.2 | 3.5 |
| 90 | 2.6 | 4.9 | 2.2 | 4.8 | 2.0 | 4.6 | 1.7 | 4.5 | 1.6 | 4.3 | 1.5 | 4.1 | 1.4 | 3.9 | 1.3 | 3.7 |
| 100 | 2.7 | 5.1 | 2.3 | 5.0 | 2.0 | 4.9 | 1.8 | 4.7 | 1.7 | 4.5 | 1.5 | 4.3 | 1.4 | 4.1 | 1.4 | 3.9 |
| 110 | 2.8 | 5.2 | 2.4 | 5.2 | 2.1 | 5.0 | 1.9 | 4.9 | 1.7 | 4.7 | 1.6 | 4.5 | 1.5 | 4.3 | 1.4 | 4.1 |
| 120 | 2.9 | 5.4 | 2.5 | 5.4 | 2.2 | 5.2 | 2.0 | 5.0 | 1.8 | 4.9 | 1.7 | 4.7 | 1.6 | 4.5 | 1.5 | 4.3 |
| 130 | 3.0 | 5.6 | 2.6 | 5.5 | 2.3 | 5.4 | 2.1 | 5.2 | 1.9 | 5.0 | 1.7 | 4.9 | 1.6 | 4.7 | 1.5 | 4.5 |
| 140 | 3.0 | 5.7 | 2.7 | 5.6 | 2.4 | 5.5 | 2.1 | 5.4 | 1.9 | 5.2 | 1.8 | 5.0 | 1.7 | 4.8 | 1.6 | 4.7 |
| 150 | 3.1 | 5.9 | 2.7 | 5.8 | 2.4 | 5.6 | 2.2 | 5.5 | 2.0 | 5.4 | 1.8 | 5.2 | 1.7 | 5.0 | 1.6 | 4.8 |
| 160 | 3.2 | 6.0 | 2.8 | 6.0 | 2.5 | 5.8 | 2.2 | 5.7 | 2.1 | 5.5 | 1.9 | 5.3 | 1.8 | 5.1 | 1.7 | 4.9 |
| 170 | | | | | 2.6 | 6.0 | 2.3 | 5.8 | 2.1 | 5.6 | 2.0 | 5.5 | 1.8 | 5.2 | 1.7 | 5.1 |
| 180 | | | | | | | 2.4 | 5.9 | 2.2 | 5.8 | 2.0 | 5.6 | 1.9 | 5.4 | 1.8 | 5.2 |
| 190 | | | | | | | | | 2.2 | 5.9 | 2.1 | 5.7 | 1.9 | 5.5 | 1.8 | 5.4 |
| 200 | | | | | | | | | | | | | | | | |
| 220 | | | | | | | | | | | | | | | | |
| 240 | | | | | | | | | | | | | | | | |

Q = Flow, Cubic Feet per Second, V = Velocity, Feet per Second, b = Bottom Width, Feet, D = Depth, Feet.

Sheet 4 of 8

Trapezoidal Channel Design

"C" Retardance Grade 2.0 Percent Side Slope = 2:1

| Q cfs | Bottom Width, b, in Feet | | | | | | | | | | | | | | | |
|----------|--------------------------|-----|-------|-----|-------|-----|-------|-----|--------|-----|--------|-----|--------|-----|--------|-----|
| | b = 2 | | b = 4 | | b = 6 | | b = 8 | | b = 10 | | b = 12 | | b = 14 | | b = 16 | |
| | D | V | D | V | D | V | D | V | D | V | D | V | D | V | D | V |
| 15 | 1.2 | 3.0 | 0.9 | 2.7 | 0.8 | 2.4 | 0.7 | 2.1 | 0.7 | 1.9 | 0.7 | 1.7 | 0.6 | 1.6 | 0.6 | 1.4 |
| 20 | 1.3 | 3.4 | 1.0 | 3.2 | 0.9 | 2.9 | 0.8 | 2.6 | 0.7 | 2.3 | 0.7 | 2.1 | 0.7 | 1.0 | 0.6 | 1.8 |
| 25 | 1.4 | 3.8 | 1.1 | 3.6 | 1.0 | 3.3 | 0.9 | 3.0 | 0.8 | 2.7 | 0.7 | 2.5 | 0.7 | 2.3 | 0.7 | 2.1 |
| 30 | 1.5 | 4.2 | 1.2 | 3.9 | 1.0 | 3.6 | 0.9 | 3.3 | 0.8 | 3.1 | 0.8 | 2.8 | 0.7 | 2.6 | 0.7 | 2.4 |
| 35 | 1.6 | 4.4 | 1.3 | 4.2 | 1.1 | 3.9 | 1.0 | 3.6 | 0.9 | 3.3 | 0.8 | 3.1 | 0.8 | 2.9 | 0.7 | 2.7 |
| 40 | 1.6 | 4.7 | 1.3 | 4.5 | 1.1 | 4.2 | 1.0 | 3.9 | 0.9 | 3.6 | 0.9 | 3.4 | 0.8 | 3.1 | 0.8 | 2.9 |
| 45 | 1.7 | 4.9 | 1.4 | 4.7 | 1.2 | 4.5 | 1.1 | 4.2 | 1.0 | 3.9 | 0.9 | 3.6 | 0.8 | 3.4 | 0.8 | 3.2 |
| 50 | 1.8 | 5.2 | 1.5 | 5.0 | 1.2 | 4.7 | 1.1 | 4.4 | 1.0 | 4.1 | 0.9 | 3.9 | 0.9 | 3.6 | 0.8 | 3.4 |
| 55 | 1.8 | 5.4 | 1.5 | 5.1 | 1.3 | 4.9 | 1.2 | 4.6 | 1.0 | 4.3 | 1.0 | 4.0 | 0.9 | 3.8 | 0.9 | 3.6 |
| 60 | 1.9 | 5.5 | 1.6 | 5.3 | 1.4 | 5.1 | 1.2 | 4.8 | 1.1 | 4.5 | 1.0 | 4.2 | 0.9 | 4.0 | 0.9 | 3.8 |
| 65 | 1.9 | 5.7 | 1.6 | 5.5 | 1.4 | 5.3 | 1.2 | 5.0 | 1.1 | 4.7 | 1.0 | 4.4 | 1.0 | 4.2 | 0.9 | 4.0 |
| 70 | 2.0 | 5.9 | 1.7 | 5.7 | 1.4 | 5.5 | 1.3 | 5.2 | 1.2 | 4.9 | 1.1 | 4.6 | 1.0 | 4.3 | 1.0 | 4.1 |
| 75 | | | 1.7 | 5.9 | 1.5 | 5.6 | 1.3 | 5.3 | 1.2 | 5.0 | 1.1 | 4.7 | 1.0 | 4.5 | 1.0 | 4.3 |
| 80 | | | | | 1.5 | 5.8 | 1.4 | 5.5 | 1.2 | 5.2 | 1.1 | 4.9 | 1.1 | 4.7 | 1.0 | 4.4 |
| 90 | | | | | | | 1.4 | 5.8 | 1.3 | 5.5 | 1.2 | 5.2 | 1.1 | 5.0 | 1.1 | 4.7 |
| 100 | | | | | | | | | 1.4 | 5.8 | 1.3 | 5.5 | 1.2 | 5.2 | 1.1 | 4.7 |
| 110 | | | | | | | | | 1.4 | 5.8 | 1.3 | 5.5 | 1.2 | 5.2 | 1.1 | 5.0 |
| 120 | | | | | | | | | 1.4 | 6.0 | 1.3 | 5.8 | 1.2 | 5.5 | 1.1 | 5.2 |
| 130 | | | | | | | | | 1.4 | 6.0 | 1.3 | 5.8 | 1.2 | 5.5 | 1.1 | 5.2 |
| 140 | | | | | | | | | | | 1.4 | 6.0 | 1.3 | 5.7 | 1.2 | 5.4 |
| | | | | | | | | | | | | | 1.3 | 5.9 | 1.2 | 5.7 |
| | | | | | | | | | | | | | | | 1.3 | 5.9 |

Q = Flow, Cubic Feet per Second, V = Velocity, Feet per Second, b = Bottom Width, Feet, D = Depth, Feet.

Trapezoidal Channel Design
Sheet 5 of 8

"C" Retardance Grade 3 Percent Side Slope = 2:1

| Q cfs | b = 2 | | b = 4 | | b = 6 | | b = 8 | | b = 10 | | b = 12 | | b = 14 | | b = 16 | |
|----------|-------|-----|-------|-----|-------|-----|-------|-----|--------|-----|--------|-----|--------|-----|--------|-----|
| | D | V | D | V | D | V | D | V | D | V | D | V | D | V | D | V |
| 15 | 1.0 | 3.5 | 0.8 | 3.2 | 0.7 | 2.8 | 0.6 | 2.5 | 0.6 | 2.2 | 0.6 | 2.0 | 0.5 | 1.8 | 0.5 | 1.7 |
| 20 | 1.1 | 4.1 | 0.9 | 3.7 | 0.8 | 3.4 | 0.7 | 3.0 | 0.7 | 2.7 | 0.6 | 2.5 | 0.6 | 2.3 | 0.6 | 2.1 |
| 25 | 1.2 | 4.5 | 1.0 | 4.2 | 0.8 | 3.8 | 0.8 | 3.5 | 0.7 | 3.2 | 0.7 | 2.9 | 0.6 | 2.6 | 0.6 | 2.5 |
| 30 | 1.3 | 4.9 | 1.1 | 4.6 | 0.9 | 4.2 | 0.8 | 3.8 | 0.7 | 3.5 | 0.7 | 3.2 | 0.7 | 3.0 | 0.6 | 2.8 |
| 35 | 1.4 | 5.3 | 1.1 | 4.9 | 1.0 | 4.6 | 0.9 | 4.2 | 0.8 | 3.9 | 0.7 | 3.6 | 0.7 | 3.3 | 0.7 | 3.1 |
| 40 | 1.5 | 5.6 | 1.2 | 5.3 | 1.0 | 4.9 | 0.9 | 4.5 | 0.8 | 4.2 | 0.8 | 3.9 | 0.7 | 3.6 | 0.7 | 3.3 |
| 45 | 1.5 | 5.9 | 1.2 | 5.6 | 1.1 | 5.2 | 0.9 | 4.8 | 0.9 | 4.5 | 0.8 | 4.2 | 0.8 | 3.9 | 0.7 | 3.6 |
| 50 | | | 1.3 | 5.9 | 1.1 | 5.4 | 1.0 | 5.1 | 0.9 | 4.7 | 0.8 | 4.4 | 0.8 | 4.1 | 0.7 | 3.9 |
| 55 | | | | | 1.2 | 5.7 | 1.0 | 5.4 | 0.9 | 5.0 | 0.9 | 4.7 | 0.8 | 4.4 | 0.8 | 4.1 |
| 60 | | | | | 1.2 | 5.9 | 1.2 | 5.6 | 1.0 | 5.2 | 0.9 | 4.9 | 0.8 | 4.6 | 0.8 | 4.3 |
| 65 | | | | | | | 1.1 | 5.8 | 1.0 | 5.4 | 0.9 | 5.1 | 0.9 | 4.8 | 0.8 | 4.5 |
| 70 | | | | | | | 1.1 | 6.0 | 1.0 | 5.6 | 1.0 | 5.3 | 0.9 | 5.0 | 0.8 | 4.7 |
| 75 | | | | | | | | | 1.1 | 5.8 | 1.0 | 5.5 | 0.9 | 5.1 | 0.9 | 4.9 |
| 80 | | | | | | | | | | 1.0 | 5.6 | 1.0 | 0.9 | 5.3 | 0.9 | 5.0 |
| 90 | | | | | | | | | | | 1.0 | 5.6 | 1.0 | 5.6 | 1.0 | 5.4 |
| 100 | | | | | | | | | | | | 1.0 | 6.0 | 1.0 | 5.7 | |
| 110 | | | | | | | | | | | | | | 1.0 | 6.0 | |

Q = Flow, Cubic Feet per Second, V = Velocity, Feet per Second, b = Bottom Width, Feet, D = Depth, Feet.

Trapezoidal Channel Design
 "C" Retardance Grade 4 Percent Side Slope = 2:1
 Sheet 6 of 8

| Q cfs | Bottom Width, b, in Feet | | | | | | | | | | | | | | | |
|----------|--------------------------|-----|-------|-----|-------|-----|-------|-----|--------|-----|--------|-----|--------|-----|--------|-----|
| | b = 2 | | b = 4 | | b = 6 | | b = 8 | | b = 10 | | b = 12 | | b = 14 | | b = 16 | |
| | D | V | D | V | D | V | D | V | D | V | D | V | D | V | D | V |
| 15 | 1.0 | 4.0 | 0.8 | 3.6 | 0.7 | 3.2 | 0.6 | 2.8 | 0.5 | 2.4 | 0.5 | 2.2 | 0.5 | 2.0 | 0.5 | 1.8 |
| 20 | 1.1 | 4.6 | 0.8 | 4.2 | 0.7 | 3.8 | 0.6 | 3.3 | 0.6 | 3.0 | 0.6 | 2.7 | 0.5 | 2.5 | 0.5 | 2.3 |
| 25 | 1.1 | 5.1 | 0.9 | 4.8 | 0.8 | 4.3 | 0.7 | 3.8 | 0.6 | 3.5 | 0.6 | 3.1 | 0.6 | 2.9 | 0.5 | 2.7 |
| 30 | 1.2 | 5.6 | 1.0 | 5.2 | 0.8 | 4.7 | 0.7 | 4.3 | 0.7 | 3.9 | 0.6 | 3.6 | 0.6 | 3.3 | 0.6 | 3.0 |
| 35 | 1.3 | 5.9 | 1.0 | 5.6 | 0.9 | 5.1 | 0.8 | 4.7 | 0.7 | 4.3 | 0.7 | 3.9 | 0.6 | 3.6 | 0.6 | 3.4 |
| 40 | | | 1.1 | 5.9 | 0.9 | 5.4 | 0.8 | 5.0 | 0.8 | 4.6 | 0.7 | 4.2 | 0.6 | 3.9 | 0.6 | 3.7 |
| 45 | | | | | 1.0 | 5.8 | 0.9 | 5.4 | 0.8 | 4.9 | 0.7 | 4.6 | 0.7 | 4.3 | 0.6 | 4.0 |
| 50 | | | | | | | 0.9 | 5.6 | 0.8 | 5.2 | 0.8 | 4.9 | 0.7 | 4.6 | 0.7 | 4.2 |
| 55 | | | | | | | 0.9 | 5.9 | 0.8 | 5.5 | 0.8 | 5.1 | 0.7 | 4.8 | 0.7 | 4.5 |
| 60 | | | | | | | | | 0.9 | 5.8 | 0.8 | 5.4 | 0.8 | 5.0 | 0.7 | 4.8 |
| 65 | | | | | | | | | 0.9 | 6.0 | 0.8 | 5.6 | 0.8 | 5.3 | 0.7 | 5.0 |
| 70 | | | | | | | | | | | 0.9 | 5.9 | 0.9 | 5.5 | 0.8 | 5.2 |
| 75 | | | | | | | | | | | | | 0.9 | 5.7 | 0.8 | 5.4 |
| 80 | | | | | | | | | | | | | | 0.9 | 0.8 | 5.6 |
| 90 | | | | | | | | | | | | | | | 0.9 | 5.9 |

Q = Flow, Cubic Feet per Second, V = Velocity, Feet per Second, b = Bottom Width, Feet, D = Depth, Feet.

Trapezoidal Channel Design
Sheet 7 of 8

"C" Retardance Grade 5 Percent Side Slope 2:1

| Q cfs | Bottom Width, b, in Feet | | | | | | | | | | | | | | | |
|----------|--------------------------|-----|-------|-----|-------|-----|-------|-----|--------|-----|--------|-----|--------|-----|--------|-----|
| | b = 2 | | b = 4 | | b = 6 | | b = 8 | | b = 10 | | b = 12 | | b = 14 | | b = 16 | |
| | D | V | D | V | D | V | D | V | D | V | D | V | D | V | D | V |
| 15 | 0.9 | 4.4 | 0.7 | 3.9 | 0.6 | 3.4 | 0.6 | 3.0 | 0.5 | 2.6 | 0.5 | 2.3 | 0.5 | 2.1 | 0.5 | 2.0 |
| 20 | 1.0 | 5.1 | 0.8 | 4.6 | 0.7 | 4.1 | 0.6 | 3.6 | 0.6 | 3.2 | 0.5 | 2.9 | 0.5 | 2.7 | 0.5 | 2.4 |
| 25 | 1.1 | 5.6 | 0.9 | 5.2 | 0.7 | 4.6 | 0.6 | 4.2 | 0.6 | 3.7 | 0.6 | 3.4 | 0.5 | 3.1 | 0.5 | 2.9 |
| 30 | | | 0.9 | 5.6 | 0.8 | 5.1 | 0.7 | 4.6 | 0.6 | 4.2 | 0.6 | 3.9 | 0.6 | 3.5 | 0.5 | 3.3 |
| 35 | | | | | 0.8 | 5.5 | 0.7 | 5.1 | 0.7 | 4.6 | 0.6 | 4.2 | 0.6 | 3.9 | 0.6 | 3.6 |
| 40 | | | | | 0.9 | 5.9 | 0.8 | 5.4 | 0.7 | 5.0 | 0.7 | 4.6 | 0.6 | 4.3 | 0.6 | 4.0 |
| 45 | | | | | | | 0.8 | 5.7 | 0.7 | 5.3 | 0.7 | 5.0 | 0.6 | 4.6 | 0.6 | 4.3 |
| 50 | | | | | | | | | 0.8 | 5.6 | 0.7 | 5.3 | 0.7 | 4.9 | 0.6 | 4.6 |
| 55 | | | | | | | | | 0.9 | 6.0 | 0.7 | 5.5 | 0.7 | 5.2 | 0.7 | 4.9 |
| 60 | | | | | | | | | | | 0.8 | 5.8 | 0.7 | 5.4 | 0.7 | 5.1 |
| 65 | | | | | | | | | | | | | 0.7 | 5.7 | 0.7 | 5.3 |
| 70 | | | | | | | | | | | | | 0.8 | 5.9 | 0.7 | 5.6 |
| 75 | | | | | | | | | | | | | | | 0.7 | 5.8 |
| 80 | | | | | | | | | | | | | | | 0.8 | 6.0 |

Grade 6 Percent

| Q cfs | Bottom Width, b, in Feet | | | | | | | | | | | | | | | |
|----------|--------------------------|-----|-------|-----|-------|-----|-------|-----|--------|-----|--------|-----|--------|-----|--------|-----|
| | b = 2 | | b = 4 | | b = 6 | | b = 8 | | b = 10 | | b = 12 | | b = 14 | | b = 16 | |
| | D | V | D | V | D | V | D | V | D | V | D | V | D | V | D | V |
| 15 | 0.9 | 4.8 | 0.7 | 4.2 | 0.6 | 3.6 | 0.5 | 3.2 | 0.5 | 2.8 | 0.5 | 2.5 | 0.4 | 2.3 | 0.4 | 2.1 |
| 20 | 0.9 | 5.4 | 0.7 | 4.9 | 0.6 | 4.4 | 0.6 | 3.8 | 0.5 | 3.4 | 0.5 | 3.1 | 0.5 | 2.8 | 0.5 | 2.6 |
| 25 | | | 0.8 | 5.6 | 0.7 | 4.9 | 0.6 | 4.4 | 0.6 | 4.0 | 0.5 | 3.6 | 0.5 | 3.3 | 0.5 | 3.1 |
| 30 | | | | | 0.7 | 5.5 | 0.7 | 4.9 | 0.6 | 4.5 | 0.6 | 4.1 | 0.5 | 3.7 | 0.5 | 3.5 |
| 35 | | | | | 0.8 | 5.9 | 0.7 | 5.4 | 0.6 | 4.9 | 0.6 | 4.5 | 0.6 | 4.2 | 0.5 | 3.8 |
| 40 | | | | | | | 0.7 | 5.8 | 0.7 | 5.3 | 0.6 | 4.9 | 0.7 | 4.5 | 0.6 | 4.2 |
| 45 | | | | | | | | | 0.7 | 5.6 | 0.6 | 5.2 | 0.6 | 4.9 | 0.6 | 4.6 |
| 50 | | | | | | | | | | | 0.7 | 5.6 | 0.6 | 5.2 | 0.6 | 4.9 |
| 55 | | | | | | | | | | | 0.7 | 5.6 | 0.6 | 5.2 | 0.6 | 4.9 |
| 60 | | | | | | | | | | | 0.7 | 5.8 | 0.7 | 5.5 | 0.6 | 5.1 |
| 65 | | | | | | | | | | | | | 0.7 | 5.8 | 0.6 | 5.4 |
| 70 | | | | | | | | | | | | | | | 0.7 | 5.7 |
| | | | | | | | | | | | | | | | | 0.7 |
| | | | | | | | | | | | | | | | | 5.9 |

Q = Flow, Cubic Feet per Second, V = Velocity, Feet per Second, b = Bottom Width, Feet, D = Depth, Feet.

Trapezoidal Channel Design

Sheet 8 of 8

"C" Retardance Grade 8 Percent Side Slope = 2:1

| Q cfs | Bottom Width, b, in Feet | | | | | | | | | | | | | | | |
|----------|--------------------------|-----|-------|-----|-------|-----|-------|-----|--------|-----|--------|-----|--------|-----|--------|-----|
| | b = 2 | | b = 4 | | b = 6 | | b = 8 | | b = 10 | | b = 12 | | b = 14 | | b = 16 | |
| | D | V | D | V | D | V | D | V | D | V | D | V | D | V | D | V |
| 15 | 0.8 | 5.3 | 0.6 | 4.7 | 0.5 | 4.1 | 0.5 | 3.5 | 0.4 | 3.1 | 0.4 | 2.8 | 0.4 | 2.5 | 0.4 | 2.3 |
| 20 | | | 0.7 | 5.5 | 0.6 | 4.8 | 0.5 | 4.2 | 0.5 | 3.8 | 0.5 | 3.4 | 0.4 | 3.1 | 0.4 | 2.8 |
| 25 | | | | | 0.6 | 5.5 | 0.6 | 4.9 | 0.5 | 4.4 | 0.5 | 4.0 | 0.5 | 3.6 | 0.4 | 3.3 |
| 30 | | | | | 0.6 | 5.5 | 0.6 | 5.5 | 0.5 | 4.9 | 0.5 | 4.5 | 0.5 | 4.2 | 0.5 | 3.8 |
| 35 | | | | | 0.6 | 6.0 | 0.6 | 6.0 | 0.5 | 5.5 | 0.5 | 5.0 | 0.5 | 4.6 | 0.5 | 4.2 |
| 40 | | | | | | | 0.6 | 5.9 | 0.6 | 5.9 | 0.6 | 5.4 | 0.5 | 5.0 | 0.5 | 4.6 |
| 45 | | | | | | | | | | | 0.6 | 5.7 | 0.6 | 5.4 | 0.5 | 5.0 |
| 50 | | | | | | | | | | | | | 0.6 | 5.7 | 0.6 | 5.3 |
| 55 | | | | | | | | | | | | | | | 0.6 | 5.7 |
| 60 | | | | | | | | | | | | | | | 0.6 | 6.0 |

| Q cfs | Grade 10 Percent | | | | | | | | | | | | | | | |
|----------|------------------|-----|-------|-----|-------|-----|-------|-----|--------|-----|--------|-----|--------|-----|--------|-----|
| | b = 2 | | b = 4 | | b = 6 | | b = 8 | | b = 10 | | b = 12 | | b = 14 | | b = 16 | |
| | D | V | D | V | D | V | D | V | D | V | D | V | D | V | D | V |
| 15 | 0.7 | 5.9 | 0.6 | 5.1 | 0.5 | 4.4 | 0.4 | 3.8 | 0.4 | 3.4 | 0.4 | 3.0 | 0.4 | 2.6 | 0.4 | 2.4 |
| 20 | | | 0.6 | 6.0 | 0.5 | 5.2 | 0.5 | 4.6 | 0.4 | 4.1 | 0.4 | 3.7 | 0.4 | 3.4 | 0.4 | 3.1 |
| 25 | | | | | 0.6 | 6.0 | 0.5 | 5.3 | 0.5 | 4.7 | 0.4 | 4.3 | 0.4 | 3.9 | 0.4 | 3.6 |
| 30 | | | | | 0.6 | 5.9 | 0.6 | 5.9 | 0.5 | 5.3 | 0.5 | 4.9 | 0.5 | 4.4 | 0.4 | 4.1 |
| 35 | | | | | | | 0.6 | 5.8 | 0.5 | 5.8 | 0.5 | 5.4 | 0.5 | 4.9 | 0.5 | 4.6 |
| 40 | | | | | | | | | | | 0.5 | 5.8 | 0.5 | 5.3 | 0.5 | 5.0 |
| 45 | | | | | | | | | | | | | 0.5 | 5.7 | 0.5 | 5.4 |
| 50 | | | | | | | | | | | | | | | 0.5 | 5.7 |

Q = Flow, Cubic Feet per Second, V = Velocity, Feet per Second, b = Bottom Width, Feet, D = Depth, Feet.

APPENDIX F*

Sample Design Procedure for Riprap-Lined Channels

This design of riprap-lined channels is from the National Cooperative Highway Research Program Report No. 108, entitled "Tentative Design Procedure for Riprap-Lined Channels." It is based on the tractive force method and covers the design of riprap in two basic channel shapes, trapezoidal and triangular.

NOTE: This procedure is for the uniform flow in channels and is not to be used for design of riprap deenergizing devices immediately downstream from such high velocity devices as pipes and culverts. See the Standard and Specification for Storm Drain Outlet Protection.

The method in Report No. 108 (design procedure beginning on p. 18) gives a simple and direct solution to the design of trapezoidal channels including channel carrying capacity, channel geometry and the riprap lining. The publication is a very good reference and design aid.

The procedure presented in this Appendix is based on the assumption that the channel is already designed and the remaining problem is to determine the riprap size that would be stable in the channel. The designer would first determine the channel dimensions by the use of Manning's equation. The n value for use in Manning's equation is estimated by estimating a riprap size and then determining the corresponding n value for the riprapped channel from Curve 1, below.

Curve 1 - Manning's "n" for Riprap-Lined Channels
 $n = 0.0395(d_{50})^{1/6}$

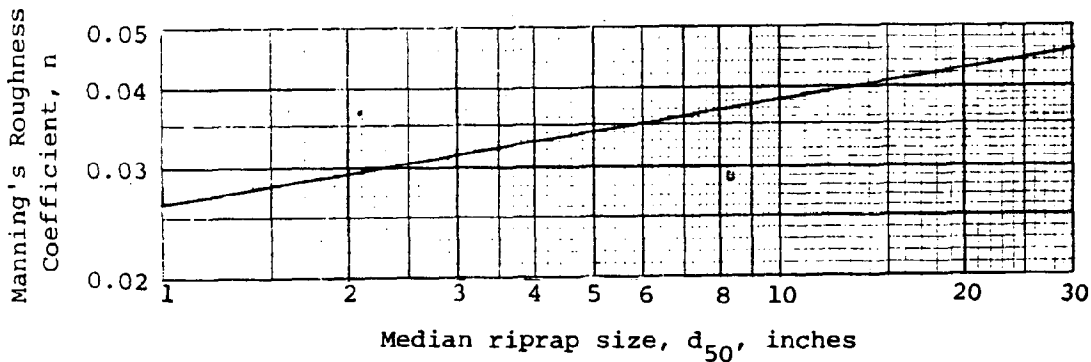

*from USDA, Soil Conservation Service, College Park, Maryland. Standards and Specifications for Soil Erosion and Sediment Control in Developing Areas. July 1975.

When the channel dimensions are known the riprap can be designed (or an already completed design may be checked) as follows:

Trapezoidal Channels

1. Calculate the b/d ratio and enter curve 2 to find the P/R ratio.
2. Enter curve 3 with $S_b, Q,$ and P/R to find median riprap diameter, d_{50} , for straight channels.
3. Enter curve 1 to find the actual n value corresponding to the d_{50} from step 2. If the estimated and actual n values are not in reasonable agreement another trial must be made.
4. For channels with bends, calculate the ratio B_s/R_o , where B_s is the channel surface width and R_o is the radius of the bend. Enter curve 4 and find the bend factor, F_B . Multiply the d_{50} for straight channels by the bend factor to determine riprap size to be used in bends. If the d_{50} for the bend is less than 1.1 times the d_{50} for the straight channel, then the size for straight channel may be used in the bend, otherwise the larger stone size calculated for the bend shall be used. The riprap shall extend across the full channel section and shall extend upstream and downstream from the ends of the curve a distance equal to five times the bottom width.
5. Enter curve 5 to determine maximum stable side slope of riprap surface.

Triangular Channels

1. Enter curve 3A with S_b, Q and Z and find the median riprap diameter, d_{50} , for straight channels.
2. Enter curve 1 to find the actual n value. If the estimated and actual n values are not in reasonable agreement another trial must be made.
3. For channels with bends, see step 4 under Trapezoidal channels.

The riprap size to be specified on the plans shall be the maximum stone size in the mixture which shall be 1.5 times the d_{50} . The thickness of the riprap layer is 1.5 times the maximum stone size, but not less than six inches. Freeboard shall be added to the channel depth and shall be not less than 0.2 times the depth of flow or 0.3 feet, whichever is greater.

Example:

Given:

Trapezoidal channel

$$Q = 100 \text{ cfs}$$

$$S = 0.01 \text{ ft/ft.}$$

Side slopes = 2.5:1

$$\text{Mean bend radius, } R_0 = 25'$$

$n = .033$ (estimated and used to design the channel to find that $b = 6'$
and $d = 1.8'$)

Type of rock available is crushed stone.

Solution:

Straight channel reach

$$b/d = 6/1.8 = 3.33$$

from curve 2, $P/R = 13.0$ from curve 3, $d_{50} = 3.4''$

from curve 1, n (actual) = 0.032, which is reasonably close to the
estimated n of 0.033.

$$\text{Maximum riprap size} = 1.5 \times 3.4 = 5.1''$$

$$\text{Riprap thickness} = 1.5 \times 5.1 = 7.7''$$

Use 5" as maximum riprap size and 8" as riprap layer thickness.

Channel bend

$$B_s = b + 2zd = 6 + (2)(2.5)(1.8) = 15'$$

$$B_s/R_0 = 12/25 = 0.60$$

from curve 4, $F_B = 1.33$

$F_B = 1.33 > 1.1$, therefore the bend factor must be used.

$$\text{Riprap size in bend, } d_{50} = 3.4 \times 1.33 = 4.52''$$

$$\text{Max. riprap size in bend} = 4.52 \times 1.5 = 6.78''$$

$$\text{Riprap thickness} = 10.2''$$

Use 7" for max. riprap size and 10" for riprap layer thickness.

The heavier riprap for the bend shall extend upstream and downstream
from the ends of the bend a distance of $(5)(6) = 30$ feet.

From curve 5, it can be found that the riprap for $d_{50} = 3.4''$ and
4.52" will both be stable on a 2.5:1 side slope.

$$\text{Freeboard} = (0.2)(1.8) = .36' \text{ but not less than } 0.3'$$

Therefore, minimum freeboard is 0.36'. Use 0.4'

P/R FOR TRAPEZOIDAL CHANNELS

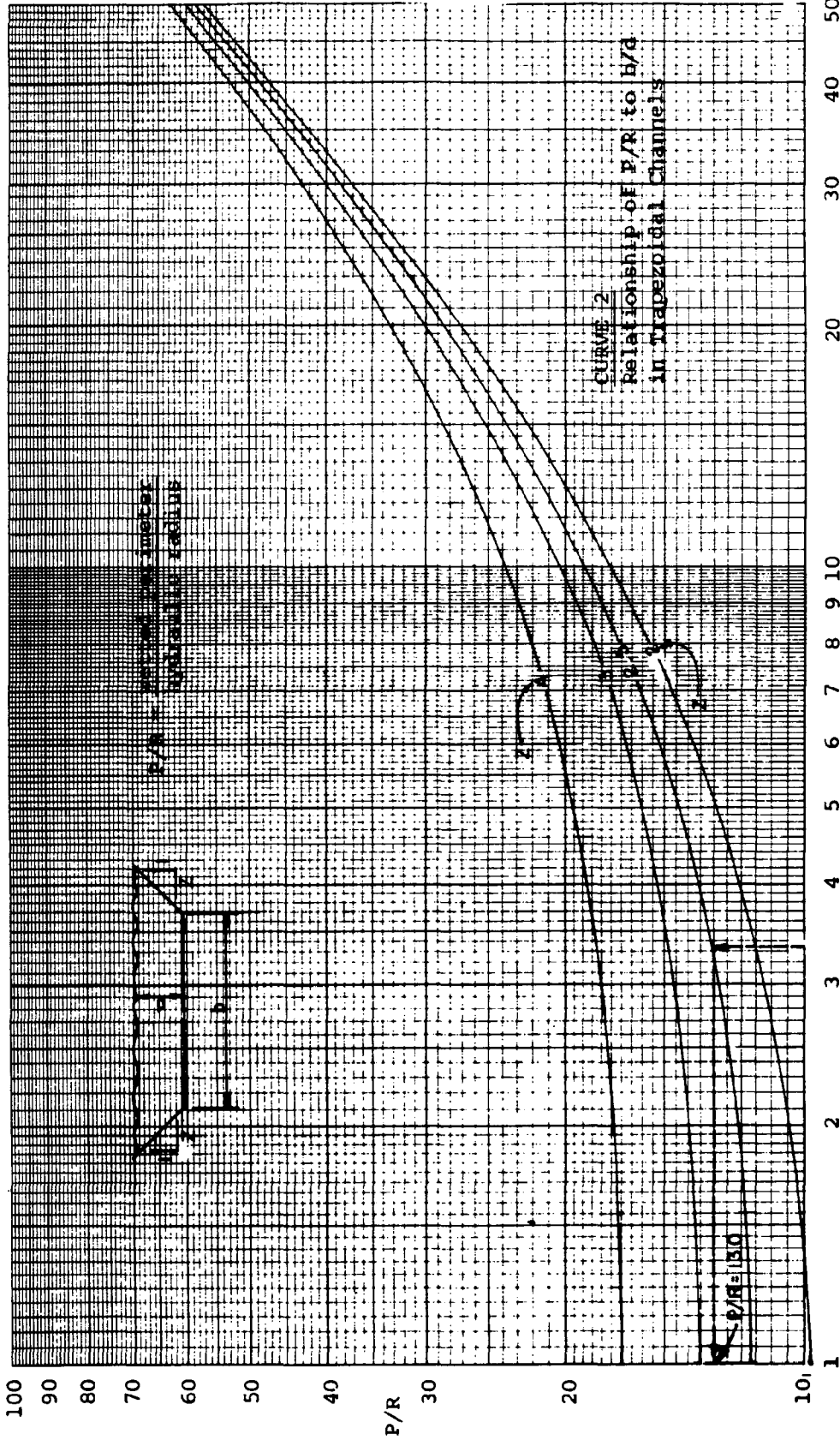

CURVE 2
Relationship of P/R to b/d
in Trapezoidal Channels

MEDIAN RIPRAP DIAMETER FOR STRAIGHT TRAPEZOIDAL CHANNELS

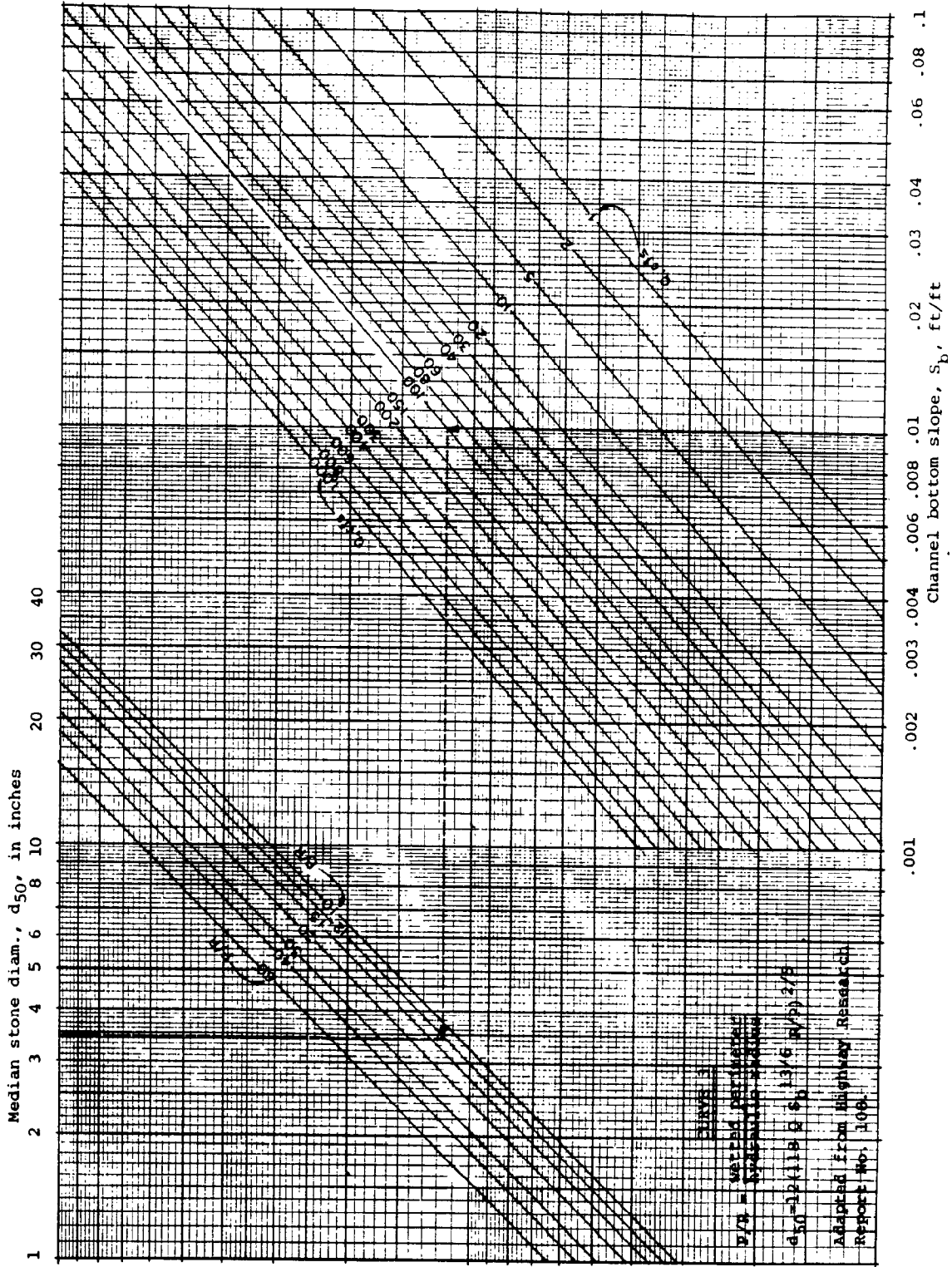

MEDIAN RIPRAP DIAMETER FOR STRAIGHT TRIANGULAR CHANNELS

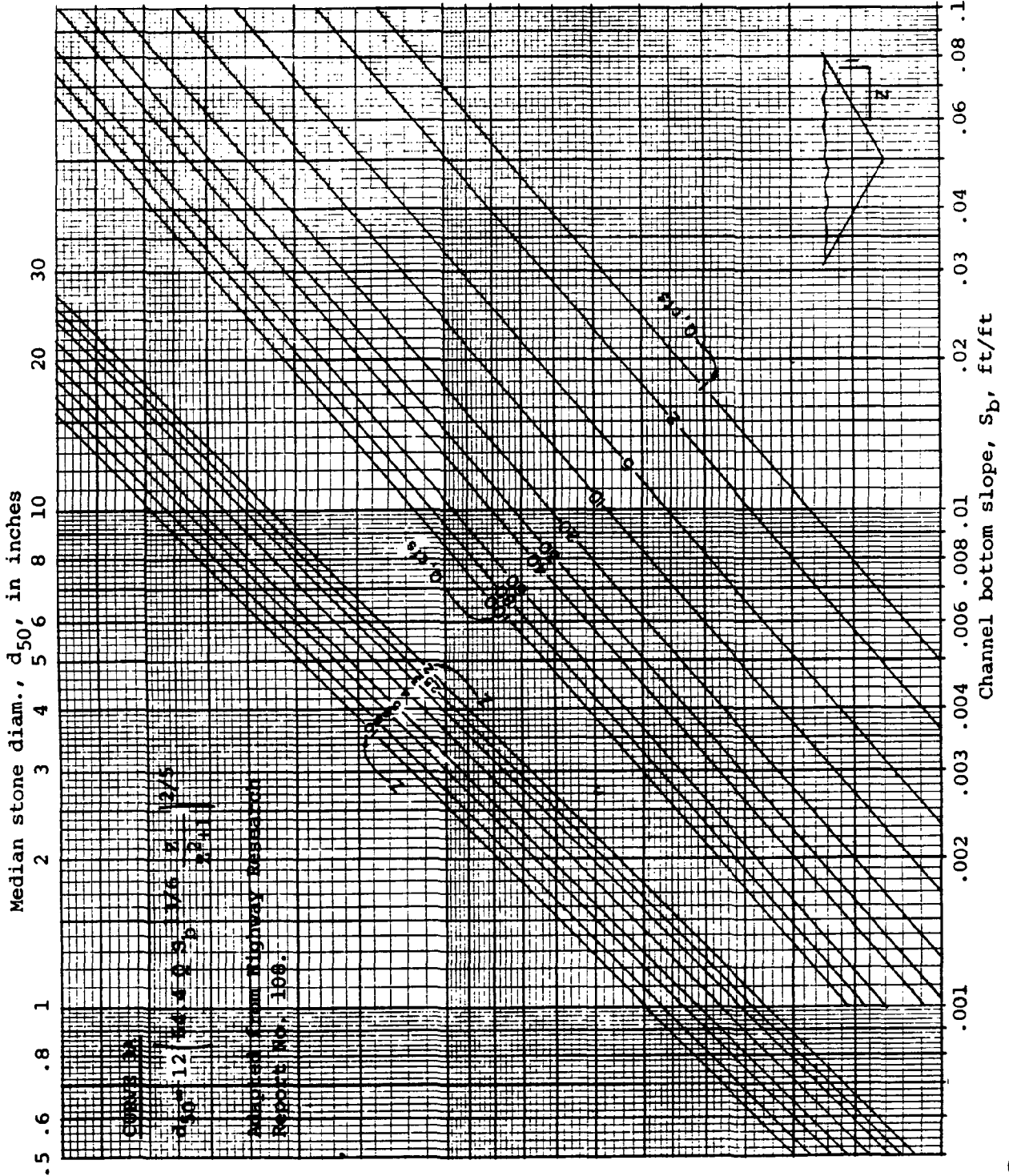

CURVE 4 - RIPRAP SIZE CORRECTION FACTOR FOR FLOW IN CHANNEL BENDS

$$d_{50}(\text{for bend}) = d_{50}(\text{for straight}) \times F_B$$

B_s = channel surface width

R_0 = mean radius of bend

Adapted from Highway Research Report No. 108.

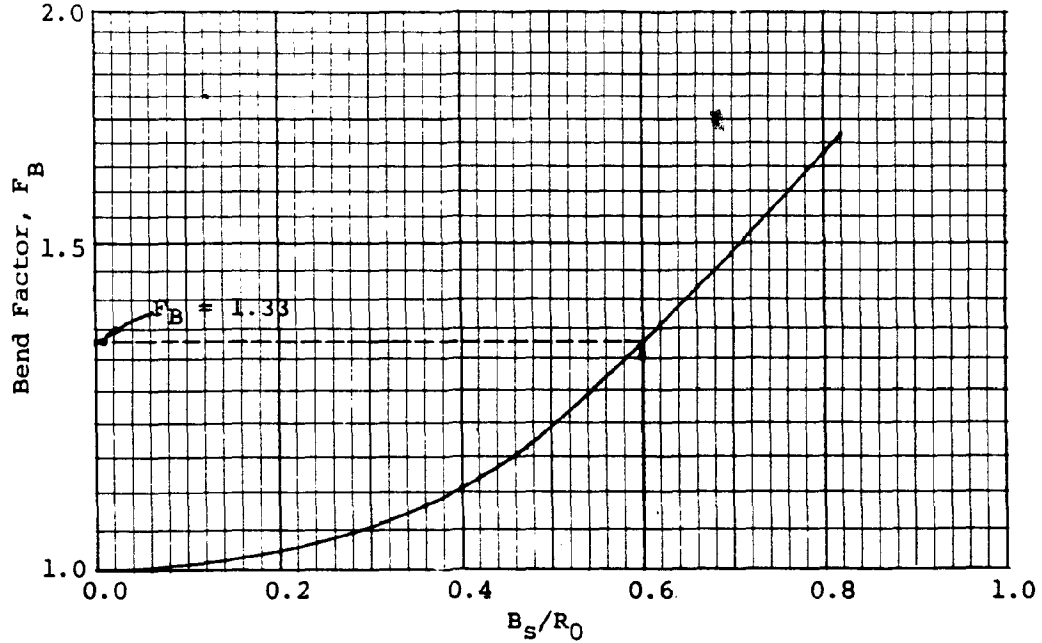

CURVE 5 - MAXIMUM RIPRAP SIDE SLOPE WITH RESPECT TO RIPRAP SIZE

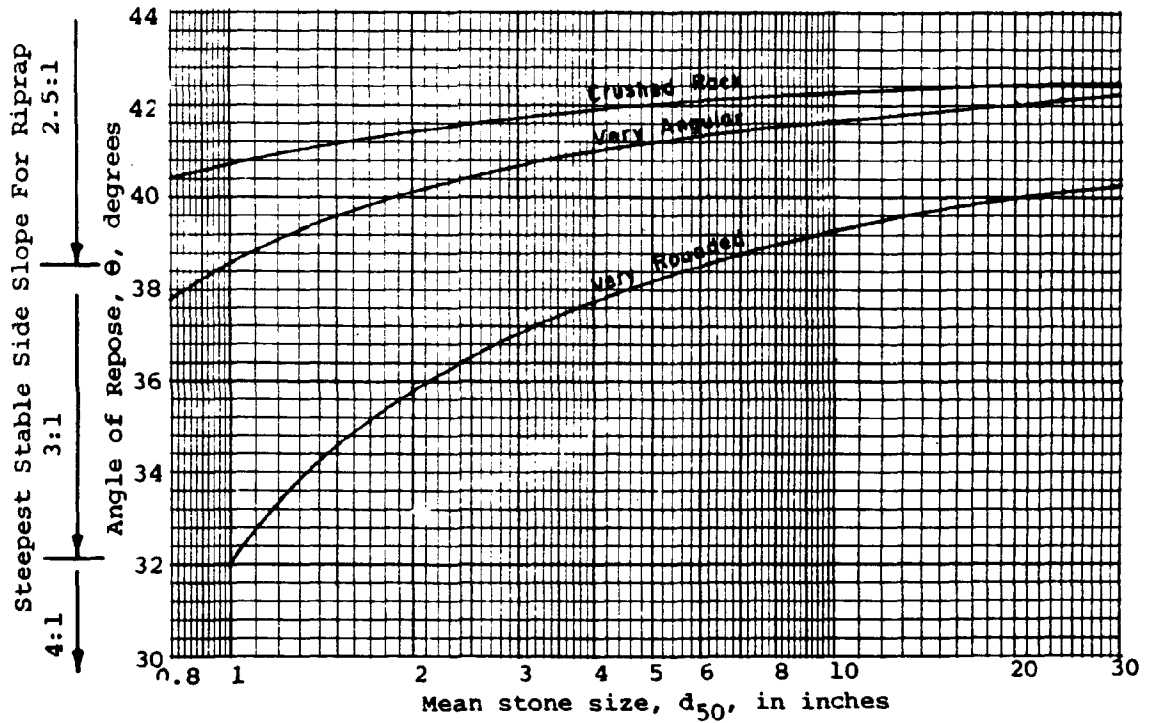

APPENDIX G*

Sample Design of Outlet Protection

Outlet protection as presented here is a level apron of sufficient length and flare such that the expanding flow (from pipe or conduit to channel) loses sufficient velocity and energy that it will not erode the next downstream channel reach. The design curves are based on circular conduits flowing full. The curves provide the apron size and if riprap is to be used, the minimum d_{50} size for the riprap. There are two curves, one for a low or minimum tailwater condition and the other a high or maximum tailwater condition. The minimum condition applies to a tailwater surface elevation less than the center of the pipe whereas the maximum condition applies to a tailwater surface elevation equal to or higher than the center of the pipe.

The first requirement in using this procedure is to determine the tailwater condition as required in the Standard and Specifications. Then, for circular conduits, enter the appropriate chart with the discharge and the pipe diameter to find the riprap size and apron length. Then calculate apron width.

Example 1:

A circular conduit is flowing full

$Q = 280$ cfs, diam. = 66", and tailwater (surface) is 2 ft. above pipe invert.

This is a minimum tailwater condition.

Read $d_{50} = 1.2'$, and apron length = 38'

Apron width = diam + $L_a = 38 + 5.5 = \underline{43.5'}$

Maximum stone size in the riprap mixture = $1.5 \times d_{50} = 1.5 \times 1.2 = \underline{1.8'}$.

The curves may also be used for the design of outlet protection for rectangular conduits but the procedure is slightly different. Depth of flow and velocity are the two flow parameters to be used. Enter the lower set of curves with velocity and depth (using the diameter curves for depth), then read to the right to find d_{50} and up and left for the length of apron. To find the apron width substitute conduit width for diameter in the apron width equations.

Example 2:

A concrete box 5.5' x 10' is flowing 5.0' deep, $Q = 600$ cfs and tailwater surface 5' above invert (Max. tailwater condition).

$$v = \frac{Q}{A} = \frac{600}{5.0 \times 10} = 12 \text{ fps}$$

At the intersection of the curve $d=60''$ and $V=12$ fps, read $d_{50} = 0.4'$.

Then reading up to the $d = 60''$ curve, read apron length = 40'.

Apron width, $W = \text{conduit width} + 0.04 L_a = 10 + (0.4)(40) = \underline{26'}$,

Largest stone size = $0.4 \times 1.5 = \underline{0.6'}$ or 7"

*from USDA, Soil Conservation Service, College Park, Maryland. Standards and Specifications for Soil Erosion and Sediment Control in Developing Areas. July 1975.

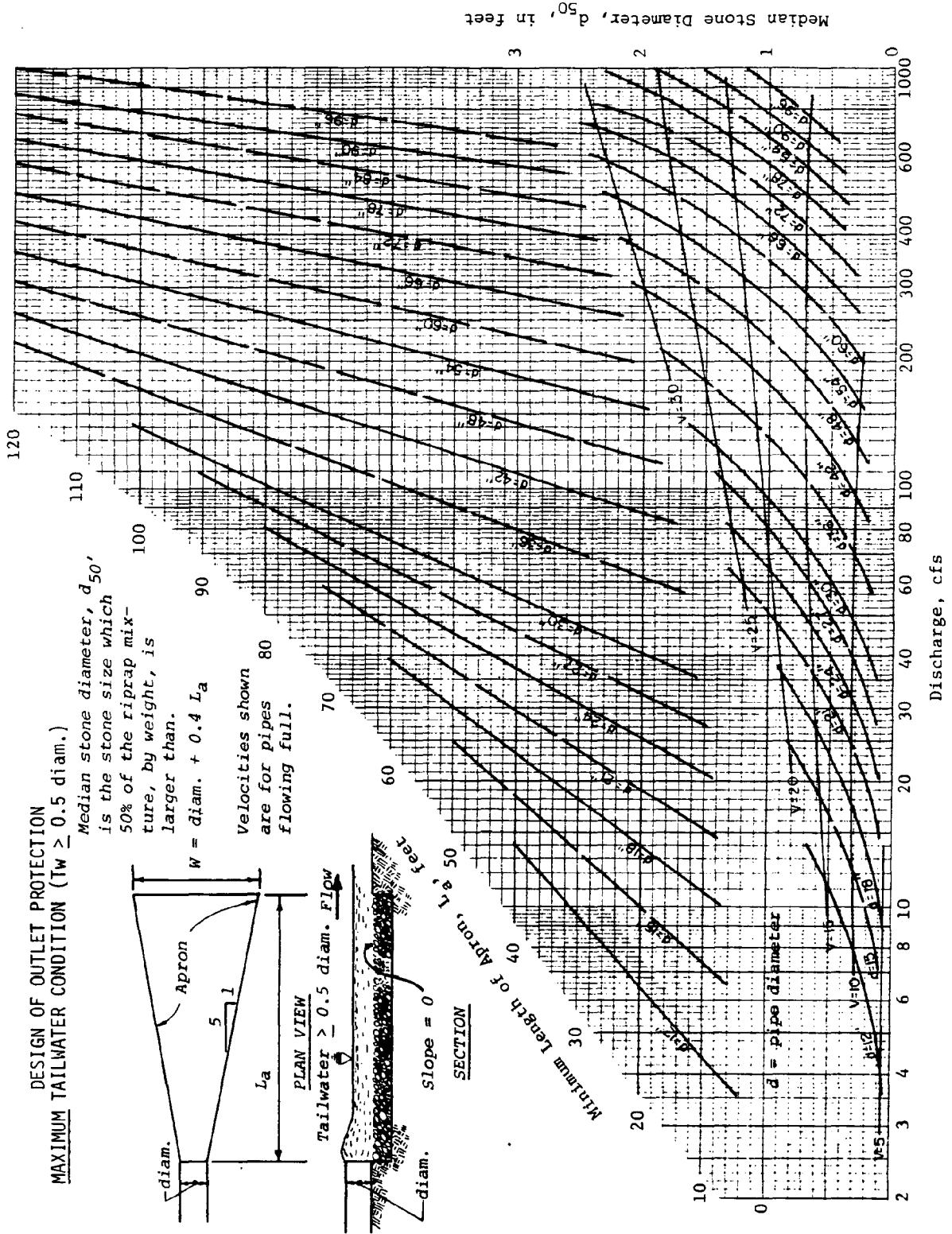

DESIGN OF OUTLET PROTECTION
MINIMUM TAILWATER CONDITION ($T_w < 0.5 \text{ diam.}$)

Median stone diameter, d_{50} , is the stone size which 50% of the riprap mixture, by weight, is larger than.

Velocities shown are for pipes flowing full.

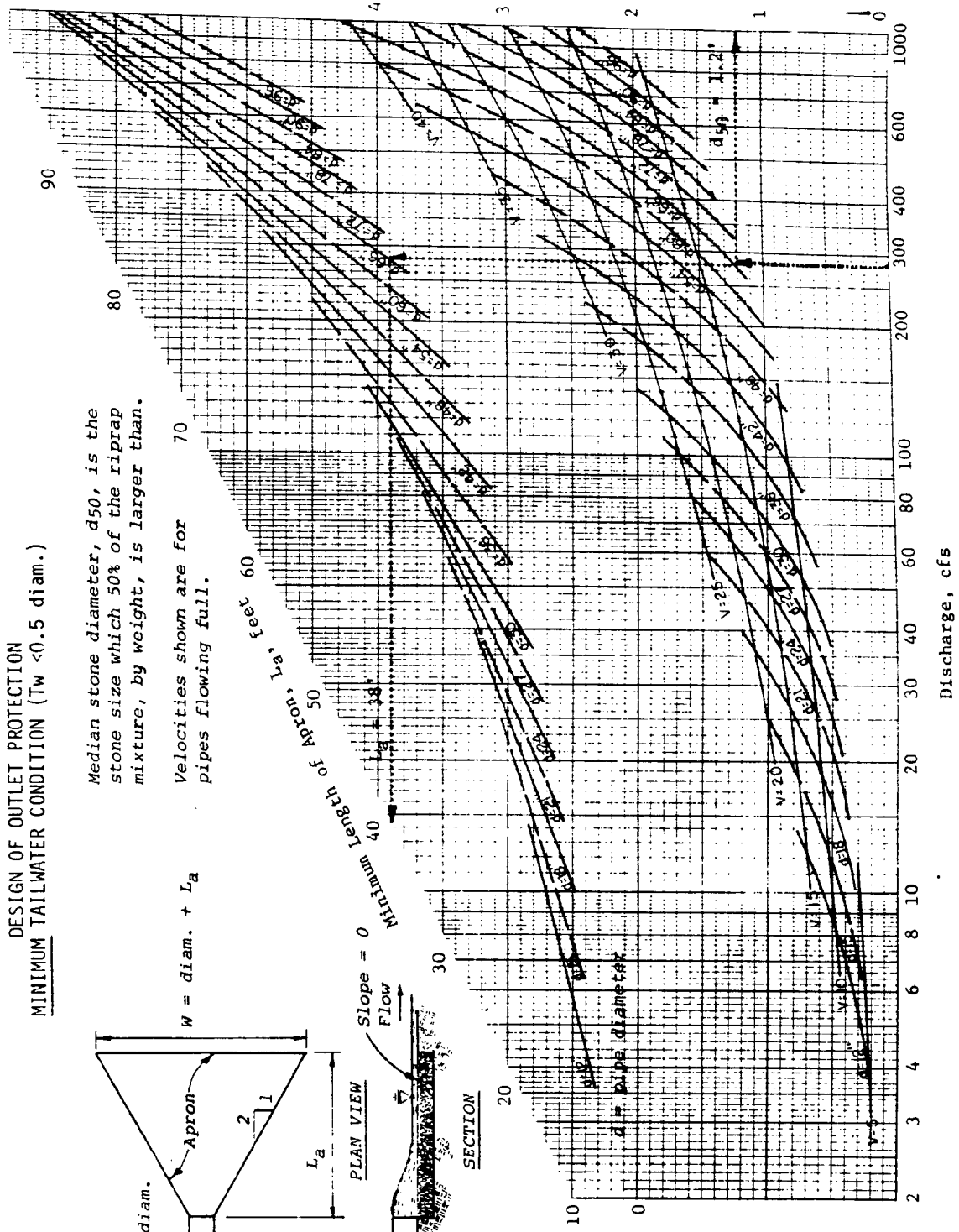
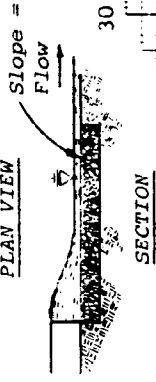
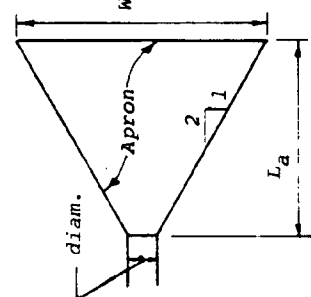

ACKNOWLEDGEMENTS

This manual was prepared under the direct supervision of Taras A. Bursztynsky, P.E., Water Quality Program Manager, ABAG.

The following individuals and organizations were major contributors:

| | |
|--------------------|--|
| Principal author | Steven J. Goldman, ABAG |
| Model ordinances | Kenneth Moy and Marc Lampe, legal consultants |
| Other contributors | Emily Silveira, Emy Chan, Katharine Jackson, Michael McMillan and Ross Turner, ABAG |
| Editing | Joyce McReynolds |

Special thanks are given to the following individuals and groups for their comments and assistance: Phillip Abel, Patrick Baker, Robert Crowell, Burgess Kay, Peter Rugerri and members of the Water Quality Technical Advisory Committee and the Bay Area Citizens Advisory Committee on Water Quality.

Additional thanks are given to Mark Boysen and the USDA, Soil Conservation Service office in College Park, Maryland, for laying the groundwork for the specifications for erosion and sediment control measures.

The preparation of this manual was funded in part by a grant from the U.S. Environmental Protection Agency.

