

DEVELOPMENT AND APPLICATION OF OPERATIONAL  
TECHNIQUES FOR THE INVENTORY AND MONITORING OF RESOURCES  
AND USES FOR THE TEXAS COASTAL ZONE

---

---

Peggy Harwood	The General Land Office 1700 North Congress Austin, Texas 78701
Robert Finley	Bureau of Economic Geology The University of Texas at Austin Austin, Texas 78712
Samuel McCulloch	Texas Natural Resources Information System Austin, Texas 78711
Patricia A. Malin	The General Land Office 1700 North Congress Austin, Texas 78701
John A. Schell	Remote Sensing Center Texas A&M University College Station, Texas 77840

October, 1977

TYPE III (FINAL REPORT)  
April, 1975 through October, 1977

VOLUME I: TEXT

prepared for:

GODDARD SPACE FLIGHT CENTER  
GREENBELT, MARYLAND 20771

---

---

GENERAL LAND OFFICE OF TEXAS

BOB ARMSTRONG, COMMISSIONER



QH  
541.15  
.M64  
H3  
1977  
v.1

Texas. General Land Office

This investigation was funded by National Aeronautics and Space Administration,  
Goddard Space Flight Center and the State of Texas through cost sharing.

TECHNICAL REPORT STANDARD TITLE PAGE

1. Report No.		2. Government Accession No.		3. Recipient's Catalog No.	
4. Title and Subtitle DEVELOPMENT AND APPLICATION OF OPERATIONAL TECHNIQUES FOR THE INVENTORY AND MONITORING OF RESOURCES AND USES FOR THE TEXAS COASTAL ZONE				5. Report Date September, 1977	
				6. Performing Organization Code	
7. Author(s) Peggy Harwood, Robert Finley, Samuel McCulloch Patricia A. Malin, John A. Schell, Texas A&M University				8. Performing Organization Report No.	
9. Performing Organization Name and Address General Land Office 1700 North Congress Austin, Texas 78701				10. Work Unit No.	
				11. Contract or Grant No. NAS5-20986	
12. Sponsoring Agency Name and Address Goddard Space Flight Center Mr. Fred Gordon Code 902 Greenbelt, Maryland 20771				13. Type of Report and Period Covered Type III (Final Report) April 25, 1975 through October 31, 1977	
				14. Sponsoring Agency Code	
15. Supplementary Notes <p style="text-align: center;">Property of CSC Library</p>					
16. Abstract Image-interpretation and computer-assisted techniques were developed to analyze Landsat scenes in support of resource inventory and monitoring requirements for the Texas coastal region. Land cover and land use maps, at a scale of 1:125,000 for the image-interpretation product and 1:24,000 for the computer-assisted product, were generated covering four Texas coastal test sites. Classification schemes which parallel national systems were developed for each procedure, including 23 classes for the image-interpretation technique and 13 classes for the computer-assisted technique. When compared to aerial photography, the mean accuracy for all image-interpretation maps was 87.5 percent; and for the computer-assisted maps, mean accuracy was 62 percent. These results suggest that further refinement of computer-assisted techniques and development of a classification scheme specifically for computer application are necessary. A cost-saving analysis on these Landsat map products indicated that for small area analysis (e.g., 200 square miles) image-interpretation maps would be less costly to the user, but over large areas with operational techniques, computer-assisted analysis would probably be less costly. Results indicate that Landsat-derived land cover and land use maps can be successfully applied to a variety of planning and management activities on the Texas coast. Computer-derived land/water maps can be used with tide gage data to assess shoreline boundaries for management purposes. Also, Landsat images can be used to monitor existing spoil areas and to evaluate proposed sites for the deposition of dredged materials along navigation channels.					
17. Key Words Suggested by Author				18. Distribution Statement U. S. DEPARTMENT OF COMMERCE NOAA COASTAL SERVICES CENTER 2234 SOUTH HOBSON AVENUE CHARLESTON, SC 29405-2413	
19. Security Classif. (of this report)		20. Security Classif. (of this page)		21. No. of Pages	22. Price

1 ex. 00. General Lane 11  
 QH 541.15 M64 H3 1977 v.1  
 26716900  
 SEP 30 1977

## PREFACE

One of the most significant opportunities for Texas natural resource agencies to test and utilize remote sensing technology has been the investigation of Landsat applications to General Land Office (GLO) needs in the coastal zone of Texas. The project was funded by a cost-sharing contract between the GLO and the National Aeronautics and Space Administration (NASA), and was supported by the Bureau of Economic Geology, the Texas Parks and Wildlife Department, and the Texas Natural Resources Information System (TNRIS). Accomplishments of this project include:

1. Development of a land cover and land use classification system representative of General Land Office needs throughout the Texas coast which can be supported by information derived from Landsat data.
2. Development of image-interpretation procedures and an interpretation guide for systematic extraction of information from Landsat imagery for generating land cover and land use maps at a scale of 1:125,000.
3. Development of procedures and software for computer-assisted analysis of Landsat digital data for generating land cover and land use maps that are scaled and registered to 1:24,000 USGS topographic maps.
4. Preparation of a cost-saving analysis comparing image-interpretation and computer-assisted analytical techniques, and an evaluation of the accuracy and comparative utility of products generated by both methods.

The utility of Landsat products with respect to specific General Land



Office concerns on the Texas coast includes the following:

1. For the study of tidal shorelines, a library of Landsat scenes would be extremely useful to supplement information gathered from visual observations and tide gage data regarding the areal extent of inundation over large areas. Such historical records of inundation are not now available for bay shorelines in Texas. Although these records could not replace ground surveys and tide gage measurements for determining legal boundaries, they could be used to estimate shoreline boundary locations for management purposes without additional ground surveys.
2. Monitoring spoil areas is important because navigation channels in Texas bays require continuous dredging, and more state-owned submerged lands and wetlands will be required for use as spoil disposal sites. Progress in enlarging the Corpus Christi and LaQuinta Ship Channels could be documented by the growth of adjacent barren spoil islands, detected on Landsat images. In addition, wetland areas in the vicinity of these channels could also be located and identified well enough to locate potential sites for future spoil disposal, so that areas containing seagrasses or marsh vegetation could be avoided.
3. For uses where the 1:125,000 scale maps were adequate, the image-interpretation product was preferred over the computer product because a more informative classification scheme was used, and the overall accuracy was higher.
4. Computer-assisted classification products, however, have the advantage of insuring that no data are overlooked. For example, a small area of vegetation on a spoil island was not visually

mapped from the imagery but was delineated by the computer analysis as grassland vegetation using spectral data only. Such vegetated spoil islands often become important rookeries for coastal birds and are protected by the state.

5. Where 1:24,000 scale maps are required, the computer-assisted product can satisfy this need, whereas image-interpretation products are not adequate.
6. In addition, the computer display is scaled and registered to USGS 7 1/2-minute topographic maps. This registered display is an advantage when used with a series of plastic overlays prepared at scale of 1:24,000 and showing state-owned coastal lands, because correlation with existing map data is improved.

Experience with this Landsat investigation has led to the following conclusions and observations:

1. Landsat, with its unique vantage point, inexpensive data products, repetitive coverage, and variety of formats, is an important data source for inventorying coastal resources when combined with other data sources such as climatic data and aerial photographs.
2. Through the opportunity provided by this project, Texas agencies have developed a capability for utilizing sophisticated remote sensing techniques and have developed a competent remote sensing data handling and ordering capability within TNRIS.
3. Several state agencies have shown that they can work together effectively in solving common problems, and such cooperation allows the existing expertise in each agency to be utilized.
4. Products generated through this investigation have stimulated numerous requests to TNRIS from state agencies to evaluate possible

applications of Landsat to other resource problems. Thus, TNRIS is proving to be an effective technology transfer mechanism.

5. The investigation has represented an important first step towards achieving the longer-term objective of incorporating satellite and other remote sensing technology with other data sources into an operational system for statewide inventory and monitoring of natural resources.

It should be noted that capabilities now available as a result of the Landsat study, particularly with regard to streamlining computer-assisted techniques, are not yet completely adequate for operational implementation to support requests of state agencies. The deficiencies lie primarily in the area of timely processing of data for large areas and in providing a readily available, useful product for delivery to the requesting agency. Necessary improvements would likely include the addition of hardware for "interactive" processing of imagery and other data, and software for image enhancement and for integration of the various proposed subsystems and existing TNRIS capabilities.

The level of funding for this current Landsat investigation is summarized on the following page.

TOTAL BUDGET - LANDSAT INVESTIGATION #23790 BY CATEGORIES

		<u>NASA<sup>1</sup></u> <u>CONTRIBUTION</u>	<u>STATE<sup>2</sup></u> <u>CONTRIBUTION</u>
<u>Labor</u>	GLO	\$ 44,840.00	\$ 24,000.00
	TNRIS	23,939.00	7,000.00
	BEG	34,641.00	X
	P&W	10,523.00	X
<u>Overhead</u>	GLO	847.00	5,800.00
	P&W	122.00	X
	TNRIS		2,000.00
	BEG	1,697.00	X
<u>Equipment</u>	TNRIS	X	X
	BEG	6,475.00	X
	P&W	X	X
<u>Map Repro.</u>	GLO	5,199.00	
	TNRIS	X	500.00
	P&W	X	X
<u>Travel</u>	GLO	2,718.00	1,700.00
	TNRIS	X	940.00
	BEG	1,343.00	X
	P&W	1,584.00	X
<u>Computer</u>	TNRIS	3,682.00	9,000.00
<u>Consulting</u>		15,000.00	X
TOTAL		\$152,610.00	\$ 55,940.00

<sup>1</sup>Original contract amount: \$158,145.00.

<sup>2</sup>Estimates provided by each agency for the investigation period June 1975 through August 1977. Additional GLO staff time contributed September through December for printing final report.

## Acknowledgements

The project team for this investigation included staff from the General Land Office (GLO); the Texas Natural Resources Information System (TNRIS); the University of Texas, Bureau of Economic Geology (BEG); and the Texas Parks and Wildlife Department (TPWD).

Peggy Harwood coordinated the investigation for the General Land Office. Patricia A. Malin compiled the cost data and prepared the economic analysis. Delores Seaton managed the project budget, as well as typed and supervised reproduction of all project reports. John Gosdin of the Governor's Office assisted the General Land Office with state coordination and project design.

Dr. Robert Finley provided the research and documentation of image-interpretation techniques for the Bureau of Economic Geology. Dr. Finley was assisted by Robert W. Baumgardner, Jr., as project research assistant, and also by Sam Shannon. Dr. E.G. Wermund critically reviewed BEG manuscripts, and editorial assistance was provided by Karen White. Final map preparation was done by Claudia Farmer under the direction of J.W. Macon. Text of the final documentation from the Bureau of Economic Geology was typed by Mary Hall.

Sam McCulloch coordinated the data handling support to this investigation and the development of computer-assisted techniques that were provided by staff of TNRIS Systems Central. Bill Hupp used the computer software to establish a set of operating procedures for generating land cover and land use maps. David Murphy developed all of the software needed to supplement the original programs obtained from NASA and also assisted in developing the analysis procedures. Dr. Charles Palmer, Roger Merschbrock, and Mike Ellis developed the data handling system. TNRIS draft manuscripts were typed by

Mamie Villanueva, Vangie Arzola, Terri Turek, and Jackie Favors.

Jim Stevens and Tom Moore coordinated the biological field support for the Texas Parks and Wildlife Department. Larry Lodwick prepared the field sampling methodology used in this project. George Clements coordinated all aspects of collecting field data for TPWD, as well as travelled to Austin from the coast on several occasions to attend project meetings.

Mr. Clements also prepared all TPWD field documentation.

Dr. John A. Schell from the Texas A&M University Remote Sensing Center and Dr. Robert K. Holz from the University of Texas at Austin, Department of Geography, provided assistance and critical review throughout the project as consultants on remote sensing techniques. Dr. Schell prepared the analysis of classification accuracy for map products derived from the computer-assisted techniques. In addition, Dr. Holz organized and led the initial orientation field trip to the San Antonio Bay area on the central Texas coast for project participants. This field trip proved invaluable in training team members who had little or no background in remote sensing.

Special appreciation is extended to Fred Gordon, Technical Monitor, and to Donna Throne, Contracting Officer, both of Goddard Space Flight Center, for their attention and efficient support to the details of this contract. Working with them has been a distinct pleasure. We would also like to express appreciation to personnel of the NASA Johnson Space Center, Texas Applications Project, who provided considerable assistance and advice in developing the computer-assisted analysis techniques.

Finally, recognition is also given to members of the Remote Sensing Task Force, the Texas Natural Resources Information System Task Force, and staff of participating agencies, whose continued interest and support were essential to this project. Many of the ideas in the original proposal

for this investigation were contributed by David Ferguson, TNRIS Task Force Secretary, and Dr. E.G. Wermund, Bureau of Economic Geology. Ray Childress participated in the writing of the proposal for the Texas Parks and Wildlife Department. Ward Goessling and John Wells of the Governor's Office spent many hours editing and assisting the state coordination of the proposal. Wayne D. (Red) Oliver accepted the responsibility of preparing the project proposal on behalf of the General Land Office and coordinated the contract negotiations with NASA.

The final manuscript was organized by Delores Seaton, with typing assistance from Lucia Doyle, Cathy Kilpatrick, Marvel Connell, and Chris Looney. Muriel Wright edited the final manuscript, and John Macklin worried about it all!

## TABLE OF CONTENTS

	<u>Page</u>
1.0 INTRODUCTION AND BACKGROUND	1
1.1 <u>Remote Sensing</u>	1
1.2 <u>Development of Texas Remote Sensing Activities</u>	1
1.3 <u>Texas Coastal Zone Management Requirements</u>	3
1.4 <u>Indirect Benefits of This Investigation</u>	5
2.0 OBJECTIVES	
2.1 <u>Objectives and Information Priorities</u>	5
2.2 <u>Anticipated Results</u>	8
3.0 METHODS AND APPROACH	9
3.1 <u>Overview of the Investigation Approach</u>	9
3.2 <u>Project Management</u>	12
3.2.1 <u>Organization</u>	12
3.2.2 <u>Coordination</u>	14
3.2.3 <u>Schedule</u>	14
3.3 <u>Data Handling Procedures</u>	16
3.3.1 <u>Introduction</u>	16
3.3.2 <u>Data Specification</u>	17
3.3.3 <u>Data Inquiry</u>	21
3.3.4 <u>Data Ordering</u>	23
3.3.5 <u>Indexing</u>	23
3.3.6 <u>Distribution</u>	24
3.4 <u>Ground Truth and Support Data</u>	24
3.4.1 <u>Updating the Coastal Atlas to Provide a Regional Base for the Texas Coast</u>	24
3.4.2 <u>Ground Truth and Field Verification</u>	25
3.5 <u>Test Sites</u>	28



TABLE OF CONTENTS (Con't)

	<u>Page</u>
4.0 CLASSIFICATION SCHEMES FOR USE WITH LANDSAT DATA	33
4.1 <u>Development of a Land Cover and Land Use Classification Scheme</u>	33
4.2 <u>Land Cover and Land Use Classification for Computer-Assisted Analysis</u>	38
5.0 COMPUTER-ASSISTED ANALYSIS	41
5.1 <u>Analytical Techniques</u>	42
5.1.1 <u>Introduction</u>	42
5.1.2 <u>Software Support</u>	42
5.2 <u>Analytical Procedures</u>	51
5.2.1 <u>Site Classification</u>	51
5.2.2 <u>Change Detection</u>	70
5.2.3 <u>Boundary Extraction</u>	72
5.3 <u>Computer-Assisted Analysis of Test Site 4</u>	72
5.4 <u>Classification Results</u>	80
5.5 <u>Change Detection Results</u>	80
6.0 IMAGE-INTERPRETATION ANALYSIS	87
6.1 <u>Development of Image-Interpretation Techniques</u>	87
6.1.1 <u>The Optical Interpretation Procedure</u>	88
6.1.2 <u>An Image Analysis Schedule</u>	89
6.1.3 <u>Problems Associated with a Poor-Quality False-Color Composite</u>	92
6.2 <u>Development of Image-Interpretation Techniques for Change Detection</u>	93
6.3 <u>Discussion of Image-Interpretation Results for Test Sites 2, 3, 5, and 4 with Ground Truth</u>	95
6.3.1 <u>Analysis of Test Site 2</u>	95

TABLE OF CONTENTS (Con't)

	<u>Page</u>
6.3.2 <u>Analysis of Test Site 3</u>	101
6.3.3 <u>Analysis of Test Site 5</u>	115
6.3.4 <u>Analysis of Test Site 4</u>	120
6.3.5 <u>Summary of Test Site Results</u>	130
7.0 EVALUATION OF CLASSIFICATION ACCURACY FOR IMAGE-INTERPRETATION AND COMPUTER MAP PRODUCTS	142
7.1 <u>Accuracy of Image Interpretation</u>	142
7.1.1 <u>Procedures</u>	142
7.1.2 <u>Image-Interpretation Accuracy Results for All Four Test Sites</u>	143
7.1.3 <u>Summary of Image-Interpretation Accuracy for Test Site 4, Harbor Island Area</u>	146
7.2 <u>Accuracy of Computer Classification</u>	147
7.2.1 <u>Introduction</u>	147
7.2.2 <u>Comparison Procedure for Computer Classification</u>	150
7.2.3 <u>Correlation Sampling for Determining Computer- Classification Accuracy</u>	159
7.2.4 <u>Automatic Correlation Procedures as One Method to Assign Interpretation Classes to Computer Classes</u>	161
8.0 APPLICATION OF LANDSAT PRODUCTS TO MANAGEMENT ACTIVITIES	166
8.1 <u>Objectives for the Test and Evaluation of Analytical Techniques in Site 4</u>	166
8.2 <u>Information from Landsat Products</u>	169
8.2.1 <u>Inundation of Tidal Flats, Marshes, and Bay Margins</u>	169
8.2.2 <u>Spoil Islands</u>	172
8.2.3 <u>Land Cover Conditions and Changes</u>	173
8.3 <u>Summary of Findings</u>	174

TABLE OF CONTENTS (Con't)

	<u>Page</u>
9.0 ECONOMIC ANALYSIS OF LANDSAT MAP PRODUCTS	176
9.1 <u>Overview</u>	176
9.1.1 <u>Introduction</u>	176
9.1.2 <u>Costs of Production of Landsat Map Products and Demand</u>	177
9.1.3 <u>Cost-Saving Study</u>	180
9.1.4 <u>Plan of the Economic Analysis</u>	181
9.2 <u>Costs of Production of Landsat Map Products by Image-Interpretation and Computer-Classification Methods</u>	181
9.2.1 <u>Record-Keeping and Estimation Method</u>	181
9.2.2 <u>Data Acquisition Costs</u>	184
9.2.3 <u>Data-Interpretation Costs of Image Interpretation</u>	188
9.2.4 <u>Data-Interpretation Costs of Computer-Assisted Analysis</u>	192
9.2.5 <u>Data Display Costs</u>	197
9.2.6 <u>Office Space, Equipment, and Materials</u>	199
9.2.7 <u>Total Costs of Map Production and the Effects of Data Display</u>	203
9.3 <u>Costs of the Hypothetical Map Produced by Conventional Interpretation of Aerial Photography</u>	207
9.3.1 <u>Introduction</u>	207
9.3.2 <u>The Questionnaire</u>	209
9.3.3 <u>Assumptions, Computations, and Results</u>	209
9.4 <u>The Cost-Saving Analysis</u>	216
9.4.1 <u>Introduction</u>	216
9.4.2 <u>The Comparison in Costs</u>	217
9.5 <u>Conclusions</u>	221
10.0 DISCUSSION OF ACCOMPLISHMENTS AND CONCLUSIONS	
10.1 <u>A Quasi-Operational Coastal Zone Resources Monitoring System</u>	222

TABLE OF CONTENTS (Con't)

	<u>Page</u>
10.2 <u>A Documented Cost-Benefit Analysis of the System Developed</u>	225
10.3 <u>A Remote Sensing Software and Data Handling Library Available to the State of Texas for Further Work</u>	226
10.4 <u>A Complete Base Map of Coastal Zone Features Being Studied, and the Beginning of a Historical Library of Temporal Changes Along the Coast</u>	227
10.5 <u>A Documented Analysis of the Performance of Image Interpretation vs. Digital Processing, and the Various Algorithms in Digital Processing, with Respect to Monitoring Coastal Zone Features</u>	227
10.6 <u>Conclusions Relating to Image Interpretation of Landsat Imagery</u>	229
10.7 <u>Conclusions Relating to Computer-Assisted Analysis of Landsat Computer-Compatible Tapes (CCT's)</u>	232
10.8 <u>Recommendations</u>	234
REFERENCES	236

## LIST OF FIGURES

<u>Number</u>	<u>Title</u>	<u>Page</u>
1	Summary organization chart for Landsat Investigation #23790.	13
2	An example of the overlay updating the Environmental Geology Map covering the Harbor Island area (test site 4).	26
3	Wind data prior to the 29 March 1974 image.	29
4	Precipitation and temperature data for the Texas coastal zone.	30
5	Project test site locations.	32
6	Circuit diagram derived from HGROUP program output.	46
7	Sample sequential tree derived from HGROUP program.	47
8	Stepwise hierarchical tree derived from HGROUP program.	48
9	Example of PICTAB display.	55
10	Portion of the USGS topographic map corresponding to the area of the PICTAB display in fig. 9.	56
11	ELLTAB classification assuming 30 clusters as an example.	60
12	Portion of Landsat scene depicting area mapped by the DAM package in fig. 13.	61
13	Example of display from Detection and Mapping (DAM) package showing two categories: water and "other."	62
14	Plot of spectral means derived from ISOCLS results.	63
15a & b	Examples of imagery used for correlation.	66
16	Classification display before using MR-CLEAN.	68
17	Classification display after processing with MR-CLEAN.	69
18	Refinement illustrations.	71
19	Portions of Landsat scenes corresponding to change detection displays (figs. 20-22).	73
20	Part of the classification display of test site 4 near Port Ingleside on the Corpus Christi Ship Channel, 25 February 1975 (scene 1, 2034-16202).	74

LIST OF FIGURES (Con't)

<u>Number</u>	<u>Title</u>	<u>Page</u>
21	Same area as fig. 20, but 6 months later on 10 July 1975 (scene 3, 5082-16080).	75
22	Change detection comparing scene 1 to scene 3.	76
23	Example of boundary map and corresponding display map portion.	77
24	Test site 4 ISOCLS training areas.	79
25	Seischrome <sup>TM</sup> display of test site 4.	81
26	Seischrome <sup>TM</sup> display of test site 4.	82
27	Seischrome <sup>TM</sup> display of test site 4.	83
28	Seischrome <sup>TM</sup> display of test site 4.	84
29	Image-interpretation line boundary map of part of test site 3, Pass Cavallo area.	90
30	Schematic diagram of change detection procedure based on observed radiance differences.	94
31	Unclassified line boundary map of the Freeport-San Luis Pass test site.	97
32	San Luis Pass area, test site 2, with classified land and water units delineated from Landsat scene 1289-16261, 8 May 1973.	98
33	Freeport area, test site 2, with water units unclassified except for transportation (dredged canals or maintained river channel), delineated from Landsat scene 1289-16261, 8 May 1973.	100
34	Geographic features in the vicinity of test site 3.	102
35	Unclassified line boundary map of test site 3 from 29 March 1974 imagery.	105
36	Unclassified line boundary map of test site 3 from 25 February 1975 imagery.	106
37	Pass Cavallo area with water units unclassified, except for transportation (dredged channels), and land units classified from Landsat scene 2034-16200, 25 February 1975.	107

LIST OF FIGURES (Con't)

<u>Number</u>	<u>Title</u>	<u>Page</u>
38	Map showing change in area of emergent marsh, tidal flats, and beach at Pass Cavallo owing to wind tide of 25 February 1975.	110
39	Guadalupe River delta area with classified land and water units, delineated from Landsat scene 1614-16261, 29 March 1974.	112
40	Unclassified line boundary map of the southern Padre Island-Laguna Madre test site.	116
41	Brazos Santiago Pass area with classified land and water units delineated from Landsat scene 2034-16205, 25 February 1975.	118
42	Geographic features in test site 4.	121
43	Unclassified line boundary map of the Harbor Island test site, 25 February 1975.	123
44	Unclassified line boundary map of the Harbor Island test site, 10 July 1975.	124
45	Unclassified line boundary map of the Harbor Island test site, 2 February 1976.	125
46	Unclassified line boundary map of the Harbor Island test site, 16 December 1972.	126
47	Aransas Pass area with classified land and water units delineated from Landsat scene 2034-16202, 25 February 1975.	128
48	Summary of recent dredge spoil additions along channels in the Harbor Island test site.	136
49	Sequence of dredge spoil additions in the Harbor Island area.	137
50	Radiance changes detected between February and July scenes in the Harbor Island test site.	140
51	Summary of interpretation accuracy for all categories in the Harbor Island area test site.	148
52	Location of areas within Harbor Island area for comparing classification results of Landsat scenes.	168

LIST OF FIGURES (Con't)

<u>Number</u>	<u>Title</u>	<u>Page</u>
53	Portion of test site 4 as depicted on the Detection and Mapping (DAM) display with an overlay showing the numbered state-owned tracts and USGS topographic information.	170
54	Scheme of production and delivery of products from a Landsat operational system illustrating components of cost and demand.	178



## LIST OF TABLES

<u>Number</u>	<u>Title</u>	<u>Page</u>
1	Priority I: Features of the Wetlands	6
2	Priority II: Features of Land Cover and Land Use Conditions Adjacent to Coastal Waters	7
3	Priority III: Features of the Beach and Associated Sands	7
4	Priority IV: Estuaries and Related Phenomena	8
5	Generalized Schedule for Landsat Investigation #23790	15
6	Data Requirements to Support Landsat Investigation	18
7	Land Cover and Land Use Classification for Use with Unenhanced Landsat Data in the Texas Coastal Zone	35
8	Land Cover and Land Use Classification for Use with Landsat Computer-Compatible Tapes	40
9	Steps Required in Site Classification Using Computer-Assisted Techniques	52
10	Assigned Parameter Values	58
11	Landsat Scenes for Test Site 4	72
12	LARSYS/ISOCLS Parameters	78
13	Summary of Control Network Parameters	78
14	Summary of Land Cover and Land Use Classes Derived from the Four Landsat Scenes of Test Site 4	85
15	Summary of Site Conditions at Time Landsat Scene Was Imaged	86
16	Evaluation Review Schedule for Image-Interpretation Analysis	91
17	Vegetation Transects in the Low Marshes at Pass Cavallo	108
18	Vegetation Transects in the Upper San Antonio Bay Marshes	113
19	Landsat Images Used in Dredge Spoil Study	135
20	Results of Accuracy Tests by Stratified Random Sampling; All Images for All Test Sites	144

LIST OF TABLES (Con't)

<u>Number</u>	<u>Title</u>	<u>Page</u>
21	Results of Accuracy Test by Stratified Random Sampling; First Images Mapped for All Test Sites	145
22	Accuracy Analysis of Landsat Image-Interpretation Map Products, Harbor Island Test Site	147
23	Computer and Image-Interpretation Class Correlation, 25 Feb. 1975	153
24	Computer Classification Accuracy from Comparison with Image Interpretation, 25 Feb. 1975	155
25	Realignment of Classes into Urban (U), Agriculture (A), Upland Vegetation (Up), Water (WA), Wetlands (W), and Barren (B), 25 Feb. 1975	157
26	Summary of Accuracy Analysis of Landsat Computer-Generated Map Products, Harbor Island Test Site	158
27	Intensified Sample Correlation Between Image Interpretation (Horizontal Axis) and Computer Classification (Vertical Axis), 25 Feb. 1975 Landsat Scene	160
28	Computer Classification Accuracy from Comparison with Image Interpretation Using an Intensified Sample, 25 Feb. 1975 Landsat Scene	162
29	Realignment of Computer Classes into Urban (U), Agriculture (A), Upland Vegetation (Up), Wetland (W), Barren (B), and Water (WA), Using an Intensified Sample, 25 Feb. 1975 Landsat Scene	163
30	Summary of Classification Accuracy for Computer-Assisted Analysis Using an Intensified Sample, Harbor Island Test Site	164
31	Examples of Management Activities and Issues in the Harbor Island Area Occurring Between 1973 and 1976	167
32	Cost Computations for Data Acquisition to Support Interpretation and Computer Classification	185
33	Cost Computations for Data Interpretation of Image-Interpretation Maps	189
34	Cost Computations for Data Interpretation of Computer-Classification Maps	193

LIST OF TABLES (Con't)

<u>Number</u>	<u>Title</u>	<u>Page</u>
35	Cost Computations for Data Display of Image-Interpretation and Computer-Classification Maps	198
36	Cost Computations for Office Space, Equipment, and Material Costs for Image-Interpretation and Computer-Classification Maps	200
37	Total Costs for Image Interpretation, Including Office Space, Equipment and Materials, and Labor Costs Other Than Interpretation	204
38	Total Costs for Computer-Assisted Analysis, Including Office Space, Equipment and Materials, and Labor Costs Other Than Interpretation	205
39	Survey Questionnaire on Costs of an Environmental Geology Map	210
40	Cost Computations on a Hypothetical Map Based on Interpretation of Aerial Photography: Data Acquisition, Data Interpretation, and Data Display	211
41	Distribution of Costs on the Hypothetical Map Based on Interpretation of Aerial Photography: Assuming Two Different Scales of Infrared Photography and No Change in Interpretation Time with Photo Scale	215
42	Costs Per Square Mile for the Computer Map, Image-Interpretation Map, and Hypothetical Map Based on Interpretation of Aerial Photography, with a 40"x40" Map Size	218

PLATES  
(In pocket)

LANDSAT IMAGERY-DERIVED LAND COVER/LAND USE

- Plate 1 Seischrome<sup>TM</sup> Display of Computer-Assisted Analysis  
of Test Site 4
- Plate 2 Freeport-San Luis Pass, Test Site 1
- Plate 3 San Antonio-Espiritu Santo Bay Area, Test Site 3
- Plate 4 South Padre Island-Laguna Madre Area, Test Site 5
- Plate 5 Harbor Island Area, Test Site 4
- Plate 6 Harbor Island Area, Test Site 4

## 1.0 INTRODUCTION AND BACKGROUND

### 1.1 Remote Sensing

Remotely sensed data used as a tool for inventory and mapping purposes can vary from oblique aerial photography collected from a small airplane, through conventional and high-altitude vertical photography, to imagery from manned and unmanned orbital space craft. Often, resolution decreases while the area covered by a single image increases through this sequence; the product from each platform offers a unique vantage point. The use of Landsat-1 and Landsat-2 multispectral scanner (MSS) imagery in four bands per scene permits the mapping and interpretation of earth resources over the scene area of 10,000 square nautical miles (n.mi<sup>2</sup>). The satellite scans this same area every 18 days, and, even with data losses due to cloud cover and variations in sensor function, a substantial amount of excellent synoptic coverage is obtained. The Landsat Data Users Handbook (NASA, 1976) provides a detailed description of the Landsat sensor systems, operational characteristics, and data formats. Compilations by Freden and others (1973a, 1973b), Smistad and others (1975), and most recently Williams and Carter (1976) demonstrate the wide variety of applications being made of Landsat data, including those in the coastal zone.

### 1.2 Development of Texas Remote Sensing Activities

The involvement of the State of Texas in remote sensing applications has a long and varied history. Two agencies, the Texas Department of Highways and Public Transportation and the University of Texas Bureau of Economic Geology, have employed aerial photography extensively as major sources of data relevant to highway design, flood studies, geological mapping, and environmental inventories. The Texas Department of Highways and Public

Transportation collects its own aerial photography and employs digital data processing to produce detailed topographic design layouts and instructions to contractors. The Bureau of Economic Geology has produced the Environmental Geologic Atlas of the Texas Coastal Zone, environmental maps of the Houston Area Test Site of NASA, and environmental maps of south Texas for the Texas Water Development Board--all from photographic interpretation supplemented by field studies. Recently, other agencies have begun to use more remote sensing data. For example, the Texas Parks and Wildlife Department, which previously had made limited use of remote sensing, has initiated a statewide inventory of wildlife habitats using Landsat data. Increasingly, those concerned with complex planning and management problems in Texas have recognized the need for regional information that only remote sensing data can provide within the constraints of time and funding available to gather these data.

In June 1972, the Governor's Office was designated as the single point of contact with NASA to coordinate state government requests for remote sensing assistance. The Governor's Office surveyed state agencies to determine the desirability of and support for an integrated Texas remote sensing program. In March 1973, the Interagency Council on Natural Resources and the Environment (ICNRE), then composed of 14 natural resources agencies, considered the progress that had been made by the representatives of the various ICNRE agencies in exploring the development of an integrated remote sensing program. This progress included results of the survey of Texas agencies made in 1972 that indicated areas where remotely sensed data would have immediate application to agency needs. As a result, the ICNRE established the Remote Sensing Task Force to develop an integrated plan for using remote sensing data to satisfy state agency needs. In December 1974,

recommendations in the Texas Remote Sensing Plan were adopted by the ICNRE and added to the responsibilities of the task force charged with developing the Texas Natural Resources Information System (TNRIS).\*

During preparation of the Remote Sensing Plan, in November 1973, the state was informed of the opportunity to become a Principal Investigator of the Second Earth Resources Satellite (ERTS-B) program. The Remote Sensing Task Force decided that this program would be a complementary step in formulating the Texas Remote Sensing Plan, and because of recent state and federal legislation concerning coastal zone management that had become responsibilities of the General Land Office, requested that the General Land Office prepare a proposal for submission to NASA. Other agencies having an interest in the coastal zone were invited to assist. The Texas Natural Resources Information System, the Texas Parks and Wildlife Department, and the Bureau of Economic Geology accepted this invitation and participated in preparation of the proposal and in the resulting Landsat investigation.

### 1.3 Texas Coastal Zone Management Requirements

Recognizing that Texas had little or no documented plan for managing

---

\*The Texas Natural Resources Information System (TNRIS) is being implemented through the TNRIS Task Force of the Interagency Council on Natural Resources and the Environment (ICNRE). The ICNRE membership includes the administrative heads of the state's natural resource agencies and is chaired by the governor or his representative. The present participating agencies on the TNRIS Task Force are the Texas Water Development Board, the General Land Office, the Texas Air Control Board, the Texas Forest Service, the Texas Industrial Commission, the Texas State Department of Health Resources, the Texas Water Quality Board, the Bureau of Economic Geology (University of Texas at Austin), the Railroad Commission of Texas, the Texas Department of Agriculture, the State Department of Highways and Public Transportation, the Texas Parks and Wildlife Department, the Texas Soil and Water Conservation Board, the Texas Water Rights Commission, and the Texas Coastal and Marine Council.

over four million acres of state-owned coastal resources, the 63rd Legislature enacted laws that defined state policy concerning the coastal public lands. The Coastal Public Lands Management Act of 1973 directed the School Land Board with the assistance of Texas General Land Office (GLO) staff to draft and implement a comprehensive management program, as well as to undertake the following:

- (1) A continuous inventory of coastal lands and water resources...;
- (2) A continuous analysis of the potential uses to which the coastal public lands and waters might be put, including recommendations as to which configurations of uses consonant with the policies of this Act maximize the benefits conferred upon the present and future citizens of Texas;
- (3) Guidelines on the priority of uses in coastal public lands within the coastal area, including specifically those uses of lowest priority;
- (4) A definition of the permissible uses of the coastal public lands and waters and definitions of the uses of adjacent areas which would have a significant adverse impact upon the management or use of coastal public lands or waters...

(The General Land Office and Texas Coastal Marine Council, 1974, and TEX.REV.CIV.STAT.ANN. art.5415e-1, Supp. 1976).

In addition, the governor of the State of Texas had designated the commissioner of the General Land Office as the official to prepare and submit a proposal to develop a comprehensive coastal zone management program for Texas under the federal Coastal Zone Management Act of 1972, which is administered by the National Oceanic and Atmospheric Administration of the Department of Commerce.

These responsibilities, and specifically the need to acquire cost-effective techniques for the continuous inventory of coastal land and water resources within a coastal zone of about 15,000 square miles, provided the focus for this investigation. From these requirements, the GLO developed a priority listing of information needs to be addressed with the Landsat data and analytical techniques that are defined in section 2.0 of this report.



#### 1.4 Indirect Benefits of This Investigation

Although specific objectives and various constraints were identified for this project, this investigation has the potential for much wider application to state agency needs. For example, the type of information to be addressed in the investigation was limited to the specific land cover and land use information about the Texas coastal zone that was required to support the General Land Office. However, many state agencies have responsibilities relating to natural resources and the environment that require some information about land cover and land use (Task Force on Remote Sensing, 1974). Thus, the experience gained from this project can be applied to the evaluation of Landsat data for land cover and land use mapping in light of other state agency responsibilities and for other regions of the state.

Additional constraints placed on the project (because of costs) were (1) to minimize the acquisition of expensive, specialized equipment and (2) to make maximum use of existing capabilities within the participating agencies. These constraints provided the rationale for a multiagency investigation so that existing equipment, facilities, and expertise could be shared.

## 2.0 OBJECTIVES

### 2.1 Objectives and Information Priorities

The short-term objective of this investigation was to develop and make operational both image-interpretation and digital pattern recognition techniques for the inventorying and monitoring of (1) coastal wetlands, (2) land cover and land use conditions adjacent to coastal waters, (3) shoreline changes and dune areas, and (4) bay and estuary systems. Test sites were chosen to develop, modify, and test these techniques by comparison with

selected ground truth information obtained from interpretation of aerial photo coverage and field studies of these areas. Tables 1-4 represent investigation priorities determined from information requirements of the General Land Office with respect to coastal management responsibilities outlined in state legislation (Armstrong, 1973).

The long-term objective of this project was to incorporate the proven techniques into a quasi-operational system by which changes in the extent of wetlands and other land cover conditions of the Texas coast could be detected. These changes could then be compared with past conditions, with a high degree of reliability, and the information presented in a suitable form for use by the General Land Office.

Table 1  
PRIORITY I: FEATURES OF THE WETLANDS

<u>Feature</u>	<u>Characteristics</u>	<u>Size (km<sup>2</sup>)</u>
Tidal Flat	Barren areas that are inundated during high water conditions and partially or completely exposed during low water conditions.	5-20
Marsh	Wet vegetated area periodically inundated by salt or fresh water.	10-30
Swamp	Wet vegetated area generally inundated by water; usually some deciduous trees.	8-20
Grassflat*	Submerged saltwater vegetation (seagrasses) in bays, estuaries, and lagoons.	1-2

---

\*Included with wetlands, or periodically inundated areas, because of the importance of grassflats as feeding and nursery ground for fish, shellfish, and waterfowl on the lower Texas coast.

Table 2

PRIORITY II: FEATURES OF LAND COVER AND LAND USE  
CONDITIONS ADJACENT TO COASTAL WATERS

<u>Feature</u>	<u>Characteristics</u>	<u>Size (km<sup>2</sup>)</u>
Land Resources	Land-Use Category Level I, some Level II (Anderson and others, 1972)	1-10

Table 3

PRIORITY III: FEATURES OF THE BEACH AND ASSOCIATED SANDS

<u>Feature</u>	<u>Characteristics</u>	<u>Size (km<sup>2</sup>)</u>
Beach	Highly reflective, unconsolidated sediment at the Gulf-land interface; more or less in transit.	1-10
Washover Areas	Bare sediment of deltaic shape on landward side of beach or barrier island built by storm water passing over the beach.	1-10
Blowouts	Unvegetated hollow scooped out by wind.	1-5
Dunes	Unvegetated areas of active sand in movement and stabilized dune-form with some vegetation.	1-100*

---

\*Continuous area of feature that may be present within one Landsat scene on the Texas coast.

Table 4

PRIORITY IV: ESTUARIES AND RELATED PHENOMENA

<u>Feature</u>	<u>Characteristics</u>	<u>Size (km<sup>2</sup>)</u>
Tidal Pass	An inlet or channel through a barrier island through which the tide flows at ebb and flood.	<1
Estuary*	A drowned river valley of brackish to salt water, funnel-shaped and widest seaward.	30-600
Spoil	Embankment of dredged sediment, both submerged and subaerial.	<1-10
Plankton Bloom	Rapid growth of aquatic algae.	2-20 kms
Suspended Sedi- ment	Sediment carried into suspension by wind-driven currents or waves. Indicates some of circulation pattern in estuaries and bays.	20-300

---

\*Includes bay and lagoon systems on the Texas coast.

✓ 2.2 Anticipated Results

The purpose of this investigation, as defined in the "Statement of Work" in the contract between NASA and the GLO, was to yield the following results:

1. A quasi-operational coastal zone resources monitoring system, using satellite remote sensing and supportive data.
2. A documented cost-benefit analysis on the system developed.
3. A remote sensing software and data library available to the State of Texas for further work.
4. A complete base map of the coastal zone features being studied

and the beginning of a historical library of temporal changes of these features along the coast.

5. A documented analysis of the performance of image interpretation vs. digital processing and of the performance of the various algorithms in digital processing with respect to monitoring coastal zone features.

Techniques developed to analyze Landsat data, as part of a system to inventory and monitor coastal zone features, were designed to assist the GLO in meeting its statutory requirements as well as those that might be imposed by federal coastal zone management legislation. A cost-benefit analysis was included to determine if Landsat data would provide a reasonable means of accomplishing these objectives. The remaining anticipated results had been placed in a research category in the proposal and therefore had less emphasis placed on them during the investigation (Armstrong, 1973).

### 3.0 METHODS AND APPROACH

#### 3.1 Overview of the Investigation Approach

The long-term objective or goal of this investigation was to develop a capability within the General Land Office and other Texas agencies to "monitor" natural resources in the coastal zone utilizing Landsat and other available data sources. However, only the short-term objective (section 2.1) was considered feasible in terms of selecting a manageable scope and approach for the investigation.

For example, the design of a true "monitoring" system would have required more effort than could be accomplished by this investigation. For a complete system, a capability would be required not only to inventory

existing natural resources and related activities by analysis of Landsat data, but also to detect changes in resources and conditions through periodic inventories. In addition, to be useful, a monitoring system would need the ability to store, retrieve, and display the results in a manner that supported operational functions of coastal management. Careful consideration of these operational functions would, in fact, require a separate study, which was beyond the scope of this project. Consequently, a simplified systems approach was adopted in which three system components were identified: (1) data ordering and data handling, (2) data analysis, and (3) information display or output. This approach allows for evaluation of each component as part of a monitoring system at project end to pursue later if proven desirable.

There were other factors in the selection of the appropriate approach for conducting the investigation. One factor was the multiagency composition of the investigation that required a workable management structure to make maximum use of agency capabilities. Another was that agency participants had minimal experience with manipulating Landsat multispectral scanner (MSS) data when the project began, so that it was difficult to schedule tasks and adhere to a strict timetable. Refining and modifying techniques to analyze this data continued to a certain extent throughout this investigation. And finally, the Texas coast is one of the most diverse and dynamic regions of Texas. Test sites were selected to sample as much of this diversity as practical, while concentrating on the development and testing of techniques for analyzing Landsat data.

The following steps were taken to achieve the established objectives:

1. The project objectives were translated into specific tasks to be accomplished during the investigation.

2. An organizational structure was established that would make maximum use of the capabilities and expertise available within the participating agencies, and the appropriate tasks were assigned to each agency.
3. A project schedule was developed with specific milestones and timetables for accomplishing each task, for data acquisition, reporting project status, and completion of the final report.
4. A data handling system was developed for locating, ordering, storing, and retrieving the Landsat data, aerial photography, and associated data needed for the investigation.
5. A land cover and land use classification system was developed that was applicable to Landsat and that would provide the information needed for monitoring resources and activities in the coastal zone.
6. Specific test sites were selected throughout the coastal zone for use in developing and demonstrating the analytical techniques for extracting the required information from Landsat and associated data.
7. Ground truth requirements were established and the information collected that was needed to support the analysis of Landsat data.
8. Established test sites were used to develop experimental techniques for analysis of Landsat data.
9. Using one site reserved for testing the developed analytical techniques, data was generated for the cost-benefit study, and sample map products were prepared for subsequent evaluation.
10. A cost-benefit analysis was prepared to aid in evaluation of techniques developed for this investigation.

11. The sample map products were evaluated for classification accuracy and utility.

12. The results of the investigation were documented.

The following sections will provide additional details regarding accomplishment of these steps.

### 3.2 Project Management

#### 3.2.1 Organization

The functional organization for this investigation is shown in figure 1 along with general areas of responsibility assigned to each agency and consultant. The technical and contract monitors were located at NASA's Goddard Space Flight Center (GSFC). Two Texas natural resource agencies and the Texas Natural Resources Information System (TNRIS) participated with the General Land Office (GLO) in the investigation. These two agencies were the University of Texas at Austin, Bureau of Economic Geology (BEG), and the Texas Parks and Wildlife Department (TPWD). GLO staff provided project management and coordination, as well as an evaluation of product utility. TNRIS staff were responsible for ordering and indexing data and for developing techniques to process computer-compatible tapes (CCTs) of Landsat data. BEG staff developed techniques for image interpretation, performed field verification, and assisted with the correlation of computer classification by TNRIS data processing staff. TPWD staff provided ground truth for the biological interpretation and assisted in the field verification of image interpretation and computer classification.

Personnel of NASA's Johnson Space Center, Houston, Texas, provided the basic software for computer-assisted analysis of Landsat digital data and gave technical support and advice on various aspects of the project.



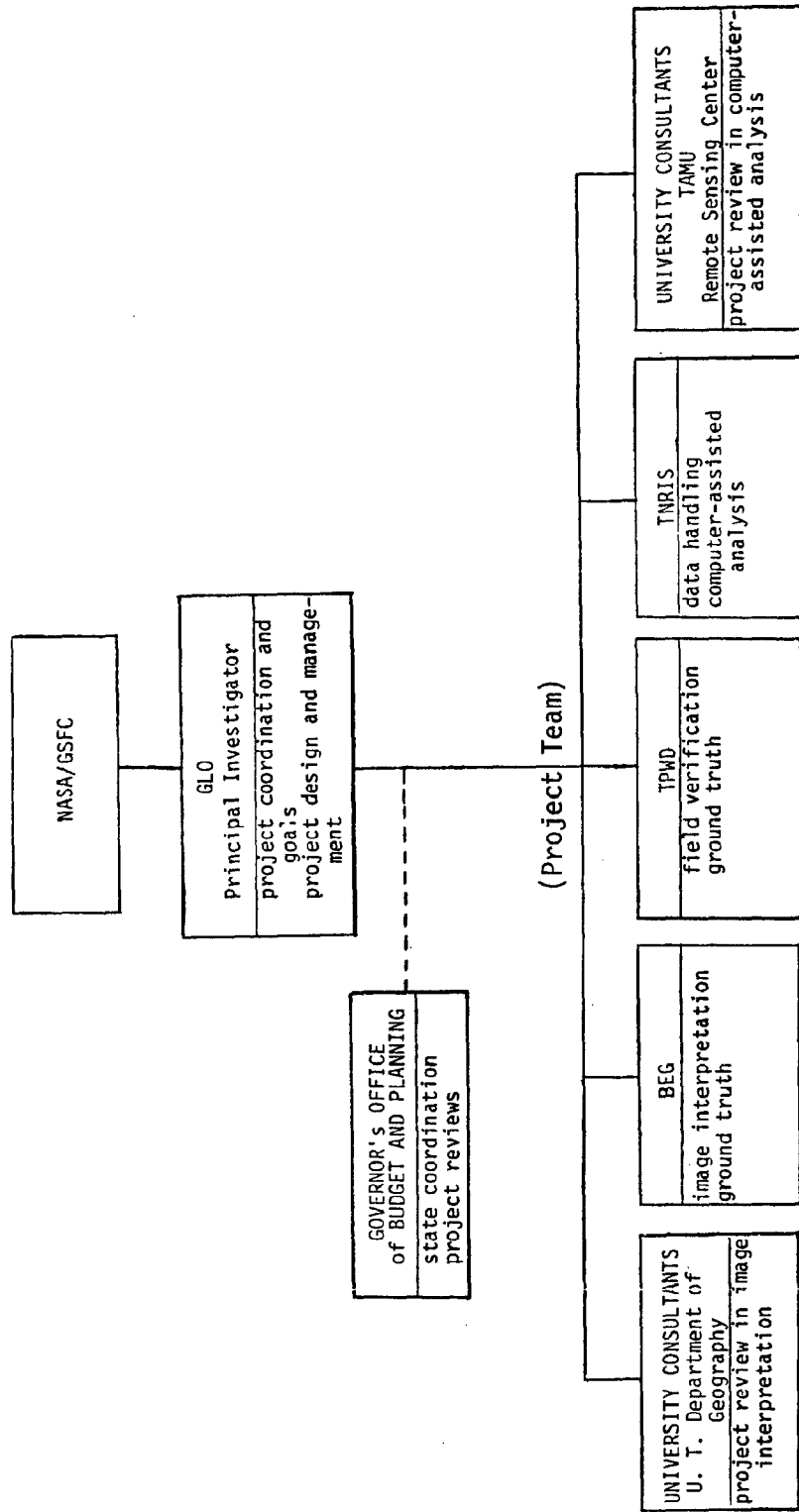

Figure 1. Summary organization chart for Landsat Investigation #23790.

### 3.2.2 Coordination

This investigation had two important coordination functions related to the application of Landsat technology to Texas coastal problems. First, the investigation was designed to develop techniques for monitoring resources that might support the NOAA-funded Coastal Management Program being developed in the General Land Office for the State of Texas, as well as support the GLO management responsibilities for the more than four million acres of state-owned submerged lands in the bays and Gulf of Mexico. Some attention to these coastal management activities was necessary so that products generated by this investigation would be compatible with existing information use or needs.

The second coordination function was the transfer of capability developed by this investigation to other state agencies through the Texas Natural Resources Information System. TNRIS is being implemented by a task force of the Interagency Council on Natural Resources and the Environment (ICNRE), with assistance from the Governor's Office of Budget and Planning. This investigation is partly funded through the TNRIS by the donation of computer time. Techniques developed by TNRIS and BEG staff for this investigation are made available to other agencies through the TNRIS.

### 3.2.3 Schedule

The generalized schedule established for this investigation is shown in table 5. Tasks 1-4 were accomplished within the investigation time frames. The system testing, cost-saving analysis, and project documentation tasks, however, encountered delay. This occurred in part because a heavy user workload was imposed on the Texas Water Development Board's computer system, which was shared with TNRIS and several state agencies. A larger computer system was subsequently installed, eliminating such delays.

**Table 5**  
**GENERALIZED SCHEDULE FOR LANDSAT INVESTIGATION #23790**

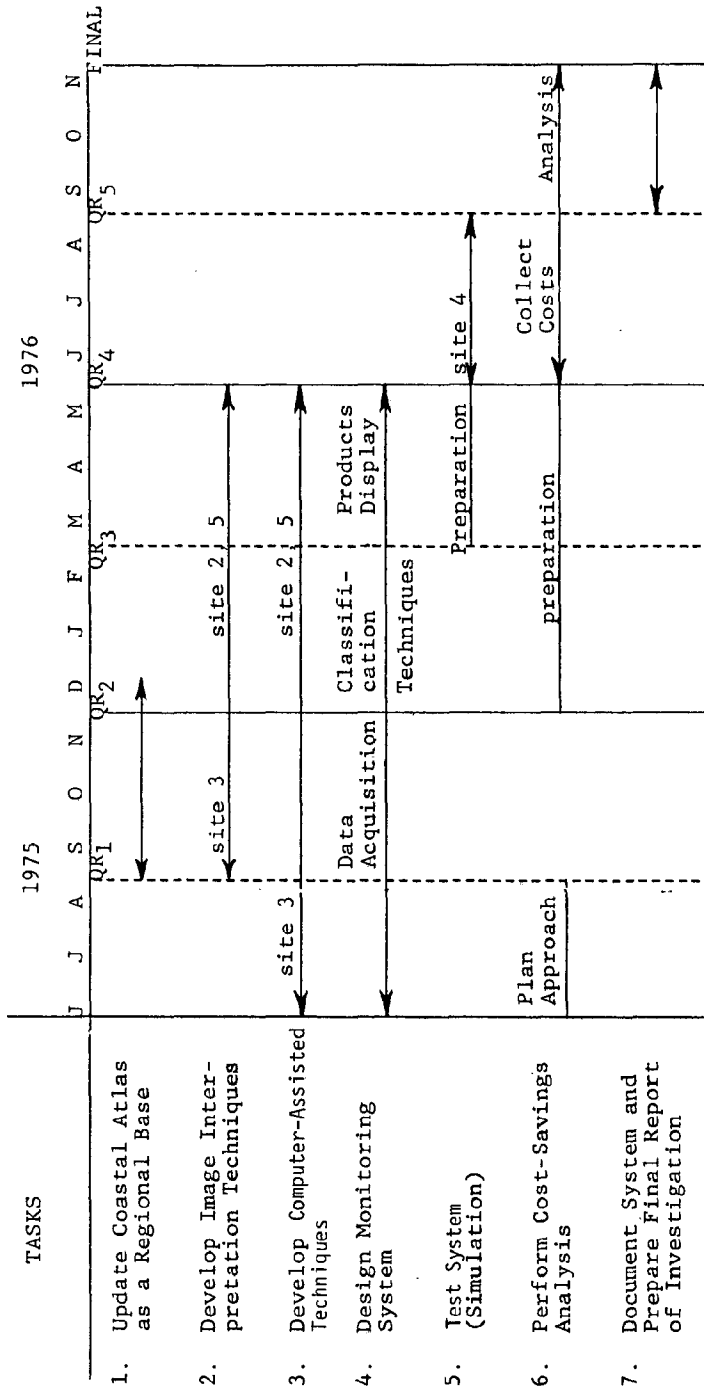

However, computer analysis runs for test site 4 were not completed until January 1977, which in turn delayed completion of other tasks.

Early in the investigation, it became apparent that the development of techniques for computer-assisted analysis and image interpretation of data would not progress at the same rate. Image-interpretation techniques were, in fact, developed first, being readily adapted from experience in mapping from aerial photography (section 6.1). Computer-assisted analysis techniques, however, took much longer to develop and still must be refined. Analytical techniques and classification schemes for image interpretation and computer-assisted analysis had to be completely developed before information displayed on map products for each test site could be examined and compared. For this reason, test site 4 (the Harbor Island area) was reserved until last to allow extra time for computer technique development, so that the products derived from both methods could be evaluated for information accuracy and utility.

Information priorities established for the investigation (tables 1-4) guided the development of the classification schemes (section 4.0) and the emphasis placed on ground truth. In order to set more specific guidelines for the evaluation of map products with respect to the management of coastal public lands, specific investigation objectives were established for test site 4. A discussion of these objectives is included in section 8.0.

### 3.3 Data Handling Procedures

#### 3.3.1 Introduction

The TNRS developed procedures to acquire, index, store, retrieve, and distribute Landsat data, meteorological and climatological data, and other remote sensing and cartographic data to support the needs of TNRS

users. This effort also served to satisfy one of the objectives of the Landsat investigation and was used extensively to support this aspect of the project. The TNRIS procedures for handling remote sensing data include the following steps: specification, inquiry, ordering, indexing, and distribution.

### 3.3.2 Data Specification

The project team reviewed the work planned for each test site and determined the types of data needed, seasonal requirements, the number of Landsat scenes to be analyzed, type and amount of aircraft photography needed, and supportive information required. A standard set of imagery products and other data was evolved during the project which provided the materials needed to support the image-interpretation and computer-assisted analysis tasks (table 6).

The following comments apply to the utility of items listed in table 6:

1. 1:1,000,000 false-color transparency--This data format is excellent for discrimination within vegetated areas and is by far the most useful Landsat standard product. Comparison may easily be made with color-infrared aerial photography. Moderate reflectance barren areas, industrial sites, and dredge spoil are readily distinguished from surrounding vegetation. Seasonal changes in wetland and rangeland vegetation are easier to detect as differences in color tone than as differences in shades of grey.
2. 1:1,000,000 positive transparencies, bands 4-7--Together with the false-color composite, these are the primary products from which image interpretation by optical enlargement may be accomplished. Band 4 is of low utility because of the effects of atmospheric haze and humidity but may be useful in defining urban areas.

Table 6

DATA REQUIREMENTS TO SUPPORT LANDSAT INVESTIGATION

1. Landsat Data

a. Image Interpretation

<u>Item</u>	<u>Scale</u>	<u>Band</u>	<u>Cost</u> <sup>1</sup>
Color Transparency	1:1,000,000	composite	\$ 15.00
B&W Paper Enlargement	1:250,000	5, 7	40.00
B&W Film Positive Enlargement	1:125,000	7	5.95 <sup>2</sup>
B&W Positive Transparency	1:1,000,000	4, 5, 6, 7	40.00
B&W Negative Transparency	1:1,000,000	5, 7	<u>20.00</u>
Cost if Color Master Available.....			\$120.95
Additional Cost of Color Master.....			\$ 50.00
Cost if Color Master Needed.....			\$170.95

b. Computer-Assisted Analysis

<u>Item</u>	<u>Scale</u>	<u>Band</u>	<u>Cost</u> <sup>1</sup>
B&W Positive Transparency	1:1,000,000	7	\$ 10.00
Computer-Compatible Tapes	-	-	200.00

2. Aircraft Photography

<u>Item</u>	<u>Scale</u>	<u>Cost</u>
Color/Color-Infrared Aerial Roll Film (MSN 300)	1:120,000	Flown by NASA and purchased from EROS Data Center at \$7.50/frame in roll form.
Color/Color-Infrared Aerial Roll Film (MSN 325)	1:40,000	Flown by NASA and purchased from EROS Data Center at \$7.50/frame in roll form.

<sup>1</sup>Costs represent price increases effective January 1, 1977, at EROS Data Center. Cost of some products was less at actual time of purchase.

<sup>2</sup>Obtained by TNRIIS through interagency contract with the Texas Highway Department from the B&W negative transparency.

Table 6 (Con't)

## DATA REQUIREMENTS TO SUPPORT LANDSAT INVESTIGATION

<u>Item</u>	<u>Scale</u>	<u>Cost</u>
Color/Color-Infrared Aerial Roll Film (AMPS MSN)	1:30,000	Flown by NASA and purchased from EROS Data Center at \$7.50/frame in roll form. <sup>3</sup>
Color Infrared Paper Prints	1:24,000	Available through Texas General Land Office for test site 4 only.
Color/Color Infrared Slides/Paper Prints (35mm)	1:5,000 (Handheld Obliques)	\$5.00/20 exposure roll.

3. Meteorological/Climatological Data

<u>Item</u>	<u>Cost</u>
Precipitation History	Purchased from National Climatic Center for collection points near test sites at \$2.55/year/station.
Wind Velocity/Direction History	Purchased from National Climatic Center for collection points near test sites at \$2.55/year/station.
Tide Levels	Obtained from the U.S. Army Corps of Engineers for gages nearest test site at no cost to project.

4. Other Support Data

<u>Item</u>	<u>Scale</u>	<u>Cost</u>
Boundary Map Enlargement	1:24,000	\$ 23.80/sheet
Aerial/Ground Reconnaissance	-	-
Ground Truth Data: Biological Transects	-	-
Spot Verifications	-	-

<sup>3</sup>Specific costs for this project were considerably greater due to requirement for producing 9 1/2" frames from original 70 mm frames.

Band 5 suffers less from these effects and may be used to delineate built-up areas, surface drainage patterns, roads and airports, and suspended sediment patterns in water bodies. Bands 6 and 7 offer the best land-water boundary discrimination, including the details of coastal wetland drainage. The preparation of a map base showing land-water boundaries is best done with band 7 data.

3. 1:1,000,000 negative transparencies, bands 5 and 7--These products have been used to produce: (1) paper (contact) prints for field or group discussion use and (2) film positive enlargements for use in map preparation over the test site areas. River drainage seems somewhat easier to detect on the band 5 negative than on the positive.
4. 1:250,000 paper print, bands 5 and 7--The acquisition of these prints may be considered optional since they are not actually used in the map preparation process. However, the prints are a useful data format for display and discussion purposes, and for quick reference to the imagery at a larger scale than that of the 7.3-inch transparencies.
5. 1:125,000 positive transparency enlargement, band 7--This enlargement was prepared from the band 7 negative transparency and was utilized as the base for recording information interpreted from the other products.
6. Boundary map enlargement--The Landsat-derived classifications were verified by correlation with ground truth and the enlargement was used to evaluate and correlate the various spectral classes generated by the computer-assisted analysis with the established classification scheme.



7. Computer-compatible tapes--These tapes provided the source of the Landsat digital data for the computer-assisted analysis.
8. 1:1,000,000 black-and-white positive transparency, band 7--This product was used to develop the control network as part of the computer-assisted analysis. Specific procedures for preparation of the control network are contained in the Detection and Mapping (DAM) package.
9. Aircraft photography/other data--This data was used in the correlation of Landsat-derived spectral "clusters" with the various land cover and land use categories of interest and to verify the results. The aircraft photography was also used to establish known points for computing the accuracies of the interpretations and for updating the existing base maps of the Texas coastal zone.

### 3.3.3 Data Inquiry

Once the general time frame is determined for study of a given test site, an inquiry regarding available Landsat coverage is made to the EROS Data Center via direct terminal access from TNRIS. The resulting printout indicates various characteristics for each Landsat scene, including the acquisition date, percentage of cloud cover, quality rating for each band, corner coordinates, and browse file cassette reference number. The browse file consists of 16mm film in cassette format which can be reviewed on an Eastman Kodak Recordak. The reference number on the inquiry printout denotes the specific cassette number and the frame number to be preselected for the Recordak search.

Using this information, the 16mm version of each Landsat scene (band 5 only) can be reviewed to determine if the quality and other characteristics appear suitable for analysis. For bands 4, 6, and 7, or if the

appropriate cassette is not available, the evaluation must be done on the basis of information contained in the inquiry printout. In either case, the quality of the color composite registration cannot be determined until the actual product is available for review. The criteria generally used for this investigation were 10 percent maximum cloud cover (if 16mm coverage was not available) and a minimum of "8" quality rating for all bands.

The NASA aircraft photography used for this project was flown specifically for the project. However, inquiries regarding the availability of other aircraft data can be made through TNRIS. Access to the EROS Data Center for this purpose is also made through the remote terminal. Inquiries to other remote sensing data sources are made by letter or telephone or by review of available coverage indexes.

As indicated in table 6, the meteorological and climatological data were obtained from the National Climatic Center and the U.S. Army Corps of Engineers. This was accomplished early in the investigation. Since that time, the TNRIS has gained additional data, and access to files of data, which should provide most of the information needed for future efforts of this type.

Because of delays in availability of information about new Landsat coverage (scene ID, cloud coverage, quality, etc.) at the EROS Data Center, it was necessary in several instances to contact the NASA technical monitor at the Goddard Space Flight Center (GSFC) to determine whether or not appropriate test site coverage had been acquired during recent Landsat passes. When GSFC indicated suitable coverage was available, orders could be placed at the EROS Data Center for that particular scene.

#### 3.3.4 Data Ordering

Three standing accounts were established at the EROS Data Center (EDC) for aircraft photo products, Landsat imagery products, and Landsat computer-compatible tapes (CCTs). Delivery schedules for Landsat imagery and tapes were generally as follows: black-and-white imagery of the four bands and the CCTs required four to six weeks from the date of acquisition by Goddard for delivery of a master copy to EDC. Once these copies were available at EDC, two to three weeks were required for production of black-and-white or for color composite imagery products, if the color composite master had already been produced. Production of the color master required an additional two to three days. Delivery of the CCTs required seven to ten days. Shipping time added two to three days to each delivery.

Orders were placed by TNRIS using the standard EDC order forms. Other data to support the project were obtained at the direction of the project manager as required.

#### 3.3.5 Indexing

The Landsat black-and-white transparencies used for the computer-assisted analysis were indexed by TNRIS staff according to scene ID, date, band, and geographic location. The transparencies were filed in clear plastic sleeves inserted in paper envelopes and bound book form. The CCTs were assigned local identifier tape numbers and indexed into the TNRIS magnetic tape file system. A software program was written by TNRIS staff to maintain an accurate account of available data. The listing, updated as new data was received from EDC, included the scene ID, date, geographic coordinates (center), tape ID number, and the format available (imagery, CCTs, or both). A record of Landsat scenes and products acquired to support

this project are listed in appendix A.

### 3.3.6 Distribution

Imagery and data for use in the image-interpretation tasks were delivered to the Bureau of Economic Geology as soon as available. NASA aircraft Mission 300 data was acquired for this investigation in two sets: one at BEG, and one in TNRIS. In addition, a third copy of Mission 300 data had been acquired independently by the Texas Coastal Management Program and was available for reference in the General Land Office.

## 3.4 Ground Truth and Support Data

### 3.4.1 Updating the Coastal Atlas to Provide a Regional Base for the Texas Coast

The Environmental Geologic Atlas of the Texas Coastal Zone (Brown, coordinator, in progress) includes an Environmental Geology map at a scale of 1:125,000. This map provides an excellent regional base which has been used to control the scale of enlargements of Landsat images and to aid in evaluation of the test site mapping. To insure that these maps reflect current conditions, the February 1975 photography flown for this investigation by NASA (Mission 300, 1:120,000 scale) was used to produce a transparent overlay showing recent changes. The area covered by the photography corresponds to approximately the seaward half of each Environmental Geology sheet, or a coast-parallel strip some 20 to 25 miles (32.2 to 40.2 km) wide.

Differences between the maps and the photography were classified as either additions or deletions. Additions refer to boundary expansion of an existing area within the same category or to delineation and classification of a new area, all of whose boundaries are new. Deletion refers to areal contraction of an existing classified area. Most of the changes were

considered to be addition. For example, the emplacement of new dredge spoil was considered as dredge spoil addition rather than deletion of bay bottom.

The updated overlays are intended to be used with the color prints of the Environmental Geologic Atlas maps; the overlay line boundaries are derived from the same negatives as the original map (fig. 2). Categories in the explanation on the original map were numbered, making it easy to tag all changes with the appropriate new category on the overlay. Recent land use changes were also defined by comparison with Current Land Use maps from the Environmental Geologic Atlas of the Texas Coastal Zone, and the new areas were labeled according to the land cover and land use classification scheme adopted as part of this study.

Most changes detected using the Mission 300 photography were minor revisions relating to realignment of channels, deposition of dredge spoil, erosion and deposition along shorelines, and changes in the configuration of tidal inlets. As expected, the man-induced changes were related to industrial, commercial, and residential development, while the natural changes occurred where coastal geologic and biologic processes normally are most active. Among the latter were the effects of tidal and longshore currents, wind, and the colonization of new substrate by marsh vegetation. No field confirmation of these results was made, except coincidentally within areas of test site mapping. The overlays will remain available at the Bureau of Economic Geology in an open-file format for use by all interested persons and state agencies.

#### 3.4.2 Ground Truth and Field Verification

The use of multiband photography by Pestrong (1969), and of color aerial photographs by Grimes and Hubbard (1971), has documented the response



ADDITIONS
  DELETIONS

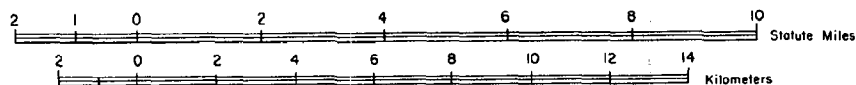

Figure 2. An example of the overlay updating the Environmental Geology Map covering the Harbor Island area (test site 4). The categories indicated are: 24 - wind-tidal flat; 46 - stabilized blowout dune complex; 50 - washover distal fan; 51 - fore-island blowout dunes; 63 - bay and lagoon mud; 73 - subaerial spoil; 75 - subaerial reworked spoil; 75 - subaqueous spoil; 78 - dredged channel.

of marshland vegetation on different film types. Wetland analyses using photography were also carried out by Anderson and Wobber (1973), Reimold and others (1972), and Klemas and others (1974). Utilization of Landsat data for mapping wetland vegetation has been described by Anderson and others (1973, 1974), Carter and Schubert (1974), and Bartlett and others (1975). The latter investigation, as well as Anderson and others (1975), included analysis of Skylab orbital photography.

No comprehensive coastwide ecological study of Texas marshes has been published. Differences in ecology between the well-documented Atlantic wetlands and the Gulf Coast marshes contributed to the need for detailed ground truth studies of vegetation within this investigation. These were carried out by the Texas Parks and Wildlife Department (appendix B). Remote sensing studies (Erb, 1974; Weisblatt, 1976; and personal communications), analyses of vegetation in conjunction with geologic investigations (Andrews, 1970; McGowen and Brewton, 1975; Brown, project coordinator, in progress), and dissertation research (Johnson, 1955) provided most of the information on Texas marshes. For the southern Laguna Madre test site, where marshes are scarce and saline grasslands abundant, Fleetwood (1973) provided a valuable species list and summary of environments. For the middle and upper Texas coast, where marshes become more extensive as annual rainfall increases towards the northeast, a study of the Louisiana coastal region (Chabreck, 1972) was helpful in classifying field transect data.

Biological field verification was conducted by Texas Parks and Wildlife Department (TPWD) staff to assist in correlating computer-generated products with imagery and also to document the marsh vegetation represented in the computer products and image-interpretation marsh classes. Vegetation sampling sites were chosen within spectrally uniform areas on the USGS 7 1/2 -

minute topographic maps. The field approach used was the point intercept method described in appendix B.

The geologic verification procedure included field investigations, extensive use of available maps, aircraft photography, and published reports as the basis for ground truth. In addition, time histories of weather conditions were compiled for the week ending with the date of each Landsat image and used as an aid in interpreting each scene (appendix C). Figure 3 shows wind data for the 22-30 March 1974 period which includes the 29 March 1974 scene of test site 3 and is based on U.S. Weather Service data taken at Victoria, Texas. As this station is some 35 miles inland from the test site, the precise velocities do not apply to the coastal area, but the general onshore or offshore direction and relative duration are probably similar. Precipitation data was also compiled, and tide gage data was obtained from the U.S. Army Corps of Engineers, Galveston District.

*compare  
2.3*

The large-scale photography of Missions 300 and 325, as well as the smaller-scale photography for the entire Texas coastal zone, were very useful in interpreting questionable features on the Landsat imagery. When this photography is utilized with the Environments and Biologic Assemblages and Environmental Geology sheets of the Environmental Geologic Atlas (Brown, project coordinator, in progress), an excellent base of natural resource information exists for verification of Landsat analysis.

### 3.5 Test Sites

Climate along the Texas coast varies from humid at the Louisiana border to semiarid at the boundary with Mexico. The strong gradients of biological assemblages, differences in environmental geology, and variations



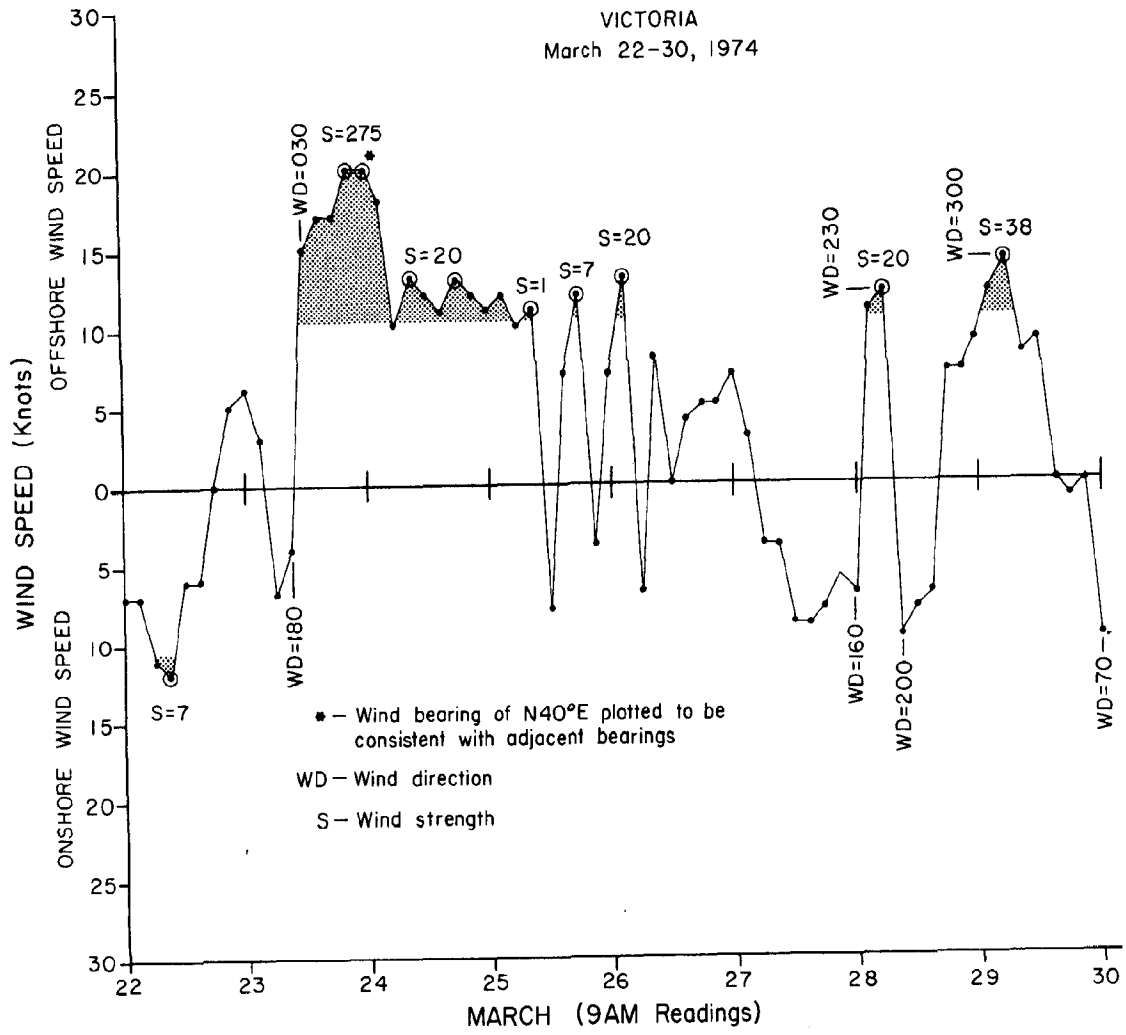

Figure 3. Wind data prior to the 29 March 1974 image shows that wind strengths were low, and therefore water levels would not be wind-influenced. Effective winds are those above 10.4 knots (12 mph), and  $S = (V - 10.4 \text{ knots})^2 (d)$  when  $V = \text{observed velocity}$  and  $d = \text{wind duration}$  (Price, 1975). Data are plotted at 3-hour intervals, and shaded areas indicate periods of effective winds and the associated peak strength.

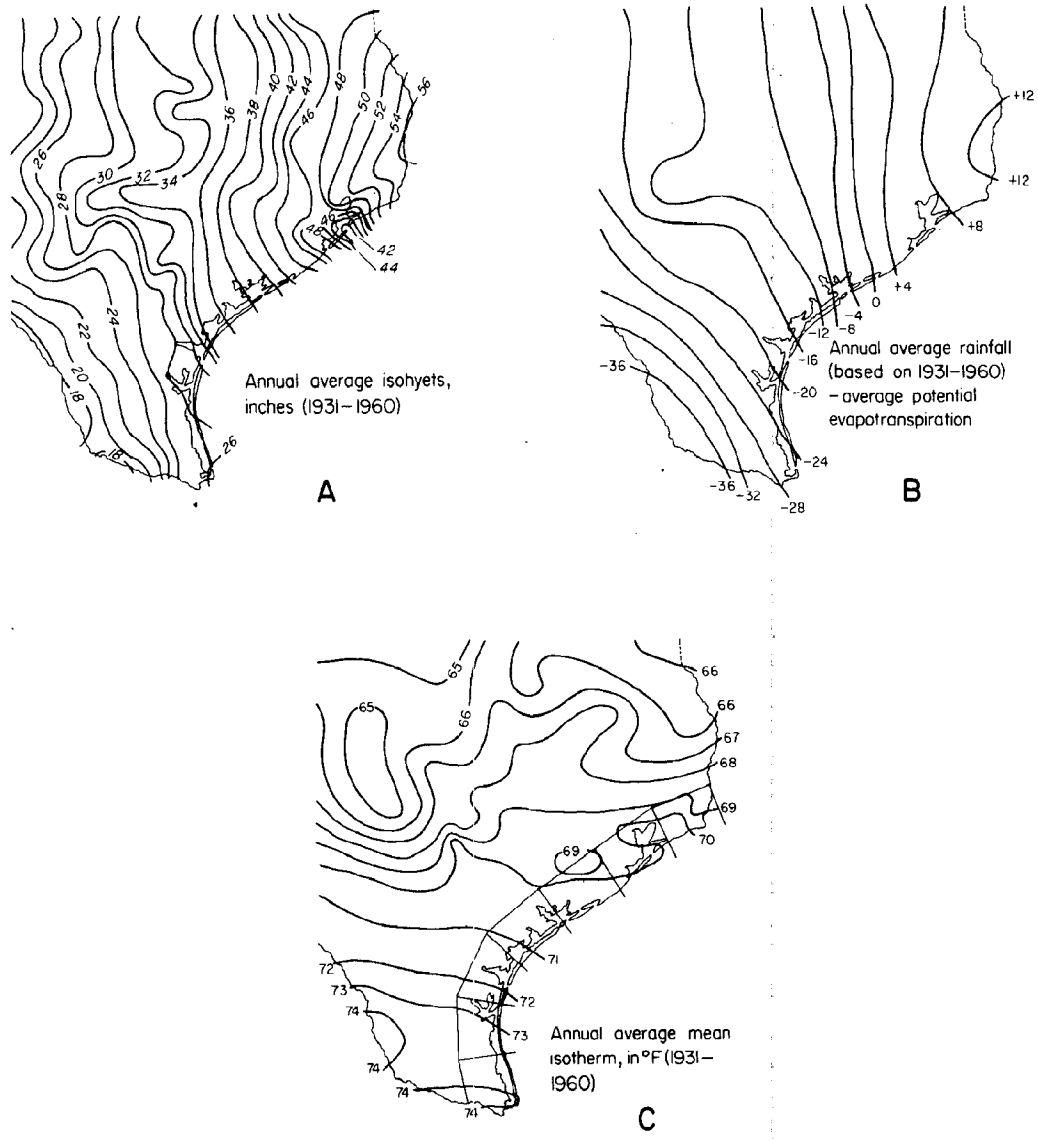

Figure 4. Precipitation and temperature data for the Texas coastal zone (from Fisher and others, 1972).

in active processes along the coast from north to south.

The project proposal identified the entire coastal region as test site 1, which had been planned for the test and evaluation of the monitoring system. Four other sites within the coastal zone had been selected originally for system development. However, it was realized early in the project that this was much too ambitious for the time and funds available. Consequently, three of the four smaller sites were used for technique development and one was reserved for the final test. In order that the resulting system might have general application to wetlands and land use mapping throughout this region, three test sites (2, 3, and 5, fig. 5) were chosen from differing climatic areas. Site 4 (fig. 5) was reserved for final testing of the mapping techniques and the classification scheme developed during analysis of the other sites.

Moderately dense coastal vegetation, absence of wind deflation of sandy areas, and the infrequent occurrence of hurricane washover channels are indications of the importance of positive effective precipitation (excess of rainfall over evapotranspiration) on the northern Texas coast (Fisher and others, 1972). This importance is in contrast to the southern Texas coastal region, where evapotranspiration exceeds rainfall, washover channels and dunes are abundant, and wind transport of sediment contributes to the formation of vast tidal flats on the landward side of the barrier islands.

Other factors which influence the physical environment of all test sites are wind and tidal range. The Texas coast is influenced by prevailing southeasterly winds from March through November and dominant northerly winds from December through February. The latter are associated with the passage of cold fronts, which are often followed by low temperatures, low humidity,

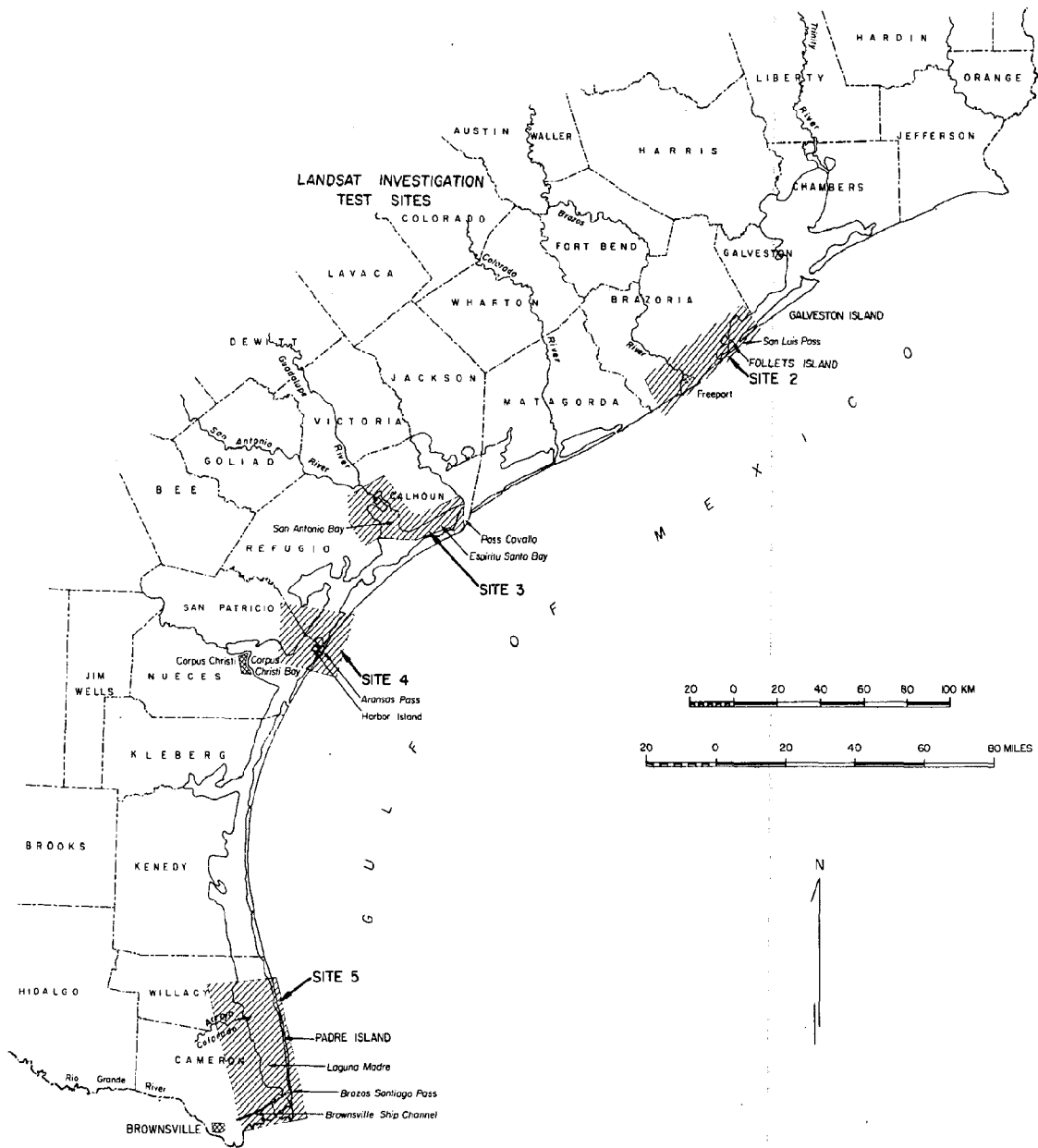

Figure 5. Project test site locations. Test site 1 included the entire Texas coastal zone.

and fair weather during which excellent Landsat imagery can be obtained.

The tidal regime in the Gulf of Mexico is microtidal (range <2m; Davies, 1964). Diurnal tidal ranges (U.S. Department of Commerce, 1975b) of 1.4 ft (0.42 m) and 1.7 ft (0.52 m) are given for Galveston Channel and Aransas Pass, respectively, and within the bays the periodic tide has a range of less than 0.5 ft (15 cm). With these low astronomical tides, wind stress becomes a relatively important influence on water levels. Winter northerly winds tend to lower water levels in the nearshore Gulf of Mexico, while the onshore component of the summer southeasterly winds tends to raise water levels. These effects are evident on Landsat imagery; therefore wind direction and velocity summaries were prepared from published data (appendix C) as an aid in the interpretation of each scene. Actual records of water levels at the time of satellite passage were obtained from gages located within the test site and maintained by the Galveston District of the U.S. Army Corps of Engineers.

No phase of this investigation dealt directly with the physical results of hurricanes, since a major hurricane has not struck the Texas coast in the last five years. Hurricanes, however, have a tremendous impact on the Texas coastal zone, and the effects of such a storm are felt, on the average, once every two to three years (Fisher and others, 1972).

#### 4.0 CLASSIFICATION SCHEMES FOR USE WITH LANDSAT DATA

##### 4.1 Development of a Land Cover and Land Use Classification Scheme

In establishing a workable classification system for land cover and land use within the Texas Coastal Zone, J. R. Anderson's (1971, 1976) multilevel system was modified to meet the needs of this investigation. The areas of emphasis were the monitoring of wetlands, other land uses,

Added  
to  
FWS  
Wetland/

beaches and dunes, and bay systems. The resulting scheme (table 7) contains 23 secondary classes, 14 of which are specifically oriented toward uniquely coastal geologic processes and biologic assemblages. Categories in the standard system that are not applicable to the coastal environment were deleted, while wetlands were expanded from two to five categories, and water was subjectively classified on the basis of turbidity. The number codes assigned to each of the 23 subcategories were consistent with the U.S. Geological Survey system (J.R. Anderson, 1976). Most secondary categories carry a three-digit code, indicating that they would be considered specialized units of regional interest, or Level III units, when placed in the context of the national system.

All wetland units, for example, are subunits of Nonforested Wetland, coded 62 in the standard system. Water was not classified at Level II because the designation of lakes, streams, estuaries, etc., is readily available to the intrastate user from supplementary information, and turbidity distribution as an indicator of surface-water circulation patterns was considered more important for coastal management purposes.

Although wetlands may be defined on the basis of elevation references such as the mean high tide mark (Clark, 1974), it would perhaps be more meaningful to define coastal wetlands as areas that are near sea level and adjacent to bay, lagoonal, or fluvial water bodies and that naturally contain plants tolerant of inundation, as by tidal or wind-tidal action. Swamps contain primarily woody vegetation in contrast to marshes, which are dominated by grasses and which are often mapped as fresh, brackish, or saline marsh associations, depending on species content. Erb (1974) found that only salt marshes could be mapped consistently from Landsat film data and that delineation of fresh and brackish marshes

Table 7

LAND COVER AND LAND USE CLASSIFICATION FOR USE WITH  
UNENHANCED LANDSAT DATA IN THE TEXAS COASTAL ZONE

1*	Urban or Built-up Land	(13)	Ui-Industrial
		(131)	Ue-Extractive-hydrocarbons
		(14)	Ut-Transportation
		(16)	U-Mixed Urban
2	Agricultural Land	(21)	A-Cropland
3	Grassland/Rangeland	(31)	G-Range-pasture
		(311)	Gd-Vegetated dunes
		(312)	Gb-Vegetated barrier flat
		(32)	Gbr-Brushland
4	Forest Land	(43)	WO-Woodland or dense chaparral
5	Water	(501)	WA-Non-turbid
		(502)	WAst-Slightly turbid
		(503)	WAm-Moderately turbid
		(504)	WAt-Highly turbid/very shallow
6	Wetland	(621)	Wlm-Topographically low marsh
		(622)	Whm-Topographically high marsh
		(623)	Wtf-Tidal flat
		(624)	Wga-Seagrasses and algal flats
		(625)	Ws-Vegetated dredge spoil
7	Barren Land	(72)	B-Beaches
		(731)	Bd-Dunes
		(732)	Bds-Dredge spoil barren
		(77)	Bu-Undifferentiated barren land

---

\* Numbers refer to system in J.R. Anderson and others (1976).

met with limited success.

Study of the Texas coastal region indicates that the marshes could be divided into topographically high and low categories which appear to differ primarily in water content and in reflectivity of the vegetation on the Landsat false-color composite image. Computer classification of Landsat digital data for a test site near Galveston Bay (Erb, 1974) indicates a transition between the reflectivity of low, wet marsh groups and higher, drier zones which is related to the percentage of open water and soil moisture variations rather than to the changes in vegetation type.

The Level I category of Wetlands has been subdivided (table 7) into five units in order to extract as much information as possible from the Landsat data; each of these is briefly described. The two marsh categories do not imply a particular assemblage of species regionwide; instead, field checking has shown that the same group of species generally occurs within a category throughout a test site. Local exceptions are found where river influx creates a fresh-to-brackish-water environment or where tidal inlets admit water of full marine salinity.

Tidal flats are wetlands with sparse or no vegetation which occur on the bay margins of the barrier islands, adjacent to the marsh wetlands, and along the mainland margin. South Texas contains the greatest extent of tidal flats, which result from the extremely shallow depth of Laguna Madre, the low-lying topography of the abandoned Arroyo Colorado delta, and the presence of shallow, generally barren depressions throughout the area which are connected to the lagoon. Algal flats and subaqueous grass flats also occur most widely in South Texas. The algal flats occur as thick, sediment-binding mat on the surface of the extensive tidal flats. The largest seagrass beds are found within the lagoon.



near Brazos Santiago Pass, where the circulation of Gulf waters helps maintain an environment favorable to their growth. Vegetated dredge spoil is classified as a distinct wetland mapping unit because of its composition and biologic assemblages. Vegetated spoil is readily detectable on the Landsat imagery on the basis of its form and position relative to dredged channels. Its reflectance is similar to that of topographically high marsh, and field checking has indicated that many of the same plant species are found in both units. Since the presence of dredge spoil, either vegetated or barren, represents an important alteration of the coastal environment by man, the ability to detect this unit on repeated satellite imagery is significant for coastal zone management purposes.

The classification system shown in table 7 is strongly oriented toward the image-interpretation process. An interpreter with a background in coastal processes and familiarity with the Texas coastal environment can distinguish the secondary classes on the basis of radiance, texture, shape, and spatial position of an area in relation to other features seen on the Landsat imagery. It was recognized that the classes derived from digital processing would not precisely correlate with those delineated during the image-interpretation procedure. An example of such a disparity is the division of a tidal flat, during digital processing, into several classes on the basis of reflectance differences due to varying moisture content. These classification dissimilarities were resolved by side-by-side comparison of visually interpreted and digital products, as well as by use of supplemental data.

#### 4.2 Land Cover and Land Use Classification for Computer-Assisted Analysis

In the analysis of computer-generated products developed from scenes covering test sites 2, 3, and 5 earlier in this investigation, the resulting computer classes were matched only in a general way to the land cover and land use classification scheme developed for image interpretation of the Landsat data. Their relationship was established by visual correlation of the computer-generated maps with aerial photography and other ground truth data. This procedure was sufficient to determine that some computer classes could be related to the classification scheme and that, in other cases, various combinations or "splitting" of classes needed to be done to improve the correlation. In addition, there had not been an effort to match the various computer-generated classes from one Landsat scene of the test site to those of another scene covering the same site, nor to standardize the symbols used on the line-printer maps.

However, development of the change detection program (DETECT, appendix D) created a need for (1) detailed correlation of classes displayed on the computer-generated maps from each scene, which were to be compared for change detection, and (2) the use of standard symbols. Consequently, the 1:24,000 scale maps generated from the four Landsat scenes covering test site 4 were compared in detail with the image-interpretation classification scheme, and computer classes were combined to fit as nearly as possible to that scheme. The results indicated that each computer class could be assigned to one of the Level I classes, but only the water and wetland classes could be mapped at Level II or Level III listed on the classification scheme developed for direct photo interpretation of Landsat imagery. Thus, the four Urban or Built-up Land classes, the four Barren

Land classes, and one of the Wetland classes (Vegetated Dredge Spoil) could not be distinguished as unique computer classes on these particular maps. The result is an adjusted classification scheme for the computer-assisted analysis of Landsat scenes, as shown in table 8.

It is highly likely that by continued correlation with ground truth data and subsequent refinement of the various land use and land cover classes, additional classes could be mapped using the computer-assisted techniques. However, it was realized from the outset of this investigation that classes derived from Landsat digital data by computer-assisted techniques which utilize only spectral information might not precisely correlate with those delineated using the image-interpretation techniques, since both spectral data and other information are used by the interpreter. For example, Beaches, Dunes, and Barren Dredge Spoil in a given area are likely to appear identical from the analysis of spectral data alone, but can be differentiated on Landsat images when shape and association with other features are considered.

On the other hand, analysis of spectral characteristics alone can produce a large number of classes, typically 30 to 40 within the area of a single 7 1/2-minute USGS topographic map. The difficulty lies in grouping these classes into the scheme which will provide the most useful information. This investigation began with a classification scheme which was clearly designed for human interpretation and was subsequently adapted to the computer-assisted techniques. The result is that essentially a Level I classification can be derived by computer techniques, with some finer detail in one or two categories. For application of these techniques to future projects, it may be that a classification scheme designed to optimize spectral characteristics could provide more detailed maps--

that are still meaningful to the user--than is possible from the current procedure.

Table 8

LAND COVER AND LAND USE CLASSIFICATION  
FOR USE WITH LANDSAT COMPUTER-COMPATIBLE TAPES

	<u>Printer Symbols</u>
1. Urban or Built-up Land	]
2. Agricultural Land	#
3. Grassland/Rangeland	\
4. Forest Land	&
5. Water	
Non-Turbid	G
Slightly Turbid	A
Moderately Turbid	Z
Highly Turbid/Very Shallow	=
6. Wetland	
Topographically High Marsh	X
Topographically Low Marsh	>
Tidal Flat	%
Seagrasses and Algal Flats	-
7. Barren Land	'

## 5.0 COMPUTER-ASSISTED ANALYSIS

The classification of multispectral data through the use of computer-assisted techniques is based on a type of "pattern recognition" which utilizes measurements made at a single point rather than spatial relationships. These measurements represent energy sensed at particular wavelengths in the electromagnetic spectrum and can be made using either imaging or non-imaging sensors. In addition, computer-assisted classification employs the discipline of statistical decision theory.

There are basically two different approaches (supervised and unsupervised) for computer-assisted classification of Landsat MSS data. They differ primarily in the order in which the analysis steps are carried out. In a supervised classification, the analyst uses ground truth information to identify and delineate training fields on the ground which contain a specific type of homogeneous material or a specific category of land use (Eppler, 1976). The computer then uses the data from within these training areas to establish statistics for each class or category of interest. Using the resulting statistics, the computer goes throughout the entire Landsat scene, or a selected portion of the scene, and assigns each pixel (picture element) to one of the classes, using statistical decision theory.

The unsupervised classification approach carries out these same steps, but in a different order. The computer first groups all samples from the Landsat scene into clusters based on spectral similarity according to parameters established by the analyst, such as the maximum standard deviation, minimum separation between two adjacent cluster means, minimum number of points per cluster, maximum number of clusters, and so on. These clusters are then displayed to the analyst (as a line

printer map, for example), who assigns each cluster to a land cover and land use class or category based on available ground truth information and knowledge of the area imaged by the Landsat scene.

A glossary of terms relating to computer-assisted analysis is contained in appendix E.

## 5.1 Analytical Techniques

### 5.1.1 Introduction

Early examination of available software and techniques for both supervised and unsupervised classification of Landsat data provided information as to the most efficient software and classification approach to utilize (appendix F). Results indicated that an unsupervised type approach for classifying a coastal environment was preferred. Programs available from NASA were considered adequate for the basic classification task but somewhat deficient in other areas. As a result, various programs were written by TNRIS staff to enhance the displayed classification results and to facilitate correlation efforts. The computer system used was the UNIVAC 1100/41 with associated disc packs, mag tape units, and other hardware.

### 5.1.2 Software Support

Following are brief descriptions of the programs utilized for computer analysis of test site 4:

#### (1) NASA-Acquired Software

- (a) DAM Package - The Detection and Mapping package (DAM-7605) is a user-oriented system designed to accurately detect and map water from Landsat MSS data utilizing spectral bands 4 and 7 (Schlosser and Brown, 1976).

Components of the DAM package include:

- Manual procedures
- Computer programs
- Special graphics devices

The five general steps involved in processing a Landsat scene with the DAM package are:

- Acquire data (Landsat tapes and base maps)
- Establish control network (PICTAB and CONTROL)
- Determine spectral limits (CLASSIFY)
- Generate maps (PRTCLASS)

(b) GRAYMAP - The GRAYMAP program is part of the Earth Observation Division (EOD) version of the system called LARSYS developed by the Laboratory for Applications of Remote Sensing, Purdue University (NASA/JSC, 1974). GRAYMAP provides the analyst with a pictorial gray-scale map of any channel from the multispectral imagery for use in obtaining training field coordinates or project site boundaries. The map is labeled by sample number and scan line number. From this map, the analyst may locate the fields or areas within the image for which there is ground truth data. Since the output device (a line printer) used to make the maps has fewer symbols than the typical 64 to 128 gray-shades allowed by the Landsat MSS, a reduction in the number of gray-shades must be made. The analyst may define the symbols and corresponding range of data values for each symbol or allow the processor to compute the ranges from a histogram in a manner

which allows for equal "activity" for each of ten standard symbols chosen to produce a wide range of gray-shades.

- (c) ISOCLS - This is also an EOD-LARSYS product (Minter, 1972) which groups together pixels that are "similar" in radiance values. The procedure may be used to break multimodal class training data into unimodal subclasses that more closely meet the normality assumption of the maximum likelihood classifier. It may also be used independently of the other processors to perform unsupervised pattern recognition. ISOCLS is an iterative self-initializing clustering procedure which uses the measure of absolute distance from a pixel to the cluster center to determine "similarity" of pixels. The processor computes the cluster statistics (mean vector and covariance matrix for each cluster) and creates a file containing these statistics which are required for the subsequent classification task. The ISOCLS output includes tabular listings of the cluster means and standard deviations for each band and the distance between clusters. It displays a portion of the Landsat scene which has been clustered (represented by internally assigned symbols).
- (d) ELLTAB TABLE & CLASSIFY - (Elliptical Table) derives its name from the shape of the table it builds. The look-up table for each class is a computer represen-



tation of a hyperellipsoid in four-dimensional space. ELLTAB (Jones, 1974) is broken into two phases, the training phase and the table look-up phase. In the training phase, statistics previously generated by ISOCLS from training fields or selected areas are used to build a look-up table. In the look-up phase, raw Landsat data representing the area of interest are compared to the look-up table and subsequently classified and output as a classification file. The essence of the look-up approach is that during classification, a remotely sensed "unit" or pixel is assigned to a category by merely looking up its channel readings in a table instead of making the lengthy calculations required in a maximum likelihood computation.

- (e) HGROUP - Through the use of a set of class means derived from ISOCLS that have been normalized, HGROUP (NASA/JSC, 1976) performs a stepwise combining of classes. At each step, HGROUP combines two classes that have the closest set of means. After combining two classes, a single set of means is generated for the combined class. The program continues combining classes until only two classes remain. With the help of a cumulative error function generated at each step, HGROUP can be used to combine the original set of subclasses into the final set of classes of interest (figs. 6, 7, and 8). Appendix:

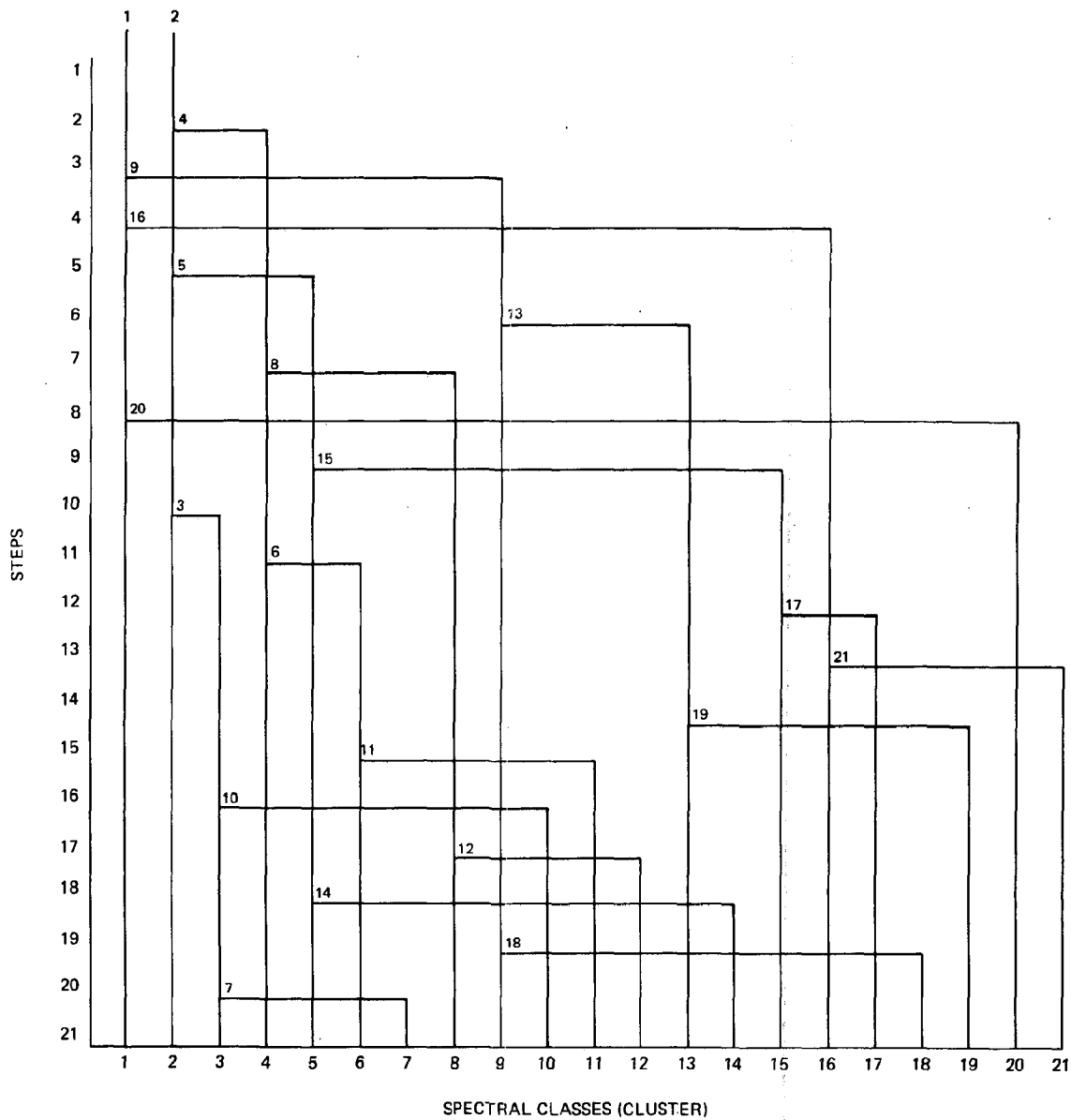

Figure 6. Circuit diagram derived from HGROUP program output.

At each iteration (step) the radiance values of all groups are compared and the two classes with the smallest combined inter-class variance are merged. This continues until only two major groups, containing all classes (clusters), remain. Those classes combined first have the smallest spectral deviations. The output values from the HGROUP analysis are manually plotted in this format (NASA/JSC, 1976).

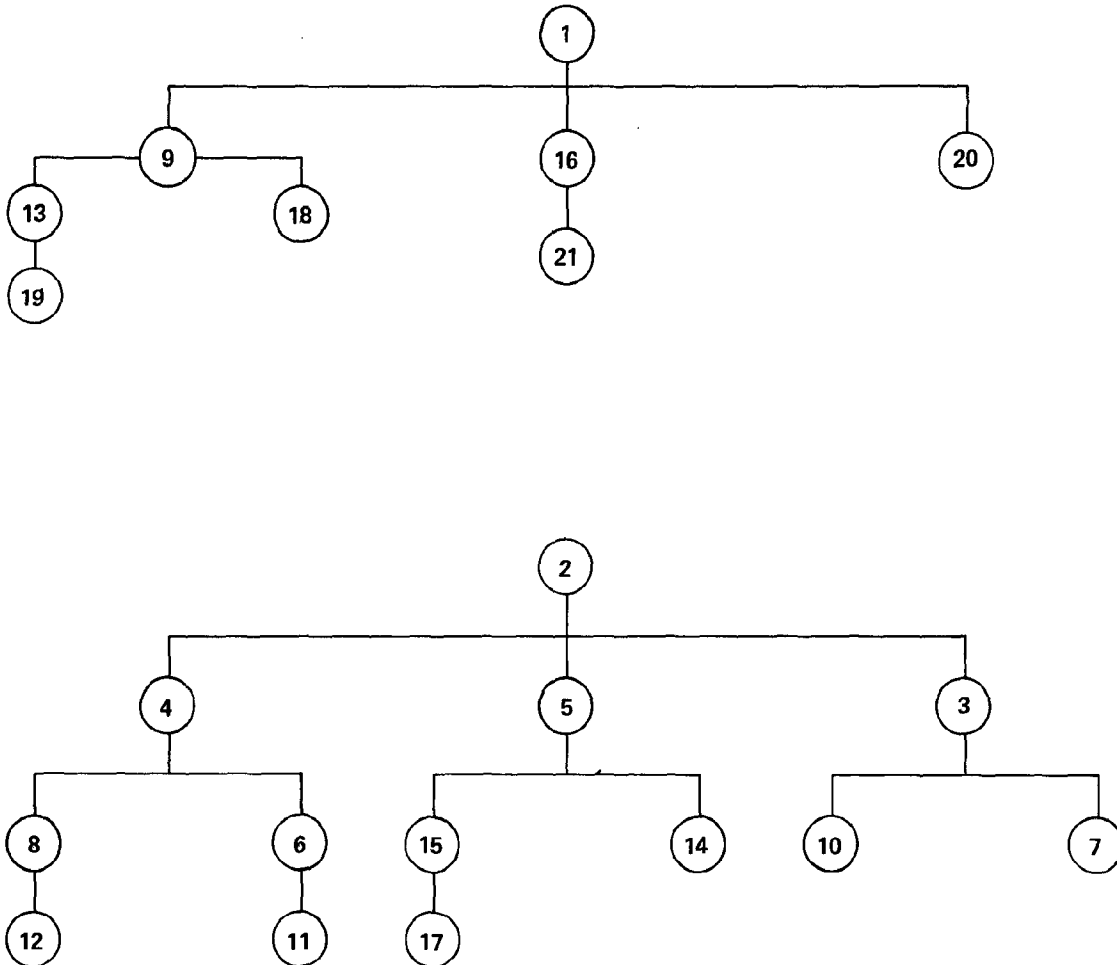

Figure 7. Sample sequential tree derived from HGROUP program.

The sequential tree is derived by tracing downward through the circuit diagram (fig. 6) and identifying each class (cluster) that belongs to one of the two primary groups (NASA/JSC, 1976).

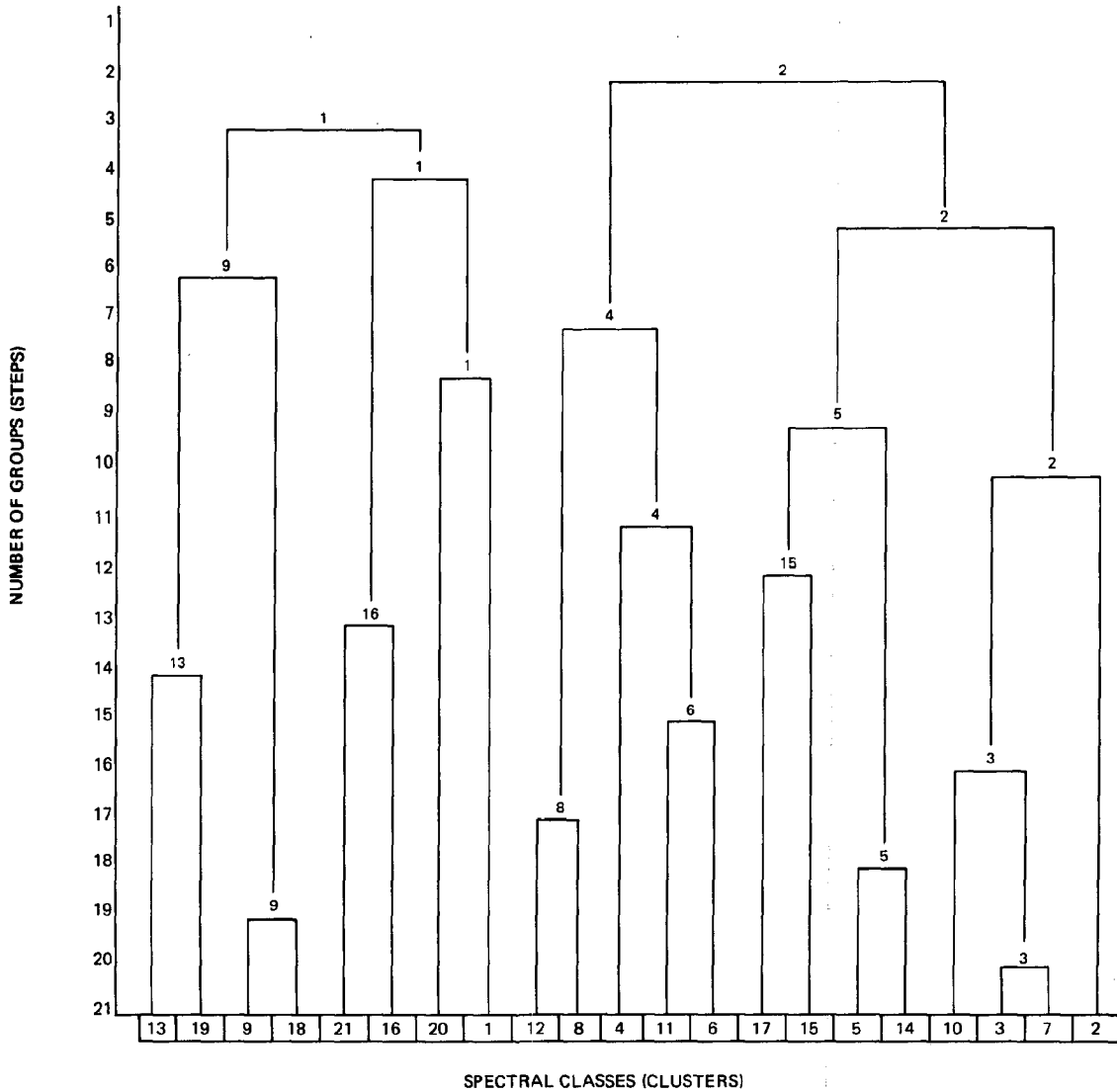

Figure 8. Stepwise hierarchical tree derived from HGROUP program.

The hierarchical tree (constructed from the previous two diagrams) depicts the various spectral clusters which can be combined at any particular step to provide the number of groups (clusters) desired. For example, at step 5, there are five distinct classes (9, 17, 1, 4, and 2) derived from 21 possible classes (NASA/JSC, 1976).

D contains the program steps for HGROUP.

- (f) ERTS-DUP - This program, contained in DAM 7605, copies an original Landsat MSS tape onto a reel of blank computer tape. If unrecoverable tape errors occur, it rewinds both tapes and tries a second time. Once a successful copy is made, ERTS-DUP identifies the Landsat scene and terminates the computer run (Schlosser and Brown, 1976).

(2) TNRIS-Developed Programs

- (a) SCALE-REGISTER - Using the ELLTAB classification results and various files derived from the DAM processing, SCALE-REGISTER (appendix D) creates a custom formatted and scaled line printer map, at any standard scale between 1:24,000 and 1:260,000 (derived from the DAM capability), depicting the classified data resulting from ELLTAB.
- (b) MR-CLEAN - This program (appendix D) improves the spatial homogeneity of the classes by eliminating "noise" or the "salt and pepper" effect inherent in most computer displays. This program examines each pixel in the classification file, along with its neighbors (above and below, left and right, and diagonally). The pixel's class is then redefined to be that of the majority of this set. If the symbol representing a particular feature is to be left alone, an input to the program will cause that class to be bypassed. This program helps produce more

uniform fields having less complicated boundaries.

- (c) DETECT - This program compares two classification maps of the same area and produces a map that reflects temporal change between the two scenes. Each scene is classified and registered separately. However, the same symbol must be used to represent the same class in each scene. The program compares the two registered scenes line by line and pixel by pixel. If two corresponding pixels are similar, a blank is printed on the change detection map. If the pixels are different, the symbol from the later scene is printed and represents a change (appendix D).
- (d) EXTRACT - Boundaries are extracted from classified data (appendix D) in the form of chains of points which can be utilized by the Geographic Information System (GIS) under development as part of the Texas Natural Resources Information System. Boundary extraction enables the GIS to produce pen plots from the Landsat boundary files at a scale smaller than 1:24,000 without the loss of information that occurs in line printer plots when lines and samples are dropped.
- (e) MERGE - A program was developed which allowed portions of two adjoining CCTs to be merged to form a single tape. The number of data columns in the "merged" tape cannot exceed the number of columns in a standard CCT (810 samples for Landsat 1 and 816

samples for Landsat 2). All of the lines can be included. This program is useful for obtaining ISOCLS statistics from the test sites that cover portions of two CCTs but are less than the width of one CCT.

## 5.2 Analytical Procedures

### 5.2.1 Site Classification

In an effort to organize the programs previously described into a logical and efficient method for analysis of Landsat data and incorporate various pre-established analysis techniques, a procedural scheme called "site classification" was developed. The specific steps involved in the scheme are listed in table 9.

This method enables the user to: (1) classify MSS data, (2) display the results in a map-like format, and (3) correct or improve the classification results.

The following paragraphs will briefly describe the steps required to conduct a site classification.

#### Pre-Classification Procedures

Referring to table 9, the first steps in conducting the site classification relate to selecting the Landsat scene and to evaluating the quality of the data. The procedures and criteria used in identifying, evaluating, and ordering the Landsat imagery and digital data (steps 1 to 5) were discussed in section 3.3. Upon receipt of the Landsat imagery and CCTs, they are indexed into the TNRIS as described in section 3.3. The CCTs are then duplicated using the ERTS DUP Program to check tape quality and possible format-related problems. If the four Landsat CCTs

Table 9

STEPS REQUIRED IN SITE CLASSIFICATION  
USING COMPUTER-ASSISTED TECHNIQUES

Pre-Classification Procedures

1. Identify potential Landsat scenes through inquiry to EROS Data Center (using TNRIS facilities).
2. Obtain climatological/meteorological (precipitation, tide, wind, etc.) and other data as needed for site to be analyzed (through TNRIS).
3. Evaluate Landsat scene quality from EROS printout and browse files (using TNRIS facilities).
4. Compare available Landsat coverage with corresponding climatological/meteorological/other data.
5. Select and order Landsat imagery and CCTs and compile ground truth/supportive data (through TNRIS).
6. Index Landsat imagery and CCTs into TNRIS.
7. Duplicate and possibly merge CCTs. (ERTS DUP and MERGE)
8. Generate grayscale maps of the area for each channel. (GRAYMAP)
9. Conduct an orientation field trip.
10. Establish the scene control network. (PICTAB and CONTROL)

Classification Procedures

1. Establish parameters, select training areas, and obtain statistics. (ISOCLS)
2. Examine ISOCLS statistical results and, if required, change parameters and rerun ISOCLS.
3. Build the ELLTAB look-up table classifier. (ELLTAB TABLE)
4. Classify the project area. (ELLTAB CLASSIFY)
5. Classify water bodies. (DAM)
6. Evaluate cluster statistics and combine clusters, if needed, to aid in correlation. (HGROU/Means Plots)



Table 9 (Con't)

STEPS REQUIRED IN SITE CLASSIFICATION  
USING COMPUTER-ASSISTED TECHNIQUES

Classification Procedures

7. Register and display results as a "cluster" map. (SCALE-REGISTER)
8. Assemble map strips from DAM and SCALE-REGISTER.
9. Correlate display results with ground truth/supportive data.
10. Evaluate classification results.
11. Enhance display if satisfied with results. (MR-CLEAN)
12. Initiate refinement procedures if dissatisfied with results.

Refinement Procedures

1. Combine two or more clusters representing same class of interest. (SCALE-REGISTER)
2. Generate new statistics for problem area or class.(ISOCLS)
3. Evaluate statistics.
4. Rebuild ELLTAB TABLE with additional data included.
5. Classify the project area. (ELLTAB CLASSIFY)
6. Display classification results. (SCALE-REGISTER)
7. Evaluate display results.
8. Repeat refinement steps 2 through 7 if dissatisfied with results.
9. Enhance final results when satisfied.(MR-CLEAN)

Supplemental Capabilities

1. Determine feature changes that have occurred over a period of time. (DETECT)
2. Extract boundaries from classified data.(EXTRACT)

are contained on a single tape, they are duplicated onto individual tapes for compatibility with the DAM Program. Occasionally, the project area to be displayed may lie within two or more CCTs. If this is the case, designated portions of the two CCTs are combined using the MERGE Program (appendix D) in order to store the entire analysis site as a single file to aid in the ISOCLS clustering step later on.

The digital data quality of a Landsat scene is further evaluated by generating a GRAYMAP computer printout display (NASA/JSC, 1974). A display of the site to be analyzed, using all four channels, may reveal the presence of scanner irregularities that are not observed by review of the imagery. A display at this time also serves as a means for establishing the project site boundaries as related to the associated maps.

At this point in the analysis, a visit should be made to the test site for familiarization with major features. Information obtained from this visit will be of benefit in the analysis and classification of Landsat MSS data.

The next step is to establish a control network for the Landsat scene. This requires the use of programs and procedures in the Detection and Mapping (DAM) package (DAM-7605). The DAM package is designed to detect and map surface water (Schlosser and Brown, 1976). The required control network programs from DAM-7605 include PICTAB and CONTROL. PICTAB produces line printer displays of selected areas for locating potential control points and their related scanner coordinates (line and sample numbers). Figures 9 and 10 show an example of a PICTAB display and the corresponding area on a USGS topographic map. The scanner coordinates, along with their corresponding geographic coordinates,

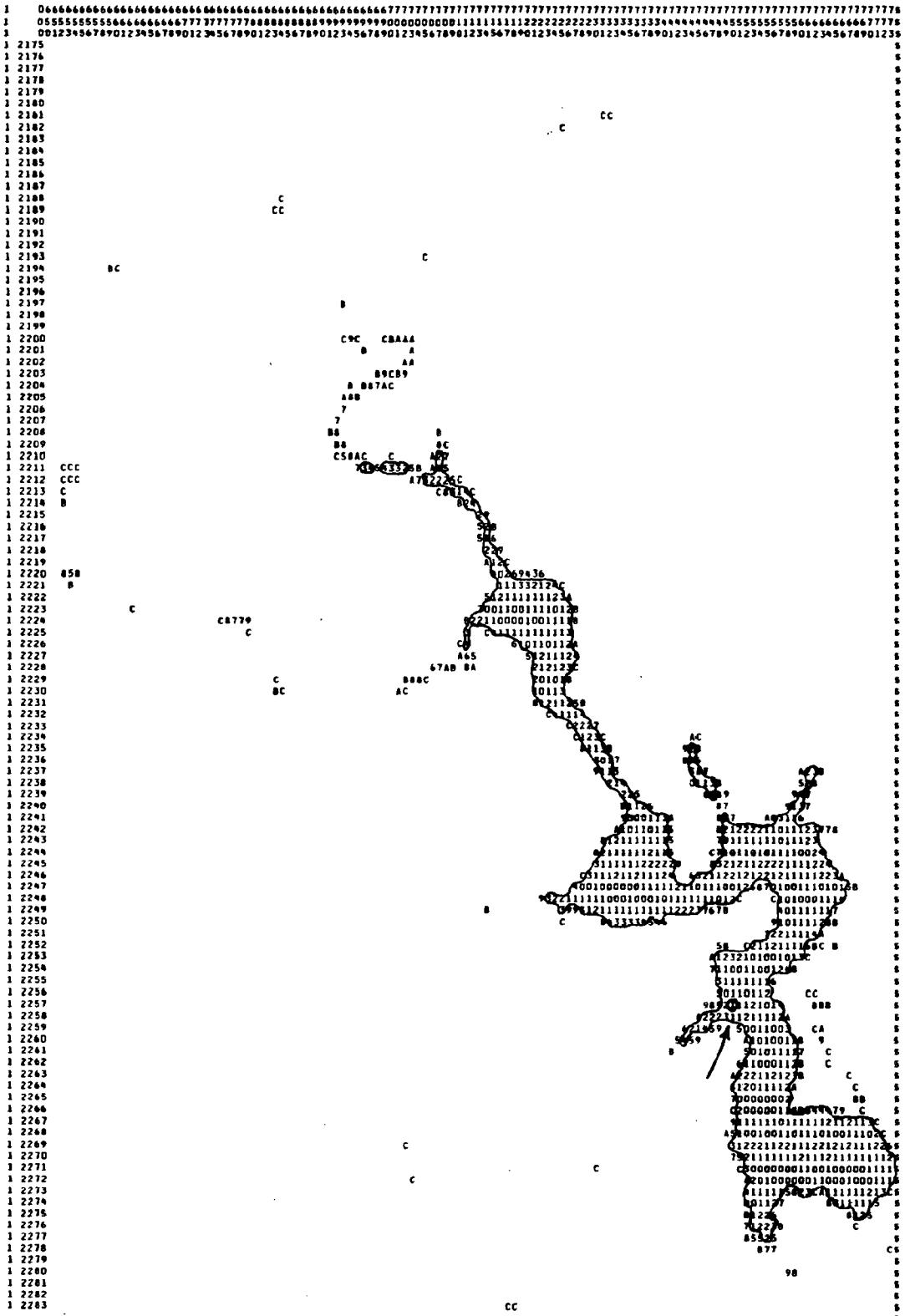

Figure 9. Example of PICTAB display.

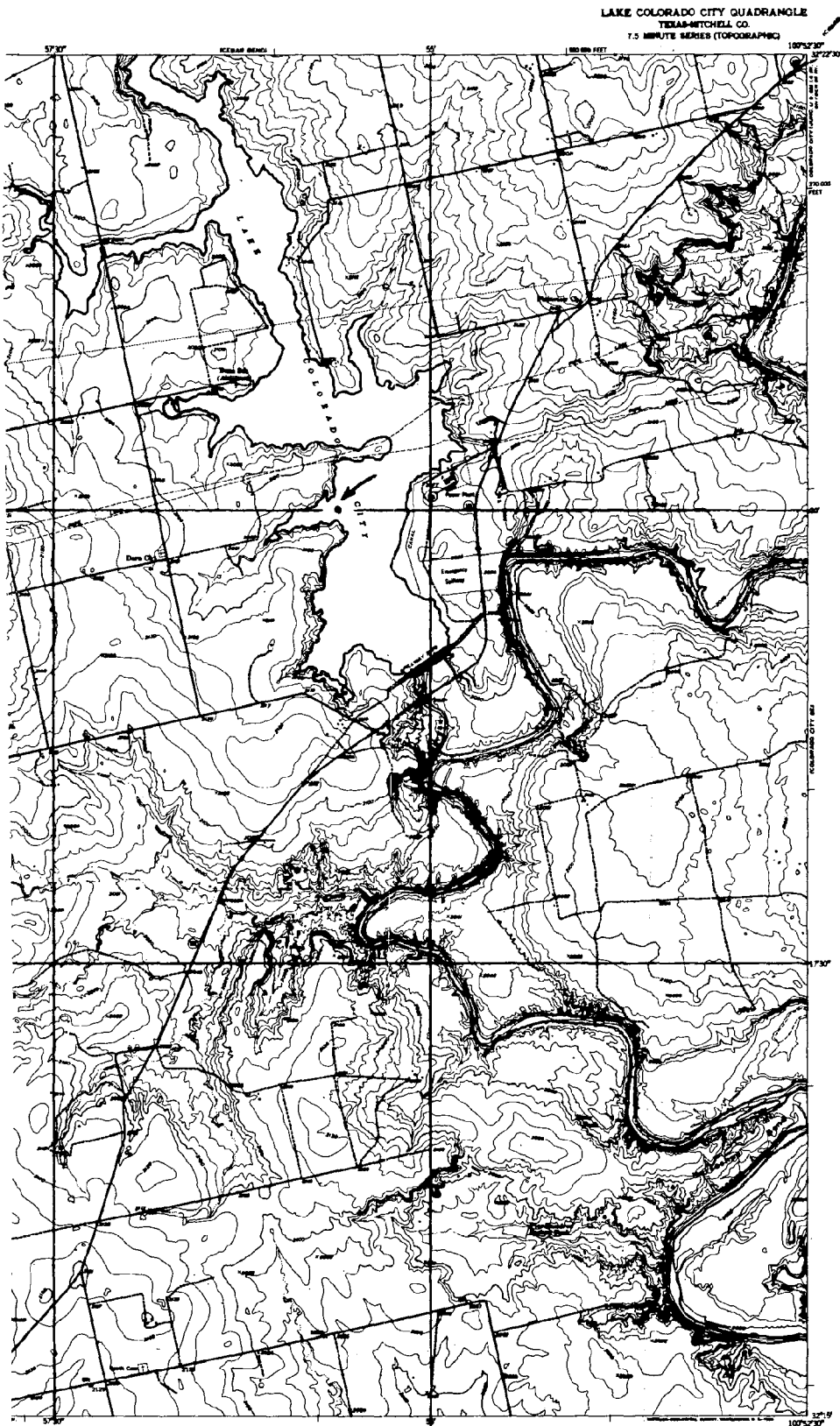

Figure 10. Portion of the USGS topographic map corresponding to the area of the PICTAB display in fig. 9.

are utilized by CONTROL to compute transformation coefficients. These coefficients are necessary for generation of a registered computer display map of the classified features. Appendix G includes the resulting control network for several of the Landsat scenes which were analyzed during this investigation.

### Classification Procedures

Initial classification of selected multispectral Landsat data begins with ISOCLS (Minter, 1972). The ISOCLS processor interactively assigns each MSS data point or pixel to a specific cluster by determining the nearest cluster center and assigning the sample to it.

Clustering is performed on training areas of various sizes selected so that they include representative samples of all land cover and land use photography, GRAYMAP displays, and other ground truth and supportive data.

Table 10 lists ISOCLS parameters which influence the statistical quality and quantity of clustering results and includes those parameter values which experience has shown to be useful for analysis of coastal zone classes. The definition of each parameter is as follows:

- (1) CHANNELS - MSS channels used for cluster determination.
- (2) ISTOP - Perform N iterations of the clustering procedure and stop.
- (3) NMIN - Delete any cluster with fewer than N members.
- (4) DLMIN - Combine any two clusters whose means are closer than X units.
- (5) SEP - Upon splitting a cluster, separate the new clusters by a distance of X units.
- (6) STDMAX - Split any cluster whose maximum standard deviation is greater than X units.
- (7) MAXCLS - Maximum number of clusters generated.

Clustering is usually performed on every other line and column of data; however, intervals may occasionally be enlarged slightly to save computer time and costs.

Table 10  
ASSIGNED PARAMETER VALUES

CHANNELS-All channels used (4)  
ISTOP - 10  
NMIN - 20  
DLMIN - 2.0  
SEP - Default (maximum of the channel's standard deviation)  
STDMAX - 3.0  
MAXCLS - Default (50 clusters)

The statistical results of the initial ISOCLS run are then examined to determine whether or not the clusters appear satisfactory for building the ELLTAB look-up table. For example, there can be no more than 40 classes and the standard deviations for each cluster mean must be reasonably narrow since the size of the ELLTAB table which can be constructed is limited by the program. If the results are not satisfactory, the parameters in table 10 need to be changed and the ISOCLS run repeated. Another approach which may be used to improve the statistics is to delete clusters with unusually high standard deviation and/or clusters with small member representation. HGROUP (NASA/JSC,1976) can also be used for reducing the number of clusters by combining spectrally similar clusters (figures 6-8).

ELLTAB TABLE and ELLTAB CLASSIFY (Jones, 1974) are utilized for classifying the multispectral (MSS) Landsat data. ELLTAB TABLE builds a classification look-up table based on cluster statistics, and ELLTAB CLASSIFY compares the radiance values of unclassified input data to the values in the table. Classification can be performed on a maximum of 40 clusters and the results may be saved on tape for later usage. Figure 11 shows the steps involved in the ELLTAB process.

Following the ELLTAB classification of MSS data covering the entire project site, data points representing water are classified and displayed. DAM-7605 programs consisting of CONTROL, CLASSIFY, and PRTCLASS are used for this purpose. DAM-7605 results consist of (1) a computer-generated printout display at a specific scale showing the location of each point classified as water (figures 12 and 13), (2) a listing of selected incremental geographic coordinates which correspond to latitude and longitude symbols on the display, (3) an optional tabular listing of pixels classified as water, and (4) an internally created density file containing information related to display registration.

The ISOCLS statistics (means and covariances) for clusters used to build the ELLTAB TABLE are then examined in light of the land cover and land use classes of interest in an attempt to reduce the number of individual clusters if the total number is considered to be clearly excessive. The HGROUPE Program is useful in this step. Another technique which was utilized in the latter part of this project involved the preparation of "means plots." The "means plots" are prepared by plotting the four means from each of the spectral bands for each cluster generated by the ISOCLS process. The band 7 values are doubled to provide better visual correlation with typical reflectance curves (fig. 14).

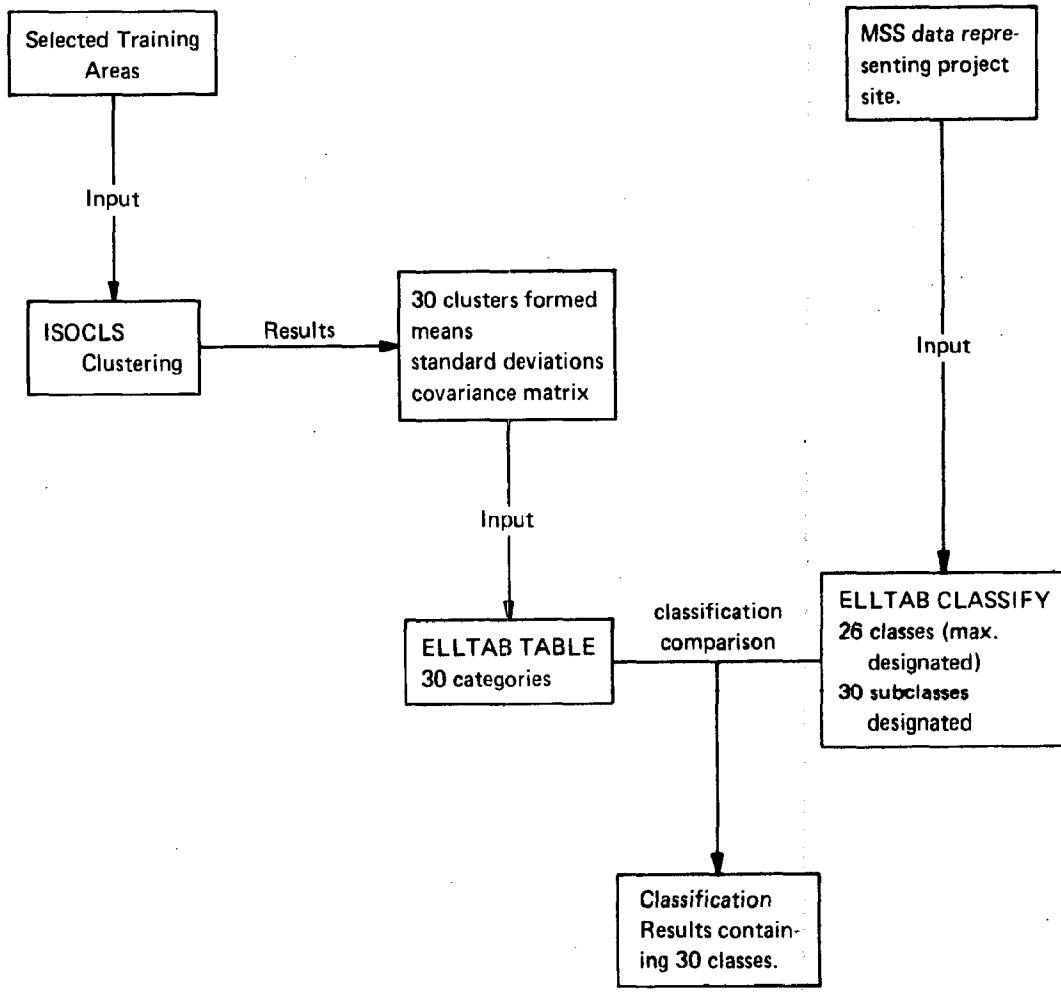

Figure 11. ELLTAB classification assuming 30 clusters as an example.



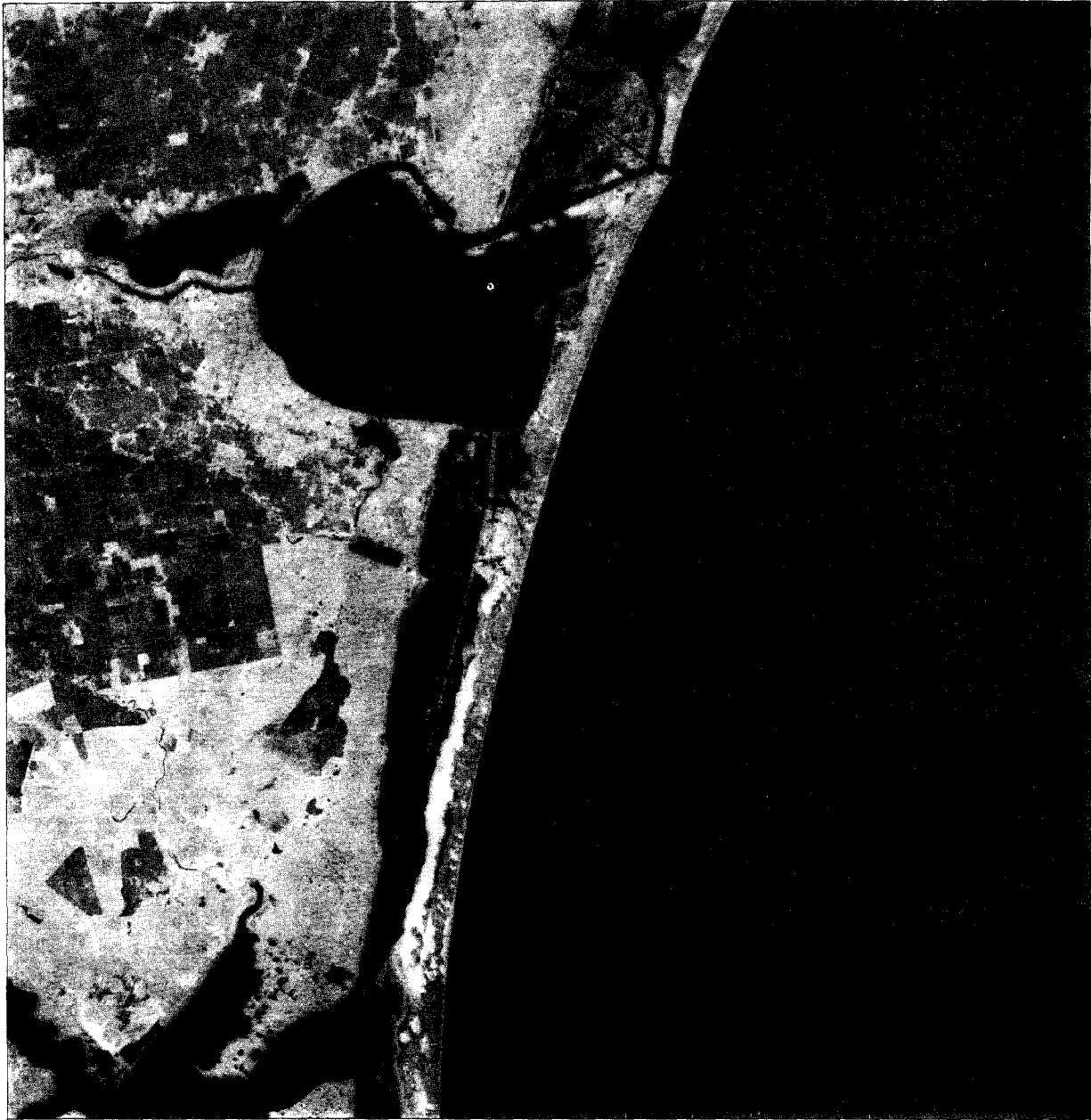

Figure 12. Portion of Landsat scene depicting area mapped by the DAM package in fig. 13.

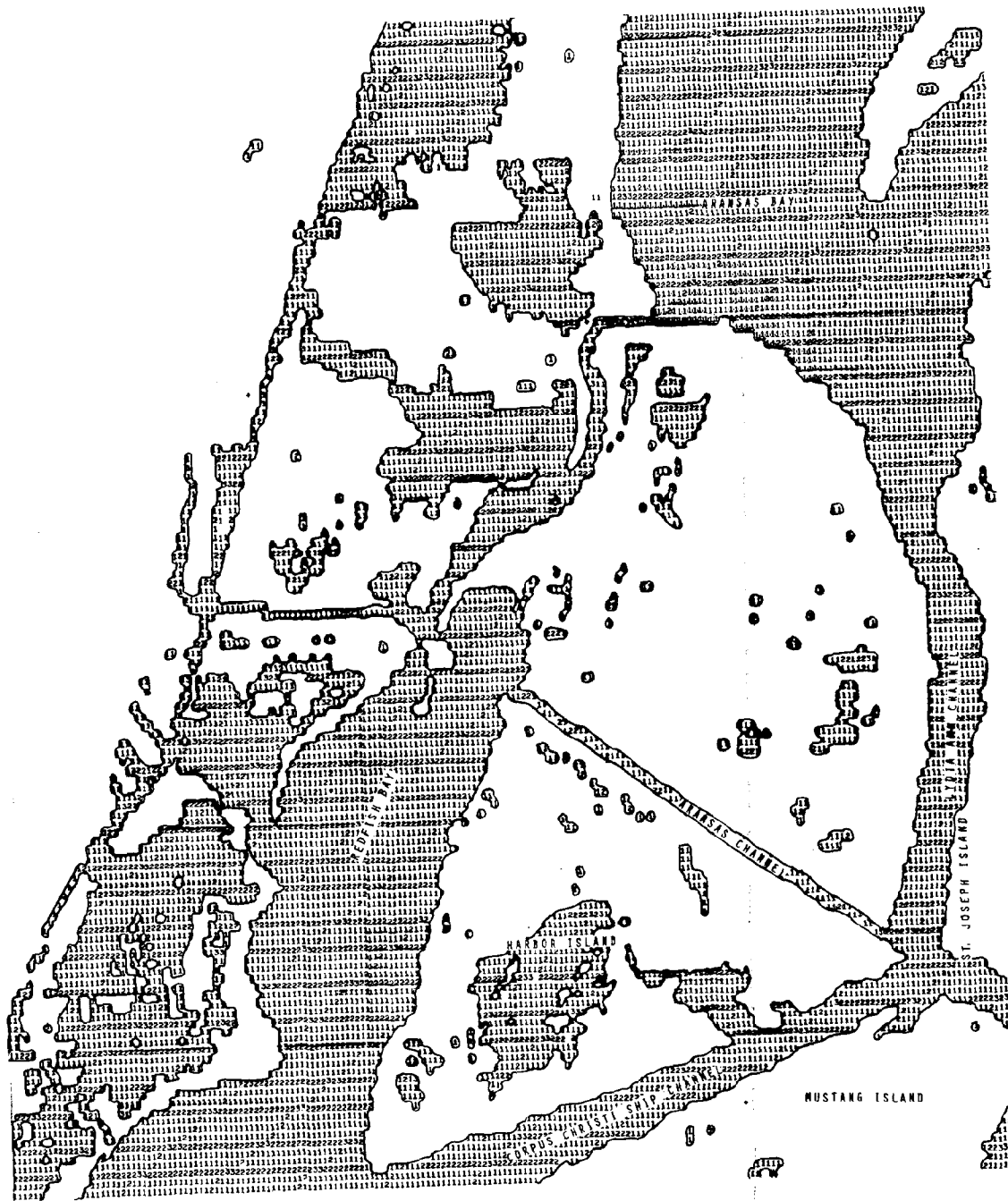

Figure 13. Example of display from Detection and Mapping (DAM) package showing two categories: water and "other."

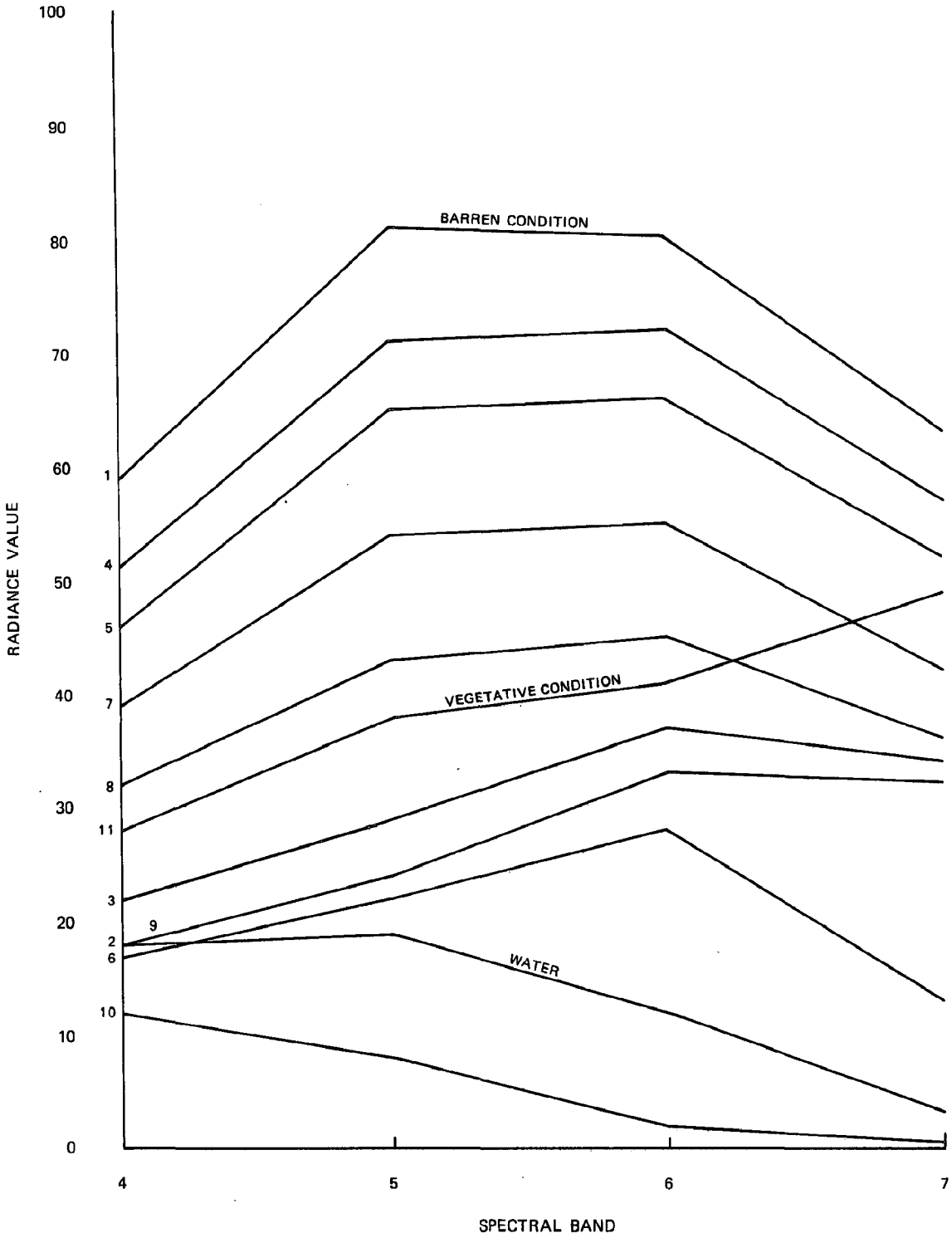

Figure 14. Plot of spectral means derived from ISOCLS results.

With all classification tasks completed (ELLTAB, DAM-7605), the results are displayed through the use of SCALE-REGISTER. Required ELLTAB classification files and DAM-7605 files may be made immediately available to SCALE-REGISTER by submitting all three programs as one continuous run. SCALE-REGISTER creates a custom formatted and scaled line-printer map of classified data at any standard scale between 1:24,000 and 1:260,000. User-selected program parameters enable the user to manipulate the display symbols to simplify correlation and to enhance the display of various features.

Several line-printer strips are generated by the SCALE-REGISTER Program for each test site (typically four to cover a block of four USGS 7 1/2-minute topographic sheets). These strips must be assembled, taped together, and the USGS map boundaries drawn to aid in the subsequent correlation and evaluation steps. To further aid in the analysis, the individual classes may be outlined with ink or hand-colored, but this is an extremely time-consuming process.

Following assembly of the map strips, the next step is identification or classification of each spectral cluster on the display map according to the land cover or land use categories of interest. The principal tool for correlating the "cluster" map with the classification scheme (table 8) was a clear plastic overlay of the project area containing boundaries of the land cover and land use features derived from the image interpretation of Landsat imagery. The overlay was approximately the same scale as the cluster display map. Correlation of the cluster display with the image-interpretation overlay was aided by use of the following supportive information:

- (1) USGS topographic maps
- (2) Aircraft photography
- (3) Climatological and meteorological data
- (4) HGROUPl charts (figs. 7 and 8)
- (5) Means plots (fig. 14)
- (6) Ground truth information

Examples of the types of imagery used for correlation are shown in fig. 15 with a portion of the associated Landsat scene. Other types of supportive data are included in fig. 3 and appendices B and C.

When the correlation process is completed, an evaluation of the results is accomplished to determine if further action is needed. If it appears that the displayed classification results fulfill specific project requirements and that the classification accuracy is acceptable, no further processing of the Landsat data is required. However, if project requirements are not satisfied and/or objectionable classification results exist, refinement procedures are initiated. Once a satisfactory classification map has been prepared, the "noise" or "salt and pepper" effect inherent to most classification displays can be removed. The program utilized for this purpose is MR-CLEAN. Input consists of a file derived from SCALE-REGISTER, and the degree of "noise" removed is left to the discretion of the user (figs. 16 and 17).

#### Refinement Procedures

In the case where two or more clusters represent the same class of interest, the display can be improved by simply assigning one display symbol to represent all clusters within that class and running the SCALE-REGISTER Program again. Classification errors, consisting of misclassified and unclassified data for a particular feature, may be

Portion of Landsat Imagery



Reduced NASA High-Level Photography 1:120,000



Figure 15a. Examples of imagery used for correlation.

Low-Level Aircraft Photography 1:5,000

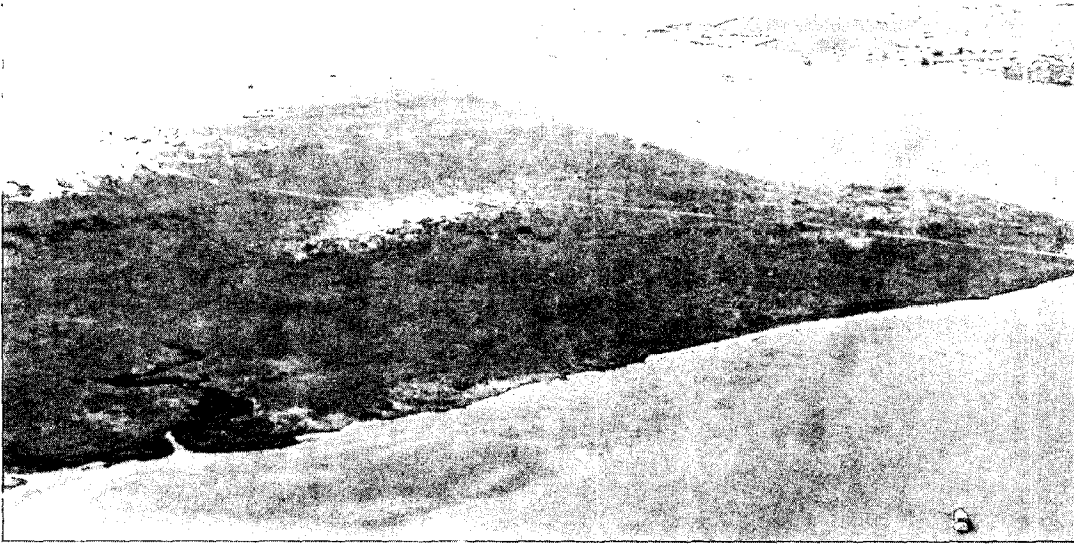

Reduced 1:24,000 Aircraft Photography



Figure 15b. Examples of imagery used for correlation.

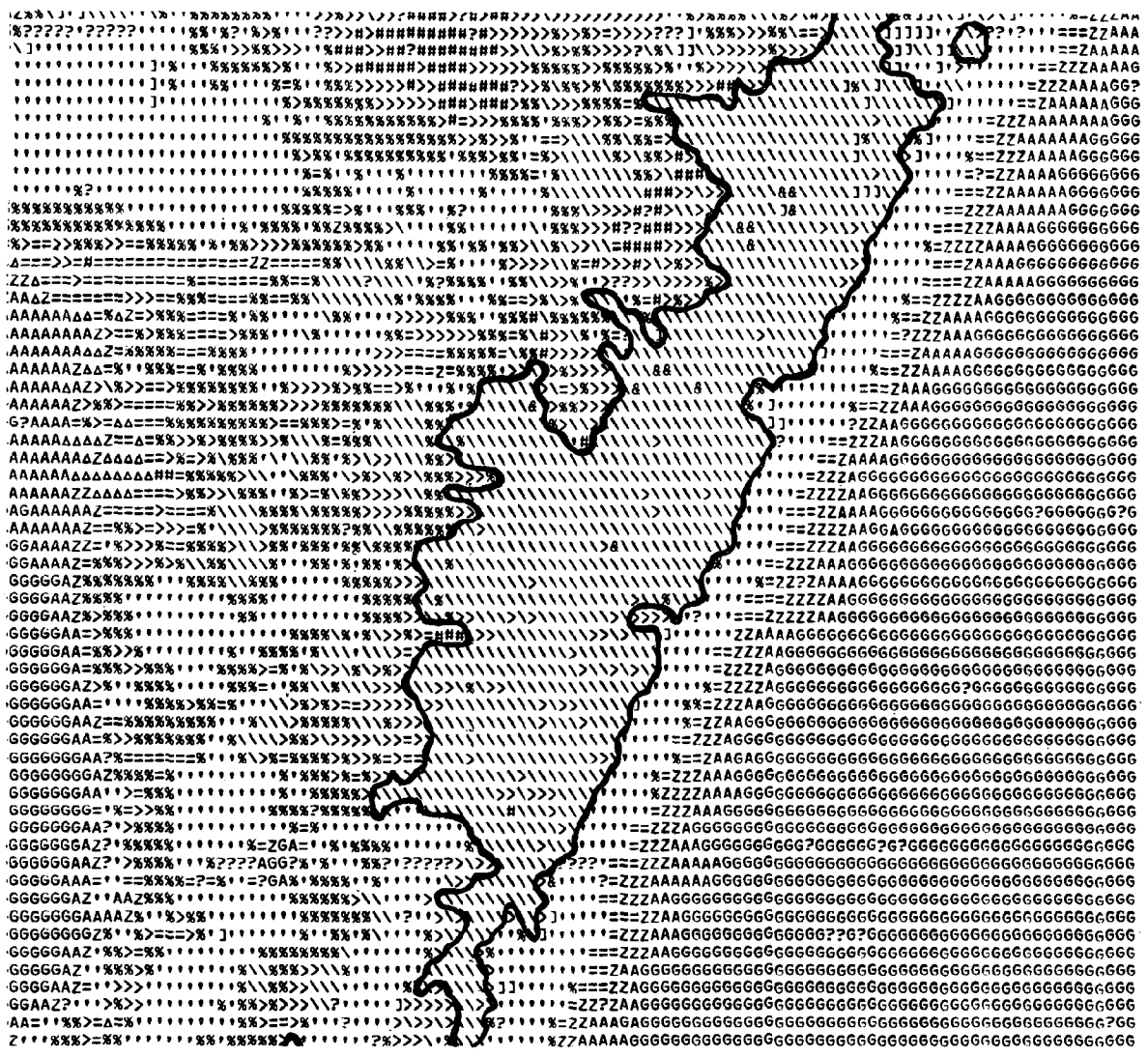

Figure 16. Classification display before using MR-CLEAN. The area outlined is primarily classified as Grassland/Rangeland with scattered pixels representing various other classes (table 8). The boundary of this area is depicted to aid in illustrating the effect of the MR-CLEAN program.



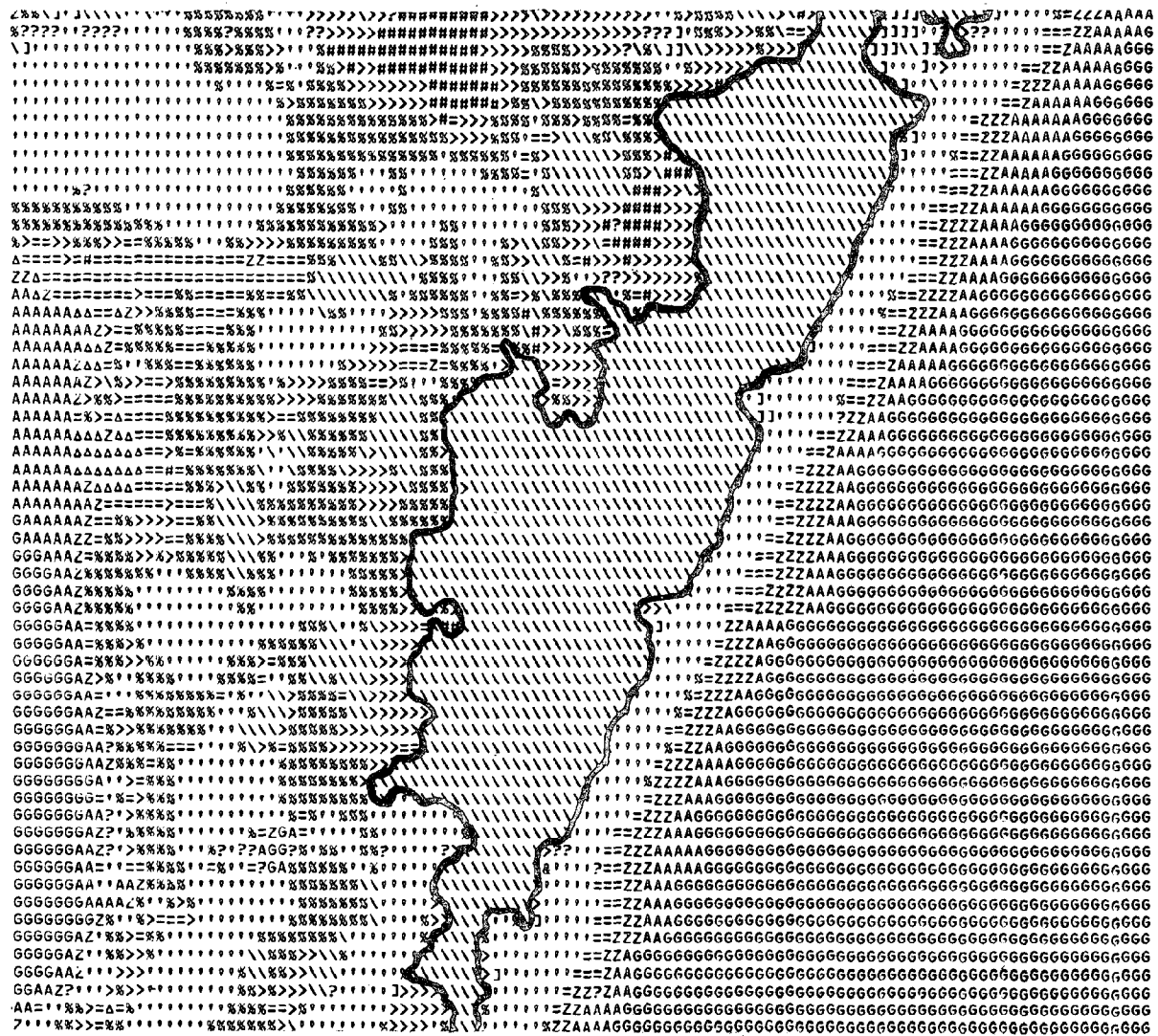

Figure 17. Classification display after processing with MR-CLEAN. An area classified as Grassland/Rangeland has been outlined here and on fig. 16 as an aid in comparison or the two maps to illustrate the effect of the MR-CLEAN program.

corrected or improved by the addition of representative statistics. Small sampling areas containing the data of questionable classification are identified on the SCALE-REGISTER display, transferred to a GRAYMAP or an unregistered LARSYS classified printout to obtain the original scanner coordinates, and run through the ISOCLS process to generate new statistics. These new statistics are evaluated and, if acceptable, added to the original group of statistics (ELLTAB TABLE) for reclassification and display. An iterative process of classification, evaluation, and refinement continues in this fashion until the results are acceptable or until it is determined that no further attempts to improve the classification should be made. The refinement process is illustrated in fig. 18. Again, the salt and pepper effect may be removed by the MR-CLEAN program to enhance the display.

The final product derived from a "site classification" type of analysis contains classes of interest in a land use/land cover map format at any standard scale desirable. Display maps can usually be made within three man-weeks and any reasonable number of copies can be provided from the line-printer. Depending on project requirements, the display maps can be created to depict various combinations of water and/or land classes of interest. The classification results also can be stored on magnetic tape or disk files for use in the change detection steps, generation of different formats, and other uses.

#### 5.2.2 Change Detection

Feature changes that have occurred in a particular area over a period of time can be detected and displayed by submitting the classification results from two Landsat MSS scenes to the DETECT program. The display



of detected changes is based on a pixel-by-pixel comparison of the entire site (appendix D). Figures 19, 20, 21, and 22 show a portion of test site 4 as depicted on two computer-assisted classification maps and the change detection results from comparison of these two maps.

### 5.2.3 Boundary Extraction

The EXTRACT program offers the capability of extracting boundary lines of classified areas for more precise analysis efforts. These boundaries can be readily utilized by the Geographic Information System (GIS). Figure 23 illustrates the results of extracting the boundaries from a classification map using the EXTRACT program.

### 5.3 Computer-Assisted Analysis of Test Site 4

Four Landsat scenes were selected for analysis in test site 4 as indicated in table 11, and analyses were initiated in the order of assigned scene number. The classification parameters used for all four scenes are noted in table 12. The sequence of steps and the software routines described in section 4.0 were used for analysis of all scenes.

Table 11

#### LANDSAT SCENES FOR TEST SITE 4

<u>Assigned Scene No.</u>	<u>Scene-ID</u>	<u>Date</u>	<u>Season</u>
1	2034-16202	25 Feb. 75	Winter
2	2376-16172	2 Feb. 76	Winter
3	5082-16080	10 July 75	Summer
4	1146-16320	16 Dec. 72	Winter

Portion of Scene 1



Portion of Scene 3



Figure 19. Portions of Landsat scenes corresponding to change detection displays (figs. 20-22).

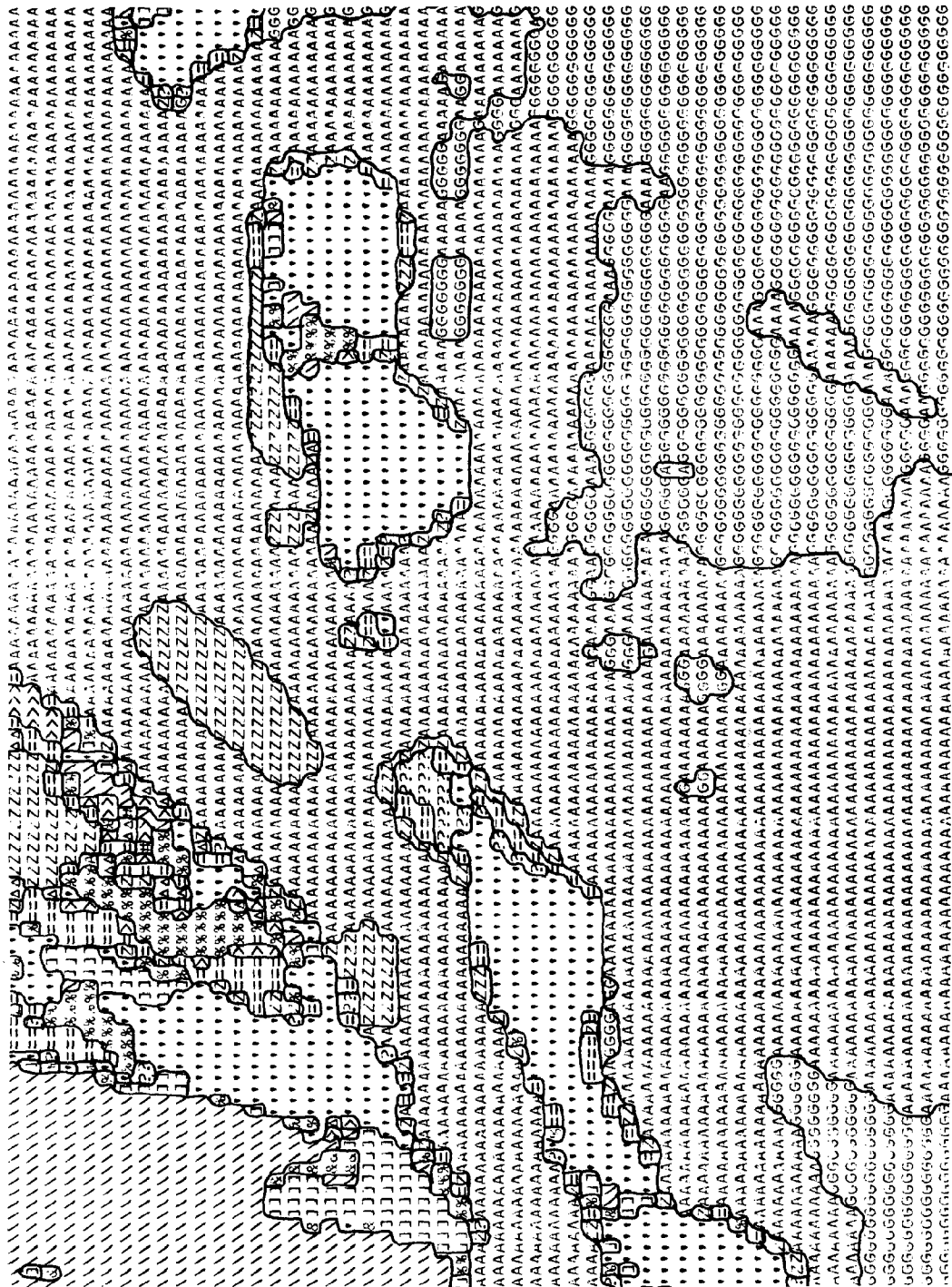

Figure 20. Part of the classification display of test site 4 near Port Ingleside on the Corpus Christi Ship Channel, 25 February 1975 (scene 1, 2034-16202).

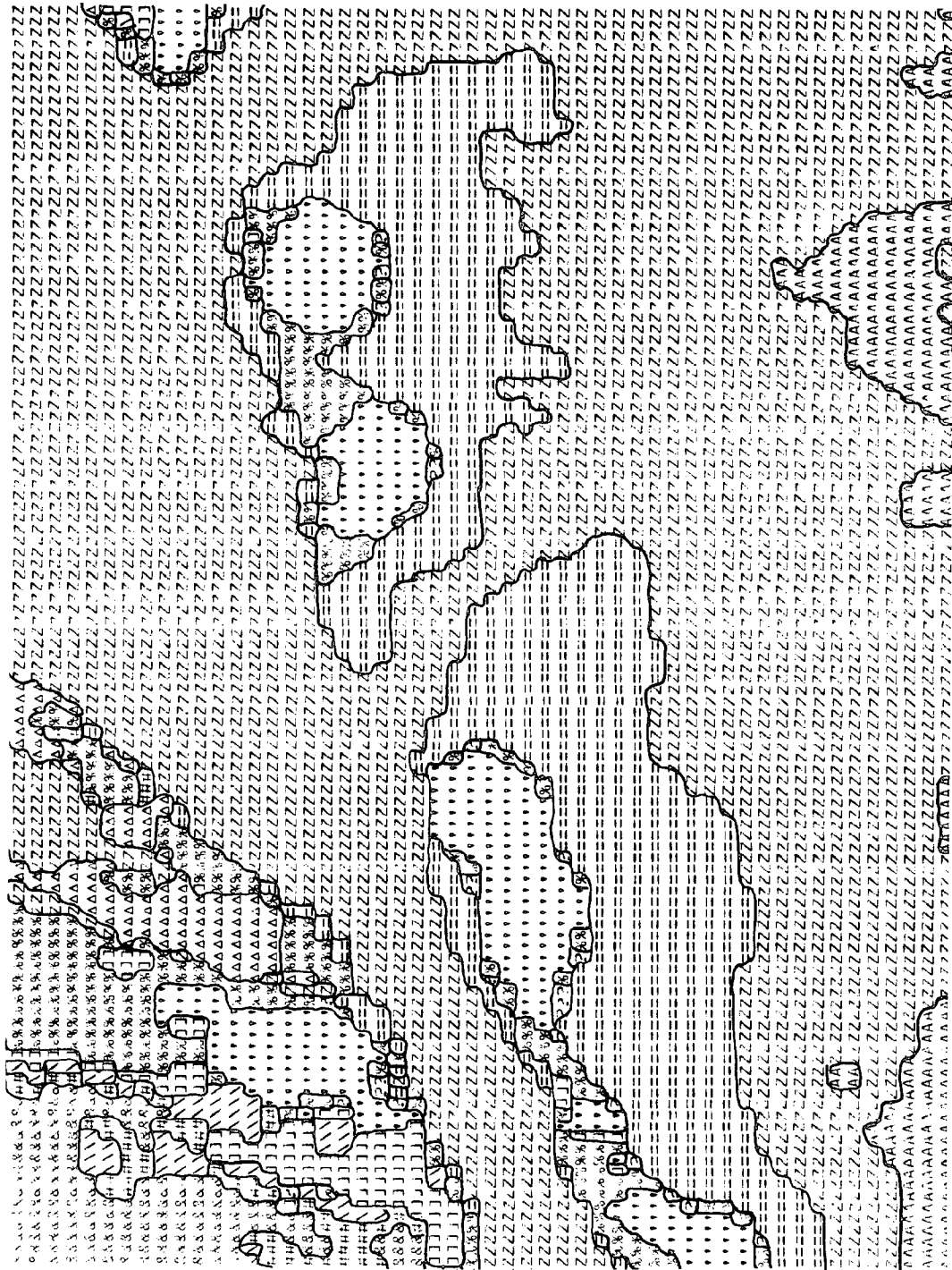

Figure 21. Same area as fig. 20, but 6 months later on 10 July 1975 (scene 3, 5082, 16080).

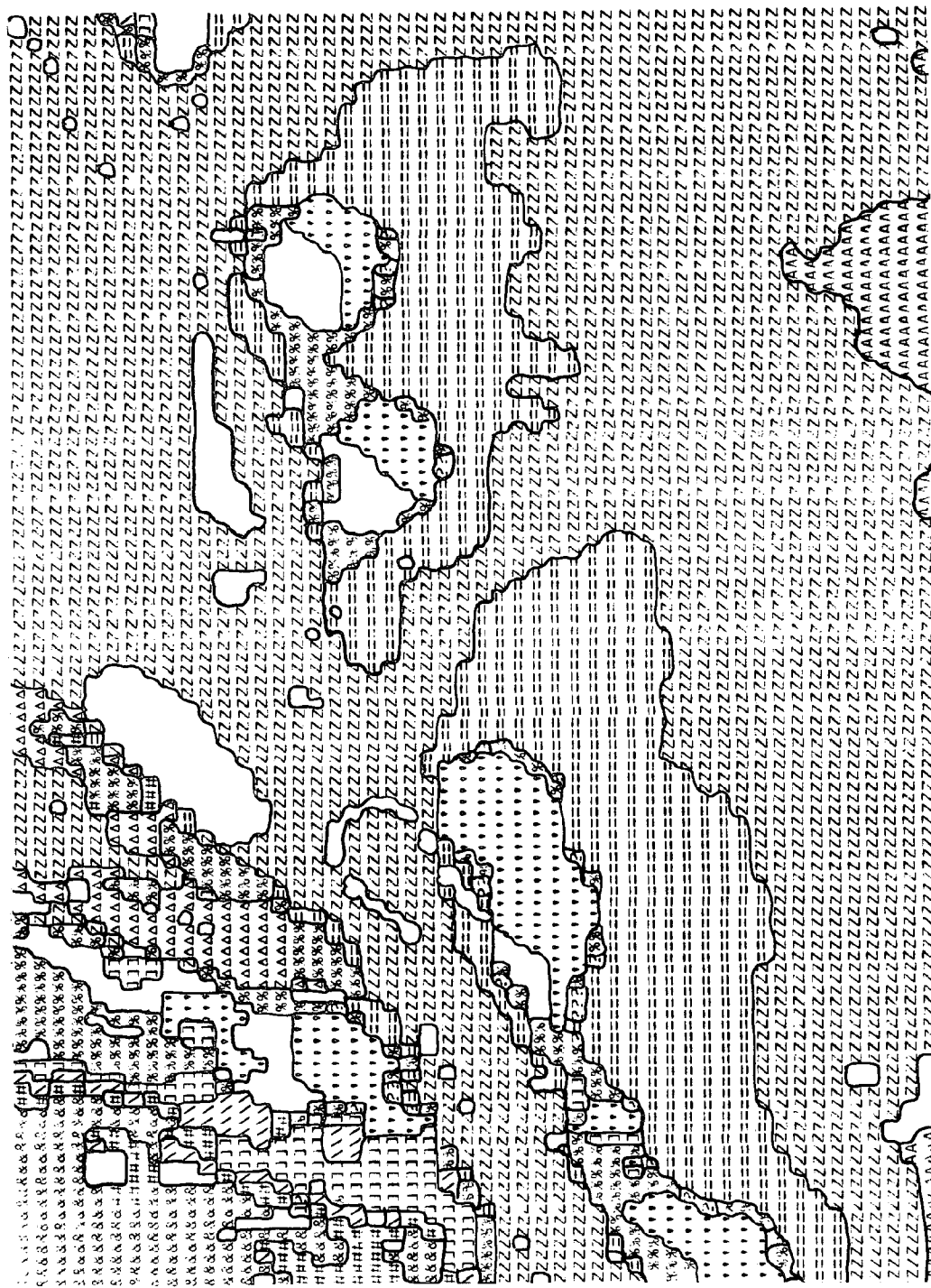

Figure 22. Change detection comparing scene 1 to scene 3. Blank areas indicate areas of no change, while symbols represent the classes that were present on scene 3 but were different on scene 1.



# Classified Display Area



# Extracted Portion of Display Area



Figure 23. Example of boundary map and corresponding display map portion.

Table 12

LARSYS/ISOCLS PARAMETERS

Number of Channels Used - All four channels  
 Number of Iteration - 10  
 Minimum Number of Points Per Class - 20  
 Minimum Separation Between Class Means - 2.0  
 Maximum Standard Deviation - 3.0  
 Maximum Classes - 50  
 Other Parameters - Default

A summary of the control network parameters is contained in table 13. Incomplete scene coverage was primarily due to the large amount of offshore coverage in each scene. The control point locations and corresponding scanner coordinates for all four scenes are included in appendix G. Through the use of aerial photography and site-related gray-scale maps, ISOCLS training areas were selected within test site 4 as shown in fig. 24. Pixels from every other column and every other

Table 13

SUMMARY OF CONTROL NETWORK PARAMETERS

	Scene No.			
	<u>1</u>	<u>2</u>	<u>3</u>	<u>4</u>
Total Control Points	7	7	9	8
RMS (meters)	60	111	95	82
% of Scene Covered	37	32	43	39



Figure 24. Test site 4 ISOCLS training areas.

line within these areas were sampled. A summary of the aircraft photography used to support the computer-assisted analysis can be found in table 6.

#### 5.4 Classification Results

A summary of the land cover and land use classes which were derived from each Landsat scene is presented in table 14. The existing scene conditions are summarized in table 15. Results of the computer-assisted classification of test site 4 from each of the four Landsat scenes are shown in figs. 25, 26, 27, and 28. These displays show the full test site area (four 7 1/2-minute USGS maps) at 1:125,000 scale. In addition, plate 1 (in pocket) shows the area in one USGS topographic map from scene 2 (2376-16172) at 1:24,000 scale. This is the scale at which the analysis, correlation, evaluation, and other tasks were performed.

*Cyran*

These products were generated so late in the investigation that there was insufficient time to prepare a detailed evaluation of each classification map. However, a discussion of the classification accuracy is contained in section 7.0 and a discussion of product utility is contained in section 8.0. This information and the various product illustrations throughout this report should give sufficient indication of the potential value of this approach to preparation of land cover and land use maps and related products.

#### 5.5 Change Detection Results

The capability to automatically compare the classification results from analysis of two Landsat scenes and to print out the differences may be one of the most important accomplishments of this investigation. The technique was developed late in the project, and consequently there







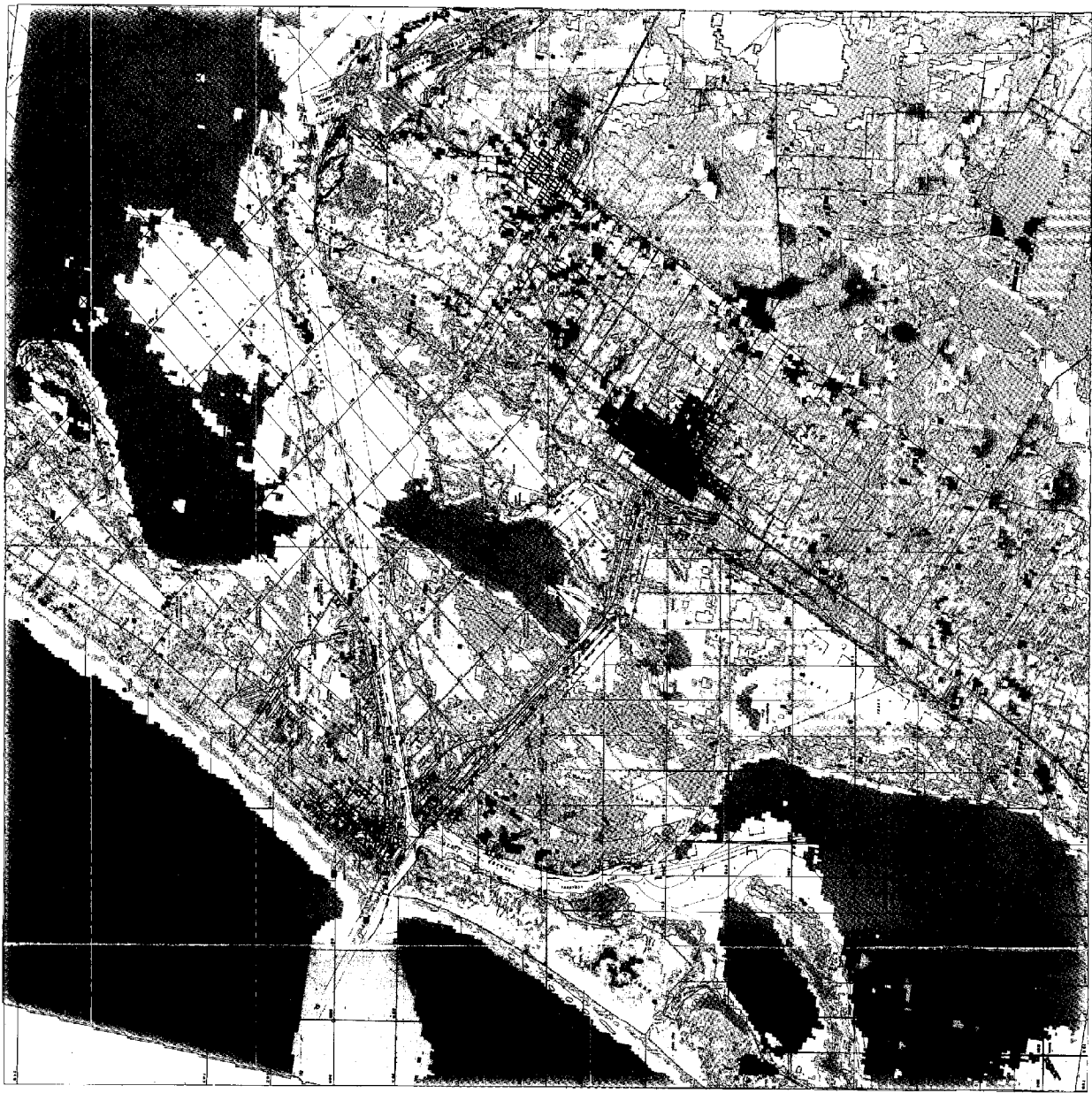





Figure 25. Seischrome™ display of test site 4,  
(Harbor Island area) scene 1,  
25 February 1975.

LANDSAT CLASSIFICATION MAP: ARANZAS PASS, ESTES,  
 PORT ARANSAS, AND PORT INGLESDIE QUADRANGLES

SCENE ID: 2034-16202  
 DATE 25 FEBRUARY 1975



EXPLANATION

-  URBAN OR BUILT-UP LAND
-  HIGHLY TURBID WATER
-  TOPOGRAPHICALLY HIGH MARSH
-  TOPOGRAPHICALLY LOW MARSH
-  TIDAL FLATS
-  SEACRASSES AND ALGAE FLATS
-  UNCLASSIFIED DATA
-  MODERATELY TURBID WATER
-  SLIGHTLY TURBID WATER
-  NON-TURBID WATER
-  FOREST LAND
-  GRASSLAND/RANGELAND
-  BARREN LAND

SCALE 1:125,000

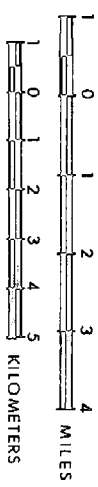

OVERLAY OF U.S. GEOLOGICAL SURVEY  
 STATE PLANNED SURVEY DATA PROVIDED  
 BY THE GENERAL LAND OFFICE

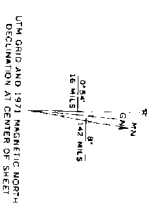

COMPUTER CLASSIFICATION PROVIDED BY THE  
 GENERAL LAND OFFICE SYSTEMS DIVISION  
 FOR SUPPORT OF CONTRACT NO. KAS-20988 BETWEEN THE  
 GENERAL SURVEY CENTER AND THE GENERAL LAND  
 OFFICE. SOURCE: LAND AND WATER USE AND  
 DEVELOPMENT IN THE ARANZAS PASS, ESTES,  
 PORT ARANSAS, AND PORT INGLESDIE QUADRANGLES,  
 THE TEXAS PARKS AND WILDLIFE DEPARTMENT

PREPARED BY  
**SEISCOM DELTA, INC.**  
 DIGITAL IMAGES DIVISION  
 HOUSTON, TEXAS

Figure 26. Seischrome™ display of test site 4,  
(Harbor Island area) scene 2,  
2 February 1976.

LANDSAT CLASSIFICATION MAP: ARANSAS PASS, ESTES,  
 PORT ARANSAS, AND PORT INGLISIDE QUADRANGLES

SCENE ID: 2376-16172  
 DATE: 2 FEBRUARY 1976

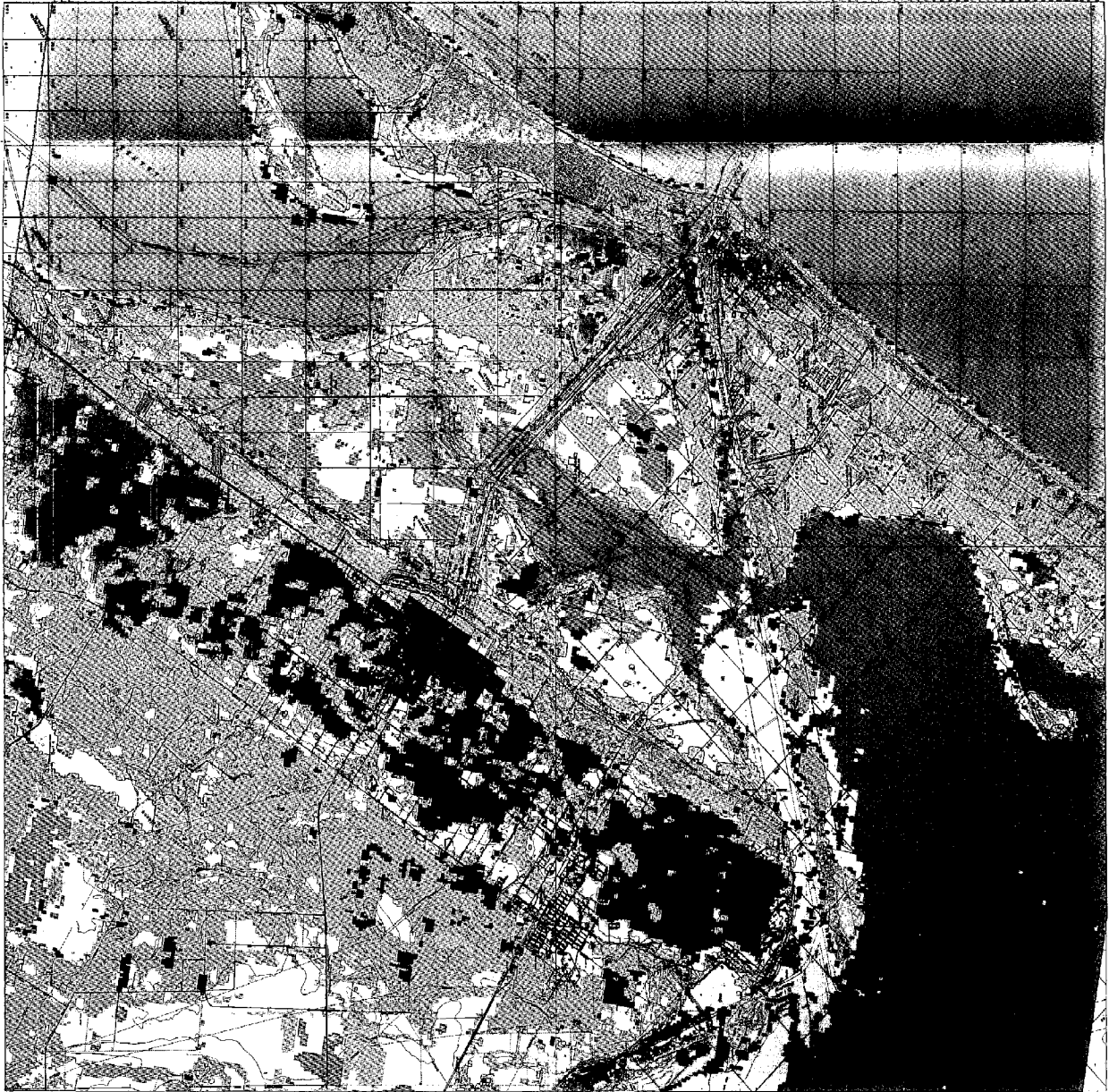

EXPLANATION	URBAN OR BUILT-UP LAND	HIGHLY TURBID WATER

SCALE 1:125,000

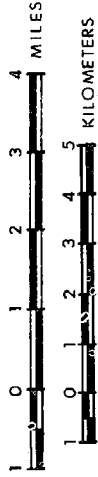

OVERLAY OF U.S. GEOLOGICAL SURVEY  
 STATE-OWNED SUBMERGED TRACTS PROVIDED  
 BY THE GENERAL LAND OFFICE



UTM GRID BASED ON NAD 83  
 DECLINATION AT CENTER OF SCENE

THIS CLASSIFICATION PROVIDED BY THE TEXAS  
 A&M UNIVERSITY CENTER FOR SPACE RESEARCH  
 FOR THE GENERAL LAND OFFICE OF THE STATE OF TEXAS  
 UNDER CONTRACT NO. MAS-20986. BETWEEN THE  
 STATE OF TEXAS, CENTER AND THE GENERAL LAND  
 OFFICE PARTICIPATING AGENCIES INCLUDE THE UNIVERSITY  
 OF TEXAS AT A&M, TEXAS A&M UNIVERSITY, AND  
 THE TEXAS PARKS AND WILDLIFE DEPARTMENT.

PREPARED BY  
 SEISCOM DELTA, INC.  
 DIGITAL IMAGES DIVISION  
 HOUSTON, TEXAS









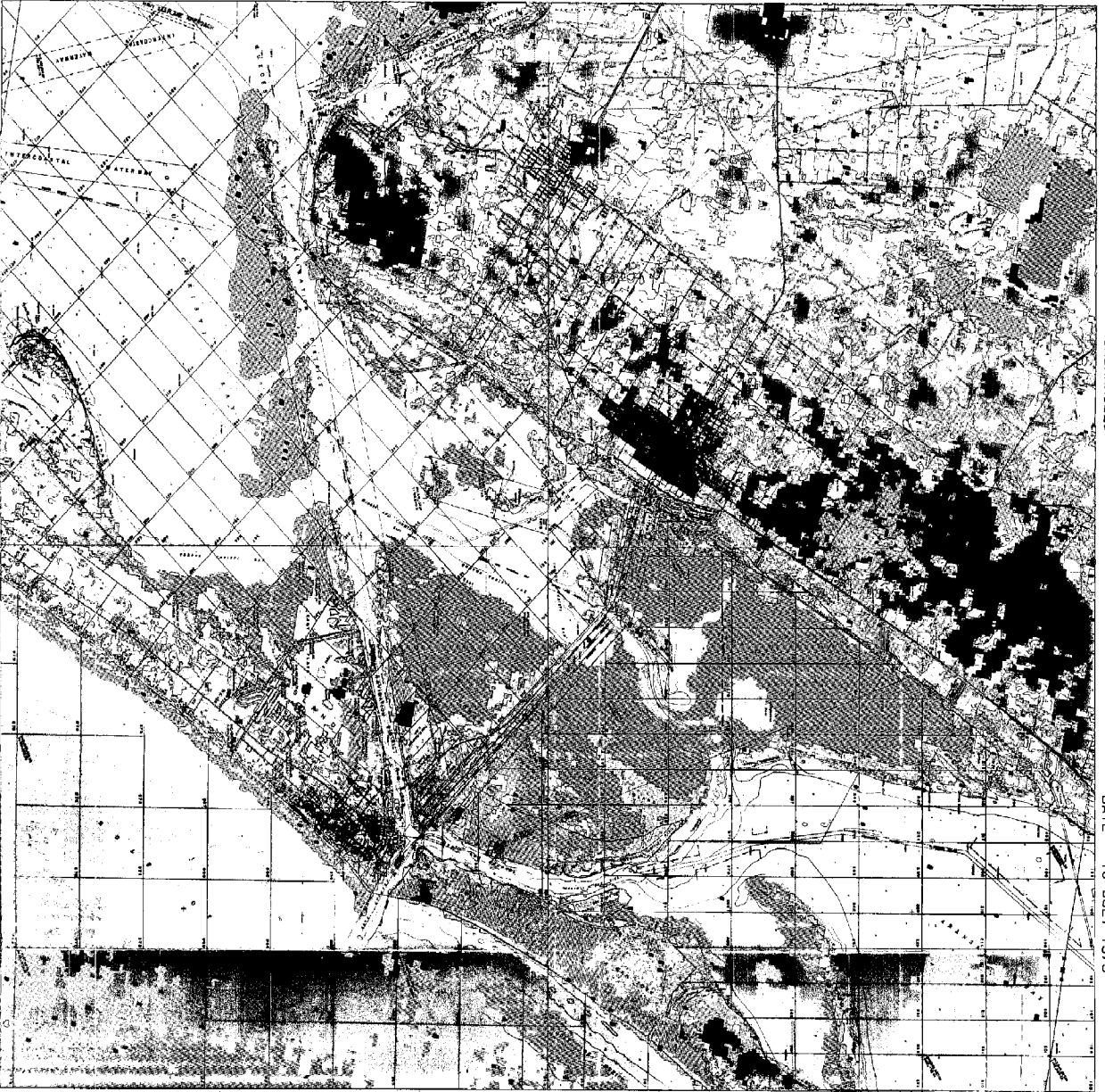









LANDSAT CLASSIFICATION MAP: ARANAS PASS, ESTES,  
 PORT ARANAS, AND PORT INCLISIDE QUADRANGLES

SCENE ID: 5082-16080  
 DATE 10 JULY 1975



EXPLANATION

	URBAN OR BUILT-UP LAND		HIGHLY TURBID WATER
	AGRICULTURAL LAND		TOPOGRAPHICALLY HIGH MARSH
	GRASSLAND/RANGELAND		TOPOGRAPHICALLY LOW MARSH
	FOREST LAND		TIDAL FLATS
	NON-TURBID WATER		SEAGRASSES AND ALGAE FLATS
	SLIGHTLY TURBID WATER		BARREN LAND
	MODERATELY TURBID WATER		UNCLASSIFIED DATA

SCALE 1:125,000

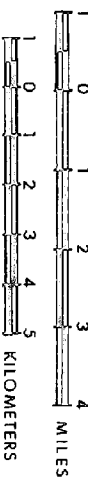

OVERLAY OF U.S. GEOLOGICAL SURVEY  
 TOPOGRAPHIC MAP INFORMATION WITH  
 LANDSAT CLASSIFICATION PROVIDED  
 BY THE GENERAL LAND OFFICE



UTM GRID AND 1971 MAGNETIC NORTH  
 DECLINATION AT CENTER OF SHEET

COMPUTER CLASSIFICATION PROVIDED BY THE  
 TEXAS NATURAL RESOURCES INFORMATION SYSTEM  
 FOR THE NATIONAL AERONAUTICS AND SPACE ADMINISTRATION  
 NATIONAL SPACE FLIGHT CENTER AND THE GENERAL LAND  
 OFFICE. PARTICIPATING AGENCIES INCLUDE THE UNIVERSITY  
 OF TEXAS AT AUSTIN, BUREAU OF ECONOMIC GEOLOGY, AND  
 THE TEXAS PARKS AND WILDLIFE DEPARTMENT







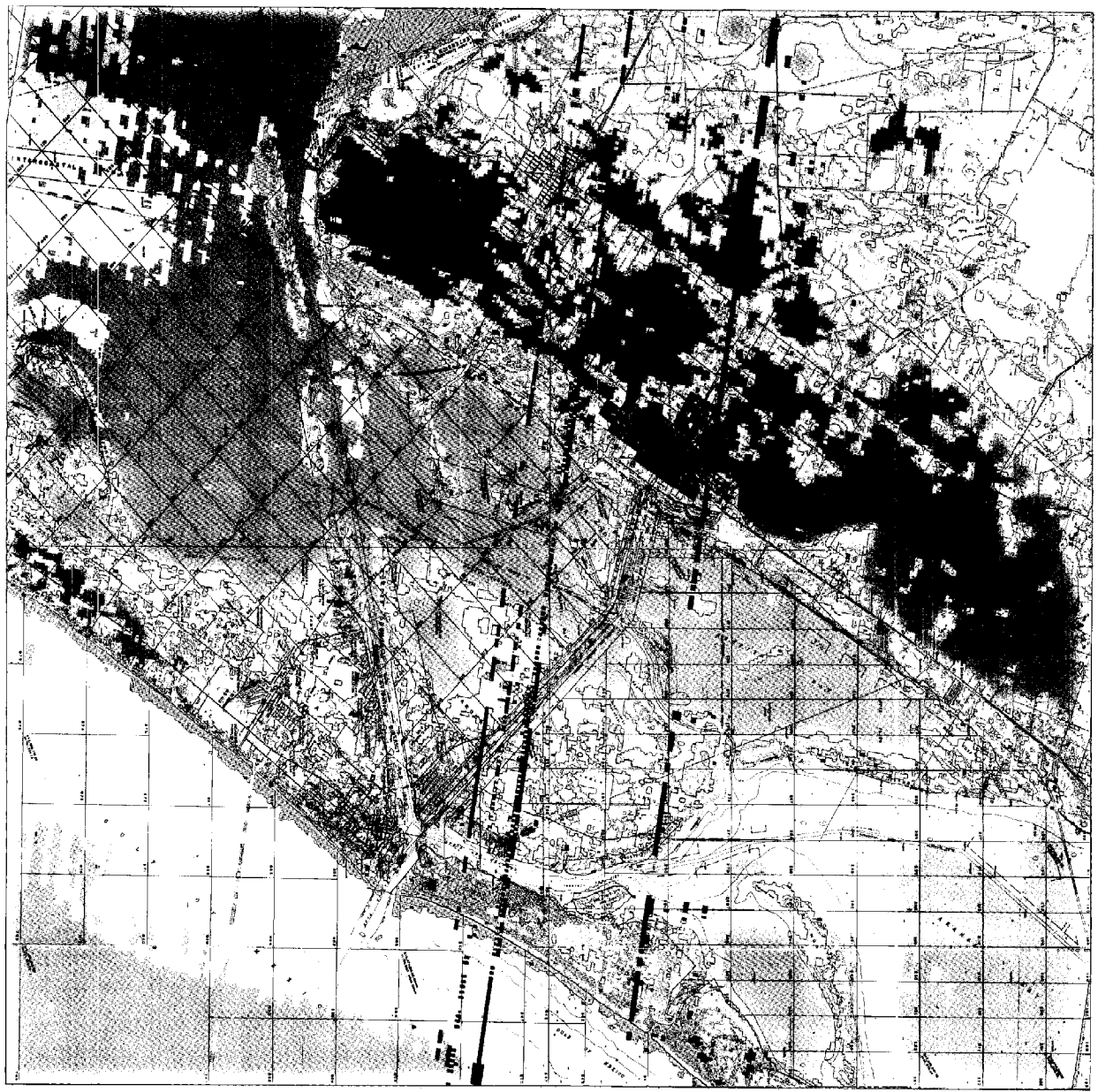







PREPARED BY  
 SEISCOM DELTA, INC.  
 DIGITAL IMAGES DIVISION  
 HOUSTON, TEXAS

Figure 27. Seischrome<sup>TM</sup> display of test site 4,  
(Harbor Island area) scene 3,  
10 July 1975.

Figure 28. Seischrome™ display of test site 4,  
(Harbor Island area) scene 4,  
16 December 1972.



EXPLANATION

-  URBAN OR BUILT-UP LAND
-  AGRICULTURAL LAND
-  CRASSLAND/RANGELAND
-  FOREST LAND
-  NON-TURBID WATER
-  SLIGHTLY TURBID WATER
-  MODERATELY TURBID WATER
-  HIGHLY TURBID WATER
-  TOPOGRAPHICALLY HIGH MARSH
-  TOPOGRAPHICALLY LOW MARSH
-  TIDAL FLATS
-  SEAGRASSES AND ALGAE FLATS
-  BARREN LAND
-  UNCLASSIFIED DATA

SCALE 1:125,000

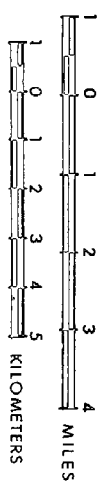

OVERLAY OF U.S.P. GEODROIDAL SURVEY  
 FOR PUBLIC SUBMISSION PROVIDED  
 BY THE GENERAL LAND OFFICE

UTM GRID AND 1971 MAGNETIC NORTH  
 DECLINATION AT CENTER OF SHEET

COMPUTER CLASSIFICATION PROVIDED BY THE  
 TEXAS STATE DEPARTMENT OF LAND  
 IN COOPERATION WITH THE NATIONAL  
 AERONAUTICS AND SPACE ADMINISTRATION  
 OTHER PARTICIPATING AGENCIES INCLUDE THE UNIVERSITY  
 OF TEXAS AT AUSTIN, THE TEXAS GEOLOGY, AND  
 THE TEXAS PARKS AND WILDLIFE DEPARTMENT

PREPARED BY  
 SEISCOM DELTA, INC.  
 DIGITAL IMAGES DIVISION  
 HOUSTON, TEXAS

Table 14

SUMMARY OF LAND COVER AND LAND USE CLASSES  
DERIVED FROM THE FOUR LANDSAT SCENES OF TEST  
SITE 4

<u>Land Cover and Land Use</u>	<u>Assigned Scene No.</u>			
	<u>1</u>	<u>2</u>	<u>3</u>	<u>4</u>
Urban/Built-up Land	X	X	X	X
Agricultural Land	X	X	X	
Range/Pasture	X	X	X	X
Woodland	X	X	X	X
Non-Turbid Water	X	X		X
Slightly Turbid Water	X	X	X	X
Moderately Turbid Water	X	X	X	X
Highly Turbid/Very Shallow Water	X		X	X
Topographically Low Marsh	X		X	X
Topographically High Marsh				X
Tidal Flat	X	X	X	X
Sea Grasses/Algal Flats	X	X	X	X
Barren Land	X	X	X	X
Number of Subclasses:	33	26	37	36

Table 15

SUMMARY OF SITE CONDITIONS AT TIME  
LANDSAT SCENE WAS IMAGED

<u>Scene No.</u>	<u>Date Imaged</u>	<u>Season</u>	<u>Tide Condition</u>	<u>Wind Speed/ Direction</u>
1	25 Feb. 75	Winter	low	South, 15-20
2	2 Feb. 76	Winter	low	N&S, 10-15
3	10 July 75	Summer	high	South, 10-15
4	16 Dec. 72	Winter	?	?

was insufficient time for detailed evaluation of the change detection products. To indicate the potential value of this capability, a brief review was made of the classification results shown in figs. 20 to 22.

The area shown in these figures is located due south of the town of Aransas Pass and includes Port Ingleside on the southern edge of Live Oak Peninsula, Corpus Christi Channel running northeast/southwest, and a string of small islands paralleling the channel. The two Landsat scenes which were classified and compared for detection of changes were acquired in February, 1975 (2034-16202, fig. 20) and July, 1975 (5082-16080, fig. 21), thus representing only five months' difference. The tide conditions were somewhat different for each scene (table 15), being higher in July; but any changes in land cover in this area were likely to be influenced primarily by seasonal differences (fig. 22).

When changes in the land cover or land use classes occurred between February and July, the July classification symbols were printed in fig. 22. When there was no change, the area was left blank. The most obvious characteristic of the map in fig. 22 is that most of the classes

of land and water changed. The Slightly Turbid and Non-Turbid water classes changed to Moderately Turbid, and along the southern edge of the chain of islands, water was Highly Turbid. The surface area of the islands was reduced due to the higher tide in July, and the perimeter was classified mainly as Tidal Flats. The large area of Grassland/Rangeland in the northwestern area was shown as Agricultural and Forestland and the Urban/Built-up area (Port Ingleside) had been extended slightly northward (due possibly to vegetation changes rather than to actual growth of the Built-up area). Numerous other changes could be obtained from analysis of these maps. The significance of the reflected differences and their value for monitoring actual changes in human and natural activities to support state agency requirements has yet to be determined. However, this approach does seem to offer a major potential for aiding in the monitoring process.

7  
J

## 6.0 IMAGE-INTERPRETATION ANALYSIS

### 6.1 Development of Image-Interpretation Techniques

An annotated bibliography (appendix H) was prepared covering applications of aerial photography and Landsat imagery in the coastal zone. Emphasis was placed on locating research related to wetlands mapping and image interpretation of Landsat film products. Most techniques termed "conventional," as opposed to "computer-aided," involve optical or electro-optical color enhancement processes. Since acquisition of the special equipment needed to implement these techniques was not part of this investigation, development efforts were aimed at perfecting a relatively simple mapping technique.

Initial development of mapping techniques in this investigation utilized imagery of the San Antonio-Espiritu Santo Bay area (test site 3), dated 29 March 1974 (1614-16261) and 25 February 1975 (2034-16200). The approaches which were considered included: (1) mapping directly from 1:250,000 Landsat paper prints; (2) using the Bausch and Lomb Zoom Transfer Scope to enlarge 7.3-inch Landsat transparencies to a scale of 1:125,000, without a Landsat map base for the test site area; and (3) production of a 1:125,000 enlargement of band 7 data for use as a base, followed by mapping from transparencies under the Zoom Transfer Scope.

#### 6.1.1 The Optical Interpretation Procedure

The 1:250,000-scale Landsat print was considered too small a scale to work with for site-specific studies. Since an excellent coastwide map base is available in the form of 1:125,000-scale Environmental Geology maps (Brown, coordinator, in progress), use of this larger scale was considered as the project mapping scale. When it was found that the 1:1,000,000 Landsat transparencies could be optically enlarged eight times without serious loss of image quality, the 1:125,000 mapping scale was adopted. A base of Landsat data across the test site was required, however, to avoid inaccuracies due to shift in field of view when using the Zoom Transfer Scope.

The map for each scene was initiated by making an enlarged positive transparency of the test site from the 1:1,000,000 band 7 negative. This enlargement was done by the Automation Division of the Texas Department of Highways and Public Transportation using either a Durst or a Laborator No. 184 enlarger. All land-water boundaries and other easily distinguishable features were transferred from the transparency to a



transparent stable film on a light table. The map was then completed by projecting enlarged false-color composite and single band transparencies onto the stable film, drawing line boundaries (fig. 29), and classifying each feature. The map units were hand-colored according to the land cover and land use classification scheme developed during this investigation (table 7).

#### 6.1.2 An Image Analysis Schedule

The optical interpretation procedure was integrated into a series of steps which was followed from initial review of each Landsat scene through final accuracy analysis of the resulting map (table 16). To use the classification scheme developed as part of this investigation, the interpreter must have some familiarity with the area to be mapped. This is a reasonable expectation where Landsat data are to be used in monitoring critical coastal environments. The availability of the detailed Environmental Geologic Atlas of the Texas Coastal Zone (Brown, project coordinator, in progress), in addition to standard topographic maps and aircraft photography, fulfilled the interpreters' need for supplemental data. In addition, a small aircraft was available for low-altitude observation and photography and was used during initial study of each test site. While supplemental data were at hand during mapping of the test sites, classification decisions made during the image-interpretation process were based solely on the Landsat data. Detailed study of supporting data relative to the classification of an area from Landsat data was not done until after the entire test site was mapped (step 5, table 16). Techniques and results of accuracy analysis (step 8, table 16) are described in the following discussion of the individual test sites.

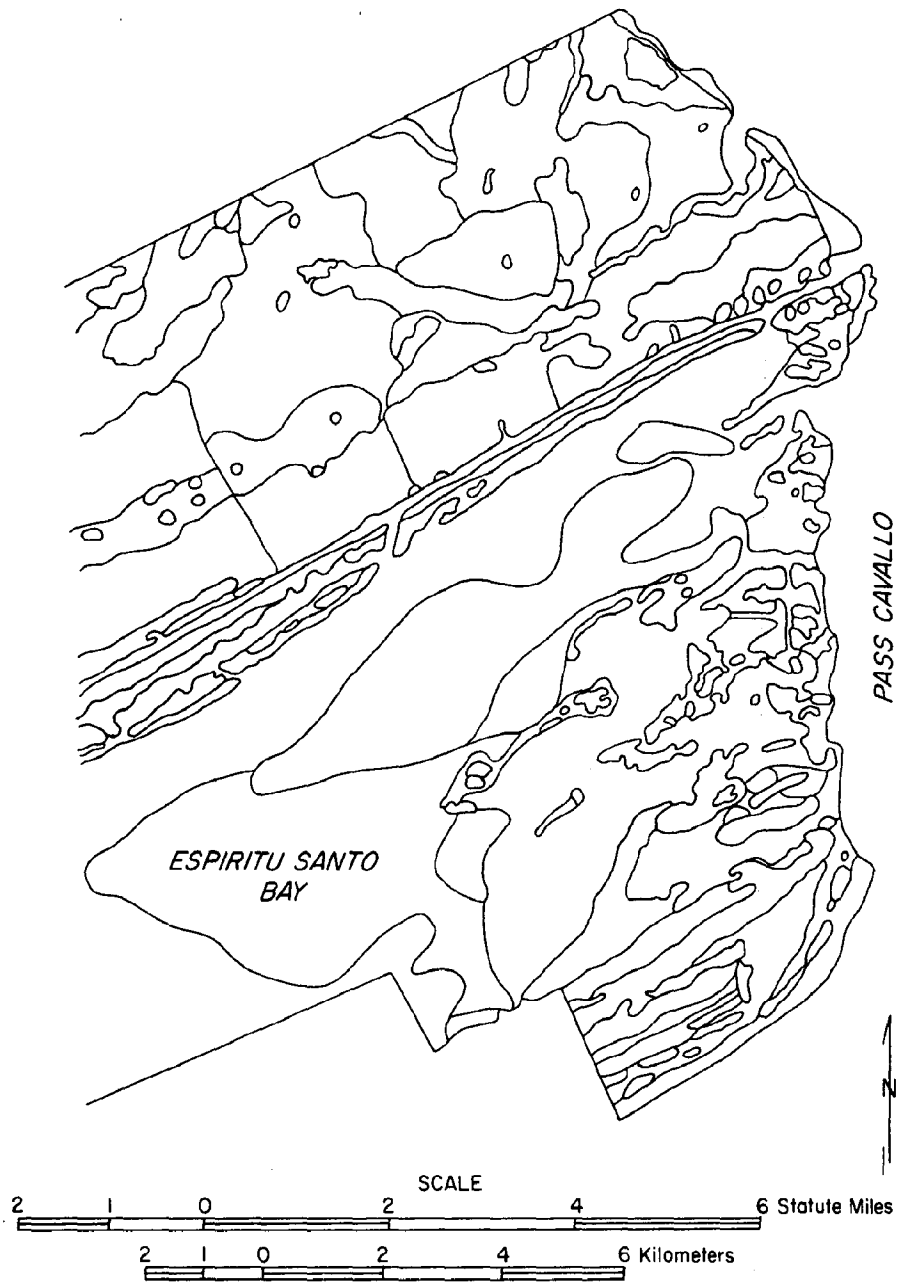

Figure: 29. Image-interpretation line boundary map of part of test site 3, Pass Cavallo area.

Table 16

EVALUATION REVIEW SCHEDULE FOR IMAGE-INTERPRETATION ANALYSIS

1. Review aerial photography, coastal atlas maps, and published tide and weather data for test site and image date.
2. Take a preliminary field trip to become generally acquainted with test site (may include oblique aerial photography).
3. Complete line boundary map of test site area from image interpretation of Landsat.
4. Classify features delineated according to the project classification scheme.
5. Study supportive data in detail, review results, field check and select areas for biological verification.
6. Document results for the Landsat scene, especially problems and unique aspects of the imagery.
7. Color-out image interpretation at 1:125,000 scale and produce overlays of selected quadrangles at 1:24,000 scale.
8. Perform accuracy analysis using randomly selected points.
9. Evaluate format and content of resulting Landsat map.
10. Evaluate image interpretation of this scene in conjunction with other scenes for the same test site.

### 6.1.3 Problems Associated with a Poor-Quality False-Color Composite

To complete the study of the Harbor Island test site, a winter scene was sought to compare with the February 1975 and February 1976 scenes. Due to cloud cover constraints and the requirement that satisfactory digital data also be available, the Landsat-1 imagery of 16 December 1972 (scene 1146-16320) was selected. Special processing was needed, however, to produce the false-color composite transparency because of poor data in band 7. Band 6 was therefore substituted for the 0.8-1.1 $\mu$  data.

The false-color composite image received from the EROS Data Center was not satisfactory for mapping via the image-interpretation procedure. A problem in registration during exposure of the three dye layers of the film resulted in a double image on the transparency in colors of blue and red. The misregistration was serious enough to obscure the boundaries of most units and to create some obviously false units. An example of the latter is the occurrence of an infrared response typical of vegetation within the tidal inlet waters of Aransas Pass.

Mapping of test site 4 was attempted using the black-and-white single band images, primarily bands 5 and 7. A line boundary map was produced over the entire test site, and the seaward half was classified as to land cover and land use. Results were poor compared to map results previously obtained using a good-quality false-color composite, supplemented by single-band images where needed. Classification of vegetated areas was difficult, less confidence was placed in the boundaries drawn, and the classified areas were highly generalized. From this experience it may be concluded that a high-quality false-color composite image is critical to the optical image-interpretation process.

## 6.2 Development of Image-Interpretation Techniques for Change Detection

The types of change detection attempted using Landsat imagery during this investigation included: (1) variations in areal extent of category, (2) change in the classification of an area, and (3) temporal signature differences within a classified area. Examples of these types of change are, respectively, the addition of spoil material along the margins of dredged channels, change in classification because of leafing-out of deciduous vegetation between a winter and summer scene, and temporal changes such as seasonal burning of coastal prairie grasslands. In the latter case, if the interpreter were aware of the burning practices, he would not alter his classification of a grassland area but would simply take notice of the sharp change in observed radiance.

Actual practice in delineating changes detectable with Landsat imagery indicated that: (1) changes in the areal extent of categories adjacent to water bodies could be detected by overlaying 1:125,000 line boundary maps, (2) category change detection could be based on side-by-side comparison of classified maps, and (3) temporal changes resulting in radiance differences could be detected by overlaying positive and negative transparencies on a light table. This method for detection of radiance differences was utilized with 1:125,000-scale enlargements of band 7 images over test sites 3 and 4. Figure 30 shows that the sense of radiance change indicated for a light area depends on the selection of a positive or negative for the older or the newer scene, respectively. Changes which have been detected and mapped relate to burning of grasslands, status of agricultural fields, growth stage of wetland vegetation, and the degree of exposure of tidal flats. The specifics of these results are included in the discussion of test sites 3 and 4.

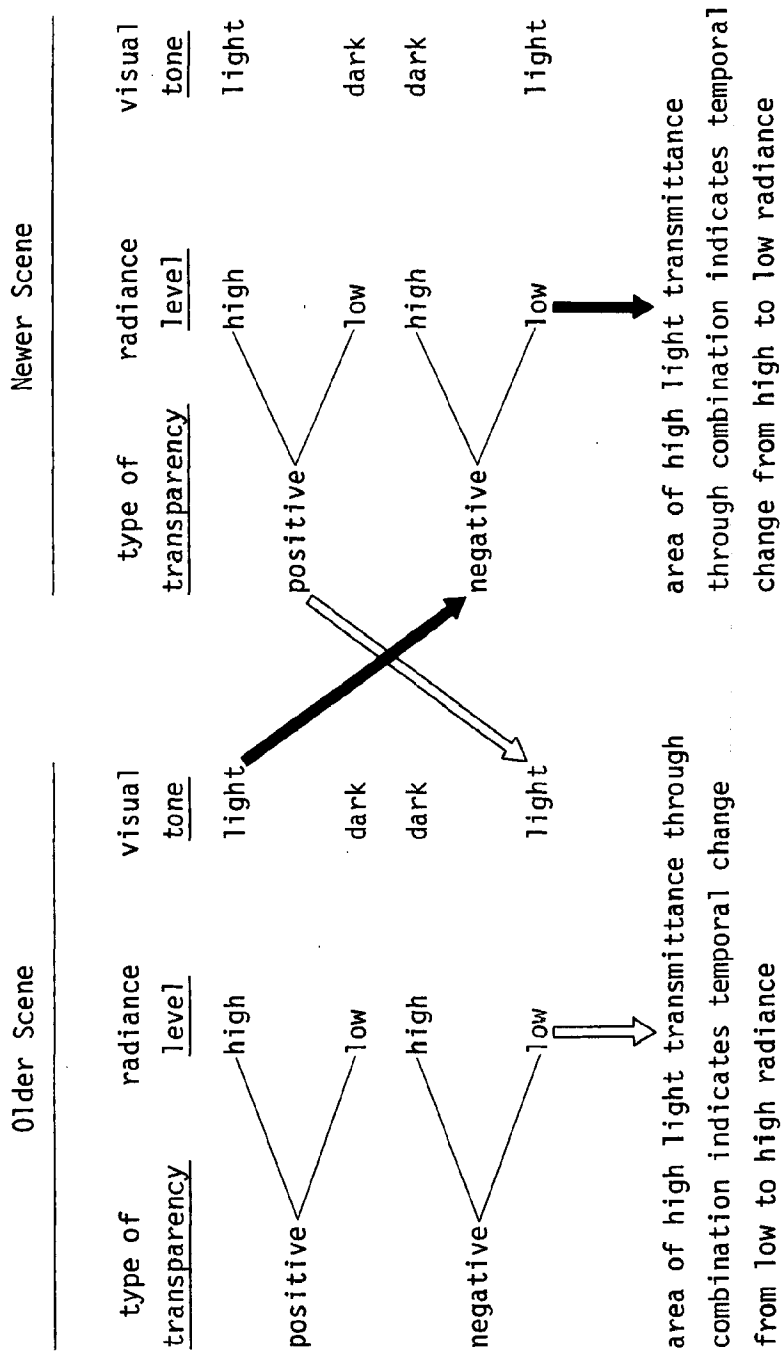

Figure 30. Schematic diagram of change detection procedure based on observed radiance differences.

### 6.3 Discussion of Image-Interpretation Results for Test Sites 2, 3, 5, and 4 with Ground Truth

#### 6.3.1 Analysis of Test Site 2

Site description.--The Freeport-San Luis Pass test site is situated within a strandplain type of shoreline developed on a Holocene deltaic headland (McGowen and Scott, 1975). The coastal plain slopes gently gulfward at a rate of 2 to 3 feet per mile, and the relatively flat coastal prairies give way to marshes and bay systems toward the coastline (McGowen and others, 1976). Dunes on Follets and western Galveston Islands are low and well vegetated. The regional excess of moisture beyond that evaporated or transpired by plants contributes to successful stabilization of the loose sand.

Topographically low saline marshes are present along the bay margins in the vicinity of San Luis Pass and contain abundant Spartina alterniflora (smooth cordgrass) and Batis maritima (maritime saltwort). Along the Gulf Intracoastal Waterway south of Freeport, saline to brackish marshes include the above species, and at slightly greater elevation, Distichlis spicata (seashore saltgrass), Salicornia spp. (glasswort), and Monanthochloe littoralis (shoregrass). Topographically higher marshes in this region, subject to only occasional flooding by saltwater (Arp, 1975), include abundant Spartina spartinae (gulf cordgrass) and Spartina patens (marsh hay cordgrass). The high marsh ecosystem grades laterally into coastal salt grass prairie which is dominated by Spartina spartinae, but includes shrubs such as Iva frutescens (marsh elder) and Baccharis halimifolia (groundsel tree), as well as other grasses (appendix B).

Urban development within this test site is centered around Freeport and the Brazosport shipping facilities. Major chemical and petroleum-

production related industries are concentrated here, along with numerous smaller industries serving the petrochemical complexes. Many dredged channels are associated with commercial activities in the area, and a series of hurricane-surge protection dikes has been built. These structures have altered the natural distribution of flora in some areas. Very little cropland is found within the test site; the coastal prairie grasslands are extensively grazed.

Mapping results.--Image interpretation of Landsat film transparencies readily reveals the complex active and abandoned natural drainage patterns, as well as dredged channels and the details of natural and jettied inlets within this coastal segment (fig. 31 and plate 2). San Luis Pass (fig. 32), an unmodified tidal inlet, is spanned by a highway bridge which is detectable with Landsat data. Extensive topographically low marshes just inside the pass were correctly identified and contain an abundance of Spartina alterniflora. Islands of lesser water content and higher reflectance vegetation surrounded by the low marsh were classified as high marsh, a decision which appears valid after examination of 1:30,000 color-infrared aerial photography.

However, some initial errors in classification also occurred, and three examples are illustrated by fig. 32. A barely emergent marshy island (A, fig. 32) was mapped as highly turbid/shallow water. Where beach width decreases below about 80 m (B, fig. 32)--the size of one pixel, or the minimum resolution element of the satellite's detectors--the subaerial beach, breaking waves, and the nearshore zone of turbid water appear as a zone of highly turbid or shallow water adjacent to the vegetated barrier flat. A strip of high-reflectance sand (C, fig. 32) is mapped as undifferentiated barren rather than dredge spoil because the



TEST SITE 2

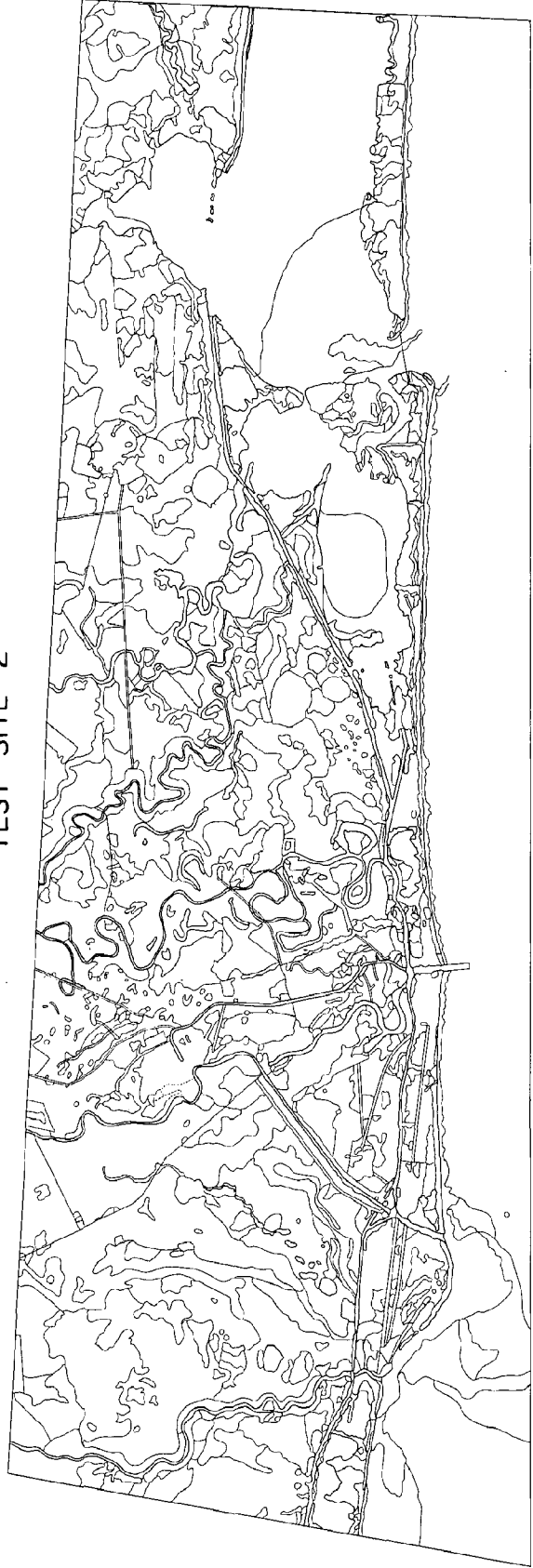

8 MAY 1973  
SCENE 1289 - 16261

Figure 31. Unclassified line boundary map of the Freeport-San Luis Pass test site.

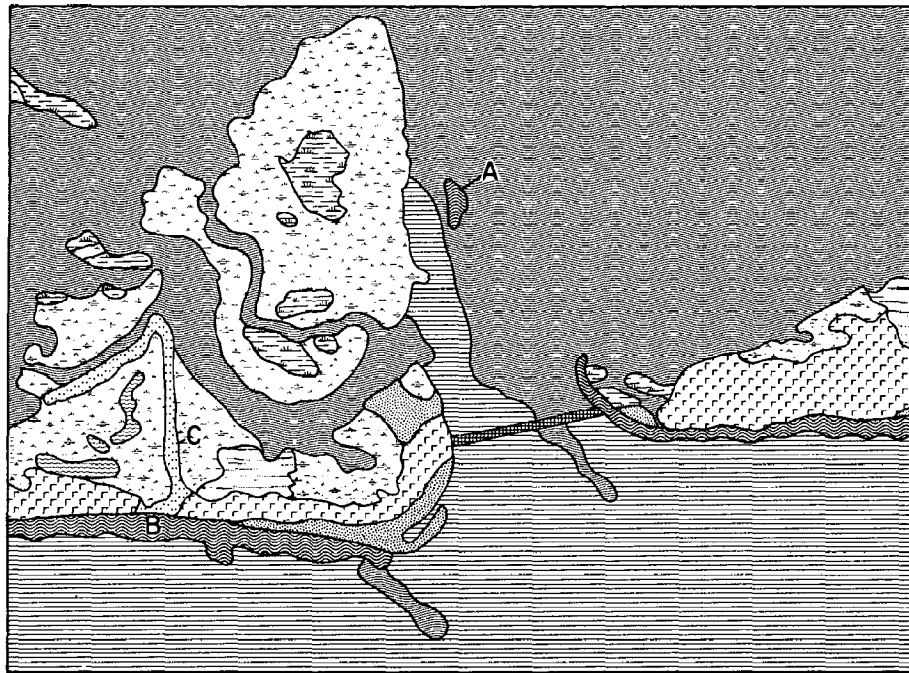

EXPLANATION  
Land Use and Land  
Cover Classes

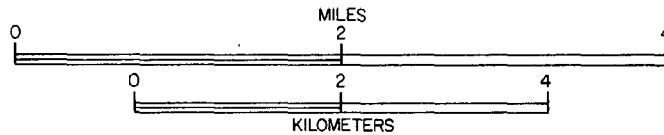
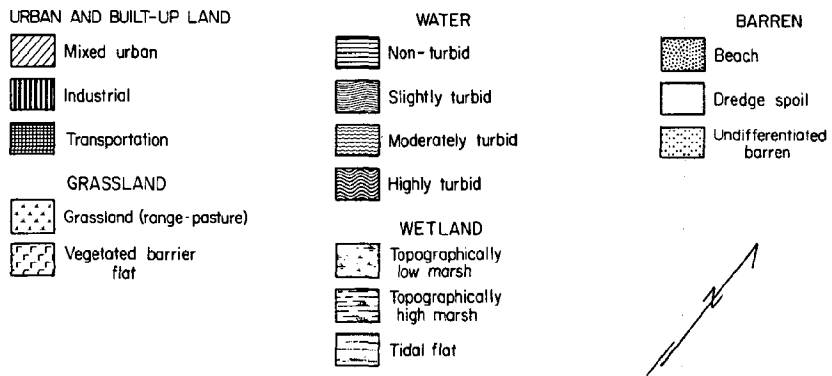

Figure 32. San Luis Pass area, test site 2, with classified land and water units delineated from Landsat scene 1289-16261, 8 May 1973. Lettered locations are explained in text.

adjacent channel, about 50 m in width, cannot be distinguished from the surrounding wet low marsh.

Woodlands within the test site include Quercus virginiana (live oak), Carya spp. (hickory and pecan), and scattered Celtis spp. (hackberry) and were most easily detected where dense stands parallel creeks and rivers. The live oak seems to give an especially bright infrared response on the Landsat false-color composite. Brushland, where cover was estimated from aerial photography to be less than 15 percent, was not distinguishable from grassland. Where woodland graded laterally into brushland, difficulty was encountered in placing a correct boundary between these units.

The Freeport area (fig. 33) includes a major industrial-port complex nearly 3 km in length and width, the urban areas of Freeport (A, fig. 33) and Surfside (B, fig. 33), and urban strip development (C, fig. 33) along State Route 332. This road leads northwest from Surfside but is not detectable where it crosses the low marshes landward of that city until the roadside development begins. At locality D (fig. 33), development becomes less continuous, but a string of individual industrial sites is a clue to the highway's location. On Landsat false-color composite transparencies, industrial sites are recognizable by : (1) the high-reflectance white to bluish-white tones caused by metal structures and the use of shell and sand fill, (2) the presence of holding ponds for liquids, and (3) distinguishable roads or dredged channels which lead to the site. Use of the first criterion alone can be misleading; at E (fig. 33) a rectangular area covered by barren dredge spoil approximately 160 by 400 m in size was misinterpreted as an industrial location.

A detectable change in marsh type was mapped across a road (F, fig. 33) which, when checked in the field, was found to follow the crest of a

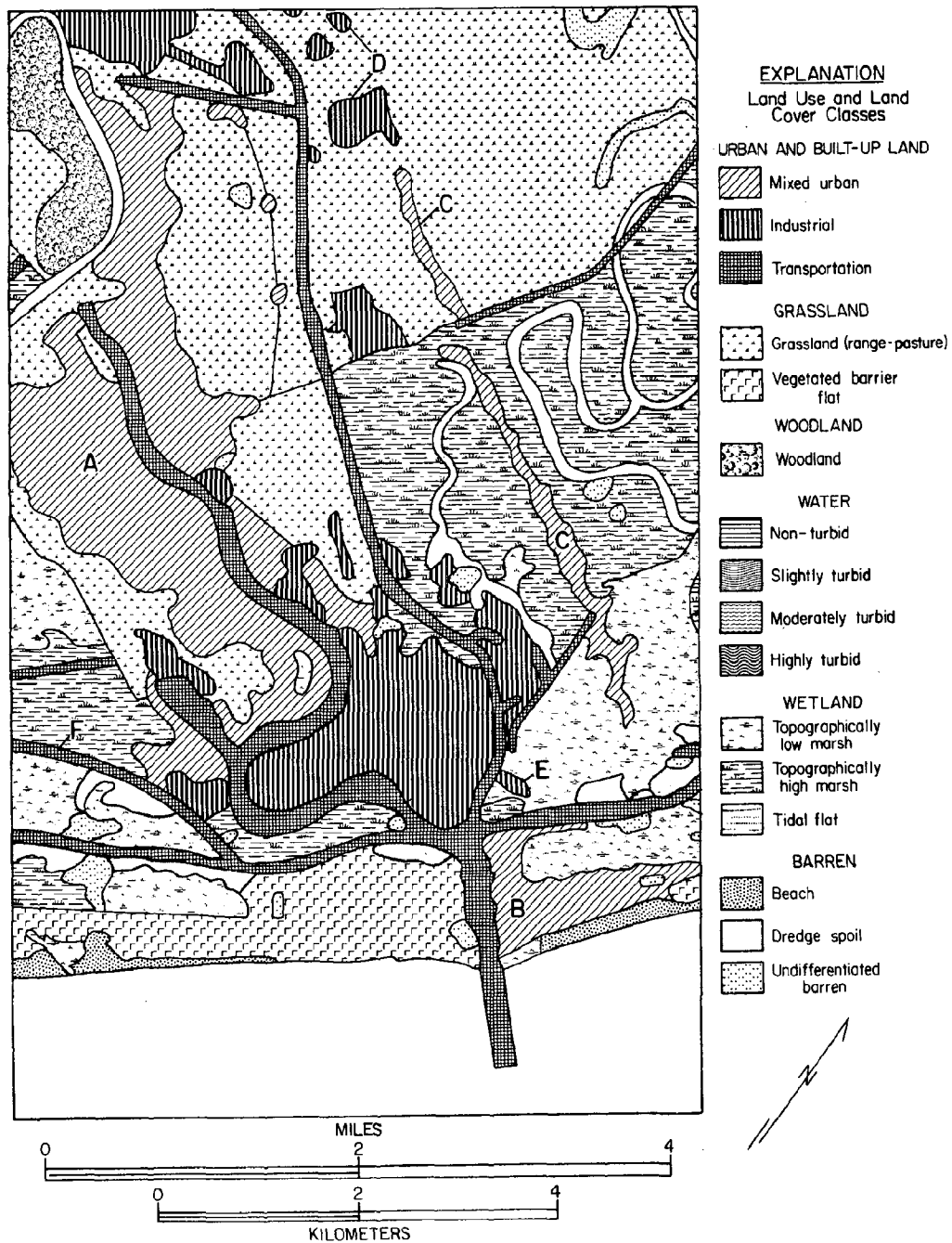

Figure 33. Freeport area, test site 2, with water units unclassified except for transportation (dredged canals or maintained river channel), delineated from Landsat scene 1289-16261, 8 May 1973. Lettered locations are explained in text.

hurricane-surge protection dike at an elevation of 4.9 m (16 ft).

Natural species zonation within saline marshes is related to gradual elevation changes, with less salt-tolerant species at greater elevations above mean sea level. In this instance, the dike (F, fig. 33) separates saline from brackish to freshwater marshes over an extremely short horizontal distance. Spartina alterniflora and Batis maritima are abundant seaward of the dike, along with a relatively greater area of open water, while Spartina spartinae, Distichlis spicata, and some Scirpus spp. (bulrush) are found on the landward side. The false-color composite response of the brackish-fresh marsh is dull red to blackish red, whereas the saline marsh is bluish black with faint reddish-black patches.

Clements (appendix B) concluded that topographically high marsh, or marsh which is inundated by the highest spring tides or by wind tides, is difficult to delineate, owing to gradational boundaries with coastal prairie and with other units. Within the Freeport-San Luis Pass test site, dredge spoil is colonized by high-marsh plant species. It can therefore be difficult to distinguish vegetated spoil from the natural marsh unless the characteristic shape of the spoil pile or its location adjacent to a channel are evident on the imagery.

Since only one scene was mapped in test site 2, no change detection analysis was undertaken in the Freeport-San Luis Pass area.

### 6.3.2 Analysis of Test Site 3

Site description.--Within the San Antonio-Espiritu Santo Bay test site (fig. 34), wetlands are primarily found adjacent to Pass Cavallo, along the mainland shoreline near the junction of the two bays, and in

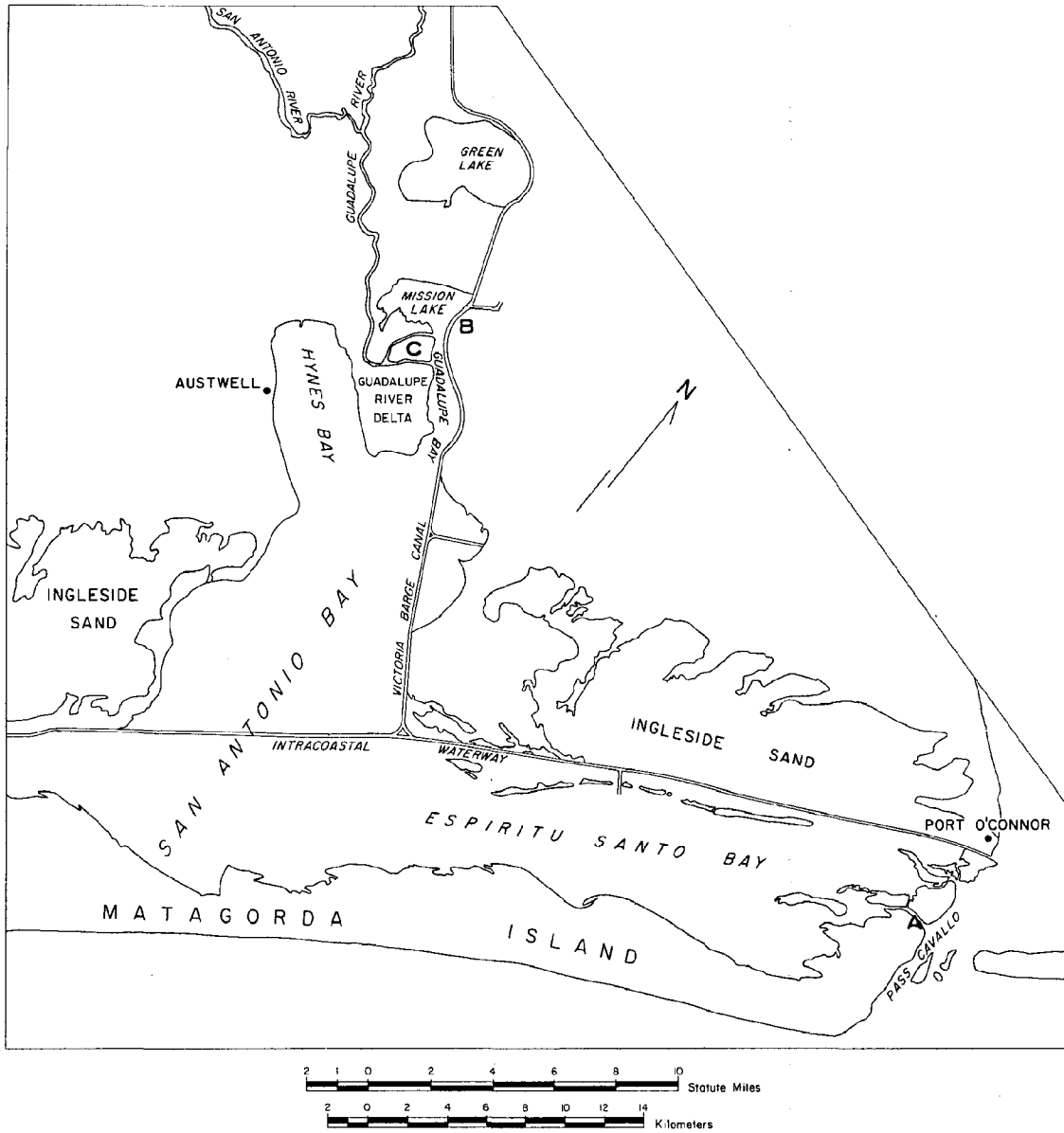

Figure 34. Geographic features in the vicinity of test site 3.

the upper reaches of San Antonio Bay where approximately 12,800 acres (Clements, personal communication, 1976) of fresh to brackish marsh are located. Characteristic saline and brackish marsh plants are the same as those listed for test site 2, with the addition of Borrichia frutescens (sea oxeye), a shrubby plant not tolerant of prolonged saltwater inundation and therefore found in the topographically high marsh.

The flood-tidal delta marshes (A, fig. 34) of the Pass Cavallo area are the most extensive saline marshes within test site 3. The dominant species are Spartina alterniflora, Batis maritima, and Salicornia spp. in the low areas and Spartina patens with bluestem and other grasses on the more elevated ground. Along the margins of upper San Antonio Bay (B, fig. 34) and on the delta of the Guadalupe River (C, fig. 34), brackish to fresh marshes include Distichlis spicata, Spartina spartinae, Spartina patens, Phragmites communis (reed), and Juncus spp. (rush).

The land adjoining the bays is rural, and communities (fig. 34) such as Austwell (pop. 284) and Port O'Connor (pop. 350) have a low density of development with widely spaced buildings and wide intervening areas of grassland. Farming, ranching, and both sport and commercial fishing are the major sources of income in this region. Cropland in site 3 is concentrated over Pleistocene interdistributary mud with distributary silts and sands (McGowen and others, 1976b). Pleistocene deltaic sands, barrier strandplain sands, and sheet sands are not favorable for crops and therefore such areas are used as range-pasture lands. The latter include the Ingleside sands southwest of Port O'Connor and south-southwest of Austwell (fig. 34), which appear mottled on Landsat imagery owing to accumulation of mud and organic material in isolated low depressions.

The marshes of the Guadalupe River delta (fig. 34) are developed on Modern-Holocene deltaic muds and sands and on associated levee and crevasse splay deposits of mud, silt, and sand (McGowen and others, 1976). Grasslands with scattered shrubs are present on delta-plain muds and sands located inland of Hynes Bay and Mission Lake (fig. 34). The Guadalupe River and its distributaries are bordered by thin belts of woodland which include oak, hickory, pecan, and hackberry.

Mapping results.--The San Antonio-Espiritu Santo Bay test site was mapped using a 29 March 1974 Landsat-1 image (fig. 35) and a 25 February 1975 Landsat-2 image (fig. 36 and plate 3). The February scene is of better quality, enabling more accurate mapping of the topographically low marsh of the Pass Cavallo flood-tidal delta and clearer discrimination of low-density development in Port O'Connor (A, fig. 37) from surrounding grasslands. The 29 March 1974 image proved more useful, however, in mapping the marshes at the head of San Antonio Bay. The one-month difference in the times of these images apparently corresponds to a significant period of annual plant growth in these fresh- to brackish-water marshes (Clements, personal communication, 1976). This initial growth results in increased infrared reflectance, and therefore greater intensity and variation of the red tones in the false-color composite image. These color differences, along with the blue to black tones representing wet and/or barren substrate, are crucial to the discrimination of the floral zones.

The low Pass Cavallo marshes (fig. 37) gave a distinctive greenish-blue to black Landsat signature, whereas the topographically high marsh areas appeared reddish black. In view of the proximity to a major tidal inlet, low-marsh species tolerant of full seawater salinities were expected, and this was confirmed by sampling transects (table 17). A



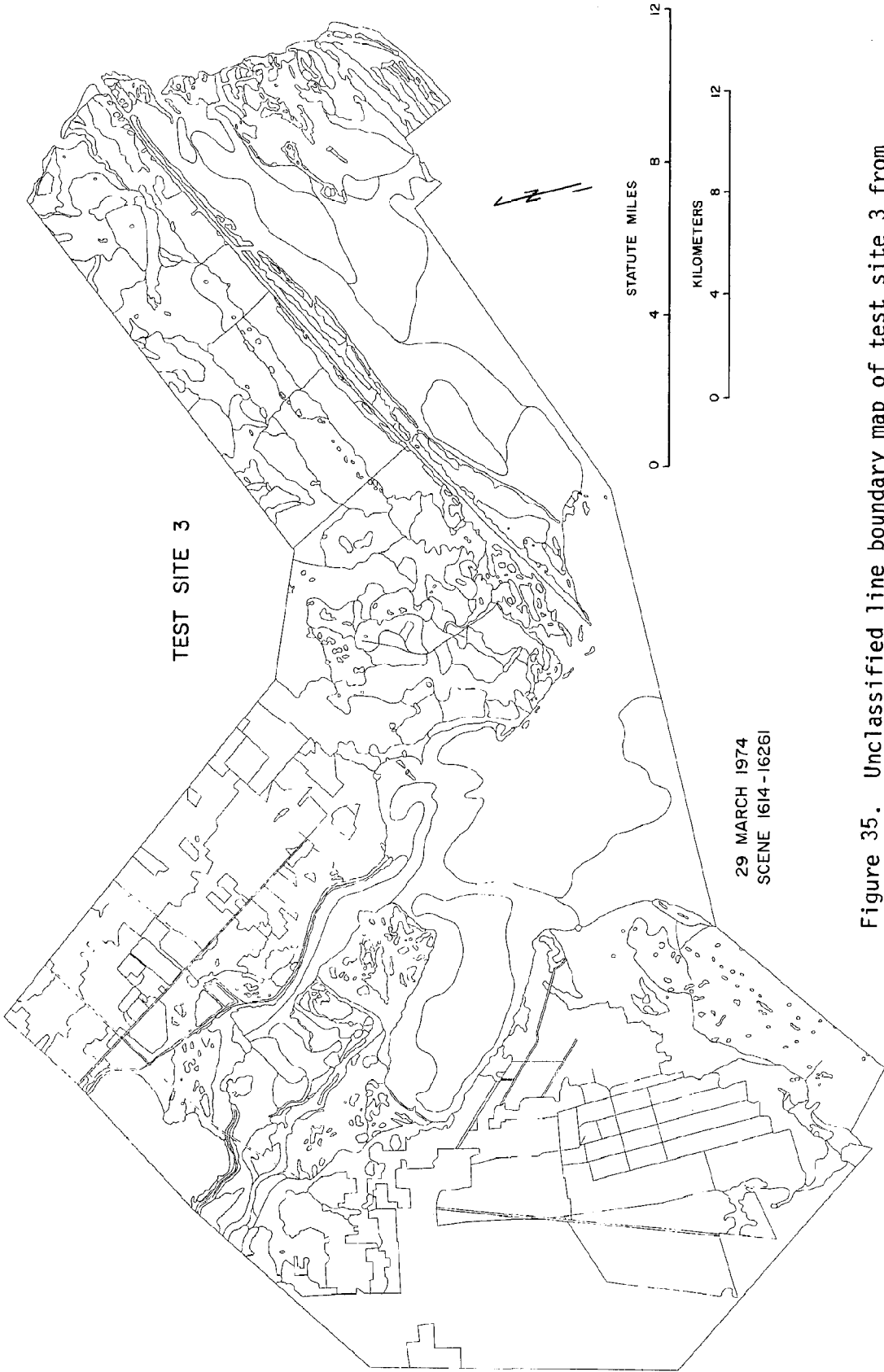

Figure 35. Unclassified line boundary map of test site 3 from 29 March 1974 imagery.

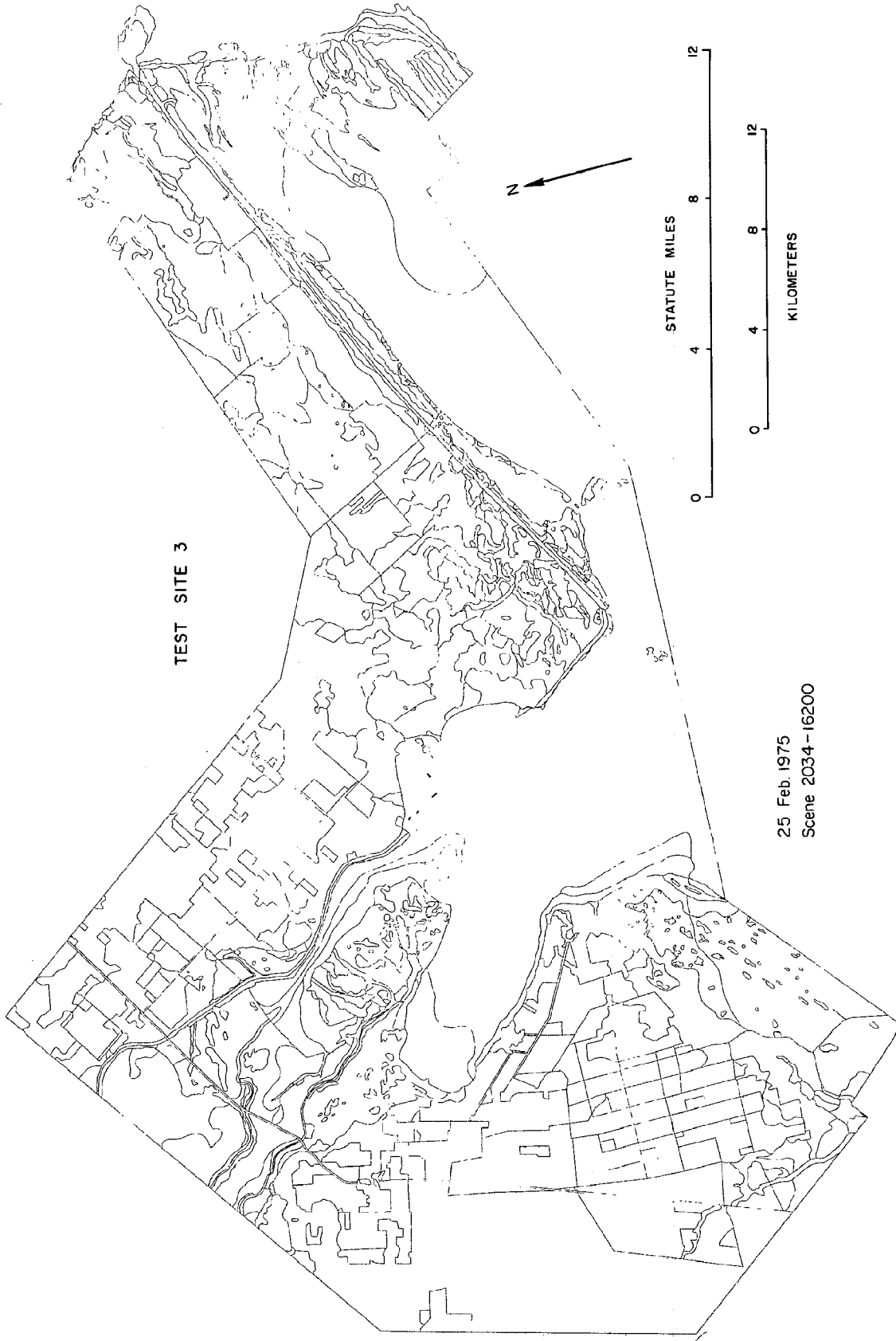

Figure 36. Unclassified line boundary map of test site 3 from 25 February 1975 imagery.

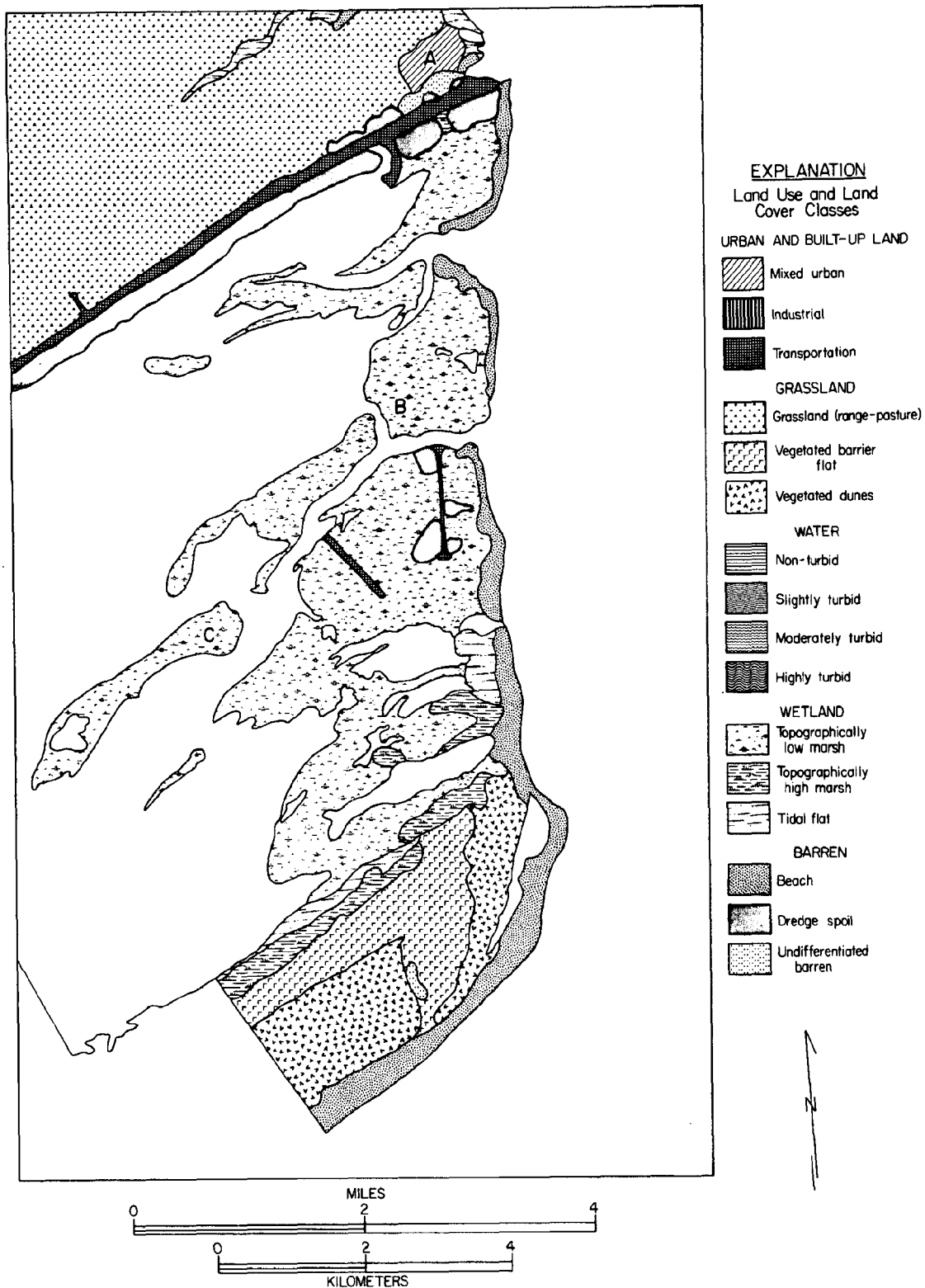

Figure 37. Pass Cavallo area with water units unclassified, except for transportation (dredged channels), and land units classified from Landsat scene 2034-16200, 25 February 1975. Lettered locations are explained in text.

Table 17

## VEGETATION TRANSECTS IN THE LOW MARSHES AT PASS CAVALLO\*

Location	Species	Relative Cover	Average Height
B, fig. 29	<u>Batis maritima</u>	38.0%	0.28 m
	<u>Spartina alterniflora</u>	34.0%	0.66 m
	<u>Avicennia germinans</u> (black-mangrove)	9.0%	
	Bare ground	20.0%	
C, fig. 29	<u>Batis maritima</u>	39.3%	0.40 m
	<u>Avicennia germinans</u>	16.2%	
	<u>Spartina alterniflora</u>	9.4%	
	<u>Salicornia spp.</u>	8.5%	
	Bare ground and water	26.5%	

\*From data provided by the Texas Parks and Wildlife Department for this investigation (appendix B).

substantial difference in the area of wet, bare substrate and open water between the topographically high and low marshes supports the finding by Erb (1974) that water content may be an important factor in the delineation of marshes by means of satellite data. Ground observations confirm the existence of permanent tidal pools and patches of bare tidal flat within the Pass Cavallo marshes which range in area from several tens to several thousands of square meters.

Comparison of maps made from the 29 March 1974 and 25 February 1975 imagery suggests that Landsat data might be used to evaluate the extent of aperiodic inundation of marsh, tidal flat, and beach. Using line boundary maps enlarged from 1:125,000 to 1:80,000, 704.8 hectares (1,741 acres) of additional emergent area was evident on the February 1975 image (fig. 38). Tide gage data supplied by the Galveston District of the U. S. Army Corps of Engineers indicate (1) a 0.43 m (1.4 ft) lower water level for that date compared to 29 March 1974 and (2) a complete masking of the predicted astronomical tide (inset, fig. 38) by a wind tide resulting from strong northerly winds preceding the time of satellite passage (appendix C). The levels of both the upper bay and nearshore Gulf waters are lowered as a consequence of the offshore-directed wind stress. These data illustrate the importance of obtaining time histories of wind and actual, rather than predicted, tidal elevations in evaluating water levels seen on Landsat imagery.

A stabilized dune complex with elevations of 2 to 6 m adjacent to Pass Cavallo and the negative effective precipitation (fig. 4) in this region indicate that wind transport of sediment is relatively more important than in test site 2. The linear pattern of vegetated beach ridges evident on Matagorda Island near Pass Cavallo (figs. 35 and 36)

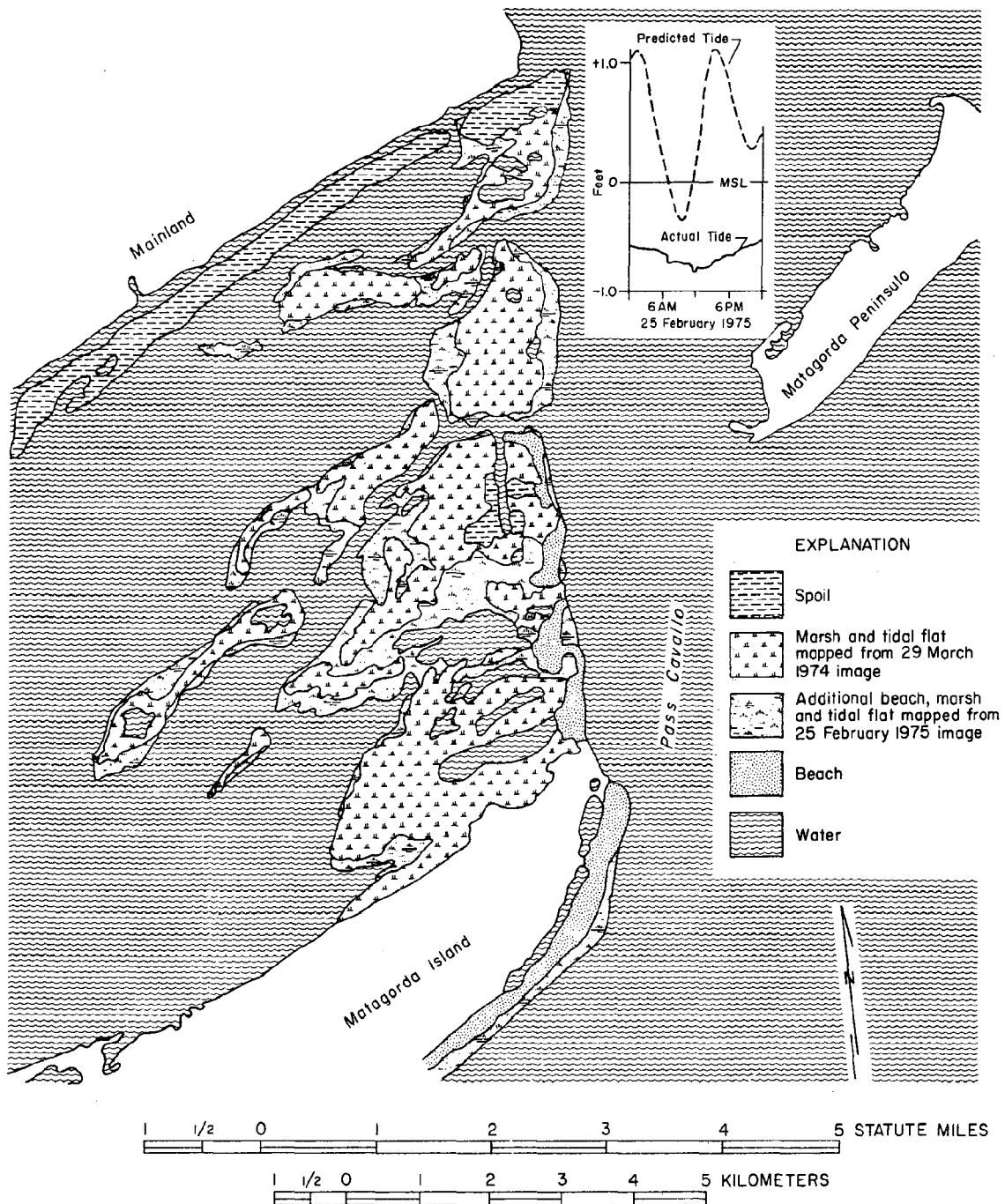

Figure 38. Map showing change in area of emergent marsh, tidal flats, and beach at Pass Cavallo owing to wind tide of 25 February 1975.

was easily detected on Landsat imagery; the ridges are probably the best examples of vegetated dunes mapped within any of the test sites.

The Guadalupe River delta at the head of San Antonio Bay (fig. 39) includes fresh- to brackish-water marshes and fluvial woodlands. The distribution of turbidity within the bay reflects the influx of sediment-laden river water at the north end of the delta. A very similar turbidity pattern is evident on high-altitude photography (NASA Mission 300) taken a year after the Landsat imagery, suggesting that such semipermanent or seasonal flow patterns may be monitored with Landsat data. The river distributaries cannot be directly detected on Landsat images, however, because they are less than 40 m in width and they are masked by the fluvial woodlands along the riverbanks.

The influx of river water near the marshes at B and C (fig. 39) results in a species contrast which differs from the tidal inlet marshes and from the marshes near Freeport (F, fig. 33). Table 18 indicates that Distichlis spicata, which seems less tolerant of salt water than Spartina alterniflora but has greater tolerance than Spartina spartinae, is here more abundant in the area classified from Landsat as low marsh. Spartina spartinae is primarily found in the fresher-water areas. These field results support the interpretation of the Landsat imagery. The topographically low marshes at D (fig. 39) are nearly as wet as the tidal pass marshes (B, C, fig. 37) and have a similar Landsat signature, but they contain fresh- to brackish-water species such as Polygonum punctatum (smartweed) and Phragmites communis (common reed) (Benton and others, 1975, and Lodwick, personal communication, 1977). Thus within a single test site the species content of the low marsh category (table 17 and C, table 18) may vary greatly because of the effect of localized fresh- or saltwater

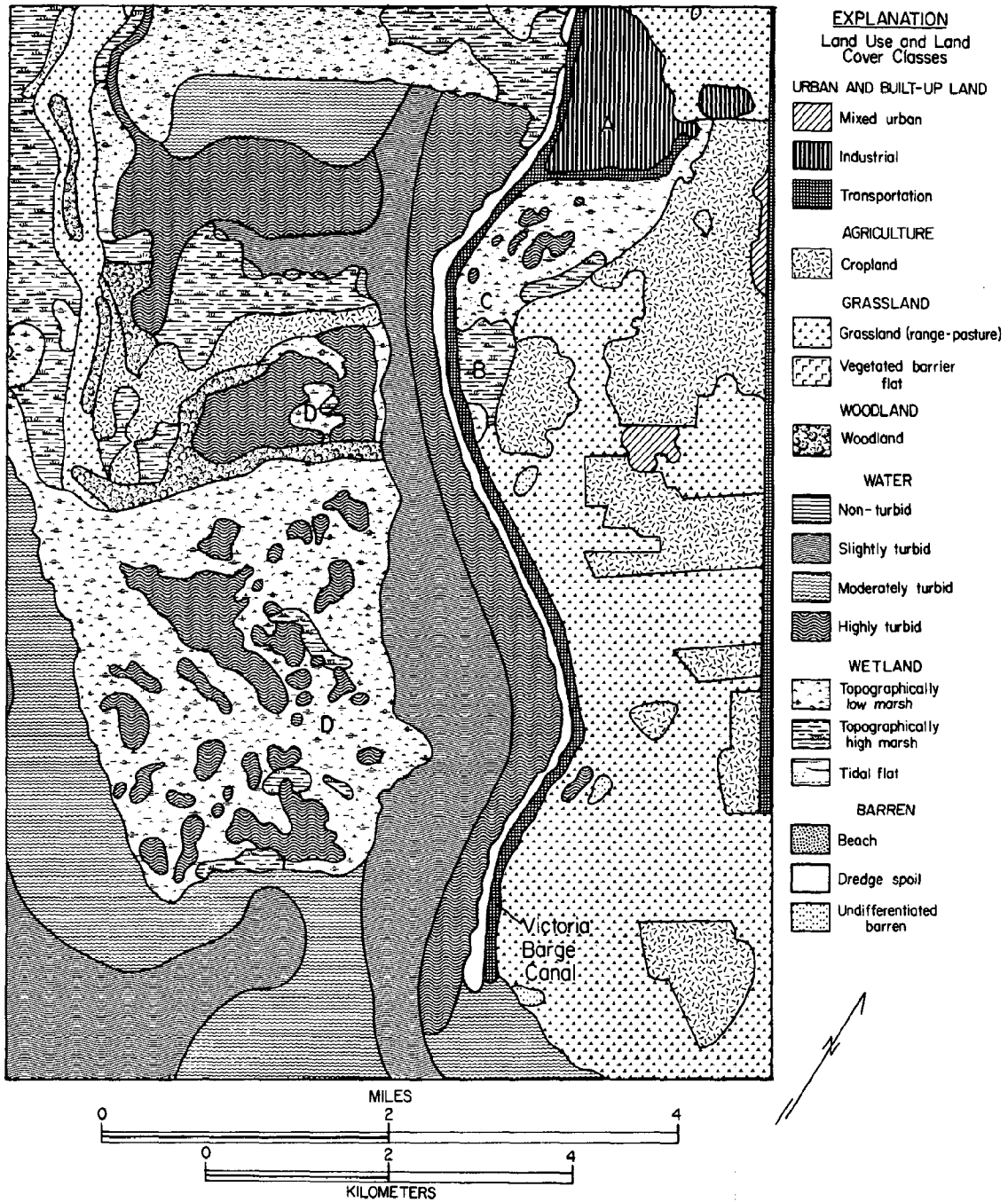

Figure 39. Guadalupe River delta area with classified land and water units, delineated from Landsat scene 1614-16261, 29 March 1974. Lettered locations are explained in text.



Table 18

## VEGETATION TRANSECTS IN THE UPPER SAN ANTONIO BAY MARSHES\*

Location	Species	Relative Cover	Average Height
B, fig. 31	<u>Spartina spartinae</u>	39%	0.12 m
	<u>Distichlis spicata</u>	5%	
	Bare ground	56%	
C, fig. 31	<u>Distichlis spicata</u>	74%	0.33 m
	<u>Rotala ramosior</u> (rotala)	17%	0.55 m
	<u>Spartina patens</u>	4%	
	<u>Spartina spartinae</u>	2%	
	Bare ground	2%	

\*From data provided by the Texas Parks and Wildlife Department for this investigation (appendix B).

influx; that variation is not readily discernible on Landsat imagery.

Cropland (fig. 39) is often recognizable by the regular boundaries of the fields and, when crops are not present, by the contrast of the low-reflectance muddy substrate with surrounding grasslands. The range-land grasses show less infrared reflectance than cultivated crops and therefore have a pale-red signature on the false-color composite in contrast to the vivid red of such crops as grain sorghum. The holding ponds (A, fig. 39) and a spur on the Victoria Barge Canal are evidence of the major industrial area located northeast of these ponds.

Change detection.--The change detection techniques outlined in fig. 3 were first applied in test site 3, using band 7 transparencies enlarged to 1:125,000. The most distinct difference between the 29 March 1974 and 25 February 1975 scenes was detected in the grasslands southwest of Port O'Connor, where tracts up to 1.5 mi<sup>2</sup> (3.8 km<sup>2</sup>) in area had been burned. Burning these grasslands removes dead culms and encourages the growth of young shoots, especially of Spartina spartinae, on which cattle thrive (Clements, personal communication, 1976). On the Landsat false-color composite, the blackish burned areas contrast sharply with the infrared response of the grasslands; using repetitive Landsat imagery, acreage being managed by this technique can be easily estimated.

Vegetal differences were also noted in the wetlands of the delta plain north of the Guadalupe River delta because of the stage in the annual growth cycle of the vegetation. In the croplands, radiance differences evidently relate to whether or not fields are completely plowed under at the end of the growing season. Because water level differences between these two scenes (fig. 38) resulted in substantially different shoreline configurations, land features were used to register the images during change detection studies.

### 6.3.3 Analysis of Test Site 5

Site description.--The southern Laguna Madre area test site (fig. 40 and plate 3) includes part of South Padre Island, the lagoon, and saline and prairie grasslands of the adjacent mainland. The climate is semi-arid with a normal annual rainfall of 26 inches; the pronounced deficit in precipitation leads to active aeolian transport of sediment and only sparse growth of barrier island vegetation. Species present on dunes and within scattered areas of vegetated barrier flat include Uniola paniculata (sea oats), Sporobolus virginica (seashore dropseed), and Croton punctatus (doveweed) (Sauer, 1967). Much of the barrier island consists of coalescing washover channels, washover fans, and blowouts. Broad tidal flats have been formed along the margin of Laguna Madre by wind transport of sediment derived from the overwash deposits (MCGowen and Scott, 1975). Algal mats are present on parts of the wind-tide dominated flats, and aquatic herbs such as Halodule wrightii (shoalgrass) and Ruppia maritima (widgeon grass) grow submerged in the lagoon. Marshes similar to those found in test sites 2 and 3 are virtually absent.

West and southwest of the Arroyo Colorado (fig. 5), prairie grasslands are found inland from the wind-tidal sandflats which border Laguna Madre. These grasslands are characterized by flat topography developed over mud and sand substrate and are extensively cultivated (Brown and others, in progress). Crops of grain sorghum and cotton, as well as orchards, are common. Areas of chaparral-type vegetation, containing Prosopis glandulosa (mesquite), Pithecellobium flexicaule (Texas ebony), and other poorly formed trees occur southwest of Arroyo Colorado and were mapped from Landsat imagery.

The saline grasslands, located from south of the Arroyo Colorado to

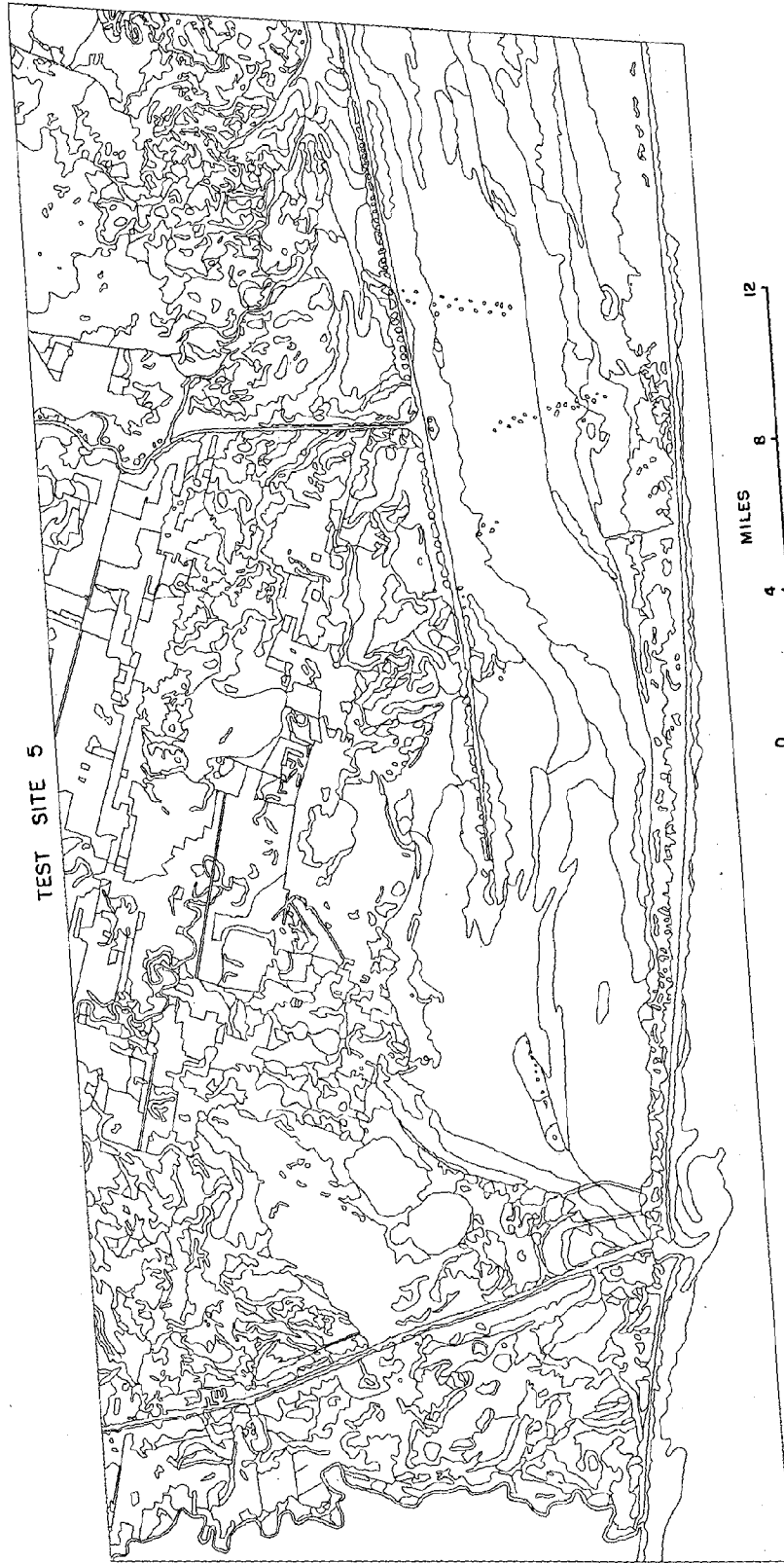

25 Feb. 1975  
 Scene 2034-16205

Figure 40. Unclassified line boundary map of the southern Padre Island-Laguna Madre test site.

the Brownsville Ship Channel and the Rio Grande, are developed on mud substrates and include Salicornia spp., Batis maritima, Monanthochloe littoralis, and Borrchia frutescens at slightly greater elevations; in less saline soils, Spartina spartinae is found (Johnston, 1955). The grassland association dominated by Spartina spartinae (gulf cordgrass) is locally known as "sacahuista." Some of the same plant species which form marshes on the northern Texas coast form grasslands on poorly drained, saline soils under the semiarid conditions of this southernmost test site. Some freshwater marsh is found in oxbows and abandoned channel courses, known locally as "resacas," and the low reflectance of mud infilling and standing water within these units characterize them on Landsat scenes.

Mapping results.--Test site 5 shows a complex of environments which is especially evident across the inactive Modern-Holocene deltaic plains (Brown and others, in progress) between the Rio Grande and the Brownsville Ship Channel and north of the Arroyo Colorado mouth (see fig. 5 for locations, and plate 4). The latter area is a complex of channels, tidal flats, subaqueous grass flats, algal mats, and undifferentiated barren substrate. Small isolated areas (0.2 to 0.09 km<sup>2</sup>) have been mapped as topographically low marsh within this complex of environments, but they total no more than 1.1 km<sup>2</sup> and may not represent true marsh; rather, these areas may be clumps of halophytic vegetation set within the upper reaches of highly saline wind-tidal flats which are rarely flooded by lagoonal waters.

The city of Port Isabel (A, fig. 41) is detectable with Landsat imagery, as are the two causeways leading across Laguna Madre to South Padre Island. The lawns and trees of the city interspersed with paved

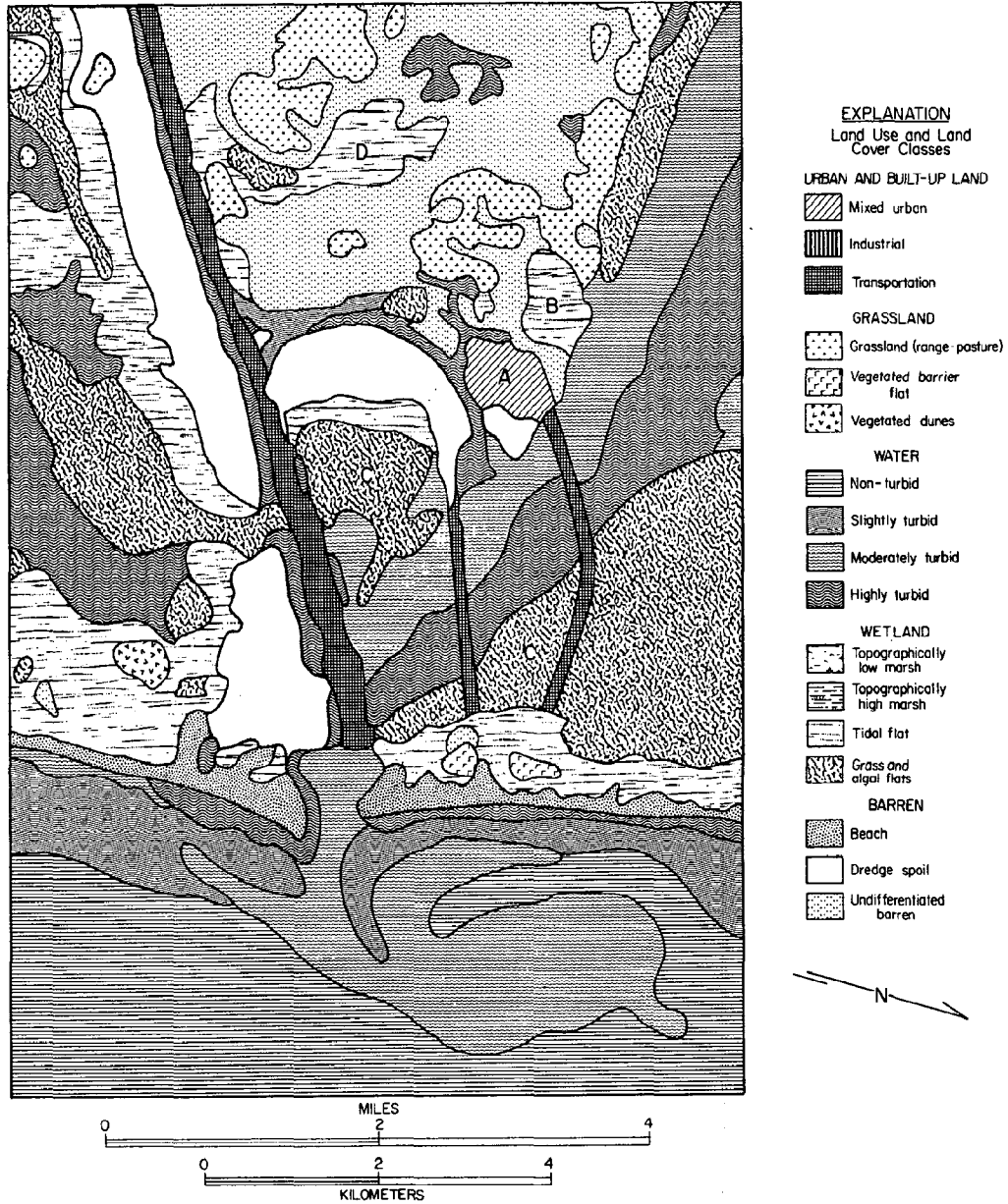

Figure 41. Brazos Santiago Pass area with classified land and water units delineated from Landsat scene 2034-16205, 25 February 1975. Lettered features are described in text.

roads and urban structures give a pebbly, dull-red and white pattern on the false-color composite which, especially when seen with transportation features, helps identify urban complexes. Urban development on Padre Island, however, is not detectable because: (1) many streets are simply cleared areas of loose sand, (2) lawns and planted trees characteristic of developed areas are not present, and (3) structures immediately adjacent to the beach and within the foredune area are masked by the high reflectance of the barren sands. These residential and commercial areas therefore have nearly the same reflectance as the surrounding natural environment of the barrier flat vegetation, tidal flat, and bare sand.

Difficulty was also encountered in mapping residential development along the margins of Laguna Madre. A housing development consisting of dredged channels and spoil fill was mapped as tidal flat (B, fig. 41), since both environments appear simply as wet sandy substrate on Landsat imagery. The channels range from 30 to 45 m in width and could not be differentiated from the surrounding high-reflectance barren spoil.

Within the Brazos Santiago Pass area are subaqueous grass flats (C, fig. 41), barren sandflats (D, fig. 41) which are occasionally flooded (Brown and others, in progress), and vegetated clay-sand dune ridges which were mapped on the basis of their orientation and linearity. Note that the moderately turbid water issuing from the tidal pass turns northward (fig. 41) because the nearshore circulation was under the influence of 12- to 16-knot winds from the south (U. S. Department of Commerce, 1975a) at the time of satellite passage.

No change detection was undertaken for this test site since mapping from only one scene was completed.

#### 6.3.4. Analysis of Test Site 4

Site description.--The Harbor Island test site includes segments of two barrier islands and, at Harbor Island, a complex of marshland, tidal flat, emergent sandflats, and dredge spoil (fig. 42). Areas of shallow water within the test site that support dense, submergent stands of seagrasses such as Ruppia maritima and Holudule wrightii include Redfish Bay, the bay sides of the barrier islands, and parts of Harbor Island. Extensive low marshes are found on Harbor Island that contain Spartina alterniflora, Batis maritima, and Avicennia germinans (black mangrove). S. alterniflora is abundant throughout the area along the submergent to barely emergent margins of natural and man-made land. These marshes are interspersed with shallow ponds and bare to slightly vegetated tidal flats; locally they grade laterally into higher marsh margins which may contain Spartina patens, Distichlis spicata, Spartina spartinae, Monanthochloe littoralis, and Borrchia frutescens. Vegetated dredge spoil supports the latter species, as well as grasses and shrubs typical of the coastal plain and the vegetated flats of the barrier islands.

On the mainland, a live oak (Quercus virginiana) woodland is developed on Pleistocene barrier-strandplain sands at elevations up to 20 to 25 feet (6.1 to 7.6 m) (Live Oak Ridge, fig. 42). Vines, such as Smilax spp. and Ibervillea lindheimeri, occur in the woodland undergrowth which, combined with the sometimes scrubby growth habit of the oak, can form an impenetrable thicket. As in test site 3, shallow ponds occur in depressions within the barrier-strandplain sands and are seen as black specks on the Landsat false-color composite. Rooted submergent vegetation (Myriophyllum spp.) is found within these ponds, and a blue-green algal mat occurs around the margins (Clements, personal communication, 1976).



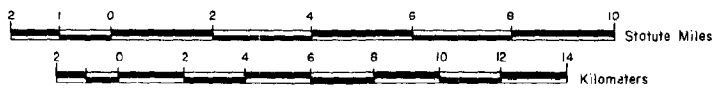
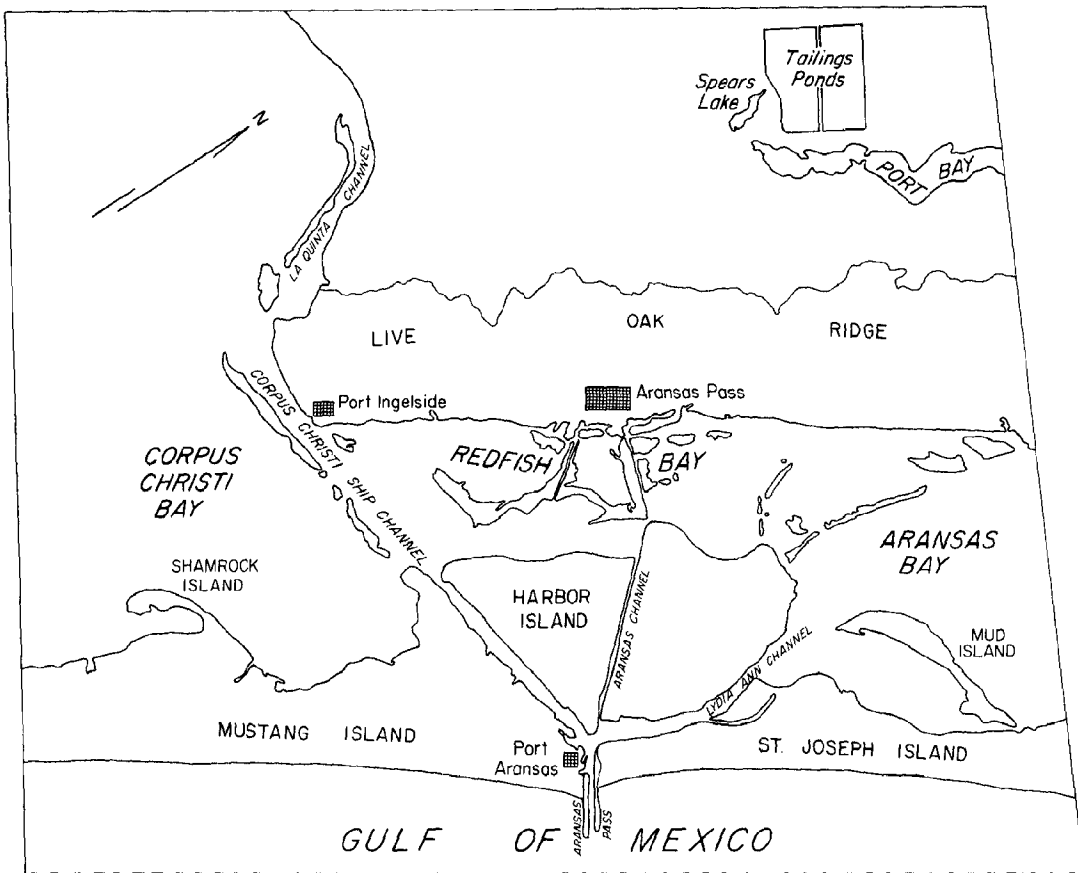

Figure 42. Geographic features in test site 4.

The bottoms of several ponds checked in the field had an inch-thick coating of organic muck, contributing to the low-reflectance signature of these features.

Between Live Oak Ridge and Port Bay (fig. 42), brushland was detected on summer imagery but not on the winter scenes. Prosopis glandulosa (mesquite) provides 80 percent canopy cover (appendix B) in this area, with cactus, Spartina spartinae, and various forbes and grasses also occurring. Grasslands west of Live Oak Ridge are dominated by Cynodon dactylon (Bermuda grass) and are developed on locally mud-veneered sheet sands (Brown and others, 1976). These grasslands are used for grazing. Pleistocene interdistributary muds southwest of Spears Lake and the industrial tailings ponds (fig. 42) support a cropland almost exclusively producing grain sorghum.

A large volume of shipping, both deep-water and intracoastal, moves through the inlet of Aransas Pass and the adjacent ship channels (fig. 42). Transportation of crude oil, production of petrochemicals and carbon black, and commercial fishing are major activities in the area. Channel maintenance results in the need to dispose of substantial amounts of dredge spoil. Dredging and filling is also taking place along the bay margins of Mustang Island because of residential development.

Mapping results.--Landsat scenes dating from 25 February 1975 (fig. 43 and plate 5), 10 July 1975 (fig. 44 and plate 6), and 2 February 1976 (fig. 45) have been mapped and fully classified. A fourth scene (1146-16320) (fig. 46), dating from 16 December 1972, was completed as a line boundary map and the seaward half of the test site area was classified. Results were unsatisfactory, however, as described in the following section.

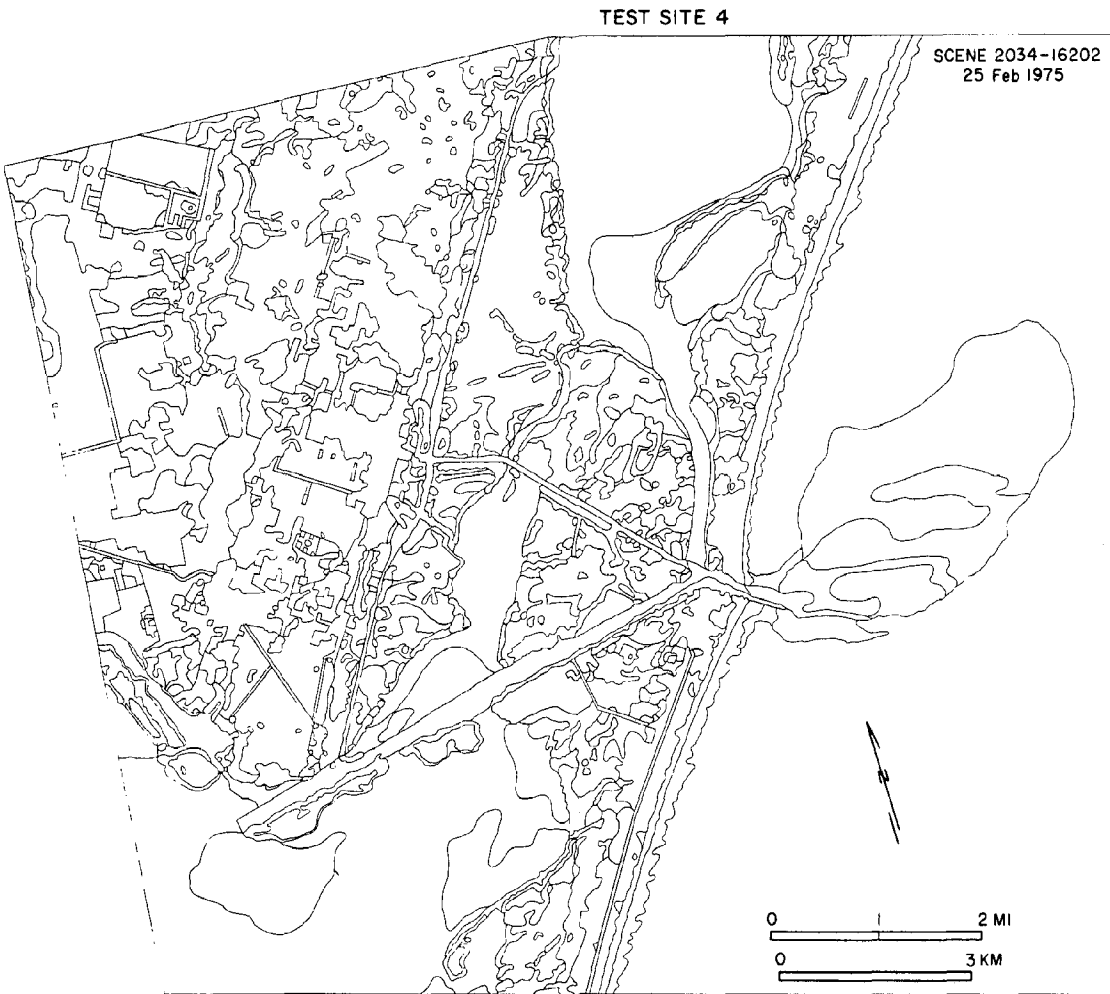

Figure 43. Unclassified line boundary map of the Harbor Island test site, 25 February 1975.

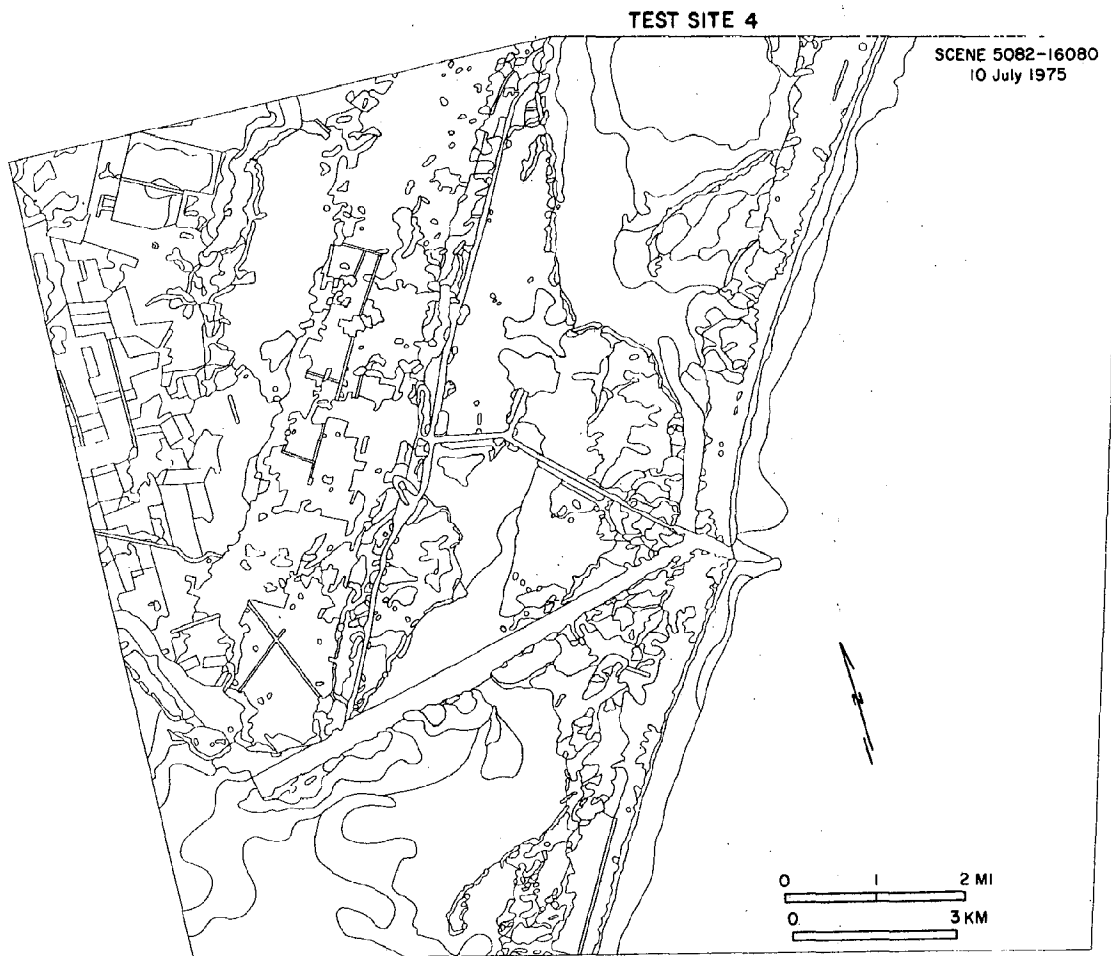

Figure 44. Unclassified line boundary map of the Harbor Island test site, 10 July 1975.

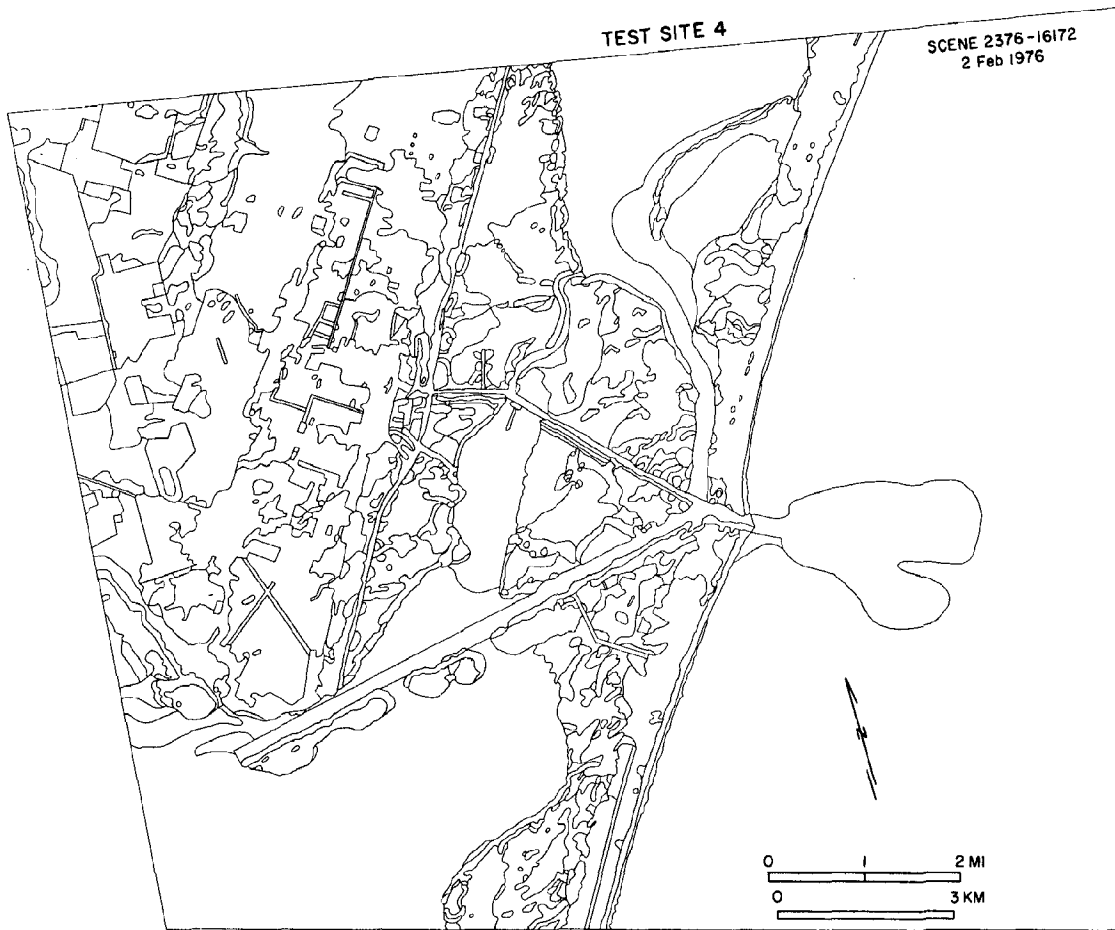

Figure 45. Unclassified line boundary map of the Harbor Island test site, 2 February 1976.



Figure 46. Unclassified line boundary map of the Harbor Island test site, 16 December 1972.

Special emphasis was placed on change detection and the mapping of dredge spoil within test site 4.

The wetlands of Harbor Island were the only areas studied during this investigation within which a single marsh species could be uniquely identified from Landsat data. Between Aransas and Lydia Ann Channels, dense stands of black mangrove are evident because of their high infrared reflectance. These areas appear deep red on the Landsat false-color composite; the signature is enhanced by reflectance from leaves 4 to 8 cm long and greatly resembles the response of live oak. Black mangrove is an evergreen (Jones, 1975); hence it has a consistent Landsat signature throughout the year. Other areas of the Harbor Island marshes have a blue to blue-black signature where S. alterniflora and Batis maritima are dominant, tending to light blue when lower water levels expose more bare substrate.

Difficulty was encountered at times in placing the boundary between seagrass and algal flats, tidal flats, and low marsh as a result of the intermixing of these units in the natural environment (fig. 47). Many narrow strips of marsh were not detected or were included in the tidal flat category owing to the dominant signature of the wet substrate or of ponded water. Bay-margin sand and shell berms, which would be classified as beaches, are difficult to distinguish from adjoining tidal flats and areas of shallow water. Along the northeast margin of Redfish Bay, the high-radiance subaerial sand and shell accumulations are less than 80 m wide in many areas. Their light-blue signature resembles that of the wide areas of tidal flat behind Mustang Island or on Harbor Island.

On the barrier islands, the areas mapped as beach include sandflats with wind shadow dunes and washover channels, all of which have high

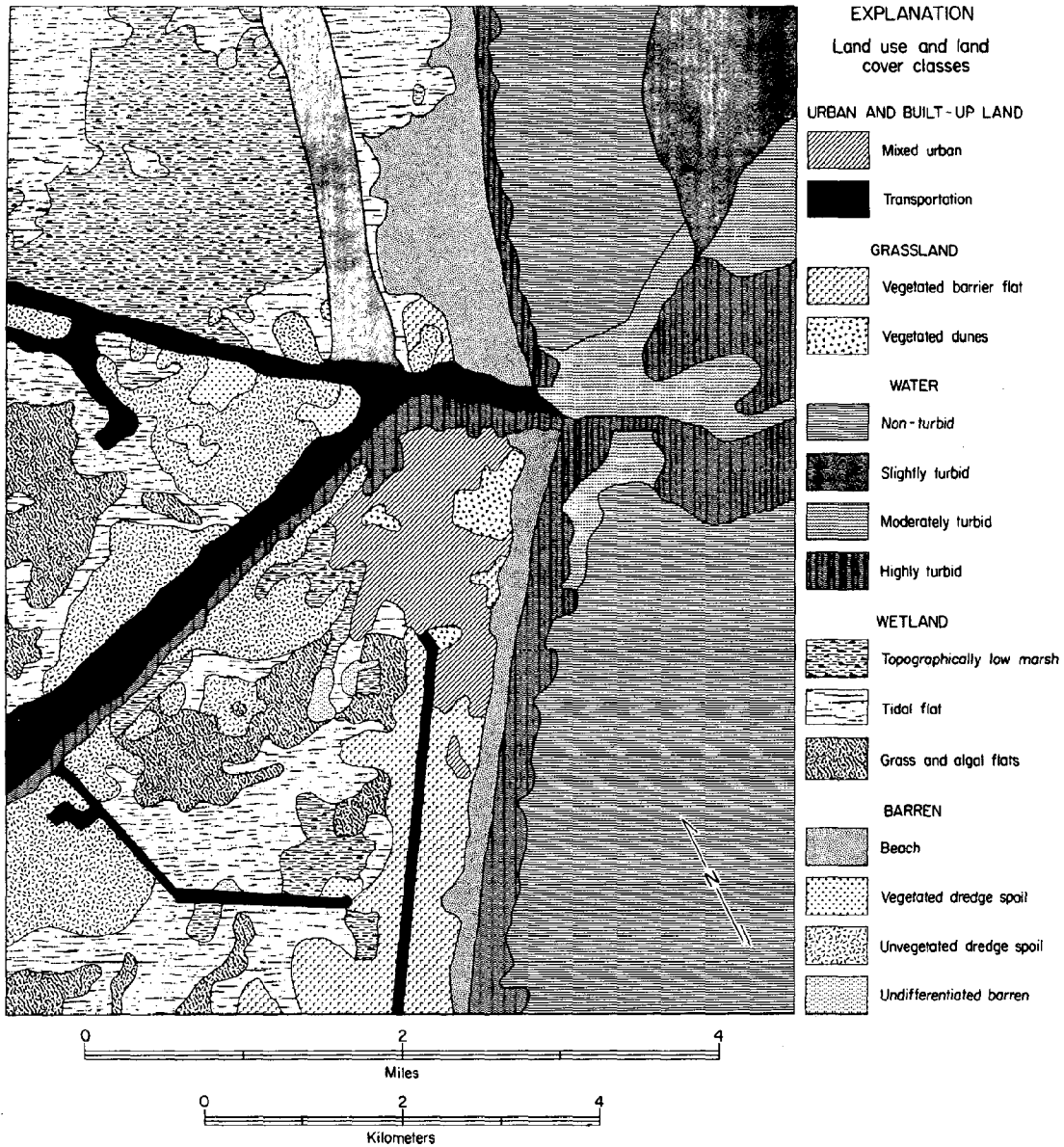

Figure 47. Aransas Pass area with classified land and water units delineated from Landsat scene 2034-16202, 25 February 1975.



reflectance and therefore indistinguishable mutual boundaries. Vegetated dunes behind the beach are not readily separated from the adjoining vegetated barrier flat, but were differentiated adjacent to the town of Port Aransas due to the more highly textured appearance of the dune area (fig. 47). Small (up to 375 by 275 m) areas of barren dunes have been mapped on Mustang Island where they occur as blowout complexes extending from the beach into the vegetated barrier flat.

The built-up area of Port Aransas (fig. 42) is difficult to recognize compared to the mainland urban areas of Aransas Pass and Ingleside. As in site 5, where development on Padre Island was not discernable on the Landsat imagery, a characteristic urban signature is not developed unless the natural barrier island vegetation is largely displaced and the density of structures reaches some critical level. The setting of the mainland urban areas, such as Aransas Pass, within a live oak woodland enhances their detectability since the imagery shows both a radiance difference and a textural contrast between areas.

The boundaries of each mainland urban area show some variation when maps produced from successive scenes are compared. These differences are attributed to operator judgment in the placing of unit boundary lines. Atmospheric and sun angle variations between images, differences in image processing, and variations in image quality affect the interpreter's decisions. Differences in the seasonal growth stage of the natural vegetation (other than the live oak) may also be a factor in delineating the urban areas, especially along transitional margins where the density of development is low.

Landward of Live Oak Ridge (fig. 42) is an area of mixed grass and brush rangeland. On the 25 February 1975 and 2 February 1976 scenes the

entire area was mapped as grassland, while on the 10 July 1975 scene, as detailed in the site description, the area adjacent to Port Bay was classified as brushland. This would be expected where brushy vegetation is deciduous. The tonal and textural variation within the brushland unit is substantial, and field checking has shown both fairly open and very dense brush growth to occur there. These results suggest that Landsat coverage during both the winter and the growing season is required to identify deciduous brushland and entirely deciduous woodland.

Expected seasonal differences were distinguished in the cropland on the northwest margin of the test site. Winter scenes show barren fields consisting of a muddy substrate and defined by linear field boundaries. The false-color composite of the summer scene shows signatures varying from bright red through pale red to bluish gray over the cropland. Field checking in July 1976 indicated that sorghum fields were in various stages of development from just prior to full ripening through post-harvest stubble and plowed ground, thereby adding variation to the cropland tonal response.

#### 6.3.5 Summary of Test Site Results

The test sites chosen have given an adequate sample of the climatically controlled variation in natural environments found along the Texas coast. The only exceptions to this statement might be the exclusion of forested wetlands, such as the swamps within the Trinity River delta vicinity, and the limited sampling of freshwater marshes. More widespread use of the classification scheme (table 7) to include bay-head areas would require the addition of a swampland category.

The difficult task of differentiating wetland species, or species groups, was avoided during this study in favor of wetland delineation

based primarily on observable water content and exposed bare substrate, as reflected by the general level of infrared response. The categories of topographically high and topographically low marsh therefore vary in species content, even within a limited area such as test site 3. To go beyond these designations is not within the capability of the optical mapping techniques employed during this investigation. An exception is the potential to locate dense stands of Avicennia germinans (black mangrove) in test site 4 (section 6.3.4).

While the designation of low marsh areas was readily agreed to by a group of observers in the field, the delineation of high marsh was open to disagreement. The coastal prairie grasslands of Texas are generally developed on low, poorly drained, heavy clay soils and are dominated by Spartina spartinae (appendix B). These grasslands lie adjacent to the coastal bay and marsh systems and intergrade with the high marshes, resulting in indistinct floral zonation within this zone. Although difficult to differentiate, retention of the topographically high marsh category seems warranted, especially on the upper coast north of test site 3. Botanical evidence supports this conclusion (appendix B), because Distichlis spicata, Monanthochloe littoralis, Sporobolus virginicus, and Borrchia frutescens occur at greater elevations than low marsh species but generally not within the coastal salt grass prairie. Field investigations indicate that the inner boundary between high marsh and the coastal prairie is more difficult to map accurately than is the boundary between high marsh and low marsh. Certainly the low (0.42 m) astronomical tidal range on the Texas Gulf Coast is less of a causal factor in marsh zonation than the 1.5 to 2.0 m tidal range off the southeastern United States.

Although submerged grasses and algal mats are not wetlands according to common definitions (Clark, 1974), these units most logically fit within the Level I Wetland category (table 7). Submersed within Redfish and Aransas Bays and Laguna Madre, Thalassia testudinum (turtle grass), Syringodium filiforme (manatee grass), Halodule wrightii (shoal grass), and Ruppia maritima (widgeon grass) form an important part of the bay ecosystem and an excellent substrate for the growth of epiphytic algae (Edwards, 1976). Algal mats develop on inundated wind-tidal flats, leaving a black organic residue when desiccated by subaerial exposure. Seagrasses are best detected when water levels have been lowered owing to strong offshore-directed winds.

Submerged grasses can be easily differentiated from algal mats over known open bay areas, but optical differentiation using Landsat data becomes more difficult along the shallow bay margins. Seagrass and algal mats therefore have been combined into a single class, with the understanding that the largest seagrass beds could be delineated from supplementary information available to users of natural resource data in Texas.

No moderate-density urban areas, such as Galveston or Corpus Christi, were included in any of the test sites. With the exception of Freeport, all urban areas mapped were of relatively low density. Wide spacing of structures and a greater percentage of natural vegetation make less intensely developed urban areas difficult to map by Landsat image interpretation. The outermost margins of towns such as Port Aransas (fig. 42) merge with surrounding woodlands or grasslands, and detectability depends on favorable atmospheric conditions during satellite passage and image quality. Roads vary in detectability, depending on reflectivity

contrast of the road material with surrounding areas and characteristics of each image. Mapping of oil fields (category 131, table 7) was limited to the detection of the field at Hoskins Mound, a shallow salt dome. The circular pattern of barren well sites and access roads and the holding ponds associated with hydrocarbon production are readily recognized on Landsat imagery.

Comment should also be made on the detection of woodlands and vegetated dredge spoil using optical enlargement of Landsat standard products. The Coastal Plain of the Atlantic and Gulf states is the habitat of live oak (Quercus virginiana) (Haislet, 1963), which as an evergreen aids in the mapping of woodlands. This tree's signature remains consistent throughout the year, and even a few live oaks within a deciduous forest aid in the mapping of woodlands on winter scenes. Live oak is found along watercourses, hence a high-infrared reflectance signature on a winter image can be indicative of a fluvial woodland containing Quercus virginiana.

Mapping of vegetated dredge spoil is dependent on the shape and position of this land cover unit. Upland, dune, and barrier flat grasses are found on spoil mounds and result in a Landsat signature which contrasts sharply with surrounding marshlands. Position parallel to dredged channels and an oblong to circular shape are keys to recognition of vegetated spoil. Since these characteristics can be utilized by the human interpreter but not by digital recognition routines, the inclusion of this unit in a land cover and land use system (table 7) requires visual interpretation of imagery to use the present classification scheme.

Dredge spoil detection.--In view of the importance of dredging as a factor in the coastal environment, a special study of dredge spoil

additions within the Harbor Island test site was undertaken. The extent of barren subaerial spoil was mapped from Landsat imagery for ten days (table 19) during the period 21 January 1973 to 2 February 1976. Band 5 images were used to locate spoil deposited on areas already subaerially exposed, while band 7 data were used to delineate spoil dumped into water bodies to create spoil islands. The high-contrast band 7 images did not provide enough detail for the subaerial sites, hence the use of the band 5 images, supplemented by use of the false-color composite image when available.

Figure 48 provides a summary of all spoil added in test site 4, as detected from the Landsat images. Two distinct periods of spoil addition were noted along with areas which remained unchanged. Most of the spoil was added to the channel-margin spoil islands and the East Flats area between 14 June 1973 and 29 March 1974, and between 7 September 1974 and 17 October 1975 (fig. 49). A large amount of spoil was also deposited on Harbor Island between 14 June 1973 and 19 March 1974 and was evident on the band 7 image from the latter date. Within specific areas on Harbor and Mustang Islands, no spoil was added over the 21 January 1973 to 2 February 1976 time period. Results indicate, therefore, that image interpretation of Landsat transparencies can be used to monitor dredge spoil placement, a capability which is enhanced by the high reflectance of the spoil material.

Surface water circulation.--The Landsat band 5 images readily reveal the variations in suspended sediment concentration in the nearshore coastal waters of the Gulf of Mexico. Using this turbidity as a natural tracer, the nearshore surface-water circulation off the tidal inlet of Aransas Pass was initially examined for fourteen scenes from 1972 through

Table 19

## LANDSAT IMAGES USED IN DREDGE SPOIL STUDY

Date	Image I.D. No.	Band
21 Jan. 1973	1182-16315	5,7
14 June 1973	1326-16315	7
29 Mar. 1974	1614-16263	7
2 Aug. 1974	1740-16225	7
7 Sept. 1974	1776-16212	7
25 Feb. 1975	2034-16202	5,7
24 Mar. 1975	1974-16135	7
10 July 1975	5082-16080	5,7
17 Oct. 1975	2268-16184	7
2 Feb. 1976	2376-16172	5,7

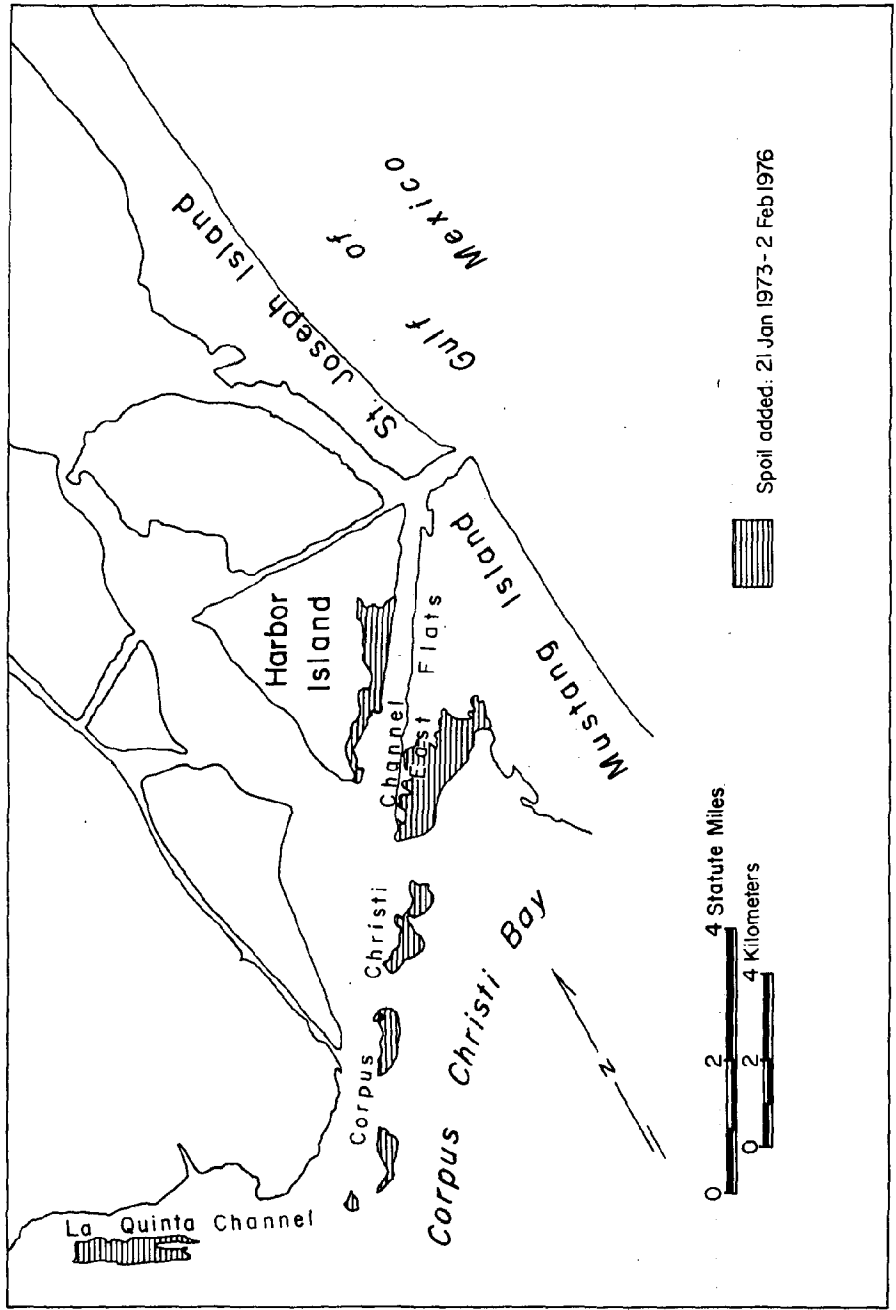

Figure 48. Summary of recent dredge spoil additions along channels in the Harbor Island test site.



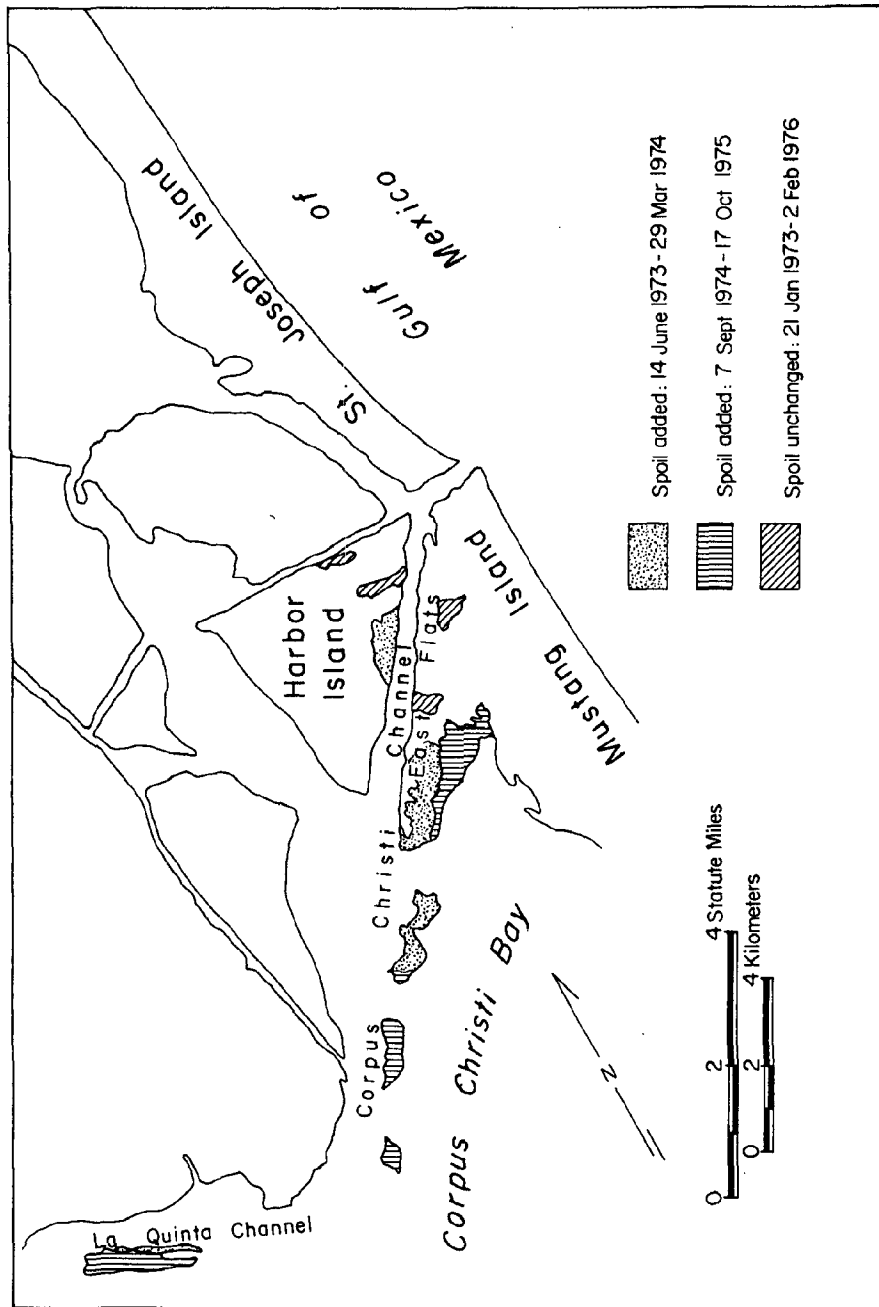

Figure 49. Sequence of dredge spoil additions in the Harbor Island area.

1976 and correlated with tide gage records, wind velocity and direction, wave observations, and predicted tidal current velocities.

Aransas Pass is a stabilized inlet with jetties extending 1.25 km seaward on either side. These structures control the observed turbid plumes by: (1) limiting expansion of ebb-tidal effluent to beyond the zone of inshore wave-generated turbidity and (2) diverting inshore turbid waters seaward to be mixed with the ebb-tidal flow. Bay-derived ebb water may be as turbid or much less turbid than inshore water, and yet in the latter case, plumes up to 3.7 mi (6.0 km) long can result from entrainment by the ebb flow of turbid, jetty-diverted inshore water. The best developed plumes of turbid inlet effluent form clockwise gyres up to 5.0 mi (8.1 km) long and correlate with the greatest tidal elevation drops (0.64 m) and effective (Price, 1975) (over 12 mph or 19.3 km/hr) northerly winds. During times of weak or flood currents and low wind velocities only small patches of slight turbidity were observed in the Gulf.

These results indicate that Landsat imagery offers a synoptic overview from which the circulation of inlet effluent and jetty-diverted inshore waters can be inferred for an area rarely covered by aerial photography. Such data can supplement as well as aid in the planning of environmental impact studies at sites of hydrocarbon production and transportation.

Change detection.--Radiance changes within test site 4, as effected by time, were studied by overlaying different dates of band 7 positive and negative transparencies at a scale of 1:125,000 (fig. 30). Two grades of change were distinguished: distinct and less distinct. The difference between these was qualitative. If the area was difficult to

outline and/or lighter than the surrounding area, it was considered less distinct (fig. 50). Changes considered questionable, and not mapped, included margins of one side of a tailings pond and of Port Bay. It is doubtful that either one changed in size; the change in radiance was probably a result of the poor fit of the two images. Other changes were judged questionable after looking at color-infrared aerial photographs of the area at a scale of 1:30,000 and finding no clear physical boundary or difference in vegetation between the area of changed radiance and its surroundings.

Comparison between 25 February 1975 (scene 2034-16202) and 10 July 1975 (scene 5082-16080) images, and between 2 February 1976 (scene 2376-16172) and 10 July 1975 images revealed that radiance changes were not simple mimics of boundaries between cropland and rangeland areas, although some areas were well-defined by turnrows and other field boundaries. In February scenes some areas of cropland were found with radiance levels which ranged from the levels equal to rangeland (relatively high) to low and intermediate levels. Generally, the lowest levels in croplands were interpreted to be barren, possibly wet, muddy fields, while the highest radiance levels were interpreted to be fields with some crops present. Intermediate levels were interpreted as damp substrate or younger, less dense crops.

The 10 July 1975 image showed a broad range of radiance levels. Most areas had well-defined boundaries. One area which was not outlined by obvious field boundaries corresponded to a natural drainage pattern within the fields. This was discovered upon examination of color-infrared aerial photography at a scale of 1:120,000.

Field checking at the test site area on 17-29 July 1976 showed

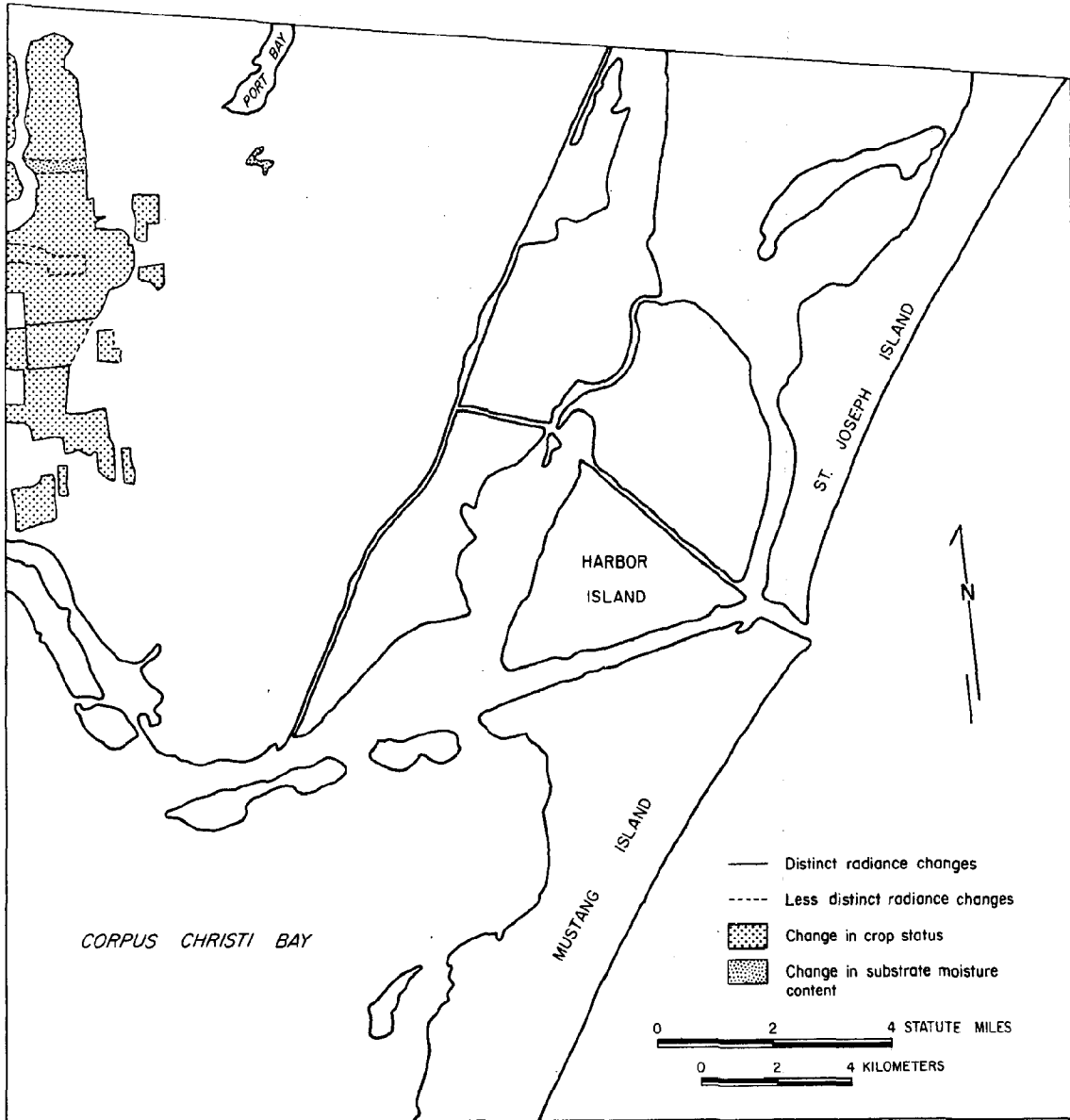

Figure 50. Radiance changes detected between February and July scenes in the Harbor Island test site.

variation in the annual cycle of crop conditions as the cause of the broad range of radiance levels. Grain sorghum and grassy pastures covered most of the cropland. The grain sorghum fields were in various stages from pre-harvest ripeness to post-harvest stubble and post-harvest plowed ground. Undergrowth of weeds in the furrows between rows of sorghum was seen in some fields. Some fields were overgrown with weeds, the sorghum not harvested. All these conditions could contribute to the variation in radiance levels on Landsat imagery.

Variations in radiance levels in areas cleared of trees and along margins of water bodies and marshes were also easily detected. The reason for radiance changes where trees have been removed and undergrowth exposed is clear. Radiance changes along the margins of water bodies and marshes are probably due to changes in water levels in these areas. In spoil areas, tidal flats, and the interior of marshes, radiance changes generally were not observed.

Aerial photography at scales of 1:30,000 and 1:120,000 (NASA Missions 300 and 325) was used to evaluate the changes detected on the imagery. The smaller scale photography was used primarily because it provided adequate detail for the confirmation of radiance changes, and because difficulty was encountered in locating on the larger scale photography the corresponding area on the 1:125,000-scale Landsat enlargement. Too much time was expended trying to adjust distances from one scale to the other.

Initial interpretations of Landsat radiance changes were usually confirmed by the aerial photography. The photography was most useful for clarification of low-radiance natural drainage patterns within croplands which did not follow field boundaries.

The fact that the Landsat enlargements were not all precisely registered to the same map scale resulted in variations in fit between images. This variation was compensated for by adjusting the image registration as each area of the test site was examined. While precise fit of images was not a problem for examining changes of large areas such as the agricultural fields in figure 50, more detailed investigations of radiance changes (e.g., identification of specific cropland acreage), would require that an investigator have aerial photo coverage available.

## 7.0 EVALUATION OF CLASSIFICATION ACCURACY FOR IMAGE-INTERPRETATION AND COMPUTER MAP PRODUCTS

### 7.1 Accuracy of Image Interpretation

#### 7.1.1 Procedures

To evaluate the classification accuracy of Landsat-based test site mapping, a comparison was made with aerial photography. A stratified random sample (Berry and Baker, 1968; Wood, 1955) of points within the land area of each map was obtained by using a random number table and a 1 x 1 inch grid with one-tenth inch subdivisions. This corresponds to a 2 x 2 mile (3.2 x 3.2 km) spacing at the map scale for the major divisions. Two points were randomly selected from within the 4 mi<sup>2</sup> (10.24 km<sup>2</sup>) area represented by each block.

NASA aircraft photography (Missions 300 and 325), dating from February and October 1975, supplemented by the Environmental Geologic Atlas of the Texas Coastal Zone (Brown, project coordinator, in progress), was used to interpret land cover and land use for the selected locations. Each location was considered to represent a circle 3 pixels (0.24 km) in diameter on the ground. The network of points was selected for each map by placing a transparent print of the line boundary map on the

point grid and transferring all locations. For those points falling near boundaries, that part of the circle which extended into another unit was ignored.

The analysis was done by an interpreter who had not been involved in classification of the Landsat data. Both color and color-infrared films were utilized, as were facilities for stereoscopic viewing.

#### 7.1.2 Image-Interpretation Accuracy Results for All Four Test Sites

The accuracy determinations for each scene are included in appendix I. Table 20 summarizes the results, by category, for all seven maps completed during this investigation. Since the combined information content of the aerial photography and the published maps exceeds that of the Landsat imagery, these data were considered valid sources of ground truth. Points which could not be classified as to land cover and land use after examination of 1:30,000 aerial photography were termed questionable. No field checking of these locations was attempted; therefore this analysis represents only a comparison of Landsat imagery with medium-altitude photography. An analysis of unit boundaries or total unit areas was not made; hence these results differ from the comparisons of photography and Landsat imagery made by Fitzpatrick (1975).

Taking all scenes together (table 20), a mean level of 87.4 percent accuracy was achieved for the 806 points checked if one-half of the questionable points could later be determined correct by study of additional information. This compares favorably with the 85 percent minimum level of interpretation accuracy suggested by J.R. Anderson (1976) as a criterion for evaluating land cover and land use classification systems. Results of evaluating the first scene mapped for each of the four test sites (table 21) yield an accuracy of 90.0 percent,

Table 20

RESULTS OF ACCURACY TESTS BY STRATIFIED RANDOM SAMPLING; ALL IMAGES FOR ALL TEST SITES

Land Cover and Land Use Classification	Points Inspected		Accuracy (percent)			
	Number Correct	Number Incorrect	Number Questionable	All the Questionables		Half the
				Correct	Incorrect	Questionables Correct
U	15	2	3	90.0	75.0	82.5
Uf	10	1	1	91.7	83.3	87.5
Ut	20	0	0	100.0	100.0	100.0
A	95	7	0	93.1	93.1	93.1
G	287	23	3	92.7	91.7	92.2
Gd	4	0	0	100.0	100.0	100.0
Gb	21	2	0	91.3	91.3	91.3
Gbr	3	0	2	100.0	60.0	80.0
W0	37	2	9	95.8	77.1	86.4
W1m	44	7	2	87.0	83.0	85.0
W1m	23	5	1	82.8	79.3	81.1
W1f	34	9	8	82.4	66.7	74.6
Wga	50	1	1	98.1	96.2	97.2
W5	7	0	0	100.0	100.0	100.0
B	11	2	2	86.7	73.3	80.0
Bds	13	1	1	93.3	86.7	90.0
Bu	23	12	2	67.6	62.2	64.9
Subtotals	697	74	35	91.3	83.5	87.4
Total	806			92.7	83.3	87.5
						Mean
						Median



Table 21

## RESULTS OF ACCURACY TEST BY STRATIFIED RANDOM SAMPLING; FIRST IMAGES MAPPED FOR ALL TEST SITES

Land Cover and Land Use Classification	Points Inspected		Accuracy (percent)			
	Number Correct	Number Incorrect	Number Questionable	All the Questionables Correct	All the Questionables Incorrect	Half the Questionables Correct
U	7	2	1	80.0	70.0	75.0
Uf	5	0	1	100.0	83.0	92.0
Ut	11	0	0	100.0	100.0	100.0
A	55	2	0	96.5	96.5	96.5
G	179	17	3	91.5	89.9	90.7
Gd	3	0	0	100.0	100.0	100.0
Gb	12	0	0	100.0	100.0	100.0
Gbr	1	0	0	100.0	100.0	100.0
WO	16	0	6	100.0	72.7	86.4
Wlm	35	2	1	94.7	92.1	93.4
Whm	18	3	1	86.4	81.8	89.1
Wtf	24	4	2	86.7	80.0	83.3
Wga	26	0	0	100.0	100.0	100.0
Wsa	5	0	0	100.0	100.0	100.0
B	8	2	0	80.0	80.0	80.0
Bds	6	1	1	87.6	75.0	81.3
Bu	19	9	2	70.0	63.3	66.7
Subtotal	430	42	18	92.5	87.3	90.0
Total	490			96.5	89.9	92.0

indicating that a learning effect was not taking place as a test site was mapped repetitively.

Among the categories (table 20) with the lowest accuracy were undifferentiated barren land (Bu, 64.9 percent) and tidal flats (Wtf, 74.6 percent). Within test site 4, one-third of the undifferentiated barren areas termed incorrect and questionable could be identified as urban areas on the photography. When industrial areas, dredge spoil, and other barren areas lacked distinguishing characteristics, they were placed in the undifferentiated barren category; therefore, the low accuracy was not entirely unexpected. High reflectance common to many of these types of land use contributes to this confusion. Accuracy of tidal flats was influenced by gradational boundaries with submergent sea grass and areas of algal mat; differentiation of these environments can be difficult, especially at higher water levels.

Categories with large samples and for which excellent results were achieved were cropland (93.1 percent accurate) and grass/rangeland (92.2 percent accurate). Wetlands other than tidal flats were delineated at accuracies exceeding 80 percent. The 85.0 percent value for topographically low marsh is a reasonable result considering the species diversity present and the occasionally indistinct marsh boundaries.

#### 7.1.3 Summary of Image-Interpretation Accuracy for Test Site 4, Harbor Island Area

Results of the accuracy analysis for image interpretation products developed for the test and evaluation phase are shown in table 22. Taking all three scenes together, a mean accuracy of 84.0 percent was indicated, assuming one-half of the questionable points are considered correct. While range-pasture land was most accurately mapped (97.1 percent), un-

Table 22

ACCURACY ANALYSIS OF LANDSAT IMAGE-INTERPRETATION  
MAP PRODUCTS, HARBOR ISLAND TEST SITE

Scene	Number of Points Checked			Accuracy*
	Correct	Questionable	Incorrect	
25 Feb. 1975 (2034-16202)	74	11	8	85.5%
10 July 1975 (5082-16080)	69	7	10	84.30%
2 Feb. 1976 (2376-16172)	59	10	9	82.1%

\*Percentage accuracy computed by assuming that one-half of the questionable points would ultimately be considered correct, which will be the computation method used unless otherwise stated.

differentiated barren areas and tidal flats were least accurately delineated (60.0 and 62.5 percent, respectively). One-third of the undifferentiated barren areas termed incorrect and questionable could be correctly identified as urban areas on the photography. High reflectance common to both categories contributes to this confusion. Tidal flats possess gradational boundaries with submergent seagrasses and areas of algal mat, and hence can be difficult to delineate, especially at higher water levels. Figure 51 summarizes the interpretation accuracy for all categories in the Harbor Island test site.

## 7.2 Accuracy of Computer Classification

### 7.2.1 Introduction

A comparison of image-interpretation results with those obtained from the computer classification was desirable for evaluating the accuracy of reliability of the two approaches in determining land use

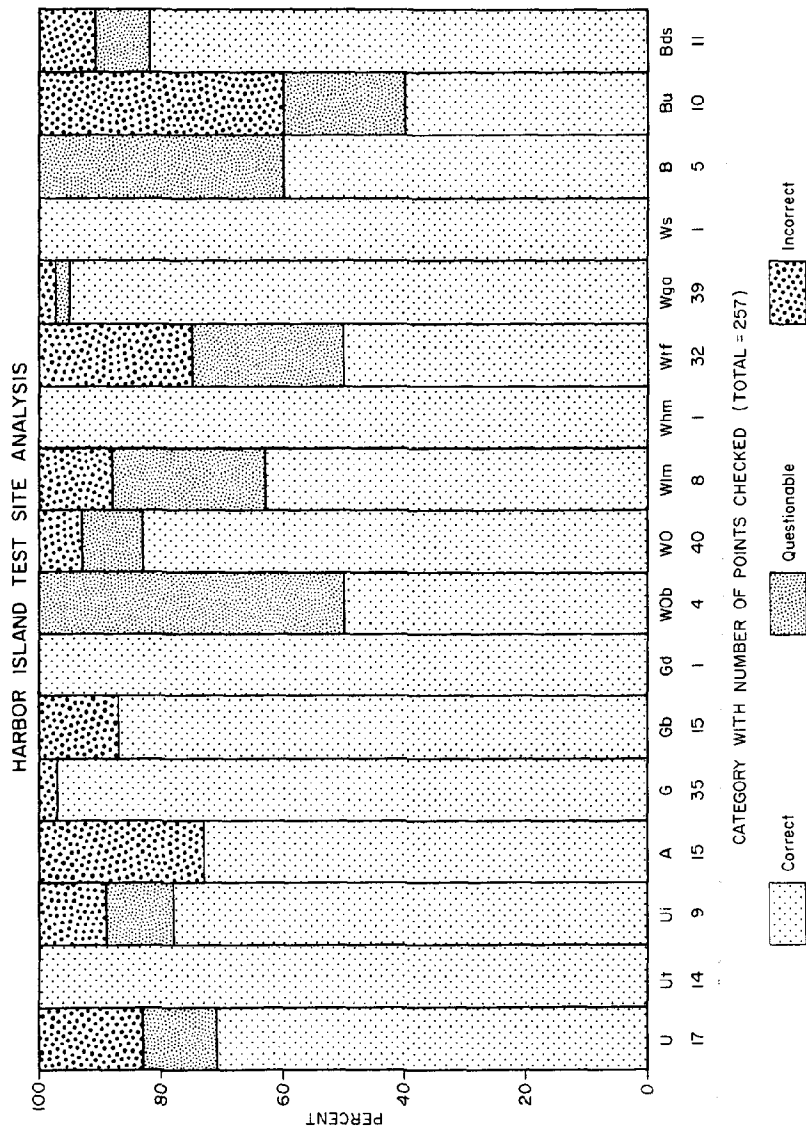

Figure 51. Summary of interpretation accuracy for all categories in the Harbor Island area test site.

patterns. The fundamental assumption was that results from image interpretation depict actual use patterns better than the computer classification. This assumption follows directly from the fact that the classification obtained from the computer is based solely on the spectral or color characteristics of a terrain cell. The interpreter, on the other hand, has not only the spectral differences to evaluate, but also those of texture, size, shape, and relationship with other scene elements. The interpreter also makes decisions based on a mental aggregation or model of scene elements over large areas, while the computer classification takes a single element at a time. The accuracy of either approach is predicated on the measurement of scene differences by the imaging system. That is, the spectral and spatial resolution of the sensor regulates the amount of information which is ultimately available for interpretation.

A representative study reported by Alexander and others (1975) has compared interpreted land use accuracies of high-altitude aerial photography enlarged to a scale of 1:250,000 to that obtained from Landsat data at a similar scale. Results of that study demonstrated that land cover and land use interpretation from Landsat compared quite favorably with those from photography, with average points correctly interpreted 70 percent and 73 percent of the time when compared with low-altitude photography and ground observations. Comparing Landsat interpretation with that from high-altitude aerial photography in this study also demonstrated similar degrees of correlation between the two sources. Other authors also have conducted comparative land cover and land use analyses using computer classification of Landsat data (Rogers and others, 1974; Smedes and others, 1975; Erickson, 1975; and Carter and Jackson,

1976). In each of these studies a scheme based on that developed by Anderson provided the land use categories used for classification and comparison. A strong correlation was shown to exist between interpreted and calculated results, with a favorable comparison between the two renditions occurring from 60 to 80 percent of the time. The greatest discrepancy consistently occurred in the urban category, which is of a heterogeneous nature. It is composed of several classes which include water, vegetation, and barren terrain. Water was generally the most easily recognized category.

It may be concluded from these studies that Landsat images do measure land use patterns with some degree of preciseness and that although there are some resolution constraints, the information desired is depicted in the scene at some level of detail.

#### 7.2.2 Comparison Procedure for Computer Classification

This section describes the method used for comparison of computer-classification results with those of image interpretation. Essentially the same sampling approach was used for computer classification as for image interpretation (section 7.1.1). There were two major problems in comparing the two classification products. The computer-classification map had been scaled and registered to a 1:24,000 USGS topographic map, using a modification of the DAM package (Schlosser and Brown, 1976). On the other hand, the image-interpretation results were still in a format that contained the distortion from the original Landsat scene. For convenience during comparison, the interpretation results were enlarged to a scale of about 1:24,000. The non-linearity in the relative position of the data was not resolved, and consequently there was good correspondence between interpreted and calculated point

positions only on a local basis.

To compare the two maps, the image-interpretation results that had been enlarged onto an acetate sheet were registered visually with the computer classification printout. The registration or fit between these two different forms of output was adjusted locally, and the sample locations selected for the stratified random sample of image-interpretation results were then compared with the computer results. In addition, there was not a precise relationship between computer classes and those classes resulting from the image interpretation. That is, one computer class could not be exactly related to an interpretation class. Interpreted classes might consist of mixtures of computer classes which were spectrally derived.

Landsat spectral signatures are more closely related to physical differences or strict land cover in the terrain than to actual land uses. Once physical characteristics of an area have been delineated by computer classification, then interpretation of those features in terms of cultural modification can be made. An urban scene, for example, is an aggregation of upland vegetation and barren areas, and an interpretation step would be necessary for precise categorization. This step was beyond the capability of the classification software available for this study, and was the basic difference which distinguishes computer classes from interpreted classes.

In order to obtain a quantitative comparison between interpreted classes and computer-generated classes, a scheme was devised to obtain the one-to-one relationship required. To overcome the inconsistencies introduced by slight misregistration of the two data sources, the classification of the four pixels closest to the point located on the enlarged

interpretation map were identified. If an "average" classification could be obtained, a one-to-one relationship could be established for comparison purposes.

To obtain this one-to-one relationship, each computer-generated pixel was associated with an interpretation class. First, the four pixels representing one or more computer classes were identified that were closest to each random point. These pixels then were associated in a matrix form with the interpretation class represented by that point.

When the number of times a particular computer class was associated with an image-interpretation class was totaled, a pattern emerged. Certain computer classes were associated more often with particular image-interpretation classes. An example depicting this relationship is shown in table 23.

An average association could thus be determined for a one-to-one relationship (more or less) between the random image-interpretation classification scheme and the computer classification scheme.

Correspondence of the computer classification product to the image-interpretation map was determined by a weighted relationship. The four computer-classification results obtained for a single interpretation were weighted by their occurrence with a particular interpretation class as depicted in the evaluation matrix. The weighted sum was calculated, and the image-interpretation class for which the sum was greatest was used as the computer classification result of all four pixels. This result was compared with that from the image-interpretation map. When the derived computer-classification result agreed with the interpreted result, a correct classification was counted; when the two results did not agree, then an incorrect classification was counted. When this procedure had been completed for all random sample points, the classification accuracy was



Table 23

COMPUTER AND IMAGE-INTERPRETATION CLASS CORRELATION, 25 FEB. 1975\*

	U Urban	A Agric.	G Grass	Wo Woods	Wa Water	W Wetland	B Barren
'	5	0	2	0	0	4	<u>17</u>
/	21	0	<u>45</u>	25	0	2	7
]	<u>14</u>	0	6	5	0	2	9
=	2	0	0	<u>5</u>	0	3	3
Δ	13	0	0	0	0	<u>19</u>	0
&	2	0	<u>16</u>	<u>16</u>	0	3	4
%	0	0	0	0	0	<u>22</u>	0
>	3	0	0	1	0	<u>34</u>	0
#	1	<u>8</u>	0	0	0	6	0
A	6	0	0	0	0	<u>18</u>	0

\*For explanation of class symbols check tables 7 and 8 (section 4.0). Underlined numbers represent intersections where "identical" image interpretation and computer classes converge. The horizontal axis represents image interpretation, and the vertical axis represents computer classes.

evaluated.

Table 24 displays results of this evaluation for the 25 February 1975 scene. The resulting classification accuracy for this scene was determined to be 60 percent, where 52 points were correctly classified out of 87 total points.

Several observations were made during the preparation of these accuracy data. It was noted that the land use comparison included only those areas which were principally land. Most water points were intentionally excluded because ground truth was not available to verify water turbidity. Even so, the computer appeared to have a high classification accuracy in identifying water areas. The data results indicated the occurrence of typical water classes in those areas designated as wetlands and urban transportation. In analyzing these data, it was determined that the urban transportation class included the Gulf Intra-coastal Waterway and other navigation channels, which the computer classified as water. Portions of the wetlands also may have been inundated at the time the Landsat data was acquired. These inundated areas would consequently be classified as water. This inexact relationship between the computer and image-interpretation classes would have lowered, by a few percentage points, the overall accuracy of the computer classification for this scene.

Another disparity which was noted was the confusion between woodland and grassland classes. The 25 February 1975 scene was acquired during a time when much of the vegetation in site 4 was dormant. Consequently there was likely to be some spectral similarity between grassland and woodlands. It should be observed that the distinction between woodlands and grasslands has been based primarily on some ratio of trees to

Table 24

COMPUTER CLASSIFICATION ACCURACY FROM COMPARISON  
WITH IMAGE INTERPRETATION, 25 FEB. 1975\*

	U	A	G	WO	WA	W	B
U	<u>2</u>	0	0	0	0	0	2
A	0	<u>2</u>	0	0	0	0	0
G	6	0	<u>17</u>	9	0	1	2
WO	1	1	1	<u>3</u>	0	1	1
WA	0	0	0	0	<u>0</u>	0	0
W	6	0	0	0	0	<u>25</u>	0
B	1	0	1	0	0	+2	<u>3</u>

$$\underline{52} \div 87 = 60\%$$

\*For explanation of class symbols check tables 7 and 8 (section 4.0). Underlined numbers represent intersections where "identical" image interpretation and computer classes converged. The horizontal axis represents image interpretation, and the vertical axis represents computer classes.

grass. Dense woodland would be spectrally separable from pure grassland areas. However, where there is a mixture of these two classes, an aggregation of scene elements is necessary to make a distinction.

In order to better establish an upper bound on classification accuracy, these factors were considered and a new relationship determined between computer and image-interpretation classes. Water classes falling under urban transportation and wetlands were aggregated as water, and the woodlands and grasslands categories were lumped into a single general class called uplands vegetation (Up). Although this redefinition was somewhat subjective, it provides some idea of what accuracies can be expected in a more refined system. Table 25 illustrates the results of this data realignment by which a classification accuracy of 72 percent was obtained.

It was also observed that the lowest classification accuracy was for the urban class, which tends to be a geographical mixture of barren, grasslands, and woodlands categories. Consequently, classification accuracy in a point-by-point comparison suffers where interpretation with a wider perspective might agree favorably. In several previously reported studies, this low accuracy for the urban category was also apparent.

Data from each of the other scenes analyzed for accuracy comparisons are provided in tabular form similar to that shown for the 25 February 1975 scene. These data are found in appendix J and are summarized in table 26.

Table 25

REALIGNMENT OF CLASSES INTO URBAN (U), AGRICULTURE (A),  
 UPLAND VEGETATION (Up), WATER (WA), WETLANDS (W), AND  
 BARREN (B), 25 FEB. 1975

	U	A	Up	WA	W	B
U	<u>2</u>	0	0	0	0	2
A	0	<u>2</u>	0	0	0	0
Up	7	1	<u>30</u>	0	1	2
WA	0	0	0	<u>10</u>	0	0
W	0	0	0	0	<u>21</u>	0
B	1	0	1	0	2	<u>3</u>

$$\underline{\underline{68}} \div 94 = 72\%$$

Table 26

SUMMARY OF ACCURACY ANALYSIS OF LANDSAT COMPUTER-GENERATED  
MAP PRODUCTS, HARBOR ISLAND TEST SITE

<u>Scene</u>	<u>Number of Points Checked</u>	<u>Number of Points Which Correlated to Image Interpretation*</u>	<u>Correlation Accuracy</u>	<u>Accuracy with Vegetation Classes Combined</u>
25 February 1975 (2034-16202)	87	52	60%	72%
10 July 1975 (5082-16080)	89	54	69%	85%
2 February 1976 (2376-16172)	<u>74</u>	<u>48</u>	<u>62%</u>	<u>74%</u>
TOTAL	250	154	62%	74%

\*Sample points on the image interpretation overlay had been annotated for the interpretation from aerial photography if this differed from the interpretation derived from Landsat imagery. The computer classification was counted correct if the computer class matched the interpretation from aerial photography.

### 7.2.3 Correlation Sampling for Determining Computer-Classification Accuracy

A second series of analyses were conducted to compare interpreted results with those obtained by computer classification. In these analyses the interpreted results were compared to the computer results using a more intensive sampling procedure. A stratified random sample grid was generated that would provide about 400 comparison points per scene, which is several times as intensive as the previous procedure. This sample of points was related to the computer-classification map on a one-to-one basis. These computer pixels (class points) were then compared to image-interpretation results on acetate overlays. Since the comparison was made to an enlarged line-boundary map with image-interpretation classes annotated for each area delineated, each computer-classified point could be related directly to an interpretation class. In this way, misregistration and errors associated with the computed relationships could be reduced.

A basic problem still exists in that the computer classes are not in themselves directly related to land use patterns, but more to the reflectance or color differences in the land cover. Thus a one-to-one correspondence must be established between the computer-derived classes and the Anderson-style land cover and land use interpretation derived from images. This correspondence was determined using a procedure whereby a correlation matrix was constructed from the comparison of the data. The correspondence between the two styles of classes was established between classes which were more significantly correlated or which most often were associated with each other.

Table 27 shows the correlation relationship between the computer

Table 27

INTENSIFIED SAMPLE CORRELATION BETWEEN IMAGE INTERPRETATION  
(HORIZONTAL AXIS) AND COMPUTER CLASSIFICATION  
(VERTICAL AXIS), 25 FEB. 1975 LANDSAT SCENE

	U	A	G	Wo	W	B	WA	
'	2	0	1	0	5	<u>17</u>	2	B
/	8	3	<u>30</u>	15	2	6	2	G
3	<u>9</u>	1	1	3	0	2	0	U
Δ	6	0	0	0	<u>13</u>	0	3	W
&	4	1	<u>15</u>	2	5	0	0	G
%	1	0	1	0	<u>8</u>	0	0	W
#	1	<u>9</u>	0	0	<u>9</u>	0	0	W/A*
=	3	1	0	0	2	0	<u>7</u>	WA
G	2	0	0	0	2	0	<u>23</u>	WA
Z	2	0	0	0	4	1	<u>19</u>	WA
A	7	0	0	0	10	0	<u>41</u>	WA
>	1	1	6	0	<u>24</u>	3	0	W

\*Counted as agriculture



and the image-interpretation classes as determined from the sample correlation. The computer classes were assigned to the interpreted classes based on the maximum occurrence of a computer class with an interpretation class. Also shown in the right-hand column of table 27 is the selection of an interpretation class for each computer class. Once the correspondence between the two classifications was established, an accuracy matrix could be developed. Table 28 illustrates this relationship. For this data an accuracy of 62 percent was determined. This is not significantly different from the accuracy determined from the previous procedure; however, the procedure is felt to have less inherent error.

As in previous comparisons, certain discrepancies are noted. The inclusion of water classes in this comparison has resulted in a more representative sample, although the errors where water is detected in urban transportation systems and inundated wetland areas are still evident. Likewise the uncertainty in grasslands versus woodlands still exists. If these errors are adjusted, and a new comparison is performed where grasslands and woodlands have been lumped, an improvement in classification accuracy occurs. These changes are depicted in table 29, where the percentage accuracy is 67 percent.

Each of the other scenes was analyzed in a similar manner and this data is shown in appendix J. A summary of the results from all those scenes is found in table 30.

#### 7.2.4 Automatic Correlation Procedures as One Method to Assign Interpretation Classes to Computer Classes

This correlation procedure could easily be automated for randomized point comparisons and could form part of an operational system using

Table 28

COMPUTER CLASSIFICATION ACCURACY FROM COMPARISON WITH  
 IMAGE INTERPRETATION USING AN INTENSIFIED SAMPLE, 25 FEB. 1975  
 LANDSAT SCENE

	U	A	G	Wo	W	B	WA
U	<u>9</u>	1	1	3	0	2	0
A	1	<u>9</u>	0	0	9	0	0
G	12	4	<u>45</u>	17	7	6	2
Wo	0	0	0	<u>0</u>	0	0	0
W	8	1	7	0	<u>45</u>	3	3
B	2	0	1	0	5	<u>17</u>	2
WA	14	1	0	0	18	1	<u>90</u>

$$215 \div 346 = 62\%$$

Table 29

REALIGNMENT OF COMPUTER CLASSES INTO URBAN (U), AGRICULTURE (A),  
 UPLAND VEGETATION (Up), WETLAND (W), BARREN (B), AND WATER (WA), USING  
 AN INTENSIFIED SAMPLE, 25 FEB. 1975  
 LANDSAT SCENE

	U	A	Up	W	B	WA
U	<u>9</u>	1	4	0	2	0
A	1	<u>9</u>	0	9	0	0
Up	12	4	<u>62</u>	7	6	2
W	8	1	7	<u>45</u>	3	3
B	2	0	1	5	<u>17</u>	2
WA	14	1	0	18	1	<u>90</u>

$$232 \div 346 = 67\%$$

Table 30

SUMMARY OF CLASSIFICATION ACCURACY FOR COMPUTER-ASSISTED  
ANALYSIS USING AN INTENSIFIED SAMPLE, HARBOR ISLAND TEST SITE

<u>Scene (ID)</u>	<u>No. of Points Checked</u>	<u>No. of Points Which Correlated</u>	<u>Correlation Accuracy</u>	<u>Accuracy with Vegetation Classes Combined</u>
25 Feb. 1975 (2034-16202)	346	215	62%	67%
10 July 1975 (5082-16080)	373	259	69%	80%
2 Feb. 1976 (2376-16172)	<u>351</u>	<u>233</u>	<u>66%</u>	<u>70%</u>
TOTAL	1071	707	66%	73%

Landsat computer compatible tapes (CCTs). The 13 computer classes were originated from 30 or more classes that had been heuristically aggregated and simplified in content from the original clusters determined from computer-assisted analysis. These aggregations essentially reduced the number of computer classes that a human analyst was required to identify on photography or with the classification scheme developed for image interpretation. In an operational system, these aggregations could be computed automatically by comparing the computer classification to points with identified Anderson-style classes or other types of cover (e.g., soils, vegetation types, etc.) rather than by the subjective correlation used in this study.

The advantages to using automatic comparison procedures would be that they would be straightforward, consistent, and possibly would preserve more information. A statistically significant set of randomized sample points located by latitude and longitude could be determined from each area to be routinely monitored. The land cover and land use class for each of these points would be determined by interpretation from available inventories, aerial photography, and field checking, and then compared to scaled and registered special classification results with the finest detail practical.

Once these associations were determined for a particular Landsat scene, the spectral classes could be aggregated into interpretation classes based on a certain standard for accuracy, and the results could then be compared with previous classifications of the scene. Other points might be used to compute the accuracy of the classification results.

Further investigation of this application might determine the best

times of the year for the delineation of certain classes, and also a reference interpretation that might be used for more accurate monitoring.

## 8.0 APPLICATION OF LANDSAT PRODUCTS TO MANAGEMENT ACTIVITIES

### 8.1 Objectives for the Test and Evaluation of Analytical Techniques in Site 4

During the period for which Landsat data were available (1973-1976), numerous projects and activities were proposed and initiated for this test site that concern the General Land Office in managing coastal public lands. Five of these activities, listed in table 31, were used to select four local areas within the Harbor Island test site for comparing classification results of the Landsat scenes (fig. 52).

These activities are examples of some recurrent issues and problems encountered in managing coastal public lands in Texas. Information needs typified by these examples were used to help formulate investigation objectives for this test site and to provide a basis for evaluating the utility of the Landsat-derived classification products in the Harbor Island area. The objectives were:

1. To define the shoreline boundaries of tidal flats, bay margins, and marshes at different tidal stages.
2. To describe the growth of spoil islands along ship channels and other disposal sites for evaluating the disturbance of wetlands and bay margins.
3. To describe the distribution of, and changes in, land cover, including wetlands, within the test site for information on future uses and potential impacts of such uses on coastal public lands.

Table 31

EXAMPLES OF MANAGEMENT ACTIVITIES AND ISSUES  
IN THE HARBOR ISLAND AREA OCCURRING BETWEEN 1973 AND 1976

<u>Area</u>	<u>Activity</u>	<u>Action Required</u>	<u>Specific Information Needed</u>
1	Oil and gas leasing in Redfish Bay	Drilling recommendations prior to lease sales	Location of sea-grass areas, existing channels, and adjacent environments for alternative drilling locations
2	Proposed site for inland deep-water port at Harbor Island	Lease of state lands for spoil deposition	Location and acreage of existing spoil, marshes and sea-grasses within proposed lease area
3	Proposed resort development on Mustang Island	Easement for access channel to marina	Location of state/private boundary (mean high tide) on tidal flat
2,4	Enlargement of Corpus Christi and LaQuinta Ship Channels	Proposed lease of additional state land for spoil deposition and turning basin	Location of existing spoil areas and wetlands
4	Potential site of regasification plant for imported liquefied natural gas (LNG)	Potential lease of state land for boat docks, piers, etc., and review and comment on permits required from other agencies	Adjacent land cover and land use conditions, especially wetlands

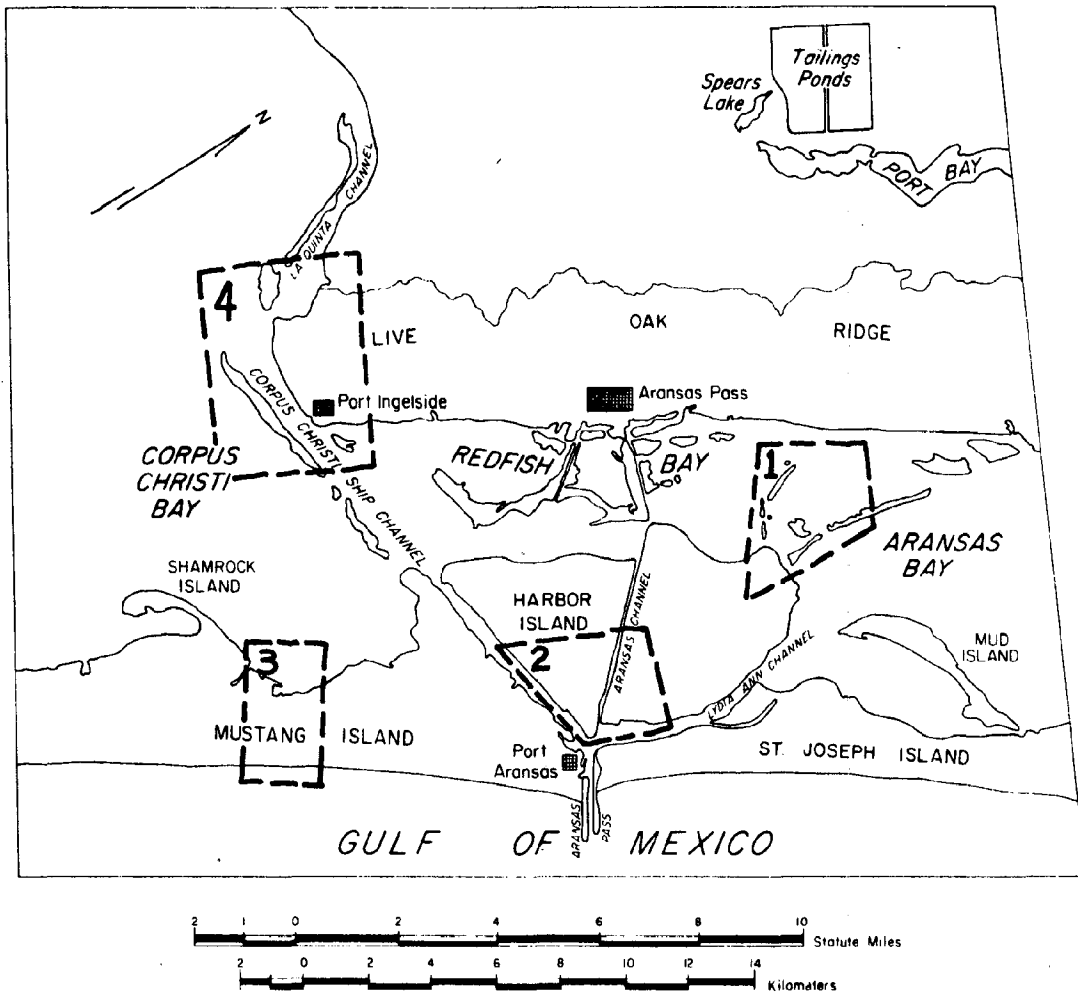

Figure 52. Location of areas within Harbor Island area for comparing classification results of Landsat scenes.



The land cover and land use classification products derived from both Landsat images and computer-compatible tapes were used as the basic information source for evaluating the usefulness of Landsat data in providing the information listed above. The land/water boundary displays, generated from the computer-compatible tapes by using the Detection and Mapping (DAM) package, also were used for locating water within tidal flats and marshes.

## 8.2 Information from Landsat Products

### 8.2.1 Inundation of Tidal Flats, Marshes, and Bay Margins

Overall results of the evaluation indicate that the use of Landsat products for detecting the distribution of inundation of tidal flats, marshes, and bay margins is satisfactory. Tide gages recorded low water levels for the 25 February 1975 and the 2 February 1976 scenes due to the passage of polar cold fronts with strong northerly winds prior to the satellite pass. Water levels were higher at the time of the 10 July 1975 scene. Effects of these water level differences, which may have been about one foot (30 cm) or more of water depth at various places, were very evident on the classification products. They were especially striking on land/water maps generated by the DAM package when used with overlays showing state ownership and USGS topographic and cultural information (fig. 53).

At low tide on the 25 February 1975 and the 2 February 1976 scenes, very shallow areas in Redfish Bay (areas 1 and 4, fig. 52) and on the bay side of Mustang Island (area 3) were classified by image interpretation as a mixture of tidal flat and seagrasses. When the winter scenes are compared to the high-tide 10 July 1975 scene, the tidal flats in these same shallow areas tended to shrink and be replaced

2/2/76

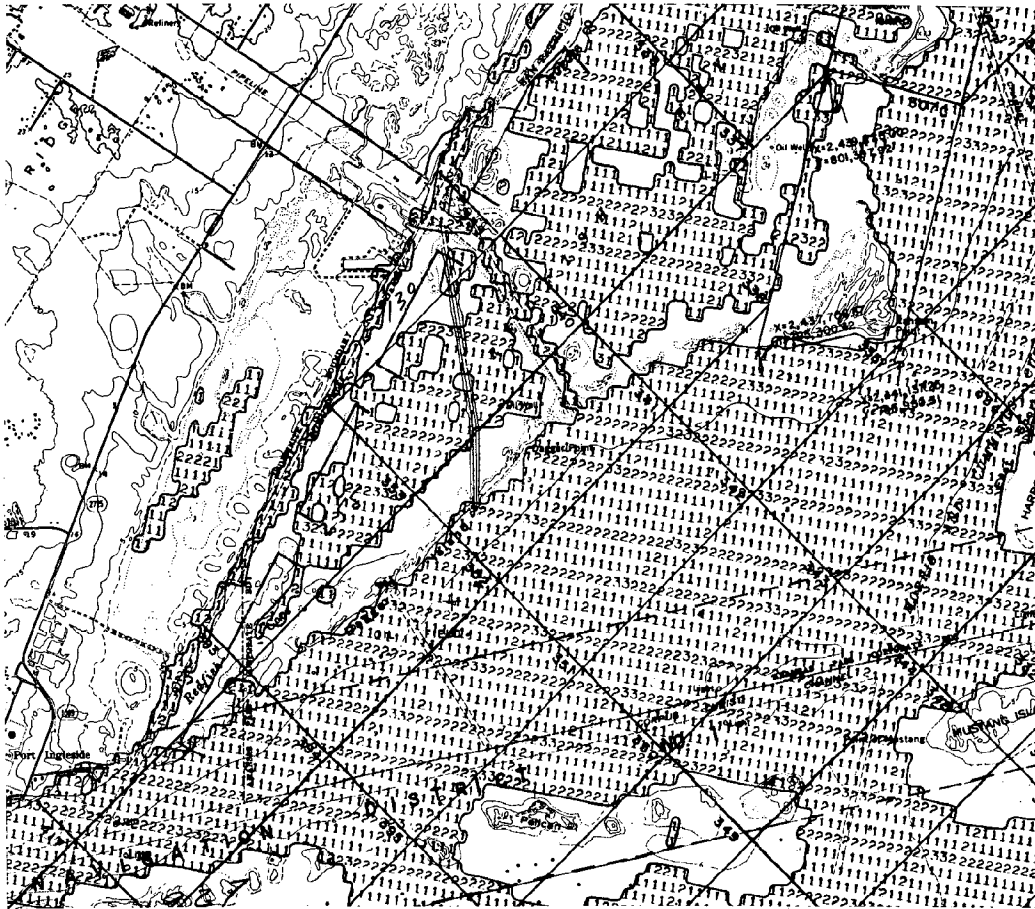

Low Tide

Figure 53. Portion of test site 4 as depicted on the Detection and Mapping (DAM) display with an overlay showing the numbered state-owned tracts and USGS topographic information.

by seagrasses and algal flats, or by water. For example, in area 3, on the back side of Mustang Island, the tidal flat area appeared to shrink from about 1 mile (1.6 km) in width to slightly more than one-half mile (0.8 km), with a seagrass and algal flat zone appearing on the bay side. In areas 1 and 4 in Redfish Bay, with the higher tide, water classes replaced tidal flats and reduced the areas classified as seagrasses.

For the study of tidal shorelines, a library of Landsat scenes correlated to known water levels could be used to supplement information gathered from visual observations and tide gage data regarding the areal extent of inundation over large areas. Such historical records of inundation are not now available for bay shorelines in Texas. Although these records could not replace ground surveys and tide gages for determining legal boundaries, they could be used to estimate shoreline boundary locations for management purposes without additional ground surveys. For example, boundary questions concerning the activities listed in table 31 for areas 2, 3, and 4 (fig. 53) could have been supported by using a Landsat computer-classification product and depicting water levels at mean high tide with a clear plastic overlay showing state-owned tracts on a USGS topographic base at 1:24,000 scale. This is a situation where the scaled and registered computer classification has a distinct advantage over the image-interpretation map, even though the overall classification accuracy of the computer-classification display might be much lower.

Although precise boundaries were not detected between land and water classes (due to the pixel size of about 1 acre), the Landsat classification products were sensitive to the effects of water-level

changes and can be used to demonstrate the general areal extent of inundation when compared to low water conditions.

#### 8.2.2 Spoil Islands

Locating and monitoring spoil areas is important since channels for navigation and commerce in Texas bays require continuous maintenance dredging. Because of the long-term commitment to maintain these channels, more and more state-owned submerged lands and wetlands adjacent to these channels will be required for use as disposal sites. In the Harbor Island area, progress in enlarging the Corpus Christi and LaQuinta Ship Channels (areas 2 and 4, fig. 52) could be documented by the growth of adjacent barren spoil island on both image-interpretation (section 6.3.4) and computer-classification products. Wetland classes in the vicinity of these channels and the proposed deep-water port (area 2) also could be located and identified well enough to locate potential sites for future spoil disposal, thereby avoiding areas containing seagrasses or marsh vegetation. It is important to recognize that information from Landsat would supplement other data sources by providing a temporal history of change from dredging and spoil disposal, as well as providing a current picture with which to review proposed projects. More detailed information on wetlands, for example, could be obtained, when needed, from sources such as existing aerial photography and the Environmental Geologic Atlas of the Texas Coastal Zone (Brown, project coordinator, in progress).

Examination of available Landsat products indicated that information for monitoring existing spoil disposal sites, and the identification of wetland types to review proposed disposal sites, were best provided by the image-interpretation products for the following reasons:

1. The 1:125,000 scale is convenient for examining large areas, such as the entire route of the ship channel.
2. Precise registration of the data to quadrangle maps is not necessary for initial review of projects.
3. Landsat standard products in Bands 5 and 7 can be readily used for detecting changes in spoil areas without more time-consuming analysis.
4. The 80 percent accuracy of the dredge spoil category inspires confidence in the use of image-interpretation products (fig. 51).

### 8.2.3 Land Cover Conditions and Changes

Qualitative evaluation of the Landsat-based map products indicated significant variation in the boundaries of certain classes. The urban class presented a problem in that the class boundaries differed on each scene for both image-interpretation and computer products. The low-density urban areas within the Harbor Island test site have a spectral response derived from a mixture of barren areas (structures, pavement, etc.), cultivated vegetation such as lawns and shrubs, and some natural vegetation. This mixture creates a spectral and textural contrast with the surrounding area which can be detected during analysis of the images. The contrast can be quite subtle along the margins of the urban areas where quality of the data, growth stage of the vegetation, and, for image interpretation, the subjective decisions of the interpreter determine boundary placement. Differences in atmospheric conditions and sun angle between winter and summer scenes also influence category delineation during image interpretation and computer classification.

The success achieved in identifying land cover conditions

and monitoring changes from Landsat data depends on the accuracy and consistency of the classification results. While consistent delineation of urban areas has not been achieved, wetlands, grasslands, and water have shown greater consistency from scene to scene and between analysis methods. For uses where the smaller 1:125,000 scale was adequate, the image-interpretation product was preferred over the computer product because a more informative classification scheme (table 7) was used, and the overall accuracy was higher (section 7.0). The computer-assisted classification product does, however, have the advantage of ensuring that no data are overlooked. For example, a small area of vegetation on a spoil island was not visually mapped from the imagery but was delineated by the computer analysis as grassland vegetation. While the image interpreter may have mapped the entire area as barren dredge spoil, the computer made a correct classification on a spectral basis by delineating a small area of grassland. Note that were larger, 1:24,000 scale data are required, the computer-assisted product can satisfy this need, whereas image-interpretation products contain too much distortion for useful enlargement.

### 8.3 Summary of Findings

1. For the study of tidal shorelines, a library of Landsat scenes would be useful to supplement visual observations and tide gage data regarding the extent of inundation over large areas. Historical records of inundation are not now available for bay shorelines in Texas. Although these records could not replace ground surveys and tide gages for determining legal boundaries, they could be used to estimate shoreline boundary locations for management purposes without additional ground surveys.

2. Monitoring spoil areas is important because navigation channels in Texas bays require continuous dredging, and more and more state-owned submerged lands and wetlands adjacent to channels will be desired for use as spoil disposal sites. Progress in enlarging the Corpus Christi and LaQuinta Ship Channels could be documented by the growth of adjacent barren spoil islands, as detected on Landsat images. In addition, wetland areas in the vicinity of these channels could also be located and identified well enough to assist in locating potential sites for future spoil disposal, thereby avoiding areas containing seagrasses or marsh vegetation.

3. For uses where the 1:125,000 scale maps were adequate, the image-interpretation product was preferred over the computer product because a more informative classification scheme was used, and the overall accuracy was higher.

4. Computer-assisted classification products do, however, have the advantage of ensuring that no data are overlooked. For example, a small area of vegetation on a spoil island was not visually mapped from the imagery but was delineated by the computer analysis as grassland vegetation using spectral data only. Such vegetated spoil islands often become important rookeries for coastal birds and are protected by the state.

5. Where 1:24,000 scale maps are required, the computer-assisted product can satisfy this need whereas image-interpretation products are not adequate.

6. In addition, the computer display is scaled and registered to USGS 7 1/2-minute topographic maps. This registered display is an advantage when used with a series of plastic overlays prepared at a

scale of 1:24,000 and showing state-owned coastal lands, because correlation with existing map data is improved.

## 9.0 ECONOMIC ANALYSIS OF LANDSAT MAP PRODUCTS

### 9.1 Overview

#### 9.1.1 Introduction

The contract between NASA and the General Land Office included the requirement for a cost-benefit study as one of the methods by which maps derived from satellite data would be evaluated. During the summer of 1975, various methods of economic evaluation were reviewed and a cost-saving approach was selected. A method for extracting cost data from the Landsat project was also developed. The review of the pros and cons of a cost-benefit study and alternative methods of evaluation can be found in the September 1975 Quarterly Report (Jones and others, 1975 a, appendix G). Appendix K describes the cost-accounting system which was used during the summer and fall of 1976 by persons doing data interpretation.

Development and evaluation of techniques for interpreting satellite data were the objectives of the Landsat Investigation, and the testing and evaluation of these techniques comprised the final phase of the investigation. During the test and evaluation phase, refined techniques of interpretation were applied to the production of land cover and land use maps for site 4, the Harbor Island site, which encompasses 200 square miles around Port Aransas and Aransas Pass, Texas. The 23 classes originally conceived as comprising the land cover and land use categories of interest are listed in table 7 (section 4.0).

Two alternative methods of producing the land cover and land use maps were investigated: computer-assisted classification of digital tapes



and classification by conventional image-interpretation techniques. Success of these techniques differed in identifying land cover and land use within site 4.

Because no extractive hydrocarbon activity was identified in site 4, this class was omitted. The image-interpretation map does identify the remaining 22 classes, while only 13 classes were identified on the computer-assisted classification map. These points are reviewed here, because the number of classes identified could be an important factor in determining not only map utility, but also interpretation time and costs.

The experience with site 4 during this investigation provided the nearest approximation to operational costs of a system for producing land cover and land use maps from Landsat data. Costs collected during this testing or simulation phase on both computer-assisted and image-interpretation techniques provided the raw data for this study. In addition to these costs, costs were estimated for maps prepared by conventional mapping methods using aerial photography, from which a hypothetical map and costs were constructed for comparison. The above costs form the core of the analysis in this study: (1) the costs of production of Landsat map products by computer-classification and image-interpretation techniques and (2) the cost-saving study which compares costs between three different types of map products.

#### 9.1.2 Costs of Production of Landsat Map Products and Demand

Figure 54 illustrates the cost components in production of computer-assisted classification and image-interpretation maps. The components or cost inputs were divided into labor, equipment, miscellaneous, office overhead, and labor costs other than interpretation. These five cost inputs were computed for three stages of production: data acquisi-

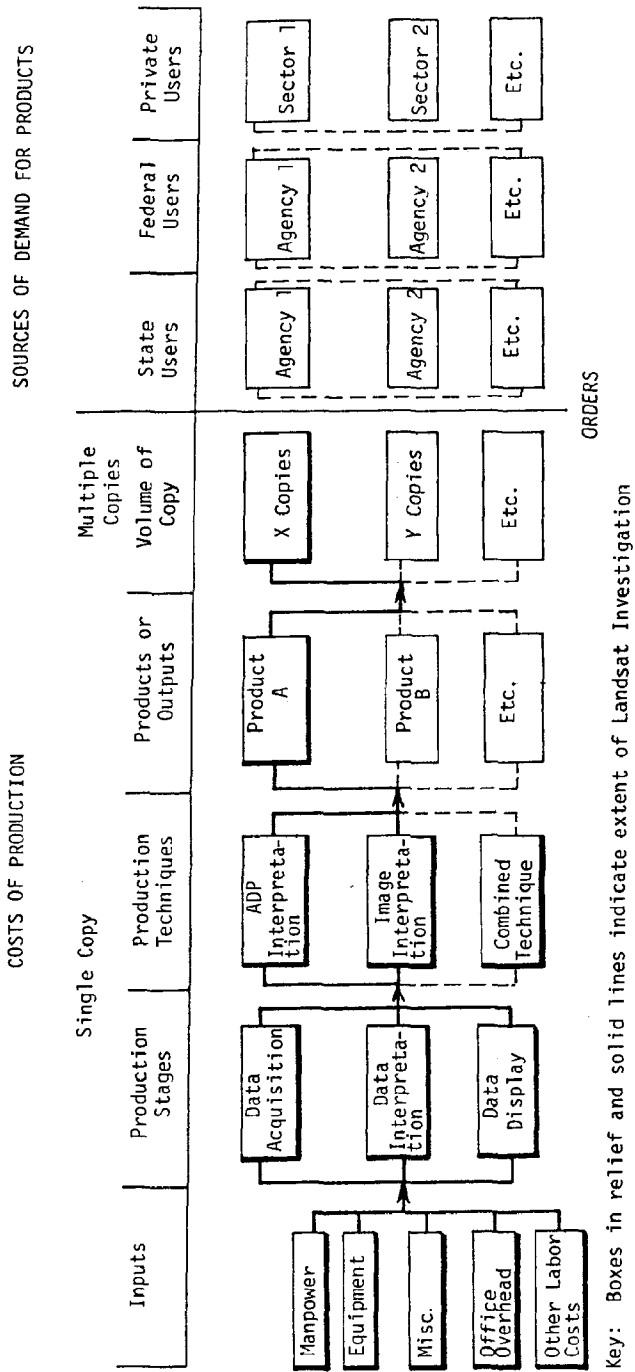

Figure 54. Scheme of production and delivery of products from a Landsat operational system illustrating components of cost and demand.

tion (the cost of obtaining imagery), data interpretation (from preliminary data analysis and field research through hand-color preparation for press), and data display (editing of hand-color copy and production of hard copy, color prints). This breakdown of costs into stages of production with cost categories was an easy way to collect costs of production and allows detailed cost comparison between computer-generated and image-interpretation maps.

A caveat is in order here: Costs cannot be the only criteria for selecting a mapping technique. The usefulness of maps to state agencies will also depend on the type of information and its quality. Quality criteria could include such dimensions as number of classes, level of detail, accuracy and consistency of interpretation, and timeliness. Timeliness of the delivery of information could be particularly important in cases where an agency desires a special study within a short period. These quality criteria must be taken into account along with costs when evaluating map products, but because a cost-saving approach was selected, only costs are considered in the economic study. Quality criteria are treated in sections 4.0-8.0 of this report.

Figure 54 highlights aspects of costs and demand in an operational system that makes use of Landsat data. Without going into detail, it can be imagined that an operational system would be characterized by regular delivery of products to known clientele. Information might be needed quarterly, yearly, or at some other time interval by a particular agency. In addition, such a system might also respond to agency requests for one-time, special studies. Two important features of such a system are the known capability to deliver specific products and knowledge of users and their numbers.

The extent of the Landsat Investigation is shown by the boxes in relief in figure 54. The scope of the investigation did not include a separate study to identify potential users or demand for a land cover and land use map. The absence of this information was one reason why a full cost-saving analysis of Landsat map products was not attempted (appendix L). Demand or volume of user results would determine the costs per square mile of information in a system with user charges. With a greater volume of users, Landsat costs per map--and therefore per square mile--would be reduced for two reasons: (1) data display costs per copy would be reduced because printing costs decline (within limits) with greater volume of copy, and (2) costs of production of the original map can be shared by more users. Thus, the greater the number of users, the less each individual user would pay per square mile of information.

This study discusses some of the relationships between costs to users and volume of maps; however, the basic costs of production of the original map were the primary focus of this study. In a government system that does not recover total costs through charges to individual users of maps, it is the cost of producing the original map that would be a principal factor in a state decision to invest in production of Landsat map products. Costs for reproducing multiple map copies would usually be recovered by government agencies through a fee charged for single copies to cover only printing costs.

### 9.1.3 Cost-Saving Study

The cost-saving methodology chosen for this project is a form of cost-benefit analysis (Jones and others, 1975a, appendix G). Unlike a more inclusive cost-benefit approach, a cost-saving study assumes that all products are of the same value to the decision-maker for the sake of

comparison only. Even though the same benefits may not accrue from maps constructed from different kinds of data or by different methods, benefits from the various kinds of maps are assumed the same to isolate differences in costs. The choice among alternatives, then, is assumed to be based on the least-cost method of mapping.

In the Landsat project, the costs of three different methods of mapping were compared: computer-assisted classification utilizing Landsat digital tapes, "visual" image interpretation utilizing Landsat imagery, and interpretation utilizing "conventional" aerial photography. None of the three map products yielded the same type of maps in terms of number of classes, level of detail, accuracy, or consistency. These are all dimensions of costs which must be taken into account by users of the products.

#### 9.1.4 Plan of the Economic Analysis

A summary of findings on the costs of different map products and the cost-saving study is given in the conclusions (section 9.5). The costs of Landsat map products, the costs of a hypothetical photo-interpretation map, and the cost-saving study form the body of this section. Appendix M contains all the data on cost inputs for map production. Appendix L is a discussion of the cost-saving methodology in an economic framework and other assumptions about the study.

### 9.2 Costs of Production of Landsat Map Products by Image-Interpretation and Computer-Classification Methods

#### 9.2.1 Record-Keeping and Estimation Methods

During the first months of the project, accounting sheets were designed to enable project participants to maintain daily records of their

work time and time of equipment usage. Although the original intention was to keep these records throughout the project, they proved impractical. Because techniques of interpretation were not fully developed in the early stages of the investigation, and because no one person had the responsibility to monitor and assist participants in completing records, it was difficult to attach meaning to the recorded times which were kept. Perhaps this only shows that research and development is an uneven process, and it is difficult to attach numbers to progress during such periods. Time records, then, were used only for site 4, during the test and evaluation stage of project work.

As previously mentioned, work on the four scenes of site 4 provided a simulation of expected interpretation times for an "operational" system; hence, costs for this work are the nearest approximation to expected costs of map production. Even during this last phase of the project, time sheets were used only when they served as invaluable aids to estimation. Time spent in data acquisition and data display was estimated by participants without the aid of time sheets. The time spent on these stages of map production was negligible compared to the time spent on data interpretation and hence was easily approximated. Time sheets were kept on data analysis for both image interpretation and computer-assisted classification. Final computer tabulation or "Fin" sheets served to track computer time. With the exception in treatment of computer time, time spent in use of special equipment such as light tables and the Zoom Transfer Scope was estimated from labor time sheets.

The tabulation of hours of analysis in each site 4 scene served as a guideline for estimating a representative time per scene. The steps of the analysis and the hours spent for each step are shown in tables 4

and 6 of appendix M. Rather than strictly adhere to an average for all four scenes, staff conducting the data analyses were asked to estimate, with the aid of time sheets, the representative or normal time for each step they would expect in an operational mode. On the whole, staff expected that they would spend less time when in an operational mode than was spent during the test and evaluation phase. Computer program run time was estimated in an analogous manner, with "Fin" sheets as the guide for the estimates. Thus, the judgement was made that even in this late phase of the Landsat Investigation, not all experience could be taken as typical of an operational mode.

In computer classification, difficulties arose with scenes 1 and 2 of site 4. The computer used by TNRS underwent systems modifications, which meant some computer software had to be rewritten. Consequently, times for the analysis staff and the computer were based only on scenes 3 and 4. Given this type of experience, it seemed more flexible to average times for a step or program in some cases, and in others to ask for the staff's best estimate of expected time during an operational mode. These adjustments do not imply that time sheets served no purpose; on the contrary, they kept estimates in bounds and allowed the analysis staff to review experience with each scene and make adjustments where appropriate.

Cost estimates for data acquisition, data interpretation, and data display for image-interpretation and computer-classification maps are discussed below. Tables exhibiting estimated costs, with considerable detail about assumptions, serve as guides for the discussion. Depending upon how costs are allocated, cost estimates vary. A variety of estimates are displayed for total costs, with low and high estimates as well as an

estimate which parallels the Landsat Investigation. The meaning of these estimates will become more clear with examination of the data.

### 9.2.2 Data Acquisition Costs

Table 32 tabulates data acquisition costs for both image-interpretation and computer-classification maps. In this estimate, labor, equipment, and material costs were based on the data ordered for site 4: four Landsat scenes, including imagery and digital tapes for computer classification and image interpretation. These costs were disaggregated in order to estimate costs of separate orders for each type of map.

Labor and equipment costs were treated as a constant cost per site, so that these costs do not vary if one or four scenes are ordered for either type map. These costs were then allocated among scenes to obtain costs per scene under two assumptions: case 1 was an order of one scene, and case 2 was an order of four scenes. In case 1, labor and equipment costs per scene are one-fourth of those for case 2. In case 2, each scene, though it was of the same site, was assumed to yield essentially different information. Imagery costs are already given as costs per scene.

In order to obtain total costs per square mile, costs per scene were divided by (1) 13,248 square miles (or the number of square miles in one Landsat scene), (2) by 4,000 square miles (or the size of a typical mapping project), and (3) by 200 square miles. The first estimate assumes that one Landsat scene would be utilized for many projects and sites similar to site 4, which is only 200 square miles in area. Whether the data is for the computer classification or image interpretation, costs of data acquisition per square mile are extremely low if the data is used for large areas (table 32).

The above estimates treat labor and equipment costs as fixed per



Table 32

COST COMPUTATIONS FOR DATA ACQUISITION TO SUPPORT  
INTERPRETATION AND COMPUTER CLASSIFICATION

1. Labor Costs:<sup>1</sup>

	<u>Costs Per Scene</u>
a. Engineering Technician IV, Group 14 @ \$8.55 per hour for 6.5 hours	\$ 55.58
b. Research Scientist Associate IV @ \$10.71 per hour for 2.0 hours	21.42
c. Clerk Typist II, Group IV <sup>2</sup> @ \$4.47 per hour for .85 hours	<u>3.80</u>
Total:	
Case 1. Order of one scene	\$ 80.80
Case 2. Order of four scenes	\$ 20.20

2. Equipment Costs:<sup>3</sup>

a. Keyboard printer terminal @ \$ .43 per hour for .5 hours	\$ .22
b. Recordak unit @ \$ .91 per hour for .5 hours	.46
c. Richards light table (Model GPL 3040) @ \$ .27 per hour for .5 hours	<u>.14</u>
Total:	
Case 1. Order of one scene	\$ .82
Case 2. Order of four scenes	\$ .21

3. Miscellaneous Costs:<sup>4</sup>

a. Cost of imagery for image interpretation	\$124.00
b. Cost of imagery and digital tapes for computer classification	\$205.00

Table 32 (Con't)

DATA ACQUISITION

	<u>Area Of Scene/Cost Per Sq. Used</u>	<u>Mile</u>
4. Total Costs of Data Acquisition: <sup>5</sup>		
Image-Interpretation Map:		
Case 1. Data order consisting of one scene	(full scene)	\$ .02
Labor = \$ 80.80	(4000 mi <sup>2</sup> )	.05
Equipment = .82	( 200 mi <sup>2</sup> )	1.03
Material = <u>124.00</u>		
		\$205.62
Case 2. Data order consisting of four scenes	(full scene)	\$ .01
Labor = \$ 20.20	(4000 mi <sup>2</sup> )	.04
Equipment = .20	( 200 mi <sup>2</sup> )	.72
Material = <u>124.00</u>		
		\$144.40
Computer-Classification Map:		
Case 1. Data order consisting of one scene	(full scene)	\$ .02
Labor = \$ 80.80	(4000 mi <sup>2</sup> )	.07
Equipment = .82	( 200 mi <sup>2</sup> )	1.43
Material = <u>205.00</u>		
		\$286.62
Case 2. Data ordering consisting of four scenes	(full scene)	\$ .02
Labor = \$ 20.20	(4000 mi <sup>2</sup> )	.06
Equipment = .21	( 200 mi <sup>2</sup> )	1.13
Material = <u>205.00</u>		
		\$225.41

Table 32 (Con't)

DATA ACQUISITION

- <sup>1</sup> Remuneration per hour can be found in tables 1 and 2 and time for ordering imagery in table 7 of appendix M. Time spent by personnel of the Texas Natural Resources Information System and the General Land Office for site 4 of the Landsat project was summed under the engineering technician; time spent by personnel in the Bureau of Economic Geology, under the research scientist.
- <sup>2</sup> Secretarial assistance is computed as one-tenth of the time of the major interpreter.
- <sup>3</sup> Time in use of equipment for ordering can be found in table 15, while actual costs can be found in tables 10 and 11 of appendix M. A five-year life was used, which means the original cost of the equipment was divided by 5 to obtain a yearly cost and an hourly rate was figured by dividing yearly costs by 2078.4 hours, the number of hours in a year of working time.
- <sup>4</sup> Material costs, in this case, imagery and digital tapes, are found in table 19 of appendix M. Costs reflect rate charges at the time the data was purchased for this investigation.
- <sup>5</sup> Total costs for data acquisition were computed two ways. In case 1, an order to NASA consisted of one scene only, while in Case 2, an order consisted of four scenes. These cases hold for both image interpretation and computer classification. The labor costs for ordering data were not changed if an order was for one scene or four, if for computer compatible tapes or imagery or both. It is clear, however, that bulk orders, that is, orders consisting of many scenes, save appreciably in labor costs, as a comparison of cases 1 and 2 shows.
- <sup>6</sup> There are 13,248 square miles in one scene of Landsat imagery.

site, whether an order consists of one or four scenes of imagery for computer classification or image interpretation. Within limits, labor costs and equipment costs probably vary negligibly with the number of scenes and type of imagery ordered. Bulk orders could reduce costs per square mile for data acquisition, since only a few extra hours might be added to the order time. Such possibilities are interesting but essentially inconsequential for total costs. Data costs are small when compared to the principal task of data analysis.

### 9.2.3 Data-Interpretation Costs of Image Interpretation

Table 33 shows costs of image interpretation excluding costs of office overhead and labor costs other than interpretation. Steps in interpretation and hours of time for each step are shown in table 4 of appendix M. Note that only the first three scenes were used as the basis for estimation. Scene 4 was not completed. Two total costs estimates are given: case 1 assumes that only one scene is interpreted at a site, while case 2 assumes four scenes per site. This treatment impacts on time in the field, and therefore also labor costs and travel costs (under miscellaneous costs).

In the case of labor costs, a preliminary field trip of 8 hours (step 2 in interpretation) and a field check of the map of 16 hours (step 5 in interpretation) were assumed. This time should be viewed as time at the site, irrespective of the number of scenes interpreted. If one scene is interpreted, total field time of 24 hours is allocated to that scene. This accounts for the difference in hours between cases 1 and 2. These estimates of field time do not, however, allow for detailed checking of boundaries among all classes mapped. For the research associate and the assistant, travel costs were allocated to one scene in

Table 33

COST COMPUTATIONS FOR DATA INTERPRETATION  
OF IMAGE-INTERPRETATION MAPS

	<u>Cost Per Scene</u>
1. Labor Costs <sup>1</sup> , including field check	
a. Research Scientist Associate IV	
Case 1. @ \$10.71 per hour for 50 hours	\$535.50
Case 2. @ \$10.71 per hour for 32 hours	342.72
b. Research Scientist Assistant II	
Case 1. @ \$5.98 per hour for 81 1/2 hours	487.37
Case 2. @ \$5.98 per hour for 63 1/2 hours	379.73
c. Secretary	
Case 1. @ \$4.38 per hour for 5 hours	21.90
Case 2. @ \$4.38 per hour for 3.2 hours	<u>14.02</u>
Total: Case 1.	\$1,044.77
Case 2.	\$ 736.47
2. Equipment Costs <sup>2</sup>	
a. Zoom Transfer Scope (ZT4)	
@ \$ .48 per hour for 19 1/4 hours	\$ 9.24
b. Richards Light Table (MIM-231100)	
@ \$ .48 per hour for 6 3/4 hours	3.24
c. Richards Light Table (MIM-475100 and Scope)	
@ \$ 1.45 per hour for 1 hour	<u>\$ 1.45</u>
Total:	\$ 13.93
3. Miscellaneous Costs <sup>3</sup>	
a. Scene and scribe coat enlargement	
@ \$ 25.80	\$ 25.80
b. Drafting Costs	
@ \$ 78.01	78.01

Table 33 (Con't)

## DATA INTERPRETATION, IMAGE-INTERPRETATION MAP

	<u>Cost Per Scene</u>
c. Travel Costs	
Case 1. For one scene	\$220.00
Case 2. For one site with four scenes	<u>55.00</u>
Total: Case 1. Travel Costs	\$325.81
Case 2. Travel Costs	\$158.81
	<u>Cost Per Square Mile</u>
4. Total Costs	
a. Labor Costs, including field check	
Case 1.	\$ 5.22
Case 2.	3.68
b. Equipment Costs	
	.07
c. Travel Costs, including field check	
Case 1.	\$ 1.62
Case 2.	<u>.79</u>
Grand Total: Case 1.	\$ 6.91
Case 2.	\$ 4.54

<sup>1</sup> Staff salaries can be found in table 1 of appendix M and times in table 4 of appendix M. Case 1 of field checking assumes 24 hours of fieldwork for one scene, while case 2 assumes four scenes to a site and allots 6 hours to each scene. In effect, 18 hours are subtracted from total times for the Associate and Assistant in case 1 to obtain case 2 times.

<sup>2</sup> Equipment costs can be found in table 9 of appendix M. Total cost is divided by 2078.4 hours, the number of hours in a working year, to obtain an hourly rate. Heavy use was assumed for convenience of computation (see text).

Table 33 (Con't)

DATA INTERPRETATION, IMAGE-INTERPRETATION MAP

<sup>3</sup> Scene and scribe coat enlargement costs can be found in table 21 and drafting costs in table 22 of appendix M. Travel costs are located in table 20 of appendix M. Case 1 represents travel costs for one scene while Case 2 represents travel costs distributed over four scenes per site, assuming each scene to represent essentially different information.

case 1 and among four scenes in case 2. The two figures for total costs represent the summation for each case of one scene per site and four scenes per site.

Labor costs account for a substantial portion of data-interpretation costs. In case 1, they are 76 percent of total costs and in case 2, 81 percent. Total costs per square mile drop from \$6.91 to \$4.54, or by one-third, when field checking and travel costs are allocated over four scenes.

Finally, equipment costs in image interpretation are not substantial under the assumptions made. Throughout this study, equipment costs were given a five-year life. In most cases, this figure underestimates the useful life of the equipment or its durability. On the other hand, rapid advances in the technology of visual interpretation equipment might make this figure seem too high. Perhaps more controversial is the manner in which the hourly rate was computed: continuous use of the equipment was assumed during the working hours of the year. This probably stretches credibility for some special equipment (e.g., the Richards light table or Zoom Transfer Scope) but is suitable for use on ordinary office equipment. Rather than make individual adjustments for each piece of equipment, all were treated the same. These assumptions were made for the convenience of this study and for easy conceptualization of costs. More precise estimates were left to the discretion of the individual reader. Note that if each piece of equipment listed in table 33 were used 2 hours per day rather than 8 hours per day over a 5-year period, the cost per square mile for image interpretation would increase by 21 cents.

#### 9.2.4 Data-Interpretation Costs of Computer-Assisted Analysis

Table 34 shows the costs of computer-classification maps excluding costs of office overhead and labor costs other than for analysis. Analysis



Table 34

COST COMPUTATIONS FOR DATA INTERPRETATION OF  
COMPUTER-CLASSIFICATION MAPS

	<u>Cost Per Scene</u>
1. Labor Costs <sup>1</sup> , including field check	
a. Engineering Technician IV, Group 14	
Case 1. @ \$8.55 per hour for 111.5 hours	\$ 953.33
Case 2. @ \$8.55 per hour for 93.5 hours	799.43
b. Secretary	
Case 1. @ \$4.47 per hour for 11.2 hours	\$ 50.06
Case 2. @ \$4.47 per hour for 9.4 hours	42.02
Total: Case 1.	\$1,003.39
Case 2.	\$ 841.45
2. Equipment Costs <sup>2</sup>	
a. Keyboard printer terminal	
@ \$ .43 per hour for 14 hours	\$ 6.02
b. Computer time for one scene	
1. Operating runs	
@ \$130.00 per hour for 1.576 hours	204.88
2. Supplemental runs	
@ \$130.00 per hour for .5 hours	65.00
3. Error runs	
@ \$130.00 per hour for .25 hours	<u>32.50</u>
Total:	\$ 308.40
Operating Only:	\$ 210.90
3. Miscellaneous Costs - Travel Costs <sup>3</sup>	
Case 1. For one scene	\$ 220.00
Case 2. For four scenes	55.00

Table 34 (Con't)

## DATA INTERPRETATION, COMPUTER-CLASSIFICATION MAPS

	<u>Cost Per Square Mile</u>
4. Total Costs	
a. Labor Costs, including field check	
Case 1.	\$ 5.02
Case 2.	4.21
b. Equipment Costs	
Case 1. Operating runs on computer	1.05
Case 2. Total runs on computer	1.54
c. Travel Costs (field check)	
Case 1. Travel costs	1.10
Case 2. Travel costs	<u>.28</u>
	Totals:
	Operating Runs
	Case 1. \$ 7.17
	Case 2. \$ 5.54
	Total Runs
	Case 1. \$ 7.66
	Case 2. \$ 6.03

Labor costs are computed on the basis of scenes 3 and 4 of site 4. Staff salaries are in table 2 and staff time in table 6 of appendix M. Secretarial assistance is computed as 10 percent of analysis staff's time. Case 1 assumes 24 hours of field work for one scene and one scene per site. Case 2 allots 6 hours to each scene on the basis of four scenes per site. The time of the analysis staff for case 2 is equal to case 1 time minus 18 hours.

Table 34 (Con't)

DATA INTERPRETATION, COMPUTER-CLASSIFICATION MAPS

<sup>2</sup>Costs of a remote terminal are based on the costs of the keyboard printer terminal, although both the keyboard printer terminal (a stationary remote terminal) and the teleterm printer (a portable terminal) were used. See table 10 of appendix M for these costs. A yearly cost was computed by dividing a five-year life into cost of equipment and an hourly rate by dividing the yearly rate by 2078.4 hours, or the number of hours in a year of working time. Computer time can be found in table 14 of appendix M. TNRIS charges are \$130 per hour of computer time.

<sup>3</sup>Case 1 represents travel costs for one site, assuming only one scene per site. Case 2 represents travel costs allocated among four scenes for one site. Case 2 implies that each scene yields different information about a site.

of scenes 3 and 4 served as the basis for estimation. Times for scenes 1 and 2 were abnormally high because computer-classification programs were being modified for compatibility with conversions underway in the computer system; therefore, scenes 1 and 2 were not utilized in estimation.

Labor costs are displayed for two cases under the same type of assumptions used for image interpretation. Case 1 treats field trips as time for one scene, while case 2 allocates total time of 24 hours among four scenes. Two cases are also given for travel costs. In case 1, costs are for one scene; in case 2, costs are divided among four scenes.

Computer times are an important cost element of the computer classification. For all but scene 4, computer time included extra runs which did not yield results. These extra runs were placed into two classes, supplemental runs and error runs. Supplemental runs are those which were used to verify or support previous results or to test a program for a particular scene. These runs contrast with operational runs that allow the analysis staff to proceed to the next step. It is difficult to say whether an operational system would be plagued by the extra time represented by supplemental and error runs. The total costs using operating runs only, and total costs using all runs, resulted in both low and high cost estimates of computer time.

Staff time was not adjusted to complement these two estimates of computer time. Although it may be more appropriate to also adjust labor time to the two extremes of run time, it would entail a whole set of new estimates. In addition, labor time computed for the computer-assisted analysis is an average of labor time between these two extremes. Estimates were based on scenes 3 and 4. Scene 3 included many supplemental and error runs, while scene 4 had one error run and no supplemental runs.

Computer costs obviously make equipment costs an important component of the total costs; nevertheless, labor costs still dominate the estimates. Labor accounts for 70 percent of the total costs of \$7.17, and 76 percent of \$5.54 under cases 1 and 2, respectively, using only operating runs. With the extra runs included, labor costs drop in significance to 66 percent of total costs of \$7.66 in case 1 and 70 percent of total costs of \$6.03 in case 2.

The range of cost estimates for computer-assisted analysis of from \$5.54 to \$7.66 contrasts with a slightly lower range of estimates for image interpretation, \$4.54 to \$6.91.

#### 9.2.5 Data Display Costs

Table 35 gives various data display costs for computer-classification and image-interpretation map products. The two processes used in producing these maps are quite different. For the computer map, a technique patented by Seiscom-Delta, Inc. (Houston, Texas) is used to estimate costs for generating a color map from digital tapes. These tapes contain the final classification of an area related to the land cover and land use scheme. A photographic process with four-color screens to separate the colors from a hand-colored image-interpretation map and to yield a color-hard copy was used to estimate costs for the image-interpretation map.

The display scale chosen was 1:125,000. Display costs are shown not only for the 200-square-mile area of site 4, but also for an area of 4,000 square miles which was the map size used for the hypothetical project using aerial photography. Twenty-three classes were assumed for the cost estimates of printing the image-interpretation map. The number of colors or classes used was not a factor in pricing the map generated by the computer technique;

Table 35

COST COMPUTATIONS FOR DATA DISPLAY OF IMAGE-INTERPRETATION  
AND COMPUTER-CLASSIFICATION MAPS<sup>1</sup>

		Approximate Area in Sq. Mi.	Approximate Map Size (inches)	Number of Copies <sup>2</sup>	Total Cost of Print- ing	Cost Per Sq. Mi.	Cost Per Map <sup>3</sup>
Computer-Classification Map	(1)	200	10x10	1	\$ 560.00	\$ 2.80	\$ 560.00
	(2)	200	10x10	100	682.00	3.41	6.82
	(3)	200	10x10	2400	1,248.00	6.24	.52
	(4)	4,000	42x41	1	1,750.00	.44	1,750.00
	(5)	4,000	42x41	100	3,113.00	.78	31.13
	(6)	4,000	42x41	2500	3,859.00	.96	1.54
Image-Interpretation Map	(1)	200	10x10	1	208.00	1.04	208.00
	(2)	200	10x10	100	330.00	1.65	3.30
	(3)	200	10x10	2400	896.00	4.48	.37
	(4)	4,000	38x42	1	1,772.00	.44	1,772.00
	(5)	4,000	38x42	100	3,135.00	.78	31.35
	(6)	4,000	38x42	2500	3,981.00	1.00	1.59

<sup>1</sup>Number of classes identified is assumed to be 23. Scale of maps is 1:125,000. See table 19 in appendix M.

<sup>2</sup>One copy represents cost of set-up and one copy.

<sup>3</sup>Cost treated as a user charge cost disbursed over the number of map copies.

instead the number of data elements (or pixels) within the map area was used to figure the printing cost.

Display costs per square mile drop markedly with map size or area displayed, given the same display scale. For example, under costs for 100 copies of the computer-classification map, the cost per square mile for a display of 200 square-mile area is \$3.41, while it is only \$ .78 for the 4,000 square-mile area.

Another way of looking at display costs is in terms of the cost per copy. As the number of copies rises, the cost per copy falls with the same map size and scale. For example, the cost per computer map of a 200-square-mile area reduces from \$560.00 for one copy, to \$6.82 per copy for 100 copies, and \$ .52 per copy for 2,400 copies. It must be remembered, however, that a larger number of copies printed only increases total project cost, unless a large number of copies can be sold.

The decrease in display costs per square mile with map size and in display costs per map with volume are an important dimension of costs. The impact on total user costs with increasing volume of copies is even more important than that on display costs. The impact of volume will become clear in the discussion of total costs.

#### 9.2.6 Office Space, Equipment, and Materials

Office costs, or overhead, are not always treated in cost studies, though they are an important budgeting consideration. Table 36 gives estimates for the Landsat Investigation. Office costs per square mile are \$ .31 for image interpretation and \$ .28 for computer classification. Office costs are not a negligible consideration, although labor costs still remain dominant.

Table 36

COST COMPUTATIONS FOR OFFICE SPACE, EQUIPMENT,  
AND MATERIAL COSTS FOR IMAGE-INTERPRETATION  
AND COMPUTER-CLASSIFICATION MAPS<sup>1</sup>

<u>Image Interpretation:</u>	<u>Cost Per Square Mile<sup>2</sup></u>
1) Office Space <sup>3</sup>	
1. Housing Interpreter and Assistant	
@ \$ .0018 per hour per square foot for 81.5 hours and 300 square feet = \$44.01 per scene	\$ .22
2. Housing Secretary	
@ \$ .0018 per hour per square foot for 5 hours and 120 square feet = \$ 1.08 per scene	\$ .01
2) Office Equipment <sup>4</sup>	
1. Utilized by interpreter and assistant	
@ \$ .0957 per hour for 81.5 hours = \$7.80 per scene	\$ .04
2. Utilized by secretary	
@ \$ .0792 per hour for 5 hours = \$ .39 per scene	\$ .00
3) Office Materials <sup>5</sup>	
1. Utilized by interpreter and assistant	
@ \$ .09 per hour for 81.5 hours = \$7.34 per scene	\$ .04
2. Utilized by secretary	
@ \$ .09 per hour for 5 hours = \$ .45 per scene	<u>\$ .00</u>
Total	\$ .31



Table 36 (Con't)  
OFFICE SPACE, ETC.

<u>Computer Classification:</u>	<u>Cost Per Square Mile</u>
1) Office Space <sup>6</sup>	
1. Housing Technician	
@ \$ .0018 per hour per square foot for 111.5 hours and 150 square feet = \$30.00 per scene	\$ .15
2. Housing Secretary	
@ \$ .0018 per hour per square foot for 11.2 hours and 120 square feet = \$ 2.40 per scene	\$ .01
2) Office Equipment <sup>7</sup>	
1. Utilized by Technician	
@ \$ .0989 per hour for 111.5 hours = \$11.03 per scene	\$ .06
2. Utilized by Secretary	
@ \$ .0792 per hour for 11.2 hours = \$ .89 per scene	\$ .00
3) Office Materials <sup>8</sup>	
1. Utilized by Technician	
@ \$ .09 per hour for 111.5 hours = \$10.04 per scene	\$ .05
2. Utilized by Secretary	
@ \$ .09 per hour for 11.2 hours = \$1.01 per scene	<u>\$ .01</u>
	Total       \$ .28

Table 36 (Con't)

OFFICE SPACE, ETC.

- <sup>1</sup>Office space, equipment, and material costs are computed on the basis of data interpretation time only. For image interpretation, the number of hours used was that for the research assistant for one scene or 81.5 hours, a time which exceeded the 50 hours of time for the principal interpreter. Secretarial time was based on 5 hours (see table 33). For computer-assisted analysis, the basis for the technician's time is 111.5 hours and secretarial assistance 11.2 hours for one scene (see table 34).
- <sup>2</sup>There are 200 square miles in site 4. These costs are based on one scene per site.
- <sup>3</sup>Office dimensions can be found in table 16 of appendix M. Rental cost is figured on the basis of \$ .31 per square foot per month and 173.2 hours of working time per month. See table 18 of appendix M.
- <sup>4</sup>Office equipment costs of image interpretation are in table 16 of appendix M. A five-year life is used, with hourly costs based on 2078.4 hours of working time per year. This assumption was made for convenience of computation (section 9.2.3).
- <sup>5</sup>Office material costs can be found in table 18 of appendix M.
- <sup>6</sup>Office space for computer-assisted analysis can be found in table 13 of appendix M. Only half of the space was counted for the technician. Rental costs are figured on the basis of \$ .31 per square foot per month and 173.2 hours of working time per month. See table 18 of appendix M.
- <sup>7</sup>See table 17 in appendix M. A five-year life is used, with hourly costs based on 2078.4 hours of working time per year.
- <sup>8</sup>Cost of office materials can be found in table 18 of appendix M.

### 9.2.7 Total Costs of Map Production and the Effects of Data Display

Tables 37 and 38 show total costs of image-interpretation and computer-assisted analysis, respectively. One cost was added which has not previously been discussed. This is the cost of time spent in activities other than data analysis. Meetings, reports, and miscellaneous activities on the part of the interpreter can be expected as part of an operational system. On the basis of time sheets kept by the image interpreter, this time was calculated to be 20 percent of time spent on interpretation (table 5 of appendix M). This item is included under item 5 in tables 37 and 38.

Costs in tables 37 and 38 assume only one copy of the map. The effect of multiple copies on user costs per square mile of information is discussed below.

In table 37, the lowest cost combination for an image-interpretation map is \$5.64 per square mile, while the highest cost combination is \$8.82. Costs which approximate costs of the Landsat investigation assume four scenes per site and therefore include case 2 under data acquisition and data display, and labor time other than interpretation time. Cost for a map depicting the 200-square-mile area yield the higher \$1.04 per square mile for data display. With the remaining costs added in, costs of the Landsat investigation for image interpretation total \$6.24.

In table 38, the lowest cost combination is \$7.05 per square mile for computer-generated maps, while the highest cost combination is \$11.72. Costs which approximate the Landsat investigation for computer-assisted analysis include case 2 under data acquisition, case 2 for total runs under data interpretation, case 1 under data display, and case 2 under labor time other than interpretation time. These costs total \$9.90. The total costs for computer classification are over 50 percent higher than the computed

Table 37

TOTAL COSTS FOR IMAGE INTERPRETATION, INCLUDING OFFICE SPACE,  
EQUIPMENT AND MATERIALS, AND LABOR COSTS OTHER THAN INTERPRETATION

	<u>Cost Per Square Mile</u>
1. Data Acquisition <sup>1</sup>	
Case 1. Data order consisting of one scene	\$ .02
Case 2. Data order consisting of four scenes	.01
2. Data Interpretation <sup>2</sup> , including field check and travel	
Case 1.	\$ 6.91
Case 2.	4.54
3. Data Display <sup>3</sup>	
Case 1. Cost of set-up and one copy (10"x10")	\$ 1.04
Case 2. Cost of set-up and one copy (38"x42")	.44
4. Office Space, Equipment, and Materials <sup>4</sup>	\$ .31
5. Labor Costs Other Than Interpretation @ 20 Percent of Data Interpretation Costs <sup>5</sup> , including field and travel	
Case 1.	\$ .54
Case 2.	.34
Grand Totals:	
Lowest cost combination	\$ 5.64
Highest cost combination	\$ 8.82
Landsat investigation <sup>6</sup>	\$ 6.24

<sup>1</sup>See table 32 for assumptions.

<sup>2</sup>See table 33 for assumptions.

<sup>3</sup>See table 34 for assumptions.

<sup>4</sup>See table 36 for assumptions.

<sup>5</sup>See table 32 for interpreter's cost at 50 hours of time. This labor cost represents time spent in meetings, writing reports, etc.

<sup>6</sup>Landsat investigation includes case 2 under data acquisition, case 2 under data interpretation, case 1 under data display, case 2 under labor costs other than interpretation, and office overhead.

Table 38

TOTAL COSTS FOR COMPUTER-ASSISTED ANALYSIS, INCLUDING  
OFFICE SPACE, EQUIPMENT AND MATERIALS, AND LABOR  
COSTS OTHER THAN INTERPRETATION

	<u>Cost Per Square Mile</u>
1. Data Acquisition <sup>1</sup>	
Case 1. Data order consisting of one scene	\$ .02
Case 2. Data order consisting of four scenes	.01
2. Data Interpretation <sup>2</sup> , including field and travel	
Operating Runs	
Case 1.	\$ 7.17
Case 2.	5.54
Total Runs	
Case 1.	7.66
Case 2.	6.03
3. Data Display <sup>3</sup>	
Case 1. Cost of set-up and one copy (10"x10")	\$ 2.80
Case 2. Cost of set-up and one copy (38"x42")	.44
4. Office Space, Equipment, and Materials <sup>4</sup>	\$ .28
5. Labor Costs other than interpretation @ 20 percent of Data Interpretation Costs <sup>5</sup> , including field and travel	
Case 1.	\$ .96
Case 2.	.79
Grand Totals:	
Lowest cost combination	\$ 7.06
Highest cost combination	\$11.72
Landsat Investigation <sup>6</sup>	\$ 9.91

Table 38 (Con't)

TOTAL COSTS, COMPUTER-ASSISTED ANALYSIS

<sup>1</sup>See table 32 and section 9.2.2 for assumptions.

<sup>2</sup>See table 34 for assumptions.

<sup>3</sup>See table 35 for assumptions.

<sup>4</sup>See table 36 for assumptions.

<sup>5</sup>See table 34 for interpreter's time. Labor costs other than interpretation includes time for meetings, reports, etc.

<sup>6</sup>The Landsat investigation includes case 2 under data acquisition, case 2 under total runs for data interpretation, case 1 under data display, case 2 under labor costs other than interpretation, and office overhead.

figure for image interpretation.

Finally, the time for special reports which would accompany a mapping project are shown in table 5 of appendix M. In order to compute labor costs, it is only necessary to use the remuneration costs in table 1 or 2 of appendix M. For actual detail about these reports, see the discussion on image interpretation (section 6.0).

### 9.3 Costs of the Hypothetical Map Produced by Conventional Interpretation of Aerial Photography

#### 9.3.1 Introduction

The costs estimated for the environmental-geology map of the South Texas Project, prepared by the Bureau of Economic Geology under contract to the Texas Water Development Board, were used for constructing a hypothetical map product for cost comparison with Landsat maps. The original environmental geology map was produced by aerial photo-interpretation to display various environmental and physical features of the south central Texas region. The environmental geology map was different "in kind" and in value to users from the Landsat maps; however, it did utilize conventional mapping methods and no other mapping project was available from which to collect costs to contrast with the project maps produced from Landsat data. The hypothetical map is used in this study as an example of how cost data can be collected, analyzed and compared with other map products.

The environmental geology map was one of eight maps made of the Southern Edwards Plateau Region of Texas, an area of about 30,000 square miles. The South Texas mapping project was a comprehensive study of environmental geological processes affecting the recharge zone of the Edwards Aquifer, which supplies nearly one million people with water, from San Antonio to San Marcos. The maps of the South Texas Project include a basic environ-

mental geology map, a slope map, a physical properties map, an active process map, a biologic assemblages map, a current land use map, a man-made features map, and a mineral and energy resources map. Mapping for the project was done on USGS 1:24,000 topographic maps, using semi-controlled aerial photographic mosaic prints of the same scale and augmented by 1:40,000 stereo pairs of black-and-white aerial photographs. The project was initiated in 1972 and completed in 1975.

The Bureau of Economic Geology has a history of producing high-quality maps. This experience lends confidence to the cost estimates, for Bureau maps result from the application of skilled and well-developed mapping techniques.

Initially, the design of the cost-saving study had only one major constraint: the conventional map selected for comparison with Landsat maps had to have a classification scheme similar to the Landsat land cover and land use classification. However, when it actually became time to select a map from the many the Bureau produces, a stronger consideration prevailed. The Bureau seldom has reason to collect economic costs, and the possibility of reconstructing these costs for an existing map project became the most important consideration. The task was made easier by selecting a map which had recently been completed. The director of the South Texas project is still on the Bureau's staff, and with his aid, costs for the environmental geology map could be estimated.

The fact that the environmental geology map is different in kind and value from the Landsat maps was relatively significant. What may clearly impact on total costs of maps are the analysis costs, which will vary depending on factors such as the number of classes interpreted. Unfortunately for this study, the environmental geology map had a classification scheme



of 92 classes, which contrasts with the 12-23 classes included in the classification schemes for use with Landsat data (section 4.0). The importance of this difference will be discussed in the section on cost-saving.

Still another provision was kept in mind when constructing the hypothetical map. Some maps produced for the South Texas project were really joint products. The environmental-geology map was used as an input into several other "derivative" maps. To separate the costs of the environmental-geology map from the costs of the other maps would have added another dimension to the study. A discussion of assumptions and adjustments used to construct the hypothetical map are included in section 9.3.3.

### 9.3.2 The Questionnaire

In August 1976, a questionnaire was sent to the Bureau of Economic Geology about the costs of producing an environmental geology map. This questionnaire is shown in table 39. Questions were asked about the three stages of production: data acquisition, data interpretation, and data display. The resulting cost estimates were recognized to be less accurate than the Landsat cost estimates. Two significant costs which were not estimated for the environmental geology map were the labor costs of activity other than interpretation and the costs of office overhead. Cost estimates from the Bureau of Economic Geology (BEG) are included in appendix M.

### 9.3.3 Assumptions, Computations, and Results

Table 40 shows the costs of data acquisition, data interpretation, and data display for the hypothetical map. Those costs derived from BEG estimates were computed for the total area and then divided by 30,000 square miles to arrive at costs per square mile. All costs for the hypothetical map were computed on a current cost basis. This means that these costs reflect the methods and current costs that would be required to produce a

Table 39

SURVEY QUESTIONNAIRE ON COSTS OF AN  
ENVIRONMENTAL GEOLOGY MAP

Stage 1. Data Acquisition (cost of obtaining imagery)

--What scale and kind of photography was used or would be recommended if the project were done today?\*

--What is the current cost per square mile for this photography?\*

--What was the staff time in man-hours by staff level (University System) for ordering?

--What was the number of hours of usage of special equipment?

Stage 2. Data Interpretation (preliminary data and field research through hand-color preparation for press)

--What were the major steps (say a maximum of four) and what is a description of them in interpretation?

For each step:

--What is the staff time in man-hours by staff level for interpretation?

--What was the number of hours of usage of special equipment?

--What was the amount of travel and special transportation utilized?

--What would be current costs for travel for individuals (travel voucher and any rental, such as airplanes)?

Stage 3. Data Display (editing of hand-colored copy and production of hard copy, color display)

--What are the commercial costs of display of this product today?

--What was the staff time in man-hours by staff level for editing and ordering hard copy, color display?

General for all three stages:

For all of the special equipment, what are the manufacturing company, trade name, model number, description of use, and retail costs today of such equipment? For all staff levels, what is the range of pay (from lowest to highest step) per month today?

\*Sources: Costs of photography from Tobin Surveys of San Antonio, Texas.

Table 40

COST COMPUTATIONS ON A HYPOTHETICAL MAP BASED ON INTERPRETATION OF AERIAL PHOTOGRAPHY: DATA ACQUISITION, DATA INTERPRETATION, AND DATA DISPLAY

I. Data Acquisition (cost of obtaining imagery)	<u>Costs Per Sq. Mi.</u> <sup>1</sup>
(1:20,000).....	\$ 5.04
(1:40,000).....	1.79
A. Labor Costs (ordering time).....	.04
Research Scientist Associate IV = \$19,908	
15 man-days out of 260 man-days	
per year = x.058	
<u>\$1,155</u> ÷ 30,000 Sq. Mi.	
B. Imagery	
(1:20,000 color infrared).....	\$ 5.00
(1:40,000 color infrared).....	1.75
II. Data Interpretation (preliminary data and field research)	
through hand-color preparation for press <sup>2</sup> .....	\$12.01
A. Interpretation and Derivation.....	7.96
1. Labor Costs.....	7.68
Research Scientist Associate III =	
\$18,276	
x14 man-years	
<u>\$255,864</u>	
x90	
<u>\$230,278</u> ÷ 30,000 Sq. Mi.	
2. Travel.....	\$ .28
Per Diem	\$5,500.
BEG Vehicles @ \$ .18 per mile driven	<u>+3,960.</u>
22,000 mi.	
Total	\$9,460.
	90
	<u>\$8,514</u> ÷ 30,000 Sq. Mi.
	Fraction

Table 40 (Con't)

COST COMPUTATIONS ON A HYPOTHETICAL MAP

	<u>Costs Per Sq. Mi.</u>
B. Scribe Interpretations.....	\$ .80
1. Labor Costs.....	.78
Senior Cartographer = \$17,412	
18 Man-months =	$\frac{\begin{array}{r} \text{x1.5} \\ \$26,118 \\ \text{x.90} \\ \hline \$23,506 \end{array}}{\div 30,000 \text{ Sq. Mi.}}$
2. Pantograph <sup>3</sup> .....	.02
\$2,000 Cost ÷ 5 year life = \$400/year	
18 Man-months or 1.5 yr. =	$\frac{\begin{array}{r} \text{x1.5} \\ \$600/\text{year} \\ \text{x.90} \\ \hline \$540 \end{array}}{\div 30,000 \text{ Sq. Mi.}}$
C. Color-Out and Edit.....	3.25
1. Labor Cost.....	3.25
Research Scientist Assistant I = \$9,408	
11.5 Man-years =	$\frac{\begin{array}{r} \text{x11.5} \\ \$108,192 \\ \text{x.90} \\ \hline \$ 97,373 \end{array}}{\div 30,000 \text{ Sq. Mi.}}$
III. Data Display and Color Separation (editing of hand-colored copy and production of hard copy, color display).....	4.35
A. Color Separation.....	3.27
1. Labor Costs.....	2.75
Base Map @ 1:125,000	\$34,000
Environmental Geology	+48,500
	$\frac{\$82,500}{\div 30,000 \text{ Sq. Mi.}}$

Table 40 (Con't)

COST COMPUTATIONS ON A HYPOTHETICAL MAP

	Costs Per Sq. Mi.
2. Materials.....	\$ .52
Base Map	\$ 1,441
Environmental Geology	+14,067
	\$15,508 ÷ 30,000 Sq. Mi.
B. Printing.....	1.08
	\$32,500 ÷ 30,000
GRAND TOTAL	(1:20,000) \$21.40
	(1:40,000) \$18.19

<sup>1</sup>Original data was received in terms of a 30,000-square-mile area; hence; all numbers are divided by 30,000 to compute costs per square mile.

<sup>2</sup>Data-interpretation costs were received as costs for all seven maps. The factor of .90 is used throughout data interpretation to adjust for the fact that the environmental geology map is a fraction, albeit large, of total mapping costs.

<sup>3</sup>Pantograph cost estimates by G.W. Macon of the Bureau of Economic Geology, August 16, 1976.

Sources: All information from Dr. E.G. Wermund, Bureau of Economic Geology with the exception of the following:

Photography: Letter from Tobin Research, Inc., San Antonio, Texas, dated June 30, 1976.

Pay Scales: Gary Otting, University of Texas Personnel Office.

similar map today.

Data acquisition costs are given in terms of 1:20,000 and 1:40,000 color infrared aerial photography. It was assumed that flights would be required for new photography because these costs could be documented, even though existing data is often used for such projects. The costs of data acquisition today would be \$1.79 per square mile with color infrared at 1:40,000 and \$5.04 per square mile with color infrared at 1:20,000. As can be seen in table 41, data acquisition costs are a higher percent of total costs with larger scale photography, 23.5 percent for 1:20,000 as opposed to 9.8 percent for 1:40,000.

Data interpretation costs were divided into three steps: interpretation and derivation, scribe interpretations, and color-out and edit. The principal cost is actual interpretation of photography, which accounts for 37 and 44 percent of total costs, assuming 1:20,000 and 1:40,000 scale photography respectively.

Finally, data display costs were based on a 30,000-square-mile area and 2500 copies. This information was displayed on several maps, the largest of which covered an area of 4,000 square miles. Data display costs are in the range of 20 to 24 percent of costs, respectively.

A rearrangement of the data in table 41 would reveal that labor costs are dominant. Labor costs were assumed to stay the same regardless of photo scale, and as computed range from 67.8 to 79.9 percent of total costs with 1:20,000 and 1:40,000 infrared photography, respectively.

Total costs vary from \$18.15 to \$21.40 per square mile. These costs seem extremely high when compared to Landsat costs, until it is remembered that cost data used for constructing the hypothetical map were based on a classification scheme with a much greater level of detail and number of

Table 41

DISTRIBUTION OF COSTS ON THE HYPOTHETICAL MAP  
 BASED ON INTERPRETATION OF AERIAL PHOTOGRAPHY:  
 ASSUMING TWO DIFFERENT SCALES OF INFRARED PHOTOGRAPHY  
 AND NO CHANGE IN INTERPRETATION TIME WITH PHOTO SCALE

	Cost Per Sq. Mile	Percent of Total Costs (In Percent)	
		@1:20,000	@1:40,000
1. Data Acquisition	\$5.04*/1.79	23.5	9.8
Labor Costs	.04	.2	.2
Imagery Costs			
@1:20,000	5.00*	23.4	
@1:40,000	1.75		9.6
2. Data Interpretation	12.01	56.1	66.2
a. Interpretation and Derivation	7.96	37.2	43.9
Labor Costs	7.68	35.9	42.3
Travel Costs	.28	1.3	1.5
b. Scribe Interpretation	.80	3.7	4.4
Labor Costs	.78	3.6	4.3
Pantograph Costs	.02	.1	.1
c. Color Out and Edit	3.25	15.2	17.9
Labor Costs	3.25	15.2	17.9
3. Data Display and Color Separation	4.35	20.3	24.0
a. Color Separation	3.27	15.3	18.0
Labor Costs	2.75	12.9	15.2
Material Costs	.52	2.4	2.9
b. Printing	1.08	5.0	6.0
Total @1:20,000	21.40*	100.0	
@1:40,000	18.15		100.0

---

\*Infrared photography at 1:20,000 as opposed to 1:40,000.

classes than was attempted with Landsat maps.

## 9.4 The Cost-Saving Analysis

### 9.4.1 Introduction

This section compares the costs of producing the Landsat computer-classification map, the Landsat image-interpretation map, and a hypothetical map made from aerial photography. Difference in costs among these maps may be due to several factors, such as the type of classification scheme used, the number of classes mapped, and the method of mapping. Ideally, for a cost-savings study, this comparison among maps would reflect differences in the costs of the mapping technique only; yet these maps vary widely in the type of information and number of classes identified. As pointed out previously, the classification scheme for the hypothetical map had 92 classes, the computer map had 13, and the image-interpretation map had 23 classes. Not all classes would be on any one map, however. Given a mapping technique and required level of detail in imagery interpretation and display, the increase in costs of map production with greater numbers of classes could be mainly due to an increase in data-interpretation time and costs. There is, however, no easy way to separate cost differences arising from mapping technique from those arising from the number of classes. Therefore, in the following discussion, some calculations are made which assume there is no relationship between data-interpretation costs and number of classes for each of the three production techniques discussed.

At this point, the reader might object that these maps are so different in content (due to the classification schemes, techniques, and data sources used to extract information) that to assume these maps are the same misses a basic cost difference. For part of the discussion it was assumed that a



land cover and land use map with the same specifications and number of classes would cost the same as the hypothetical map, even though this may not be an accurate statement. Cost differences due to classes were treated for this comparison only as arising from the number of classes and not the information content of the classes.

Finally, the cost-savings framework of the study assumes that all three maps have the same information value to the decision-maker. If this were correct, then the benefit of using the least-cost method of mapping would be the savings in cost to the user (appendix L). However, the decision-maker would not be indifferent as to which map he used when confronted with these three maps. There is no question that the type of map represented by the hypothetical map would have more overall value in decision-making because there would be more information available.

#### 9.4.2 The Comparison in Costs

Table 42 shows comparisons of costs of the computer map, image-interpretation map, and hypothetical map. Photography for the hypothetical map is assumed to be new data acquired at a scale of 1:40,000 and in color-infrared. The discrepancy in data acquisition costs may reflect non-comparable costs. The hypothetical map reflected the total commercial cost of acquiring aerial photography, including costs of new flights, because this type of information could be documented. However, this commercial cost may be somewhat unrealistic for several reasons. For one, custom-flown aerial photography is relatively expensive to acquire, and consequently, many mapping projects (especially in state agencies) use data acquired for other purposes. Therefore, the cost of duplicating the data might be the major data acquisition cost. In addition, costs of Landsat data may not necessarily include all costs, especially those associated with placing

Table 42

**COSTS PER SQUARE MILE FOR THE COMPUTER MAP, IMAGE-INTERPRETATION  
MAP, AND HYPOTHETICAL MAP BASED ON INTERPRETATION OF AERIAL  
PHOTOGRAPHY, WITH A 40"x40" MAP SIZE**

Stage of Map Production	Computer Classification	Image Interpretation	Hypothetical Map
(Costs per square mile with selected percentages in parentheses)			
Data Acquisition <sup>1</sup>	\$ .02	\$ .01	\$ 1.79
(Costs of imagery as a percent of data acquisition costs)	(72.6)	(61.6)	(97.8)
Data Interpretation <sup>2</sup>	7.66	6.91	12.01
(Labor costs as a percent of data interpretation)	(62.2)	(74.0)	(97.5)
Data Display <sup>3</sup>			
a. Cost of set-up and one copy	.44	.44	.44
b. Cost of 100 copies	.78	.78	.78
c. Cost of 2500 copies	.96	1.00	4.35
Total costs per square mile with 2500 copies	\$ 8.64	\$ 7.92	\$18.15

<sup>1</sup> Computer and image-interpretation maps assume one scene only. The Hypothetical Map assumes infrared photography at 1:40,000. See tables 32 and 40 of the text.

<sup>2</sup> Data-interpretation costs for the Computer and image-interpretation maps assume one scene per site of Case 1. The computer map costs are for total number of runs. The percent of data-interpretation costs due to labor costs excludes secretarial assistance for these two maps. Data-interpretation costs for the Hypothetical Map can be found in table 40.

<sup>3</sup> Data display costs are for a 40" x 40" map which covers a 4,000 square mile area at a scale of 1:125,000. With the exception of the number for 2500 copies, the display costs for the image interpretation and the Hypothetical Map are treated as identical. All costs can be found in table 35, with the exception of those for the Hypothetical Map at 2500 copies. This is found in table 40.

<sup>4</sup> Total costs omit office overhead and additional time spent in work other than interpretation. The totals for computer and image interpretation maps include a negligible cost omitted in that for the Hypothetical Map, secretarial assistance.

a satellite in orbit. This study does not attempt to assess the costs of Landsat data, yet in a cost-benefit analysis such costs should be taken into account, for they are costs to the nation as a whole. However, for this study, only costs to the state were considered (appendix L). Costs of data acquisition, then, were higher for conventional photography, even though this, in part, may be a function of some subsidy to the Landsat program by the federal government.

The computations in cost-savings in table 42 imply that costs of a map made from Landsat data by computer-assisted analysis versus image-interpretation techniques would differ little, while costs of the hypothetical map would be much more expensive than the Landsat techniques. For example, a mapping project of 4000 square miles (2500 copies) would be expected to have costs of \$34,560, \$31,680, and \$72,600, depending on whether it was produced (1) from Landsat digital tapes (the computer map), (2) from Landsat images (the image-interpretation map), or (3) by conventional methods (the hypothetical map). If these costs were shared by 2500 users, the user cost per map would be \$13.82, \$12.67, and \$29.04, respectively. The first costs represent costs to the state for production, while the second set represents costs to the user, if the state charged the user the full costs of production.

Cost-savings are the difference between these costs. By the calculations in table 42, Landsat maps do show cost-savings. However, these costs do not represent comparable costs because only a few very elementary adjustments were made.

For example, costs for the computer map were based on the analysis of a small fraction of a Landsat scene. If a larger area were classified, costs would probably increase much less than those computed from table 42,

because the only additional cost would be computer time. Lower costs over large areas for the computer maps, however, would be coupled with fewer classes and less accuracy. More thorough knowledge of the relationship between the number of classes and the data-interpretation costs would also be desirable, so that the cost-savings could be adjusted to reflect differences in mapping techniques only. As noted earlier, the computer and image-interpretation map products display different numbers of land cover and land use classes, and these numbers may be significant. Sections 4.2 and 7.2 discuss some of the problems of fitting computer-derived classes based only on "color" or reflectance to an image-interpretation scheme designed for human judgment. Some information was, in fact, lost when some of the 30  $\pm$  classes originally generated by the computer-assisted technique were combined into 13 classes. Inserting a human interpreter into the process to delineate boundaries of areas of rangeland, agricultural land, etc., from mixtures of pixels representing several computer classes may or may not produce the same number and type of classes as the image-interpretation product. Adding an image-interpretation step might also increase total costs, but probably not by the 91 percent increase one might assume if cost adjustments were made to reflect only the difference in number of classes. For example, total costs for the computer map would be \$15.69 per square mile (instead of \$8.64) if adjusted to the 23 classes of the image-interpretation map. For comparison, a simple cost adjustment to reduce the number of classes to 23 for the hypothetical map would decrease total costs by 75 percent to \$4.54 per square mile. Such a low cost per square mile appears unlikely.

One factor not considered in this comparison is the advantage of computer classification of large areas (eg., an entire scene) versus the

smaller area of only a few USGS topographic maps. Much of the cost of computer classification occurs when classification statistics are generated. Once these statistics are set, the classification of Landsat data is automatic, and would be expected to reduce costs per square mile and produce a consistent classification over large areas. Costs per square mile for image interpretation, however, would not be expected to change, since decisions by the interpreter must be made repeatedly.

In summary, these cost adjustments were made for the sake of comparison only. It is not clear that the state really has a set of flexible mapping techniques at this point. Landsat mapping from digital tapes is not a refined process; much work remains to be done. It would be convenient if every technique were capable of delivering any type of map desired, so that selection among techniques could be made on the basis of cost alone. However, differences in costs indicate that some techniques are more refined than others and that the mapping method cannot be easily divorced from content area, number of classes, and other factors.

#### 9.5 Conclusions

This study has reviewed (1) the costs of production of Landsat-derived map products for small areas by computer-assisted and image-interpretation techniques; (2) an example of a cost-saving study which compared the costs of conventional mapping to mapping from Landsat data. This is the immediate information provided by the study, yet it is helpful to view prospective uses of the information in order to place the study in a wider context.

Costs of producing these Landsat maps could be used to estimate the costs of producing other types of maps from remote-sensing data. For instance, given the feasibility of identifying forest density and various

types of trees, one could use the raw cost data in appendix M and the computational procedure in tables 32-38 to compute a rough estimate of costs. Costs also could be adjusted for such differences as the number of classes and the rate of identification by the interpreter, for it is the interpreter who could be expected to be most attuned to interpretation time. These costs could also be used in a budgeting and planning context for an agency that needs to conduct natural resource inventory and mapping, providing consideration is given to the variables involved.

The cost-saving study is an example only. It is the sum of cost-saving to various state agencies which should determine a state decision to invest in a Landsat-based system, not merely the saving in producing one copy. In other words, if a Landsat product were produced, each agency which used it might have a unique source of current information to which the map should be compared. Neither the demand for Landsat map products nor the costs of information from current sources were ascertained through a survey of state agencies. A complete cost-savings analysis for a land cover and land use map would cover this added dimension.

## 10.0 DISCUSSION OF ACCOMPLISHMENTS AND CONCLUSIONS

### 10.1 A Quasi-Operational Coastal Zone Resources Monitoring System

The primary sense in which the term "monitoring" has been used throughout this investigation has been that of a repetitive, ongoing inventory of resources. This is a simplistic approach in that it has also been assumed that identifying a certain list of classes (e.g., section 4.0, table 7) over and over again and detecting changes in those classes would satisfy a requirement for "monitoring." No doubt such a capability would constitute part of a monitoring system. However, repet-

itive inventory and detection of changes must have some purpose. Periodic assessment of status or conditions of natural resources perhaps best would be an "accounting function" of resources management.

It is probably not realistic--i.e., cost-effective--to inventory the entire coastal zone or any other resource or region to any great detail on a frequent interval (less than 1-5 years), even with Landsat data. The sheer magnitude of inventorying an area of 15,000 square miles with any detail at all is staggering. Rather, baseline information (such as the Environmental Geologic Atlas of the Texas Coastal Zone being prepared by the Bureau of Economic Geology) that is available for the Texas coast within a specific time frame, could be updated on a site-by-site basis as part of ongoing management processes. Such a concept, if tied into the baseline information as new data was collected, and coordinated between agencies having management responsibilities for the same resources would, in fact, form the nucleus of a truly functional monitoring system. Exploring this approach was outside the scope of this investigation, however.

What was accomplished in terms of a "quasi-operational coastal zone resources monitoring system," was a capability (a partial system) to analyze Landsat data. The remote-sensing "system" that eventually developed from this investigation included the following components:

1. An operational, remote-sensing data handling and data ordering component (section 3.3) was established as a service of the Texas Natural Resources Information System (TNRIS).

2. A Landsat data analysis component was developed, consisting of both image-interpretation and computer-assisted classification techniques as independent options for generating land cover and land use information

from Landsat data. Image-interpretation techniques as discussed in this report (sections 6.0 and 7.1) are potentially "operational" in that these techniques need no further development to be utilized. Techniques for computer-assisted analysis, however, still require considerable refinement (sections 5.0 and 7.2) to realize the full potential of their speed, versatility, economy, and consistency of classification over large areas.

3. An experimental data display component was designed to provide essentially single working copies. Products generated from computer classification or image-interpretation techniques may be displayed in the following ways: (a) Printer maps, scaled and registered to USGS topographic maps at a scale of 1:24,000. These computer maps must be hand-colored, taped together, and trimmed for use. (b) Hand-colored, line-boundary maps display the classification of all areas delineated by line boundaries. Each map is reproduced on stable white plastic material before classifying features.

Commercial alternatives for printing multiple copies of Landsat maps have been explored, should this reproduction capability be needed. These options are discussed as part of the data tables and text in the economic analysis (section 9.0). Samples of commercial reproduction using 4-color screens of the hand-colored image-interpretation maps for test sites 2, 3, 4, and 5 have been produced at a scale of 1:125,000 (in pocket). In addition samples of the computer-classification maps for site 4 have been displayed in color using a commercial process patented by Seiscom Delta, Inc., Houston, Texas, at scales of 1:125,000 (figs. 25, 26, 27, and 28) and at a scale of 1:24,000 (in pocket).



## 10.2 A Documented Cost-Benefit Analysis of the System Developed

A cost-saving analysis was selected as the cost-benefit approach most suitable to the scope and resources available to this investigation (section 9.0). A cost-savings methodology assumes that differences in costs of production between two maps having the same information content would provide a means to evaluate different analytical techniques and data sources. Unfortunately, the three map products used in the cost comparison differed in "value" as well as cost.

The most comparable products, in the sense of similar record-keeping and information "value," were those derived from image-interpretation and computer-assisted analysis of Landsat data for test site 4 (200 square miles) as part of this investigation. When compared on the basis of costs per square mile only, the computer product cost \$8.64 per square mile, compared to \$7.92 per square mile for the image-interpretation map (table 42).

Not only was the image-interpretation map "less costly" for the small area evaluated, but it also contained more information (section 4.0) with a higher classification accuracy (section 7.0). Thus, the image-interpretation map appears to be the better "buy" of the two at this time. An important factor that contributed to the higher cost for the computer product, probably was that computer-assisted classification techniques are less well refined than techniques for image-interpretation analysis and currently require more analyst time than would be expected if "operational." In addition, computer-assisted analysis over large areas was not attempted but would be expected to cost less per square mile than image-interpretation when analysing a full Landsat scene. Image-interpretation techniques, however, can often generate finer detail or

different classes of information than can be obtained from computer analysis and also may obtain greater accuracy for some classes. This suggests that a combination of the two techniques for large area analysis would be especially cost-effective.

Costs for a hypothetical map, derived by conventional interpretation of aerial photography, were constructed from cost estimates provided by the Bureau of Economic Geology (BEG) as an example of how cost data could be compiled without detailed records. BEG had not produced a comparable land use map with 13-23 classes from aerial photography with which to estimate costs, so that a more recently completed and much more detailed map was used. Results of the cost analysis for this hypothetical map (section 9.3 and table 42) appear to indicate that if a map product contains more information (e.g., the classification scheme for the hypothetical map had 92 classes) and would, therefore, be of more "value" to users, it would also cost more (\$18.15 per square mile).

### 10.3 A Remote Sensing Software and Data Handling Library Available to the State of Texas for Further Work

Section 3.3 discusses the data handling procedures established for this investigation by the Texas Natural Resources Information System (TNRIS). Not only were all data for this project ordered and distributed by the TNRIS Systems Central Staff, but they were also indexed as part of the permanent files of Landsat data and aerial photography which are available to TNRIS users.

Software and analytical procedures developed as part of TNRIS support for this project are also available to other agencies through the TNRIS. Several state agencies, including the Texas Forest Service and the Texas Water Development Board, have recently initiated feasibility

studies with TNRS to explore application of the techniques for computer-assisted analysis of Landsat data that are documented in section 5.0.

#### 10.4 A Complete Base Map of Coastal Zone Features Being Studied, and the Beginning of a Historical Library of Temporal Changes Along the Coast

Even before the investigation began, it was apparent that this objective could not be accomplished as part of this project. However, a complete regional base map of coastal zone features was, in fact, already provided by the Bureau of Economic Geology's Environmental Geologic Atlas of the Texas Coastal Zone (Brown, project coordinator, in progress). To insure that these maps reflected current conditions, a transparent overlay was prepared on which recent changes were compiled from February 1975 aerial photography (NASA Mission 300, 1:120,000 scale) flown for this project (section 3.4.1). These annotated overlays are available in "open-file" at the Bureau of Economic Geology on the University of Texas campus.

#### 10.5 A Documented Analysis of the Performance of the Image Interpretation vs. Digital Processing, and the Various Algorithms in Digital Processing, with Respect to Monitoring Coastal Zone Features

Techniques developed and tested during this investigation using both image-interpretation and computer-assisted approaches to analyze Landsat data were discussed in sections 5.0 and 6.0 of this report. The performance of these techniques was evaluated (1) by determining the classification accuracy or reliability for map products generated by image interpretation and computer-assisted analysis (section 7.0) and (2) by examining the application of these products to selected types of management concerns of the General Land Office on the Texas coast (section 8.0).

The performance of these Landsat-derived maps, in terms of the accuracy or reliability of the information displayed on them, was given thoughtful consideration by the project team. Landsat data has very low resolution for conventional image interpretation, even with optical enlargement, so that the interpreter may have less confidence in some classification decisions than with aerial photography. In addition, computer-assisted analysis provides a display of spectral classes that are different from land cover and land use classes almost by definition (section 4.2). Therefore, it was important to examine these products for classification accuracy.

In section 7.2, the computer classification display was compared to the image-interpretation results in two different ways. One comparison used the land cover and land use classification schemes developed for each technique, in which the computer classification correlated with the interpreted classes overall about 62 percent of the time (table 26). For this comparison, the image-interpretation results derived from Landsat data had been verified using aerial photography.

A correlation of 62 percent may be somewhat misleading due to the differences in the types of information compared. Because the computer spectral classes had not been carefully related to ground conditions, the use of specific land cover terms for these classes could in itself introduce considerable error. In an attempt to see if more accurate information might be "hidden" in the spectral classes, lacking only better definition, those classes with vegetation were combined. With this adjustment, overall classification accuracy did improve to 74 percent, suggesting that more work could profitably be done in this area.

Classification accuracy for the image-interpretation maps was 87.5 percent (table 20), which was within the 85 percent minimum accuracy for land cover and land use information suggested by Anderson and others (1976). These image-interpretation maps were more useable overall from the standpoint of the information displayed than the computer-generated maps, which still require some interpretation when used.

The application of Landsat-derived map products to coastal management activities in section 8.0 was only a partial, qualitative assessment. As we emphasized in the economic analysis (section 9.0), specific information requirements had not been carefully surveyed before this investigation began, nor was such a survey within the scope of this investigation.

Results of the application of Landsat-derived map products, however, did indicate the potential value of Landsat data as a supplemental data source for coastal management purposes (section 8.3). In addition, Landsat provides repetitive coverage that could fill the "gaps" between availability of aerial photo coverage. Ground data collected for a variety of purposes could also be coordinated with the schedule for Landsat overpasses. Such an application, however, would be somewhat risky with the experimental nature of the existing satellite system. Currently, schedule changes for times of Landsat overpasses or in sensor status are not readily available to users. Thus, attempts to coordinate ground data collection with satellite overpasses might meet with some frustration.

#### 10.6 Conclusions Relating to Image Interpretation of Landsat Imagery

Results of interpreting Landsat images of the Texas coast indicate that a substantial degree of success can be achieved in mapping 23

specialized categories of land cover and land use (table 7). Landsat transparencies can be optically enlarged up to eight times without serious loss of image quality to produce maps at a scale of 1:125,000. An understanding of coastal geologic processes and biologic assemblages is essential to visual interpretation because it enables the human interpreter to use much more than just reflectance in delineating coastal features. The shape of an object, its internal texture, and its characteristic position with respect to adjoining environmental units often supersede reflectance as the basis for making classification decisions. Perhaps because Landsat data originate in a digital format and are readily processed by machine, these aspects of imagery interpretation have received less attention than they certainly warrant.

Reflectance alone, seen as the color tones of the false-color composite or the gray tones of a single-band image, is not the absolute criterion for identifying each type of land cover and land use. The growth phase of the vegetation, recent weather conditions, atmospheric conditions at the time of image acquisition, and tide level are factors which must be taken into account in interpreting reflectance in a Landsat scene of the coastal region. Furthermore, seasonal change in sun angle, photographic processing of the image, and functioning of the satellite's sensors and recorders can introduce additional variation in color tone and intensity. The interpreter using standard Landsat products therefore must rely on a familiarity with the coastal environment in order to compensate for the limit of resolution of about 80 m and the 1:1,000,000 scale of the imagery.

A knowledge of the location of urban and built-up areas in a particular study site is easily obtained from published maps and available

aerial photography. Since small urban areas which have a low density of development and therefore lack reflectivity contrast with the naturally surrounding area may be totally missed, the necessity of auxiliary information in making some Level II and Level III classification decisions cannot be ignored. Indeed, J. R. Anderson and others (1972) define the second classification level to include the use of topographic maps as an additional data source. The techniques outlined in this paper can be easily and inexpensively adapted for use with existing map data. In this manner, the user can take advantage of Landsat's unique vantage point, its repeated coverage, and the low direct purchase cost for data about a large area.

Change detection can be accomplished during optical image interpretation by combining transparencies (fig. 22). This technique is easy to use, and registration of the images is not a problem because a good local fit can be achieved over small areas of interest. Changes in rangeland, cropland, and wetlands resulting from water level differences were closely correlated with ground truth data. Changes in low-density urban areas and the mappability of roads varied with image characteristics and the subjective decisions of the image interpreter. These urban categories, therefore, could not be handled reliably during optical change detection.

The delineation of land use and land cover in any area involves a detailed initial inventory using all available types of information followed by monitoring to ensure that the data remain indicative of current conditions. This monitoring is especially important in coastal regions in which the development of natural resources and the sometimes catastrophic natural processes can induce rapid change. It is in the

monitoring function that the procedures outlined here for use with the Landsat data can play an important role. Such changes as channel dredging, placement of spoil, conversion of rangeland to cropland, filling of wetlands for other uses, and migration of large (up to several km in width) active dune complexes can, depending on the scale of the change, be readily detected and mapped. The synoptic coverage of the bays and near-shore areas provides data on turbidity distribution and therefore circulation patterns, which are not often obtained repetitively by aerial photography because of cost constraints. The results obtained during this investigation are indicative of the need to maintain the availability of Landsat standard image products. The mapping technique utilizing simple optical enlargement of Landsat imagery and a multilevel classification system are the means of incorporating up-to-date regional information which might not be available from other sources at a comparable cost into a valuable body of information concerning coastal resources.

#### 10.7 Conclusions Relating to Computer-Assisted Analysis of Landsat Computer-Compatible Tapes (CCT's)

The experience gained during this Landsat investigation leads to the following conclusions:

1. Landsat imagery in digital form can provide an important data source for the analysis of coastal zone activities.
2. Computer-assisted techniques and procedures, as developed through this project, provide a fairly reliable, consistent means of extracting information from Landsat digital data concerning land cover and land use activities in the coastal zone, within the limits of data resolution and the classification scheme used (section 7.0).



3. The use of spectral data alone for image analysis, without regard to such common factors as texture, shape, size, and association, when applying computer-assisted techniques, places a major constraint on the types of land use categories which can be mapped without added human interpretation (sections 4.0 and 7.0).
4. The "unsupervised" approach to computer-assisted analysis of coastal zone activities is more appropriate than the "supervised" approach due to the unhomogeneous nature of many of the land cover and land use categories of interest (e.g., tidal flats and marshes).
5. The computer-assisted analysis of Landsat digital data provides a means of generating products which could be interacted with data from other sources in the computer environment to create products having significantly increased utility to the user.
6. Use of the computer-assisted analysis techniques developed during this project requires a minimum of training in automatic data processing activities. The analyst should have some knowledge of remote-sensing fundamentals and familiarity with the area under study.
7. Selected aerial photography and some surface-collected data are required as "ground truth" to support the computer-assisted analysis of Landsat data.
8. Landsat data, aerial photography, and surface-collected data are complementary data sources which can be used in combination to acquire information about coastal zone activities and processes more effectively than when used individually.

9. A combination of image-interpretation techniques and computer-assisted analysis techniques would allow maximum value to be gained from each approach.
10. Development of an "operational" capability to support ongoing user requirements that utilize computer-assisted techniques will necessitate considerable improvement in several areas of the experimental capability developed during this project.
11. Classification maps displayed by line-printer, particularly at larger scales, are cumbersome and difficult to analyze.

#### 10.8 Recommendations

1. The task of correlating "cluster" maps, generated by unsupervised computer-assisted analysis techniques, with ground truth should be automated if feasible (section 7.2.4). The possibility should be investigated of storing in computer-compatible form the latitude and longitude coordinates of points that had been identified as specific land cover and land use categories for later comparison with newly generated spectral clusters.
2. Procedures requiring human interaction with the computer, such as building the control network and selection of training fields, should be improved to provide for faster and more efficient analysis of the Landsat digital data, particularly if the computer-assisted analytical approach is to be used in an "operational" mode (i.e., quick response, useful format, etc.).
3. An evaluation of "interactive" digital image processing systems should be conducted to determine the feasibility and cost-effectiveness of such systems to support state agency needs for imagery analysis.

4. A land use and land cover classification system optimized for spectral data should be developed for the coastal zone to allow maximum use of computer-assisted techniques for analysis of Landsat data.
5. An effort should be made to determine the optimum mix of Landsat data, aircraft photography, and surface data to support identified information needs of state agencies in the coastal zone.
6. An effort should be made to determine the optimum mix between image-interpretation techniques and computer-assisted analysis techniques for analysis of Landsat and related data to provide the most cost-effective method for support of state agency requirements.
7. The capability should be developed for digital image enhancement and other specialized processing to allow maximum information to be extracted from Landsat and related data.
8. Software and procedures should be explored for extension of spectral "signatures" between adjacent Landsat scenes and for different dates to allow analysis of large areas and possible development of a signature file.
9. More effective methods for displaying the classification results need to be investigated.

## REFERENCES

- Alexander, R. H., Fitzpatrick, K., Lins, H. F., Jr., McGinty III, H. K., 1975, Land use and environmental assessment in the Central Atlantic Region, in Proc. NASA Earth Resources Survey Symposium: Houston, Texas, p. 1683-1703.
- Anderson, J. R., Hardy, E. E., and Roach, J. T., 1971, A land-use classification system for use with remote sensor data: U.S. Geol. Survey Circ. 671, 16 p.
- Anderson, J. R., Hardy, E. E., Roach, J. T., and Witmer, R. E., 1976, A land use and land cover classification system for use with remote sensor data: U.S. Geol. Survey Prof. Paper 964, 18 p.
- Anderson, R. R., Alsid, L., and Carter, V., 1975, Applicability of SKYLAB orbital photography to coastal wetland mapping: Proc. Am. Soc. Photogrammetry, 41st Ann. Mtg., p. 371-377.
- Anderson, R. R., Carter, V. P., and McGinness, J. W., 1973, Applications of ERTS data to coastal wetland ecology with special reference to plant community mapping and typing and impact of man, in Freden and others, eds., Third Earth Resources Technology Satellite Symposium, v. 2: Washington, D. C., NASA, p. 1225-1242.
- Anderson, R. R., Carter, V. P., and McGinness, J. W., 1974, Mapping northern Atlantic coastal marshlands, Maryland-Virginia, using ERTS-1 imagery, in Shahrokhi, F., ed., Remote Sensing of Earth Resources: Univ. Tenn., Tullahoma, v. 2, p. 1011-1020.
- Anderson, R. R., and Wobber, F. J., 1973, Wetlands mapping in New Jersey: Photogram. Eng., v. 30, p. 353-358.
- Andrews, P. B., 1970, Facies and genesis of a hurricane-washover fan, St. Joseph Island, Central Texas Coast: Univ. Texas, Austin, Bur. Econ. Geology, Rept. Inv. 67, 147 p.
- Armstrong, Bob, Commissioner, General Land Office, 1973, Development and application of operational techniques for the inventory and monitoring of resources and uses for the Texas coastal zone: General Land Office, Austin, Texas, 51 p.
- Arp, G. K., 1975, The rationale for attempting to define salt marsh mosquito breeding areas in Galveston County by remote sensing the associated vegetation, in Smistad and others, coord., NASA Earth Resources Survey Symposium: Houston, Johnson Space Center, NASA. TM-X-58168, p. 289-299.
- Bartlett, D., Klemas, V., and Rogers, R., 1975, Investigations of coastal land use and vegetation with ERTS-1 and SKYLAB-EREP: Proc. Am. Soc. Photogrammetry, 41st Ann. Mtg., p. 378-389.

- Benton, R. A., Jr., Hatch, S. L., Kirk, W. L., and Newman, R. M., 1975, Monitoring of Texas coastal wetlands with aerial photography, Phase I-feasibility study: College Station, Texas A & M Univ.
- Berry, B. J., and Baker, A. M., 1968, Geographic sampling, in Berry B. and Marble, D. F., eds., Spatial analysis--A reader in statistical geography: Englewood Cliffs, N.J., Prentice Hall, p. 91-100.
- Brown, L. F., Jr., project coordinator, in progress, Environmental geologic atlas of the Texas coastal zone: seven volumes, Univ. Texas, Austin, Bur. Econ. Geology.
- Brown, L. F., Jr., Brewton, J. L., Evans, T. J., McGowen, J. H., Groat, C. G., and Fisher, W. L., in progress, Environmental geologic atlas of the Texas coastal one--Brownsville-Harlingen area: Univ. Texas, Austin, Bur. Econ. Geology.
- Brown, L. F., Jr., Brewton, J. L., McGowen, J. H., Evans, T. J., Fisher, W. L., and Groat, C. G., 1976, Environmental geologic atlas of the Texas coastal zone--Corpus Christi area: Univ. Texas, Austin, Bur. Econ. Geology, 123 p.
- Carter, P. and Jackson, M., 1976, The automated recognition of urban development from Landsat images, in Proc. Symposium on Machine Processing of Remotely Sensed Data: Purdue University, West Lafayette, Ind., p. 1B-15-1B-24.
- Carter, V., and Shubert, J., 1974, Coastal wetlands analysis from ERTS MSS digital data and field spectral measurements: in Proc. 9th Inter. Symp. on Remote Sensing of the Environment: Ann Arbor Michigan, p. 1241-1260.
- Chabreck, R. H., 1972, Vegetation, water and soil characteristics of the Louisiana coastal region: Baton Rouge, Louisiana State Univ., Agri. Expt. Sta., Bull. No. 664, 31 p.
- Clark, J., 1974, Coastal ecosystems: Washington, D. C., The Conservation Foundation, 178 p.
- Davies, J. L., 1964, A morphogenic approach to world shorelines: Zeit. fur. Geomorph., V. 8, p. 127-142.
- Edwards, P., 1976, An illustrated guide to the seaweeds and sea grasses in the vicinity of Port Aransas, Texas: Austin, Univ. Texas Press, 128 p.
- Eppler, W. G., 1976, Computer processing for classification and registration: An introduction: Lockheed Electronics Company, Inc., HASD, Houston, Texas.
- Erb, R. P., 1974, The ERTS-1 investigation, Vol. II-ERTS-1 Coastal/estuarine analysis: Houston, Johnson Space Center, JSC-08457, 284 p.
- Erickson, J. D., 1975, Advances in automatic extraction of earth resources information from multispectral scanner data, in Proc. NASA Earth Resources Survey Symposium: Houston, Texas, p. 1245-1274.

- Fisher, W. L., McGowen, J. H., Brown, L. F., Jr., and Groat, C. G., 1972, Environmental geologic atlas of the Texas coastal zone - Galveston-Houston area: Univ. Texas, Austin, Bur. Econ. Geology, 91 p.
- Fitzpatrick, K., 1975, Cost accuracy and consistency comparisons of land use maps made from high-altitude aircraft photography and ERTS imagery: Reston, Va., Final report, vol. 6, CARETS project, Goddard Space Flight Center, Greenbelt, Md., and U.S. Geol. Survey, 61 p.
- Fleetwood, R. J., 1973, Plants of Laguna Atascosa National Wildlife Refuge, Cameron County, Texas: Harlingen, Tx., U.S. Dept. Interior, Fish and Wildlife Service, Bur. Sports Fisheries and Wildlife, 48 p.
- Freden, S. C., Mercanti, E. P., and Becker, M. A., eds., 1973a, Symposium on significant results obtained from the Earth Resources Technology Satellite-1, Vol. I, Technical Presentations, Sections A and B: Washington, D. C., Goddard Space Flight Center, NASA SP-327, 1730 p.
- \_\_\_\_\_, 1973b, Third Earth Resources Technology Satellite-1 Symposium, Vol. I, Technical Presentations, Sections A and B: Washington, D. C., Goddard Space Flight Center, NASA SP-351, 1974 p.
- The General Land Office and Texas Coastal and Marine Council, 1974, Texas coastal legislation: 51 p.
- Grimes, B. H., and Hubbard, J. C. E., 1971, A comparison of film type and the importance of season for the interpretation of coastal marshland vegetation: Photogramm. Rec., v. 7, p. 213-222.
- Haislet, J. A., 1963, Forest trees of Texas: College Station, Texas A & M Univ. Texas Forest Service, Bull. No. 20, 156 p.
- Interpretation Systems Incorporated, 1976: Glossary and index to remotely sensed image pattern recognition concepts: Image Interpretation Systems Incorporated, Kansas.
- Johnston, M. C., 1955, Vegetation of the eolian plain and associated coastal features of southern Texas: Univ. Texas, Austin, unpub. Ph.D. dissert.
- Jones, Clay, 1974, Implementation of an advanced Table Look-up classifier for large area land use classification, in Proc. 9th Inter. Symp. on Remote Sensing of the Environment: Ann Arbor, Michigan, p. 813.
- Jones, F. B., 1975, Flora of the Texas Coastal Bend: Sinton, Tx., Welder Wildlife Found., 262 p.
- Jones, R., Harwood, P., Finley, R., Murphy, D., and Holz, R. K., 1975b, Development and application of operational techniques for the inventory and monitoring of resources and uses for the Texas coastal zone: Type II (Quarterly) Report, prepared for Goddard Space Flight Center, December, 1975, 36 p.

- Klemas, V., Daiber, F. C., Bartlett, D., Crichton, O. W., and Fornes, A. O., 1974, Inventory of Delaware's wetlands: Photogramm. Eng., v. 40, p. 433-439.
- McGowen, J. H., and Brewton, J. L., 1975, Historical changes and related coastal processes, Gulf and mainland shorelines, Matagorda Bay area, Texas: Univ. Texas, Austin, Bur. Econ. Geology, 72 p.
- McGowen, J. H., Proctor, C. V., Jr., Brown, L. F., Jr., Evans, T. J., Fisher, W. L., and Groat, C. G., 1976, Environmental geologic atlas of the Texas coastal zone--Port Lavaca area: Univ. Texas, Austin, Bur. Econ. Geology, 107 p.
- McGowen, J. H., and Scott, A. J., 1975, Hurricanes as geologic agents on the Texas coast, in Cronin, L. E., ed., Estuarine research, v. II: New York, Academic Press, p. 23-46.
- Minter, Ruth T., 1972, ISOCLS-Interactive Self-Organizing Clustering Program: Lockheed Electronics Company, Inc., HASD, Houston, Texas.
- National Aeronautics and Space Administration/Johnson Space Center, 1974, EOD-LARSYS, Program Q619: Houston, Texas, p. 4-16 thru 4-36.
- \_\_\_\_\_, 1974, The ERTS-1 Investigation (ER-600): Volume VII - ERTS-1 Land Use Analysis of the Houston Area Site, NASA Technical Memorandum: NASA/JSC, Houston, Texas, p. D-1 thru D-6.
- \_\_\_\_\_, 1976, Prototype coastal environment mapping procedure: Contract NAS9-12200, prepared by Lockheed Electronics Co.
- National Aeronautics and Space Administration, 1976, Landsat data users handbook: Goddard Space Flight Center, Greenbelt, Maryland.
- Pestrong, R., 1969, Multiband photos of a tidal marsh: Photogram. Eng., v. 35, p. 453-470.
- Price, W. A., 1975, Physical environmental dynamics of tidewater zone, Texas, and human interferences in the Corpus Christi area: Port Aransas, Tx., Coastal Science Workshop, unpub. notes, 25-27 Sept. 1975.
- Reimold, R. J., Gallagher, J. L., and Thompson, D. E., 1972, Remote sensing of tidal marsh: Photogramm. Eng., v. 39, p. 477-488.
- Rogers, R. H., Smith, V. E., and Reed, L. E., 1974, ERTS-1; Automated land-use mapping of lake watersheds, in Remote Sensing of Earth Resources, Univ. Tenn., Tullahoma, v. 3, p. 463-485.
- Sauer, J., 1967, Geographic reconnaissance of seashore vegetation along the Mexican Gulf coast: Baton Rouge, Louisiana State Univ., Coastal Studies Institute, Tech. Rept. No. 56, 59 p.
- Schlosser, Edward H., and Brown, M. L., 1976, Detection and Mapping Package: 3 volumes, Earth Observation Division, NASA, JSC.

- Smedes, H. W., Hulstrom, R. L., and Ransow, K. J., 1975, The mixture problem in computer mapping of terrain: Improved techniques for establishing spectral signatures, atmosphere, path radiance, and transmittance, in Proc. NASA Earth Resources Survey Symposium: Houston, Texas, p. 1099-1159.
- Smistad, O., Zeitler, E. O., and Richard, D., coordinators, 1975, NASA Earth Resources Survey Symposium, Vols. IA--ID: Houston, Johnson Space Center, NASA TM X-58168, 2685 p.
- Task Force on Remote Sensing, 1974, Texas Remote Sensing Plan: A report to the Interagency Council on Natural Resources and the Environment: Austin, Texas.
- Texas Revised Civil Statutes Annotated, article 5415e-1, Supp. 1976.
- U. S. Department of Commerce, 1975a, Local climatological data: Brownsville, Texas: Asheville, N. C., National Climatic Center.
- \_\_\_\_\_, 1975b, Tide tables, 1976: Washington, D. C., Natl. Oceanic and Atmospheric Adm., Natl. Ocean Survey, 290 p.
- Weisblatt, E. 1976, Satellite inventories of coastal zone environments (abs.), in Symp. on Research Techniques in Coastal Environments: Baton Rouge, Louisiana State Univ., March 18-19, 1976, p. 42.
- Williams, R. S., Jr., and Carter, W. D., eds., 1976, ERTS-1 A new window on our planet: U.S. Geol. Survey Prof. Paper 929, 362 p.
- Wood, W. F., 1955, Use of stratified random samples in a land use study. Annals Assoc. Am. Geographers, v. 45, p. 350-367.



PLATE 5. Harbor Island Area, Test Site 4, 25 February 1975.

PLATE 6. Harbor Island Area, Test Site 4, 10 July 1975.

PLATE 4. South Padre Island-Laguna Madre Area, Test Site 5, 25 February 1975.

PLATE 2. Freeport-San Luis Pass, Test Site 2, 8 May 1973.

PLATE 3. San Antonio-Espiritu Santo Bay Area, Test Site 3, 29 March 1974.

PLATE 1. Seischrome™ Display of Computer-Assisted Analysis of Harbor Island Area, Test Site 4, 2 February 1976.

**DATE DUE**

GAYLORD No. 2333

PRINTED IN U.S.A.

NOAA COASTAL SERVICES CENTER LIBRARY



3 6668 14106 7233