

# The Potential Impact of Ocean Thermal Energy Conversion (OTEC) on Fisheries

Edward P. Myers  
Donald E. Hoss  
Walter M. Matsumoto  
David S. Peters  
Michael P. Seki  
Richard N. Uchida  
John D. Ditmars  
Robert A. Paddock

---



U.S. DEPARTMENT OF COMMERCE  
National Oceanic and Atmospheric Administration  
National Marine Fisheries Service

## NOAA TECHNICAL REPORT NMFS

---

The major responsibilities of the National Marine Fisheries Service (NMFS) are to monitor and assess the abundance and geographic distribution of fishery resources, to understand and predict fluctuations in the quantity and distribution of these resources, and to establish levels for their optimum use. NMFS is also charged with the development and implementation of policies for managing national fishing grounds, development and enforcement of domestic fisheries regulations, surveillance of foreign fishing off United States coastal waters, and the development and enforcement of international fishery agreements and policies. NMFS also assists the fishing industry through marketing service and economic analysis programs, and mortgage insurance and vessel construction subsidies. It collects, analyzes, and publishes statistics on various phases of the industry.

The NOAA Technical Report NMFS series was established in 1983 to replace two subcategories of the Technical Reports series: "Special Scientific Report—Fisheries" and "Circular." The series contains the following types of reports: Scientific investigations that document long-term continuing programs of NMFS; intensive scientific reports on studies of restricted scope; papers on applied fishery problems; technical reports of general interest intended to aid conservation and management; reports that review in considerable detail and at a high technical level certain broad areas of research; and technical papers originating in economics studies and from management investigations. Since this is a formal series, all submitted papers receive peer review and those accepted receive professional editing before publication.

Copies of NOAA Technical Reports NMFS are available free in limited numbers to governmental agencies, both Federal and State. They are also available in exchange for other scientific and technical publications in the marine sciences. Individual copies may be obtained from: U.S. Department of Commerce, National Technical Information Service, 5285 Port Royal Road, Springfield, VA 22161. Although the contents have not been copyrighted and may be reprinted entirely, reference to source is appreciated.

1. Synopsis of biological data on the Blue Crab, *Callinectes sapidus* Rathbun, by Mark R. Millikin and Austin B. Williams. March 1984, 39 p.
2. Development of hexagrammids (Pisces: Scorpaeniformes) in the Northeastern Pacific Ocean, by Arthur W. Kendall, Jr., and Beverly Vinter. March 1984, 44 p.
3. Configurations and relative efficiencies of shrimp trawls employed in southeastern United States waters, by John W. Watson, Jr., Ian K. Workman, Charles W. Taylor, and Anthony F. Serra. March 1984, 12 p.
4. Management of northern fur seals on the Pribilof Islands, Alaska, 1786-1981, by Alton Y. Roppel. April 1984, 26 p.
5. Net phytoplankton and zooplankton in the New York Bight, January 1976 to February 1978, with comments on the effects of wind, Gulf Stream eddies, and slope water intrusions, by Daniel E. Smith and Jack W. Jossi. May 1984, 41 p.
6. Ichthyoplankton survey of the estuarine and inshore waters of the Florida Everglades, May 1971 to February 1972, by L. Alan Collins, and John H. Finucane. July 1984, 75 p.
7. The feeding ecology of some zooplankters that are important prey items of larval fish, by Jefferson T. Turner. July 1984, 28 p.
8. Proceedings of the International Workshop on Age Determination of Oceanic Pelagic Fishes: Tunas, Billfishes, and Sharks, by Eric D. Prince (convener and editor), and Lynn M. Pulos (editor). December 1983, 211 p.
9. Sampling statistics in the Atlantic menhaden fishery, by Alexander J. Chester. August 1984, 16 p.
10. Proceedings of the Seventh U.S.-Japan Meeting on Aquaculture, Marine Finfish Culture, Tokyo, Japan, October 3-4, 1978, by Carl J. Sindermann (editor). August 1984, 31 p.
11. Taxonomy of North American fish Eimeriidae, by Steve J. Upton, David W. Redeker, William L. Current, and Donald W. Duszynski. August 1984, 18 p.
12. Soviet-American Cooperative Research on Marine Mammals. Volume 1—Pinnipeds, by Francis H. Fay, and Gennadii A. Fedoseev (editors). September 1984, 104 p.
13. Guidelines for reducing porpoise mortality in tuna purse seining, by James M. Coe, David B. Holts, and Richard W. Butler. September 1984, 16 p.
14. Synopsis of biological data on shortnose sturgeon, *Acipenser brevirostrum* LeSueur 1818, by Michael J. Dadswell, Bruce D. Taubert, Thomas S. Squiers, Donald Marchette, and Jack Buckley. October 1984, 45 p.
15. Chaetognatha of the Caribbean sea and adjacent areas, by Harding B. Michel. October 1984, 33 p.
16. Proceedings of the Ninth and Tenth U.S.-Japan Meetings on Aquaculture, by Carl J. Sindermann (editor). November 1984, 92 p.
17. Identification and estimation of size from the beaks of 18 species of cephalopods from the Pacific Ocean, by Gary A. Wolff. November 1984, 50 p.
18. A temporal and spatial study of invertebrate communities associated with hard-bottom habitats in the South Atlantic Bight, by E. L. Wenner, P. Hinde, D. M. Knott, and R. F. Van Dolah. November 1984, 104 p.
19. Synopsis of biological data on spottail finfish, *Diplodus holbrooki* (Pisces: Sparidae), by George H. Darcy. January 1985, 11 p.
20. Ichthyoplankton of the Continental Shelf near Kodiak Island, Alaska, by Arthur W. Kendall, Jr., and Jean R. Dunn. January 1985, 89 p.
21. Annotated bibliography on hypoxia and its effects on marine life, with emphasis on the Gulf of Mexico, by Maurice L. Renaud. February 1985, 9 p.
22. Congrid eels of the eastern Pacific and key to their Leptocephali, by Solomon N. Raju. February 1985, 19 p.
23. Synopsis of biological data on the pinfish, *Lagodon rhomboides* (Pisces:Sparidae), by George H. Darcy. February 1985, 32 p.
24. Temperature conditions in the cold pool 1977-81: A comparison between southern New England and New York transects, by Steven K. Cook. February 1985, 22 p.
25. Parasitology and pathology of marine organisms of the world ocean, by William J. Hargis, Jr. (editor). March 1985, 135 p.
26. Synopsis of biological data on the sand perch, *Diplectrum formosum* (Pisces: Serranidae), by George H. Darcy. March 1985, 21 p.
27. Proceedings of the Eleventh U.S.-Japan Meeting on Aquaculture, Salmon Enhancement, Tokyo, Japan, October 19-20, 1982, by Carl J. Sindermann (editor). March 1985, 102 p.
28. Review of geographical stocks of tropical dolphins (*Stenella* spp. and *Delphinus delphis*) in the eastern Pacific, by William F. Perrin, Michael D. Scott, G. Jay Walker, and Virginia L. Cass. March 1985, 28 p.
29. Prevalence, intensity, longevity, and persistence of *Anisakis* sp. larvae and *Lacis-torhynchus tenuis* metacystodes in San Francisco striped bass, by Mike Moser, Judy A. Sakanari, Carol A. Reilly, and Jeannette Whipple. April 1985, 4 p.
30. Synopsis of biological data on the pink shrimp, *Pandalus borealis* Krøyer, 1838, by Sandra E. Shumway, Herbert C. Perkins, Daniel F. Schick, and Alden P. Stickney. May 1985, 57 p.
31. Shark catches from selected fisheries off the U.S. east coast, by Emory D. Anderson, John G. Casey, John J. Hoey, and W. N. Witzell. July 1985, 22 p.
32. Nutrient Distributions for Georges Bank and adjacent waters in 1979, by A. F. J. Draxler, A. Matte, R. Waldhauer, and J. E. O'Reilly. July 1985, 34 p.
33. Marine flora and fauna of the Northeastern United States. Echinodermata: Echinoidea, by D. Keith Serafy and F. Julian Fell. September 1985, 27 p.
34. Additions to a revision of the shark genus *Carcharhinus*: Synonymy of *Aprionodon* and *Hypoprion*, and description of a new species of *Carcharhinus* (Carcharhinidae), by J. A. F. Garrick. November 1985, 26 p.
35. Synoptic review of the literature on the Southern oyster drill *Thais haemastoma floridana*, by Philip A. Butler. November 1985, 9 p.

NOAA Technical Report NMFS 40

# The Potential Impact of Ocean Thermal Energy Conversion (OTEC) on Fisheries

Edward P. Myers  
Donald E. Hoss  
Walter M. Matsumoto  
David S. Peters  
Michael P. Seki  
Richard N. Uchida  
John D. Ditmars  
Robert A. Paddock

June 1986



U.S. DEPARTMENT OF COMMERCE  
Malcolm Baldrige, Secretary  
National Oceanic and Atmospheric Administration  
Anthony J. Calio, Administrator  
National Marine Fisheries Service  
William G. Gordon, Assistant Administrator for Fisheries

The National Marine Fisheries Service (NMFS) does not approve, recommend or endorse any proprietary product or proprietary material mentioned in this publication. No reference shall be made to NMFS, or to this publication furnished by NMFS, in any advertising or sales promotion which would indicate or imply that NMFS approves, recommends or endorses any proprietary product or proprietary material mentioned herein, or which has as its purpose an intent to cause directly or indirectly the advertised product to be used or purchased because of this NMFS publication.

# Contents

---

Introduction	1	The Potential Range of Ecological Effects Resulting from OTEC Operations	21
Background	2	Impingement	21
The OTEC Principle	2	Primary Entrainment of Plankton	21
Application	3	Secondary Entrainment	22
U.S. Legislation	3	Impacts on Fishery Food Chains	23
Estimated Operating Conditions for Initial U.S. OTEC Deployments	4	Potential Impact on Fisheries	23
General Site Characteristics	4	Measures to Reduce Potential Effects to Fisheries	24
Temperature, Salinity and Density Profiles	4	Cold Water Intake	25
Currents	4	Warm Water Intake	25
General Plant Characteristics	4	Discharge Location and Configuration	26
Type of Plant	4	Chemical Additions	27
Plant Capacity	4	Research Priorities	27
Plant Dimensions	4	Investigations on Fish Distribution	27
Power System		Studies on the Effects of Entrainment	27
Working Fluids	4	Biostimulation/Inhibition	27
Heat Exchangers	4	Early Life History Studies	27
Biofouling Control	7	Dynamics of Fishery Populations	28
Operating Efficiencies	7	Ciguatera	28
Seawater Systems		Construction Effects	28
Warm Water Intake	7	Conclusions	28
Cold Water Intake	7	References	29
Discharge	7		
Physical Interaction with the Environment	8		
Cold Water Intake	8		
Warm Water Intake	8		
Effluent Discharge	8		
Regional Influence	11		
Biological Interaction with the Environment	12		
Biological Characteristics of the Environment	12		
Location	12		
Phytoplankton	12		
Zooplankton	13		
Fisheries	14		
Eggs and Larvae of Important Species	15		
Other Important Biological Components	15		
Factors that may Affect Fish	16		
Attraction/Avoidance	16		
Impingement	17		
Primary Entrainment	18		
Temperature	18		
Pressure	19		
Chemical Additions	19		
Secondary Entrainment	20		
Ocean Water Mixing	20		



# The Potential Impact of Ocean Thermal Energy Conversion (OTEC) on Fisheries

EDWARD P. MYERS

*Ocean Minerals and Energy Division,  
Office of Ocean and Coastal Resource Management,  
National Ocean Service, NOAA,  
Page 1 Building, Room 105,  
2001 Wisconsin Avenue NW,  
Washington, D.C. 20235*

DONALD E. HOSS

DAVID S. PETERS  
*Southeast Fisheries Center,  
Beaufort Laboratory,  
National Marine Fisheries Service, NOAA,  
Beaufort, NC 28516-9722*

WALTER M. MATSUMOTO

MICHAEL P. SEKI  
RICHARD N. UCHIDA  
*Southwest Fisheries Center,  
Honolulu Laboratory,  
National Marine Fisheries Service, NOAA,  
2570 Dole Street,  
Honolulu, HI 96822-2396*

JOHN D. DITMARS

ROBERT A. PADDOCK  
*Energy and Environmental Systems Division  
Argonne National Laboratory  
Argonne, IL 60439*

## ABSTRACT

The commercial development of ocean thermal energy conversion (OTEC) operations will involve some environmental perturbations for which there is no precedent experience. The pumping of very large volumes of warm surface water and cold deep water and its subsequent discharge will result in the impingement, entrainment, and redistribution of biota. Additional stresses to biota will be caused by biocide usage and temperature depressions. However, the artificial upwelling of nutrients associated with the pumping of cold deep water, and the artificial reef created by an OTEC plant may have positive effects on the local environment.

Although more detailed information is needed to assess the net effect of an OTEC operation on fisheries, certain assumptions and calculations are made supporting the conclusion that the potential risk to fisheries is not significant enough to deter the early development of OTEC. It will be necessary to monitor a commercial-scale plant in order to remove many of the remaining uncertainties.

## INTRODUCTION

Under the Ocean Thermal Energy Conversion (OTEC) Act of 1980, the National Oceanic and Atmospheric Administration (NOAA) was given responsibility for licensing U.S. commercial OTEC operations and determining the potential environmental effects associated with this development and operation. NOAA (1982), in an environmental research plan required by the Act, identified two high-priority research areas that could be addressed with the available resources:

1. Determining the region of influence of an OTEC operation on mixing and redistribution of water masses, and
2. predicting the potential effects on fisheries.

Research in the first area has resulted in development of a model to predict the spatial scale and degree of perturbation to ocean waters (Wang 1984). This development responds to a direct licensing requirement of the Act and, in addition, has resulted in information useful in the determination of biological effects.

The second area, prediction of potential fishery effects, was considered a high priority because of the commercial and recreational value of fisheries and because of NOAA's responsibilities for fisheries through the National Marine Fisheries Service (NMFS). In fact, in its environmental research plan for OTEC, NOAA (1982) noted that the "Achilles heel," if any, to OTEC siting and operation could well be the effect on fisheries or other biologically important resources such as corals.

The concern over fisheries is primarily related to the entrainment and impingement that would result with the pumping of large volumes of seawater through an OTEC plant, the secondary entrainment caused by the discharge of OTEC waters, the use of biocides, and the redistribution of ocean properties (e.g., nutrients, trace metals, heat). The very presence of an OTEC structure might add to these factors due to the attraction or avoidance of fish and other biota to OTEC structures. There are other potential problems (NOAA 1981a), e.g., the leakage or spilling of working fluids to the environment, that are not discussed in any detail in this report. The report has focused on those problems associated with the normal everyday operating conditions of an OTEC plant.

NOAA believed that there was much information available that would be useful in making preliminary estimates of OTEC effects on fisheries. This includes information on the oceanographic characteristics of marine waters near potential OTEC sites, on the fates and effects of substances such as biocides, trace metals, and nutrients, and on other problem areas such as entrainment and impingement. Some of this available information is rather general, some site-specific, and some related to experiences from the operation of conventional and nuclear power plants.

A synthesis of pertinent information to assess the potential effects on fisheries was initiated in FY 1982 and culminated in this report. The effort focuses on the Caribbean and the North Pacific, since these are regions where U.S. OTEC interests have the greatest potential for development. It also emphasizes the nearshore application of OTEC more than the open-ocean case. The rationale for this emphasis is that at the present time there appears to be more interest in the nearshore application of OTEC, and there is definitely more reason for concern over the coastal areas as compared to the open ocean, at least during the early development of OTEC.

## BACKGROUND

### The OTEC Principle

Ocean thermal energy conversion (OTEC) is a renewable energy technology which produces power using a heat engine driven by the temperature difference between warm surface ocean waters and cold deep ocean waters (Gritton et al. 1980). The heat engine can take the form of a closed-cycle process (Fig. 1) which employs a working fluid (e.g., ammonia or Freon™) which is evaporated by warm seawater. The expanding gas drives a gas turbine, is then recondensed by cold seawater, and the process is repeated. The open-cycle process is quite similar to the closed-cycle process, with the exception that the warm seawater, acting as the working fluid, is flash-evaporated and the resulting vapor passed through a turbine. A big advantage of the open-cycle process is that the condensate can be used as a freshwater source.

There are several possible locations and construction strategies proposed for OTEC plants. The plants could be land-based, be mounted or moored on the continental shelf, or be open-ocean plantships (NOAA 1981a). A land-based plant would be constructed onshore with the needed warm-water, cold-water, and discharge pipes extending offshore to reach the desired intake and discharge conditions. A plant mounted on the continental shelf might be similar to an offshore oil rig. A moored plant would be a floating plant that is moored (anchored) to the seafloor. All of the above designs could be used to supply baseload electricity to existing electrical grids. A plantship, on the other hand, would be a ship equipped with an OTEC plant and could utilize suitable thermal resources wherever they existed. The power produced by a plantship could be used to produce energy-intensive products such as hydrogen, ammonia, and methanol (Francis and Dugger 1980; NOAA 1981a; Dugger et al. 1982; Avery et al. 1985).

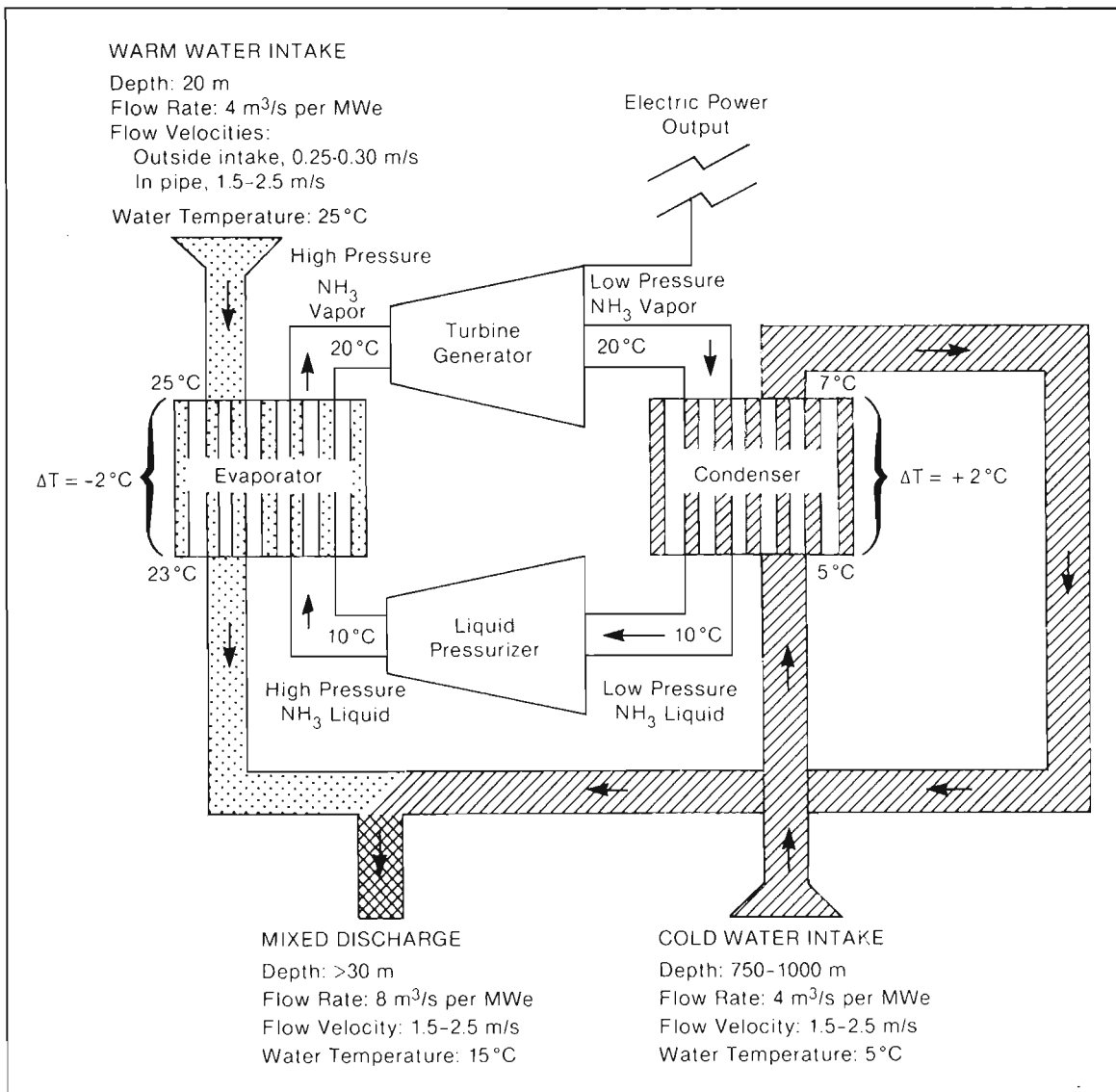

Figure 1.—Schematic diagram of a closed-cycle OTEC system. (adapted from U.S. Department of Energy 1979). (Note: Newer designs can achieve somewhat higher temperature changes across the heat exchangers with slightly less flows; Avery 1984).



## Application

A temperature difference of approximately 20°C is needed to make the OTEC process sufficiently efficient to be cost-effective (Myers and Ditmars 1985). Such temperature differences exist between the ocean surface and depths of about 1000 m in most coastal and open-ocean areas within about ±20° of the Equator, and in some areas outside of this band (United Nations 1981). These areas include approximately 70 developing nations with an adequate thermal resource (Table 1). Although temperature differences represent only one of the various forms of renewable ocean energies (e.g., biomass, waves, tides, currents, salinity gradients), it has been concluded that this form of ocean energy potential offers much promise by the year 2000 (United Nations 1981).

Countries that presently have an interest in developing OTEC technology include the United States, France, Japan, Sweden, and the Netherlands. The U.S. Department of Energy has supported design studies for a 40 megawatt-electric (MWe) pilot plant that would be located at Kahe Point, Oahu, Hawaii. During the conceptual design phase of this work, two closed-cycle designs were under development: An artificial island design by Ocean Thermal Corporation (OTC) (1983) that would be located about 550 m offshore, and a tower-mounted concept by General Electric (1983) to be located about 2200 m offshore. The OTC plant was chosen over that of General Electric for the second phase of the project—preliminary design. The OTC plant would utilize the thermal discharge from the Hawaiian Electric Company's (HECO) conventional power plant at Kahe Point to supplement the thermal resource of the ambient seawater. The intake of ambient warm water would

be near the surface at the plant with the intake of cold water further offshore at a depth of about 700 m. Both warm and cold waters, once used, would be discharged as a mixture at a depth of about 100 m.

The French government has been performing preliminary studies related to a 5-MWe prototype open-cycle plant in Tahiti. Japanese companies have designed, built, and operated a land-based closed-cycle 100-kWe plant for the island of Nauru in the North Pacific. Although this demonstration plant has been shut down, there are plans for a 2.5-MWe plant at the same site. Sweden's interest has principally been in building plants or components of plants and selling to developing countries. For instance, they have had discussions with Jamaica for a plant. Certain Dutch companies have similar interests.

## U.S. Legislation

Two legislative acts were passed by Congress in 1980 to facilitate the commercial development of OTEC: The Ocean Thermal Energy Conversion Research, Development, and Demonstration Act; and the Ocean Thermal Energy Conversion Act of 1980. The purpose of the OTEC Research, Development, and Demonstration Act (P.L. 96-310) is to accelerate OTEC **technology** development; the designated lead agency is the U.S. Department of Energy. The purpose of the OTEC Act of 1980 (P.L. 96-320) was to create a **legal regime** that would facilitate the commercialization of OTEC in a manner compatible with the protection of the marine environment and other marine resources; the lead agency is the National Oceanic and Atmospheric Administration.

Table 1. Some developing nations with adequate ocean thermal resources (after United Nations 1981)

Region/nation	Lat.	Long.	ΔT (°C) 0-1000 m	Distance from resource to shore (km)	Region/nation	Lat.	Long.	ΔT (°C) 0-1000 m	Distance from resource to shore (km)
<b>Africa</b>					<b>Latin America</b>				
Angola	6°S-18°S	11°E-14°E	18-22	65	Bahamas	25°N	77°W-79°W	20-22	15
Benin	6°N	3°E-4°E	22-24	50	Barbados	13°N	58°W-60°W	22	1-10
Congo	4°S-5°S	22°E-12°E	20-22	50	Belize	16°N-17°N	87°W-88°W	22	50
Gabon	2°N-4°S	9°E-22°E	20-22	50	Brazil	4°N-32°S	35°W-55°W	20-24	75
Ghana	5°N-6°N	3°W-1°E	22-24	50	Colombia	2°N-12°N	63°W-79°W	20-22	50
Guinea	9°N-11°N	24°W-15°W	20-22	80	Costa Rica	8°N-12°N	83°W-85°W	21-22	50
Guinea-Bissau	11°N-13°N	15°W-17°W	18-19	60	Cuba	20°N-23°N	75°W-85°W	22-24	1
Ivory Coast	5°N	3°W-8°W	22-24	30	Dominica	15°N-16°N	61°W-62°W	22	1-10
Kenya	2°S-5°S	34°E-41°E	20-21	25	Dominican Republic	18°N-20°N	68°W-72°W	21-24	1
Liberia	5°N-17°N	8°W-23°W	22-24	65	Ecuador	2°N-4°S	79°W-81°W	18-20	50
Madagascar	10°S-25°S	45°E-50°E	18-21	65	El Salvador	13°N-14°N	87°W-90°W	22	65
Mozambique	20°S-25°S	35°E-40°E	18-21	25	French Guiana	4°N-5°N	50°W-52°W	22-24	130
Nigeria	4°N-6°N	4°E-9°E	22-24	30	Grenada	13°N	61°W-62°W	27	1-10
Rio Muni	2°N-3°N	10°E	20-22	30	Guatemala	14°N-17°N	88°W-94°W	22	65
Sao Tome and Principe	0°N-2°N	7°E-9°E	22	1-10	Guyana	5°N-8°N	58°W-60°W	22-24	130
Senegal	13°N-17°N	16°W-17°W	18	50	Haiti	18°N-20°N	72°W-75°W	21-24	1
Sierra Leone	7°N-9°N	12°W-14°W	20-22	100	Honduras	14°N-16°N	83°W-88°W	22	65
Somalia	10°N-2°S	41°E-50°E	18-20	25	Jamaica	18°N-19°N	76°W-78°W	22	1-10
Togo	6°N	2°E-3°E	22-24	50	Lesser Antilles	12°N-18°N	61°W-65°W	22-24	1
United Republic of Cameroon	3°N-4°N	9°E-10°E	22-24	65	Mexico	17°N-22°N	104°W-108°W	20-22	32
United Republic of Tanzania	5°S-10°S	35°E-40°E	20-22	25	Nicaragua	11°N-14°N	84°W-86°W	22	65
Zaire	5°S-6°S	12°E	20-22	50	Panama	8°N-9°N	76°W-83°W	21-22	50
					St. Lucia	13°N-14°N	61°W-62°W	22	1-10
					St. Vincent and the Grenadines	13°N-14°N	61°W-62°W	22	1-10
					Suriname	4°N-5°N	52°W-58°W	22-24	130
					Trinidad and Tobago	11°N	61°W	22-24	10
					Venezuela	8°N-12°W	60°W-73°W	22-24	50
					U.S. Virgin Islands	18°N	65°W	21-24	1

Under its responsibilities of the OTEC Act of 1980, NOAA has issued regulations for licensing commercial OTEC plants (NOAA 1981b), an environmental impact statement on the licensing of commercial plants (NOAA 1981a), a technical guidance document on the environmental requirements of the regulations (NOAA 1981c), and a research plan for assessing environmental effects that may accompany the commercialization of OTEC (NOAA 1982).

## ESTIMATED OPERATING CONDITIONS FOR INITIAL U.S. OTEC DEPLOYMENTS

---

This chapter presents preliminary estimates of site characteristics and operating conditions for early OTEC developments. Two areas are so characterized because of the interest for OTEC in these areas: The western coast of Oahu, Hawaii, in the vicinity of Kahe Point (Fig. 2); and the southeastern coast of Puerto Rico in the vicinity of Punta Tuna (Fig. 3). Both near/onshore and open-ocean sites near Oahu and Puerto Rico are considered in the following description which is primarily based on an evaluation of information presented by BATHEN (1975, 1977, 1978), EG&G (1980), MILLER (1977), NODA et al. (1980), OCEAN DATA SYSTEMS, INC. (1977a,b), and WOLFF (1978).

### General Site Characteristics

**Temperature, Salinity, and Density Profiles**—In the vicinity of Kahe Point, Oahu, Hawaii, the probable surface temperature varies from 24.1°C in late winter to 26.9°C in midsummer. The likely range of surface temperatures is generally within 1.2°C of these probable values. At a depth of 700 m the probable temperature varies from 5.2 to 5.5°C. At a depth of 1000 m the temperature is about 4.2°C with very little variation. The thickness of the mixed layer typically varies from as little as 10 m to as much as 180 m; however, the probable thickness of the surface mixed layer varies from 40 to 100 m, being deepest during the winter and shallowest in the summer. The average nearsurface salinity is about 34.8 ppt and increases to about 35.1 ppt at the bottom of the surface waters (a depth of 100-125 m), and then decreases again to about 34.1 ppt at a depth of about 450 m. The density profile is dominated by temperature, but salinity variation has some effect due to the salinity maximum occurring near the thermocline (just below the bottom of the surface mixed layer).

In the vicinity of southeastern Puerto Rico the probable surface temperature varies from 26.2°C in winter to 29.2°C late summer and early fall. The likely range of surface temperatures is generally within  $\pm 2.3^\circ\text{C}$  during spring and fall. At a depth of 700 m the probable temperature is 7.9-8.2°C. At a depth of 1000 m the temperature is about 5.3°C with very little variation. The thickness of the mixed layer typically varies from as little as 10 m to as much as 140 m; however, the probable thickness of the surface mixed layer varies from 40 to 100 m, being deeper during the winter and shallower in the summer. The nearsurface salinity is about 35-36 ppt and increases to a maximum of about 36.7 ppt at a depth of 100-125 m. The salinity minimum is about 35 ppt at a depth of 700-900 m.

**Currents**—The ocean currents near Kahe Point, Oahu, Hawaii, are fairly complex, being a combination of tidal (i.e., depth-averaged, shelf) currents, geostrophic (i.e., upper water column of deep water)

flow, and wind-driven (i.e., surface) currents. The tidal current has both a semidiurnal and a diurnal component. The flood-tide is basically parallel to the shore, flowing in the south-southeast direction. The maximum semidiurnal component of the current is about 20-30 cm/s while the diurnal component is 10-20 cm/s. The geostrophic flow is highly variable and can exceed 60 cm/s in larger eddies, although near Kahe Point currents on the order of 15-25 cm/s are more typical. The magnitude of wind-driven currents (i.e., surface) depends on the wind strength, but values of 9-10 cm/s are typical. Wind-driven currents tend to be shore-parallel near Kahe Point.

The currents discussed above are highly variable in magnitude and direction. The mean flow near Kahe Point is difficult to determine but is estimated to be on the order of or less than 10 cm/s. In shallower areas nearshore, this flow tends to be more shore-parallel. The net flow of the surface waters in the vicinity of Hawaii tends to be westward, being part of the North Pacific Equatorial Current.

Ocean currents in the vicinity of southeastern Puerto Rico are generally westward flowing due to the South Atlantic Drift, which is driven by the North Atlantic Trades. The currents tend to follow the bathymetric contours (and thus tend to be shore-parallel) but are highly variable. The mean current is typically 10-40 cm/s in the deep offshore waters (< 1000 m deep) and slightly higher (60 cm/s) nearshore.

### General Plant Characteristics

**Type of Plant**—The first OTEC plants are expected to be of the closed-cycle type using ammonia as the working fluid. Smaller plants (of the pilot-plant scale) will probably be located on or nearshore or on bottom-mounted towers in about 100 m of water. Larger plants (of commercial scale) will likely be either on bottom-mounted towers or offshore in the form of moored floating plants or free-floating plantships.

**Plant Capacity**—OTEC plants are expected to be made up of multiple units which can operate independently. A typical pilot plant might be made up of four to six 10-MWe units, while eventually ten to twenty 25-MWe units might be typical for commercial plants (W. H. Avery, Director, Ocean Energy Programs, Johns Hopkins Univ. Appl. Physics Lab., Laurel, MD, pers. commun. 1984).

**Plant Dimensions**—Pilot plants located on or nearshore where space is not particularly limited will have horizontal dimensions on the order of 100 m. Bottom-mounted plants (on towers) will make use of the space along the vertical extent of the tower and thus will have horizontal dimensions on the order of 50 m. Larger plants (commercial scale) in the open ocean are expected to be 100-150 m in diameter for cylindrically symmetric designs and 50-75 m wide  $\times$  150-200 m long for ship or barge type designs.

### Power System

**Working Fluids**—Most designs for first-generation OTEC plants specify ammonia as the working fluid. Other fluids that have been considered are noted in Table 2.

**Heat Exchangers**—Initially heat exchangers will be of aluminum or titanium but eventually other materials may be used. Designs

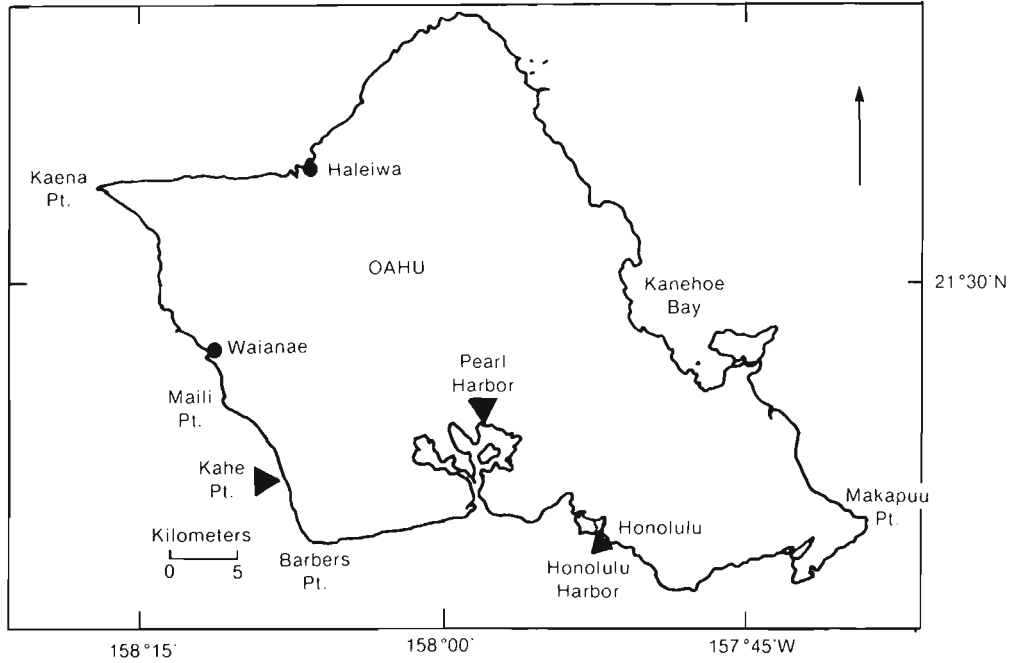

Figure 2.—The Kahe Point area, Oahu, Hawaii.

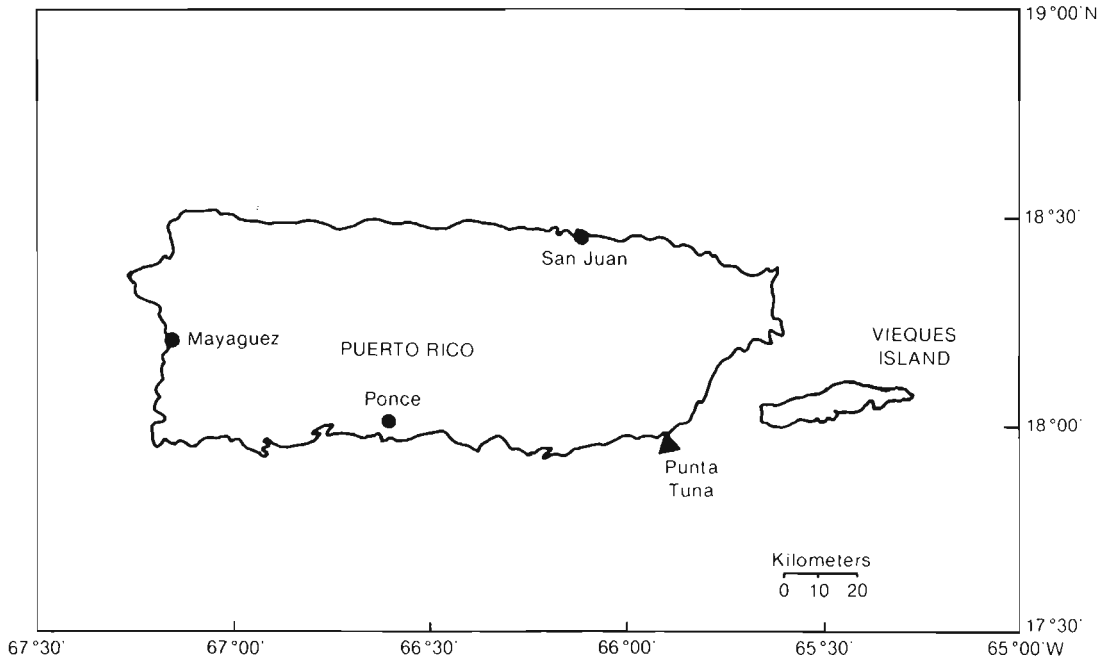

Figure 3.—The Punta Tuna area, Puerto Rico.

Table 2.—Characteristics of some candidate OTEC working fluids.

Fluid	Physical state*† (20°C)	Clean Water Act (1977) standing	Water solubility*† (in 100 ml H <sub>2</sub> O)	Flammability**	Explosion hazard**	Disaster hazard	OSHA <sup>c</sup> 8-h exposure limits†† (ppm)	Human toxicity** <sup>d</sup>	Carcinogenicity**
Ammonia	Gas	Hazardous substance	90 g (0°C)	671°C <sup>a</sup>	Moderate (when exposed to flame)	Moderately dangerous (emits toxic fumes when exposed to heat)	50	High	None
Freon™ 22	Gas	Not regulated	Insoluble	632°C <sup>a</sup>	No data	Dangerous (emits highly toxic fumes when heated to decomposition or on contact with acid or acrid fumes) Atmospheric release may contribute to potential degradation of the ozone layer.	No data	Low	None
Freon™ 11	Liquid	Not regulated	Insoluble	No data	Reacts violently with molten aluminum	Dangerous (emits highly toxic fumes of fluorides and chlorides when heated to decomposition) Atmospheric release may contribute to potential degradation of the ozone layer.	No data	Low	None
Methyl chloride	Gas	Toxic pollutant	400 g	632°C <sup>a</sup> <0°C <sup>b</sup>	Moderate (Reacts violently with aluminum)	Dangerous (emits highly toxic fumes when heated to decomposition; reacts vigorously with oxidizing materials)	100	Moderate	None
Methylene chloride	Liquid	Toxic pollutant	2 g (20°C)	615°C <sup>a</sup>	None under ordinary conditions	Dangerous (emits highly toxic fumes when heated to decomposition)	500	Moderate	None
Nitrogen dioxide	Gas	Hazardous substance	7 g (0°C)	No data	Reacts violently with aluminum	Dangerous (emits highly toxic fumes when heated to decomposition, reacts with water or steam to produce heat and corrosive fumes)	5	High	None
Methyl formate	Liquid	Not regulated	30 g (20°C)	465°C <sup>a</sup> -2°C <sup>b</sup>	Moderate (when exposed to heat or flame)	Dangerous (emits toxic fumes when exposed to heat or flame; reacts vigorously with oxidizing materials)	100	Moderate	None
Methyl amine	Gas	Not regulated	807 g (12°C)	430°C <sup>a</sup> 0°C <sup>b</sup>	Moderate (when exposed to spark or flame)	Dangerous (reacts vigorously with oxidizing materials)	10	Moderate	None
Ethyl amine	Liquid	Not regulated	Soluble	385°C <sup>a</sup> < -17°C <sup>b</sup>	No data	Dangerous (reacts vigorously with oxidizing materials)	10	High	None

<sup>a</sup>Autoignition temperature

<sup>b</sup>Flash point

<sup>c</sup>Occupational Safety and Health Administration

<sup>d</sup>Low - causes readily reversible tissue changes which disappear after exposure ceases.

Moderate - may cause reversible or irreversible changes to exposed tissue, no permanent injury or death.

High - capable of causing death or permanent injury in normal use; poisonous

SOURCES: \* P. Holtzclaw, U.S. EPA, 401 M St. SW, Wash., D.C., pers. commun. 1981.

† Hodgman, 1959

\*\* Sax, 1979

†† United States Department of Labor, 1972

suitable for OTEC applications involving tube-in-shell, plate types, and folded tube heat exchangers have been successfully tested at small scale under OTEC conditions (Avery, pers. commun. 1984).

**Biofouling Control**—Most designs will use periodic (daily) chlorination for biofouling control. Some designs also plan to use mechanical cleaning methods, such as Amertap™ balls or M.A.N.™ brushes, in conjunction with chlorination. The dose of chlorine needed to prevent biofouling will be somewhat dependent on site-specific characteristics; however, recent studies suggest doses on the order of 0.07 mg/L (70 ppb) injected 1 hour/day may be sufficient (Larsen-Basse and Daniel 1983).

**Operating Efficiencies**—Overall thermal operating efficiencies for most OTEC plants are expected to be in the 2-3% range. However, certain pilot-plant designs use larger than normal warm-water flow rates to take advantage of less expensive heat exchangers. Such designs will have efficiencies in the 1.0-1.5% range.

The thermal efficiency is the fraction (usually expressed as a percent) of the heat energy extracted from the warm water that is converted into net electrical energy. For normal OTEC operating temperatures, this efficiency is limited to 6.0-7.5% by the basic laws of thermodynamics. Therefore, a more useful quantity might be the “effectiveness” of the plant which is the ratio of the net electrical power available for external use to the gross power produced by the turbo-generator system. This ratio is 65 to 75% for typical designs (increases rapidly with  $\Delta T$ ) and may fall to 35% for shore-based sites where the needed cold-water pipe lengths require higher pumping power (Avery, pers. commun. 1984).

## Seawater Systems

### Warm Water Intake

**Depth and location**—The warm-water intake will be located in the upper part of the surface mixed layer of the ocean to take advantage of the warmest water available. Intakes for pilot plants will be about 10 m deep, while intakes for larger commercial plants will have to be about 20 m deep due to the larger intake flow-rate requirements.

**Shape and orientation**—The intake structure will generally be constructed to produce horizontal flows external to the structure because it appears that fish can sense and avoid horizontal flows better than vertical flows (see Impingement section). The structure will also be much larger in the horizontal direction than in the vertical direction to keep intake velocities low and yet keep the structure near-surface where the warmest water is located.

**Flow rates and intake velocities**—Typical warm-water flow rates for OTEC designs are in the range of 3-5  $\text{m}^3 \cdot \text{s}^{-1} \cdot \text{MWe}^{-1}$ . However, flow rates as high as 8.5  $\text{m}^3 \cdot \text{s}^{-1} \cdot \text{MWe}^{-1}$  are proposed for plants intending to trade larger flow rates for less expensive heat exchangers. Flow velocities in the warm-water pipes and conduits will generally be in the 1.5-2.5 m/s range, but intakes are expected to be designed to reduce the velocity to 0.25-0.30 m/s outside the intake structure. The low intake velocities can lead to rather large intake area requirements for large (100-MWe) plants.

### Cold Water Intake

**Depth and location**—The cold-water intake for most OTEC designs will be at the end of a long pipe extending to a depth of 750-1000 m. The selection of the depth at which the cold water will be withdrawn is the result of a trade-off between the efficiency gained by colder temperatures and the added expense of constructing and operating a longer cold-water pipe.

**Shape and orientation**—Because the cold-water intake will be located in an area of low biological activity, little effort has gone into design of the intake structure; most likely, it will be an open-ended pipe with bar screens placed to keep out relatively large objects.

**Flow rates and intake velocity**—Typical OTEC designs call for cold-water flow rates comparable to the warm-water flow rate, in the range of 3-5  $\text{m}^3 \cdot \text{s}^{-1} \cdot \text{MWe}^{-1}$ . However, some designs try to reduce the cold-water requirements because of the expense of obtaining water from such depths. Flow velocities in the cold-water pipe will generally be in the 1.5-2.5 m/s range. Intake velocities may be of this same order because it is generally thought that there is no need to reduce the intake velocity at the great depths involved. However, lower intake velocities can be achieved, if needed, by use of a flared pipe section. Ocean Thermal Corporation will use such a section to reduce the cold-water intake speed to 0.3 m/s for the Kahe Point design.

### Discharge

**Depth and location**—Most OTEC designs will try to locate the discharge so as to reduce the potential for recirculation of effluent into the warm-water intake. Although this may be accomplished through either separate or mixed effluent discharges, most designs depend on the density of the effluent being greater than the density within the mixed layer so that the effluent will come to equilibrium near the bottom of the mixed layer, out of the influence of the intake. For nearshore plants this may involve the use of a discharge pipe leading offshore. In deeper waters it is anticipated that the discharge will generally be located at a depth of 30 m or greater to avoid recirculation.

It is expected that the temperature of the warm water and cold water will decrease about 2-3°C during passage through the heat exchangers. For representative warm and cold waters of 25°C and 5°C, respectively, temperatures of separate warm and cold discharges would then be about 22-23°C and 7-8°C, respectively. For this situation, a mixed discharge would have a temperature near 15°C.

**Shape and orientation**—Most proposed designs do not involve the use of any special discharge structures such as multiport diffusers (see Effluent Discharge section). Thus, the discharges will be from open-ended round pipes directed either downward or horizontally (often with a downward component).

**Flow rates and discharge velocity**—Discharge flow rates must equal intake flow rates due to continuity. Typically, discharge velocities will be in the 1.5-2.5 m/s range.

## PHYSICAL INTERACTION WITH THE ENVIRONMENT

The presence of an OTEC plant will cause a physical interaction with the marine environment. However, with the exception of some small modification of water movement in the immediate vicinity of a plant, the principal physical interaction will be due to the intake and discharge of the relatively large volumes of water needed for an OTEC operation. These topics are discussed in this section since they are so important to the definition of biological interaction taken up in the later section on Biological Interaction.

### Cold Water Intake

The cold water intake provides the cold water needed for the condensing part of the OTEC cycle. Given a certain surface temperature, a cold water pipe (CWP) will have to be extended deep enough to obtain cold water at a temperature low enough to assure a temperature difference ( $\Delta T$ ) of about 20°C. Certain engineering constraints will be present, however, in obtaining the cold water, e.g., the large pipe diameters and depths required for bottom-mounted pipe installations both exceed the demonstrated capability of the offshore pipe laying industry (Brewer 1979). However, it is believed that these problems may be overcome with a minimum extension of present technology. The CWP may either be

1. emplaced on a shelf, extending to the needed depth for a land-based OTEC plant;
2. placed vertically within the structure of a shelf-sitting tower to the needed depth, or to the seabed and then extended on the shelf to the needed depth; or
3. placed vertically to the required depth beneath an open ocean plantship.

To obtain a  $\Delta T$  of about 20°C, the CWP intake will need to be located at a depth of about 800-1000 m in most locations. At this depth the induced flow will not interact with other intake and discharge flow fields, and the interaction with the environment will depend primarily on the volumetric flow rate (Paddock and Ditmars 1983). Therefore, the intake depth, volumetric withdrawal rate, and velocity are the three principal variables that will define the interaction.

### Warm Water Intake

Like the need for cold water, a relatively large volumetric rate of warm water is needed for the evaporation part of the OTEC cycle (see section on Flow Rates and Intake Velocities).

In general, the warm water intake will draw water from a range of depths, dependent upon the ambient density stratification in the vicinity of the intake, the flow rate at which water is withdrawn, and the size and shape of the intake structure (Paddock and Ditmars 1983). The volumetric flow rate at which water will be withdrawn will depend, among other factors, on thermodynamic needs of the power cycle and the efficiencies of the heat exchangers. Once the volumetric flow rate is established, however, a trade-off is involved between the intake dimension and the velocity of the flow—the less the intake dimensions, the greater the intake velocity and vice versa. For example, consider the intake of 140 m<sup>3</sup>/s of warm water for a 40-MWe OTEC plant (i.e., 3.5 m<sup>3</sup>·s<sup>-1</sup>·MWe<sup>-1</sup>). Using an intake pipe of 34 m diameter would result in an intake velocity of 15 cm/s, whereas an intake pipe of 17 m would impart an intake

velocity of 62 cm/s. Using an intake pipe of 10 m diameter would result in an intake velocity of 178 cm/s for which the power loss due to friction would be small, whereas an intake diameter of 5 m would entail a velocity of 713 cm/s which would cause an unacceptable friction loss (Avery, pers. commun. 1984).

The effect of the warm water intake on the flow field in the vicinity of the intake structure will also be dependent upon a number of factors. To provide an idea of the possibilities, three induced flow patterns are indicated in Figure 4 for three simplified hypothetical intake situations:

1. Intake flow field in the presence of an ambient current for an intake distributed uniformly over the mixed layer where the density is constant above and below a strong thermocline (Fig. 4a);
2. intake flow field in the presence of an ambient current for a point intake within the mixed layer, again where the density is constant above and below the thermocline (Fig. 4b); and
3. intake flow field for a point intake in a stagnant, linearly stratified environment (Fig. 4c).

These hypothetical scenarios provide an indication of the variety of cases that will determine where seawater and organisms are withdrawn. The quantification of the pertinent variables for such cases has been discussed by Paddock and Ditmars (1983).

Most ocean environments exhibit some variations of seawater density with depth (i.e., density stratification) such as shown in Figures 5 and 6 for Kahe Point and Punta Tuna, respectively. In the case of intake withdrawal from a density-stratified environment, selective withdrawal occurs. Selective withdrawal involves the flow of water from discrete layers centered about the elevation of the intake as shown in Figure 4c. The thickness of the layer withdrawn ( $\sigma$ ) is inversely proportional to the degree of stratification, so that thinner layers will be withdrawn when strong stratification is present.

### Effluent Discharge

The discharge of used warm and cold OTEC waters may be either separate or mixed. Additionally, a discharge could be through a single discharge pipe, through a number of discharge pipes if the dimensions of a single discharge structure became unrealistic, or through a multiple port diffuser. Multiple port diffusers are commonly used for the discharge of municipal waste to ocean waters (Koh 1983) and have been considered in hydraulic studies of OTEC discharges. Although multiple port diffusers could ensure a greater degree of dilution of an OTEC effluent, it is not obvious that this is the desired objective, as discussed below. Furthermore, problems with construction, head losses, and additional pump requirements might outweigh possible advantages of a multiple port diffuser, to say nothing of additional biological concerns over the greater volume of dilution water needed.

A separate discharge scheme would involve separate discharges for both the warm and cold waters, whereas a mixed discharge scheme would utilize the same discharge structure for both water types. Although the initial physical fates of the discharged water would vary according to the scheme employed, the physics that define these fates are the same for both cases and relate to the behavior of buoyant discharges.

The behavior of positively or negatively buoyant discharges has been studied analytically as well as through the use of physical models. Initially these studies were conducted to evaluate the behavior of cooling water discharges from conventional power plants and of effluents from sewage outfalls; recently such studies have

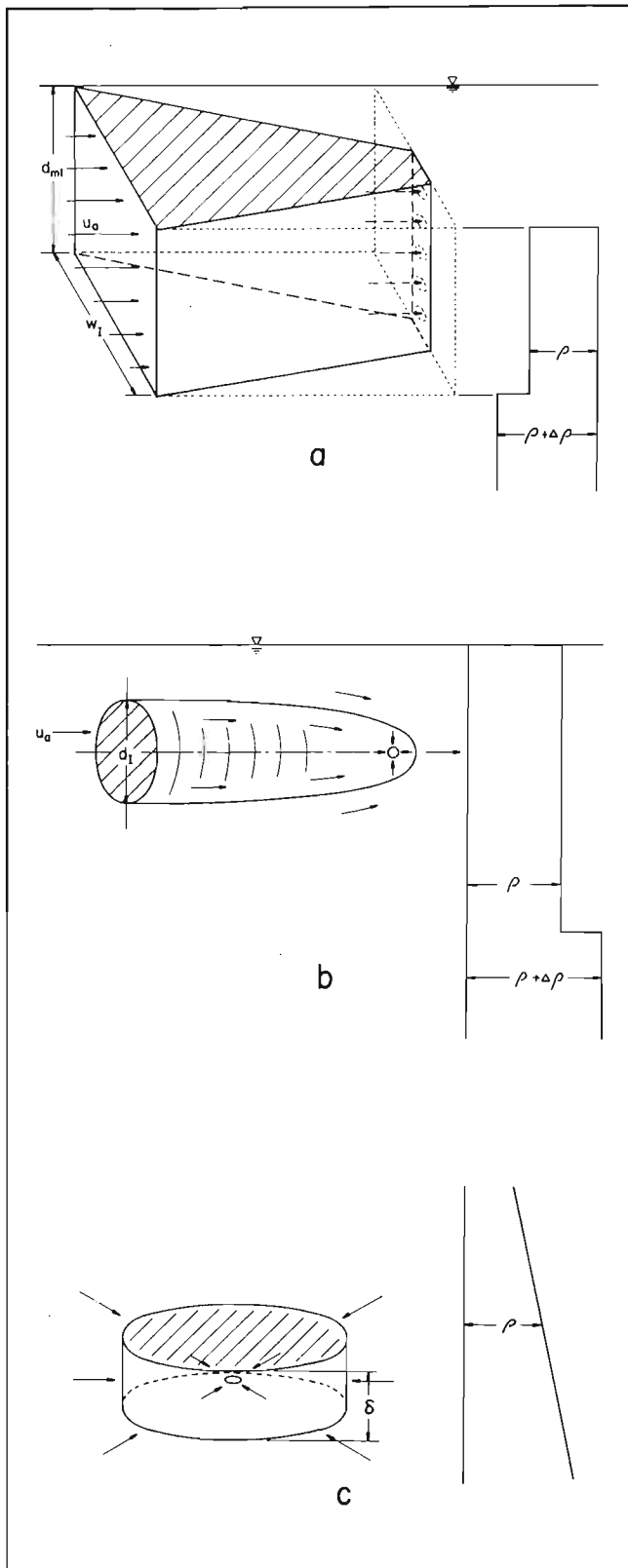

Figure 4.—a. Schematic of the intake flow field in the presence of an ambient current for an intake distributed uniformly over the mixed layer (from Paddock and Ditmars 1983). b. Schematic of the intake flow field in the presence of an ambient current for a point intake within the mixed layer (from Paddock and Ditmars 1983). c. Schematic of the intake flow field for a point intake in a stagnant, linearly-stratified environment (from Paddock and Ditmars 1983).

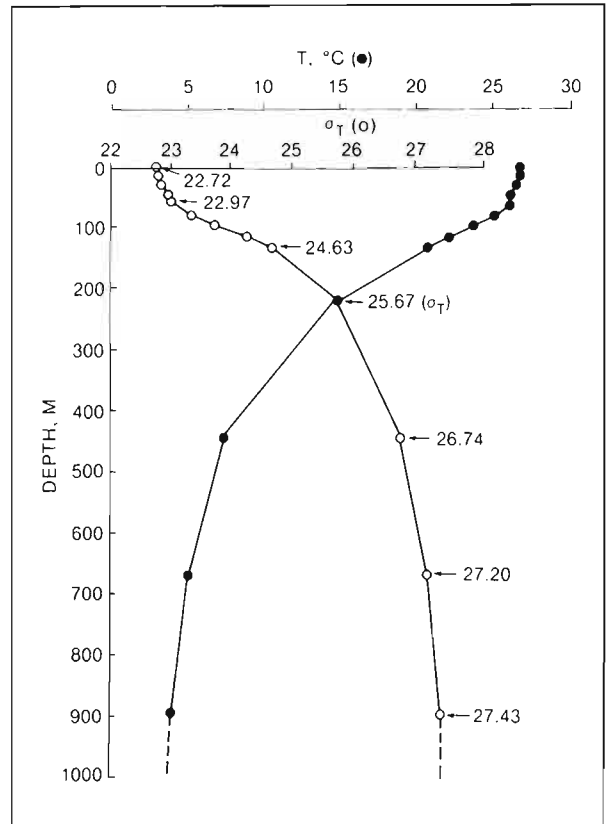

Figure 5.—One temperature and density profile offshore Kahe Point, Oahu, Hawaii (from Noda et al. 1981a; site 1, cast 1, 6 November 1980).

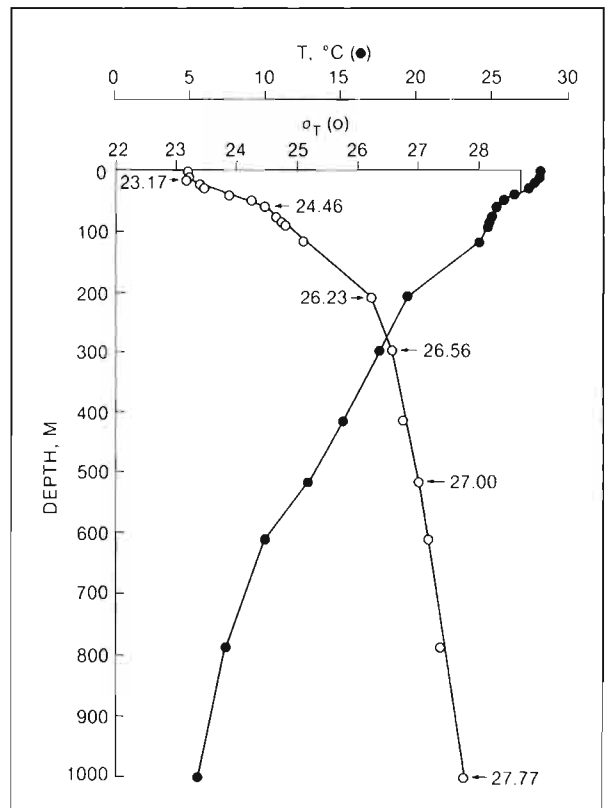

Figure 6.—One temperature and density profile offshore Punta Tuna, Puerto Rico (from Vargo et al. 1981; daycast, PROTEC-13).

been applied to OTEC discharges (Allender et al. 1978; Ditmars 1979; Ditmars and Paddock 1979). Although details of such assessments may be quite complex and dependent upon site-specific factors, generalities can be made for certain simplified situations (Paddock and Ditmars 1983). As discussed by Paddock and Ditmars, different phenomena govern the different regions of the flow that develop, termed the near-field, intermediate-field, and far-field (Figs. 7, 8). Momentum and buoyancy dominate in the near-field, gravity and interfacial shear in the intermediate field, and advective and dispersive mechanisms in the far field.

The important parameters about the near-field region are primarily the depth where the discharge plume reaches neutral buoyancy (equilibrium depth), the average dilution achieved by the discharge plume upon reaching the equilibrium depth (initial dilution), and the trajectory from the point of discharge to the equilibrium depth. Paddock and Ditmars (1983) present methods for quickly estimating these parameters for simplified situations. As an example, consider the discharge from 40-MWe hypothetical OTEC plants located off-shore of (1) Kahe Point, Oahu, Hawaii, and (2) Punta Tuna, Puerto Rico. The plants pump 140 m<sup>3</sup>/s of both cold and warm water for a total flow and discharge of 280 m<sup>3</sup>/s. Four cases are considered to give an indication of the range of behavior that might be expected:

1. Separate horizontal round discharges to nearsurface waters (20 m);
2. separate horizontal round discharges at depth (100 m);
3. mixed horizontal round discharge to nearsurface waters (20 m); and
4. mixed horizontal round discharge at depth (100 m).

For all four cases, it is assumed that stagnant conditions prevail, the density profiles of Figures 5 and 6 apply, and the intake waters are from 20 m and 1000 m with the following ambient properties:

	Temp. (°C)	Salinity (ppt)	$\sigma_t$
Kahe Point			
Warm Water	26.6	34.9	22.8
Cold Water	3.8	34.5	27.4
Punta Tuna			
Warm water	27.7	36.0	23.3
Cold Water	5.4	35.2	27.8

It is also assumed that the warm water will undergo a temperature drop of 2°C and that the cold water will undergo a temperature increase of 2°C. Based on tables of seawater density in Fischer et al. (1979), these temperature changes would produce sigma-t's ( $\sigma_t$ ) of approximately 23.4 for the warm water side and 27.2 for the cold water side at Kahe Point, and 23.9 for the warm water side and 27.5 for the cold water side at Punta Tuna. All discharges are made through 10-m diameter pipes, whether separate or mixed. For the case of mixed discharges, the discharge velocity is kept constant at 1.8 m/s by using two 10-m diameter pipes. It is assumed that the discharges do not interfere with each other. Using the approximation methods of Paddock and Ditmars (1983) leads to the following results.

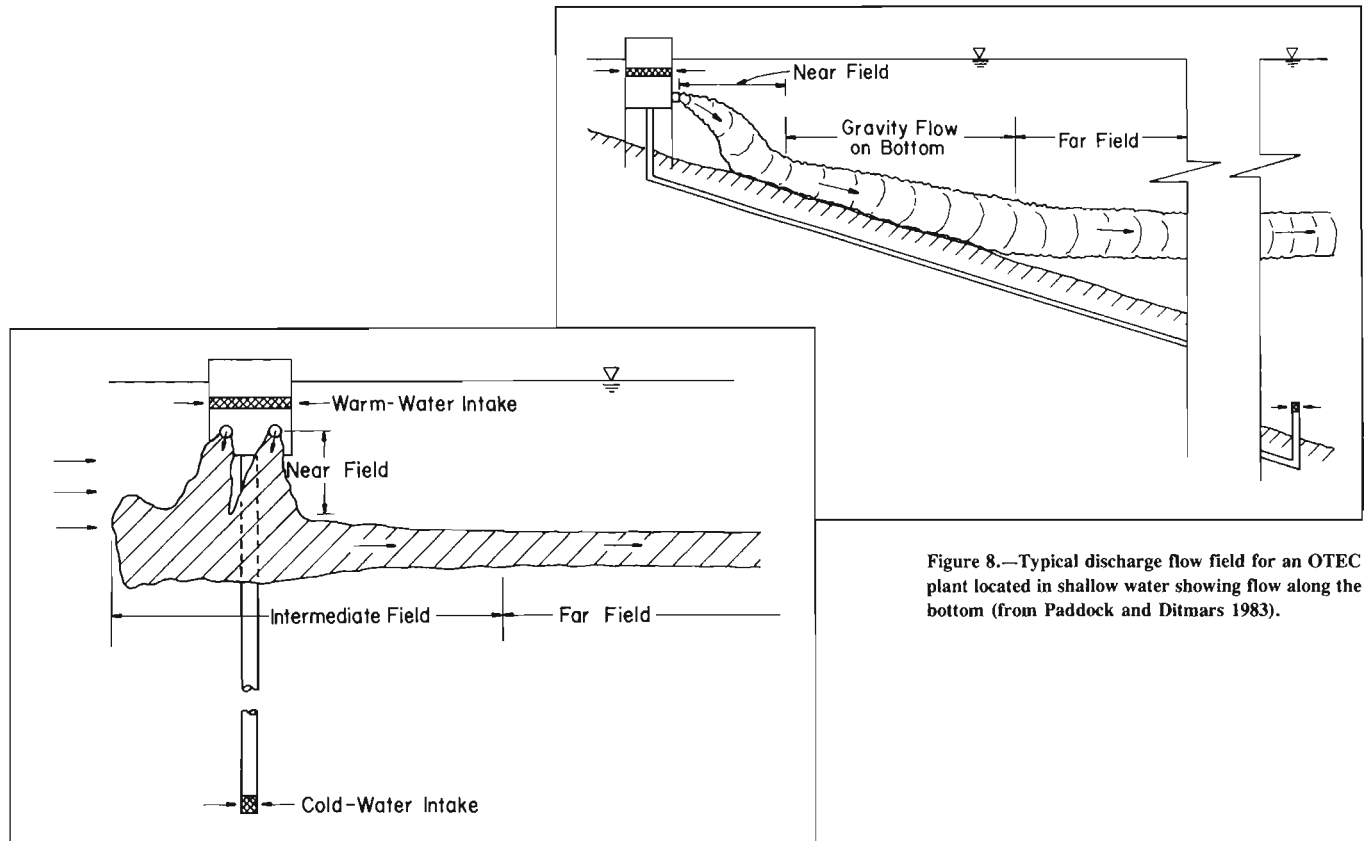

Figure 7.—Typical discharge flow field for an OTEC plant located in deep water (from Paddock and Ditmars 1983).

Figure 8.—Typical discharge flow field for an OTEC plant located in shallow water showing flow along the bottom (from Paddock and Ditmars 1983).



	Discharge	Level of neutral buoyancy, m	Dilution
<b>Kahe Point</b>			
Separate to nearsurface (20 m)	Warm	50	6.5
	Cold	80	7
Separate to depth (100 m)	Warm	95	4
	Cold	145	6
Mixed to nearsurface (20 m)	Mixed	75	6.5
Mixed at depth (100 m)	Mixed	120	4.5
<b>Punta Tuna:</b>			
Separate to nearsurface (20 m)	Warm	30	4
	Cold	55	5.5
Separate to depth (100 m)	Warm	75	5
	Cold	160	7
Mixed to nearsurface (20 m)	Mixed	45	4.5
Mixed at depth (100 m)	Mixed	115	5

Although the above results are only rough approximations, they provide insights that are useful for defining physical interaction with the environment. In general, it can be seen that initial dilution for OTEC discharges will be in the range of about 1 to 10. The strong effect of density stratification is also apparent and suggests that wherever an OTEC discharge plume encounters a strong density gradient, its further vertical motion will be limited. Not only do strong density gradients arrest a plume's trajectory, they also limit the amount of dilution that can be achieved. The presence of currents would act to lengthen the trajectory of the discharge plume and increase the dilution achieved; accordingly, the depth of neutral buoyancy of an effluent plume might be somewhat less for a negatively buoyant discharge.

## Regional Influence

Using approximation methods discussed by Paddock and Ditmars (1983), it can be shown that the above initial dilutions and levels of neutral buoyancy will occur in a time frame on the order of a minute. Referring back to Figures 7 and 8, it can then be inferred that the intermediate and far field processes will have a greater influence on regional environmental impacts. Examining a hypothetical 40-MWe OTEC plant in typical tropical ocean conditions, Jirka et al. (1980) analyzed the spreading of a mixed discharge plume in a density stratified environment. The results indicated the effluent plume to be about 10 m thick and 5 km wide. This size is comparable with island shelf areas and warrants an analysis of the regional environmental influence of even a small OTEC plant.

Aware that the regional influence of an OTEC operation could be considerable, NOAA initiated a research effort in 1982 with Argonne National Laboratory to develop a model that could define this influence. To come to an understanding of the influence, a description was needed of the physical processes associated with the discharge of large volumes of water into the upper ocean by OTEC plant operations. The approach taken departed from previous mathematical modeling investigations of OTEC plant interactions with the ocean environment. In previous modeling, effluent plumes and intake flows have been superimposed on fixed ambient ocean waters; that is, no attempt was made to model changes in the ocean resulting from their presence. The Argonne model simulates the

interaction of an OTEC discharge with the ocean, thereby permitting discharge-induced modifications to the ambient ocean to be determined. Changes in ambient circulation, temperature structure, and concentration of effluent and water column constituents are modeled. The general approach was to modify an existing three-dimensional model for limited-area coastal regions (Wang 1982) by incorporating simulations of the effluent flows due to an OTEC operation. The effect of the intake flow was found to be minimal and thus is not included in the model.

The Argonne model was applied to a base case of a 280 m<sup>3</sup>/s mixed discharge from a 40-MWe OTEC plant into coastal waters for various ambient ocean conditions, and then was used to examine the effect of two nearby 40-MWe plants and that of an 80-MWe plant. Applied to the case of a mixed discharge from a 40-MWe OTEC plant located in deep water on a coastal margin, the Argonne model indicated the effluent plume will be confined mostly to the top of the thermocline. In the case of an ambient alongshore current of 20 cm/s, the addition of a conservative dye to the discharge indicated the effluent plume to be about 20 m thick, 2 km wide, and 4 km long (Fig. 9), and diluted by a factor of 20-100. Because the plume is mainly driven by the buoyant discharge, the regional influence does not depend on the details of the mode of discharge (e.g., single or multiple outlet discharge). Temperature perturbations are caused by the dilution of the effluent and by the redistribution of ambient temperature structure. For a 40-MWe OTEC plant discharge, temperature perturbations are less than 0.2°C and are distributed almost uniformly between the bottom of the mixed layer and the top of the thermocline.

The circulation induced by interaction of the buoyant discharge and the ocean not only influences plume dilution and temperature structure but also contributes to the redistribution of other ocean constituents. A computation of a nitrate profile subjected to only the physical (conservative) aspects of OTEC operation indicated that the nitrate flux into the upper ocean is derived both from the mixed-discharge effluent (i.e., cold water influence) and from discharge-induced deep upwelling. For a base condition where the nitrate level is very little in the upper 90 m and increases to some higher level in the depth interval of 90-130 m, the two processes contribute about equal amounts of the OTEC-induced nitrate flux into the upper ocean.

Using the Argonne model to examine the effects of discharges of two adjacent OTEC plants showed that the regional influence may be computed as a superposition of two individual plumes, given reasonable separation between plants. When two 40-MWe OTEC plants are separated by 2 km alongshore, the effluent concentration near the up-current plant is about the same as the effluent concentration of a 40-MWe OTEC single plant, where the effluent concentration near the down-current plant is increased by about 25% (Fig. 10). When two plants are separated by only a few hundred meters, which is equivalent to the case of a single 80-MWe OTEC plant, significant interaction occurs and the effluent concentration is increased by about 100% from that of a single 40-MWe OTEC plant.

The regional influence is not very sensitive to the effects of the coastal boundary. On the other hand, the dilution of the effluent plume is greatly reduced for effluents discharged in shallow water or along the bottom. For a 40-MWe OTEC plant with bottom discharge, the maximum effluent concentration will be about 10% of the initial concentration, which is about twice the maximum concentration of the effluent plume from the nearsurface discharge. The plume also penetrates deeper into the thermocline than in the case of nearsurface discharge.

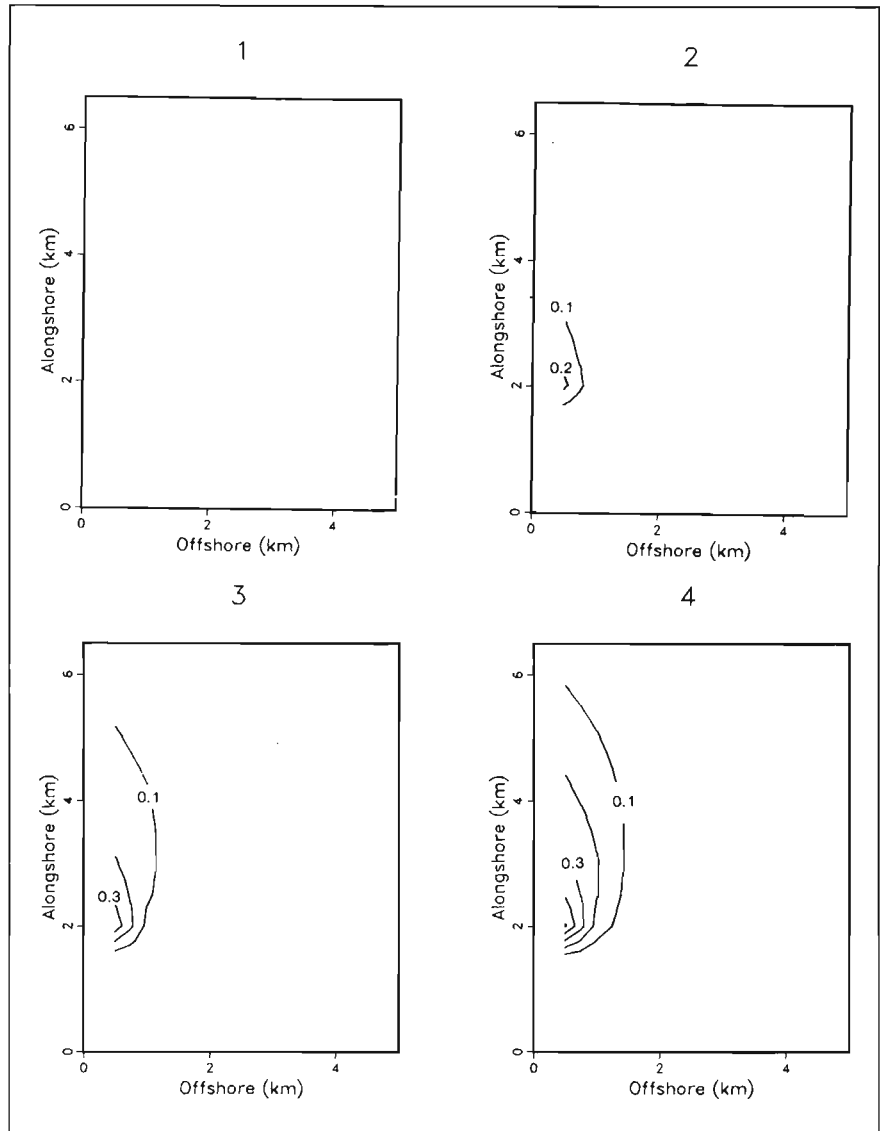

Figure 9.—Horizontal distribution of dye at 10 m (level 1), 30 m (level 2), 50 m (level 3), and 70 m (level 4) from a model of the regional influence of a 40-MWe OTEC plant (initial concentration = 10; ambient current = 20 cm/s alongshore) (from Wang 1984).

The applications of the Argonne model to several OTEC configurations have demonstrated the importance of the discharged-induced circulation, or interactions between the discharge and ambient ocean. The region of influence of an OTEC facility clearly is greater than simply the geometric extent of the plume determined from integral jet models and superimposed on a fixed ambient ocean. For the purpose of investigating regional influence in a generic sense, model applications have been restricted to a simple coastal geometry and steady ocean currents. In the case of a more complex geometry, the effluents that are advected downcurrent may accumulate in a convergence zone. The effluent plume also may be swept away by storm currents and impinging eddies.

## BIOLOGICAL INTERACTION WITH THE ENVIRONMENT

### Biological Characteristics of the Environment

This section briefly summarizes information presented in reports by Hoss et al. (1983) and Uchida (1983) (both efforts being part of this overall study), on pertinent biological information from the

Caribbean and Pacific, respectively. For specific details those reports should be directly consulted.

**Location**—There are no areas in the Caribbean which lie outside of existing or potential Exclusive Economic Zone claims of some nation. It is likely that OTEC operations by U.S. corporations will be within the Fishery Conservation Zone (equivalent to the Exclusive Economic Zone in the U.S.) surrounding Puerto Rico and the U.S. Virgin Islands (Fig. 11). Several sites in the Pacific have been studied for possible land-based OTEC plants including Keahole Point and Kahe Point in the Hawaiian Islands and Cabras Island, Guam. Additional areas in the open Pacific (e.g., between lat. 5°-10°N and long. 90°-95°W) have been investigated and found to be excellent for OTEC plantship operation.

**Phytoplankton**—Primary production in Hawaiian and open tropical Pacific waters is low relative to that of Continental Shelf areas in the Pacific (estimated to be on the order of  $200 \text{ g C} \cdot \text{m}^{-2} \cdot \text{y}^{-1}$ ) (Platt and Rao 1975). Noda et al. (1982) estimated the annual primary production off Keahole Point to range from 4.2 to 72.6  $\text{g C} \cdot \text{m}^{-2} \cdot \text{y}^{-1}$ ; measurements off Kahe Point are similar, with Noda et al. (1981a) determining average annual primary produc-

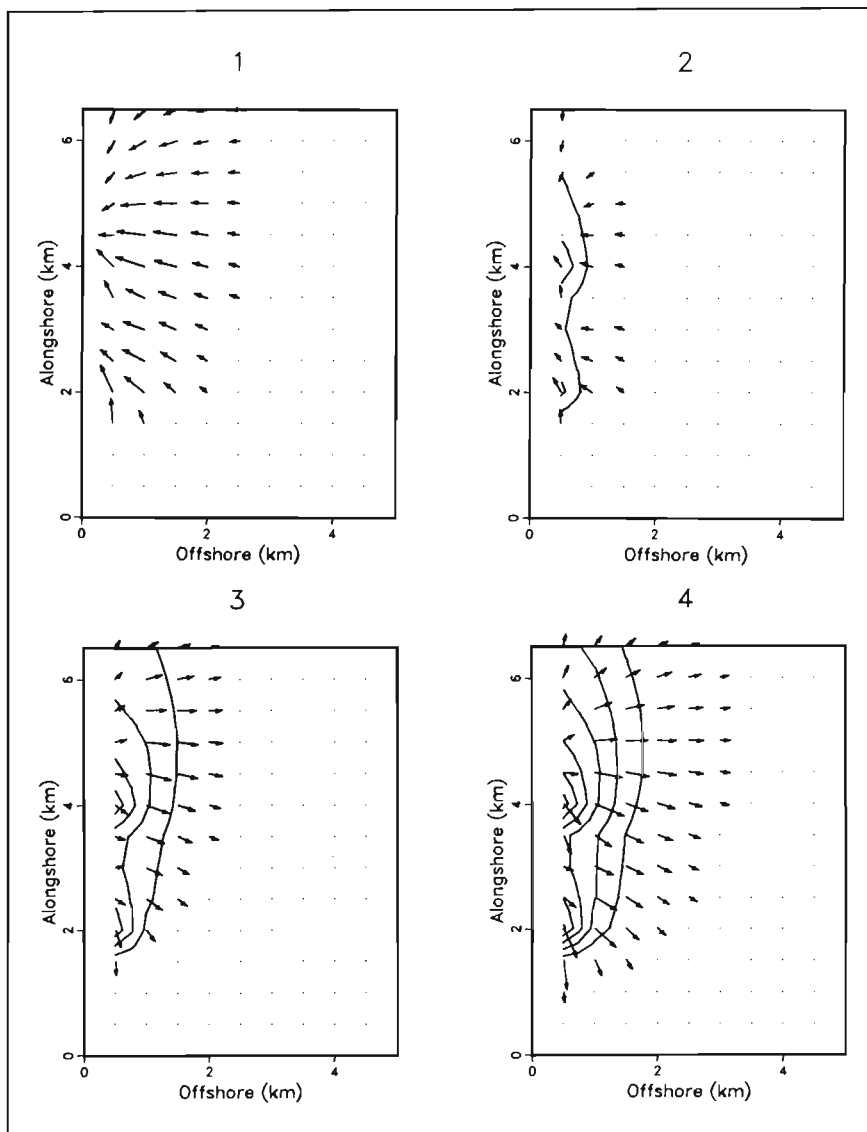

Figure 10.—Horizontal distribution of velocity and dye for two adjacent 40-MWe OTEC plants at 10 m (level 1), 30 m (level 2), 50 m (level 3), and 70 m (level 4) (velocity scale = 20 cm/s alongshore; initial dye concentration = 10; contour interval = 0.1) (from Wang 1984).

tion at  $60.4 \pm 15.6 \text{ g C} \cdot \text{m}^{-2} \cdot \text{y}^{-1}$ . Slightly higher values, 120 to  $144 \text{ g C} \cdot \text{m}^{-2} \cdot \text{y}^{-1}$ , have been reported from the open ocean (El-Sayed and Taguchi 1979). Bienfang and Szyper (1982) demonstrated that enriching the photic zone with upwelled nutrients can increase production.

Production in the Caribbean is also generally low, typical of areas without a pronounced admixture of nutrient-rich water from below. Average daily production rates reported from various areas (Sander and Steven 1973; Steven 1971; Beers et al. 1968; and Steeman Nielsen and Jensen 1957) correspond to annual rates ranging from 20 to  $105 \text{ g C} \cdot \text{m}^{-2} \cdot \text{y}^{-1}$ . The variation is associated with input of nutrients to the surface: where water passes over shallow banks, at the edge of eddies which form in the wake of islands, at upwellings along the South American coast, and in upwellings on the periphery of eddies of Amazon river water. Potential OTEC sites near Puerto Rico and the U.S. Virgin Islands may be particularly low in primary and secondary production due to the thick wedge of low-density surface water present which may reduce nutrient advection.

Phytoplankton standing crop is similar at oceanic sites in the Caribbean, Hawaii, and the mid-Pacific. Surface chlorophyll-*a* concentration from eight Caribbean locations (Marshall and Solder

1982; Knauer and Flegal 1981; Sander and Steven 1973; Malone 1971; and Hargraves et al. 1970) averaged  $0.13 \text{ mg m}^{-3}$ . Off Keahole Point in Hawaii it ranged from 0.03 to  $0.18 \text{ mg m}^{-3}$  (Noda et al. 1982) and in the open tropical Pacific the average value was  $0.12 \text{ mg/m}^3$  (El-Sayed and Taguchi 1979).

Investigations of plankton near oceanic islands have repeatedly revealed that taxonomic composition, standing crop, and production change with distance from shore. The intensity of this "island mass" effect and the area influenced are generally greater on the leeward side of the island. Data from Barbados (Sander and Steven 1973) showed that moving from 2 to 10 km offshore reduced cell concentration and production rates by a factor of four and increased the relative abundance of blue-green algae by a factor of ten. Because the intensity of this island mass effect varies with location, site-specific studies are particularly important at potential sites which are nearshore.

**Zooplankton**—Although zooplankton have not been studied extensively in either Hawaii or the Caribbean, the data available indicate similar abundance in both areas. In dry weights per sample from the Caribbean oceanic water, the range ( $0.3$  to  $12 \text{ mg/m}^3$ ) is similar to that found in Hawaiian nearshore samples, 0.14 to 25

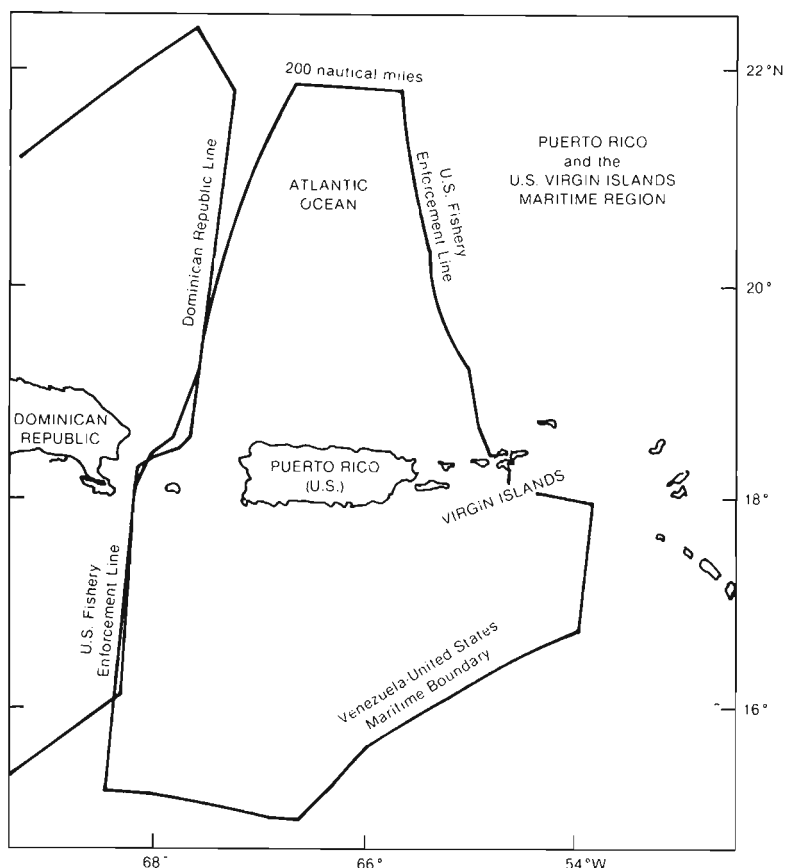

Figure 11.—The Fishery Conservation Zone surrounding Puerto Rico and the U.S. Virgin Islands (U.S. Department of State 1982).

mg/m<sup>3</sup> (Noda et al. 1981a). The average displacement volume, 0.20 to 0.30 ml/m<sup>3</sup>, and average dry weight, 2.4-3.3 mg/m<sup>3</sup>, are very similar among oceanic studies from the Caribbean (Moore and Sander 1977; Deevey 1971; Margalef 1971; and Moore 1967). The importance of an island effect on zooplankton abundance is evident from studies near Jamaica and Barbados where respective dry weights inshore were 1.7 and 2.5 times those found offshore (Sander and Steven 1973; Moore 1967).

Abundance of zooplankton decreases considerably with depth. Off Bermuda, total abundance in the upper 500 m was 8, 19, and 39 times that found at respective depths of 500-1000 m, 1000-1500 m, and 1500-2000 m (Deevey and Brooks 1971). In the mid-Pacific, Hirota (1977) showed the highest concentration in the upper 150 m and moderately high concentration between 200 and 900 m. Standing stocks in the upper 200 m varied about 50-90% of that in the upper 1000 m. Off of Kahe Point in Hawaii, Noda et al. (1981a) observed an approximate tenfold difference between surface samples and those from 600-1000 m.

Although diel migration of zooplankton has been observed but not extensively documented in Hawaii and the Caribbean, the phenomenon is general and fairly well known. "Diel vertical movements occur in all planktonic phyla and in most of the smaller taxonomic groups" (Longhurst 1976). In general this consists of a migration from deep water toward nearsurface layers, where plankton spend the night and then descend again at dawn. The planktoners do not necessarily rise all the way to the surface; aggregations tend to occur at the level of the deep chlorophyll maximum, and abundance in the surface water may even decrease during the night as a result of downward migration of surface zooplanktoners to the chlorophyll maximum layer.

**Fisheries**—The major thrust of the commercial fishery in Hawaii is in the open ocean beyond 200 m in depth, where pole-and-line sampans catch skipjack tuna; and longline, handline, and charter boats harvest yellowfin and bigeye tuna, albacore, striped blue and black marlin, swordfish, spearfish, sailfish, wahoo, and mahimahi. Nearshore fisheries include a variety of commercial handline, net, trap, and recreational boats which catch a wide variety of demersal and bathypelagic species including pink, red, and grey snappers, goatfishes, seabass, and bigeye and mackerel scad. The scad landings are of considerable importance, being second only to tuna and billfishes.

The area near Kahe Point sustains a varied and valuable fishery. In the years from 1976 to 1980, 101 different species were identified in the harvest from the area. Hawaii Division of Aquatic Resources records show that the average annual catch was about 219 metric tons with an annual yield to commercial fishermen of \$350,000.

The commercial fishery in the oceanic waters of the Caribbean is basically a long-line fishery for tunas. The fishery is dominated by large modern vessels from Japan, Korea, Taiwan, and Venezuela.

The commercial fishery in nearshore waters can be described in terms of several main components which overlap slightly. The most important of these, both in weight and value, is the demersal fishes component, in which fish pots and hand lines are used to catch shallow reef species and deep-water snappers and groupers. This component of the fishery accounts for about 70% of the catch in Puerto Rico and 53% of its value. The second component of the fishery is for coastal pelagic fishes, using troll lines, beach seines, and gill nets; this component accounts for about 21% of the total catch and 16% of its value in Puerto Rico. Shellfish, the third com-

ponent, accounts for only about 15% of the Puerto Rico catch but about 30% of its value. Spiny lobster landings are over 50% of the shellfish catch, yet 70% of its value; the other major shellfish species is the queen conch.

Although the economic importance of the recreational fishery has not been evaluated, it is of considerable importance to the tourism industry and the local residents. Its importance in Puerto Rico is reflected in a catch of 1,361 blue and white marlin and sailfish from May 1977 to April 1978, about half of which were caught by vessels from outside the area. Other species for which the area is known are yellowfin tuna, wahoo, bonefish, some of the larger reef species, and billfishes. Billfishes are already overexploited in the Atlantic, so the future of that recreational fishery is uncertain.

**Eggs and Larvae of Important Species**—Data on abundance and distribution of the early life stages of important species is rather scant; thus, it is difficult to make a general comparison of larvae from Hawaii and the Caribbean. Based on reproductive stages of adult fish in the Caribbean (Munro et al. 1973), it appears that reef fish eggs and larvae will be most abundant during February through April. However, the eggs and larvae of tuna and billfishes will be most abundant during the summer, with some species present at lower numbers in spring and fall (Matsumoto et al. 1984; Uchida 1981; Yoshida 1979; Shomura and Williams 1975; Miller et al. 1979; Idyll and deSylva 1963).

Spatial distribution of larvae is quite complicated depending on both the reproductive habits of the fish and water movement in and near the spawning area. Most of the important reef species have pelagic eggs and appear to be spawned at times and locations where the eggs will be quickly moved offshore to areas where predators may be less abundant. This pattern has been substantiated in Hawaii by Leis (1982) who found reef fish eggs were more abundant 3.0 km from shore than 0.2 km out, and Miller (1974) who reported larvae of some fish were more abundant 50 km off Oahu than 5 km out. Dekhnik et al. (1973) found the same larval pattern off Cuba and several studies have shown the same pattern with fish eggs at other Caribbean sites (Moore 1967; Sander and Steven 1973; Moore and Sander 1976). Larval distribution of pelagic species may be much different. Miller et al. (1979) reported tuna larvae were much more abundant nearshore and on the leeward rather than windward coast. It appears likely that high surface densities of larvae are produced by wind-driven upwelling of layers of water containing fairly dense larval concentrations.

Comparing absolute abundance of larvae between areas is particularly difficult because various investigators use different techniques, including sampling at different depths, and because the samples display considerable variability. The larval abundance of oceanic species in the Caribbean (Richards 1981), however, appears similar to that in the eastern tropical Pacific (Ahlstrom 1971, 1972). The Caribbean may have a more diverse assemblage with 15 families accounting for about 70% of the larvae (Richards 1984) in comparison to the Pacific, where 10 families constituted 90% of the larvae. It is likely that in both regions the larvae are most abundant near surface. In the mid-Pacific, Hirota (1977) found:

- 1) that the larvae of commercially important tuna occur more abundantly in the neuston layer than from 1-200 m,
- 2) the species in the 1-200 m layer are primarily midwater forms, and
- 3) very few larval fish occur between 200-1000 m.

Off Puerto Rico the vertical trend is similar with few fish below 200 m and the highest number between 0 and 25 m (Vargo et al. 1981).

**Other Important Biological Components**—Other biological components such as coral reefs, mangroves, and sea grass beds are all very important habitat types for numerous fishery resources, at least during some portion of the individual species' life cycle. Impacts on such fishery habitats may be of greater importance than direct impact on the species themselves (eggs, larvae, adults), particularly for near/onshore OTEC sites (J. Naughton, Southw. Region-West. Pacific Program Staff, Natl. Mar. Fish. Serv., NOAA, Honolulu, HI, pers. commun. 1984). In addition, the destruction of coral reefs can sometimes lead to an increase in the incidence of ciguatera poisoning, caused by the ingestion of fish contaminated with a paralytic neurotoxin of natural origin (see Research Priorities section). It is important that all efforts be made to minimize the impact of OTEC operations on such biological resources.

In a strict interpretation, protected species such as marine mammals may not be "fisheries" resources. However, they are important components of the biota at the potential OTEC sites and impacts on them will have to be evaluated on a thorough basis. As noted in Table 3, a number of species are listed as threatened or endangered in Hawaiian and Caribbean waters. The humpback whale,

**Table 3.—Threatened (T) and endangered (E) marine species (Source: 50 CFR 17.11-12).**

	Hawaii	Virgin Islands
<b>Marine mammals</b>		
Right whale <i>Balaena glacialis</i> *	E	
Sei whale <i>Balaenoptera borealis</i>	E	
Blue whale <i>Balaenoptera musculus</i>	E	
Finback whale <i>Balaenoptera physalus</i>	E	
Humpback whale <i>Megaptera novaeangliae</i>	E	
Hawaiian monk seal <i>Monachus schauinslandi</i>	E	
Sperm whale <i>Physeter catodon</i>	E	
Caribbean monk seal <i>Monachus tropicalis</i>		E
West Indian manatee (Florida) <i>Trichechus manatus</i>		E
<b>Sea Turtles</b>		
Loggerhead sea turtle <i>Caretta caretta</i>	T	T
Green sea turtle <i>Chelonia mydas</i>	E	T
Leatherback sea turtle <i>Dermochelys coriacea</i>	E	E
Hawksbill sea turtle <i>Eretmochelys imbricata</i>	E	E (=carey)
Kemp's Ridley sea turtle (=Atlantic) <i>Lepidochelys kempii</i>	E	E
Olive Ridley sea turtle (Pacific) <i>Lepidochelys olivacea</i>	T	
<b>Birds</b>		
Newel's shearwater <i>Puffinus auricularis newelli</i>	T	
Hawaiian dark-rumped petrel <i>Pterodroma phaeopygia sandwichensis</i>	E	

\*Not considered part of the normal cetacean fauna in Hawaiian waters.

*Megaptera novaeangliae*, one of the most abundant cetaceans in Hawaii, is an endangered species which migrates into Hawaiian waters in winter to breed. A second endangered species, the Hawaiian monk seal, *Monachus schauinslandi*, is present; however, the population resides in the Northwestern Hawaiian Islands and away from potential OTEC sites. Of the five sea turtles that have been reported off Hawaii, the green sea turtle (*Chelonia mydas*) is the most abundant. A single green sea turtle has been observed repeatedly on the reef directly off the Kahe Point power station.

A number of marine species listed as threatened or endangered, including several turtles, are found in the waters off Puerto Rico and the Virgin Islands. Of particular importance are the leatherback and hawksbill turtles which nest in potential OTEC areas, and humpback whales which calve and mate in the region from January through April.

## Factors That May Affect Fish

Organisms entrained by the intakes of an OTEC plant will either be impinged on screens placed to prevent larger objects from entering and clogging critical parts of the plant, or entrained and transported through the plant and then discharged. In passage through the plant, entrained organisms will be subject to a number of stresses such as temperature and pressure changes, and chemical additions. Upon discharge to the environment, entrained organisms will be redistributed in the water column along with additional organisms entrained into the discharge plume. The artificial upwelling of nutrients and other constituents contained in the deeper, colder waters and their subsequent redistribution may also effect some biological changes.

**Attraction/Avoidance**—The attraction or avoidance of fish towards objects, light and noise is a known phenomena that is expected to occur with OTEC operations, whether they be open-ocean plant-ships, stationary towers, moored platforms, or land-based plants. For the purpose of this study, Seki (1984) has summarized available information on this topic and related it to OTEC development; the following is a brief synopsis of his findings.

The attraction of fish to free-floating and anchored objects or structures has been studied throughout the world's tropical and subtropical waters. The objects with which fish have been observed to associate include drifting seaweed (Senta 1966), driftwood (Yabe and Mori 1950; Inoue et al. 1963; Hunter and Mitchell 1967; Inoue et al. 1968), manmade rafts (Kojima 1960; Gooding and Magnuson 1967), and artificial surface or midwater structures, including commercial fish aggregating devices (FAD's) (Hunter and Mitchell 1968; Klima and Wickham 1971; Wickham et al. 1973; Wickham and Russell 1974; Matsumoto et al. 1981). Tunas dominate the catch of the pole-and-line, trolling, handline, and purse seine boats fishing around FAD's, as evidenced by some catch data obtained from Kiribati, Western Samoa, Fiji, and Hawaii (Shomura and Matsumoto 1982). The experimental study by Matsumoto et al. (1981) provided the most detailed records of catches around FAD's in the Pacific. Matsumoto reported that skipjack tuna, *Katsuwonus pelamis*, represented nearly 90% of the catch by the pole-and-line boats. These fish ranged from 0.9 to 5.4 kg and sometimes over 9.1 kg. Unlike pole-and-line boats, trolling boats had a much more diversified catch. Tunas (mostly yellowfin tuna, *Thunnus albacares*, and skipjack tuna, *Katsuwonus pelamis*) still dominated the catch, although mahimahi, *Coryphaena hippurus*, constituted the largest percentage of single species caught.

Another tuna fishery which utilizes FAD's (in conjunction with an artificial light source) in Hawaii is the ika-shibi or the night handline fishery for tuna. Although this rapidly growing fishery utilizes extremely simple gear (a single hook and a line) as compared with the longliners and large purse seiners, it is an extremely effective method as indicated by the mean catch rate of approximately two fish per hook per night (Yuen 1979).

In comparison to floating OTEC structures, the tower and man-made island designs of OTEC plants are expected to function as artificial reefs, duplicating those conditions that cause concentrations of fishes and invertebrates on natural reefs and rough bottom areas. The effect of tower designs would be similar to that of offshore oil platforms, which have resulted in an increase in offshore sport fishing in the immediate area.

Numerous studies have described the variety of fish which have been attracted to artificial reefs at various sites. In all studies, the many different species found generally represent similar basic broad behavioral classes, such as the Turner et al. (1969) reef or nonreef associates (the former further split into resident or semiresident). Four reefs were established at various sites in Hawaii between 1960 and 1973, using primarily car bodies, damaged concrete pipes, and old car tires filled with mortar. The southern boundary of a reef created on one of these sites (Waianae) on the western coast of the Island of Oahu is at lat. 21°25.1'N, long. 158°11.6'W (Kanayama and Onizuka 1973) only 3 miles from the present OTEC benchmark survey site at lat. 21°19.5'N, long. 158°12.5'W offshore of Kahe Point. Sampling along a fish transect established before the reef construction indicated the presence of 32 different species and a standing crop density of 103 pounds of fish per acre. The reef was constructed in two sections, one composed of car bodies and the other of damaged concrete pipes. Thirty species of fishes (standing crop estimated at 1,271 pounds/acre) were present at the car body section. This was a tenfold increase over the pre-reef count. The concrete pipe section showed a fivefold increase of 45 fish species and a standing crop estimated at 496 pounds/acre.

Although attraction of fish to man-made structures is well documented, questions still arise regarding the relationship between artificial structures and fish production. Mallory (1965) believed that a structure concentrated the fish which constantly migrated in and out, thus serving as an orientation point. This was true for a number of species (primarily the game fishes) associated with flotsam. Stroud (1965) felt that since the artificial habitat provides food and shelter, reproduction will be enhanced resulting in an increase in production and yield of fish. A third hypothesis discussed by Carlisle et al. (1964), Turner et al. (1969), and Dugas et al. (1979), combines both viewpoints; fish are concentrated by recruitment, and, as the colonization progresses on the structures, a reproducing resident fish community may evolve. Although this may hold true for many of the reef fishes, this hypothesis falls short of accounting for overall fish attraction as evidenced primarily for such species as the deeper water pelagic scombrids and billfishes.

The attraction of various marine organisms to light is a phenomenon that has been used in the harvesting of fish for many years. Mackerel scad, *Decapterus macarellus*, and bigeye scad, *Selar crumenophthalmus* (Yamaguchi 1953; Powell 1968), various species of tuna (Yuen 1979), and squid (Ogura and Nasumi 1976), are caught by the use of night lights. How much of an effect the lights from an OTEC facility will have on the tuna is not presently known. As indicated by Laevastu and Hayes (1981), every species has a particular optimum light intensity in which its activity is at a maximum. It is probable that the intensity of the artificial light would fall within the thresholds of some species.

Regarding avoidance traits of marine biota to structures and operations in the ocean, published information is virtually nonexistent. Yuen (1981) indicated that the endangered and threatened species would probably avoid the area due to human presence and to the noise emitted from the plant. Among the few studies that address avoidance was one on the negative phototactic behavior of fish. Dragesund (1958) found that herring would sometimes display a shock response. That is, when the light was turned on, the fish would make a sudden upward movement towards the light only to later disperse or school and descend. Studies on other aspects of avoidance, such as of the physical structures, are nonexistent in published literature. Future studies should be directed in this area.

**Impingement**—Impingement at coastal power plants has been an ecological problem (loss of a large number of organisms), an operational problem (reduction in cooling water flow), and a cost problem (removal and disposal of organisms). Impingement occurs when organisms too large to pass through the intake screen, are pulled against it, and are unable to escape due to the current velocity. Schooling fishes are especially susceptible, and impingement mortalities may involve millions of individuals. In one incident, 2 million menhaden at the Millstone Plant in Connecticut were impinged and caused a shutdown of the plant by reducing the cooling water flow. These mortalities are believed by some ecologists to be reaching proportions which may cause population damage (Van Winkle

1977). As a result, data on impingement of fish have been collected from many operating plants (Adams 1969; Marcy 1971; Jensen 1974; Uziel 1980).

Variation in impingement on intake screens is related, among other things, to season, swimming speeds, intake location, and operating schedules of the power plant. Screen catches at most coastal power plants studied in temperate waters fluctuate markedly with season, due to migrations into and out of intake areas and to changes in water temperature that affect the fishes' ability to swim successfully against intake currents. In tropical areas, where OTEC plants will be located, impingement may be less variable because there is generally less migrational movement of populations and the water temperature is essentially the same the entire year.

The swimming speed of an organism determines whether or not it will escape impingement or entrainment once in the vicinity of an intake. Eggs and larvae of marine fish drift passively in the ocean within the zooplankton community. Early larval stages utilize swimming only to capture prey, escape predation, or migrate vertically. In general, sustained swimming speeds of fish larvae fall into a range of 2-4 body lengths/second for larvae in advanced development or for juveniles (Blaxter 1969; Bainbridge 1960). Table 4 lists representative species, including a few freshwater species, for individuals up to 6 cm in length. For most fishes, relative speeds decrease as size increases above that shown in Table 4, and absolute speed increases as size increases.

Table 4.—Sustained swimming speeds of some larval and juvenile fish species (adapted from Marcy et al. 1980).

Species	Length (mm)	Speed (mm/s)	Temp (°C)	Time maintained	Body lengths per second	Author
European plaice	7.5	12	6.5-7.5	A few s	—	Ryland (1963)
	9.5	27	6.5-7.5	A few s	—	
Whitefish	10-12	16	4	?	1.6	Braum (1964)
		29	16	?	2.4	
Common roach	35-45	138	?	1 min	3.1-3.9	Aslanova quoted by Radakov (1964)
Common bream	45-55	126	?	1 min	2.3-2.8	
Carp	50-60	129	?	1 min	2.1-2.6	
Horse mackerel	30-40	136	?	1 min	3.4-4.5	
Mullet	35-45	128	?	1 min	2.8-3.6	
Mullet	45-55	156	?	1 min	2.8-3.5	
White bream	18-26	330	?	?	12.7-18.3	Radakov (1964)
Atlantic herring	6.5-8	5.8	?(14)	45 min	0.7-0.9	Bishai (1960)
Atlantic herring	12-14	10	9-10	60 min	0.7-0.8	Blaxter (1966)
Sole	4	6-9	15	Long periods intermittent swimming	1.5-2.2	Rosenthal (1966)
Bleak	0.26 g (wet wt)	29.8	20	—	—	Ivlev (1960)
Smallmouth bass	22	146-312	20-35	3 min	6.6-14.2	Larimore and Duever (1968)
Yellow perch	6.5	5.5	13	60 min	0.8	Houde (1969)
	7.5	14.0	13	60 min	1.9	
	8.5	24.0	13	60 min	2.8	
	9.5	27.5	13	60 min	2.9	
	10.5	32.0	13	60 min	3.0	
	13.5	46.0	13	60 min	3.4	
Walleye	7.5	5.0	13	60 min	0.7	Houde (1969)
	8.5	13.0	13	60 min	1.5	
	9.5	29.0	13	60 min	3.0	
	10.5	32.0	13	60 min	3.0	
	11.5	37.5	13	60 min	3.3	
	13.5	42.0	13	60 min	3.1	
	14.5	46.0	13	60 min	3.2	
Lake whitefish	15.2	35	7.5	1 min	2.4	Hoagman (1974)
	15.8	58	11.5	1 min	3.7	
	19.7	71	11.5	1 min	3.6	
	21.3	76	14.5	1 min	3.5	
	28.8	115	14.5	1 min	4.0	

Among the fastest burst swimmers are yellowfin tuna, which as adults can swim 27 body lengths/s for 5 seconds (Walters and Fierstine 1964). Although larvae do not have strong sustained swimming ability, they possess impressive darting or burst speeds relative to their size. Blaxter (1969) suggests bursts of 10 body lengths/s which, for most larvae (up to 25 mm), would limit their speed to less than the 0.25-0.30 m/s suggested as typical of OTEC plant warm-water intake velocity (see Seawater Systems section). Scombrid larvae have not been measured for burst swimming performance, but Pacific mackerel up to 3.6 cm in length swam up to 26 cm/s, counting time spent in rest and feeding (Hunter 1980).

Swimming ability is a function of morphological shape, stage of development, length, ambient temperature and light, and the duration required for the performance (Tsukamoto et al. 1975; Hartwell and Otto 1978; Rulifson 1977; Pavlov et al. 1968; Larimore and Duever 1968; Hunter and Kimbrell 1980). Knowledge of these factors and the types of species likely to be near the OTEC plant site is necessary to predict the potential of larvae and juveniles to escape intake currents.

Morphologically, the fastest species have a high aspect ratio of the caudal fin (ratio of the square of the caudal fin depth to the surface area) (Lighthill 1970). Species with high aspect ratios are those with the carangiform (e.g., Carangidae, Clupeidae, Pomatomidae) and thunniform (e.g., Scombridae, Istophoridae, Xiphiidae, Stromateidae) swimming motion. Anguilliform swimmers (e.g., Anguillidae, Pleuronectiformes), subcarangiform swimmers (e.g., Gadiformes, Salmonidae), or ostraciiform swimmers (e.g., Ostraciidae, Tetraodontidae, Lophiiformes) have a low caudal fin aspect ratio and are relatively slow.

The effects of temperature on swimming speeds are probably unimportant in predicting susceptibility of small fish to entrainment in an OTEC plant. While Hettler (1979) found that a 10°C increase in temperature caused the swimming speed for two carangiform juveniles to increase by a factor of 1.6, the relatively consistent temperature in the tropics is unlikely to cause large seasonal changes in susceptibility to entrainment.

The design of the water intake structure will greatly affect current velocity. It has been shown that fish are better able to orient to a horizontal flow than a vertical flow. Intake structures placed or capped so that intake flows are in the horizontal plane enable fish to orient to the flow and more effectively avoid the intake (Langford 1983).

Because of the large volume of water required by OTEC plants and the relatively high flow rate at the screens, impingement of organisms on the warm-water intake screens will assuredly be a visible effect and may, in some cases, be ecologically important. Impingement rates will depend on intake location and velocity, time of day, behavior characteristics of the populations of organisms associated with the plant site and, to some extent, season of the year, although this will be a relatively minor factor in tropical waters. Another important factor is that the plant may serve as a fish-attracting device and concentrate large numbers of organisms where they are in danger of being impinged or entrained (Seki 1984).

Impinged organisms generally fall into the micronekton size category (2-20 cm) and include fishes, macroplanktonic crustaceans, cephalopods, and gelatinous organisms such as coelenterates, salps, and ctenophores. Micronekton are an important intermediate step in the food chain between the zooplankton and commercially important fishes. The significance of large-scale mortalities due to impingement at coastal power plants in temperate waters has not been quantified from field data and there is presently no conclusive evidence of actual population declines in any species due to impingement losses.

**Primary Entrainment**—Any organism small enough to pass through the intake screens (approximately 1.3 cm; Sands 1980) will be entrained in the seawater flowing through the heat exchangers (primary entrainment). During this period, organisms are subjected to thermal and mechanical stresses as a result of changes in pressure and temperature, shear and acceleration forces, abrasion, and collision with structures. In addition, organisms will be subjected to biocides used to clean the surfaces of the heat exchangers, anti-corrosion agents, and corrosion products. Effects on organisms will be due to a combination of these factors.

The effects of primary entrainment at conventional power plants have been extensively studied and a number of reviews have been reported (e.g., Schubel and Marcy 1978). There is general agreement that while a great many species of organisms cannot survive passage through the cooling water system, there is a wide range of tolerance among species, and plant design and operating characteristics are critical factors. Mechanical damage is probably the major single factor contributing to primary entrainment mortality. The importance of thermal and chemical stress will vary depending on thermal exposure, biocide treatments, and corrosion rates.

Entrainment effects associated with OTEC will no doubt be one of the most important factors to consider with respect to fisheries. Because of the low thermal efficiency of OTEC plants the amount of water needed is extremely large; generally between 6 and 10  $\text{m}^3 \cdot \text{s}^{-1} \cdot \text{MWe}^{-1}$  for the total combined warm and cold water flow (see Seawater Systems section), as compared to an average of 0.05  $\text{m}^3 \cdot \text{s}^{-1} \cdot \text{MWe}^{-1}$  for condensing water for a nuclear plant. Because of this large water requirement, the number of organisms subject to entrainment will be large.

**Temperature**—Organisms entrained in conventional power plants are subjected to rapid increases in temperature as they pass through power plant condensers. The near instantaneous temperature changes ( $\Delta T$ ) may range from less than 6°C to more than 19°C (Schubel and Marcy 1978), and the exposure time to these elevated temperatures may range from several minutes to an hour (including time in the discharge canal) depending on the plant design. Laboratory research on the larvae of four species of temperate subtropical marine fish (Atlantic menhaden, *Brevoortia tyrannus*; spot, *Leiostomus xanthurus*; pinfish, *Lagodon rhomboides*; and flounder, *Paralichthys* sp.) has shown that their survival following entrainment in a once-through cooling water system will depend on the increase in condenser water temperature over ambient water temperature and the length of exposure (Hoss et al. 1971, 1974).

Studies designed to evaluate a hypothetical offshore conventional power plant with a  $\Delta T$  of 10-12°C and an ambient temperature of



15-16°C indicate that spot, *Leiostomus xanthurus*, eggs may be more affected by heat shock during their first day of life than at later stages as embryos (Hettler and Coston-Clements 1978). Eggs of black sea bass, *Centropristis striatus*, did not show this same effect, so it appears that stage of development at time of shock may be important, but must be determined on an individual species basis. Spot eggs that were slowly returned to ambient temperatures had a much better survival than those subjected to a rapid return. The larvae of spot (1-21 days old) showed no apparent relationship between age and survival following thermal shock (Hettler and Coston-Clements 1978).

Unlike conventional power plants where organisms experience only an increase in temperature as they pass through the condensers, organisms entrained in OTEC plants will experience both increases and decreases in temperature. Organisms entrained in the warm water will pass through the evaporator, where the temperature will be decreased by 2-3°C, while organisms entrained in the cold water will pass through the condenser, where temperature will be increased 2-3°C (U.S. Dept. of Energy 1978). Additionally, organisms will be subject to larger temperature changes upon mixing of the two effluents (if practiced) and/or discharge to the environment. For instance, a mixed discharge would effect a temperature drop of about 10°C for the warm-water organisms and a 10°C increase for any cold-water organisms. Entrained organisms will also experience a redistribution in the water column when discharged with effluent waters. This redistribution could also expose organisms to a different temperature regime.

No literature was found on cold shock in fish for the temperature range and  $\Delta T$  expected for the OTEC discharge. Cold shock literature is limited to describing effects of rapidly reduced temperatures during the cooler months to new temperatures at or near the low lethal temperatures, which produce death by the formation of ice in the tissues or induce primary (respiratory) or secondary (nerve blockage) chill comas. All reported fish kills or experimental cold shocks involved species in temperate climates. Chittenden (1972) found that young *Alosa sapidissima* exposed to abrupt temperature decreases from 24°C to 12°C were not affected, but below 12°C even gradual decreases caused sublethal behavioral problems. Terpin et al. (1977) showed that *Anchoa mitchilli* died at 10°C when acclimated to 22°C and subjected to a 12°C decrease in 29 hours. However, no mortality occurred at decreases of 4°C and 7°C. Becker et al. (1977), although not working with marine species, showed that differences in response to abrupt temperature changes were found between species, inferring that a general prediction of the effect of cold shock cannot be made to a number of species. Further, knowledge of thermal requirements of the adults of a species may not be sufficient to predict those of egg and larval forms. In Brett's (1956) review, he states that "... the thermal requirements in the very early stages are more exacting than in the adult." For eggs and larvae of stenothermal species, reduced temperatures, although not actually "cold," will retard development and may cause abnormalities. Harada et al. (1978) found that no yellowfin tuna larvae developed normally in temperatures below 20°C.

**Pressure**—Rapid change in hydrostatic pressure is one of the stresses to which organisms are subjected during entrainment. These pressure changes may be either negative (vacuums within the pump) or positive, and the magnitude of the change is dependent on design of the plant.

It has been suggested that rapid changes in pressure that occur in power plant cooling water pumps may be potentially damaging to entrained fish (Marcy et al. 1980). Although much research has

been conducted on the effect of pressure change on fish, very little of it has any direct relevance to the relatively small pressure changes (1-5 atmospheres; 1 atmosphere change equivalent to a 10-m depth change) to which fish are subjected in power plant cooling systems.

Much less entrainment of organisms is expected in the cold water intake of an OTEC plant, but any entrained organisms will be exposed to a pressure change of 70-100 atmospheres depending on depth of the intake pipe. Entrained fish larvae possessing a swim bladder would be very vulnerable to rapid changes in pressure of this magnitude (Hoss and Blaxter 1979; Blaxter and Hoss 1979).

**Chemical Additions**—Due to the low thermodynamic efficiencies available through the OTEC system (Myers and Ditmars 1985), the heat transfer rate at the heat exchanger surfaces will be critical. The inhibition of biofouling due to microorganisms must thus be an integral aspect of OTEC operations. As in coastal power plants, current thought here supports the need for intermittent chlorination to keep biofouling to a sufficiently low level. As noted by Hoss and Peters (1983), there is concern over the use of chlorine because of its toxicity. It has been shown that added chlorine can seriously affect the growth and survival of entrained organisms (Schubel and Marcy 1978), although there are species-to-species variations and certain synergistic effects with temperature and trace metals (Hoss et al. 1975, 1977).

The biocide concern is amplified in an OTEC operation because of the large volumes of water involved, i.e., the achievement of a certain concentration for biocidal effectiveness will require the application of large quantities of biocide. Although the required dose of chlorine will be somewhat site-specific, recent studies indicate that concentrations of total residual chlorine of about 0.07 mg/L may achieve the desired results (Larsen-Basse and Daniel 1983). This is well below the new source performance standards (NSPS) requirement for chlorine discharges from steam electric generating stations, the standards which would most likely apply to OTEC discharges (Myers and Ditmars 1985). For plants with a steam electric generation capacity of 25-MWe or more, the NSPS specify the total residual chlorine (TRC) in the cooling water discharge from any single generating unit shall not exceed 0.20 mg/L, and that the duration of chlorine discharge shall not exceed 2 hours/day.

Although chlorine bioassay studies by Venkataramiah et al. (1981b) suggest that levels less than or equal to 0.5 mg/L may be generally safe, there are still concerns regarding cumulative effects of continuous discharges that must be further addressed (Venkataramiah et al. 1981a; U.S. Department of Energy 1981). There is also a potential for synergistic reactions of chlorine with trace metals and ammonia leaks. Recent studies (Venkataramiah et al. 1981a,b) on marine fishes and zooplankton have shown that the toxicity of ammonia and chlorine varies with habitat of the species and with duration of exposure. Within the same species (gray mullet, *Mugil cephalus*), smaller fish were more sensitive than larger fish. This work confirms past research on other species and provides further evidence that exposure to chlorine in marine waters, while not well understood, may present a serious problem and should receive additional study.

Because of the large surface areas required for OTEC heat exchangers [about 9.3 m<sup>2</sup>/kWe for closed cycle (NOAA 1981a)], heat exchangers are considered one of the principal sources of trace metal release. Myers and Ditmars (1985) have used the results of DOE-supported corrosion tests (Tipton 1980) to make worst-case estimates of trace metal concentrations in OTEC discharges (Table 5). In general, the concentrations of trace metals in an OTEC

**Table 5.—Estimates of OTEC effluent trace metals concentrations due to heat exchanger corrosion and erosion.**

Material <sup>a</sup>	Cleaning environment <sup>b</sup>	Material loss/unit area 3-mo exposure <sup>c</sup> (mg/cm <sup>2</sup> )	Trace constituent concentrations in OTEC discharge effluent <sup>d</sup> (ng/g)
Alclad 3003	Brush + chlorine	34.3	Al, 66; Zn, 1
5052 Al	Brush + chlorine	10.1	Al, 19; Mg, 0.49; Cr, 0.05
CA 706 Cu-Ni	Brush	87.5	Cu, 151; Ni, 17; Fe, 2.4
Al-6X Steel	Brush	0.02	Fe, 0.02; Ni, 0.01; Cr, 0.01; Mo, 0.002
Ti	Brush	<0.01	Ti, <0.02

<sup>a</sup>Material composition: Alclad 3003 is 99% Al, 1% Zn; 5052 Al is 97.5% Al, 2.5% Mg, 0.25% Cr; CA 706 Cu-Ni is 88.6% Cu, 10.0% Ni, 1.4% Fe; Al-6X Steel is 50% Fe, 24% Ni, 20% Cr, 6% Mo; and titanium is commercially pure.

<sup>b</sup>Cleaning environment is either M.A.N.<sup>®</sup> (American M.A.N. Corp., N.Y.), brushing with 3 round-trips/day or brushing plus continuous chlorination at 0.1 mg/L concentrations.

<sup>c</sup>From Tipton (1980); largest alloy losses from 3-mo exposure reported here.

<sup>d</sup>Calculated assuming alloy loss (from Tipton 1980), heat exchanger surface areas of 9.3 m<sup>2</sup>/kW (NOAA 1981a), and OTEC seawater flows of 6 m<sup>3</sup>s<sup>-1</sup>MWe<sup>-1</sup>.

discharge are estimated to be on the order of 100 ng/g (100 µg/L) or smaller. With the possible exception of copper, these estimates suggest that the release of trace metals from heat exchanger surfaces would not pose significant concern. Worst-case estimates of the release of copper from a Cu-Ni alloy (i.e., CA 706) indicate concentrations above 100 ng/g, in the acute toxicity range of copper in seawater based on a number of observations of copper toxicity (Klapow and Lewis 1979).

With the exception of catastrophic accidents, any leaks of working fluids will be diluted by the large volumetric flow of seawater through the plant, to the point that problems should not arise. For instance, with the Ocean Thermal Corporation OTEC design for Kahe Point, it is predicted that normal leaking of ammonia could result in an increase of 2.4 µg/L above the ambient level of 10.7 µg/L in the mixed discharge (Ocean Thermal Corporation 1983). Upon reaction with the seawater, only about 5% of this increase would remain as un-ionized ammonia, the principal toxic form. The concentration of un-ionized ammonia in the discharge would then be about 0.66 µg/L, well below a reported minimum-risk level of 10 µg/L (U.S. Environmental Protection Agency 1973) and only 0.12 µg/L greater than the ambient concentration of un-ionized ammonia.

**Secondary Entrainment**—Secondary entrainment refers to the capture of organisms in discharge waters (effluent plume) as a result of turbulent mixing or behavioral responses. The rate at which organisms are entrained in this manner will depend on the discharge flow rate, the near-field dilution, and the average population density along the near-field trajectory of the plume (Paddock and Ditmars 1983).

Most of the same stresses encountered in primary entrainment will also be encountered in secondary entrainment, the difference being that the magnitude of the stress will, in general, be much less. Determining the effects on fisheries organisms of secondary entrainment will be even more difficult than for primary entrainment, and results from previous power plant studies are limited in their usefulness.

Ehrlich (1977) reported that the hatching success of California grunion (*Leuresthes tenuis*) was significantly reduced by a non-thermal but unknown component of the effluent from a California power plant. Large variation in hatching success suggested that the unknown hatching inhibitor in the water fluctuated during plant

operation. It is possible that trace metals in the effluent caused the variation, since previous work by Rosenthal and Alderdice (1976) showed reduced hatching in herring eggs exposed to trace metals. The effects of small changes in water temperature have been shown by Peters and Angelovic (1973) to be an important factor in controlling fish feeding and growth. Small changes in temperature (either increases or decreases) in the discharge plume may, therefore, have an effect on larval fish growth, but this will be very dependent on the depth at which the discharge occurs and the total area that is impacted.

**Ocean Water Mixing**—An OTEC plant's displacement of large quantities of deep ocean water can cause an upwelling effect that may disturb the natural temperature structure, salinity gradient and levels of dissolved oxygen, nutrients, and trace metals in the surface waters. Artificial upwelling is not a characteristic of conventional power plants; therefore, there is little direct analogy to the OTEC situation. However, some studies that have been made on nutrient distribution and changes in trace metal levels may be of some use in predicting upwelling effects.

In general, it is thought that the pumping of large amounts of deep nutrient-rich ocean water to the surface layer may have positive effects if the same type of biostimulation occurs near OTEC plants as occurs near areas of natural upwelling. However, whether upwelling will be harmful or beneficial to local ecosystems will depend on many factors, as discussed in the section Impacts on Fishery Food Chains.

The concentration of trace metals in surface water may increase due to upwelling of metal-rich deep water or the formation of corrosion products. The impact of these increases will depend in large part on the amount and chemical form of the metals involved. The free ion activity, not the total metal concentration, determines biological availability and effect. Increases in the bioavailability of micronutrients, e.g., iron, manganese, and copper, could increase production of the algae community. Similarly, toxicity could result from high availability of metals, such as copper, zinc, or cadmium, which could be detrimental to biological production. If the trace metal complement of the effluent water is harmful, the potential biostimulatory effect of upwelled nutrients may either not occur or be unnoticeable. The trace metal complement will change with time through a variety of processes, and a bloom may be merely delayed. With current information it is not possible to predict what

effect the altered trace metal regime will have on the utilization of upwelled macronutrients, nor is it clear whether the effects will differ with location.

### The Potential Range of Ecological Effects Resulting From OTEC Operations

Marine ecosystem impacts which may result from OTEC operations can be described only in very general terms. This section attempts to estimate the upper and lower bounds of these effects for a 40-MWe shorebased plant with the effluent plume coming to equilibrium near the bottom of the mixed layer (see Effluent Discharge section). Impacts which we consider include impingement, primary and secondary entrainment, and nutrient enrichment. This or any estimate of impacts is limited by the environmental data available and by an incomplete understanding of the amounts and types of ecological compensation which may occur. Also, evaluating the importance of projected effects will be particularly difficult and dependent upon resource and system boundaries.

**Impingement**—Impingement rates will depend on volume and speed of the intake waters and the abundance of animals larger than the mesh size of the intake screen and their ability to avoid the intake. An animal's ability to avoid the intake depends on (1) rheotactic behavior, (2) visual perception in low light environments, and (3) swimming speed. Swimming speed depends on (a) species limitations (form or hydrodynamics), (b) temperature, and (c) physical condition. Physical condition depends on (i) nutritional state, and (ii) presence of disease or injury. While neither abundance or avoidance capability is well documented, reasonable estimates are possible. Fish, in general, can swim about 3-6 body lengths per second and will avoid intakes which are visible and in a horizontal flow field (Hocutt and Edinger 1980). With estimated intake velocities of 0.25 to 0.30 m/s (see Seawater Systems section), it is unlikely that fish over 10 cm in length will be impinged, and many smaller ones could probably avoid the screens. The minimum length of fish impinged will be several times the screen mesh size. Thus, most impinged animals will be in a size range probably narrower than from 3 to 10 cm.

While there are no measurements of the absolute abundance of animals susceptible to impingement by an OTEC plant, trawl surveys conducted near Hawaii (Maynard et al. 1975) and Puerto Rico (Vargo et al. 1981) may be used to provide estimates of impingement rate. While catch efficiencies of the trawls are not known, we assume the fishes' susceptibility to capture by net is about the same as by impingement. Although the nets were pulled several times faster than plant intake velocities, most animals caught were of the same small size (<10 cm) which is most susceptible to entrainment or impingement. By adjusting the reported trawl catches for items identified as undersized or soft-bodied (entrainable rather than impingeable) and oversized (those which can probably avoid an intake), we can estimate expected impingement.

In both areas surveyed, fishes were the most abundant group, with crustaceans and cephalopods also present. In Hawaii surface-waters, a combined catch of all three groups was 0.2 mg/m<sup>3</sup> during the day and 5.4 mg/m<sup>3</sup> at night. Micronekton sampling near Puerto Rico revealed an average biomass of 2.7 mg/m<sup>3</sup>. Adjusting the Caribbean catch for the 60% "residue" of entrainable size organisms, which those samples contained, results in estimates of 1.1 and 2.5 mg/m<sup>3</sup> for day and night, respectively, or an average 1.8 mg/m<sup>3</sup> of animals large enough to get caught on surface intake screens. In these samples, there appeared to be few animals

which were large enough to escape intake velocities. In Hawaii the net was pulled faster than in Puerto Rico (1.7 vs 1.0 m/s) and larger animals were collected. Adjusting the nocturnal catch in Hawaii for those fish weighing more than 10 g (those most likely to be able to avoid impingement) results in estimates of the biomass of animals which will be impinged at night (4.6 mg/m<sup>3</sup>). The average impingeable biomass over a 24-hour period is 2.4 mg/m<sup>3</sup>. Similar calculations with data from deeper water result in an estimate of impingeable biomass at the cold water intake of 3.4 mg/m<sup>3</sup> in the Caribbean and 4.2 mg/m<sup>3</sup> in Hawaii.

Multiplying the average concentrations of impingeable biomass from the two studies (2.1 mg/m<sup>3</sup> at the surface and 3.8 mg/m<sup>3</sup> in deep water) times estimated flow rates results in an estimate of impingement rates. A 40-MWe plant with surface and deep intake rates of 120-200 m<sup>3</sup>/s (i.e., 3-5 m<sup>3</sup>·s<sup>-1</sup>·MWe<sup>-1</sup> for each intake; see Seawater Systems section) would probably impinge 20-35 kg live weight daily from the surface water and another 40-65 kg at the cold water intake, roughly in accord (being an order of magnitude less) with the impingement estimated by Sullivan and Sands (1980) for a 400-MWe OTEC plant in similar waters (see Impingement section). These estimates of impingeable biomass are based on the assumption that larger organisms can detect and avoid the intake screens. We are unaware of any measures of the concentration of larger organisms which could be used to estimate impingement rates on a screen which they could not detect; thus, our estimates can serve only as a lower bound. Higher rates are possible, but we have no means of estimating them.

**Primary Entrainment of Plankton**—Plankton entrainment rates are a function of plankton density and the rate of water intake. While the intake rate can be predicted and information on average density of various planktonic groups is available, their vertical stratification is, in many cases, not clearly documented. Those motile organisms which aggregate at particular depths may be entrained at rates vastly different than predicted from their average density in the mixed layer.

Phytoplankton biomass is approximately the same in Hawaii and the Caribbean. In the mixed layer at the Hawaiian Kahe Point OTEC site the median value was 0.10 mg chlorophyll-*a*/m<sup>3</sup> (Uchida 1983). The average of eight published values reported from the Caribbean surface waters (Hoss et al. 1983) is 0.13 mg/m<sup>3</sup>. Judging from chlorophyll-*a* concentration at discrete depths, there is no consistent pattern in the vertical distribution of phytoplankton in the upper 50 m near Hawaii and Puerto Rico (Sands 1980). Thus, average concentrations can be used to estimate phytoplankton entrainment. However, it should be recognized that while mean abundances in Hawaii and the Caribbean are similar, individual measurements showed considerable variation, so the rate of entrainment of phytoplankton may also vary widely over time. To be conservative in estimating the range, extreme lower and upper bounds are assumed to be 0.05 mg/m<sup>3</sup> and 0.25 mg/m<sup>3</sup>.

Daily phytoplankton entrainment by a 40-MWe plant, again with surface and deep-water intake rates each in the range of 120-200 m<sup>3</sup>/s, will probably be between 0.5 kg chlorophyll-*a* (0.05 mg chlorophyll-*a* m<sup>3</sup> and 120 m<sup>3</sup>/s) and 4.3 kg (0.25 mg chlorophyll-*a* m<sup>3</sup> and 200 m<sup>3</sup>/s). Assuming a factor of 100 for relating chlorophyll-*a* to organic carbon (Holm-Hansen 1969), we estimate that the organic carbon of phytoplankton entrained will be in the range 50 to 430 kg C/d. If the chlorophyll-*a* concentration is 0.1 mg/m<sup>3</sup>, a figure frequently used to describe subtropical oceanic water, then phytoplankton entrainment will be in the range 100 to 170 kg C/d.

The zooplankton biomass which is subject to entrainment by an OTEC plant consists of two major fractions: macroplankton caught in conventional nets (200  $\mu\text{m}$  or larger mesh) and microplankton small enough to pass through such nets. The larger animals in surface waters have been studied enough that their density is fairly well known. In Hawaiian water the mean dry weight biomass in the upper 200 m was 4.9  $\text{mg}/\text{m}^3$  and 3.3  $\text{mg}/\text{m}^3$  in two different sets of cruises (Noda et al. 1981b, from Uchida 1983). The average of four published studies from the Caribbean is 2.6  $\text{mg}/\text{m}^3$  (standard error = 0.24). Converting these dry weights to near-surface zooplankton carbon (Wiebe et al. 1975) yields estimates of 1.3  $\text{mg C}/\text{m}^3$  in Hawaii and 0.8  $\text{mg C}/\text{m}^3$  in the Caribbean. Macrozooplankton abundance at cold-water intake depths has not been studied as thoroughly as at the surface. The concentration clearly decreases with depth and will probably be less than 0.24  $\text{mg C}/\text{m}^3$  (Table 6). The 0.24  $\text{mg C}/\text{m}^3$  average estimated from four studies (Table 6) is probably inflated because many of the samples were taken during the day when plankton abundance is greater than the 24-hour average and because we chose the highest of the conversion factors reported for estimating dry weight.

The smaller zooplankton, i.e., microzooplankton, have received little study so estimates of their density are not very precise. While microzooplankton density appears to vary with depth, we averaged measurements from the top 100 m of the photic zone as an indicator of entrainable biomass. A study in Hawaii (Gundersen et al. 1976) showed an average biomass of 0.7  $\text{mg C}/\text{m}^3$ . Holm-Hansen (1969) reported values off southern California of 0.9  $\text{mg C}/\text{m}^3$ . Using 0.08 as a factor to convert displacement volume to carbon (Holm-Hansen 1969) and the volumes given by Beers and Stewart (1969, 1971), we calculate the microzooplankton biomass averaged 2.3  $\text{mg C}/\text{m}^3$  in the eastern tropical Pacific and 1.2  $\text{mg C}/\text{m}^3$  in the California current. From these estimates it appears that microzooplankton abundance is approximately the same as the average macrozooplankton density in Hawaii and the Caribbean (about 1  $\text{mg C}/\text{m}^3$ ). This similarity in biomass of these vastly different sized animals has also been noted by Sheldon et al. (1977). With little information indicating the factors responsible for differences in density of microplankton, a more precise estimate of abundance in surface water is not possible.

With micro- and macrozooplankton densities in the mixed layer each averaging about 1  $\text{mg C}/\text{m}^3$ , the warm water intake of a 40-MWe plant will entrain between 10 and 17  $\text{kg C}/\text{d}$  in each of the zooplankton size categories. For the lack of evidence that microplankton are abundant at such depths, we assumed that entrainment at the cold water pipe will be limited to macroplankton. If deeper water macroplankton are present at a density of 0.2  $\text{mg C}/\text{m}^3$  (Table 6), then entrainment will probably range from 2 to 4  $\text{kg C}/\text{d}$ .

**Secondary Entrainment**—Turbulent mixing will result in a rapid dilution of the effluent water through the entrainment of ambient water (see Effluent Discharge section). As a result, there is a potential for impact on the plankton present in the ambient water as they become entrained into the discharge plume. While it is difficult to predict the scale of impact from this secondary entrainment, the potential effect is considerable. This impact will depend on the abundance of organisms in the dilution water, their sensitivity to the altered water quality, and the amount of water involved.

Secondary entrainment will occur over a narrow depth range. Because of the desire to avoid recirculation of effluent back into the warm-water intake, the discharge location may be below 30 m. Based on the density of the effluent, relative to the density and

**Table 6.—Estimated macrozooplankton carbon density at cold water intake depth.**

Area	Source	Depth of samples (m)	Data provided	Calculated ( $\text{mg C}/\text{m}^3$ )
Hawaii	Uchida 1983	200-1000	0.80 $\text{mg dry wt}/\text{m}^3$	0.26
Pacific (19°C) and Sargasso Sea	Vinogradov 1968	700	0.004 $\text{ml}/\text{m}^3$	0.17
Puerto Rico	Vargo et al. 1981	600-1000	0.0035 $\text{ml}/\text{m}^3$	0.15
Sargasso Sea	Deevey and Brooks 1971	500-1000	0.0108 $\text{ml}/\text{m}^3$	0.45
		1000-1500	0.0046 $\text{ml}/\text{m}^3$	0.19

Calculations used the following conversions: wet weight = 72% of displacement volume; dry weight = 13% of displacement volume; carbon weight = 32% of dry weight (Wiebe et al. 1975)

density gradient of ambient waters near the discharge, the plume will come to equilibrium near the bottom of the mixed layer. Thus, it appears that the dilution water and therefore secondary entrainment of organisms will generally be from depths between 30 and 80 m. However, some recent modeling investigations (Wang 1984) indicate that there may also be an induced upwelling from beneath the plume which would entrain some water from below the mixed layer (see Regional Influence section).

Several characteristics of the effluent (e.g., reduced water temperatures, the presence of a biocide, and a supersaturation of nitrogen gas) may adversely affect secondarily entrained organisms. Assuming a mixed discharge, we estimate that the temperature of the effluent at the point of discharge could be as low as 15°C. While many of the organisms which could be secondarily entrained engage in vertical migrations which expose them to a wide range of temperatures, others, including some of the ichthyoplankton, are not accustomed to such low temperatures. Even thermally tolerant, temperate organisms may be immobilized or killed by sudden exposure to cold temperature (Hoss et al. 1974; Bradley 1978; Stauffer 1980). The probability of mortality is greatest when the animals are living near their lower lethal limit. While most of the important tropical organisms have not been studied for thermal effects, it seems likely that many of those found in surface waters are stenothermal (e.g., tuna larvae) and may be impacted by temperature changes during secondary entrainment.

While biocides will probably be introduced only intermittently and at low concentrations, it is reasonable to assume that if the biocide is concentrated enough to kill fouling organisms it may also affect the more sensitive animals which are secondarily entrained. Prediction of biocide impacts from current information is difficult because most research has involved temperate organisms. Conducting additional research on biocide effects will be difficult because likely effluent concentrations are near the limit of detectability. Whatever biocide effects occur will be greatest in the zone of initial dilution where their concentration is greatest and thermal impacts are largest. Furthermore, previous research has shown that thermal and chlorine effects are synergistic (Hoss et al. 1977). There is also a possibility that temperature or chlorine effects may interact with effects from gas supersaturation. When saturated cold water is brought to the surface and warmed, it will be supersaturated with nitrogen, a condition which has caused fish mortality at other types of power plants.

With all the uncertainty surrounding the effects of water quality on secondarily entrained organisms, any prediction of effects is largely subjective. Until additional information is collected, it is assumed that cold shock effects will be insignificant for short-term temperature drops of less than 2°C, even in combinations with biocide concentrations and nitrogen supersaturation 20% that at the point of discharge. If surface and deep water intake rates are equal, the total discharge rate will be twice the surface intake rate. Assuming the temperature of the mixed layer to be constant, the amount of dilution water required to reduce the temperature difference to 2°C would be 8 times the surface intake rate (a 5:1 dilution being needed to decrease the difference between effluent temperature and ambient temperature to 2°C). With the further assumption that the concentration of biota in the depth interval of 30 to 80 m is the same as used in estimating primary entrainment mortality, an upper limit on secondary entrainment mortality may then be about 8 times that lost to surface primary entrainment. If cold shock rather than exposure to biocides, trace metals, or pressure changes is the major factor involved in the harmful effect of secondary entrainment, then many species may suffer only slightly, the most vulnerable being non-migratory animals. This, unfortunately, includes many fish larvae.

**Impacts on Fishery Food Chains**—Increased fish production can occur through either more primary production or shorter food chains, either of which could result from upwelling of nutrient-rich deep water. Primary production changes will in large part be due to the reaction of algae to nutrient and trace metal characteristics of the effluent plume. If these characteristics stimulate algal growth, fast growing diatoms will in all likelihood account for most of the production (Sunda and Huntsman 1983). If these diatoms are large or chain forming species they can probably be utilized directly by macrozooplankton. This could result in a shorter food chain than would occur if small algae were eaten by microzooplankton which were then eaten by macrozooplankton. Removal of one trophic step could increase fish production 5 to 10 times in the receiving waters.

In general, complex food webs, which occur in potential OTEC areas, are resilient so that most changes have little impact on ecosystem function. Minor changes in the food web, however, may drastically alter our acceptance of the fish produced. For example, blooms of the dinoflagellates which cause red tide or ciguatera can make the fish inedible. Unfortunately, the factors responsible for blooms of these algae are not well enough understood to allow precise estimates of OTEC influence on them. Based on the theory that most red tide outbreaks are associated with terrestrial runoff, they would not be expected as a consequence of OTEC operations. It is possible that minimizing disturbances of the benthic substrate (Bagnis 1981) during construction or operation of an OTEC plant will reduce the likelihood of ciguatera.

The indirect predatory effect of a 40-MWe OTEC plant on carbon or energy flow through the fishery food web is predicted to be minimal. Based on estimates of primary and secondary entrainment and impingement of various organisms by an OTEC plant (Table 7), the number of trophic transfers between the various trophic levels and fishery harvest (Ryther 1969), and an assumed trophic transfer efficiency of 15%, calculations were made of equivalent harvestable stock which would be lost due to OTEC operation. If all the entrained or impinged biomass were removed from the system, then 1.8 to 3.1 fewer kg of carbon would be available as fish harvest each day. Based on a carbon-to-live-weight ratio of 1:10, about 18 to 31 kg of fishery harvest would be lost daily. This probably overestimates actual loss because it is likely that many of the organisms killed will be eaten and thus not be lost from the food web.

Our projection that food chain effects will not significantly impact the fishery does not address direct effects on the harvested species. Many of the fishes are currently being harvested at levels equal to or greater than the Maximum Sustainable Yield (MSY). If such assessment of harvest levels is accurate, then those stocks may not be able to compensate for the individuals lost through entrainment or impingement, and yield will be reduced. Unfortunately, we do not know the fine-scale temporal and spatial distribution of the early life stages of the major species, and thus are unable to predict the number which may be impacted by OTEC operation. In addition, our knowledge of the survival of these early stages is too incomplete to predict the amount of impact on the resource.

### Potential Impact on Fisheries

Defining in detail what constitutes significant adverse impact on fisheries is very subjective. Effects which reduce commercial and recreational fisheries harvest would likely be considered adverse. On the other hand, if the plant were to serve as a fish aggregating phenomenon, harvest efficiency may be increased and the overall effect considered beneficial. However, this potential beneficial effect would have to be weighed against the overall negative effect that aggregation (see Attraction/Avoidance section) may have on entrainment and impingement.

In predicting impacts of conventional power plant operations on fish population levels, scientists have relied on life cycle models which focus on those components of the life cycle which are susceptible to power plant effects at the appropriate stages. Simple models take a gross view of the life cycle, examine the environment in which the species exist, and incorporate details of the plant operations and effects. More complex models account for increased temporal resolution, more detailed environmental variation, and knowledge of behavioral responses to changes in the environment.

**Table 7.—Estimated loss of living carbon and equivalent harvestable stock due to entrainment and impingement during operation of a 40-MWe OTEC plant (kg C/d). (Based on Peters 1983).**

	Phytoplankton	Microzooplankton	Macrozooplankton	Micronekton
Entrainment				
Primary	100 - 170	10 - 17	12 - 21	—
Secondary	800 - 1360	80 - 136	80 - 136	—
Impingement	—	—	—	6 - 10
Total	900 - 1530	90 - 153	92 - 157	6 - 10
Trophic transfers	5	4	2.5	1
Transfer efficiency	-----		0.15	-----
Equivalent harvestable stock	0.07 - 0.12	0.05-0.08	0.80-1.4	0.90-1.5

With OTEC, adverse impacts cannot be examined with any degree of confidence because what information is available on fish eggs and larvae at potential sites is not sufficiently precise. Furthermore, effects from operations of conventional power plants can hardly be extrapolated to that of an OTEC plant because of the unprecedented volume of water the latter is expected to pump and the redistribution of water properties that will occur. However, in the absence of data which can be used as input into a life cycle model, a crude evaluation of OTEC-related impacts on fisheries has been made by Matsumoto (1984) for the purpose of this study.

Based on a review of the combined effects of impingement, direct entrainment, and biocide usage to fish, Matsumoto (1984) concluded that an assumption of total mortality of all fish eggs, larvae and juveniles, directly entrained is not unreasonable. Because the eggs and larvae of most fishes caught commercially off Kahe Point are buoyant and tend to reside near or at the surface, the degree of secondary entrainment of fish eggs and larvae will be very dependent on the discharge depth of the effluent. Little is known regarding the effects of secondary entrainment; however, Matsumoto (1984) believes the effects would be minimal for deep (e.g., 100 m) discharges. More information is needed, however, on the micro-distribution of fish eggs and larvae to judge whether such a conclusion would be justified for shallow discharges where the degree of secondary entrainment may be 10 to 20 times (worst case) that of direct entrainment on the warm water side. If 100% mortality is assumed for both direct and secondary entrainment, one must then ask what effect this will have on fisheries.

Off Kahe Point, the principal fisheries that would be affected by OTEC operations include six pelagic and two demersal fish groups representing 98% by weight of the area's total annual production. The pelagic forms include tunas (mainly skipjack and yellowfin tuna), billfishes (Pacific blue and striped marlin), mahimahi, wahoo, bonefish, and jacks (principally scads), where the demersal forms include goatfishes (six species) and snappers (eight species).

Based on density values of tuna and billfish larvae at depths near the warm water intake and discharge points, and warm and cold water intake rates of 160 m<sup>3</sup>/s (i.e., 4 m<sup>3</sup>·s<sup>-1</sup>·MWe<sup>-1</sup>), Matsumoto (1984) has estimated the extent of damage from the planned Ocean Thermal Corporation plant at Kahe Point. Assuming total mortality during entrainment, it was estimated 13.7 million skipjack and 5.5 million yellowfin larvae will be killed each spawning season. To be more realistic, these mortality figures must be adjusted for natural mortality which is estimated at 93% for skipjack and 91% for yellowfin. This would result in estimates of OTEC-induced mortality of 1.0 million and 0.5 million, respectively. Any effects of secondary entrainment would add to these figures; however, Matsumoto suspects that the effects of secondary entrainment would be minimal.

The OTEC plant is also expected to function as a fish aggregating device and attract fish from adjacent areas. Any increase of large aggregations of fishes, such as tunas, mahimahi, mackerels, and carangids, will eventually result in concentrated spawnings around the plant, subjecting more than the usual amounts of eggs and larvae to entrainment effects.

The impact on fisheries will be largely through the recruitment process. Through recruitment, the impact on pelagic species, particularly tunas, is not expected to be noticeable because most of them are migrants from the eastern Pacific fishery, the northwestern Pacific, and from equatorial waters. The effects of recruitment on bottom and reef-associated fishes would most likely be felt in areas further downstream from the plant site. If the prevailing currents carry the eggs and larvae along the coast and out into open ocean,

the full impact of the damages caused by the plant may not be apparent at the plant site.

Direct effects could occur, however, in the demersal fishery. For the Ocean Thermal Corporation OTEC design for Kahe Point, Oahu (see Application section), warm effluent from the Hawaiian Electric conventional powerplant at Kahe Point is used as a supplementary heat source, and sand particles which are contained in this effluent (McCain 1977; Coles 1980) will eventually be discharged over the escarpment and build up over a period of time, blanketing the rocky bottom near the discharge point. The effect would be to force fishes such as snappers to relocate to other areas. The net effect to the fishery should be negligible, however, since demersal species comprise only a small portion (1.3%) of the total fish production off Kahe Point.

Turning to Puerto Rico, we find that the principal fisheries off Punta Tuna include four demersal and one pelagic fish groups representing 72% of the fish taken along the eastern coastline. The demersal group includes groupers (14 species), grunts (11 species), snappers (14 species), and porgies (3 species); the pelagic group is comprised of mackerels (2 species). Other pelagic fishes, such as tunas, marlins, dolphins, and jacks, comprise 1.8% of the total fish production and are caught in small numbers.

The potential effects of OTEC plant operations on pelagic fishes off Punta Tuna are also believed by Matsumoto (1984) to be insignificant. The effects there on demersal and reef fishes, however, cannot be estimated in the absence of appropriate data and biological information.

## MEASURES TO REDUCE POTENTIAL EFFECTS TO FISHERIES

---

From the previous chapter and background reports, one can conclude that there will remain some level of uncertainty regarding the potential risk to fisheries due to construction and operation of an OTEC plant until a full-scale OTEC operation can be monitored for some period of time. However, certain aspects of an OTEC operation warrant enough concern to examine measures that would minimize the risk to fisheries of early plant operations.

First, from the viewpoint of general environmental risk, proper siting is the single most effective means to minimize the potential for environmental damage. The avoidance of areas of high biological productivity and others of special biological importance (e.g., critical habitats, spawning grounds, coral reefs) is desirable. However, the flexibility in choice of location may be limited in many of the islands that have a suitable thermal resource. For instance, as noted by Uchida (1983), there are a number of sites in Hawaiian waters that satisfy criteria for both nearshore floating and shore-based OTEC power plants. However, on the island of Oahu, only the area along the Waianae coast from Barbers Point to Kaena Point was concluded to meet certain criteria for OTEC siting (Shupe 1982). Along or offshore of this part of the Oahu coast are major coral formations and important commercial and recreational fisheries.

Once the location has been tentatively chosen, preliminary oceanographic information will have to be collected to identify initial engineering flexibility. This will include information on the thermal resource, waves and tides, currents, and extreme oceanographic events.

The power produced, and thus the cost-effectiveness of a plant, is highly dependent upon the thermal resource ( $\Delta T$ ). For an island plant, the site selected will therefore have to offer a suitable thermal

resource within a reasonable distance of shore. One of the major trade-offs for the conceptual design by Ocean Thermal Corporation for Kahe Point, Oahu, Hawaii (Ocean Thermal Corporation 1983), was the distance offshore for placement of their “artificial island” system. The artificial island would require greater structural and construction costs in deeper waters; however, greater distances offshore also reduce the cost of the cold water pipe (i.e., less length) required to achieve a certain  $\Delta T$ . Greater distances offshore also reduce the cost of effluent pipes. The study conducted by OTC indicated that a plant in about 15 m of water was optimal for their design.

Assuming normal operation of an OTEC plant at a suitable location, the most important design features for which there is some flexibility to reduce the potential threat to fisheries are the cold water intake, warm water intake, discharge, and chemical additions. These topics are discussed in the following sections.

### Cold Water Intake

Generally, reviews by Hoss and Peters (1983) and Uchida (1983) reveal that the direct environmental implications of the deep water intake of cold water are small. The depths involved are below the euphotic zone, estimated to be in the range of 100-150 m in subtropical waters of the Caribbean and the Pacific. As a consequence, the entrainment of phytoplankton by the cold water pipe (CWP) is not a concern.

The information on zooplankton distributions indicated that the CWP will entrain certain zooplankton. It is also apparent that the deeper the placement of the CWP intake, the fewer the number of zooplankton that will be entrained. If the CWP intake could be placed beneath the zone within which certain zooplankton undergo diel migrations (see Zooplankton section), this would also help to minimize entrainment. However, the extension of the CWP to depths deeper than necessary to achieve the needed  $\Delta T$  would be very expensive, since this is one area where present technology is being advanced. This could also totally upset the financial aspects of a plant since the CWP construction and deployment costs will comprise a major percentage of the total construction and deployment costs.

It might be argued that the cost of extending the CWP to deeper depths to achieve less entrainment of zooplankton would be offset by a decrease in seawater volume requirements, and thus pumping requirements, if a sufficiently greater  $\Delta T$  was obtained. Although such trade-offs will have to be examined on a site-specific basis, such factors tend to balance out when consideration is given to other factors such as the increase in pipe frictional losses. Any extension of the CWP is going to be expensive. Furthermore, although deep zooplankton play a role in the food web and thus fisheries, it is not a well defined role as yet. Therefore, the true benefit of trying to avoid deep zooplankton entrainment cannot be quantified with the present state of knowledge.

As noted by Hoss et al. (1983) and in the section on Eggs and Larvae of Important Species, little information is available on the vertical distribution of fish eggs and larvae in the Caribbean and Pacific. However, it appears that they are most abundant in the upper 25 m, particularly at night. Although Miller (1979) suggests there may be a deep source of certain larvae in waters nearshore Kahe Point, few larvae are found below 200 m. The relative lack of information on fish larvae suggests that additional information should be gathered at specific OTEC sites when a design is contemplated.

The most significant environmental implication of the CWP in-

take would appear to be related to the intake in these deep waters of nutrients and other natural chemical constituents, which are generally present in greater concentrations here than in surface waters (NOAA 1981a). Since the potential environmental impact does not relate to the intake as much as to the discharge of these constituents back to the ocean near the surface, this topic is taken up under discharges (see Discharge Location and Configuration).

To conclude this section, it is suggested that for most situations the placement and configuration of the CWP will be driven by economic considerations. However, the lack of flexibility in design does not seem to imply any significant disadvantage in terms of potential environmental impact and risk to fisheries.

### Warm Water Intake

As discussed under Biological Interaction with the Environment, the warm water intake will have significant interaction with the biological environment, entraining or impinging phytoplankton, zooplankton, ichthyoplankton, and fish.

Generally (see Phytoplankton), the concentration of phytoplankton increases near tropical and subtropical islands due both to the upwelling of nutrients from depths as well as a greater input of nutrients from the land mass. Also, in both the Caribbean and Pacific areas under discussion, the levels of maximum phytoplankton biomass tend to be near the 100-m level, near the bottom of the mixed layer. For instance, for waters off Keahole Point, Hawaii, Noda et al. (1980) reported that the subsurface chlorophyll maximum occurred between 64 and 94 m. Chlorophyll-*a* levels tended to be relatively constant in the top 40 m or so of the water column. In general, they increase below this level to the levels found at the chlorophyll maximum and then quickly decrease to very low values, with the lowest values occurring beneath the euphotic zone. As noted by Uchida (1983) for six cruises in the Kahe Point environment, Noda et al. (1981a) observed that the chlorophyll maximum remained relatively constant in its vertical position at 86 m as well as in its concentration. Furthermore, this layer accounted for 77% of the chlorophyll biomass in the photic zone.

The discussion in the section Impacts on Fishery Food Chains suggests that the predatory effect on harvestable fish stock caused by any food chain effect of the entrainment of phytoplankton is not a concern. However, where the design flexibility exists, it is probably prudent to avoid the direct entrainment of phytoplankton to the extent practicable. In light of the information on phytoplankton distributions, this would suggest that the warm water intake of an OTEC plant should probably be located in shallow water (i.e., 0-40 m). The secondary entrainment of phytoplankton is a separate issue and is discussed under the next section.

As discussed in the Zooplankton section, the abundance of zooplankton tends to be greatest near the level of the chlorophyll maximum, particularly at night when many zooplankters migrate from both deeper and shallower waters to this level. Thus, the avoidance of zooplankton to the extent practicable also suggests relatively shallow warm-water intake depths. However, as in the case of phytoplankton, the effect on fish stocks due to the predation of zooplankton by an OTEC plant of 40-MWe capacity is not expected to be significant (see Impacts on Fishery Food Chains).

Like phytoplankton, zooplankton also exhibit an island mass effect with concentrations higher at nearshore locations (see Zooplankton section). However, as evident in Table 8 for Caribbean waters, the gradient in surface zooplankton concentration is not great enough to warrant the extension, for a land-based plant,

**Table 8.—Mean displacement volume, dry weight, and abundance of surface zooplankton at island sites in the Caribbean. All samples were taken with 203  $\mu\text{m}$  or 239  $\mu\text{m}$  mesh nets (from Hoss et al. 1983).**

Location	Distance offshore (km)	Water depth (m)	Displacement volume ( $\text{ml}/\text{m}^3$ )	Dry weight ( $\text{mg}/\text{m}^3$ )	Abundance ( $\text{no.}/\text{m}^3$ )	Source
Puerto Rico	0.5-1.0	10	0.086	—	818	Youngbluth 1979
Barbados	<1	10	0.049	4.00	—	Sander and Steven 1973
Barbados	2	25	0.041	3.05	345	Moore and Sander 1976
Barbados	10	460	0.028	2.40	368	Sander and Steven 1973 Moore and Sander 1977
Jamaica	1	35	0.043	8.28	1600	Moore 1967
Jamaica	8	900	0.021	3.30	823	Moore 1967

of a warm water intake to waters, say, 10 km offshore. For instance, the data suggest that the entrainment of zooplankton might be halved for an extension of the intake from less than 1 km to, say, 10 km. However, the suggestion of an insignificant effect of zooplankton entrainment on fisheries would not justify the benefit of this entrainment reduction, if indeed it was to be realized. On the other hand, if there was some flexibility over the location of the plant, e.g., whether it could be land-based or a shelf-sitter, the shelf-sitter with its location and intake being further offshore might imply a lower environmental risk on qualitative grounds, other factors being equal.

The only conclusion which can be drawn from observations of larval fish (see Eggs and Larvae section) is that the actual distributions may be quite complex. The implication is that the spatial/temporal and species distribution of larval fish should be determined before engineering flexibility in the location of the warm water intake is considered.

From the standpoint of impingement and entrainment of adult fish, the warm-water intake velocity is a critical factor with lower velocities being more desirable (see Impingement section). The general guideline regarding velocities for conventional power plant intakes is to keep the velocity below 15 cm/s so as to allow fish to escape the screen wells (U.S. Environmental Protection Agency 1973). Although the effectiveness of velocity caps (covers used to create horizontal velocity fields for a vertical intake) to reduce fish entrainment is not universally accepted, EPA recommends their use for offshore, submerged intakes; the principle is that fish tend to avoid horizontal velocity fields more so than vertical ones (see Impingement section).

### Discharge Location and Configuration

The discharge of effluent waters from an OTEC operation has important implications for both the operation of the plant and its environmental effect. It is of great importance that discharge waters not recirculate to the warm water intake and thereby reduce the effective thermal resource of the plant. However, for most situations the negative buoyancy of the discharge plume and the initial dilutions achieved (see Effluent Discharge section) should assure that recirculation is not a problem. It is also of great importance that a discharge scheme be chosen so as to minimize the potential effects to fisheries and other biological resources. As discussed, the initial and, to a certain extent, subsequent fates of the effluent plume will be very dependent upon the density of the discharge, the configuration of the discharge outlet, the vertical ambient density distribution, and the presence of currents.

Several discharge situations were examined in the Effluent Dis-

charge section: separate and mixed discharges from a 40-MWe OTEC plant to two water types that are representative of situations found offshore of Kahe Point, Oahu, and Punta Tuna, Puerto Rico. Discharges at depths of 20 m and 100 m were considered for both situations.

For the Kahe Point case considered, the upper 50 m were fairly mixed so that there was little stratification in density. The calculations showed that there would be little impedance to the sinking of effluent plumes, whether mixed or separate, until a depth of 50-100 m was reached. Discharges at 100 m did not stray too far from that depth because of the stronger stratification there. Calculated dilutions were in the range of 4-7.

The Punta Tuna case was somewhat different because of the stronger density stratification present. A separate warm water discharge at 20 m fell to 30 m, achieving a dilution of about 4; whereas a separate cold water discharge fell further, to 55 m with a dilution of 5.5. A separate warm water discharge at 100 m rose, because of its positive buoyancy at that depth, to 75 m with a dilution of 5; the separate cold water discharge at 100 m fell to 160 m with a dilution of 7. A mixed discharge at the 20-m depth fell 25 m to a depth of 45 m with a dilution of 4.5, and a mixed discharge at 100 m fell 15 m to 115 m with a dilution of 5.

Although the examples offered are limited, they do provide an indication as to how the level of neutral buoyancy (where the density of the plume equals that of the ambient waters) and dilutions are affected by the type of discharge. For a given situation, larger differences in density between the discharge and receiving waters will involve longer trajectories and higher dilutions before a neutral buoyancy is achieved. This may be desirable if dilution and removal of certain constituents (e.g., chlorine) from the immediate environment is desired. However, it might be undesirable if the redistribution of organisms is a concern, or if the utilization of nutrients from the cold water is possible and desired. Long trajectories and high dilutions also result in larger secondary entrainment of the organisms which could have an effect many times that of primary entrainment.

This brief treatment of discharge schemes provides only a glimpse of the discharge possibilities and how they might be used to advantage. The presence of currents, occurrence of coastal upwelling, and placement of the plant will greatly influence the final schemes chosen. Also if the plant is land-based, an artificial island, or a shelf sitter, the presence of the seabed may influence the selection. For example, a mixed effluent discharged to shallow waters will probably hit the seabed before it reaches its level of neutral buoyancy. This would affect the rate of subsequent dilution and also cause impact to benthic biological resources in the area, such as corals. It is obvious that the discharge scheme, more so than either of the intakes, will have to be fine-tuned to the environmental conditions at a site.



## Chemical Additions

Chemicals will be added to the seawater pumped through an OTEC plant by the corrosion/erosion of heat exchanger surfaces, the addition of biocides to control the biofouling of heat exchanger surfaces, and the leaking of working fluids. The release rates will be determined by both the engineering design and the biological-chemical characteristics of the local ambient waters. For the most part, the normal release of working fluids and metals from heat exchanger and other surfaces is not expected to be a problem (see Chemical Additions section).

Given that a biocide such as chlorine may be a necessary evil for an OTEC operation, a certain amount of engineering flexibility can still be utilized to reduce the degree or scale of potential effects. All of the previously discussed options are definite candidates (i.e., plant location and intake/discharge schemes). For instance, achieving a high dilution and a level of neutral buoyancy below the euphotic zone may be very desirable to limit the exposure of biota to the biocide. This would require the identification of a certain optimal discharge scheme. In addition, certain dosing schemes can be used.

Flexibility in biocide dosing might involve applying the biocide to different power modules at different times and mixing the dosed module effluent with other module effluents to create some degree of pre-dilution. For instance, if a 40-MWe OTEC plant was composed of four 10-MWe modules and the condenser and evaporator could be dosed separately, a certain dose to one of the evaporator units and subsequent mixing with the total warm and cold water discharge would produce a dilution of 8 to 1 prior to discharge. In other words, a free residual chlorine level of 0.05  $\mu\text{g/g}$  in the effluent of the evaporator or unit in question would be diluted to 0.006  $\mu\text{g/g}$  before discharge to the environment. Initial dilutions of 5 to 10 could further reduce these concentrations to 0.0012 and 0.0006  $\mu\text{g/g}$ , respectively.

## RESEARCH PRIORITIES

---

The preceding sections have presented information and inferences regarding the potential effects of OTEC operations on fisheries. The discussions have primarily relied upon information on power plant effects in temperate waters and the limited biological information available for tropical waters. Although such an assessment provides valuable insights regarding the effects of early small-scale OTEC development, a more thorough assessment will eventually be needed. To do so will require much additional research of both generic and site-specific types as defined below. However, although further research is needed, the preceding sections also allude to areas where additional information is either not needed or deemed to be unimportant. Specifically, the assessments in the Biological Interactions section of the predatory effect of an OTEC plant on phytoplankton and zooplankton (with the exception of ichthyoplankton) would suggest that the effect is so minimal as to not warrant further investigation of this topic. As emphasized below, additional information on the eggs and larvae of fish is direly needed.

### Investigations of Fish Distribution

There is almost no quantitative information available on the distribution of the early life stages (eggs to juveniles) of fish in tropical waters. Both spatial and temporal information of this type is needed

and should be given high priority, in order to determine the potential numbers of fish that will be subjected to impingement and primary and secondary entrainment. An understanding of the distribution of fish in the water column may allow plant modifications to be made that will help decrease the environmental impact of OTEC operations.

### Studies on the Effects of Entrainment

Primary and secondary entrainment effects associated with OTEC are potentially important because of the extremely large volumes of water involved. Unlike conventional power plants where organisms experience an increase in temperature as they pass through the condensers, larval fish entrained in an OTEC plant will be subjected to a decrease in temperature of about 2°C upon passage through the evaporators. Additionally, in the case of a mixed discharge, organisms entrained in the warm water intake will be further subjected to a decrease in temperature of about 10°C when the warm and cold waters are mixed. Depending on where this discharge is made, secondary entrainment may expose additional organisms to some temperature decreases.

Since we found no reported work on the effects of cold shock on the young of tropical fish, research on this subject was initiated by the National Marine Fisheries Service. This research is examining the effects of cold shock (using realistic decreases in temperature) that could occur as a result of entrainment. In the future, factors such as the addition of biocides and increased levels of trace metals in the water should be examined in conjunction with the temperature studies.

### Biostimulation/Inhibition

The OTEC plants are unique in their utilization of cold water from the deep ocean. This use of large amounts of deep ocean water creates a potential for changes in the upper part of the water column similar to those caused by natural upwelling. The increased nutrient load of cold, deep ocean waters may have stimulating, inhibiting, or no effects on the productivity of marine fisheries.

Although some experiments have described the effect of mixing deep water with surface waters at potential OTEC sites (e.g., Quinby-Hunt 1979; Szyper et al. 1984), further work is needed. This research should look at nutrient and trace metal distributions of waters from different depths and test their ability to affect primary production and species composition. This type of research can be completed in a relatively short time, and the results must then be combined with the effects of natural nutrient fluxes to determine the ecological significance of potential changes in primary production.

### Early Life History Studies

It appears that the major direct impacts of OTEC operations on fish will be on the early stages in their life history. In order to evaluate OTEC impacts on these stages, we need more information on their abundance, distribution, migration, and growth and mortality rates. Generic information on tropical species is lacking and general principles may be applicable to many species. Such information should be collected, starting with some of the major recreational and commercial species. The duration for this type of research is in years, but specific parts can be completed in less time.

## Dynamics of Fishery Populations

The research priorities outlined above are directed at establishing the effects of OTEC operations on the biological community which supports and includes harvested fishery populations. Such research should indicate whether effects may be positive or negative and supply information needed to predict the number and life stage of fish directly impacted. In order to evaluate any such effects as they relate to commercial or recreational fisheries, additional information is needed. For example, while some information is available on many of the fisheries, much more is needed, including:

- 1) Stock structure (i.e., the number and geographic distribution of the stocks);
- 2) stock assessment over time, which depends upon age distribution of the stocks, size at age, and age-specific fecundity,
- 3) accurate catch and effort statistics, and
- 4) increased information about the factors affecting recruitment, including development of models to predict compensation for mortality at various early life stages.

Although parts of this research area can be performed over short time scales, the topic as a whole will require years to address adequately.

## Ciguatera

Independent of other impacts, fisheries could be severely impacted if the fish present were inedible due to ciguatera fish poisoning, which occurs in many tropical waters. Current information is inadequate to predict or prevent such an occurrence, and additional information is needed, including a description of the environmental factors responsible for blooms of the toxin-producing algae, methods of easily detecting contaminated fish, and methods of mitigation.

## Construction Effects

Further research is also needed to properly assess the effects from disturbances to the environment (including the fisheries) by actual construction of the OTEC facility. Any dredging in open seas will generate turbidity and sedimentation, not only in the immediate area of construction but also in adjacent areas. Sediment in the dredging plume will settle out of the water column, covering and perhaps killing some benthic life, including, possibly, coral communities. Dredging has also been found to be correlated with outbreaks of ciguatera poisoning. Thus, in addition to the information needed on ciguatera, there is a need to gather data on effects of sediments on coral reef ecosystems as well as on the downstream extent of the dredging plume.

## CONCLUSIONS

This report examines the potential impact to fisheries due to the operation of ocean thermal energy conversion (OTEC) plants. The effort is primarily a synthesis of existing information that has pertinence to the topic, and an extrapolation to conditions brought about by OTEC operations. The intent was to gain a perspective of the potential risk to fisheries, to identify practicable measures that would reduce the potential for problems, and to suggest research areas where significant uncertainties exist, uncertainties that under certain conditions might impede the commercial development of OTEC.

The report focused on two regions where U.S. OTEC interests might lie: the Caribbean and the Pacific. It also focused on near-shore operation of OTEC as compared to open ocean application; the rationale here is that the nearshore area is considered to be the more ecologically sensitive as well as more likely to see OTEC development in the near term. Additionally, the report has contained itself primarily to those factors of concern that would be associated with the normal operating conditions of an OTEC plant: the impingement and direct entrainment of biota, the secondary entrainment of biota, the redistribution of ocean water properties, and the addition of biocides and other chemical constituents. These concerns are highlighted by the relatively large volume of water that will be pumped through OTEC plants.

Fish impingement rates caused by these flows will depend on the abundance of fish which are larger than the mesh size of an OTEC intake screen and on the ability of the fish to avoid the intake. Although this avoidance ability will also depend on a number of factors, it can be increased through the use or creation of horizontal intake flow fields. It can also be increased by keeping the flow speeds as low as practicable. It is estimated that a 40-MWe Hawaiian or Puerto Rican OTEC plant would impinge about 20-35 kg of organisms daily, due to the warm water intake, and another 40-65 kg at the cold water intake. It is estimated that the effect on a fishery of such impingement rates will be negligible compared to other pressures on a fishery; however, the use of the above mitigating measures and attempts to locate intakes away from areas of high biological activity are recommended.

Organisms, including fish eggs and larvae, that are caught up in the intake flows and not impinged, will be entrained, travel through the plant, and then be discharged. Although the combined effect of the various stresses that these entrained organisms would undergo is difficult to quantify with accuracy, it is considered prudent to assume 100% mortality until better knowledge is available. Additionally, entrainment mortality will be added to by the secondary entrainment of organisms. This entrainment is due to a discharge plume that, in falling or rising to find its level of neutral buoyancy, entrains surrounding water and biota as it is diluted. With typical dilution ratios expected to be in the range of 5:1 to 10:1, the level of secondary entrainment may be quite high. However, until further information is gathered, assessments of the associated mortality are very subjective. It is concluded that cold shock to biota may be the main concern with secondary entrainment and that organisms may only suffer slightly. However, the most vulnerable of the organisms will be the non-migratory species; and these, unfortunately, include many larvae.

OTEC plants have the potential of influencing the food chains leading to fish in several ways. Increased fish production can occur through either more primary production or shorter food chains, either of which could result from the "pumped upwelling" of nutrient-rich deep water. On the other hand, minor changes in food webs may drastically alter our acceptance of the fish produced. For example, blooms of the dinoflagellates which cause red tides or ciguatera can make the fish inedible. Although more information is needed on such processes, red tide outbreaks are not expected and the minimization of benthic disturbances during OTEC construction and operation will reduce the likelihood of ciguatera outbreaks.

In trying to examine impacts to fisheries due to mortalities associated with OTEC operations, one key problem is the lack of detailed information on the spatial and temporal distribution of fish eggs and larvae, the natural mortality of most fish, and the range of natural variability associated with the various life stages of fish.

This results in a low degree of confidence in anything beyond rather subjective conclusions. However, even these conclusions are valuable until further information is gained.

Design measures that might be taken to reduce the potential risk to fisheries relate to the location of the plant, location and configuration of the intakes and discharges, and the mode of introducing biocides to the system. From the viewpoint of general environmental risk, proper siting is the single most effective means to minimize the potential for environmental damage. Here, the avoidance of areas of high biological productivity and of others of special importance (e.g., critical habitats, spawning grounds, coral reefs) is desirable.

For most situations the placement and configuration of the cold water pipe will be constrained purely by economic considerations. However, the perceived lack of flexibility does not seem to imply any significant disadvantage in terms of potential environmental impact and risk to fisheries. Regarding the warm water intake, it is felt that more information is needed on the microscale distribution of fish eggs and larvae. However, in general, it is believed that warm water intakes placed below the surface, where many fish eggs tend to concentrate, and above the chlorophyll maximum may be most desirable. This suggests a placement between about 10 and 40 m. Additionally, if there was some flexibility over the location of the plant, particularly its warm water intake, a plant located further offshore might imply a lower environmental and fishery risk on qualitative grounds, other factors being equal.

The placement and configuration of discharges will be a very site-specific consideration. Mixed vs. separate, and deep vs. shallow, discharges can achieve different dilutions and levels of neutral buoyancy. Different permutations have implications regarding the utilization of cold water nutrients, the potential for recirculation into the warm water intake, the degree of secondary entrainment, the amount of cold shock, and the concentration of biocides. Brief treatment of the possibilities suggests that in deeper waters the discharge of a mixed effluent near the surface would offer a number of advantages. First, the cost of the discharge structure is minimized. Second, the plume, because of the density addition provided by the mixed cold water, would probably sink deep enough to avoid problems of recirculation into the warm water intake. Third, sufficient dilution would be imparted to minimize potential problems with biocides and other trace constituents. Also, the mixed discharge would minimize the degree of cold shock to organisms secondarily entrained. However, with the discharge near the surface, there may be some impact associated with the entrainment of ambient water and organisms into the discharge plume.

The presence of currents, occurrences of coastal upwelling, and placement of the plant will also influence the final discharge scheme chosen for a particular plant. For instance, for a land-based or very nearshore plant, the effluent from a nearsurface discharge will probably hit the seabed and roll down it before the level of neutral buoyancy is reached. Depending upon a number of factors, e.g., benthic resources, this might necessitate a deep discharge.

In general, it is not believed that the effect of the corrosion products of metals will be a problem with OTEC. However, the addition of chlorine as an antifoulant over long time periods does create some concern. Although more information is needed on the chemistry and long-term effects of chlorine, this concern is lessened through the achievement of high dilutions of the biocide and/or a level of neutral buoyancy near the bottom of the euphotic zone. Certain dosing schemes can be utilized to achieve predilutions that, combined with the initial dilution process would result in much lower levels of biocides in the environment.

In conclusion, the potential risk to fisheries of OTEC operations is not judged to be so great as to not proceed with the early development of OTEC. Due to the lack of a suitable precedent, however, there will remain some level of uncertainty regarding these initial conclusions until a pilot plant operation can be monitored for some period of time. In the meantime, further research on fisheries should be undertaken to assure an acceptable level of risk regarding the larger commercial OTEC deployments.

## REFERENCES

- ADAMS, J. R.  
1969. Ecological investigations around some thermal power stations in California tidal waters. *Chesapeake Sci.* 10:145-154.
- AHLSTROM, E. H.  
1971. Kinds and abundance of fish larvae in the eastern tropical Pacific, based on collections made on EASTROPAC I. *Fish. Bull., U.S.* 70:3-77.  
1972. Kinds and abundance of fish larvae in the eastern tropical Pacific on the second multivessel EASTROPAC survey, and observations on the annual cycle of abundance. *Fish. Bull., U.S.* 70:1153-1242.
- ALLENDER, J. H., J. D. DITMARS, R. A. PADDOCK, and K. D. SAUNDERS.  
1978. OTEC physical and climatic environmental impacts: an overview of modeling efforts and needs. *In Proceedings, 5th Ocean thermal energy conversion conference*, pp. III-165 - III-185. Conf-780236, U.S. Department of Energy, Wash., D.C.
- AVERY, W. H., D. RICHARDS, and G. L. DUGGER.  
1985. Hydrogen generation by electrolysis, and economical energy transfer to world markets via ammonia and methanol. *Intl. J. Hydro. Energy* 10(11): 727-736.
- BAGNIS, R.  
1981. L'ichtyosarcotisme de type ciguatera: Phenomene complexe de biologie marine et humaine. *Oceanol. Acta* 4(3):375-387.
- BAINBRIDGE, R.  
1960. Speed and stamina in three fish. *J. Exp. Biol.* 37:129-153.
- BATHEN, K. H.  
1975. Oceanographic and socio-economic aspects of an ocean thermal energy conversion pilot plant in subtropical Hawaiian water. *Proceedings, Third workshop on ocean thermal energy conversion (OTEC)*. Report APL/JHU SR 75-2, The Johns Hopkins University, Applied Physics Laboratory, Laurel, MD., 232 p.  
1977. The Behavior of nearsurface ocean currents, plankton biology, benthic currents and ocean temperatures to depths of 2200 feet at a potential OTEC site off Keahole Point, Hawaii. A report submitted to State of Hawaii, Department of Planning and Economic Development, by Department of Ocean Engineering, College of Engineering, University of Hawaii, Honolulu, 92 p.  
1978. Circulation atlas for Oahu, Hawaii. University of Hawaii Sea Grant College Program, UNIHI-SEAGRANT-MR-78-05, Honolulu.
- BECKER, C. D., R. G. GENOWAY, and M. J. SCHNEIDER.  
1977. Comparative cold resistance of three Columbia River organisms. *Trans. Am. Fish. Soc.* 106:178-184.
- BEERS, J. R., D. M. STEVEN, and J. B. LEWIS.  
1968. Primary productivity in the Caribbean Sea off Jamaica and the tropical North Atlantic off Barbados. *Bull. Mar. Sci.* 18:86-104.
- BEERS, J. R., and G. L. STEWART.  
1969. Micro-zooplankton and its abundance relative to the larger zooplankton and other seston components. *Mar. Biol.* 4:182-189.  
1971. Microzooplankton in the plankton communities of the upper waters of the eastern tropical Pacific. *Deep-Sea Res.* 18:861-883.
- BIENFANG, P. K., and J. P. SZYPER.  
1982. Photosynthetic response of subtropical phytoplankton populations to deep water nutrient enrichment. Report LBID-467, Lawrence Berkeley Lab., Univ. Calif., Berkeley, 24 p.
- BISHAI, H. M.  
1960. The effect of water currents on the survival and distribution of fish larvae. *J. Cons. Perm. int. Explor. Mer.* 25:134-146.
- BLAXTER, J. H. S.  
1966. The effect of light intensity on the feeding ecology of herring. *Brit. Ecol. Soc. Symp.* 6:393-409.  
1969. Development: eggs and larvae. *In* W. S. Hoar and D. J. Randall (eds.), *Fish physiology*, Vol. 13, Reproduction and growth, bioluminescence pigments and poisons, p. 177-252. Academic Press, New York.

- BLAXTER, J. H. S., and D. E. HOSS.  
1979. The effect of rapid changes of hydrostatic pressure on the Atlantic herring *Clupea harengus* L. II. The response of the auditory bulla system in larvae and juveniles. *J. Exp. Mar. Biol. Ecol.* 41:87-100.
- BRADLEY, B. P.  
1978. Genetic and physiological flexibility of a calanoid copepod in thermal stress. *In* J. H. Thorp and J. W. Gibbons (eds.), *Energy and environmental stress in aquatic systems*, p. 452-469. U.S. Department of Energy, Wash., D.C. (Available from NTIS: CONF-771114.)
- BRAUM, E.  
1964. Experimentelle untersuchungen zur ersten nahrungsaufnahme und biologie und jungfischen von blaufelchen (*Coregonus wartmani* Bloch), Werssfelchen (*Coregonus fera jurine*) and Hechten (*Esox lucius* L.). *Arch. Hydrobiol* 28(2/3):183-244.
- BRETT, J. R.  
1956. Some principles of the thermal requirement of fishes. *Q. Rev. Biol.* 31:75-87.
- BREWSTER, J. H.  
1979. Land-based OTEC plants - Cold water pipe concepts. *In* G. L. Dugger (ed.), *Ocean thermal energy for the 80's*. Proceedings, 6th OTEC conference, p. 5.10-1 to 5.10-6. U.S. Department of Energy, Wash., D.C.
- CARLISLE, J. G., C. H. TURNER, and E. E. EBERT.  
1964. Artificial habitat in the marine environment. *Calif. Dep. Fish and Game, Fish Bull.* 124, 113 p.
- CHITTENDEN, M. E.  
1972. Responses of young American shad, *Alosa sapidissima*, to low temperatures. *Trans. Am. Fish. Soc.* 4:680-685.
- COLES, S. L.  
1980. Annual report — Kahe generating station NPDES monitoring program, Vols. I-II. Hawaiian Electric Company, Inc., Honolulu, unpagged.
- DEEVEY, G. B.  
1971. The annual cycle in quantity and composition of the zooplankton of the Sargasso Sea off Bermuda. I. The upper 600 m. *Limnol. Oceanogr.* 16(2): 219-240.
- DEEVEY, G. B., and A. L. BROOKS.  
1971. The annual cycle in quantity and composition of the zooplankton of the Sargasso Sea off Bermuda. II. The surface to 2000 m. *Limnol. Oceanogr.* 16(6):927-943.
- DEKHNIK, T. V., M. HUARES, and D. SALABARIYA.  
1973. Distribution of pelagic eggs and larvae of fishes in the coastal waters of Cuba. *In* *Investigations of the Central American seas*, p. 189-241. [Translated from Russian.] Published for Smithsonian Institution and National Science Foundation, Wash., D.C., by Indian National Scientific Documentation Centre, New Delhi, India (Available from NTIS:TT70-57762).
- DITMARS, J. D.  
1979. Assessment and control of OTEC physical environmental impacts. *In* Proceedings, Environmental control symposium, p. 142-151. Report DOE/EV-0046, Vol. 3, U.S. Department of Energy, Wash., D.C.
- DITMARS, J. D., and R. A. PADDOCK.  
1979. OTEC physical and climatic environmental impacts. *In* Proceedings, 6th OTEC conference, p. 13.11-1 to 13.11-8. U.S. Department of Energy, Wash., D.C.
- DRAGESUND, O.  
1958. Reactions to artificial light, with special reference to large herring and spring herring in Norway. *J. Cons. Int. Explor. Mer* 23:213-227.
- DUGAS, R., V. GUILLORY, and M. FISCHER.  
1979. Oil rigs and offshore sport fishing in Louisiana. *Fisheries* 4(6):2-10.
- DUGGER, G. L., D. RICHARDS, E. J. FRANCIS, L. L. PERINI, W. H. AVERY, and P. J. RITZCOVAN.  
1982. OTEC energy products and GEOTEC plants. ASME Solar energy technical conference, April 1982. American Society of Mechanical Engineers, 11 p.
- EG&G, ENVIRONMENTAL CONSULTANTS.  
1980. Current observations offshore Keahole Point, Hawaii, 24 July to 19 September 1980. Preliminary data report prepared for Lawrence Berkeley Laboratory by EG&G, Waltham, MA, 34 p.
- EL-SAYED, S. J., and S. TAGUCHI.  
1979. Phytoplankton standing crop and primary productivity in the tropical Pacific. *In* J. L. Bischoff and D. Z. Piper (eds.), *Marine geology and oceanography of the Pacific manganese nodule province*, p. 241-286. Plenum Press, N.Y.
- EHRlich, K. F.  
1977. Inhibited hatching success of marine fish eggs by power plant effluent. *Mar. Pollut. Bull.* 8:228-229.
- FISCHER, H. B., J. IMBERGER, E. J. LIST, R. C. Y. KOH, and N. H. BROOKS.  
1979. *Mixing in inland and coastal waters*. Academic Press, New York, 483 p.
- FRANCIS, E. J., and G. L. DUGGER.  
1980. Promising applications of OTEC. *In* Proceedings, 7th Energy technology conference. U.S. Department of Energy, Wash., D.C.
- GENERAL ELECTRIC.  
1983. Ocean thermal energy conversion pilot plant program - Draft final conceptual design report. Prepared for U.S. Department of Energy under Contract DE-ACO1-82CS80000. General Electric Company, Advanced Energy Programs Department, Schenectady, New York. Unpagged.
- GOODING, R. M., and J. J. MAGNUSON.  
1967. Ecological significance of a drifting object to pelagic fishes. *Pac. Sci.* 21:486-497.
- GRITTON, E. C., R. Y. PEI, J. AROESTY, M. M. BALABAN, C. GAZLEY, R. W. HESS, and H. KRASE.  
1980. A quantitative evaluation of closed-cycle ocean thermal energy conversion (OTEC) technology in central station applications. Report R-2595-DOE prepared for the U.S. Department of Energy by the Rand Corporation, Santa Monica, CA, 126 p.
- GUNDERSEN, K. R., J. S. CORBIN, C. L. HANSON, M. L. HANSON, R. B. HANSON, D. J. RUSSELL, A. STOLLER, and O. YAMADA.  
1976. Structure and biological dynamics of the oligotrophic ocean photic zone off the Hawaiian Islands. *Pac. Sci.* 30:45-68.
- HARADA, T., S. MIYASHITA, and H. YONESHIMA.  
1978. Effect of water temperature on yellowfin tuna hatching. [In Japanese, English synopsis]. *Mem. Fac. Agric. Kinki Univ.* 13:29-32.
- HARGRAVES, P. E., R. W. BRODY, and P. R. BURKHOLDER.  
1970. A study of phytoplankton in the Lesser Antilles region. *Bull. Mar. Sci.* 20(2):331-349.
- HARTWELL, S. I., and R. C. OTTO.  
1978. Swimming performance of juvenile menhaden (*Brevoortia tyrannus*). *Trans. Am. Fish. Soc.* 107:793-798.
- HETTLER, W. F.  
1979. Swimming speeds of juvenile estuarine fish in a circular flume. *Proc. Annu. Conf. Southeast. Assoc. Fish. Wildl. Agencies* 31:392-398.
- HETTLER, W. F., and L. COSTON-CLEMENTS.  
1978. Effects of acute thermal stress on marine fish embryos and larvae. *In* L. D. Jensen (ed.), *Fourth national workshop on entrainment and impingement*, p. 171-190. E.A. Communications, Melville, N.Y.
- HIROTA, J.  
1977. DOMES zooplankton. Final Report, Hawaii Inst. Mar. Biol. and Dep. Oceanogr., Univ. Hawaii, Honolulu, 247 p.
- HOAGMAN, W. J.  
1974. Vital activity parameters as related to the early life history of larvae and post larvae lake whitefish (*Coregonus clupeaformis*). *In* J. H. S. Blaxter (ed.), *The early life history of fish*. p. 473-558. Springer Verlag, New York.
- HOCUTT, C. H., and J. E. EDINGER.  
1980. Fish behavior in flow fields. *In* C. H. Hocutt, J. R. Stauffer, Jr., J. E. Edinger, L. W. Hall, Jr., and R. P. Morgan II (eds.), *Power plants: Effects on fish and shellfish behavior*, p. 143-181. Academic Press, New York.
- HODGMAN, C. D. (ed.).  
1959. *Handbook of chemistry and physics*, 40th ed. Chemical Rubber Publishing Co., Cleveland, Ohio.
- HOLM-HANSEN, O.  
1969. Determination of microbial biomass in ocean profiles. *Limnol. Oceanogr.* 14(5):740-747.
- HOSS, D. E., and J. H. S. BLAXTER.  
1979. The effect of rapid changes of hydrostatic pressure on the Atlantic herring, *Clupea harengus* L.—I. Larval survival and behavior. *J. Exp. Mar. Biol. Ecol.* 41:75-85.
- HOSS, D. E., L. C. COSTON, J. P. BAPTIST, and D. W. ENGEL.  
1975. Effects of temperature, copper and chlorine on fish during simulated entrainment in power-plant condenser cooling systems. *In* *Environmental effects of cooling systems at nuclear power plants*, Proceedings of a symposium, p. 519-527. International Atomic Energy Agency, Vienna.
- HOSS, D. E., L. COSTON-CLEMENTS, and D. R. COLBY.  
1977. Synergistic effects of exposure to temperature and chlorine on survival of young-of-the-year estuarine fishes. *In* F. J. Vernberg, A. Calabrese, F. P. Thurberg, and W. B. Vernberg (eds.), *Physiological response of marine biota to pollutants*, p. 345-355. Academic Press, New York.
- HOSS, D. E., L. C. COSTON, and W. F. HETTLER, Jr.  
1971. Effects of increased temperature on postlarval and juvenile estuarine fish. *Proc. Annu. Conf. Southeast. Assoc. Game Fish. Comm.* 25:635-642.
- HOSS, D. E., W. F. HETTLER, Jr., and L. C. COSTON.  
1974. Effects of thermal shock on larval fish - Ecological implications with

- respect to entrainment in power plant cooling systems. In J. H. S. Blaxter (ed.), The early life history of fish, p. 357-371. Springer-Verlag, New York.
- HOSS, D. E., and D. S. PETERS.  
1983. Synthesis of pertinent information on the potential effects of estuarine and coastal power plants on fisheries with comments on how this information might apply to ocean thermal energy conversion (OTEC) operations. Southeast Fisheries Center Beaufort Laboratory, National Marine Fisheries Service, NOAA, Beaufort, NC, 52 p.
- HOSS, D. E., D. S. PETERS, and R. E. ROSE.  
1983. Study of the potential impact to fisheries of OTEC operations. Summary report of pertinent biological information from the Caribbean. Southeast Fisheries Center Beaufort Laboratory, National Marine Fisheries Service, NOAA, Beaufort, NC, 111 p.
- HOUDE, E. D.  
1969. Sustained swimming ability of larvae of walleye (*Stizostedion vitreum*) and yellow perch (*Perca flavescens*). J. Fish. Res. Board Can. 26:1647-1659.
- HUNTER, J. R.  
1980. Feeding ecology and predation of marine fish larvae. In R. Lasker (ed.), Marine fish larvae, p. 33-77. Washington Sea Grant Program, Seattle.
- HUNTER, J. R., and C. A. KIMBRELL.  
1980. Early life history of Pacific mackerel, *Scomber japonicus*. Fish. Bull., U.S. 78:89-101.
- HUNTER, J. R., and C. T. MITCHELL.  
1967. Association of fishes with flotsam in the offshore waters of Central America. U.S. Fish Wildl. Serv., Fish. Bull. 66:13-29.  
1968. Field experiments on the attraction of pelagic fish to floating objects. J. Cons. Perm. Int. Explor. Mer 31:427-434.
- IDYLL, C. P., and D. de SYLVA.  
1963. Synopsis of biological data on yellowfin tuna *Thunnus albacares* (Bonaterre) 1788 (Western Atlantic). FAO Fish. Rep. 6, vol. 2:771-777.
- INOUE, M., R. AMANO, and Y. IWASAKI.  
1963. Studies on environments alluring skipjack and other tunas—I. On the oceanographical condition of Japan adjacent waters and the drifting substances accompanied by skipjack and other tunas. [In Jpn., Engl. summ.] Rep. Fish. Res. Lab., Tokai Univ. 1:12-23.
- INOUE, M., R. AMANO, Y. IWASAKI, and N. YAMAUTI.  
1968. Studies on environments alluring skipjack and other tunas—II. On the drift-woods accompanied by skipjack and tunas. Bull. Jpn. Soc. Sci. Fish. 34:283-287.
- IVLEV, V. S.  
1960. On the utilization of food by planktonophage fishes. Bull. Math Biophys. 22:371-389.
- JENSEN, L. D., (ed.).  
1974. Entrainment and intake screening: Proceedings, Second workshop on entrainment and intake screening. EPRI Publ. 74-049-00-5. Electric Power Research Institute, Palo Alto, CA, 347 p.
- JIRKA, G. H., J. M. JONES, and F. E. SARGENT.  
1980. Theoretical and experimental study of the intermediate field dynamics of ocean thermal energy conversion plants. Environmental Engineering Department, Cornell University, Ithaca, New York, 150 p.
- KANAYAMA, R. K., and E. W. ONIZUKA.  
1973. Artificial reefs in Hawaii. Hawaii Fish Game Rep. 73-01, 23 p.
- KLAPPOW, L. A., and R. H. LEWIS.  
1979. Analysis of toxicity data for California marine eater quality standards. J. Water Pollut. Control Fed. 51:2054-2070.
- KLIMA, E. F., and D. A. WICKHAM.  
1971. Attraction of coastal pelagic fishes with artificial structures. Trans. Am. Fish. Soc. 100:86-99.
- KNAUER, G. A., and A. R. FLEGAL.  
1981. Ocean thermal energy conversion (OTEC) particulate program 1980, St. Croix (VOTEC). Report LBL-14115. Lawrence Berkeley Laboratory, Univ. Calif., Berkeley. (Available from NTIS) 43 p.
- KOH, R. C. Y.  
1983. Delivery systems and initial dilution. In E. P. Myers (ed.), Ocean disposal of municipal wastewater: Impacts on the coastal environment, p. 129-175. Sea Grant College Program, Massachusetts Institute of Technology, Cambridge, MA, 1115 p.
- KOJIMA, S.  
1960. Fishing for dolphins in the western part of the Japan Sea—V. Species of fishes attracted to bamboo rafts. [In Jpn., Engl. summ.] Bull. Jpn. Soc. Sci. Fish. 26:379-382. (Engl. transl. by W. G. Van Campen, 1962, 4 p.; Southwest Fish. Cent., Nat. Mar. Fish. Serv., NOAA, Honolulu, HI 96812).
- LAEVASTU, T., and M. L. HAYES.  
1981. Fisheries oceanography and ecology. Page Bros. (Norwich) Ltd., Norwich, 199 p.
- LANGFORD, T. E.  
1983. Electricity generation and the ecology of natural waters. Liverpool University Press, Liverpool, 342 p.
- LARIMORE, R. W., and M. J. DUEVER.  
1968. Effects of temperature acclimation on the swimming ability of small mouth bass fry. Trans. Am. Fish. Soc. 97:175-184.
- LARSON-BASSE, J., and T. H. DANIEL.  
1983. OTEC heat transfer experiments at Keahole Point, Hawaii, 1982-1983. In Proceedings, Oceans '83 conference, Paper F2-4. Marine Technology Society, Wash., D.C.
- LEIS, J. M.  
1982. Nearshore distributional gradients of larval fish (15 taxa) and planktonic crustaceans (6 taxa) in Hawaii. Mar. Biol. 72:89-97.
- LIGHTHILL, M. J.  
1970. How do fishes swim? Endeavor 29:77-83.
- LONGHURST, A. R.  
1976. Vertical migration. In D. H. Cushing and J. J. Walsh (eds.), The ecology of the seas, p. 116-137. W. B. Saunders Co., Toronto.
- MALLORY, J. D.  
1965. Artificial reefs in shallow waters. Proc. Intl. Game Fish Comm. 10:29-37.
- MALONE, T. C.  
1971. The relative importance of nanoplankton and netplankton as primary producers in tropical oceanic and neritic phytoplankton. Limnol. Oceanogr. 16(4):633-639.
- MARCY, B. C., Jr.  
1971. Survival of young fish in the discharge canal of a nuclear power plant. J. Fish. Res. Board Can. 28:1057-1060.
- MARCY, B. C., Jr., V. R. KRANZ, and R. P. BARR.  
1980. Ecological and behavioral characteristics of fish eggs and young influencing their entrainment. In C. H. Hocutt, J. R. Stauffer, Jr., J. E. Edinger, L. W. Hall, Jr., and R. P. Morgan II (eds.), Power plants, p. 29-74. Academic Press, New York.
- MARGALEF, R.  
1971. The pelagic ecosystem of the Caribbean Sea. In Symposium on investigations and resources of the Caribbean Sea and adjacent regions, Willemstad, Curacao, 1968, p. 483-498. UNESCO.
- MARSHALL, H. G., and J. A. SOLDER.  
1982. Pelagic phytoplankton in the Caribbean Sea. Bull. Mar. Sci. 32(1):354-365.
- MATSUMOTO, W. M.  
1984. Potential impact of ocean thermal energy conversion (OTEC) operation on fisheries. Admin. Rep. H-84-4, Southwest Fisheries Center Honolulu Laboratory, National Marine Fisheries Service, NOAA, Honolulu, 29 p.
- MATSUMOTO, W. M., T. K. KAZAMA, and D. C. AASTED.  
1981. Anchored fish aggregating devices in Hawaiian waters. Mar. Fish. Rev. 43(9):1-13.
- MATSUMOTO, W. M., R. A. SKILLMAN, and A. E. DIZON.  
1984. Synopsis of biological data on skipjack tuna, *Katsuwonus pelamis*. NOAA Tech. Rep. NMFS Circ. 451, U.S. Department of Commerce, Wash., D.C., 92 p.
- MAYNARD, S. D., F. V. RIGGS, and J. F. WALKERS.  
1975. Mesopelagic micronekton in Hawaiian waters: Faunal composition, standing stock, and diel vertical migration. Fish. Bull., U.S. 74:726-736.
- McCAIN, J. C.  
1977. Final report — Kahe generating station NPDES monitoring program, Vol. I-II. Hawaiian Electric Company, Inc., Honolulu.
- MILLER, A. R.  
1977. Ranges and extremes of the natural environment related to design criteria for ocean thermal energy conversion plants. Report prepared for Energy Research and Development Administration, Division of Solar Energy, by Woods Hole Oceanographic Institution, Woods Hole, MA. 73 p.
- MILLER, J. M.  
1974. Nearshore distribution of Hawaiian marine fish larvae: effects of water quality, turbidity and currents. In J. H. S. Blaxter (ed.), The early life history of fish, p. 217-231. Springer-Verlag, New York.  
1979. Nearshore abundance of tuna (Pisces: Scombridae) larvae in the Hawaiian Islands. Bull. Mar. Sci. 19(1):19-26.
- MILLER, J. M., W. WATSON, and J. M. LEIS.  
1979. An atlas of common nearshore marine fish larvae of the Hawaiian Islands. Sea Grant Misc. Rep. UNIH-SEAGRANT-MR-80-02. University of Hawaii, Honolulu, 179 p.
- MOORE, E.  
1967. A study of the surface zooplankton in the Caribbean Sea off Jamaica. Ph.D. thesis, McGill University, Montreal, Quebec, 138 p.

- MOORE, E., and F. SANDER.  
1976. Quantitative and qualitative aspects of the zooplankton and breeding patterns of copepods at two Caribbean coral reef stations. *Estuar. Coastal Mar. Sci.* 4:589-607.  
1977. A study of the offshore zooplankton of the tropical western Atlantic near Barbados. *Ophelia* 16(1):77-96.
- MUNRO, J. L., V. C. GAUT, R. THOMPSON, and P. H. REESON.  
1973. The spawning seasons of Caribbean reef fishes. *J. Fish Biol.* 5:69-84.
- MYERS, E. P., and J. D. DITMARS.  
1985. Ocean thermal energy conversion (OTEC): Effects on marine environment. Vol. 4, Energy wastes in the ocean. In W. Duedall, D. R. Kester, P. K. Park, and B. K. Ketchum (eds.), *Wastes in the ocean*, p. 163-192. Wiley-Interscience, New York.
- NODA, E. K., P. K. BIENFANG, and D. A. ZIEMAN.  
1980. OTEC environmental benchmark survey off Keahole Point, Hawaii. J.K.K. Look Lab. Oceanogr. Eng. Report, University of Hawaii, Honolulu, unpagged.  
1982. OTEC environmental benchmark survey off Keahole Pt., Hawaii. Report DOE/NBM-2016054 (DE82016054), U.S. Department of Energy, Wash., D.C. Unpagged.
- NODA, E. K., P. K. BIENFANG, W. J. KIMMERER, and T. W. WALSH.  
1981a. OTEC environmental benchmark survey, Kahe Point, Oahu. Final Report for the Period May 1980-May 1981. Report DOE/NBM-2016055 (DE82016055), U.S. Department of Energy, Wash., D.C. Unpagged.  
1981b. Plume survey, OTEC-1 mixed water discharge, Apr. 11-12, 1981. Report LBL-12951, Lawrence Berkeley Lab., Univ. Calif., Berkeley, 116 p.
- NOAA.  
1981a. Final environmental impact statement for commercial ocean thermal energy conversion (OTEC) licensing. Office of Ocean Minerals and Energy, National Oceanic and Atmospheric Administration, Wash., D.C.: 246 p.  
1981b. Licensing of ocean thermal energy conversion facilities and plantships (as amended by 46 FR 61643 et seq., Dec. 18, 1981), 15 CFR Part 981. Federal Register 46(147):39388-39420.  
1981c. Technical guidance document for environmental requirements of commercial OTEC licensing regulations. Office of Ocean Minerals and Energy, National Oceanic and Atmospheric Administration, Wash., D.C. 105 p.  
1982. Ocean thermal energy conversion: Environmental effects assessment program plan, 1981-85. Office of Ocean Minerals and Energy, National Oceanic and Atmospheric Administration, Wash., D.C. 54 p.
- OCEAN DATA SYSTEMS, INC.  
1977a. Ocean thermal resource report for Hawaii. Prepared for U.S. Energy Research and Development Admin., Division of Solar Energy, Wash., D.C. by Ocean Data Systems, Inc., Monterey, CA.  
1977b. OTEC thermal resource report for Puerto Rico. Prepared for U.S. Energy Research and Development Admin., Division of Solar Energy, Wash., D.C. by Ocean Data Systems, Inc., Monterey, CA.
- OCEAN THERMAL CORPORATION.  
1983. Ocean thermal energy conversion (OTEC) pilot plant conceptual design study — Conceptual design report (final report). Prepared for U.S. Department of Energy under contract DE-ACO1-82CE30716. Ocean Thermal Corp., New York, 285 p.
- OGURA, M., and T. NASUMI.  
1976. Fishing lamps and light attraction for squid jigging. In *Contributed papers submitted to the expert consultation on fishing for squid and other cephalopods*, Suppl. 1, p. 93-96. FAO Fish. Rep. 170.
- PADDOCK, R. A., and J. D. DITMARS.  
1983. Initial screening of license applications for ocean thermal energy conversion (OTEC) plants with regard to their interaction with the environment. Report ANL/OTEC-EV-2. Argonne National Laboratory, Argonne, IL, 126 p.
- PAVLOV, D. S., Yu. N. SBIKIN, and A. D. MOCHEK.  
1968. The effect of illumination in running water on the speed of fishes in relation to features of their orientation. *Probl. Ichthyol.* [Engl. lang. ed. of *Voprosy Ikhtiologii*] 8:250-255.
- PETERS, D. S.  
1983. The potential range of ecological effects resulting from OTEC operations. Southeast Fisheries Center Beaufort Laboratory, National Marine Fisheries Service, NOAA, Beaufort, NC, 17 p.
- PETERS, D. S., and J. W. ANGELOVIC.  
1973. Effect of temperature, salinity, and food availability on growth and energy utilization of juvenile summer flounder *Paralichthys dentatus*. In D.J. Nelson (ed.), *Proceedings, Third national symposium on radioecology*, p. 545-554. U.S. Atomic Energy Comm., Wash., D.C. (NTIS:CONF-710501-P1).
- PLATT, T., and D. V. SUBBA ROA.  
1975. Photosynthesis and productivity in different environments. *Intl. Biol. Program* 3:249. Cambridge University Press.
- POWELL, R.  
1968. "Akule" night fishing gear. *South Pac. Comm.*, Noumea, New Caledonia, 13 p.
- QUINBY-HUNT, M. S.  
1979. Comparison of nutrient data from four potential OTEC sites. Report LBL-9052, Lawrence Berkeley Lab., Univ. Calif., Berkeley, 6 p.
- RADAKOV, D. V.  
1964. Velocities of fish swimming. In "Nauka," p. 4-28. Pamphlet from A. N. Severtsov Institute of Animal Morphology, Moscow [in Russian].
- RICHARDS, W. J.  
1981. Kinds and abundances of fish larvae in the Caribbean Sea. *Rapp. P.-v. Réun. Cons. int. Explor. Mer* 178:240-241.  
1984. Kinds and abundances of fish larvae in the Caribbean Sea and adjacent areas. NOAA Tech. Rep. NMFS-776. U.S. Department of Commerce, Wash., D.C., 54 p.
- ROSENTHAL, H.  
1966. Beobachtungen über die entwicklung des schwarmverhaltens bei den larven der herings *Clupea harengus*. *Mar. Biol.* 2:73-76.
- ROSENTHAL, H., and D. F. ALDERDICE.  
1976. Sublethal effects of environmental stressors, natural and pollutional, on marine fish eggs and larvae. *J. Fish. Res. Board Can.* 33:2047-2065.
- RULIFSON, R. A.  
1977. Temperature and water velocity effects on the swimming performances of young-of-the-year mullet (*Mugil cephalus*), spot (*Leiostomus xanthurus*), and pinfish (*Lagodon rhomboides*). *J. Fish. Res. Board Can.* 34:2316-2322.
- RYLAND, J. S.  
1963. The swimming speeds of plaice larvae. *J. Exp. Biol.* 40:285-299.
- RYTHER, J. H.  
1969. Photosynthesis and fish production in the sea. *Science* 166:72-76.
- SANDER, F., and D. M. STEVEN.  
1973. Organic production of inshore and offshore waters of Barbados: A study of the island mass effect. *Bull. Mar. Sci.* 23:771-793.
- SANDS, M. D.  
1980. Ocean thermal energy conversion (OTEC) programmatic environmental analysis, vol. 1. Report LBL-10511, Lawrence Berkeley Lab., Univ. Calif., Berkeley, 213 p. (Available from NTIS: DE81030222).
- SAX, N. I.  
1979. *Dangerous properties of industrial materials*, 5th ed. Van Nostrand Reinhold Co., New York, 1018 p.
- SCHUBEL, J. R., and B. C. MARCY, Jr., (eds.).  
1978. *Power plant entrainment*. Academic Press, New York. 271 p.
- SEKI, M. P.  
1984. Summary of pertinent information on the attraction effects of artificial structures placed in tropical and subtropical waters. Admin. Rep. H-83-12, Southwest Fisheries Center Honolulu Laboratory, National Marine Fisheries Service, NOAA, Honolulu, 49 p.
- SENTA, T.  
1966. Experimental studies on the significance of drifting seaweeds for juvenile fishes—I. Experiments with artificial drifting seaweeds. *Bull. Jpn. Soc. Sci. Fish* 32:639-642.
- SHELDON, R. W., W. H. SUTCLIFFE, Jr., and M. A. PARANJAPE.  
1977. Structure of pelagic food chain and relationship between plankton and fish production. *J. Fish. Res. Board Can.* 34:2344-2353.
- SHOMURA, R. S., and W. M. MATSUMOTO.  
1982. Structured flotsam as fish aggregating devices. NOAA-TM-NMFS-SWFC-22, Southwest Fish. Cent., National Marine Fisheries Service, NOAA, La Jolla, CA, 9 p.
- SHOMURA, R. S., and F. WILLIAMS (eds).  
1975. *Proceedings, International billfish symposium, August 1972. Part 3. Species synopses*. NOAA Tech. Rep. NMFS SRRF-675. U.S. Department of Commerce, Wash., D.C., 159 p.
- SHUPE, J. W.  
1982. Energy self-sufficiency for Hawaii. *Science* 216:1193-1199.
- STAUFFER, J. R., Jr.  
1980. Influence of temperature on fish behavior. In C. H. Hocutt, J. R. Stauffer, Jr., J. E. Edinger, L. W. Hall, Jr., and R. P. Morgan II (eds.), *Power plants: Effects on fish and shellfish behavior*, p. 103-141. Academic Press, New York.
- STEEMAN NIELSEN, E., and E. A. JENSEN.  
1957. Primary oceanic production: The autotrophic production of organic matter in the oceans. *Galathea Rep.* 1:49-136.
- STEVEN, D. M.  
1971. Primary productivity of the tropical western Atlantic Ocean near Barbados. *Mar. Biol.* 10:261-264.

- STROUD, R. H.  
1965. Artificial reefs as tools of sport fishery management in coastal marine waters. Proc. Intl. Game Fish Comm. 10:2-12.
- SULLIVAN, S. M. and M. D. SANDS.  
1980. A preliminary evaluation of impingement and entrainment by ocean thermal energy conversion (OTEC) plants. Report LBL-13915. Lawrence Berkeley Laboratory, Univ. Calif., Berkeley, 14 p.
- SUNDA, W. G., and S. A. HUNTSMAN.  
1983. Effect of competitive interactions between manganese and copper on cellular manganese and growth in estuarine and oceanic species of the diatom *Thalassiosira*. Limnol. Oceanogr. 28 (5):924-934.
- SZYPER, J. P., P. K. BIENFANG, L. D. CONQUEST, K. KLEIN, and D. A. ZIEMANN.  
1984. Distribution of oceanographic parameters and phytoplankton response to deep-water enrichment off Kahe Point, Oahu. A report on the survey cruises of 16-18 August 1983 and 10-12 January 1984. Prepared for TRW Energy Development Group, Redondo Beach, CA., by OI Consultants, Inc., Waimanalo, Hawaii.
- TERPIN, K. M., M. C. WILLIE, and E. R. HOLMSTROM.  
1977. Temperature preference, avoidance, shock, and swim speed studies with marine and estuarine organisms from New Jersey. Bull. 17, Ichthyological Associates, Ithaca, New York, 86 p.
- TIPTON, D. G.  
1980. Effect of mechanical cleaning on seawater corrosion of candidate OTEC heat exchanger materials. In Proceedings, Seventh ocean energy conference, p. 5.2-1 to 5.2-20. Conf. 800633, U.S. Department of Energy, Wash., D.C.
- TSUKAMOTO, K., T. KAJIHARA, and M. NISHIWAKI.  
1975. Swimming ability of fish. Bull. Japan Soc. Sci. Fish. 41:167-174.
- TURNER, C. J., E. E. EBERT, and R. R. GIVEN.  
1969. Man-made reef ecology. Calif. Dep. Fish Game, Fish. Bull. 147, 221 p.
- UCHIDA, R. N.  
1981. Synopsis of biological data on frigate tuna, *Auxis thazard* and bullet tuna, *A. rochei*. NOAA Tech. Rep. NMFS Circ. 436. U.S. Department of Commerce, Wash., D.C., 63 p.  
1983. Summary of pertinent biological characteristics of potential ocean thermal energy conversion (OTEC) sites in the Pacific Ocean. Admin. Rep. H-83-13, Southwest Fisheries Center Honolulu Laboratory, National Marine Fisheries Service, NOAA, Honolulu, 91 p.
- UNITED NATIONS.  
1981. Substantive preparation for the conference: Report of technical panel on ocean energy on its second session. U.N. Conference on new and renewable sources of energy, September 1980, Geneva, Switzerland, 45 p.
- U.S. DEPARTMENT OF ENERGY.  
1978. Environmental development plan (EDP) - Ocean thermal energy conversion. Rep. DOE/EDP-0006. U.S. Dept. of Energy, Wash., D.C., 43 p.  
1979. Environmental development plan - Ocean thermal energy conversion. Assistant Secretary for Energy Technology, Assistant Secretary for Environment, Wash., D.C., 48 p.  
1981. The potential environmental consequences of ocean thermal energy conversion (OTEC) plants - A Workshop. Conf. 810622, U.S. Department of Energy, Wash., D.C., 106 p.
- U.S. DEPARTMENT OF LABOR.  
1972. Occupational safety and health standards, air contaminants. Occupational Safety and Health Admin. 37 Federal Register 22139-22144, October 18, 1972.
- U.S. DEPARTMENT OF STATE.  
1982. Puerto Rico and the U.S. Virgin Islands Region. Map 4357 2-82 State (GE). Office of Geographer, U.S. Department of State, Wash., D.C. Unpagged.
- U.S. ENVIRONMENTAL PROTECTION AGENCY.  
1973. Reviewing environmental impact statements - Power plant cooling systems, engineering aspects. Pacific Northwest Environmental Research Lab., U.S. EPA, Corvallis, OR, 93 p.
- UZIEL, M. S.  
1980. Entrainment and impingement at cooling-water intakes. J. Water Pollut. Control Fed. 52:1616-1630.
- VAN WINKLE, W. (ed.).  
1977. Proceedings, Conference on assessing the effects of power-plant-induced mortality on fish populations. Pergamon Press, New York, 380 p.
- VARGO, S., K. FANNING, T. HOPKINS, H. MICHELE, G. VARGO, E. HARTWIG, and A. JONES.  
1981. Physical, chemical and biological measurements off Puerto Rico. Report DOE/NBM-1043, Lawrence Berkeley Lab., Univ. Calif., Berkeley. 2 vols. (Available from NTIS: DE82021294 and DE82021295), 663 p.
- VENKATARAMIAH, A., G. J. LAKSHMI, C. BEST, G. GUNTER, E. HARTWIG, and P. WILDE.  
1981a. Studies on toxicity of OTEC plant components on marine animals from the Gulf of Mexico. Rep. LBL-13915, Lawrence Berkeley Lab., Univ. Calif., Berkeley, 114 p.  
1981b. Studies on toxicity of OTEC plant components on *Eucalanus* sp. from the Gulf of Mexico. Rep. LBL 13916, Lawrence Berkeley Lab., Univ. Calif., Berkeley, 53 p.
- VINOGRADOV, M. E.  
1968. Vertical distribution of the oceanic zooplankton. Moscow, Acad Nauk SSSR, Inst. Okeanol. [Transl. from Russian by Israel Program Sci. Transl. 1970, 339 pp.] (Available TT 69-59015 from NTIS, Springfield, VA.)
- WALTERS, V., and H. L. FIERSTINE.  
1964. Measurements of swimming speeds of yellowfin tuna and wahoo. Nature 202:203-209.
- WANG, D.-P.  
1982. Development of a three-dimensional limited-area (island) shelf circulation model. J. Phys. Oceanogr. 12:605-617.  
1984. A far-field model of the regional influence of effluent plumes from ocean thermal energy conversion (OTEC) plants. Draft Final Report to the National Oceanic and Atmospheric Administration by Energy and Environmental Systems Division, Argonne National Laboratory, Argonne, IL, 46 p.
- WICKHAM, D. A., and G. M. RUSSELL.  
1974. An evaluation of midwater artificial structures for attracting coastal pelagic fishes. Fish. Bull., U.S. 72:181-191.
- WICKHAM, D. A., J. W. WATSON, Jr., and L. H. OGREN.  
1973. The efficacy of midwater artificial structures for attracting pelagic sport fish. Trans. Am. Fish. Soc. 102:563-572.
- WIEBE, P. H., S. BOYD, and J. L. COX.  
1975. Relationships between zooplankton displacement volume, wet weight, dry weight, and carbon. Fish. Bull., U.S. 73:777-786.
- WOLFF, P. M.  
1978. Temperature variability at three OTEC sites. Report prepared for U.S. Department of Energy, Wash., D.C. by Ocean Data Systems, Monterey, CA.
- YABE, H., and T. MORI.  
1950. An observation on the habit of bonito, *Katsuwonus vagans*, and yellowfin, *Neothunnus macropterus*, schools under the drifting timber on the surface of ocean. [In Jpn., Engl. abstr.] Bull. Jpn. Soc. Sci. Fish. 16:35-39. (Engl. transl. by W. G. Van Campen, 1954, 12 p.; Southwest Fish. Cent., Natl. Mar. Fish. Serv., NOAA, Honolulu, HI 96812)
- YAMAGUCHI, Y.  
1953. The fishery and the biology of the Hawaiian opelu, *Decapterus pinnulatus* (Eydox and Souleyet). M.S. Thesis, Univ. Hawaii, Honolulu, 125 p.
- YOSHIDA, H. O.  
1979. Synopsis of biological data on tunas of the genus *Euthynnus*. NOAA Tech. Rep. NMFS Circ. 429. U.S. Department of Commerce, Wash., D.C., 57 p.
- YOUNGBLUTH, M. J.  
1979. The variety of abundance of zooplankton in the coastal waters of Puerto Rico. Northeast Gulf Sci. 3(1):15-26.
- YUEN, H. S. H.  
1979. A night handline fishery for tunas in Hawaii. Mar. Fish. Rev. 41 (8):7-14.
- YUEN, P. C.  
1981. Ocean thermal energy conversion: A Review. Report HNEI-81-03, Hawaii Natural Energy Institute, University of Hawaii at Manoa, Honolulu, 173 p.