

GB
1627
.G8
G7
1982

Great Lakes Environmental Research Laboratory Annual Report FY 1982

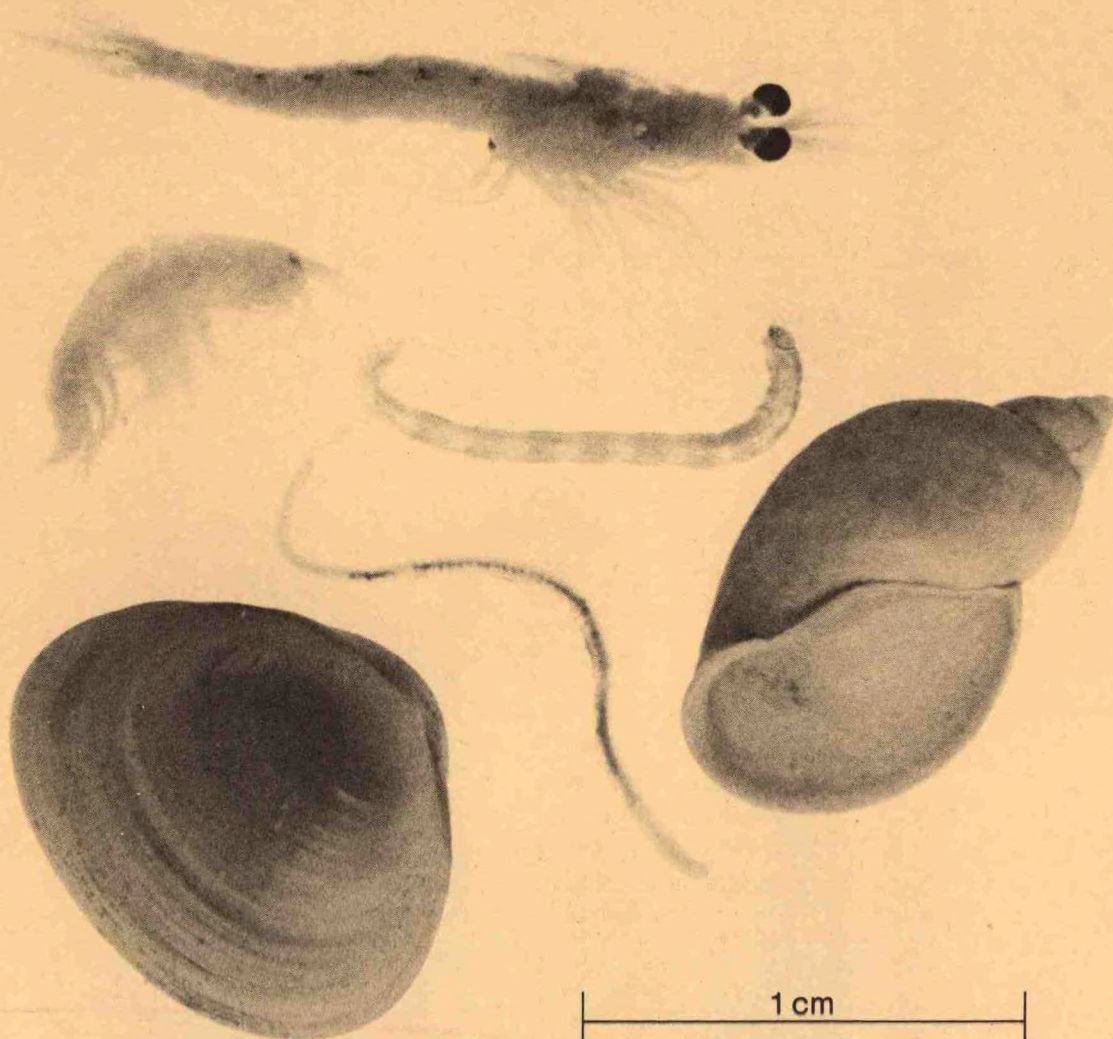

U.S. DEPARTMENT OF COMMERCE
National Oceanic and Atmospheric Administration
Office of Research and Development
Environmental Research Laboratories



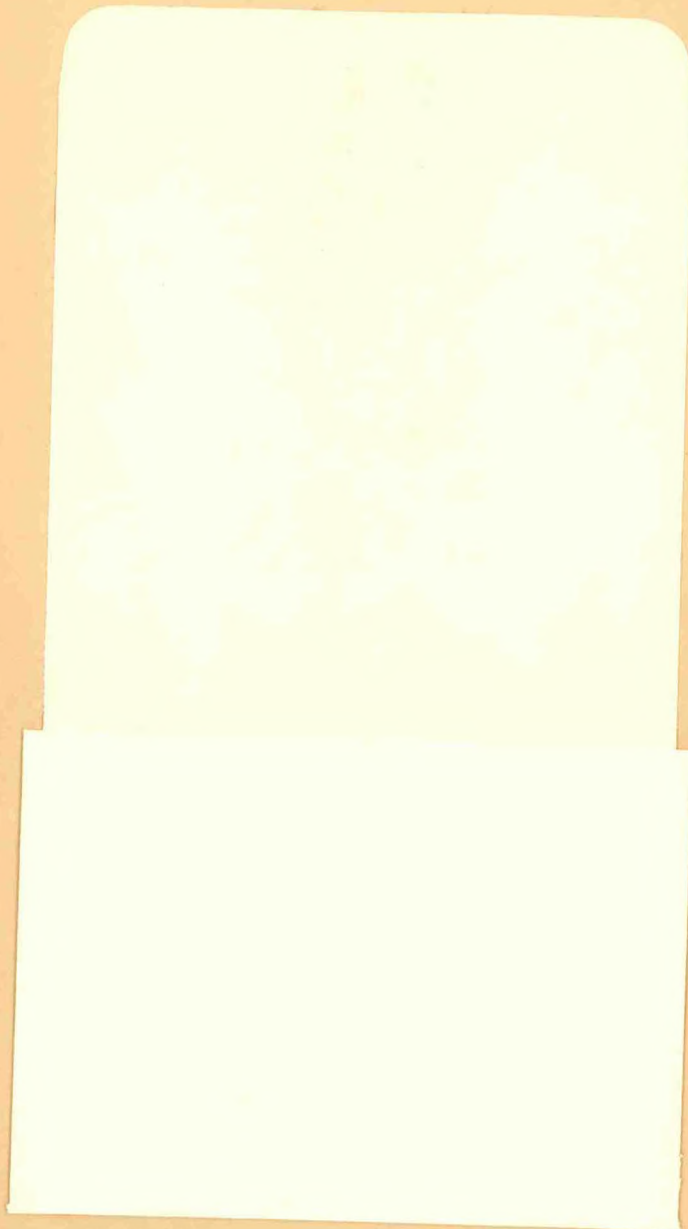

Cover photograph

Benthic organisms studied by scientists at the Great Lakes Environmental Research Laboratory. From the top and moving counterclockwise, they are *Mysis relicta* (opossum shrimp), *Pontoporeia hoyi* (scud), *Sphaerium* sp. (fingernail clam), *Limnodrilus* sp. (worm), *Bulimus* sp. (snail), and *Chironomus* sp. (midge). The distribution of the various benthic organisms is a good indicator of water quality. In addition, *Pontoporeia hoyi* has been shown to be important in the cycling of toxic materials and, with *Mysis relicta*, forms an important element of the food chain because they are a major food source for fish. Bioturbation (disturbance of the sediments) caused by the burrowing of *Chironomus* sp. and *Limnodrilus* sp. regenerates nutrients into the overlying waters.

H
CB
1627
CF
C7
1982

GREAT LAKES ENVIRONMENTAL RESEARCH LABORATORY ANNUAL REPORT FY 1982

December 1982

Eugene J. Aubert, Director



U.S. DEPARTMENT OF COMMERCE
National Oceanic and Atmospheric Administration
Office of Research and Development
Environmental Research Laboratories
Great Lakes Environmental Research Laboratory
2300 Washtenaw Avenue
Ann Arbor, Michigan 48104

CENTRAL
LIBRARY

APR 25 1983

N.O.A.A.
U. S. Dept. of Commerce

NOTICE

Mention of a commercial company or product does not constitute an endorsement by NOAA Environmental Research Laboratories. Use for publicity or advertising purposes of information from this publication concerning proprietary products or the tests of such products is not authorized.



PREFACE

The Great Lakes Environmental Research Laboratory (GLERL) has completed its 8th year of operation in Ann Arbor. Our mission at GLERL is to conduct research directed toward understanding the environmental processes and solving problems in resource management and environmental services in coastal and estuarine waters, with a special emphasis on the Great Lakes. The environmental information developed is made available to NOAA, other government agencies, universities, industries, and individual citizens to aid them in their environmental services, plans, and operations.

Understanding the complex lake-land-atmosphere-sediment system of the areas in and around the Great Lakes and coastal and estuarine waters and the many interactions that influence the lives of those in these regions requires a team of scientists with different backgrounds working together on field, laboratory, and analytic investigations on the limnological, hydrological, and meteorological properties of the lakes, their basins, and the overlying atmosphere. The ultimate goal of the GLERL program is to understand the lake-land-atmosphere-sediment system to the extent that environmental simulation and prediction models can be built that will provide sufficiently precise information on Great Lakes and coastal and estuarine processes and phenomena to support enlightened use of the regions' resources.

This annual report is intended to inform the scientific community, decision-makers, and other interested individuals of GLERL's capabilities, program, significant results, and plans for the future. It is also intended to encourage an exchange of information between laboratory staff and those in need of environmental information for operational, planning, or management activities.

Examples of some of the major problem areas that the GLERL program addresses are the dynamics of certain chemical and biological properties and systems—critical to understanding and prediction of the natural ecosystem, of human influences on the ecosystem, and of toxic substance movement and to water quality, water supply, and fisheries management; lake water levels and connecting channel flow prediction—critical to erosion control, shipping, recreation, and power generation; lake ice prediction—critical to shipping and shoreline structure design and protection; lake circulation—critical to ecosystems analysis and an understanding of the transport and dispersion of pollutants; and surface waves and oscillations—critical to shipping, recreational boating, and the control of shore erosion and flooding.

GLERL staff continue to work with Great Lakes regulatory and management agencies, in both Canada and the United States, to provide them with the research products, data, and expertise they need. They also serve as officers, board members, or committee members of such organizations as the International Joint Commission (IJC), the Great Lakes Commission, and the International Association for Great Lakes Research. These activities provide an outlet for GLERL products and a means of identifying environmental problems requiring further study.

Other outlets for GLERL products include requests from private organizations and individual citizens. The scientific community is informed of the products through journal articles, NOAA technical reports and memoranda and data reports, and presentations at society meetings. The location of GLERL in Ann Arbor near the University of Michigan provides the opportunity for cooperative research programs and for graduate student participation in GLERL projects. Visiting scientists participate in GLERL research studies on a continuing basis.

TABLE OF CONTENTS

	Page
Preface	iii
Highlights	1
Synthetic Organics and Particle Dynamics	5
Ecosystem and Nutrient Dynamics	10
Lake Hydrology	16
Physical Limnology and Meteorology	22
Special Projects	26
Information Services	30
International and Interagency Activities	32
Facilities	35
Publications	40
Presentations	42
Contractor Publications	44

GLERL ORGANIZATION CHART

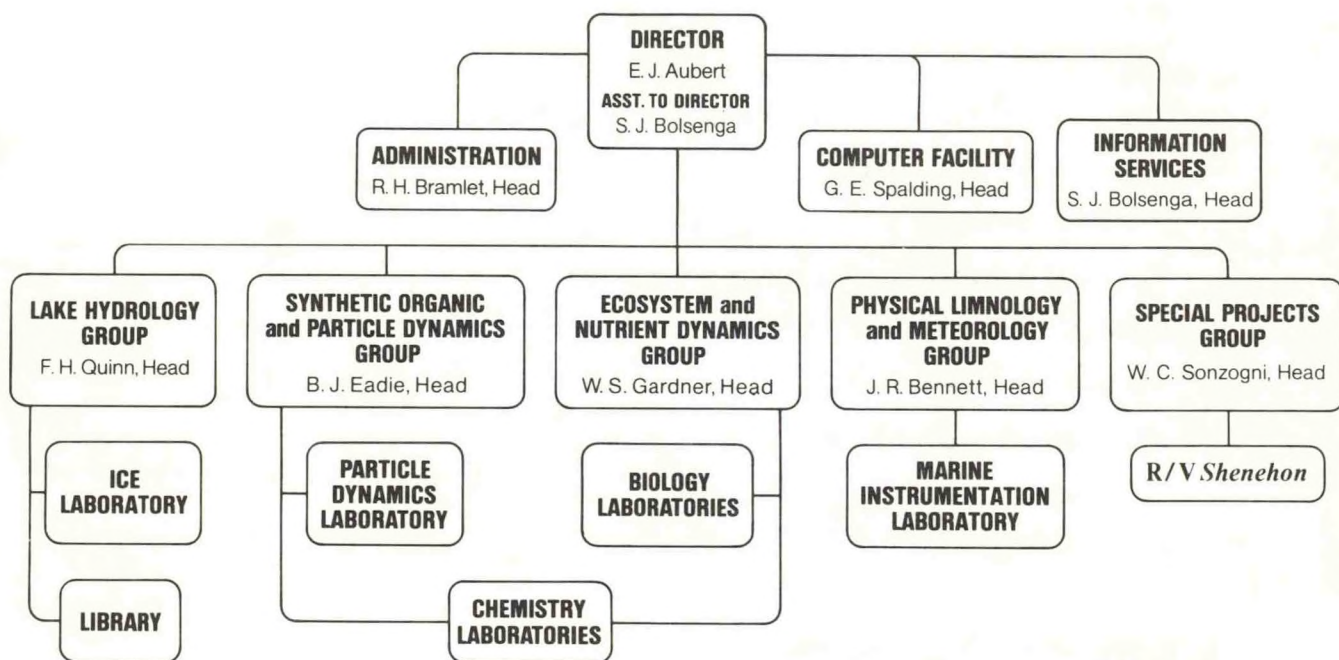

HIGHLIGHTS

For 8 years the Great Lakes Environmental Research Laboratory (GLERL) has conducted research on significant processes and problems in the Great Lakes Region and other coastal and estuarine waters. GLERL research is diversified in form. As is shown by the organization chart, process research is aligned along five primary disciplines. But problem-oriented multidisciplinary research, using staff from more than one group, is also conducted. The in-house research program is supplemented by grants and contracts with private institutions. In turn, GLERL supports the efforts of other government agencies. GLERL research products are disseminated by publications or presentations and discussions at scientific and user meetings. During FY 1982, 50 papers authored by GLERL staff and 12 papers by contractors were published, and 55 papers prepared by GLERL staff were presented at meetings.

Research

The GLERL research program continues to evolve. Some major research accomplishments during the past fiscal year are indicated below.

- A program to study the cycling, transport, and fate of toxic organic compounds continued. In cooperation with NOAA's Office of Marine Pollution Assessment (OMPA), a GLERL in-house modeling team composed of chemical, toxicological, ecological, and physical scientists calibrated a long term near-equilibrium model for polychlorinated biphenyls (PCB's). Recent data from the U.S. Environmental Protection Agency (EPA) indicate that the predictions are reasonable. Disturbing information hidden in the model output and data indicates that the distribution of PCB's is shifting toward the more toxic highly chlorinated compounds.
- During the past year, measurements of polycyclic aromatic hydrocarbons (PAH's) and PCB's in laboratory experiments and sediment-pore water matrices have shown very high concentrations of contaminants in the dissolved phase. Because synthetic organic contaminants tend to associate with (or sorb onto) particles in the water, the movement and fate of particles play an important role in the behavior and influence of these, often toxic, compounds. This study indicates that these contaminants desorb at the sediment-water interface, rather than being buried with the particles that have served to move them through the water column. Continuing research will be necessary to determine whether these compounds diffuse back into the water column or are available to the biota. This is an important factor in the movement of toxics up the food chain.
- The interdependent tank-cascade model of basin runoff, which uses analytical solutions of climatological considerations relevant to large watersheds, has been refined and applied to the Lake Ontario Basin. Although predictions are limited by available meteorological information, the model is practical for forecasting if data can be supplied on a near real-time basis. Since the requisite data are precipitation and air temperature, this may soon be possible for many areas of the Great Lakes Basin. Work is underway to create the necessary data links with agencies in the United States and Canada. The model has been chosen by the International Joint Commission (IJC) for use in their assessment of data network needs in the Great Lakes Region.
- Laboratory studies of intact sediment cores indicated that significant quantities of nutrients were released from aerobic sediments. Processes releasing phosphorus from sediments back into the water must be understood and quantified to develop predictive models of nutrient cycling in lake ecosystems because aerobic sediments are the major sink for phosphorus in lake systems. Laboratory microcosm experiments are currently testing the effects of sediment type and organism composition on the release of phosphorus.
- Mathematical models were used to examine rotating current patterns in Lake Michigan and the results compared with observations recorded in previous years. The method consisted of running time-dependent circulation models and analyzing the results to determine the distribution of kinetic energy with frequency. The average kinetic energy spectrum of current computed from 3-hourly wind-stress values is very similar to the spectrum of the observed currents and to the spectrum of the wind stress. Results of a simulation employing this model were used to plan where to deploy current meters for a rotational mode experiment.
- A toxic substances model for easy implementation by managers was developed and refined this past year. It simulates the concentration of a contaminant in the sediments and overlying water column of a lake. The contaminant being considered is divided into that associated with organic and inorganic particles and that dissolved in the water. The principal application of such a model is to predict the year-to-year and steady-state responses of the sediments and water column to changes in the loading rate of contaminants and/or particulate matter.
- Box and gravity cores were collected from locations of maximum sediment accumulation in the lower four lakes and a few kilometers away where sedimentation was significantly lower. The assumption is that the distribution of compounds reaching these high and low sedimentation areas would be similar. The analysis of these

data will provide information on the rates of early diagenesis of compounds in recent lake sediments. This will aid in the understanding of the fate of various compounds in the Great Lakes.

- The kinetics of uptake, depuration, and biotransformation of selected PAH's by certain organisms are currently being examined. These processes are important because they may play a role in the direct decrease of potentially toxic compounds through biotransformation and they can be an important first step in the concentration of PAH's in fish. Bioconcentration factors from water of 10^4 to 10^5 have been measured in several types of benthic organisms.

- A monthly climatic water balance model was developed and calibrated for Lake Erie. The model was used as part of a study of the impact of secular changes in precipitation and air temperatures on the water supplies to the Lake Erie Basin. The study concluded that the primary cause of the recent (since 1966) high water supplies has been an increase in precipitation averaging 6 percent, which resulted in an increase in runoff of 16 percent. Tests also indicated that a 0.5°C decrease in air temperature will increase runoff by 6 percent. The model is currently being used to improve water supply forecasts for Lake Erie.

- Field data acquisition has now been completed for the Unsteady Overland Sedimentation Project conducted in cooperation with the U.S. Department of Agriculture's Science Education Administration (SEA) with input from the U.S. Geological Survey. Specially prepared plots of agricultural lands were exposed to computer-controlled precipitation from SEA's rainulator, furnished by the National Soil Erosion Laboratory at Purdue University. The theory developed and tested will be useful in ultimate assessments of sediment loadings to the lakes from agricultural lands.

- Studies have been performed to determine the composition and bioavailability of phosphorus compounds in lake water and in input sources. Results have indicated that the composition of the soluble reactive phosphorus pool in lake water is heterogeneous, free orthophosphate is often an order of magnitude lower than indicated by chemical measurements, and the major fraction of the soluble reactive phosphorus pool is unavailable for immediate use by microorganisms. This information is necessary for evaluation of the impact of phosphorus from various sources on the biota of the lakes.

- Fifteen current meter moorings were deployed on a widely-spaced grid in Lake Michigan to study the important properties of rotational waves in the lake basin. Earlier studies revealed a powerful mode in the southern basin of the lake. This study will determine the

lake-scale structure of the waves and their propagation characteristics.

- A consumptive use study of Great Lakes water aided in estimates of a fivefold increase in consumptive use over the next 60 years. Consumptive use (water removed from the system but not returned) could result in an average lake level drop of 21 centimeters on the unregulated lakes (Michigan, Huron, and Erie) by the year 2035.

- GLERL scientists studied variations in the concentration of nutrients around zooplankters in an effort to explain why phytoplankton growth has been observed to be much greater than would be expected based on measurable concentrations of "available" phosphorus in the lake water. This study demonstrated that excreted nutrient plumes influence both growth and nutrient selection of phytoplankton, changing traditional theories of phytoplankton-zooplankton nutrient interactions.

- Beginning this year, a procedure was implemented to update United States tributary pollutant inputs of total phosphorus, nitrate, ammonia, and chloride. The ratio-estimator technique used accounts for the effects of the variability of flow over an annual cycle. These estimates of long term variability of pollutant loads will be very useful in prediction models and as an aid in understanding lake ecosystem dynamics.

Information Services

During the past year, as part of GLERL's Information Service, over 3,600 research products were provided in response to nearly 2,400 documented requests. Of these, 42 percent came from institutions of higher learning, 31 percent from U.S. and foreign federal governments, 15 percent from private industry, 7 percent from domestic and foreign state governments, and 5 percent from private citizens. This activity is in addition to regular mailings to a list of recipients who have indicated interest in a 6-month listing of one or more of the five types of GLERL publications. There were eight Draft Environmental Impact Statements evaluated during the year.

International and Interagency Activities

GLERL staff members were active in several IJC task forces, boards, and committees, including the Non-point Source Control Task Force, International Great Lakes Diversions and Consumptive Use Reference Working Committee, Levels and Flows Advisory Board, and Technical Information Network Board.

GLERL also participated in the activities of the Great Lakes Commission, the International Association for Great Lakes Research, the Regional Response Team for

Spills of Oil and Hazardous Substances, the Joint United States–Canadian Ice Information Working Group, the Winter Navigation Program, and the Inter-agency Great Lakes Hydromet Steering Committee.

Facilities

To monitor island effects of wave generation in the western basin of Lake Erie, marine instrumentation laboratory staff deployed two Waverider buoys, one 10 miles east and one 10 miles west of the Bass Islands. Marine instrumentation laboratory engineers have been working with the GLERL computer facility staff to provide an automatic dial-up system for real-time wave data transmission from these buoys.

In a combined effort of the staffs of the chemistry and biology laboratories, nutrient release patterns of various groups of pelagic and benthic invertebrates have been measured.

The research vessel *Shenehon* supported benthic, planktonic, and bacterial experiments studying nutrient cycling by collecting specimens of benthic organisms in Lakes Huron and Michigan. In support of other nutrient cycling studies, benthic invertebrates were collected from the Grand River and adjacent Lake Michigan waters to determine whether they release significant quantities of phosphorus by metabolic and digestive processes.

GLERL library staff are expanding the on-line literature search support they provide to researchers.

STAFF AS OF SEPTEMBER 30, 1982

	Permanent Employees	
	Full Time	Part Time and Intermittent
Office of Director	11	0
Lake Hydrology Group	11	1
Ecosystems and Nutrient Dynamics Group	7	3
Synthetic Organics and Particle Dynamics Group	7	2
Physical Limnology and Meteorology Group	11	4
Special Projects Group	<u>2</u>	<u>5</u>
TOTAL	49	15

Assel, R. A.	LH	Lawton, B. J.	LH
Aubert, E. J.	OD	Lee, J. P.	OD
Bell, G. L.	SOPD	Leshkevich, G. A.	LH
Bennett, J. R.	PLM	Liebig, J. R.	END
Boatright, J. G.	END	Liu, P. C.	PLM
Bolsenga, S. J.	OD	Lojewski, N. L.	SP
Booker, H. L.	PLM	Losey, D. A.	LH
Bramlet, R. H.	OD	Malczyk, J. M.	END
Burns, W. R.	SP	McCormick, M. J.	SOPD
Campbell, J. E.	PLM	Miller, G. S.	PLM
Carrick, B. J.	LH	Miller, T. C.	PLM
Clites, A. H.	PLM	Moorhead, N. R.	SOPD
Croley, T. E., II	LH	Morse, D. V.	SP
Del Proposto, D. J.	OD	Muzzi, R. W.	PLM
Derecki, J. A.	LH	Nalepa, T. F.	END
Dungan, J. E.	PLM	Noble, P. E.	OD
Dunivan, E. M.	OD	Norton, D. C.	LH
Eadie, B. J.	SOPD	Pickett, R. L.	PLM
Fahnenstiel, G. L.	END	Pinsak, A. P.	SP
Faust, W. R.	SOPD	Quigley, M. A.	END
Field, L. P.	PLM	Quinn, F. H.	LH
Gardner, W. S.	END	Robbins, J. A.	SOPD
Gray, M. J.	SOPD	Saylor, J. H.	PLM
Greene, G. M.	LH	Scavia, D.	END
Grimes, J. E.	SP	Schwab, D. J.	PLM
Hawley, N.	SOPD	Sonzogni, W. C.	SP
Herche, L. R.	OD	Soo, H. K.	PLM
Kelley, J. M.	OD	Spalding, G. E.	OD
Kelley, R. N.	LH	Stubblefield, B.	LH
Kistler, R. D.	PLM	Tarapchak, S. J.	END
Landrum, P. F.	SOPD	Vanderploeg, H. A.	END
Lang, G. A.	SP	Vreeland, S. A.	OD

LH—Lake Hydrology Group
 OD—Office of Director
 SOPD—Synthetic Organics and Particle Dynamics Group
 PLM—Physical Limnology and Meteorology Group
 END—Ecosystem and Nutrient Dynamics Group
 SP—Special Projects Group

SYNTHETIC ORGANICS AND PARTICLE DYNAMICS

The Synthetic Organics and Particle Dynamics Group concentrates on studies of the movement and fate of synthetic contaminants in the Great Lakes and coastal marine ecosystems. This work is grouped into the areas of toxic organic cycling, the role of benthic invertebrates in the fate of pollutants, synthetic organic partitioning, particle flux dynamics, and early diagenesis in Great Lakes sediments.

With the increase in population and industrial and mining activities over the last half century, more human-induced pollution has been added to the Great Lakes. Many of these contaminants are foreign to the biosphere and some are highly resistant to decomposition. Because many of these pollutants are highly toxic and tend to concentrate as they move up the food chain, it is vitally important that water resource managers and other decision-makers have precise information on their nature and movement. Often the toxics sorb onto particles and move through the water and sediments in that way, making it important to understand the movement of particles within the lakes.

Models have proven to be the best method of supplying fast, accurate information on the movement, storage, and resuspension of chemicals and particles in the water and sediments of the Great Lakes, as well as coastal marine ecosystems. Recent modeling efforts have concentrated on the movement and distribution of PCB's and fallout radionuclides such as cesium-137. Studies on the adsorption and desorption of synthetic organics, the movement of total suspended matter, the composition of sediments, and xenobiotic biotransformation (the way in which living organisms alter the foreign chemicals they encounter in the water and ingest) will provide the basis for additional modeling work.

Toxic Organic Cycling

The 1978 Water Quality Agreement between the United States and Canada included language designed to minimize future pollutant loads and mitigate the impact of existing contaminants. It is necessary to improve our understanding of how such chemicals move through a large aquatic ecosystem so that regulation and management of trace contaminants can be effective.

In August 1979 the Great Lakes Environmental Research Laboratory began a research program in cooperation with OMPA. The purpose of this program is to develop the ability to predict the environmental consequences of persistent synthetic organic contaminants in

the Great Lakes ecosystem. The assurance of long term OMPA funding has allowed GLERL to develop cooperative agreements with several research institutions and to pursue a comprehensive research program focused on a few questions regarding the flow of selected organics within the Great Lakes. The results generated will be transferable to coastal marine systems.

A predictive capability requires models. Therefore, an in-house modeling team, consisting of chemical, toxicological, ecological, and physical scientists, has been established. This modeling group is supported by researchers working on primary ecosystem processes. Most of the process research has been conducted either in-house or at the University of Michigan; however, our program has now been expanded to include several research groups, an arrangement that allows for a maximum of flexibility.

Our early modeling results indicated that the contaminant concentrations in biota appear to come into relatively rapid equilibrium with the water column and that water column concentrations are mediated by sorption, settling, and resuspension. Benthic organisms appear to be somewhat different and are discussed below. During the past year, a long term near-equilibrium model has been calibrated for PCB's. In this model, all decomposition processes are handled as first order. Recent data from the U.S. EPA indicate that the predictions are reasonable. Hidden in both the model output and data is the fact that the isomeric distribution of PCB's is shifting toward the more toxic highly chlorinated compounds.

Other models that simulate the movement of synthetic contaminants within the Great Lakes at different time and space scales are also being calibrated. More detailed information on the movement of particle associated contaminants is needed for these simulations.

Role of Benthic Invertebrates in the Fate of Pollutants

Many of the major pollutants of concern in the Great Lakes are primarily associated with sediments. One probable mode of entry of these contaminants into the food chain is through ingestion of sediments by benthic organisms, remobilizing the compounds. Benthic organisms may play an additional role in the fate of pollutants through xenobiotic biotransformation. This would result in a direct decrease in the pool of potentially toxic compounds. There have been few studies on accumulation of toxics from sediments. Thus, there is little known about the interaction of infauna with contaminated sediments.

Currently, scientists in the Synthetic Organics and Particle Dynamics Group are examining the kinetics of uptake, depuration, and biotransformation of selected

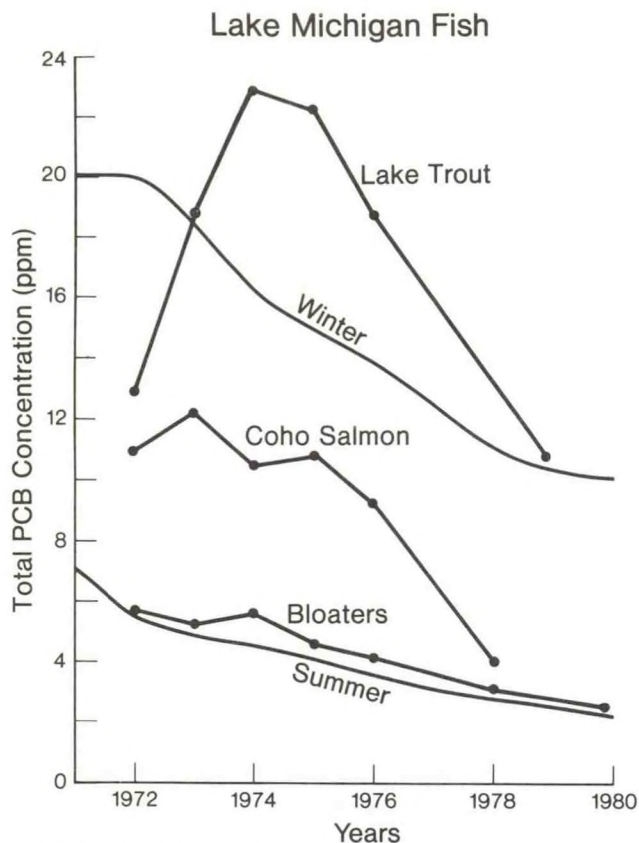

PCB's in Lake Michigan fish. The smooth lines are model output using maximum pollutant removal rates (summer) and minimum rates (winter). Fish data through 1978 are from the International Joint Commission; 1979 and 1980 data are from W. A. Wilford (personal communication, U.S. Fish and Wildlife Service, Ann Arbor).

PAH's by *Pontoporeia hoyi* and other selected benthic organisms. These studies include the influence of temperature and concentration, as well as sediment sorption, on the bioconcentration kinetics of PAH's. The studies are being performed in temperature controlled chambers of both static and flow-through design. Complementing these studies is a field program to measure the PAH content in benthic organisms, sediments, pore waters, and overlying waters.

During the past year, concentrations of 0.1 to greater than 1 part per million of individual PAH's have been measured in several types of benthic organisms from Lakes Erie and Michigan. These concentrations represent bioconcentration factors from water of 10^4 to 10^5 , and they have been confirmed in controlled laboratory studies. These organisms can contribute a substantial fraction of the PAH exposure to fish.

GLERL scientists have determined the preliminary relationship between an organism's bioconcentration factor and the octanol/water partition coefficient

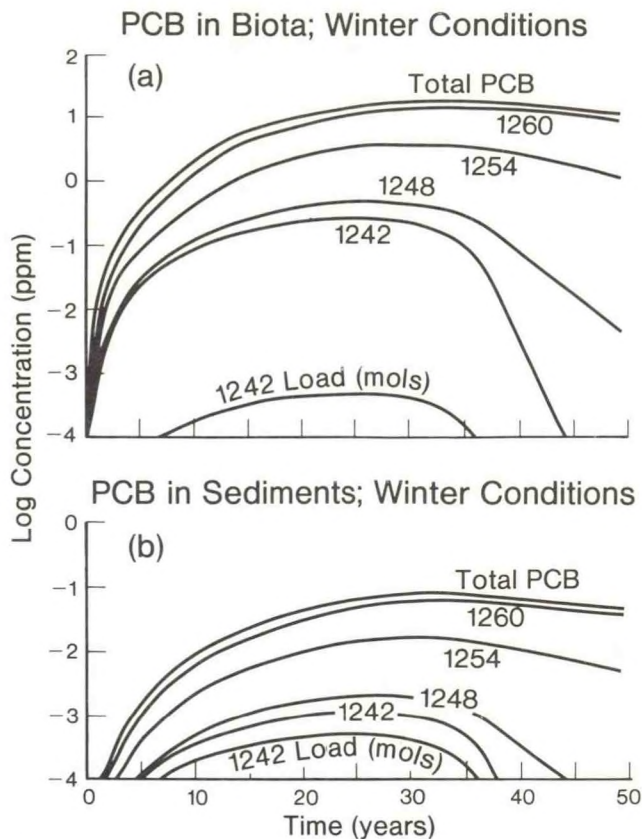

Distribution of PCB's in Lake Michigan biota and sediments. The model predicts decay of total PCB's, but the remaining contaminants will have higher chlorine content and thus may be more toxic.

(proportional to solubility). Benthic organisms appear to be quite different from fish in their ability to concentrate synthetic organic contaminants, presumably because of their direct exposure to high concentrations in the sediments.

Synthetic Organic Partitioning

The association of synthetic organic contaminants with particles in an aquatic system plays an important role in determining the compounds' behavior and fate. This association is generally expressed as a ratio of concentrations in the two phases, termed the partition coefficient (K_p). The magnitude of K_p is a function of the compounds' water solubility and the organic carbon content of the solid substrate.

Recent evidence indicates that this association is proportional to the concentration of particles in the system. During the past year, measurements of PAH's and PCB's in laboratory experiments and sediment-pore water matrices have shown very high contaminant concentrations in the dissolved phase. This indicates that desorption occurs at the sediment-water interface, and it

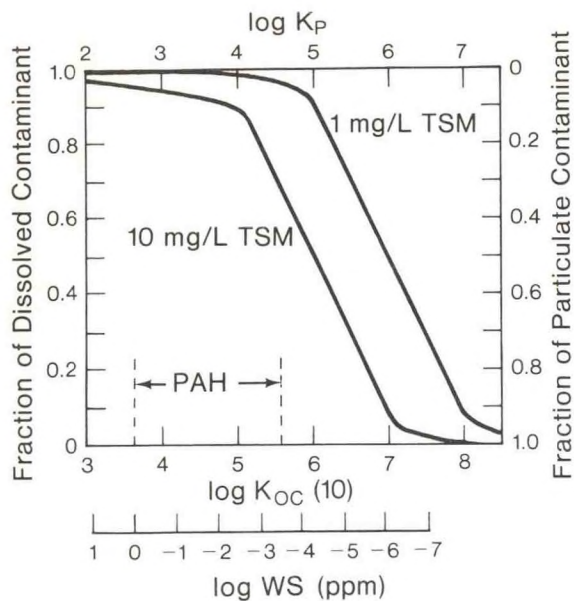

The equilibrium distribution of PAH's (and other organic contaminants) within the Great Lakes water column. The fraction of dissolved contaminant is defined as $f_0 = 1/(1 + K_p * TSM)$. $K_{oc}(10)$ represents the partition coefficient assuming 10-percent substrate organic carbon, equivalent to $10 * K_p$. The region of PAH solubility is indicated. At equilibrium, PAH's are predominately dissolved.

appears that the desorbed contaminants are being complexed with high molecular weight organic compounds. Whether these are free to diffuse back into the water column or are available to the biota is not yet known.

Lake Particle Flux Measurements

Most polluting and enriching substances in the aqueous environment have a strong affinity for fine suspended particles; thus their transport and fate are dictated by the fine particle dispersal system. Total suspended matter (TSM) plays a vital role in the solution chemistry of the Great Lakes. TSM sorbs pollutants from the water, providing a potential mechanism for cleansing the lakes through sedimentation. In some cases, however, the sediments serve as only a temporary reservoir for the sorbed contaminants, later releasing them into overlying water and exposing the ecosystem to "trapped" contaminants. It is necessary at this time not only to know the concentrations of TSM and associated contaminants and nutrients, but to determine the net flux of these substances into the lakes and sediments and the rates of reentrainment.

Some of our previous studies with sediment traps have shown open Lake Michigan metalimnetic TSM

flux to be about 0.7 grams per square meter per day during the stratified, non-storm periods. This agrees well with lead-210 and cesium-137 sediment accumulation rates from the same region, leading us to believe that, during the period of stratification, our traps at 35 meters are measuring gross downward flux of suspended material and its associated contaminants. For storm and non-stratified periods, our measurements show a TSM flux of about 4.6 grams per square meter per day. To improve our model estimates of sedimentation and resuspension, 111 sediment traps were deployed at 12 locations throughout the stratified period and a subset of these (at five locations) were redeployed throughout the winter. A mass balance for PCB's in Lake Michigan can be calculated from this information. Resuspension is seen as a significant input into the water column.

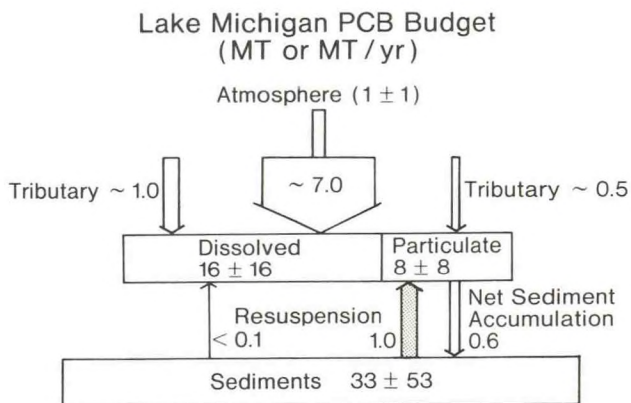

Annual mass fluxes and distribution of PCB's in Lake Michigan. Units for fluxes (arrows) are metric tons per year; units for inventories (boxes) are metric tons. The width of the boxes and arrows are proportional to average inventory and flux values, respectively. Inventory estimates are as follows: atmospheric concentration is 2 ± 2 nanograms PCB's per cubic meter, about 20-kilometers thick layer; water concentration is 5 ± 5 nanograms PCB's per liter. The shaded arrow coming out of the sediment represents the conservatively estimated reentrainment of sediment-bound PCB's.

Studies of Early Diagenesis in the Great Lakes

As part of the study of the long term behavior and fate of toxic organic compounds in the Great Lakes, GLERL scientists have carefully collected box and gravity cores from locations of maximum sediment accumulation from the four lower lakes. At the same time, cores were collected from a few kilometers away, where accumulation was significantly slower, on the assumption that the

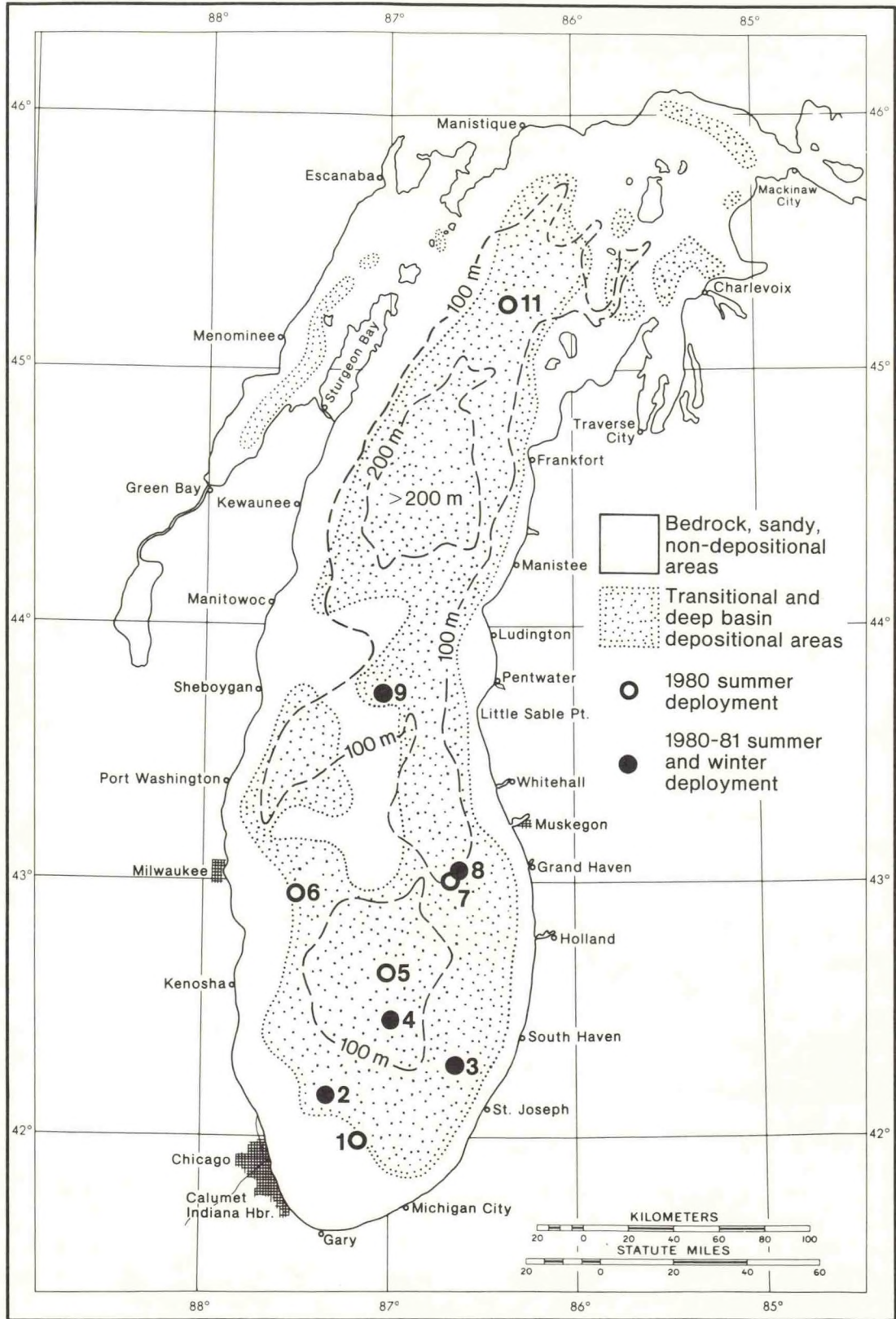

Locations of sediment trap arrays deployed for collection throughout the stratified season. Sediments play an important role in the movement and storage of contaminants.

distribution of compounds reaching these locations would be similar. The field program could not have been conducted without the assistance of the United States EPA, Region V, and the Canada Centre for Inland Waters (CCIW). Analysis of these sets of high and low sedimentation cores will allow scientists to deduce information on the rates of early diagenesis of compounds in recent lake sediments.

At this time, scientists have finished analyzing organic carbon in the high sedimentation cores from Lakes Ontario and Michigan, along with preliminary results of trace organic (PCB, DDT, PAH, mirex, etc.), radionuclide (cesium-137, beryllium-7, hydrogen-3, cesium-144, lead-210, etc.), and trace metal (mercury, lead, iron, manganese, etc.) analyses. This work is underway at GLERL, CCIW, Argonne National Laboratory, and the Universities of Michigan and Minnesota.

Tentative dates derived from the cesium-137 profiles, presently uncorrected for compaction, will be altered slightly after further analytical results are completed. The accumulation rate for the Lake Ontario high sedi-

mentation core (0.37 centimeters per year) is approximately twice that of the Lake Michigan high sedimentation core (0.20 centimeters per year). Recent (upper 10-centimeter) organic carbon content in the two sediments are the same, but earlier sections of the Lake Ontario core have significantly less organic carbon than the Lake Michigan cores. It is not known whether this difference can be attributed to changes in lake productivity due to cultural eutrophication or differences in diagenesis within the sediments. Pore water dissolved organic carbon (DOC) in the 0- to 1-centimeter section of the Michigan core is 35 parts per million, approximately 25 times the DOC in overlying waters. This high DOC content may be important in resolubilizing sedimentary contaminants and moving them back into the active ecosystem through diffusion, resuspension, or interaction with benthic organisms. The results generated from this study will be incorporated into GLERL's models of the behavior and fate of persistent contaminants in the Great Lakes, work partially supported by NOAA's OMPA.

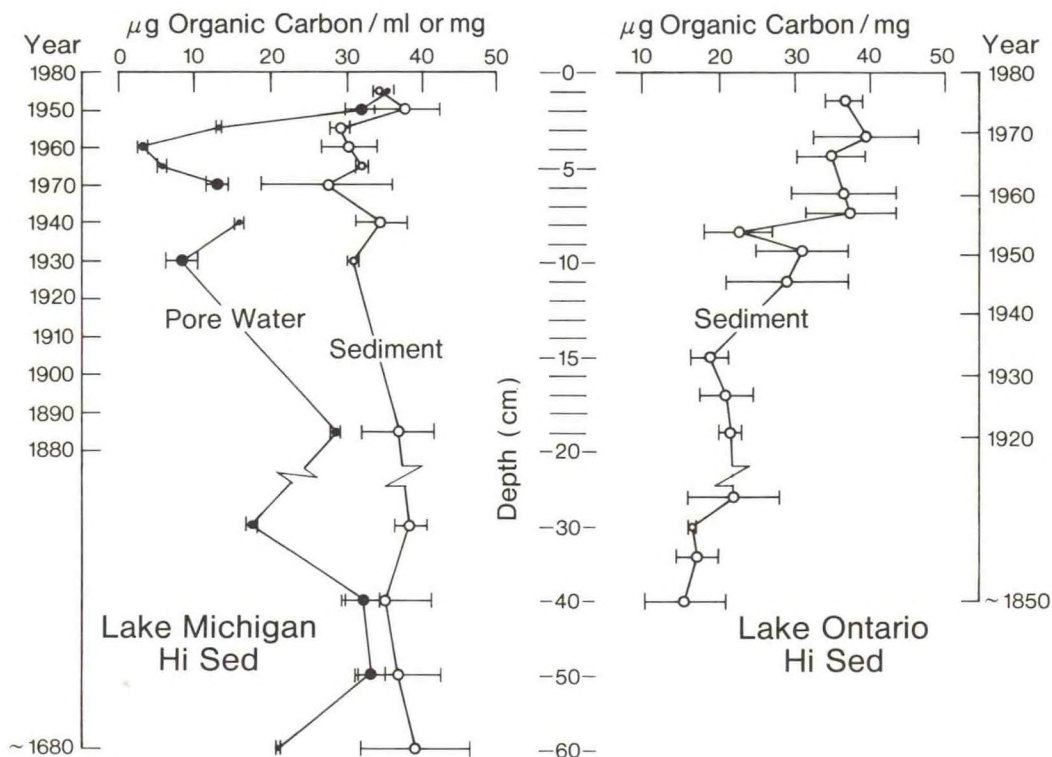

Concentration of pore water organic carbon (milligrams carbon per liter) and sedimentary organic carbon (milligrams carbon per gram) in the Lakes Michigan (left) and Ontario (right) high sedimentation cores. Dates (based on cesium-137) are approximate. The amounts and types of nutrients added to a lake influence the entire ecosystem.

ECOSYSTEM AND NUTRIENT DYNAMICS

The health or well being of an aquatic ecosystem such as the Great Lakes is evidenced by the quantity and composition of biota in the system. Benthic organisms can indicate long term trends in water quality, whereas pelagic biota reflect water quality more immediately. Planktonic plants and animals are of particular interest because they are at the base of the aquatic food chain. The ability to predict quantitatively types and amounts of these organisms in the lakes is important to assessing potential effects resulting from anthropogenic (man-induced) activities or natural changes in lakes or marine coastal ecosystems. The composition and successional patterns of organisms in aquatic ecosystems are affected by the interactions of physical (e.g., light, temperature, ice cover, water movements), chemical (e.g., nutrient supply and availability, toxic substances), and biological (e.g., food chain dynamics, predation,

nutrient uptake, and regeneration) factors.

To accurately predict the effects of man-induced changes on the Great Lakes or marine coastal ecosystems, critical factors affecting the biota must be recognized and quantified as parts of a mathematical model of the system. Conceptual and mathematical models developed at GLERL and elsewhere have demonstrated that nutrient limitation is a major force controlling the quantity and composition of plankton in photic zones of the Great Lakes. Mechanisms controlling nutrient cycling must therefore be understood before changes in the biota and water quality of the lakes can be predicted. The close interrelationships between nutrients, phytoplankton, and aquatic invertebrates require an interdisciplinary research program so that critical processes can be quantified and integrated into simulative and predictive models. The Ecosystem and Nutrient Dynamics Group is investigating factors controlling nutrient cycling and ecological succession in the Great Lakes and is integrating experimental results into ecosystem models applicable to the Great Lakes, as well as to other freshwater and coastal marine ecosystems.

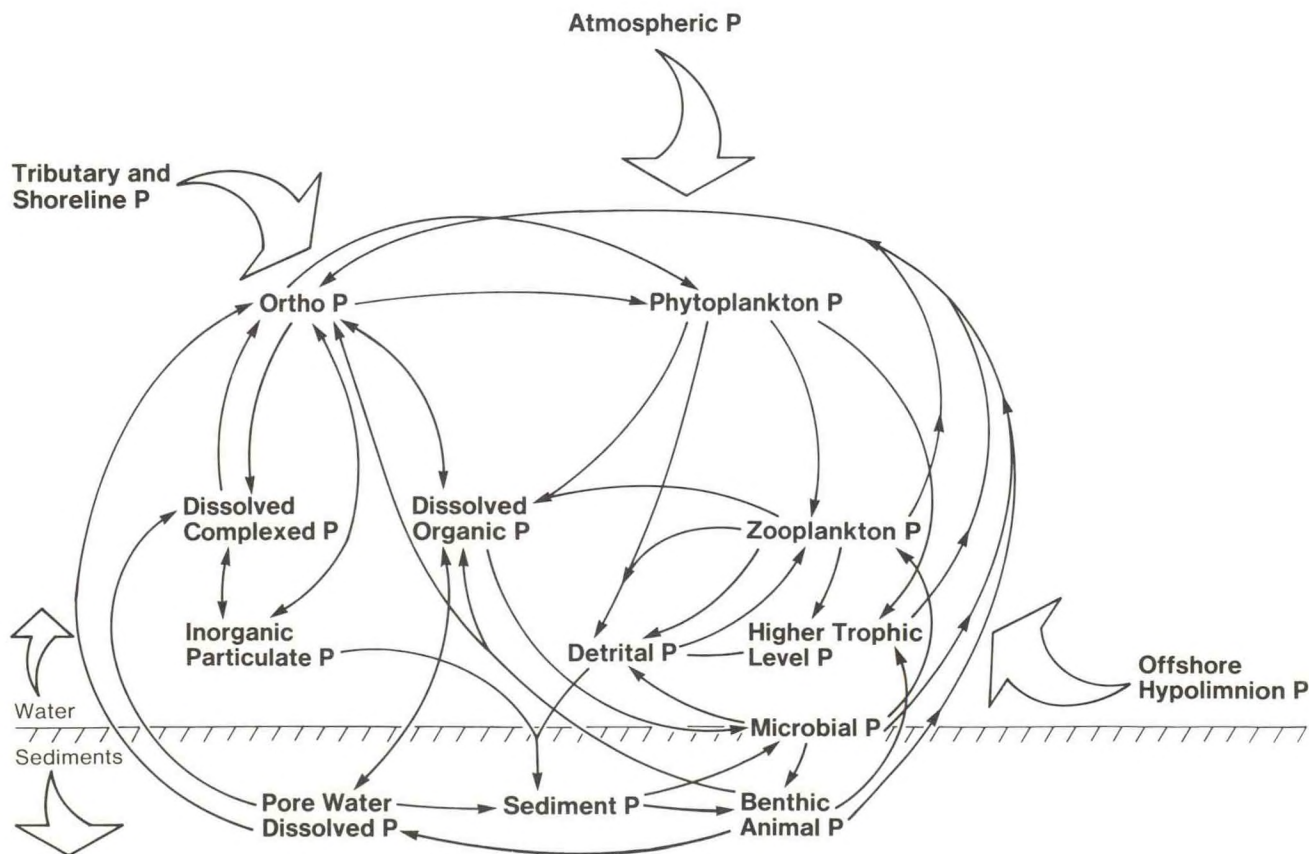

Schematic diagram of phosphorus compartments (bold print) and processes (arrows) important to phosphorus cycling in nearshore zones of the Great Lakes. Phosphorus is the nutrient of most concern to Great Lakes managers because it is often the limiting factor in the growth of phytoplankton.

Nutrient Cycling

A state-of-the-art document completed in 1980 resulted in a conceptual model defining important compartments and processes affecting phosphorus cycling in the Great Lakes and has been used to focus GLERL's nutrient cycling research effort. This conceptual model, along with mathematical models of Lake Ontario's ecosystem, points out the quantitative importance of internal nutrient recycling mechanisms within that lake. These processes must be understood before the effects of nutrients supplied from outside sources can be evaluated.

Model calculations have demonstrated that, without internal nutrient cycling, available phosphorus in the Great Lakes could be removed by phytoplankton on a time scale of approximately a day. Thus, the ability of the lakes to sustain phytoplankton populations is dependent on the recycling of nutrients by pelagic animals, such as zooplankton, or on other internal regeneration processes. Nutrient release by zooplankton and its relationship to food quantity and quality have been difficult to quantify experimentally because of the close connection between nutrients, phytoplankton, and zooplankton. To provide more information about zooplankton nutrient regeneration, microchemical kinetic techniques were developed to assess patterns and amounts of nutrient release for individual animals. Experiments using these techniques demonstrated that phosphorus is released continuously by freshwater cladocerans, with additional spurts at intervals. The marine copepod *Eucalanus pileatus* excretes ammonium continuously, but also occasionally releases amino acid nitrogen in large spurts. Experiments relating quality and quantity of ingested food to nutrient excretion rates further demonstrated the importance of nutrient interactions between phytoplankton and zooplankton. Studies are now under way to quantify nutrient release by Great Lakes zooplankton. This information will be incorporated into ecosystem models to allow more accurate simulation and prediction of nutrient cycling and biological changes in the lakes.

Since aerobic sediments are the major sink for phosphorus in lake systems, processes releasing phosphorus from sediments back into the water must be understood and quantified to develop predictive models of nutrient cycling in lake ecosystems. Nutrient regeneration from lake sediments appears to be an important mechanism providing nutrients to phytoplankton in nearshore zones. Laboratory studies of intact Lake Michigan sediment cores indicated that significant quantities of nutrients (phosphorus and silica) were released from aerobic sediments. Invertebrates of these same intact sediment

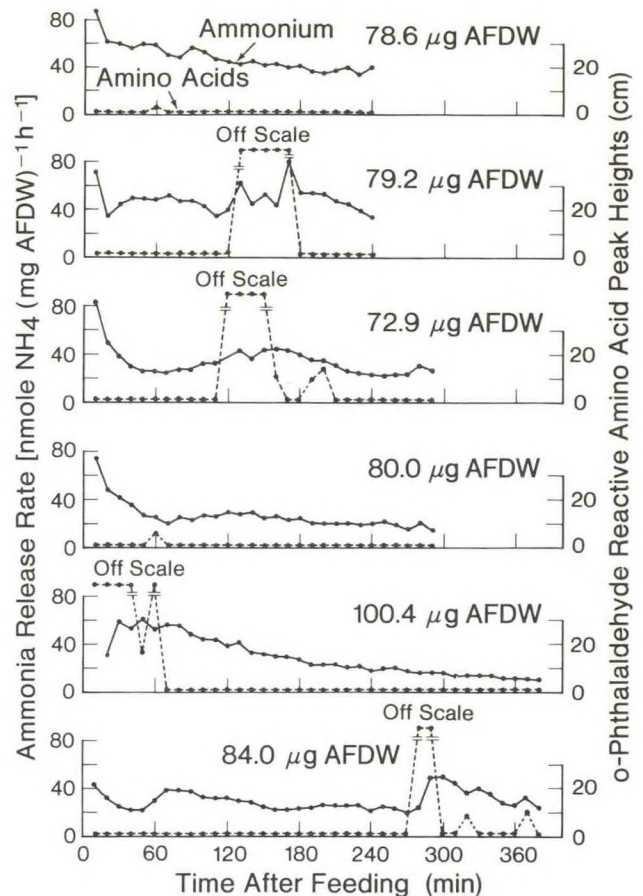

Patterns of ammonia and o-phthalaldehyde reactive amino acid nitrogen release with time after feeding for six individual *Eucalanus pileatus* fed on 3 cubic millimeters *Thalassiosira fluviatilis* per liter for 18-22 hours.

cores were partially counted and identified to correlate faunal abundance with nutrient flux values. Laboratory studies of nutrient excretion by nearshore benthic invertebrates, chironomid larvae and tubificid worms, indicated that excretion by invertebrates could account for most of the phosphorus regenerated from the sediments. Studies on nitrogen excretion by these same animals indicated that the molar ratios of ammonia to phosphate in released materials were greater for the burrowing tubificid worms (35:1) than for the filter-feeding chironomids (15:1). Laboratory microcosm experiments are currently testing the effects of sediment type and organism composition on the release of phosphorus from aerobic Lake Michigan sediments.

Although bacteria and other microbes are thought to be important to the cycling of phosphorus and other nutrients in lakes, their exact role needs to be more completely defined. For example, it is unclear whether bacteria compete with phytoplankton for uptake of in-

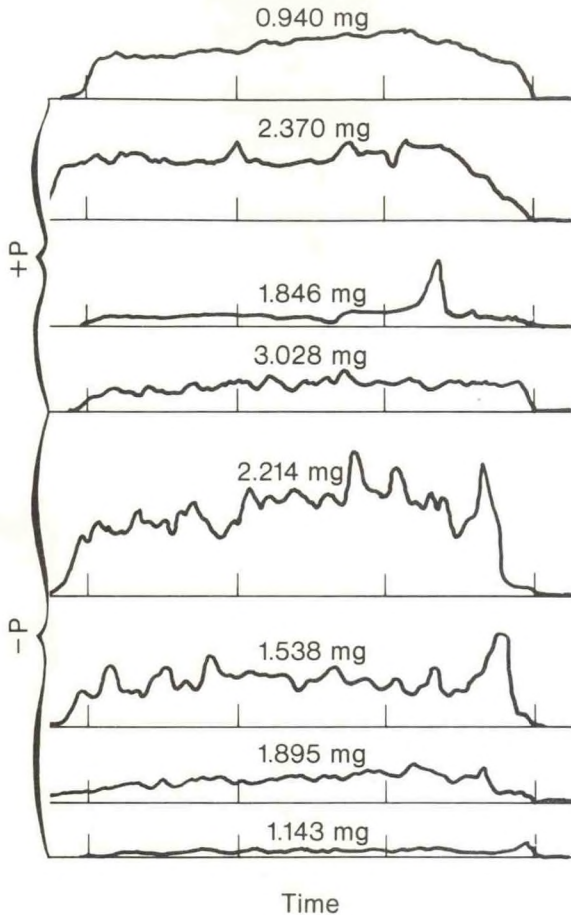

Representative continuous traces of soluble reactive phosphorus release for 30 minutes after animals (*Daphnia magna*) were removed from their food. +P represents animals fed for 3 hours on algae grown on full-strength medium. -P represents animals fed for 3 hours on phosphorus-starved algae. Animal wet weight is indicated on each trace. Height of the trace is proportional to soluble reactive phosphorus release per individual. Nutrient release by pelagic animals must be considered when calculating the cycling rate of the nutrient in the lake.

organic phosphorus in lakes, but size fractionation experiments examining phosphate-phosphorus uptake by bacteria and microalgae in Lake Michigan suggest that bacterial uptake is not a major pathway for biological removal of inorganic phosphorus from lake water. Moreover, the decomposition rates of complex organic nutrients into the elementary forms required by phytoplankton are unknown and should be quantified and included in ecosystem models.

Chemical Speciation

A major factor hindering development of realistic models of phosphorus cycling in aquatic ecosystems is

our general lack of understanding of the chemistry of naturally occurring phosphorous compounds. The composition and availability of phosphorus compounds in lake water and in input sources (e.g., tributaries and atmospheric precipitation) must be known before it is possible to evaluate the impact of phosphorus from different sources on the biota of the lakes. For example, the calculation of kinetic factors, such as the velocity of phosphorus uptake by phytoplankton, is strongly dependent on accurate measurements of ambient available phosphorus concentrations. Since traditional phosphorus methodology does not always measure forms actually available to phytoplankton, additional research is essential to both an understanding of the limitations of current approaches and to development of new approaches to calculate biologically meaningful estimates of phosphorus fractions in the water. GLERL studies have shown that the composition of the soluble reactive phosphorus pool in lake water is heterogeneous and free orthophosphate often is an order of magnitude lower than indicated by chemical measurements, and also that the major fraction of the soluble reactive phosphorus pool is unavailable for immediate use by microorganisms. Direct methods of water sample analysis by liquid chromatography in conjunction with element and group-specific detectors were developed to speciate phosphorus and to examine how it is associated with metals and organic materials in Lake

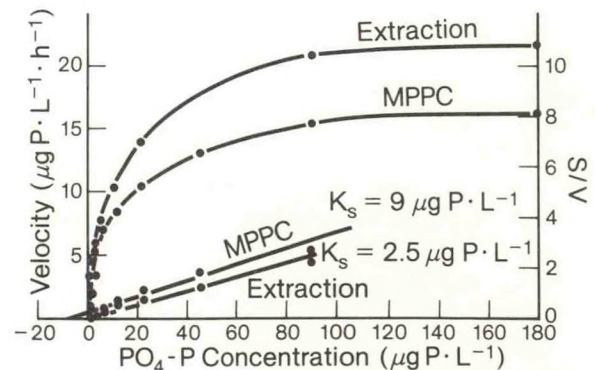

The kinetics of phosphate-phosphorus uptake by a mixed microbial population in Lake Michigan based on two estimates of ambient phosphate-phosphorus concentrations: chemical (extraction) and radioassay estimates of maximum possible phosphate-phosphorus concentrations (MPPC). The curved lines are the result of plotting the velocity of phosphorus uptake versus phosphate-phosphorus concentration. K_s (the affinity of microorganisms for phosphate-phosphorus) is obtained by linear transformation, that is, plotting the phosphate-phosphorus concentration divided by the velocity (S/V) versus the phosphate-phosphorus concentration and extrapolating through the negative y axis. The negative sign is dropped by convention.

Michigan and tributary waters. As a result of this work, techniques were developed to directly fractionate ambient levels of major metals and ultraviolet absorbing organic materials into chemically unique fractions. Chromatographic phosphorus fractionation results suggest that, in their ionic characteristics, acid-hydrolyzable forms of phosphorus are similar to unassociated phosphorus ions; more information is needed to determine the availability of isolated phosphorus forms to algae in the lakes.

Ecosystem and Experimental Models

Simulation and prediction of the effects (both short term and long term) of human impact on the Great Lakes is a vital component of GLERL's research program. GLERL's present nutrient cycling and modeling projects are oriented toward current problems in coastal areas and embayments. This modeling program is designed to synthesize existing information and to coordinate emerging data and theory in such a way as to eventually improve our understanding of, and ability to simulate and predict, the lakes' dynamics.

Errors associated with ecosystem modeling must be assessed to evaluate the usefulness of these models in simulating and predicting environmental phenomena. The effects of uncertain inputs, parameters, and forcing functions on the output of ecosystem models were investigated via first-order variance propagation and by Monte Carlo simulation. For a food-web, nutrient-cycle model of Saginaw Bay, Lake Huron, parameter-value errors were by far the largest contributors to state-variable output errors. It was determined that specific model constructs and associated parameters require further refinement to reduce overall model uncertainty. The work demonstrates certain limits to the accuracy of strictly deterministic models.

A major problem in testing the predictive effectiveness of ecosystem models is the limited amount of comprehensive long term field data available for aquatic ecosystems. Physical, chemical, and biological data collected continuously from Lake Washington over the last 30 years are being used to test a generalized ecosystem model for natural waters, including the Great Lakes. As part of this effort, Lake Washington thermal simulations were modified to include a complete air/water heat balance. Statistical comparisons between airport and lake-shore meteorological observations were completed, and they verified the airport observations. Data on chemical properties and loads have been accumulated and now augment long term physical observations. Evaluating the ability of the model to simulate ecological succession in Lake Washington will help determine

its usefulness for predicting biological and chemical trends in the Great Lakes and other coastal ecosystems.

Microscale Patchiness

The phenomenon of spatial heterogeneity in nutrient supplies caused by excreted nutrient plumes around zooplankters has been suggested as an important factor in the control of both growth and species selection of phytoplankton. Using autoradiographic techniques, GLERL scientists were the first to demonstrate microscale heterogeneous phytoplankton uptake of nutrients excreted by zooplankton. This finding explains the apparent paradox that observed growth of phytoplankton in lakes is much greater than would be expected based on measurable concentrations of "available" phosphorus. Demonstration of this phenomenon changes traditional theories of phytoplankton-zooplankton nutrient interactions and increases our understanding of possible mechanisms responsible for plankton successional patterns in lake and marine ecosystems. Mathe-

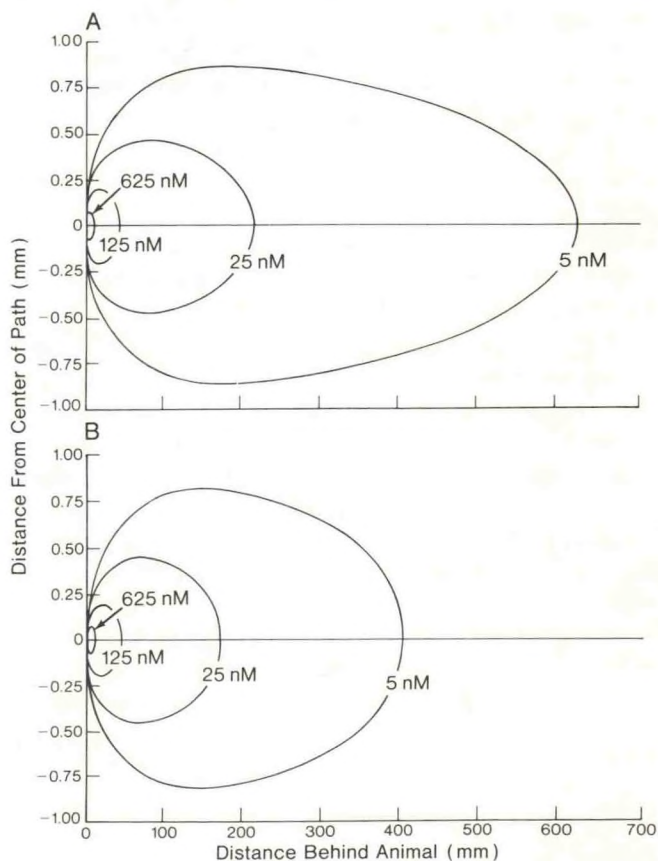

Contour diagrams for the steady-state plume of phosphorus, in nanomoles per liter, (A) behind a swimming *Daphnia pulex* and (B) with algal uptake of phosphorus included.

mathematical models developed at GLERL indicate that the effective sizes of the plumes are substantially reduced in the presence of phytoplankton. Current laboratory studies are designed to demonstrate the significance of patchiness to phytoplankton competition and to provide data for models of species competition based on small-scale processes.

Zooplankton Feeding and Particle Transport

It is necessary to understand zooplankton feeding processes and rates so that the role of these invertebrates in cycling nutrients and controlling phytoplankton successional patterns in the lakes can be determined. The feeding rate of *Diaptomus sicilis* (an important zooplankton species in the Great Lakes) was related to selectivity, effective food concentration, and food concentration in Lake Michigan by describing the functional relation between feeding rate and food concentration for natural seston and for cultured *Chlamydomonas* spp. When the concentration of various mixtures of *Chlamydomonas* species is expressed as effective food concentration, instead of total food concentration, a better fit to the feeding rate–food concentration curve is obtained for the copepod *D. sicilis*. Effective food concentration is the weighted sum of algal concentrations, where the weights are independently obtained selectivity coefficients for different kinds of algae. Selectivity information can be combined with feeding rate information to predict feeding rate for any set of environmental seston concentrations.

The biological aggregation of small particles into larger fecal pellets by zooplankton is an important mechanism for the transport of nutrients and other materials (e.g., toxic organics) to the sediments because large particles settle more rapidly than small ones. Particle egestion and fragmentation by *D. sicilis* and other zooplankton were studied by microscopically examining prerinsed algae from control (without *D. sicilis*) and experimental (with *D. sicilis*) bottles used in feeding experiments on natural Lake Michigan seston. Differences in pellet size and composition lead to variable sinking rates. For example, fecal pellet sinking rates are higher in September because of their high calcium carbonate content at that time.

Long Term Trends and Composition of Benthos in Lake Michigan

Perhaps no other biological group of organisms is a better indicator of water quality than the benthic fauna. Communities respond to and reflect environmental changes over long periods of time. Thus, GLERL scien-

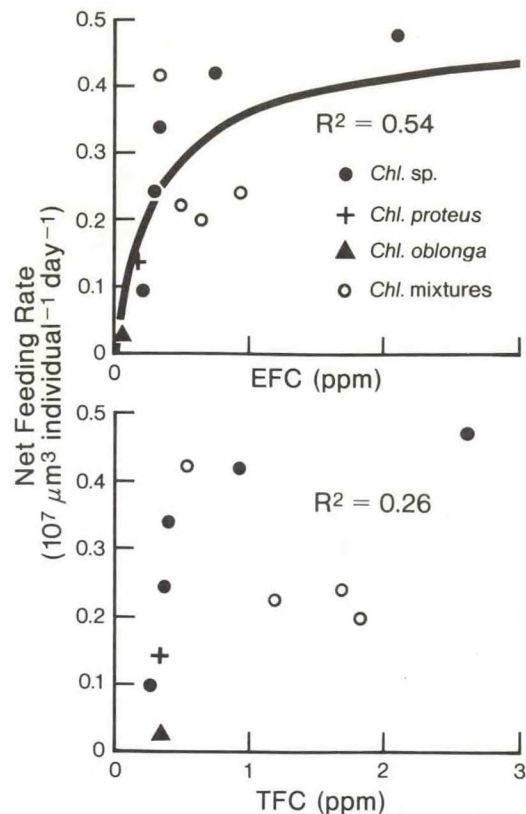

The relationship between feeding rate as a function of effective food concentration (EFC) and as a function of total food concentration (TFC). It is important to distinguish between the total amount of food in the water and the amount available to given zooplankton groups. For example, some food is too large to be ingested by a particular group.

tists are continuing to evaluate present-day distributions of benthic invertebrates in southern Lake Michigan. By comparing the number and kinds of organisms now in the lake to those found 17–50 years ago, they are gaining insight into the lake's changing trophic nature.

Mean and range (in parentheses) of the ratio of the biomass of the macrobenthos to that of the meiobenthos at each depth for each year, 1976–79

Year	Depth (meters)		
	11	17	23
1976	12:1 (10–19:1)	14:1 (10–20:1)	37:1 (28–53:1)
1977	8:1 (6–12:1)	21:1 (10–73:1)	45:1 (15–118:1)
1978	5:1 (1–14:1)	–	–
1979	5:1 (3–13:1)	–	–

Although small benthic animals (meiobenthos) may be important to the cycling of nutrients and toxic materials in the sediments, the composition and relative abundance of these organisms in the Great Lakes have not yet been determined. To quantify the meiobenthos of nearshore southeastern Lake Michigan, benthic samples were taken at three depths at monthly intervals from May to November 1976-79. The abundance of the meiobenthos in nearshore Lake Michigan was

greater than that of most freshwater lakes and was comparable to abundances found in nearshore marine environments. The biomass of the meiobenthos was at times 20 percent as large as the biomass of larger benthic animals (macrobenthos). The meiobenthos has an estimated metabolic rate fivefold higher than that of the macrobenthos. Thus, energy flow (or materials movement) through the meiobenthos can equal that of the macrobenthos.

LAKE HYDROLOGY

The emphases of the Lake Hydrology Group are on the hydrologic cycle, including channel hydraulics, and on ice research. The objectives of the hydrologic research are to develop improved methods of predicting and simulating water supplies, lake levels, connecting channel flows, and flows in tributary streams and to improve understanding of hydrologic processes. The objectives of the ice research are to improve the prediction of freezeup, breakup, areal extent, and thickness of ice in the Great Lakes and their bays, harbors, and channels and to improve understanding of the natural variability and optical properties of lake ice cover. The research involves an integrated program of data collection, data base development, analysis, prediction, model development and testing, and advisory service.

Prediction and simulation information on water supplies, lake levels, and flows is necessary for water resource planning and management and for the solution of problems with water supply, water quality, shore erosion, hydropower, navigation, recreation, and flooding. Primary users of hydrologic information are the U.S. Army Corps of Engineers, the Great Lakes shipping industry, the U.S. EPA, recreational boating enthusiasts, the power utilities, the Great Lakes States, and the general public.

The amount, type, and extent of ice on the Great Lakes is of interest to all those who use the lakes in winter. Prediction information on Great Lakes ice is of value to shoreline engineering, winter navigation, hydropower generation, water supply management, and waste disposal. Primary users of ice information are the U.S. Army Corps of Engineers, the U.S. Coast Guard, the National Weather Service (NWS), the St. Lawrence Seaway Development Corporation, the Great Lakes shipping industry, and the general public, including shoreline property owners.

Hydrology

Lake Hydrology scientists continue to develop mathematical models to simulate and predict basin runoff into each of the Great Lakes. Runoff predictions are necessary for water supply and lake level forecasting. The models will also help scientists understand the response of watersheds to natural forces. The GLERL Large Basin Runoff Model is an interdependent tank-cascade representation of basin runoff that uses analytical solutions of climatological considerations relevant to large watersheds. A mass balance is coupled with physically-based concepts of linear-reservoir storages, partial-area infil-

tration, complementary evapotranspiration and evapotranspiration opportunity based on available supply, and heat balance determinations of snowmelt and net supply. Daily air temperature, precipitation, and runoff data are used to calibrate the model's nine parameters.

The model, developed and tested last year, has been refined and applied to major data sets this year. This involved data acquisition and reduction for all Great Lakes basins; about 148 flow station and 217 meteorological station records, representing 25-30 years of daily values, have been assembled. These data are now being reduced to hydrometeorological data sets for each of the 121 subbasins around the lakes. This work has been completed for Lakes Superior, Erie, St. Clair, and Ontario and is about one-third completed for Lakes Michigan and Huron.

The model was applied to Lake Ontario data and grouped for 15 subbasins around the lake, as well as for the entire basin above Kingston, Ontario. Both lumped- and distributed-parameter approaches were used to apply the model. Eleven subbasins and the entire basin were modeled at weekly and monthly mass-balance computation intervals.

Results of this test indicate that the large basin runoff model is an accurate, fast model of weekly or monthly runoff volumes from large watersheds. An added advantage is the model's relatively simple calibration and data requirements. Parameters have physical significance and calibrated values obtained from parameter optimizations are reasonable; those obtained from weekly applications are consistent with those from monthly applications. For the Lake Ontario Basin data, weekly applications make significantly better use of available data on a monthly basis than do the monthly applications, and cost about four times as much to use. The distributed-parameter applications are marginally better than the lumped-parameter applications, and cost 11 times as much to use. The weekly distributed-parameter application to Lake Ontario yielded a weekly correlation of 0.93, a monthly correlation of 0.95, and an annual correlation of 0.97. The model is now being applied to the remaining Great Lakes basins.

The model has good potential for use in predictive studies since basin storages are represented directly. Although predictions are limited by available meteorological information, forecasting is practical if data can be supplied on a near real-time basis. This may soon be possible for many areas of the Great Lakes Basin since the requisite data are precipitation and air temperature. Work is underway for the necessary data links with agencies in the United States and Canada.

The International Great Lakes Technical Information Network Board of the IJC has chosen to use the model

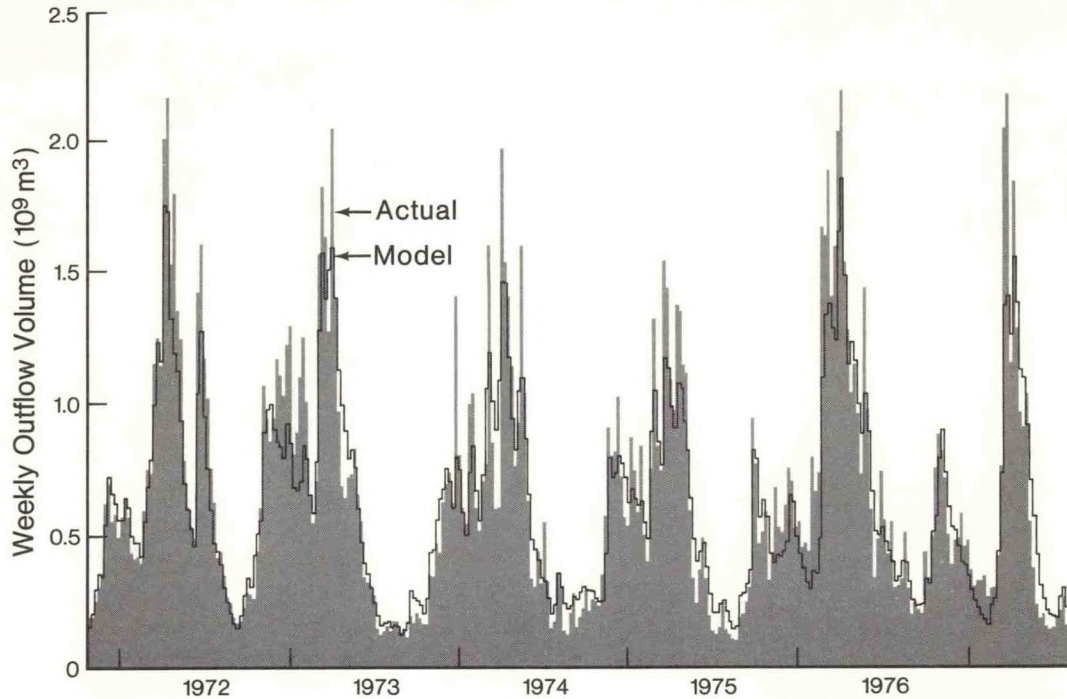

GLERL Large Basin Runoff Model weekly distributed-parameter application to Lake Ontario runoff above Kingston, Ontario. This comparison of actual flow versus flow simulated by the model indicates close correlation.

in their assessment of data network needs in the Great Lakes Region. It is also being used in connection with the joint United States-Canadian experimental gamma radiation snow water equivalent and soil moisture surveys to be conducted by flights over Lake Superior during the 1982-83 winter. Model applications will assess the information value of the experiments and enable such data to be incorporated into predictive models. The model is also being considered for use by the U.S. Army Corps of Engineers' Hydrologic Engineering Center at Davis, California.

During the past year, a monthly climatic water balance model was developed and calibrated for the United States and Canadian land basins of Lake Erie. This model is less complex than the large basin runoff model. The model uses inputs of monthly average air temperatures and precipitation and computes the runoff into Lake Erie and the moisture conditions of the basin. The potential evapotranspiration used in the model is determined by the Thornwaite procedure. On an annual basis, the model has a root mean square error of 5 centimeters or 7 percent and a correlation coefficient (between model and measured annual runoff) in excess of 92 percent.

The model was used as part of a study to determine the impact of secular changes in precipitation and air

temperature on the water supplies to the Lake Erie Basin. Existing precipitation and temperature data bases used as input by the model generated the runoff time series between 1900 and 1937, for which few data had been available. The study concluded that the primary cause of the recent high water supplies since 1966 has been an increase in precipitation averaging 6 percent over the long term average. The model indicated that this increase caused a 16-percent increase in runoff. Another factor has been a 0.3°C decrease in the average air temperature for this period. In general, model tests have indicated that a 0.5°C decrease in air temperature will increase runoff by 6 percent. The study demonstrates the usefulness of the model to fill in runoff data gaps and to access quantitatively the impact of climatic changes and trends on basin runoff.

The model is currently being used to improve water supply forecasts for Lake Erie. It is run at the beginning of each month using antecedent data to determine the basin moisture conditions and thus the relative runoff potential. Predicted or statistical air temperature and precipitation values can then be used as input to the model to provide forecasted runoff from 1 month to 1 year in the future. During the upcoming year, this form of the model will also be applied to the Lake Superior and Lake Ontario drainage basins.

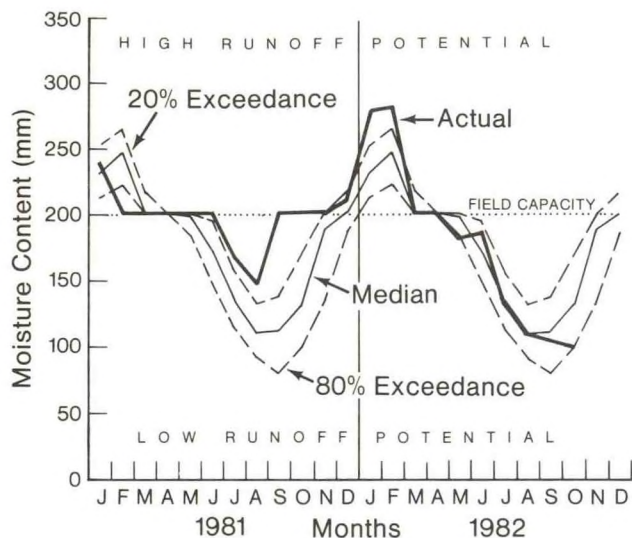

Lake Erie Basin moisture content from the Lake Erie climatic water balance model. When the soil moisture content is above the 20-percent exceedance curve, the runoff potential for the basin is high. When the soil moisture content is below the 80-percent exceedance curve, the runoff potential is relatively low. The snowmelt contribution to the spring runoff is given by the January or February maximum soil moisture content.

Last year marked the end of field data acquisition for the Unsteady Overland Sedimentation Project. GLERL is conducting this project in cooperation with the U.S. Department of Agriculture's SEA with input from the U.S. Geological Survey. SEA conducted the experiments, and GLERL is providing the theoretical developments. Specially prepared plots of agricultural lands were exposed to computer-controlled precipitation from SEA's rainulator, furnished by the National Soil Erosion Laboratory at Purdue University. As simulated rain fell, flow rate and sediment concentration were monitored in 15-second increments at the end of rills (the channels cut into the soil by the moving water). Data collected are currently being reduced. Preliminary analysis suggests that the rising part of the characteristic humped shape of the sediment concentration-time curve results from delivery of sediment from the areas between rills in excess of its flow removal within the rill during the early portion of the hydrograph. The drop down to steady state occurs because, as the flow geometry develops, deposition increases. Early indications are that rills develop naturally to the point at which sediment flow from them balances the additions to them from the interrill areas.

Sediment flux to fluid flow in a rill is represented by physically based models of simultaneous sediment entrainment (detachment), deposition (settlement), and lateral inflow. This is proving to be an improvement

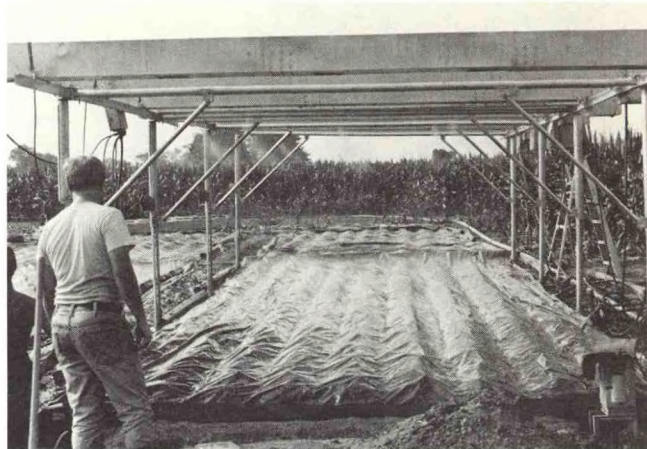

Joint GLERL-Science Education Administration (SEA) rainulator experiments. The rainulator delivers predetermined precipitation to specially prepared plots of agricultural land in a study of the relationship between precipitation and sediment loading.

over existing concepts for describing sediment concentrations. Unsteady flow and sedimentation in overland rills are described by continuity equations and approximations of flow, entrainment, and transport capacity. For an assumed rill pattern on an overland plot, the equations are reduced to one-dimensional equations of motion, which do not use sheet flow approximations. The method of characteristics solution to these equations for uniform rainfall excess yields both the hydrograph (rising limb and uniform crest) and a three-part sediment concentration graph, with a predicted time lag between peaks of these graphs. The resulting model can use reasonable parameter values rather than requiring conventional sheet flow approximations. This is an advance over earlier, less complex models. In particular, the exponent on depth for entrainment is far greater than that obtained from distorted sheet flow models.

The theory developed and tested in these experiments will be useful in ultimate assessments of sediment loadings to the lakes from agricultural lands. The theory provides physical understanding of the processes involved from which to build expanded models of overland sedimentation. Other applications include modeling of atmospheric transport of pollutants to the Great Lakes and other coastal and estuarine ecosystems.

Artificial channel changes in the outlet of Lake Huron through the St. Clair River during the present century consist of dredging for commercial gravel removal in the upper river during 1908-25 and uncompensated navigation improvements for the 25-foot and 27-foot projects completed in 1933 and 1962, respectively.

These artificial changes increased the outlet channel capacity and permanently lowered the levels of Lakes Michigan and Huron. The total effect of these changes on the levels of Lake Michigan-Huron and on the upper St. Clair River profile above St. Clair was determined with dynamic flow models, which is a more sophisticated approach than that used in previous determinations. The ultimate effect of the dredging described above was a lowering of lake levels by 0.27 meters, which represents a tremendous loss of fresh water resource (32 cubic kilometers). The water level was lowered less in the river downstream at the St. Clair gage. This lowering is nearly the same regardless of wa-

ter supply conditions, as shown by the upper river open-water profiles for the years 1970 and 1973, representing median and high-water levels and flows, respectively.

The Great Lakes connecting channels are used intensively for navigation, and in addition, a large number of industrial concentrations and municipalities are located along their banks. These factors carry a risk of oil spills or other chemical spills in these channels. The likelihood of spills, along with their trajectories, travel times in the channels, and containment, is the primary interest of the National Response Organization for Oil and Hazardous Spills, in which GLERL participates. Travel time tables were prepared for the St. Clair and Detroit Rivers in response to a request from the organization. The total travel time along the main channels of these two rivers is quite similar—21 hours for the St. Clair River and 19 hours for the Detroit River under mean flow conditions. However, the travel time is relatively uniform throughout the Detroit River, while more than a third of the total time (8 hours) in the St. Clair River is occupied in the delta, known as the St. Clair Flats. The initial information request was later expanded to include the St. Lawrence River and the Illinois Waterway (Illinois River complex). These two rivers are completely regulated, complex hydraulic systems, with large short term fluctuations in flows; thus, travel time tables for these rivers consider the high and low flow conditions in addition to the mean flows. The travel time tables for the upper St. Lawrence River (international section) were prepared by using the GLERL dynamic flow model to compute sufficient velocity distribution along the river and then by verifying with measurements, where available. The total travel time in the international section of the St. Lawrence River varies from 135 hours for the high flow to 216 hours for the low flow, with 164 hours for the mean flow. Work on the travel time tables for the upper Illinois Waterway is in progress, but will require field measurement of velocities.

The study of the winter flow regimes of the St. Clair and Detroit Rivers was advanced with the successful completion of the first field season (October 1981–May 1982) of continuous velocity measurements in the St. Clair River. Preliminary analysis of the data indicates substantial differences in winter flows obtained from the current meters and from the GLERL dynamic flow models. Ice effects are suspected to be the main reason for these deviations. The ice concentration and, thus, effects are progressively higher downstream, raising the water level gage readings in the same order and reducing the river slope and flows computed by the models. The analysis also shows that the previous ice monitoring program was insufficient and must be improved.

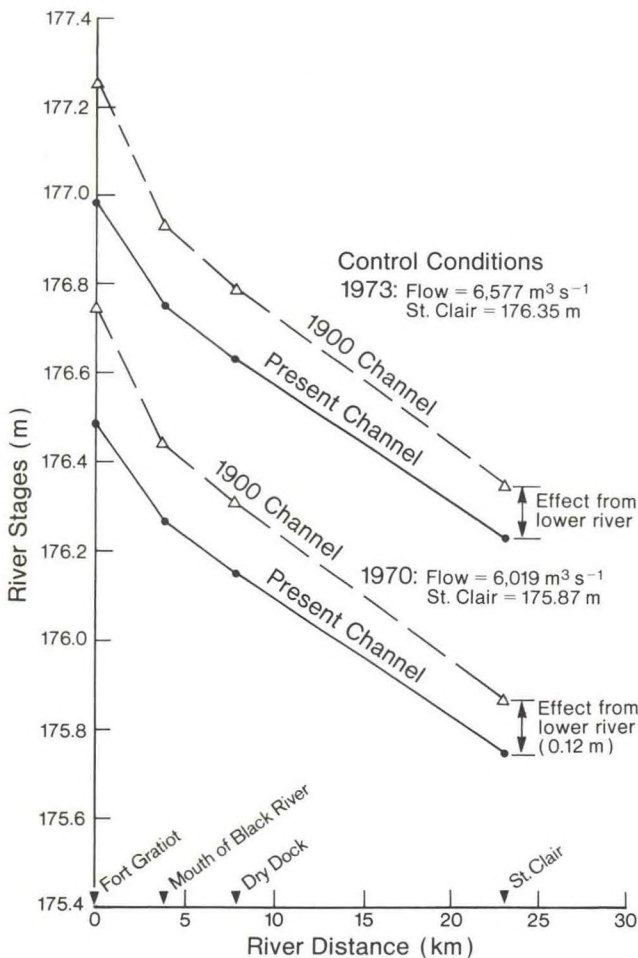

St. Clair River water levels at various points down the river from the Fort Gratiot gage with the present channel conditions and with the 1900 channel conditions (before gravel removal and dredging for navigation improvements deepened the river). The levels with each channel condition are shown under two flow conditions—high flow (1973) and average flow (1970) to indicate that water supply has very little effect on the profiles during the two periods.

The program is being expanded to simultaneous winter flow measurements in the St. Clair and Detroit Rivers, with additional meters ordered for this purpose.

Ice

Analysis of a 20-year digital ice concentration data set for the Great Lakes continued in 1982. The *NOAA Ice Atlas* scheduled for publication in late 1982 was delayed to early 1983 because of unforeseen delays in the production of the charts. Products of the statistical analysis of the 20-year data set include graphs that portray lake-wide averaged ice concentrations of the maximum, minimum, median, mode, and average ice concentration for nine half-month periods. The maximum and minimum graphs illustrate the extremes and variation of lake-wide averaged ice concentration and the median, mode, and average graphs are representative of the normal progression of ice-cover concentration over the nine half-month periods for each Great Lake.

The maximum and minimum graphs over the 20-year period of record indicate that ice concentration is most variable during the middle of the winter when ice covers normally reach their greatest areal extent on the Great Lakes. The median ice cover during the time of greatest ice cover, the second half of February, varies from 90 percent on Lake Erie to 24 percent on Lake Ontario. A comparison of all five values for each Great

Lake shows that Lake Erie, because it is by far the shallowest of the five Great Lakes and therefore responds rapidly to changing atmospheric conditions, develops the most extensive ice cover and has had the greatest ice-cover variation over the 20-year period of record.

A report documenting the file structure and format of the computerized 20-year ice concentration data set was completed in 1982. That report will facilitate the distribution of that data set, which is scheduled to be archived at the National Snow and Ice Data Center of the Environmental Data and Information Service, Boulder, Colorado, in 1983. It is hoped that this data set will prove useful to a broad spectrum of users in the fields of research, operations, and planning. Further analysis of these data will include space and time correlations of the ice concentrations on a sublake spatial scale.

Over the past year, a set of ice forecasting techniques has been developed for the U.S. Army Corps of Engineers, Detroit District. The general problem was to see how well ice-cover formation, growth, and breakup could be predicted on the St. Marys River, the connecting channel between Lakes Superior and Huron. Although the river is one of the busiest commercial waterways in the world, it is ice covered for up to 4 months of the year, causing significant ship movement problems. To provide the greatest flexibility in forecasting lead time, methods were chosen that relied only on observed ice cover and water conditions and air temperature projections. In the cases of forecasting

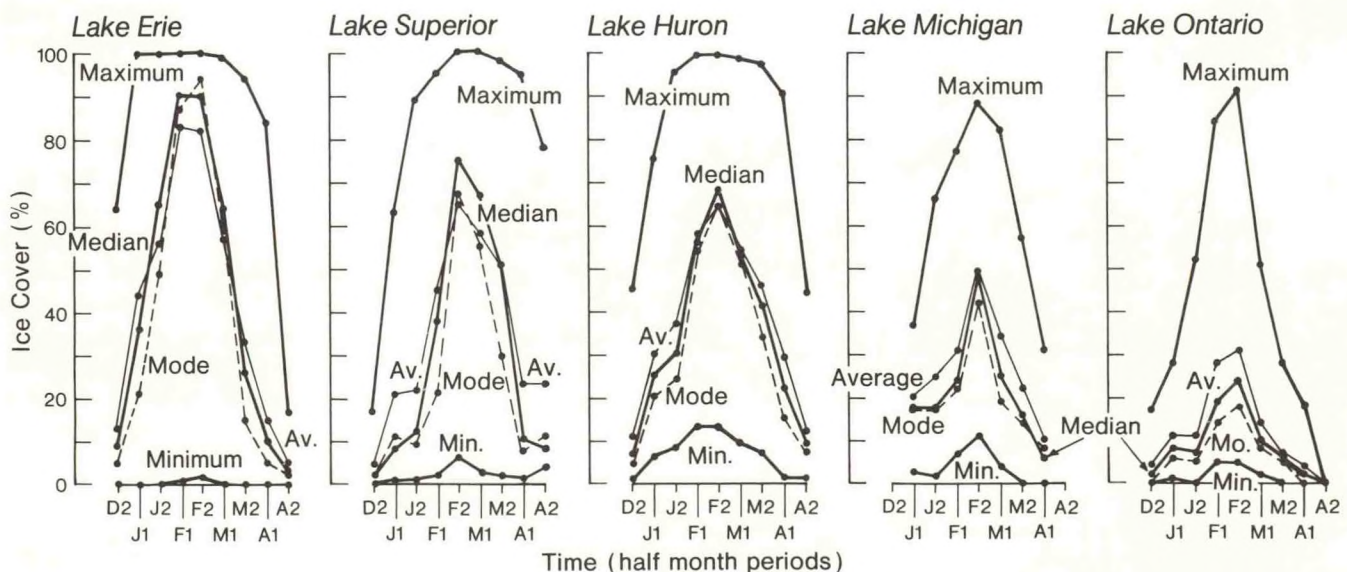

The maximum, median, mode, minimum, and average ice-cover concentration (in percent) for each of the Great Lakes for the nine half-month periods from the last half of December (D2) through the last half of April (A2) over the 20-year period 1960-79. Mean lake depth and air temperatures are two of the most important factors determining ice-cover concentration.

freezeup and ice growth, quasi-analytical methods were developed to allow both water temperature decay and ice growth rates to be expressed as a function of air temperature. The breakup of the ice cover does not occur simply as a function of air temperature. Therefore, linear regression techniques were used to relate breakup to observable ice conditions or events earlier in the season. All of the techniques are more accurate than forecasting from historically average conditions. Their greatest value, however, is the projection of ice conditions or events no more than a month in advance. The reason for this 1-month limitation is not only that forecasting air temperature is so uncertain but also that the effects of a given state of the system extend only so far into the future.

An analysis of nearshore ice thickness data for 30 stations around the Great Lakes was completed this year. The purpose of the study was to evaluate to what extent ice growth is a function of air temperature alone, as measured at the nearest National Climatic Center reporting weather station. Although forecasting ice growth was not a goal of this study, the results suggested that site-specific forecasts could be developed

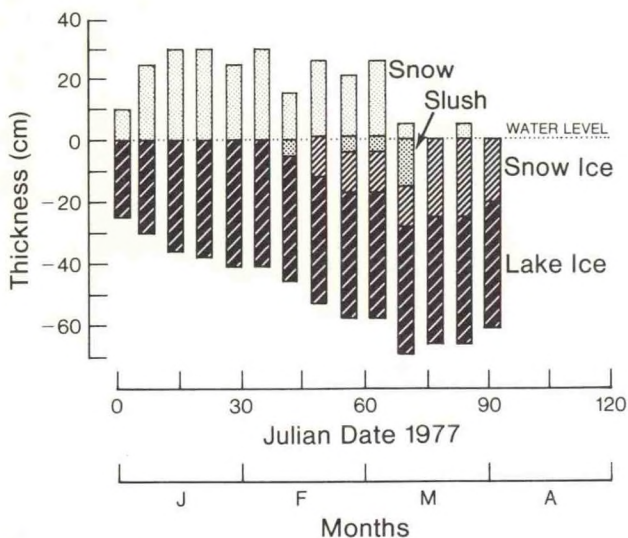

Weekly observations of ice-cover stratigraphy at a site on the St. Marys River between Lake Superior and Lake Huron. Snow cover initially acted as a thermal insulator. Ice thickness increased later in the season, however, as snow-ice formed at the ice-snow interface.

solely on the basis of air temperature projections. Growth rates at the individual sites were reasonably consistent over the 10-year period of study although there was considerable variability between sites. The major cause of variability is the snow-cover thickness, which can either accelerate growth (if the ice cover floods) or inhibit it. A secondary result of the study was that it documented the widespread presence of snow-ice in the Great Lakes. This ice type is optically and mechanically different from lake ice ("black" ice) and can contribute up to 50 percent of the ice-cover thickness.

A study testing the applicability of an Environmental Research Institute of Michigan's classification scheme to Landsat satellite imagery of Great Lakes ice cover has been concluded. The work may have both practical significance to the shipping industry in route selection and theoretical significance to energy balance studies since it indicates methods of measuring lake-wide radiation reflectance. By identifying two calibration points with known reflectance values for the four spectral bands received by Landsat, it is possible to convert satellite digital counts to ice-cover reflectance values without the need to compute the magnitude of atmospheric effects under clear skies. A number of ice types can be differentiated on the basis of their spectral signature and hence can be identified in the satellite image. This study relied upon a previously determined classification training set for Great Lakes ice types. Results, however, indicated some errors in the set that can be corrected in the course of long term studies of spectral reflectance for different ice types.

Under contract to GLERL, a deterministic Great Lakes ice dynamics simulation model has been developed and calibrated for use as an aid in forecasting Lake Erie ice conditions. The model permits short duration forecasts (on the order of days) to be made on the basis of predicted winds and air temperatures and ice conditions observed at the beginning of the forecast period. The model can be periodically updated as meteorological conditions become known and as new information is acquired about ice conditions. It is also possible to operate the model with probabilistic input data. Future ice conditions can then be specified in terms of likelihood, giving the user an additional basis for decision making.

PHYSICAL LIMNOLOGY AND METEOROLOGY

The Physical Limnology and Meteorology Group studies the physical variables describing the lake environment and the way they change with external forces. The relevant variables are currents, temperatures, waves, water level fluctuations, sediments, and suspended matter. The primary driving forces are the wind acting on the lake surface, the heat exchanged between the lakes and the atmosphere, and the river flows. The purpose of this group is to develop and test models that improve prediction of these variables. These models will, in turn, allow estimates of chemical and biological properties of the lakes that are important in waste disposal, power generation, fisheries management, and water supply planning. In addition, waves and water level oscillations are hazards that may result in loss of lives and in damage to shoreline property, shipping, and recreational activities.

The scales of the variables that need to be modeled and predicted range from years to seconds and from the size of the lake down to a few meters. In view of this tremendous range in time and space, the various phenomena must be separated according to their scales to understand and model them better. Hence, research in the Physical Limnology and Meteorology Group has been arranged in two areas. The first is water movements and temperature, which encompasses studies of lake-wide and nearshore circulation, seasonal changes in circulation, and upwelling. The second area is winds and waves, which deals with wind-generated waves, storm surges, seiches, and overlake winds. The latter area involves prediction on a real-time basis. The group also contributes to studies of particle dynamics conducted by the Synthetic Organics and Particle Dynamics Group and scientists at the University of Michigan. This program was initiated because toxic organic substances and nutrients enter the lake attached to particles. Hence the pathways and ultimate fate of these pollutants in the lakes depend on the movement of various types of particles through the lake environment.

The approach used in studying the above problems is a combination of experimental (laboratory and field), theoretical, and modeling efforts. Experimental data provide information on what happens in the lake. Theoretical studies predict new phenomena and help plan new experiments. Modeling studies incorporate the important physical processes into governing mathematical equations and extrapolate the equations over time to

predict the future state of the lake. Experimental data, in turn, can validate the accuracy of these predictions.

Water Movements and Temperature

Mathematical models were used to examine rotating current patterns (called rotational modes) in Lake Michigan and the results compared with observations recorded in previous years. The method consisted of running time-dependent circulation models to determine the distribution of kinetic energy with frequency. Numerical results for a 5-kilometer grid were computed and analyzed for impulsive wind stress and for observed (3-hourly) and daily averaged, time-dependent wind stress.

The impulsive wind stress generated a multitude of spectral peaks, several near observed periodicities. Some of the spatial structures associated with the peaks were confined to relatively small topographic features in the numerical grid, while others showed large-scale spatial dependence. Results of this simulation were used in planning where to deploy current meters for the Lake Michigan rotational mode experiment described below. The average kinetic energy spectrum of currents computed from the 3-hourly wind stress values is very similar to the spectrum of the observed currents and to the spectrum of the wind stress itself, whereas the spectrum of currents computed from daily-averaged wind stress values is less similar to observed. This interesting result has important implications for all our applications of current modeling.

A rotational mode field experiment was designed and implemented in Lake Michigan to explore further the spatial structure and intensity of these important oscillations. Based on observations of southern Lake Michigan in 1976 and from numerical simulation, an array of current meters (with temperature recorders) was deployed at 15 locations in the lake in July 1982. Two of the locations were near the sites of meteorological buoys deployed by NOAA's National Data Buoy Office (NDBO). These buoys measure wind speed and direction, air and water column temperatures, solar radiation, air pressure, and wave height. The other sites were selected because models indicated they would be important in determining wave phase and propagation characteristics. All of the moorings were fitted with current meters at 15 and 50 meters below the water surface. At the NDBO sites, current meters were also placed at 75 meters below the water surface to provide added information for mooring design and cable configuration of the meteorological buoys because NDBO eventually plans to add other sensors (e.g., current meters) to the stations.

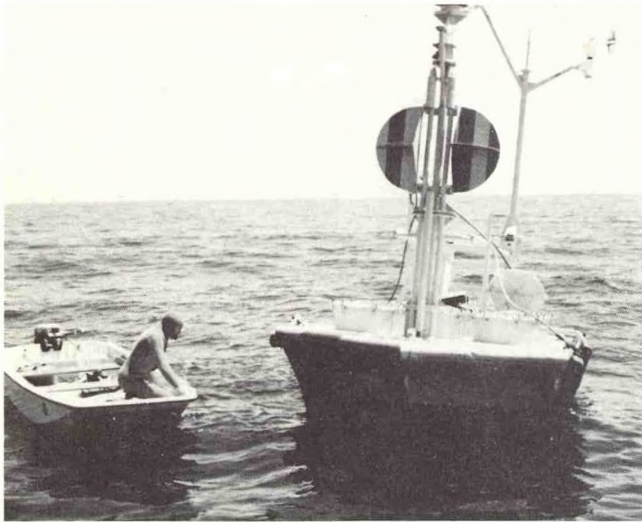

A GLERL scientist inspecting the National Data Buoy Office (NDBO) permanent meteorological buoy in southern Lake Michigan. He found storm damage to the subsurface temperature sensors.

Photo courtesy of the NDBO.

The moorings are scheduled to be retrieved in summer 1983. This long deployment period, necessary for the analysis of the long period (longer than about 60 hours) rotational modes also afforded an opportunity for the long term deployment of sediment traps in Lake Michigan. Eleven of the moorings (i.e., all except four of the closely spaced ones across the mid-lake ridge) have a suspended sediment trap 20 meters below the surface. Four of these eleven, including those at the NDBO sites and two other moorings near the centers of the deepest lake basins, have three other sediment traps suspended to provide a vertical profile of concentrations. These additional traps are at 7, 25, and 100 meters above the lake floor. Quantity and physical properties of the trapped suspended sediments will subsequently be related to the intensity and character of the current flows and to the lake-wide circulation and transport patterns.

While this fixed current metering program was in progress, a moving current meter experiment was also attempted. Satellite-tracked current drifters were launched within the fixed current meter array. The objective was to compare the two methods of measuring currents and to test the GLERL spill model. Since this spill model should predict the same trajectories as are obtained from the satellite-tracked drifters, a comparison of observed (from drifter buoys) and predicted (from spill model) trajectories would test the model's accuracy.

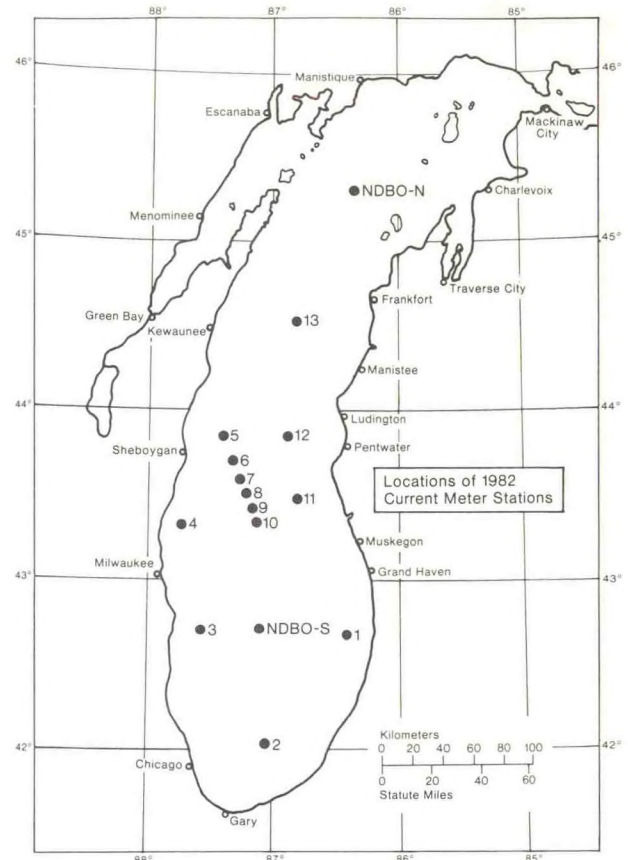

Locations of 1982 current meter stations. Two of the buoys were located near the permanent National Data Buoy Office northern (NDBO-N) and southern (NDBO-S) buoys. The other 13 sites were selected because the bathymetry and wave structure in those areas indicated they would be critical in determining phase and propagation characteristics of topographic waves.



Deployment of a current meter in Lake Michigan. These meters record currents and temperatures for 1 year and provide the fixed array data used in water movement studies.

To determine whether the drifters wash ashore so quickly in the Great Lakes that they are of limited value and whether the frequency and accuracy of their transmitted positions is sufficient, GLERL purchased four drifters from the Polar Research Laboratory in Santa Barbara, California. The surface float contains the transmitter and batteries (with a life of 6 months), and communicates with the ARGOS system onboard TIROS/NOAA satellites. The position of the drifter, within about 0.5 kilometers, is determined by Doppler shift and transmitted to a ground station. These data are available via a portable computer terminal at any telephone. Since deployment, the drifters have stayed offshore. One drifter path indicates they are capable of following the contour of the shoreline without being beached. As of yet, satellite contact has not been lost for any extensive length of time.

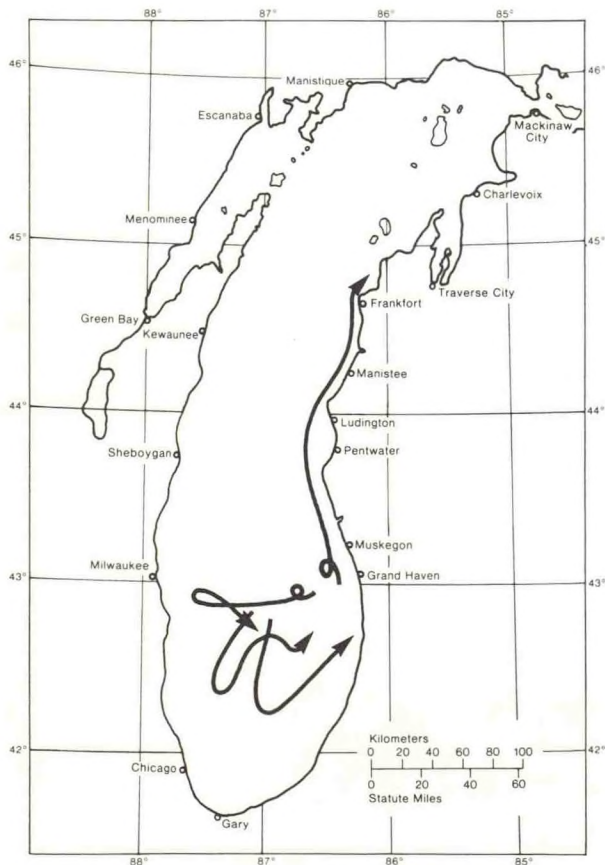

Satellite drifter tracks from September 15, 1982, to October 15, 1982. The satellite drifters will be used to test the GLERL spill model.

To examine the drifter movements in Lake Michigan, a three-dimensional current model will be used. It uses

the increased capability of the computing facility at the Environmental Research Laboratories (ERL) Headquarters in Boulder. It will be used to improve our spill models, and the drifter trajectories will provide an important learning and fine-tuning data set.

Physical Limnology and Meteorology scientists continue to analyze Lake Erie data toward the goal of describing the year-round currents in the lake. Movements of the summer hypolimnion (the cold water layer confined to depths below the thermocline) in relation to wind stresses are being charted because the movement or stagnation of the layer plays an important role in determining whether or not anoxic conditions develop in this bottom water mass. The oxygen usage of biological processes and bottom resuspended materials can deplete the oxygen supply in these hypolimnion waters if they are isolated from the surface water and from atmospheric recharge. The intensity and duration of the stratification that isolates the bottom layer and causes its volume to vary from year to year are dependent on externally applied physical forces. Knowing how these forces determine bottom water dynamics is a key to understanding the oxygen depletion phenomenon.

Winds and Waves

Another important, continuing effort is that to improve predictions of winds and waves on the Great Lakes. During 1981 scientists completed the field measurements and preliminary analyses of currents, waves, water levels, and winds recorded in a cross section of the coastal boundary layer and surf zone of Lake Erie. The purpose of that experiment was to observe the response of the coastal boundary layer and surf zone to the passage of storms. Data were collected during four major storms, of approximately 2-days duration each, from September 19 to October 4, 1981. From these detailed measurements, momentum fluxes during the growth and decay phases of the four episodes are now available. The experimental setup consisted of a surf zone array designed and operated by the University of Michigan and deep water current meter and Waverider buoy moorings and a tower operated by GLERL. The surf zone array consisted of a dense array of bi-directional current meters and wave staffs extending from shore through the surf zone and nearshore region. The tower, located 6 kilometers offshore in 13 meters of water, recorded directional wave, current, and meteorological information. The entire experimental setup was located on a transect extending 8 kilometers offshore.

During one episode, wind direction changed suddenly from alongshore to onshore. Prior to the wind shift, overwater fetch was generally long, offshore currents weak, and offshore waves strong, with only about half of the wave energy reaching the surf zone. After the wind shift, overwater fetch decreased and the wave heights were reduced. Wave potential energy in the surf zone was closer to offshore energy. The nearshore currents were stronger. Strong winds generated a longshore pressure gradient opposite the wind direction that was strong enough to overcome direct wind forcing of the current at the offshore station even before the wind shift. The nearshore currents were wind- and wave-driven.

In addition to its use by oceanographers for estimation of waves, currents, and water level fluctuations on the lakes, overlake wind information is required by mariners for navigation purposes, by meteorologists for weather forecasts, and by climatologists for evaporation calculations. Regular, year-round, and overland meteorological observations are recorded by the offices of the United States NWS and Canadian Meteorological Service. GLERL scientists used these available data and the buoys deployed in Lake Erie during 1979 by Canadian scientists to test three different methods of determining overlake wind speed as a function of overland wind speed and air-sea temperature difference. The results show that different methods provide generally similar estimations with root mean square errors above

2 meters per second. Thus, the statistical methods for determining overlake wind speed from overland wind speed have not improved markedly. Further significant improvements will require a new method with a different approach.

A new wave measurement program has been implemented in western Lake Erie to study wave characteristics as affected by island chains. This Lake Erie experiment consists of two Waveriders, one deployed to the east of the western basin island chain and one to the west. The eastern Waverider is in the proximity of the NDBO NOMAD buoy. Therefore the measurements, in addition to providing a study of island chain effects on wave characteristics, can also be used to compare Waverider and NOMAD buoy measurements. The Waverider wave data will be telemetered to a shore receiving station and transmitted via telephone line to GLERL; they are also available in real-time to the Cleveland NWS Office for their marine wave forecasts.

The NOAA NBDO has been deploying NOMAD buoys in the Great Lakes for collecting routine wave and meteorological data since 1980. The network now consists of eight NOMAD buoy stations in Lakes Superior, Michigan, Huron, and Erie. The abundant data available provide an excellent data base for model development and calibration. GLERL scientists have initiated several studies to use these data to improve wave prediction models.

SPECIAL PROJECTS

The Special Projects Group emphasizes environmental systems studies and applied modeling. The objectives are (1) to predict the effects on the Great Lakes ecosystem of management alternatives and man-induced changes, (2) to develop and apply systems analysis methods, such as optimization analysis and risk assessment, to help solve water resource problems, (3) to develop predictive models for practical application in assessing management alternatives, and (4) to develop information to minimize costs and risks in pollution management.

Research conducted by the Special Projects Group tends to be holistic in scope, i.e., it attempts to take an overall approach. Therefore, research focuses on long term rather than short term ecological effects. It also integrates or synthesizes research from a variety of disciplines and agencies (GLERL as well as other agencies and academic institutions) for practical applications and considerations. This requires a great deal of coordination between GLERL staff and scientists and engineers from other organizations.

This year Special Projects research has emphasized the practical aspects of three major topics that are expected to be the major Great Lakes research thrust during the 1980's—(1) trace toxic contaminant pollution, (2) the response of the lakes to the nutrient abatement program of the 1970's, and (3) water quantity. The Great Lakes appear to be especially susceptible to toxic substance problems, and because these toxics may affect human health, practical means must be developed to deal with this problem. During most of the 1970's, however, most research was on nutrient pollution, with virtually billions of dollars spent to reduce the load of the nutrient phosphorus to the lakes. It is important now to evaluate the effects of phosphorus control programs to determine whether these programs have been cost-effective. Finally, because of world-wide water shortages, the allocation of the vast quantity of water in the Great Lakes is becoming an important issue, with far-reaching consequences.

Inherent in the Special Projects program is the premise that cost-effective management of the Great Lakes requires that the lakes be managed as an integrated system. Management actions applied to one lake or one use affect the other lakes or other uses. For example, a fisheries management plan for Lake Michigan cannot be developed without taking into account the influences it will have on Lake Erie. Nor can a toxics contaminant control program be implemented without weighing the economic implications of such a program.

Just as modern medicine is beginning to develop an approach called holistic health care, whereby nutrition, stress management, biofeedback, and other approaches are all used to maintain and promote good health in humans (as opposed to the conventional patch-up method, which treats symptoms), an ecosystem or holistic management concept must be instituted to promote the good health of the lakes.

Toxic Substances

The Great Lakes have probably been more susceptible to toxic contaminant problems than any other area in the world. This problem has been especially difficult to control. As a result, considerable effort was expended this year to develop and refine an easily implemented toxic substances budget model for use by managers and other decision-makers.

The management model developed and documented simulates the concentration of a contaminant in the sediments and overlying water column of a lake. The contaminant being considered is divided into that associated with organic and inorganic particulate matter and that dissolved in the water. Adsorption/desorption plays an important role because only the portion of a contaminant associated with particulate matter is subject to settling and resuspension and only the dissolved component is subject to diffusion and vaporization. The principal application of such a model is to predict the

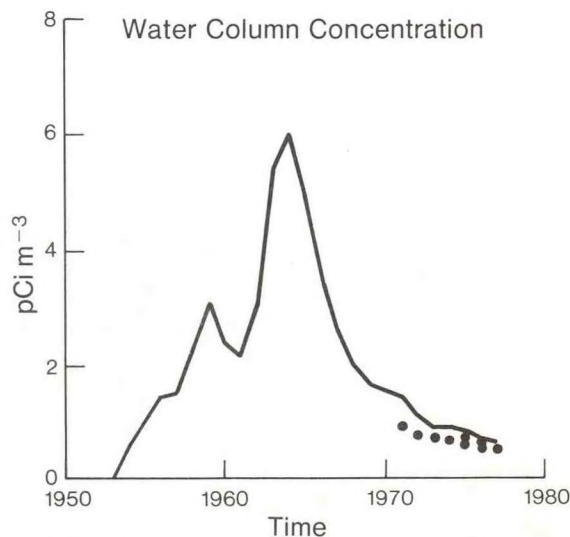

Projected water column concentration of plutonium-239 in picocuries (pCi) per cubic meter of water in Lake Michigan. Dots show actual plutonium measurements. The radioactive substance plutonium is used as a tracer to test the toxic budget substance model.

year-to-year and steady-state responses of the water column and sediments of the Great Lakes to changes in the loading rate of a contaminant and/or particulate matter.

Although the human health threat has been the main motivation for research on Great Lakes toxicants, few contaminants have been evaluated with regard to the actual risk they pose to human health. Therefore, an assessment of the possible health risks of PCB's, one of the chemicals that bioaccumulates dramatically in Great Lakes fish and the subject of considerable environmental research by GLERL scientists, was undertaken.

Individuals who habitually consume large quantities of fish from the Great Lakes, especially Lake Michigan, will have substantially higher intakes of PCB's than the general population. Based on conservative extrapolations from animal studies, such individuals face an increased, although relatively small, risk of developing cancer. More information, such as may be provided by ongoing epidemiological studies of subpopulations exposed to higher-than-normal PCB levels, is needed to define the associated risks more clearly. Further, more information is needed on the possible health effects of PCB's transferred from mother to infant.

Despite concern over the potential health effects of contaminants found in the Great Lakes, the fact that levels of such contaminants as PCB's and DDT are decreasing is cause for optimism. It would appear that control measures previously established are beginning to be effective. Nevertheless, it is necessary to continue assessing the distribution and fate of Great Lakes toxicants because of their effect on human health.

Nutrient Loads

Excessive nutrient loads pollute lakes by upsetting the ecological balance. Reliable information on nutrient pollutant inputs to the Great Lakes is necessary for successful application of many of the mathematical models developed at GLERL. Understanding the relative importance of nutrient inputs is also essential if the most cost-effective management strategy for the Great Lakes is to be determined. Furthermore, during the 1970's, billions of dollars were spent on pollution control in the Great Lakes Basin. The results of this unprecedented abatement effort have only begun to be manifested, so observations of pollutant inputs to the lakes in coming years should provide valuable information on the effectiveness of cleanup efforts.

Beginning this year, a procedure was implemented to update information on United States tributary pollutant inputs of total phosphorus, soluble reactive phosphorus, suspended solids, total nitrogen, nitrate, am-

monia, and chloride. The ratio-estimator technique used accounts for the effects of the variability of flow on pollutant loads over an annual cycle. In addition, GLERL scientists developed a procedure to estimate flows and concentrations in unmonitored and ungaged areas. These data will provide the long term estimate of the variability of pollutant loads so necessary for an understanding of lake dynamics.

Phosphorus continues to be the key nutrient considered in Great Lakes management. However, not all of the phosphorus entering the lakes affects biological productivity. GLERL scientists, in cooperation with university researchers, synthesized information from around the basin and found that significant portions (40 percent or more) of the phosphorus added to the lakes by association with particulate material cannot be used in the growth of algae and higher plants and thus are not pollutants. Whether particulate phosphorus becomes all or partly bioavailable in the lakes depends on the concentration of soluble inorganic phosphorus in the receiving water and the position (location) of the particle in the lake. A mathematical model was used to illustrate the special importance of positional limitation. Information on bioavailability is of great practical importance since it can lead to considerable savings in the cost of phosphorus control programs.

Although not a nutrient, chloride loads to the Great Lakes are important indicators of pollution. Therefore, as part of this year's activities, a Great Lakes chloride budget was developed. Chloride loads were found to be as follows: Lake Superior— 0.3×10^6 metric tons per year, Lake Michigan— 0.9×10^6 metric tons per year, Lake Huron— 1.1×10^6 metric tons per year, Lake Erie— 3.7×10^6 metric tons per year, and Lake Ontario— 6.3×10^6 metric tons per year. Of late, chloride inputs, especially industrial inputs, have decreased, indicating progress in pollution control.

Although chloride loads are decreasing, they are still much higher than before 1900. As a result, in the large upper Great Lakes, which respond very slowly to loads of chemicals such as chloride, concentrations are still rising. Of most concern is the projected buildup in Lake Michigan, where chloride concentrations are predicted to increase over the long term from 8 to nearly 20 milligrams per liter if current loads continue. Although the ecological effects are not clearly established, elevated concentrations of chloride and associated ions (e.g., sodium cations) have been linked to less desirable algal assemblages.

Water Quantity

With water in short supply in many areas of the United States, national attention has been focused on

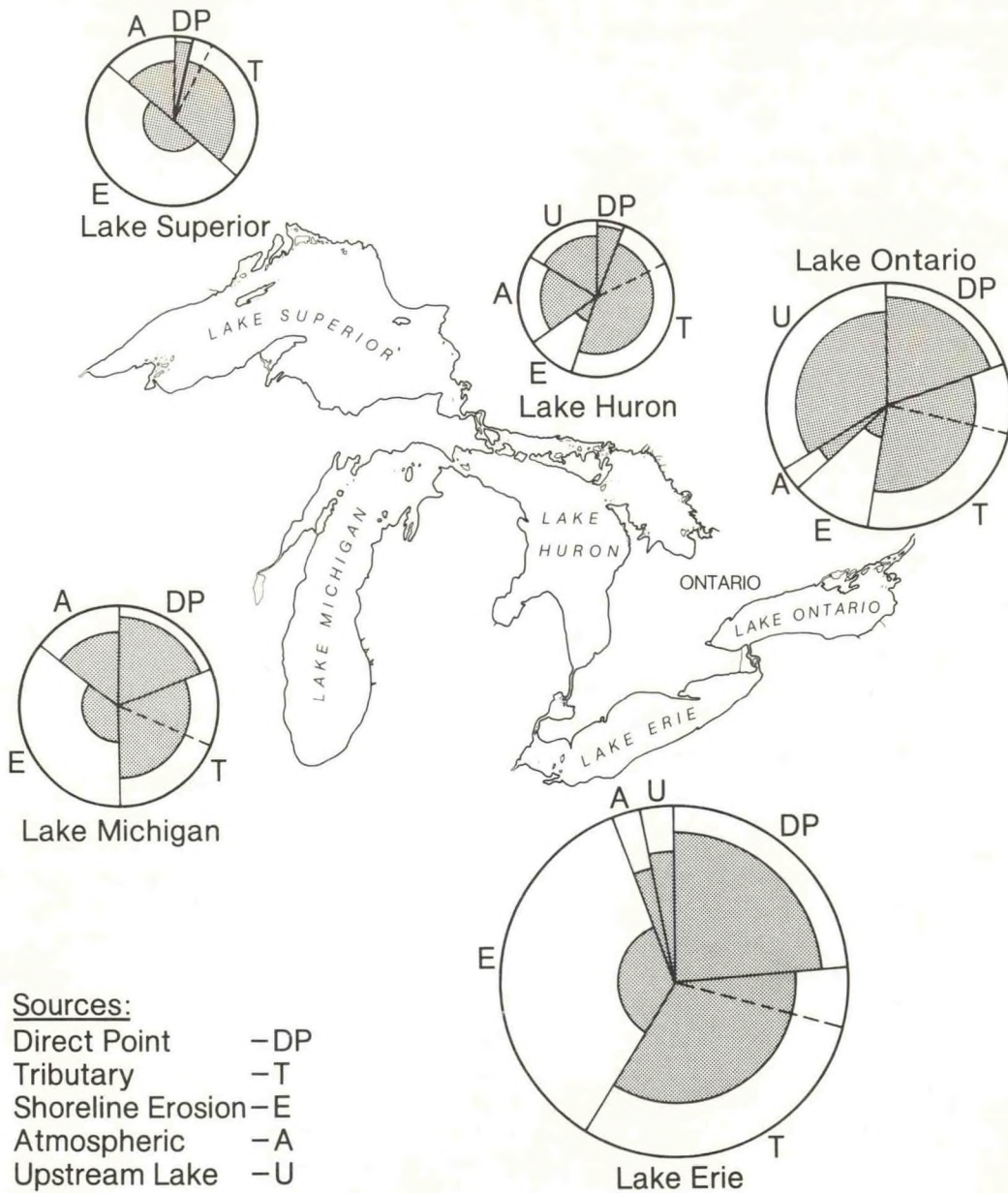

Total phosphorus loads to each of the Great Lakes. The size of each circle is proportional to the total phosphorus load to each lake. The shaded areas indicate the potentially bioavailable phosphorus portion of the different sources. The shaded areas of the tributary and shoreline erosion inputs denote upper estimates of bioavailable phosphorus. The dashed line within the tributary area separates point (adjacent to direct point sources) and diffuse contributions.

the vast reserve of high quality water held in the Great Lakes system. Based on a preliminary analysis done this year, it was concluded that a considerable volume of water could conceivably be withdrawn from the system without causing a large drop in lake levels relative to natural conditions. A diversion of 60 cubic meters per second, less than the current diversion out of Lake Michigan through the Chicago Sanitary Canal, would

supply the water needs of New York City. Nevertheless, a drop in lake levels of only a few centimeters has an important effect on the hydropower production at various locations along the system. Furthermore, international treaties restrict the amount of water that can be removed. Therefore, it is unlikely that water will be exported out of the lakes in the near future. But, because Great Lakes water may someday be exported, it is pru-

dent national policy to maintain or improve the quality of the lakes through careful and diligent research and management.

Another concern for the future is an increase in the consumptive use of Great Lakes water. Water lost from the system because of consumptive use is water withdrawn but not returned. Examples of consumptive use include evaporation losses from power plant cooling systems and incorporation of water into industrial products. (Water diversions from the Great Lakes are not considered to be a consumptive use.) Recently, based partly on work done by GLERL scientists, it was estimated that consumptive use could increase about five-fold over the next 60 years. To put this projected increase into perspective, a hydrologic response model developed at GLERL was used to project the effect on lake levels. Results indicate that the unregulated lakes (Michigan, Huron, and Erie) will be most affected. On the basis of consumptive use projections for all the lakes, the average lake level on the unregulated lakes could be lowered about 21 centimeters by the year 2035. Although this change is not large relative to natural fluctuations in lake levels, some impact on navigation, hydropower, fisheries, wildlife, and recreation

could occur. Little or no impact on lakeshore interests is expected, however. Thus, in the years ahead, consumptive use of Great Lakes water will have to be a factor in lake management.

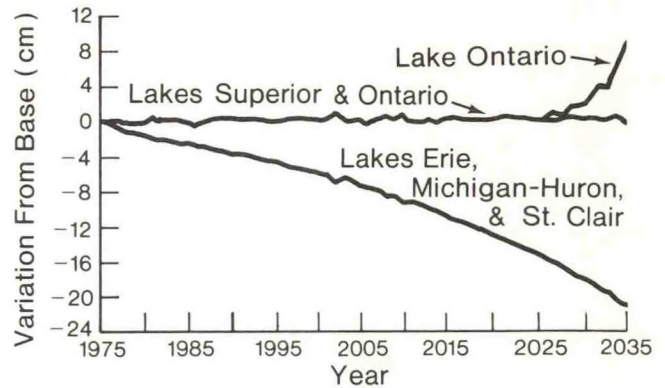

Projected impact of consumptive water use on lake levels. The apparent anomaly of a rise in Lake Ontario water levels after the year 2026 with a continuing increase in consumptive water use is due to the inability of the existing regulation plan to accommodate the progressively decreasing supply of water into the lake after that time.

INFORMATION SERVICES

The dissemination of scientific products in a form compatible with user needs is vital to fulfillment of the GLERL mission. Since research costs cannot be justified if the results are unused, a principal GLERL activity is maintenance of an advisory service as a means of providing scientific information in a form geared to user needs.

This past year, as part of that service, GLERL provided over 3,600 research products in response to over 2,400 documented requests. Of these, 42 percent came from institutions of higher learning, 31 percent from U.S. and foreign federal governments, 15 percent from private industry, 7 percent from domestic and foreign state governments, and 5 percent from private citizens. This is in addition to regular mailings to those who have indicated interest in a 6-month listing of available publications and one or more of the five types of GLERL publications: chemistry and biology, environmental systems engineering, ice, lake hydrology, and physical limnology and meteorology. Yet publications are but one form of environmental information. Also included are predictions and simulations produced from environmental models, forecasts and forecast techniques, descriptive or analytical information on the present or past status of one or more limnological characteristics of a lake or of the system, and data bases. Many of these involve what might be termed "technology transfers." A partial list of GLERL technology transfers effected this year and users is given below.

Technology Transfers

Equation of State Derivation and Method to Convert Observed Pressures to Depths.

User: NDBO

Waverider Deployment to Provide Real-Time Data to Forecasters and for Comparisons With NDBO NOMAD Buoy Measurements.

User: NWS—Cleveland, Ohio, NDBO

Climatological Mean Lake Surface Temperature Computer Program.

User: NWS—Ann Arbor

Overlake From Overland Wind Forecast Program.

User: NWS—Ann Arbor

Optimum Location of Wood Pulp Processing Plants Considering Lake Circulation Patterns.

User: State of Michigan

Microtechniques for Phosphorus Chemistry and Availability.

User: Great Lakes Fishery Laboratory, U.S. Fish and Wildlife Service

Settling Chambers for Autoradiographic Techniques.

User: University of Michigan

Kinetic Technique to Measure Ammonium Excretion by Pelagic Zooplankton.

User: Skidaway Institute of Oceanography

High-Performance Liquid Chromatography Technique to Fractionate Dissolved Constituents in Natural Waters.

User: University of Missouri

Uncertainty Analysis for Water Quality Monitoring.

User: University of Southern California

In Situ Chamber for Measuring Zooplankton Predation.

User: University of Michigan

Chloride Budget for the Great Lakes.

User: U.S. EPA

Great Lakes Environmental Quality Index.

User: State of Michigan

Diffusion Parameterization for Reservoir Problems in the United Kingdom.

User: University of Salford

Techniques for Investigating Toxicokinetics of Xenobiotics in Aquatic Invertebrates.

User: University of Michigan

Sediment Trap Designs.

User: U.S. Department of the Interior, University of Wisconsin, University of Michigan

Gamma Scan System for Sediment Reworking by Benthic Organisms.

User: University of Michigan

Large Basin Runoff Model.

User: IJC, U.S. Army Corps of Engineers

Unsteady Overland Sedimentation Model.

User: U.S. Geological Survey, U.S. Department of Agriculture

St. Marys River Ice Forecast Method.

User: U.S. Army Corps of Engineers

Draft Environmental Impact Statements are reviewed and critiqued in support of NOAA's Office of Ecology and Environmental Conservation. The Draft Environmental Impact Statements are required by law to be submitted by the company or agency planning the activity for review by all interested or affected entities. They are intended to ensure that proposed activities in and around the lakes have been designed to have little or no long term adverse effects on the environment.

This past year, eight draft environmental impact statements were reviewed by GLERL.

Other responsibilities carried out under this activity include identification of and communication with potential users, determination of user interests and needs, and liaison between the laboratory and users. Committee and board memberships and attendance at workshops, conferences, and other scientific gatherings are some means of informing people about GLERL; certain special publications, such as the technical plan and this annual report, are others. Advice was provided in such widely diverse areas as the NOAA Sewage Sludge Dumping Policy for the New York Bight, the proposed IJC Great Lakes Science Advisory Board's Task Force on Modeling, numerous information requests directed to the U.S. Army Corps of Engineers and subsequently referred to GLERL, and northern Lake Michigan water temperature data (to assist in selecting a training site for the oldest person to successfully swim the English Channel), to name a few.

International treaties and agreements between the United States and Canada, such as the Water Quality Agreement of 1978 and the Boundary Waters Treaty of 1909, are considered and agreed to at the federal level. Legislation pertaining to navigation, water quality, and water levels has been enacted by the Congress. GLERL

has advised both the legislative and executive branches on these and other matters.

Publications Unit

Publications are a major GLERL product and a critical part of our efforts to make research findings available to a broad spectrum of users for application to environmental problems and decisions.

The publications unit has responsibility for the preparation of manuscripts, including editing, typing, proofreading, and procurement of graphics. Manuscripts are edited, typed, and proofread in-house, while graphics and photographic services are procured under contract. Manuscripts are formatted according to the requirements of the publication form: articles and notes in professional journals, NOAA technical reports and memoranda and data reports, or in-house reports. During the last fiscal year, 52 manuscripts were processed in the GLERL publications unit.

Every 6 months, a listing of GLERL publications is sent to a mailing of individuals who have requested that list, and requests are filled until supplies are exhausted. Copies of publications are also available through the National Technical Information Service.

INTERNATIONAL AND INTERAGENCY ACTIVITIES

The GLERL program includes support activities for, and participation in, the work of many agencies in both the United States and Canada. This is one of the mechanisms whereby our research product is used; in addition, we obtain information on requirements for environmental information to support planning and management activities. This user need information is helpful in shaping future GLERL research programs.

International Joint Commission

GLERL staff members actively participate in a wide variety of the activities of the IJC. This past year, a GLERL staff member was appointed to the Water Quality Board's Nonpoint Source Control Task Force. This task force is charged with developing an overview of the progress made in implementing land runoff controls in the Great Lakes Basin, as well as with assessing the scientific problems involved in nonpoint source management. Also included is participation in the International Great Lakes Diversions and Consumptive Uses Working Committee. This committee provided a 60-year projection of consumptive water use in the Great Lakes Basin to be used in evaluating its potential impact on lake levels. A final report including recommendations has been submitted to the IJC for further action. In related areas, GLERL holds membership on the Levels and Flows Advisory Board and the Technical Information Network Board.

Great Lakes Commission

A GLERL staff member serves on two subcommittees of the Great Lakes Commission's Natural Resources Management Committee—the Subcommittee on Land and Air and the Subcommittee on Water. The Natural Resources Management Committee is responsible for initial commission consideration of all natural resource issues and legislation. The two subcommittees cover broad spectrums of related resource management and environmental protection/pollution control programs administrated at both State and Federal Government levels.

International Association for Great Lakes Research

Members of GLERL actively participate in activities of the International Association for Great Lakes Research. A senior GLERL scientist serves as Editor of the *Journal*

of Great Lakes Research, published by that organization. Another serves as an Associate Editor. GLERL scientists also hold positions on the Board of Directors and the Awards Committee.

Regional Response Team for Spills of Oil and Hazardous Substances

GLERL continues to play a role in spill response in the Great Lakes by providing the Department of Commerce representative to the Regional Response Team (RRT) and the regional Scientific Support Coordinator (SSC). The RRT is a standing committee that evaluates and revises the regional contingency plan for response to spills of oil and hazardous materials. The RRT may be called upon to provide specialized resources in response to a spill. A full-time SSC was assigned to work at GLERL in FY 1982. The SSC establishes and maintains contacts with the regional scientific community, identifies vulnerable resources in conjunction with State and Federal agencies, and assists in the preparation of regional and local contingency plans. When a spill has occurred, the SSC provides liaison between the on-scene coordinator and the scientific community. GLERL scientists have provided assistance to the U.S. Coast Guard and the U.S. EPA in regional spills and have participated in drills conducted by the U.S. Coast Guard and NOAA's OMPA.

Joint United States–Canadian Ice Information Working Group

A GLERL staff member is the U.S. Cochairman of this group, the primary mission of which is to coordinate the gathering and dissemination of ice information and data for the Great Lakes.

International Coordinating Committee on Hydraulic and Hydrologic Data

Because much of the Great Lakes data base is used internationally, Canadian and United States users of hydraulic and hydrologic data formed a coordinating committee in 1953. The objectives of this committee are to reach agreement upon hydraulic, hydrologic, and related physical data concerning the Great Lakes; to assist agencies in pursuing studies requiring international data; to provide basic data to anyone with a recognized need; to reach agreement on methods and procedures for measuring, collecting, and storing pertinent data; and to publish coordinated data. GLERL participates on the River Flow Subcommittee with a charge to coordinate data on tributary stream inflow to the Great Lakes system, to coordinate studies of flow in the

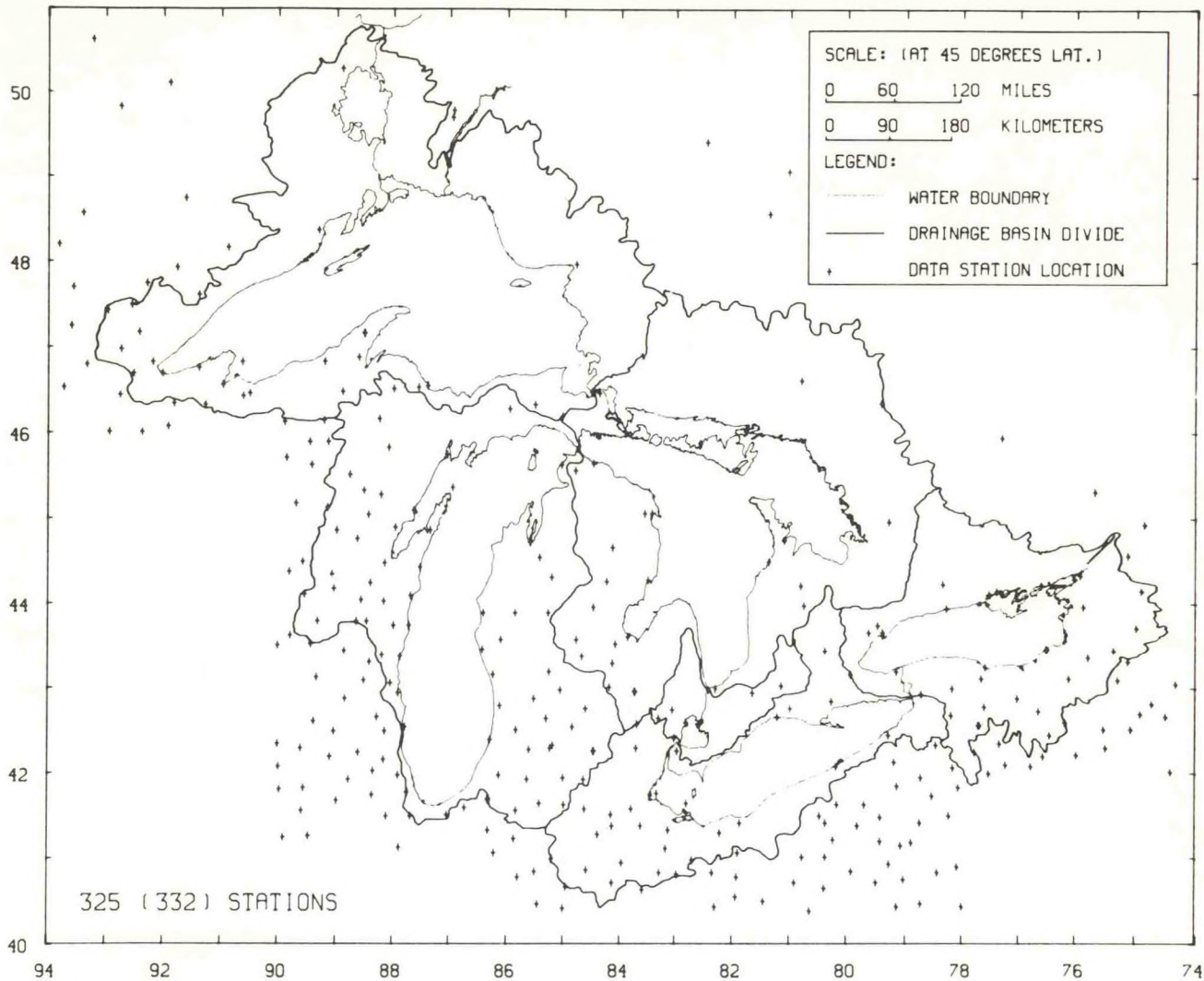

United States and Canadian precipitation stations. A GLERL scientist on the International Great Lakes Technical Information Network Board of the International Joint Commission (IJC) is preparing a directory of the hydrometeorological data network. In addition to aiding the IJC in determining future data needs, the directory will be a research tool for scientists.

connecting channels and the St. Lawrence River, and to establish procedures for updating and disseminating river flow data.

Winter Navigation Program

In the past, GLERL has worked in support of the U.S. Army Corps of Engineers in a multiagency program to examine the feasibility of extending the navigation season in the Great Lakes. Because a large portion of the demonstration program has been completed, much of GLERL's involvement has ended; however, GLERL staff continue to participate in an ad hoc capacity to advise the Corps on environmental studies that should be con-

ducted prior to possible operational implementation of winter navigation extension.

Interagency Great Lakes Hydromet Steering Committee

The Interagency Great Lakes Hydromet Steering Committee was established to coordinate the efforts of the participating U.S. Government agencies in planning and implementing a Great Lakes Hydrometeorological Forecast System. Participating agencies are NOAA, the U.S. Geological Survey, and the U.S. Army Corps of Engineers.

International Field Year for the Great Lakes (IFYGL)

The book *IFYGL—The International Field Year for the Great Lakes* has been printed. The publication summarizes and synthesizes the major scientific achievements

resulting from analytical and numerical simulations of the dynamical events recorded in the IFYGL data bases and published separately in 454 United States and Canadian articles and reports. Thirteen chapters (plus appendices), dealing with subjects covering the meteorology, hydrology, limnology, and biology-chemistry of Lake Ontario, are included.

FACILITIES

GLERL's laboratory and support facilities are an integral part of its research program. These are housed in four leased buildings in Ann Arbor, including offices and support facilities, and in a warehouse and dock facility at Monroe, Michigan.

Marine Instrumentation Laboratory

The marine instrumentation laboratory staff selects, calibrates, repairs, and, when necessary, adapts or designs instruments to collect data in the lakes and their environs. Engineers and technicians in this unit work closely with GLERL researchers to ensure that instruments are compatible with the purpose of the experiment.

As in the past, current meter mooring maintenance and deployment constituted a significant portion of the workload of the marine instrumentation laboratory during FY 1982. This past summer, 15 moorings using acoustical releases, 35 vector-averaging current meters, and 15 subsurface floats were deployed in the middle and southern basins of Lake Michigan. Sediment traps were also attached to the moorings and will remain in place for 1 year.

To monitor island effects of wave generation in the western basin of Lake Erie, marine instrumentation laboratory staff deployed two Waverider buoys, one 10 miles east and one 10 miles west of the Bass Islands. Marine instrumentation laboratory engineers have been working with the GLERL computer facility staff to provide an automatic dial-up system for real-time wave data transmission from these buoys.

The fabrication of a flow tank has made it possible to evaluate the accuracy and reliability of various current meters and sensors. Working closely with the manufacturer, marine instrumentation laboratory staff refined the Marsh McBirney, Inc., ARC 585 electromagnetic current meter. These meters will be used in a flow monitoring project in the St. Clair and Detroit Rivers using the automatic dial-up data acquisition system. A Neil Brown Instrument Systems, Inc., acoustical current meter has been ordered, with testing and evaluation scheduled for winter and spring 1983.

Development of a data concentrator designed for use in multisensor slow process environments, such as those encountered in chemical analysis, is on schedule. It uses the marine instrumentation laboratory Z80 microcomputer system with multichannel analog to digital converter, digital to analog converter, and file management.

Chemistry Laboratories

There are two major types of compounds analyzed by GLERL's chemistry laboratories: trace synthetic organic materials and nutrients. The synthetic organics, primarily PAH's, are extracted from various ecological matrices by Soxhlet extraction and cleaned on Sephadex and silica. Separation and analysis are performed on a glass capillary Hewlett-Packard gas chromatograph and on our recently acquired Waters liquid chromatograph equipped with ultraviolet and fluorescent detectors. Yields are calculated by recovery of carbon-14-labeled spikes introduced into the original sample matrix.

The uptake and release rates of selected PAH's by benthic organisms is being followed through carbon-14-labeled-compound metabolism. Compounds are extracted, cleaned on thin layer or high performance liquid chromatography, and counted by liquid scintillation.

The nutrient program has concentrated on the measurement of recycling rates and on the characterization of forms of phosphorus in lake waters. Microtechniques for filtration and analysis were developed to examine nutrients in waters of small-scale laboratory biological nutrient regeneration experiments. Speciation of phosphorus forms is needed to understand and predict chemical and biological cycling mechanisms in the lakes. We have developed new ways to fractionate and characterize organic and inorganic dissolved phosphorus forms in lake and river water. Liquid chromatographic methods have been designed to separate dissolved compounds directly into chemically distinct groups. This fractionation scheme is being interfaced with specific detection systems for phosphorus (organic and inorganic), ultraviolet-absorbing organic material, and major metals to examine the incorporation or association of phosphorus with other dissolved components in the water.

Biology Laboratories

The biology laboratories' equipment and instrumentation include a multichannel Coulter Counter used to measure particle size selection and zooplankton grazing on natural lake algae and seston. An array of instruments, including a liquid scintillation spectrometer, is used to investigate nutrient uptake, growth rates, competition for nutrients by algae, and cycling rates of selected algal nutrients. Facilities also include a full complement of sampling gear and instrumentation, growth chambers, stereo and inverted microscopes, and cultured populations of phytoplankton and zooplankton species for model studies. A mobile trailer has

been fitted for lakeside investigations of the physiology and feeding rates of planktonic and benthic organisms.

This past year, nutrient release patterns of various groups of animals have been measured as a joint effort with chemistry laboratory staff. This involves putting individual pelagic and benthic invertebrates into known quantities of lake water and measuring the phosphorus and nitrogen release patterns. Continuous nutrient release rates by individual zooplankton are measured with a flow-through incubation cell in conjunction with high performance liquid chromatographic plumbing and a modified Technicon AutoAnalyzer.

The biology laboratories continue to support the survey of benthic invertebrates in southern Lake Michigan.

Ice Laboratory

The ice laboratory makes it possible to extend the winter measurement season and to expand opportunities for measurements of ice characteristics. The facility

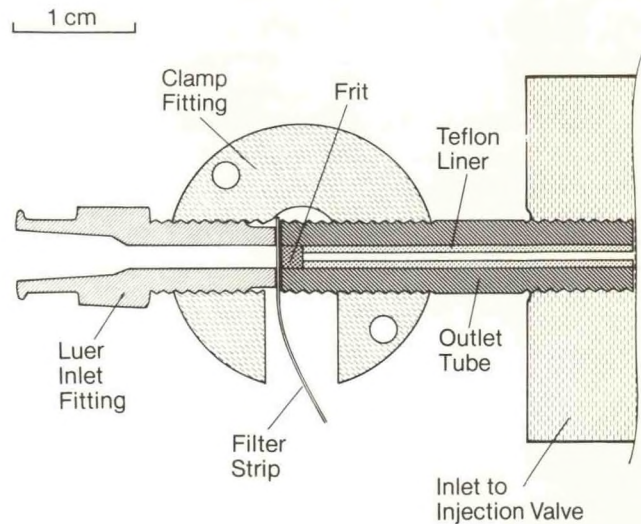

Schematic diagram of microfiltering device designed to remove particles from small (less than 1 milliliter) water samples during injection into nutrient analyzers.

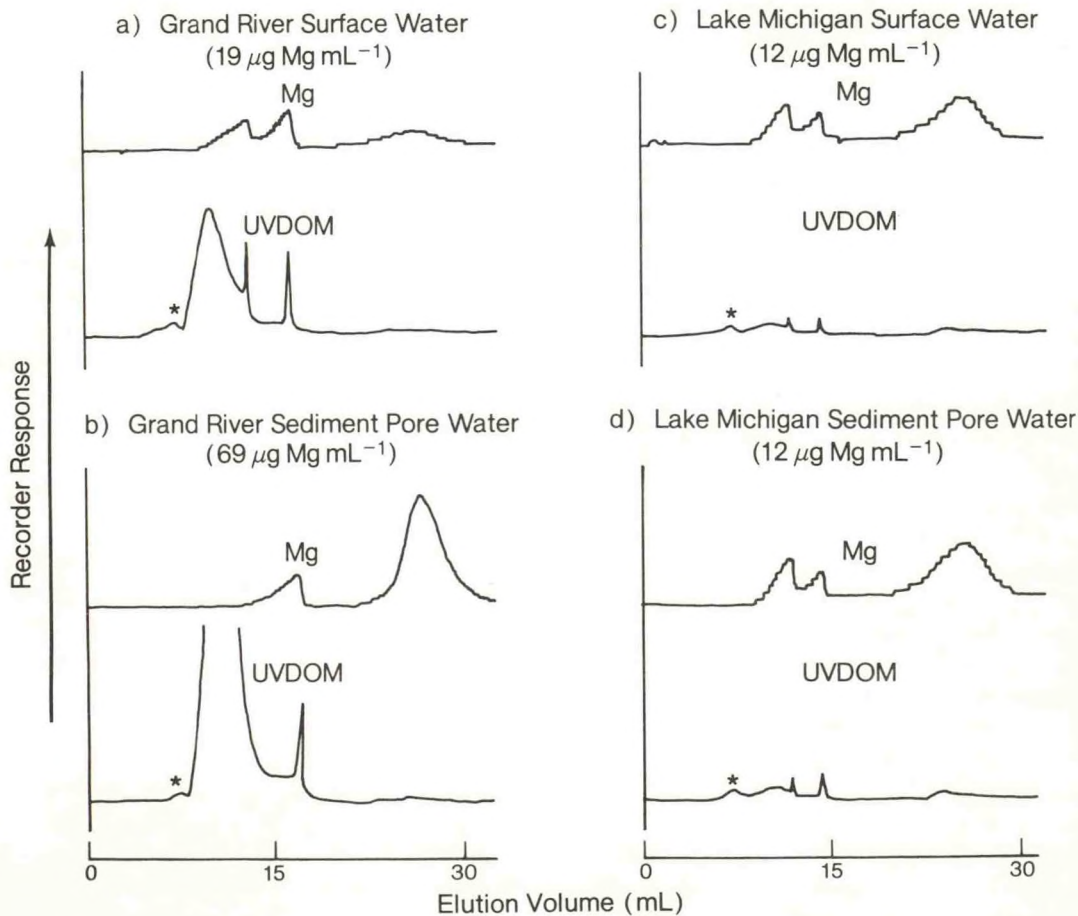

Direct injection liquid chromatograms for magnesium and ultraviolet absorbing organic matter for filtrates (0.5 milliliters) of Grand River and Lake Michigan surface and sediment pore water sampled in May 1981.

is composed of a work room and an ice storage room. The work room, held at -7.0°C , can be used to conduct experiments on natural ice harvested in previous field seasons, as well as to calibrate instrumentation for the ice research program in an environment similar to that encountered in the field. For example, scientists are investigating new optical diffusers for the dual spectroradiometers used in measuring ice reflectance. These new diffusers will allow the instrument to be used under clear sky conditions without mathematical correction factors. The cold room is also being used to test the sensitivity of a variety of instruments, such as spectroradiometers and current meters, under low temperature conditions. The interior walls are painted flat black to facilitate optical experiments. Ancillary equipment includes a high intensity light source, a mercury line source, and an optical bench.

Adjacent to the work room is a smaller room held at -29.0°C . In addition to providing low temperature storage for ice samples and a limited number of field samples from the chemistry and biology programs, the facility serves as an additional calibration room.

Particle Dynamics Laboratory

Natural and artificially produced radionuclides introduced into the Great Lakes serve as excellent model contaminant and process indicators. The particle dynamics laboratory can be used to detect and measure very low levels of many such radioactive substances present in water, sediment, and biota. The laboratory was established recently as part of the cooperative program with the University of Michigan, Great Lakes and Marine Waters Center.

Facilities include several gas flow proportional counters with automatic sample changers for total alpha and beta counting. These systems are used both for low-level counting of environmental samples and for laboratory radiotracer studies. The laboratory has one absolute geometry alpha spectroscopy system and has recently added two additional alpha spectroscopy modules. This addition is a significant improvement in capability for extremely low-level (about 10 femtocuries), high resolution measurement of alpha emitting radionuclides, such as the plutonium and thorium isotopes and polonium-210. Currently under development is a radon gas counting system in which the radioactive gas is transferred to a zinc sulfide lined chamber, where scintillations produced by its decay are detected by a photomultiplier. This system, once operational, will provide a basis for radiometric studies of vertical diffusivity within the benthic boundary layer. There is now an extensive capability for gamma analysis. A well-shielded 3-by-5-inch sodium iodide detector is

used for routine measurement of fallout cesium-137 in sediment and in trap samples. Several 2-by-2-inch sodium iodide detectors are presently used in gamma scan systems. In these systems the detectors are housed in extremely well-collimated lead shields (shields that direct light waves) mounted on hydraulically operated platforms. The gamma scan systems are used to determine the vertical distribution of gamma emitting tracers added to laboratory microcosms containing sediments, water, and zoobenthos. In addition, the laboratory includes a major gamma detection system—a high volume, high resolution, well-shielded lithium-drifted germanium detector coupled to a state-of-the-art multichannel analyzer. The system is interwired with the University of Michigan computer facility, allowing for on-line data processing. The system is designed for simultaneous determination of many radioisotopes, including beryllium-7, potassium-40, cesium-137, and other fallout radionuclides. The system may also be used for quantitative determination of stable element concentrations via neutron activation analysis.

Computer Facility

The computer systems group supports the work of GLERL scientists by designing, coding, debugging, and testing systems and applications programs. They also counsel and train scientist-technician programmers to increase the effectiveness and efficiency of their use of computing resources.

General scientific computing is done on ERL's CDC Cyber 170/750 located in Boulder. This computer is accessed by means of a remote-job-entry station and about 25 interactive terminals located throughout the laboratory. A statistical multiplexer is used to control data traffic on a 9,600-baud telephone link to Boulder; it supports the remote-job-entry station, two 1,200-baud and five 2,400-baud hard-wired terminals, and nine 300-baud dial-up lines. Four of the interactive terminals have screen graphics capabilities; one of these also has a hard-copy graphics capability.

Computer systems also supports and operates a Hewlett-Packard 9603A minicomputer as a data acquisition system. This system is used to process tapes from field instruments, to collect data transmitted by field instruments over radio-telephone links, and to collect National Aeronautics and Space Administration satellite data and data from NWS's Great Lakes Marine Circuit.

Research Vessel *Shenehon*

The primary platform used in support of open lake field investigations is the *Shenehon*. The vessel is a converted T-boat 65.6 feet long, with a 6.5-foot mean draft, a 600-nautical-mile cruising range, and a

10-knot cruising speed. A hydraulic articulated crane with a 1,630-pound lifting capacity at 21-foot extension is used for deployment and retrieval of heavy instrument moorings. Winches handle hydrographic wire and multiconductor cable for sample casts and *in situ* measurements of water variables. An on-board laboratory facilitates onsite physical, chemical, and biological experiments. A LORAN C navigation system provides the capability and precision for the ship to return to an exact site in the lakes for equipment retrieval.

During FY 1982 the *Shenehon* was based at the U.S. Army Corps of Engineers' boat yard at Grand Haven, Michigan. The Corps also provided warehouse facilities and space for a mobile shore based laboratory at that location. The range of ship operations in FY 1982 included Lakes Michigan, Huron, and Erie.

Biological work supported by the *Shenehon* during the past year included benthic, planktonic, and bacterial experiments studying nutrient cycling in the aquatic environment and the long term effects of toxic material inputs. As part of a toxics materials study, specimens of the organism *P. hoyi* were collected in Lakes Huron and Michigan to measure uptake of PAH's.

In a nutrient cycling study, benthic invertebrates were collected from the Grand River and adjacent Lake Michigan to determine whether they release significant quantities of phosphorus by metabolic and digestive processes and to examine mechanisms of nutrient release. In another nutrient investigation, dissolved phosphorus was collected from the Grand River and adjacent lake and fractionated into its various forms as a prerequisite to determining its bioavailability. Water and zooplankton samples were also collected in Lake Michigan for a laboratory study of selection and volume of food ingested by the copepod *Diaptomus*.

In ongoing cooperative programs with the University of Michigan, the *Shenehon* was used to sample an area offshore of Grand Haven during different seasons to support a study of bacterial distribution and microbial transformations of nutrients. The vessel was also used in a University of Michigan cooperative program to collect suspended sediment and zooplankton at a station about 20 kilometers offshore of Grand Haven to identify and quantify release of toxic materials by zooplankton and to determine sorption rates of toxic organic materials onto the suspended particles. In another cooperative program, equipment was regularly deployed and retrieved off the eastern shore of Lake Michigan and samples and measurements taken in an investigation of the physical factors affecting phytoplankton populations in a stratified lake and the correlation between areal distribution and nutrient gradients.

In support of the Physical Limnology and Meteorology program, the *Shenehon* crew took measurements at



Scientist lowering temperature sensors into south-central Lake Michigan from the research vessel *Shenehon*. The National Data Buoy Office (NDBO) buoy is just visible in the distance.

the NDBO NOMAD buoy in southern Lake Michigan for verification of output of meteorological and underwater sensors. These buoy data are used in GLERL investigations and are routinely used in NWS forecasts. The vessel also supported the NDBO in servicing the buoy sensors. As part of another cooperative program with NDBO, the vessel was used to deploy and retrieve free-drifting drogues that tracked water current trajectories in Lake Michigan.

At the end of the 1981 season, the *Shenehon* was engaged in retrieving an instrumented tower, Waveriders, and current meter moorings at a site in Lake Erie northeast of Ashtabula, Ohio. This experiment, in conjunction with a University of Michigan contractor, provided data input to analyses of wave directional characteristics under varying wind conditions, wave dissipation due to bottom friction, and the longshore momentum in the coastal area.

In the data collection phase of an investigation of the rotational mode currents induced in Lake Michigan by suddenly imposed wind stresses, the boat was used to deploy 16 current meter moorings throughout the lake, with the bulk of these along the juncture of the northern and southern basins. These current meters will remain in Lake Michigan through winter 1982-83. Sediment traps were also deployed on the current meter moorings to take advantage of the water current data to provide greater insight into the mass movement of settling and resuspended particles in Lake Michigan.

Library and Information Services

GLERL library staff supplies necessary library and information services support for laboratory activities by maintaining a tailored research collection and offering special retrieval services when the collection cannot meet the documentation or information needs of the researchers. The current GLERL library collection consists of research materials in the areas of climatology, hydrology, hydraulics, ice, limnology, mathematical modeling, meteorology, oceanography, sedimentation, and wave motion with emphasis on the Great Lakes Basin. Toxic organics and nutrients are now being included as major subject areas. Holdings include 2,574 books, 2,758 unbound periodical volumes, and 2,494 reports (excluding an estimated 200 books, 2,300 reports, and 1,220 unbound periodical volumes kept in a remote storage location). Space limitations have necessitated both local and distant area storage facilities. A large

number of materials obtained at the closing of the Lake Survey Center library continue to be recataloged and incorporated into the GLERL Library collection as time and shelf space permit.

Library staff perform reference, interlibrary loan, photocopying, acquisition, circulation, and bibliographic services, including on-line information retrieval, for laboratory affiliated personnel. In addition, the library staff expedite on-demand document retrieval and increase reference capability on behalf of GLERL scientists through on-site access arrangements with the University of Michigan library system. Limited services to others are provided upon special request.

During FY 1982 library staff performed 118 on-line literature searches, retrieved 544 interlibrary loans, and added 306 books and 226 reports to the collection. They also updated holdings in JOURNALINK, a national union list of serials, and actively participated in the formation of the Washtenaw-Livingston Library Network.

FY 1983 GLERL library plans call for: (1) participating in the newly formed Washtenaw-Livingston Library Network Union List of Serials and (2) expanding on-line bibliographic literature searching capabilities through the addition of the new ISI Search Network to the list of library accessible on-line search systems. The union list will not only enhance resource sharing in the local area, but will also link into the national capabilities of the OCLC Union Listing Component, thus providing on-line access to serial holdings of network participants.

PUBLICATIONS

A 6-month listing of our available publications can be obtained from:

Information Services
Great Lakes Environmental Research
Laboratory
2300 Washtenaw Avenue
Ann Arbor, Michigan 48104

- Bennett, J. R., and Schwab, D. J. 1981. Calculation of the rotational normal modes of oceans and lakes with general orthogonal coordinates. *J. Comput. Phys.* 44:359-376.
- Bolsenga, S. J. 1982. *Mathematical models of slope development—A review.* GLERL Open File Report.
- Bolsenga, S. J., and Kistler, R. D. 1982. A dual spectroradiometer system for measuring spectral reflectances. *J. Appl. Meteorol.* 21:642-647.
- Chapra, S. C.* 1982. A budget model accounting for the positional availability of phosphorus in lakes. *Water Res.* 16:205-209.
- Chapra, S. C.* 1982. Long term models of interactions between solids and contaminants in lakes. Ph.D. dissertation, the University of Michigan, Ann Arbor. University Microfilms.
- Croley, T. E., II. 1982. *Great Lakes Basins runoff modeling.* NOAA Technical Memorandum ERL GLERL-39.
- Croley, T. E., II. 1982. Unsteady overland sedimentation. *J. Hydrol.* 56:325-346.
- Croley, T. E., II, Carvey, D. G.†, and Robb, J. G.† 1982. Watershed evaluation and research system application. In *Applied modeling in catchment hydrology*, ed. V.P. Singh, pp. 229-258. Littleton, Colorado: Water Resources Publications.
- Dannelongue, H. H.†, Meadows, G. A.†, and Pickett, R. L. 1981. The growth and decay of nearshore circulation. In *Proceedings of mechanics of oil slicks conference*, pp. 107-120. Paris, France: International Association for Hydraulic Research.
- Derecki, J. A. 1981. Operational estimates of Lake Superior evaporation based on IFYGL findings. *Water Resour. Res.* 17:1453-1462.
- Derecki, J. A. 1981. Stability effects on Great Lakes evaporation. *J. Great Lakes Res.* 7:357-362.
- Derecki, J. A. 1982. *Effect of channel changes in the St. Clair River since 1900.* NOAA Technical Memorandum ERL GLERL-40.
- Derecki, J. A. 1982. *Effect of the 1981 Fort Gratiot gage modifications on the hydraulic regime of the St. Clair River.* GLERL Open File Report.
- Eadie, B. J., McCormick, M. J., Rice, C.†, Levon, P.*, and Simmons, M.† 1981. *An equilibrium model for the partitioning of synthetic organic compounds incorporating first-order decomposition.* NOAA Technical Memorandum ERL GLERL-37.
- Eadie, B. J., Faust, W., and Landrum, P. F. 1982. Polycyclic aromatic hydrocarbons in the benthic organisms of the Great Lakes. *Coast. Ocean Pollut. Assess. News* 2:4.
- Eadie, B. J., Faust, W., Gardner, W. S., and Nalepa, T. F. 1982. Polycyclic aromatic hydrocarbons in sediments and associated benthos in Lake Erie. *Chemosphere* 11:185-191.
- Eadie, B. J., Nihart, S., and Robbins, J. A. 1982. Study of early diagenesis of compounds in Great Lakes sediments is underway. *Coast. Oceanogr. Climatol. News* 4:43.
- Gardner, W. S., Landrum, P. F., and Yates, D. A.† 1982. Fractionation of metal forms in natural waters by size exclusion chromatography with inductively coupled argon plasma detection. *Anal. Chem.* 54:1196-1198.
- Gardner, W. S., and Paffenhöfer, G. A.† 1982. Nitrogen regeneration by the subtropical marine copepod *Eucalanus pileatus*. *J. Plankton Res.* 4:725-734.
- Great Lakes Environmental Research Laboratory. 1981. *Annual report for the Great Lakes Environmental Research Laboratory.* Ann Arbor: Great Lakes Environmental Research Laboratory.
- Great Lakes Environmental Research Laboratory. 1982. *Technical plan for the Great Lakes Environmental Research Laboratory.* Ann Arbor: Great Lakes Environmental Research Laboratory.
- Great Lakes Environmental Research Laboratory and the University of Michigan. 1981. *Second annual progress report to the Office of Marine Pollution Assessment: The cycling of toxic organic substances in the Great Lakes ecosystem.* Ann Arbor: Great Lakes Environmental Research Laboratory.
- Greene, G. M. 1981. Breakup of ice cover occurs early on St. Lawrence River in 1981. *Coastal Oceanogr. Climatol. News* 4:2-3.
- Hore, R. C.†, Pinsak, A. P., and Vallery, D. J.† 1981. Annex F—Consumptive water use. In *Report to the International Joint Commission by the International Great Lakes Diversions and Consumptive Uses Study Board.* Detroit, Michigan: U.S. Department of the Army, Corps of Engineers.
- Huang, J. C. K.*, and Sloss, P. W.* 1981. Simulation and verification of Lake Ontario's mean state. *J. Phys. Oceanogr.* 11:1548-1566.
- Huang, J. C. K.*, and Saylor, J. H. 1982. Vorticity waves in a shallow basin. *Dyn. Atmos. Oceans* 6:177-196.
- Hutter, K.†, and Schwab, D. J. 1982. *Internal report on baroclinic channel models.* Report prepared by Versuchsanstalt für Wasserbau, Hydrologie und Glaziologie.
- Kelley, R. N. 1982. *Comparison of Great Lakes consumptive use impacts on water levels under Lake Superior regulation plans "1977" and "55 modification of the 1949 rule."* GLERL Open File Report.
- Krezoski, J. R.†, and Robbins, J. A. 1981. Radiotracer studies of interactions between sediments and freshwater macrobenthos. *Verh. Internat. Verein. Limnol.* 21:382.
- Lehman, J. T.†, and Scavia, D. 1982. Microscale nutrient patches produced by zooplankton. *Proc. Natl. Acad. Sci.* 79:5001-5005.
- Lehman, J. T.†, and Scavia, D. 1982. Microscale patchiness of nutrients in plankton communities. *Science* 216:729-730.
- Leversee, G. J.†, Giesy, J. P.†, Landrum, P. F., Bartell, S.†, Gerould, S.†, Bruno, M.†, Spacie, A.†, Bonling, J.†, Haddock, J.†, and Fannin, T.† 1981. Disposition of benzo(a)pyrene in aquatic system components: Periphyton, chironomids, daphnia, fish. In *Chemical analysis and biological fate: Polynuclear aromatic hydrocarbons*, ed. M. Cooke and A.J. Dennis, pp. 357-366. Columbus, Ohio: Battelle Press.
- Miller, G. S., and Saylor, J. H. 1981. Winter temperature structure in Lake Huron. *J. Great Lakes Res.* 7:201-206.
- Quigley, M. A. 1982. Freshwater macroinvertebrates. *J. Water Pollut. Control. Fed.* 54:868-877.
- Quinn, F. H. 1981. Secular changes in annual and seasonal Great Lakes precipitation, 1854-1979, and their implications for Great Lakes water resource studies. *Water Resour. Res.* 17:1619-1624.
- Quinn, F. H., and Croley, T. E., II. 1981. The role of precipitation climatology in hydrologic design and planning on the Laurentian Great Lakes. In *Proceedings, fourth conference on hydrometeorology*, pp. 7-11. Boston, Massachusetts: American Meteorological Society.
- Quinn, F. H., Assel, R. A., and Gaskill, D. W.* 1982. An evaluation of the impact of the Niagara River ice boom on the air temperature regime at Buffalo, New York. *J. Appl. Meteorol.* 21:342-349.
- Robbins, J. A. 1982. *Sediments of Saginaw Bay, Lake Huron: Elemental composition and accumulation rates.* Final report to the U.S. Environmental Protection Agency, Large Lakes Research Station, Grosse Ile, Michigan.

* No longer affiliated with this laboratory.

† Not affiliated with this laboratory.

† Not affiliated with this laboratory.

* No longer affiliated with this laboratory.

- Robbins, J. A. 1982. Stratigraphic and dynamic effects of sediment reworking by Great Lakes zoobenthos. *Hydrobiologia* 92:611-622.
- Scavia, D. 1982. Use and interpretation of detailed, mechanistic models of phytoplankton dynamics. In *Phytoplankton-environmental interactions in reservoirs*, Technical Report E-81-13, vol. 1, ed. M. W. Lorenzen, pp. 196-222. Vicksburg, Mississippi: U.S. Army Corps of Engineers, Waterways Experimental Station.
- Scavia, D., and McFarland, M. J.† 1982. Phosphorus release patterns and the effects of reproductive stage and ecdysis in *Daphnia magna*. *Can. J. Fish. Aquat. Sci.* 39:1310-1314.
- Schwab, D. J. 1982. An inverse method for determining wind stress from water-level fluctuations. *Dyn. Atmos. Oceans* 6:251-278.
- Schwab, D. J., Liu, P. C., Bennett, J. R., and Meadows, G. A.† 1981. Lake Erie coastal boundary layer study measures flux of energy during storms. *Coastal Oceanogr. Climatol. News* 4:10.
- Schwab, D. J., Bennett, J. R., and Jessup, A. T.† 1981. A two-dimensional lake circulation modeling system. NOAA Technical Memorandum ERL GLERL-38.
- Schwab, D. J., Liu, P. C., Bennett, J. R., Meadows, G. A.†, Schultz, H. J.†, Campbell, J. E., and Dannelongue, H. H.† 1982. Coastal boundary layer study records response of Lake Erie to storms. *Coastal Oceanogr. Climatol. News* 4:30-31.
- Sonzogni, W. C. 1982. Great Lakes: A look to the future. In *Oceans 82—Conference proceedings of the Marine Technology Society and the Institute of Electrical and Electronics Engineers*, pp. 1186-1189. Marine Technology Society and the Institute of Electrical and Electronics Engineers, Washington, D.C.
- Tarapchak, S. J., and Rubitschun, C.* 1981. Comparisons of soluble reactive phosphorus and orthophosphorus concentrations at an offshore station in southern lake Michigan. *J. Great Lakes Res.* 7:290-298.
- Tarapchak, S. J., Bigelow, S. M.*, and Rubitschun, C.* 1982. Overestimation of orthophosphorus concentrations in surface waters of southern Lake Michigan: Effects of acid and ammonium molybdate. *Can. J. Fish. Aquat. Sci.* 39:296-304.
- Vanderploeg, H. A., and Ondricek-Fallscheer, R. L.* 1982. Intersetule distances are a poor predictor of particle-retention efficiency in *Diaptomus sicilis*. *J. Plankton Res.* 4:237-244.
- Vanderploeg, H. A., Bowers, J. A.†, Chapelski, O.†, and Soo, H. K. 1982. Measuring *in situ* predation by *Mysis relicta* and observations on underdispersed microdistributions of zooplankton. *Hydrobiologia* 93:109-119.

† Not affiliated with this laboratory.

* No longer affiliated with this laboratory.

† Not affiliated with this laboratory.

PRESENTATIONS

- Assel, R. A. 1982. A digital Great Lakes ice-cover climatology and data base. Second Symposium on Applied Glaciology, August 23-27, 1982, Hanover, New Hampshire.
- Bell, G. L., and Eadie, B. J. 1982. Variations in the distribution of suspended particulates and sedimentation rates in southern Lake Michigan. 25th Conference on Great Lakes Research, May 4-6, 1982, Sault Ste. Marie, Ontario.
- Croley, T. E., II. 1982. GLERL large basin runoff model. National Weather Service/National Environmental Satellite Service/Environmental Research Laboratories Technical Exchange Conference, May 10-15, 1982, Estes Park, Colorado.
- Croley, T. E., II. 1982. GLERL large basin runoff model. Joint United States-Canadian Gamma Radiation Snow Water Equivalent and Soil Moisture Survey Technical Planning Conference, September 16, 1982, Detroit, Michigan.
- Croley, T. E., II. 1982. Great Lakes Basins runoff modeling. 25th Conference on Great Lakes Research, May 4-6, 1982, Sault Ste. Marie, Ontario.
- Croley, T. E., II. 1982. A tank-cascade runoff model for large forested basins. Canadian Hydrology Symposium 82, June 13-16, 1982, at the University of New Brunswick, Fredericton, New Brunswick.
- Eadie, B. J. 1981. The role of the benthic boundary layer in the cycling of PCB's in the Great Lakes. Workshop on the Physical Behavior of PCB's in the Great Lakes, December 16-18, 1981, Toronto, Ontario.
- Eadie, B. J., Chambers, R. L.*, Bell, G. L., and Robbins, J. A. 1982. Fluxes and characteristics of particulate matter in Lake Michigan. Fourth Winter Meeting of the American Society of Limnology and Oceanography, February 16-19, 1982, San Antonio, Texas.
- Gardner, W. S., and Landrum, P. F. 1981. Characterization of ambient levels of ultra-violet-absorbing dissolved humic materials in natural waters by aqueous liquid chromatography. Symposium on Terrestrial and Aquatic Humic Materials, November 4-5, 1981, Chapel Hill, North Carolina.
- Gardner, W. S., Yates, D. A.†, and Landrum, P. F. 1981. Fractionation of metal forms in natural waters by distilled water size exclusion chromatography with inductively coupled argon plasma detection. Fourth Midwest Water Chemistry Workshop Program, October 22-23, 1981, at the University of Wisconsin-Milwaukee, Milwaukee, Wisconsin.
- Gardner, W. S., and Paffenhöfer, G. A.† 1982. Nitrogen regeneration by the subtropical marine copepod *Eucalanus pileatus*. 45th Annual Meeting of the American Society of Limnology and Oceanography, June 14-17, 1982, at North Carolina State University, Raleigh, North Carolina.
- Gardner, W. S., and Malczyk, J. M. 1982. Speciation of soluble unreactive phosphorus in Lake Michigan and Grand River waters. 25th Conference on Great Lakes Research, May 4-6, 1982, Sault Ste. Marie, Ontario.
- Glover, R. M.†, and Vanderploeg, H. A. 1982. Microscopic observations on particle selection and fragmentation by *Diatomus sicilis* in offshore Lake Michigan. 45th Annual Meeting of the American Society of Limnology and Oceanography, June 14-17, 1982, at North Carolina State University, Raleigh, North Carolina.
- Greene, G. M. 1982. A comparison of linear and non-linear temperature gradient models of river ice cover. Seminar series, March 11, 1982, at Clarkson College of Technology, Potsdam, New York.
- Heidtke, T. M.†, Chapra, S. C.*, and Wicke, H. D.* 1981. Cost effectiveness of treatment to meet phosphorus objectives in the Great Lakes. 54th Annual Conference of the Water Pollution Control Federation, October 5, 1981, Detroit, Michigan.
- Klahr, P. C.†, White, D. S.†, and Robbins, J. A. 1982. Effects of temperature and density on the rate of sediment reworking by *Stylodrilus heringianus*. 30th Annual Meeting of the North American Benthological Society, May 18-21, 1982, Ann Arbor, Michigan.
- Landrum, P. F. 1982. Toxicokinetics of polycyclic aromatic hydrocarbons in *Pontoporeia hoyi*. 30th Meeting of the North American Benthological Society, May 18-21, 1982, Ann Arbor, Michigan.
- Leshkevich, G. A. 1982. Comparison of visual and machine interpretation of northern Green Bay ice cover using Landsat 1 data—A case study. 25th Conference on Great Lakes Research, May 4-6, 1982, Sault Ste. Marie, Ontario.
- Leshkevich, G. A. 1982. Some uses of remote sensing in Great Lakes ice research. Cold Regions Engineering Conference, March 30, 1982, at the State University of New York, Amherst Campus, Buffalo, New York.
- Liu, P. C. 1982. A representation for the frequency spectrum of wind-generated waves. Joint Oceanic Assembly, August 2-13, 1982, Halifax, Nova Scotia.
- Liu, P. C., Schwab, D. J., Bennett, J. R., Meadows, G. A.†, Dannelongue, H. H.†, Campbell, J. E., and Schulz, H. J.† 1982. Measurement of directional wave spectra and coastal dynamics in Lake Erie. American Geophysical Union Ocean Sciences Meeting, February 16-19, 1982, San Antonio, Texas.
- McCormick, M. J. 1982. The future of Lake Ontario mirex—Vertical dynamics. 25th Conference on Great Lakes Research, May 4-6, 1982, Sault Ste. Marie, Ontario.
- McCormick, M. J., Wharram, B. L., and Scavia, D. 1982. Comparison of phytoplankton growth constructs in the context of vertically segmented plankton-profile models. Third International Conference on State-of-the-Art in Ecological Modeling, May 24-28, 1982, at Colorado State University, Fort Collins, Colorado.
- Nalepa, T. F. 1982. Some quantitative aspects of the meiobenthos in southeastern Lake Michigan. 25th Conference on Great Lakes Research, May 4-6, 1982, Sault Ste. Marie, Michigan.
- Pickett, R. L. 1982. The future of Lake Ontario mirex—Horizontal dynamics. 25th Conference on Great Lakes Research, May 4-6, 1982, Sault Ste. Marie, Ontario.
- Pickett, R. L. 1982. A Great Lakes spill model. American Geophysical Union Ocean Sciences Meeting, February 16-19, 1982, San Antonio, Texas.
- Quigley, M. A. 1982. Kinetics of phosphorus and silica release from nearshore Lake Michigan sediments. 25th Conference on Great Lakes Research, May 4-6, 1982, Sault Ste. Marie, Ontario.
- Quinn, F. H. 1982. Recent changes in the seasonal water level cycle of Lake St. Clair. 25th Conference on Great Lakes Research, May 4-6, 1982, Sault Ste. Marie, Ontario.
- Quinn, F. H. 1982. Trends and extremes of Lake Erie water supplies. International Symposium on Hydrometeorology, June 13-17, 1982, Denver, Colorado.
- Robbins, J. A. 1982. Bioturbation and lake recovery times. 30th Annual Meeting of the North American Benthological Society, May 18-21, 1982, Ann Arbor, Michigan.
- Rumer, R. R.†, Bialas, W. F.†, Quinn, F. H., Assel, R. A., and Gaskill, D. W.* 1981. Environmental impact study of the Lake Erie-Niagara River ice boom. Annual Meeting of the American Society of Civil Engineers, October 26-30, 1981, St. Louis, Missouri.
- Saylor, J. H. 1982. Circulation of southern Lake Michigan. American Geophysical Union Ocean Sciences Meeting, February 16-19, 1982, San Antonio, Texas.
- Scavia, D. 1981. Microscale patchiness of nutrients in plankton communities: Empirical evidence for presence and utilization. Seminar series, November 17, 1981, at the University of Wisconsin-Madison, Madison, Wisconsin.

* No longer affiliated with this laboratory.

† Not affiliated with this laboratory.

† Not affiliated with this laboratory.

* No longer affiliated with this laboratory.

- Scavia, D. 1981. Microscale patchiness of nutrients in plankton communities: Empirical evidence for presence and utilization. Seminar series, November 18, 1981, at the University of Wisconsin-Milwaukee, Milwaukee, Wisconsin.
- Scavia, D. 1981. Uncertainty analysis of a lake eutrophication model. American Geophysical Union Fall Meeting, December 7-11, 1981, San Francisco, California.
- Scavia, D. 1982. Nutrient supply and utilization in plankton micropatches. Ecological Society of America Meeting, August 9-13, 1982, at Pennsylvania State University, University Park, Pennsylvania.
- Scavia, D. 1982. Use and limits of ecosystem models: A Great Lakes perspective. Marine Ecosystems Modeling Workshop, April 6-8, 1982, Frederick, Maryland.
- Scavia, D., and Lehman, J.T.† 1982. Mechanisms of nutrient supply and utilization in plankton micropatches. 45th Annual Meeting of the American Society of Limnology and Oceanography, June 14-17, 1982, at North Carolina State University, Raleigh, North Carolina.
- Schwab, D. J. 1982. Calculation of seiches in closed basins with the Lanczos procedure. Internal Colloquium Series—Research Institute for Hydraulics, Hydrology, and Glaciology, June 24, 1982, Zurich, Switzerland.
- Schwab, D. J. 1982. An inverse method for determining wind stress from water level fluctuations. American Geophysical Union and American Society of Limnology and Oceanography Joint Meeting, February 16-19, 1982, San Antonio, Texas.
- Schwab, D. J. 1982. Storm surge research on Lake Erie. Geophysical Colloquium Series—University of Hamburg, June 10, 1982, at the University of Hamburg, Hamburg, West Germany.
- Schwab, D. J., and Morton, J. A. 1982. Calculation of overlake winds from overland winds: Comparison and methods. 25th Conference on Great Lakes Research, May 4-6, 1982, Sault Ste. Marie, Ontario.
- Sonzogni, W. C. 1981. Partners in research—The Great Lakes Environmental Research Laboratory. Semiannual Meeting of the Michigan Chapter, American Fisheries Society, November 6, 1981, Ann Arbor, Michigan.
- Sonzogni, W. C. 1982. Environmental effects of energy from coal. 73rd Annual Conference of the Special Libraries Association, June 5-10, 1982, Detroit, Michigan.
- Sonzogni, W. C. 1982. Great Lakes: A look to the future. Oceans 82, September 20-22, 1982, Washington, D.C.
- Sonzogni, W. C. 1982. Great Lakes: Love them, don't leave them. Ann Arbor Women's Club Meeting, February 2, 1982, Ann Arbor, Michigan.
- Sonzogni, W. C. 1982. Great Lakes management. Guest lecture, February 15, 1982, at the University of Michigan, Ann Arbor, Michigan.
- Sonzogni, W. C. 1982. A look to the future. Meeting of Great Lakes Conservation Groups, May 21, 1982, Mackinac Island, Michigan.
- Sonzogni, W. C., and Quinn, F. H. 1982. Perspectives on hypothetical water exports from the Great Lakes. 25th Conference on Great Lakes Research, May 4-6, 1982, Sault Ste. Marie, Michigan.
- Tarapchak, S. J. 1982. Causes of method-specific differences in soluble reactive phosphorus determinations. 25th Conference on Great Lakes Research, May 4-6, 1982, Sault Ste. Marie, Ontario.
- Tarapchak, S. J. 1982. Does Rigler's radiobioassay method overestimate phosphate-phosphorus concentrations in lake water? 45th Annual Meeting of the American Society of Limnology and Oceanography, June 14-17, 1982, at North Carolina State University, Raleigh, North Carolina.
- Tarapchak, S. J. 1982. Hypothesis to explain slow orthophosphorus turnover times and high dissolved phosphorus concentrations in Lake Michigan. 25th Conference on Great Lakes Research, May 4-6, 1982, Sault Ste. Marie, Ontario.
- Tarapchak, S. J., and Slavens, D. R.* 1981. Autoradiographic analysis of phytoplankton: Effects of preservation on carbon-14 and phosphorus-33 loss from algae. Third Winter Meeting of the American Society of Limnology and Oceanography, December 27-30, 1981, at the University of Washington, Seattle, Washington.
- Vanderploeg, H. A. 1982. Seasonal feeding rate and selectivity patterns of *Diatomus sicilis* in offshore Lake Michigan. 25th Conference on Great Lakes Research, May 4-6, 1982, Sault Ste. Marie, Ontario.
- White, D. S.†, and Robbins, J. A. 1982. Burrowing activities and displacement of sediment by *Stylodrilus heringianus*. 30th Annual Meeting of the North American Benthological Society, May 18-21, 1982, Ann Arbor, Michigan.

† Not affiliated with this laboratory.

* No longer affiliated with this laboratory.

† Not affiliated with this laboratory.

CONTRACTOR PUBLICATIONS

- Churchill, J. H., and Pade, B. H. 1981. *Acoustically and visually tracked drogue measurements of nearshore water velocities in Lake Huron plus observations of a coastal upwelling*. Woods Hole Oceanographic Institution Report No. WHOI-81-91. Technical Report prepared for GLERL by Woods Hole Oceanographic Institution under Contract No. 03-5-022-26.
- Dorazio, R. M., and Lehman, J. T. 1982. *Optimal reproductive strategies in age-structured populations of zooplankton*. Final report prepared for GLERL by the University of Michigan, Division of Biological Sciences, under Contract No. NA79RAC00120.
- Hewett, S. W., and Kitchell, J. F. 1982. *Implementation of predator-prey models for Great Lakes fishes*. Final report prepared for GLERL by the University of Wisconsin-Madison, Laboratory of Limnology, under Contract No. 144P436.
- Jacobs, S. J. 1982. *Wave prediction methods: Mass transport in water waves*. Final report prepared for GLERL by the University of Michigan, Department of Atmospheric and Oceanic Science and Department of Mechanical Engineering and Applied Mechanics, under Grant No. 04-7-022-44020.
- Rea, D. K., Owen, R. M., and Meadows, G. A. 1981. *A flux model for suspended particulates and associated chemical substances in large lakes*. Final report prepared for the University of Michigan-GLERL Long-Range Effects Cooperative Program by the University of Michigan, Great Lakes Research Division of the Great Lakes and Marine Water Center.
- Shen, H. T., and Yapa, P. N. D. D. 1982. *Simulation of undersurface roughness coefficient of river ice cover*. Report No. 82-6 prepared for GLERL by Clarkson College, Department of Civil and Environmental Engineering, under Contract No. NA80RAC00147.
- Shen, H. T., Pasquarell, G. C., and Ruggles, R. W. 1982. *Winter flow, ice, and weather conditions of the upper St. Lawrence River, 1971-81. Vol. I: Ice cover charts (part A)*. Report No. 82-1 prepared for GLERL by Clarkson College, Department of Civil and Environmental Engineering, under Contract No. NA80RAC00147.
- Shen, H. T., Pasquarell, G. C., and Ruggles, R. W. 1982. *Winter flow, ice, and weather conditions of the upper St. Lawrence River, 1971-81. Vol. I: Ice cover charts (part B)*. Report No. 82-2 prepared for GLERL by Clarkson College, Department of Civil and Environmental Engineering, under Contract No. NA80RAC00147.
- Shen, H. T., and Yapa, P. N. D. D. 1982. *Winter flow, ice, and weather conditions of the upper St. Lawrence River, 1971-81. Vol. II: Ice cover thickness*. Report No. 82-3 prepared for GLERL by Clarkson College, Department of Civil and Environmental Engineering, under Contract No. NA80RAC00147.
- Shen, H. T., and Yapa, P. N. D. D. 1982. *Winter flow, ice, and weather conditions of the upper St. Lawrence River, 1971-81. Vol. III: Water level, discharge, and temperature*. Report No. 82-4 prepared for GLERL by Clarkson College, Department of Civil and Environmental Engineering, under Contract No. NA80RAC00147.
- Shen, H. T., and Yapa, P. N. D. D. 1982. *Winter flow, ice, and weather conditions of the upper St. Lawrence River, 1971-81. Vol. IV: Air temperature and precipitation*. Report No. 82-5 prepared for GLERL by Clarkson College, Department of Civil and Environmental Engineering, under Contract No. NA80RAC00147.
- Simmons, M. S. 1982. *Assimilation rates of carbon by autoradiographic analysis in Great Lakes phytoplankton*. Final report prepared for GLERL by the University of Michigan under Grant No. NA80RAD00003.

CONTRACTS AND GRANTS DURING FY 1982

Principal Investigator	Institution	Title
A. M. Beeton	University of Michigan	A Cooperative Program in Great Lakes Long Term Effects Research
A. M. Beeton	University of Michigan	The Cycling of Toxic Organic Substances in the Great Lakes Ecosystem
J. E. Breck	Oak Ridge National Laboratory	Models for Behavior and Fate of Long-Lived Contaminants
D. M. Di Toro	Manhattan College	Long Time Scale Investigation of Organic Particle Transport and Fate in Lake Erie
S. J. Eisenreich	University of Minnesota	Toxic Organic-Sediment Dynamics in the Great Lakes
J. P. Giese	Michigan State University	Lysosomal Enzyme Release Assay as a Measure of Stress in Freshwater Clams
J. F. Kitchell	University of Wisconsin (Madison)	Predator-Prey Models for Great Lakes Fishes
J. T. Lehman	University of Michigan	Formulation of Zooplankton in Lake Ecosystem Models
B. M. Lesht	Argonne National Laboratory	Field Study of Sediment Resuspension
G. A. Meadows	University of Michigan	The Growth and Decay of the Coastal Boundary Layer
R. A. Moll	University of Michigan	Bacterial Dynamics
C. H. Mortimer	University of Wisconsin (Milwaukee)	Coupling of Physical and Biological Dynamics in Large Lakes
C. H. Mortimer	University of Wisconsin (Milwaukee)	Inertial Motion and Related Internal Waves
D. Nelson	Argonne National Laboratory	Removal of Radionuclides From Watersheds of the Great Lakes
K. H. Reckhow	Duke University	Uncertainty and Risk Management of Toxic Substances in Aquatic Systems
H. T. Shen	Clarkson College	Ice-Cover Effects on Hydraulic Transient Analysis
M. S. Simmons	University of Michigan	Assimilation Rates of Carbon in Great Lakes Phytoplankton