

NORTHWEST FISHERIES CENTER  
PROCESSED REPORT  
JULY 1976

LINKAGE OF THE BENGTSSON LIMITED AREA  
FORECAST MODEL AND THE OPTIMIZED HYDRODYNAMICAL-  
NUMERICAL MODEL OF THE W. HANSEN TYPE

by

R. Bauer, S. Larson, T. Laevastu and A. Stroud



Prepared by:  
Northwest Fisheries Center  
National Marine Fisheries Service  
2725 Montlake Boulevard E.  
Seattle, Washington 98112

## **NOTICE**

This document is being made available in .PDF format for the convenience of users; however, the accuracy and correctness of the document can only be certified as was presented in the original hard copy format.

Inaccuracies in the OCR scanning process may influence text searches of the .PDF file. Light or faded ink in the original document may also affect the quality of the scanned document.



LINKAGE OF THE BENGTSSON LIMITED AREA FORECAST MODEL AND THE  
OPTIMIZED HYDRODYNAMICAL-NUMERICAL MODEL OF W. HANSEN TYPE

by

R.Bauer, S. Larson, T. Laevastu and A.Stroud

Northwest Fisheries Center  
National Marine Fisheries Service  
National Oceanic and Atmospheric Administration  
2725 Montlake Boulevard East  
Seattle, Washington 98112  
July 1976



## Abstract

The operational quasi-geostrophic three-parameter model developed by Dr. L. Bengtsson for the Swedish Meteorological and Hydrological Institute has been linked with the optimized multi-layer hydrodynamical-numerical model based on the work of Professor W. Hansen at the University of Hamburg, Germany for use in the study of the wind and tide driven circulation along the southern Alaskan coast, sponsored by the Outer Continental Shelf Energy Programme (BLM/NOAA).

The Bengtsson forecast model was used to increase the resolution of the surface pressure field to a 74.08 km grid in an area where the coastal elevations are a major determining factor. The initial states and the variable boundaries were prescribed for the Bengtsson model by extracting data from the Fleet Numerical Weather Central (FNWC) archived files for two storm periods in June and November, 1973.

This document describes the programs and procedures used to link the FNWC fields to the Bengtsson model and the Bengtsson model to the Hydrodynamical-Numerical (HN) model, and provides supplemental information for the Bengtsson and HN models described fully in references (1) and (2).



## INDEX

1. INTRODUCTION.....	1
1.1 OVERVIEW OF THE AT-HN MODEL LINKAGE.....	1
1.2 DESCRIPTION OF GRID CONVENTIONS.....	2
1.2.1 Description of the 74.08 Kilometer Grid.....	5
1.2.2 Description of the Coastal Grids.....	7
1.3 TAPE FORMATS.....	7
1.3.1 FNWC 63x63 Field Tapes.....	7
1.3.2 COAM Tape.....	7
1.3.3 HN Tape Format.....	13
2. HINDCAST DATA PREPARATION.....	16
2.1 GENERAL PROGRAM NOTES.....	16
2.2 PROGRAM ANOMALY.....	17
2.2.1 Run Instructions.....	17
2.2.2 Routine Description.....	18
2.2.3 Variables.....	19
2.3 PROGRAM COAMDAT.....	19
2.3.1 Run Instructions.....	20
2.3.2 Routine Description.....	21
2.3.3 Variables.....	21
2.4 PROGRAM ATANAL.....	21
2.4.1 Run Instructions.....	21
2.4.2 Routine Description.....	24



2.4.3	Variables.....	26
3.	LIMITED AREA ATMOSPHERIC FORECAST MODEL.....	33
3.1	SUMMARY OF CHANGES.....	33
3.2	RUN INSTRUCTION FOR AT MODEL.....	34
3.2.1	Real Data Case Checklist.....	35
3.2.2	Channel Cast Checklist.....	37
3.3	DESCRIPTION OF ROUTINES.....	40
3.4	DESCRIPTION OF VARIABLES.....	46
4.	HYDRODYNAMICAL-NUMERICAL MODEL.....	68
4.1	SUMMARY OF CHANGES.....	68
4.2	ADDITIONAL NOTES ON VARIABLE WIND DATA INPUTS.....	70

LIST OF FIGURES

FIGURE

1	PROGRAM SEQUENCE.....	3
2	GRID CONVENTIONS.....	4
3	HN 74.08 KILOMETER GRID.....	8
4	HN 14.816 KILOMETER WESTERN GRID.....	9
5	HN 14.816 KILOMETER CENTER GRID .....	10
6	HN 14.816 KILOMETER EASTERN GRID.....	11
7	COAM FORMAT.....	12
8	HN TAPE FORMAT.....	14
9	AT MODEL CALL SEQUENCES.....	41
10	HN PROGRAM SEQUENCE.....	69

LIST OF TABLES

TABLE

1	HN GRID RELATIONSHIPS.....	6
2	SPECIFICATION OF CHANNEL TEST CASES.....	39

## ACKNOWLEDGEMENTS

The authors wish to thank Dr. L. Bengtsson, who spent a very difficult week with us testing his model in its revised form, and LT. Byron Maxwell, who provided us with a carefully documented listing and his notes on the Bengtsson model.



## 1. INTRODUCTION

This report describes the linking of the Naval Environmental Prediction Research Facility (NEPRF) version of the Bengtsson three parameter quasi-geostrophic atmospheric (AT) model for limited area forecasting and the NEPRF Optimized version of the Hydrodynamical-Numerical (HN) model for use in the Gulf of Alaska.

The AT model has been tested in a hindcast mode using initial and variable boundary conditions computed from the northern hemisphere 63x63 polar stereographic Fleet Numerical Weather Central (FNWC) grids. The AT model was used to compute the surface winds over the Gulf of Alaska at 6 hour intervals in a 74.08 kilometer grid for two periods beginning 1 June and 17 November 1973. The wind fields were converted to the smaller HN model area grids with grid spaces of 14.816 kilometers by extracting and reanalyzing the relative wind U and V components and then interpolating them to one hour intervals. Winds were introduced into the HN models after a six hour initialization period and updated each hour.

### 1.1 OVERVIEW OF THE AT-HN MODEL LINKAGE

There are three separate programs in the existing linkage between the models. Two of these, the grid preparation and data extraction programs, were written for the NEPRF CDC 3100 computer and are used to prepare FNWC 63x63 data for input into the AT field analysis program. The third program in the linkage started as the field analysis program on the CDC 3100 but was later converted to a dual function program on the CDC 6500. The field analysis program

analyzes the FNWC grid values into AT fields and also analyzes the AT generated wind component fields into the smaller HN grids. Figure 1 shows the program sequencing. Program ANOMALY calculates the M,N coordinates for each polar stereographic I,J grid point in a specified range of I and J points and punches the I,J and HN M,N grid values on cards. Program COAMDAT reads a tape containing FNWC 63x63 fields, extracts an I,J value from each field for each coordinate card in its input deck and generates the COAM tape containing values at I,J points with their HN M,N coordinates. The COAM tape is read by the ATANAL program which analyzes the FNWC values into the AT fields. The AT model in turn generates a wind component tape which is processed by ATANAL into the coastal grid HN wind fields.

## 1.2 DESCRIPTION OF GRID CONVENTIONS

One of the confusing factors in dealing with the programs in this sequence arises because each program borrowed code from a different source and these elements do not have common grid conventions. Figure 2 is presented to reduce the confusion. The arrows within the grid indicate the sequence in which the elements are stored in the arrays and show the array limits and principal indices.

To further complicate the matter there are actually four different HN grids involved. The original AT model grid was developed as a compromise grid for both the AT and HN models. Although the 74.08 kilometer HN model was not used the input and output tapes for and from the AT model are formatted in terms of the 74.08 kilometer HN model. The three HN models that are a part of the BLM Gulf of Alaska project all

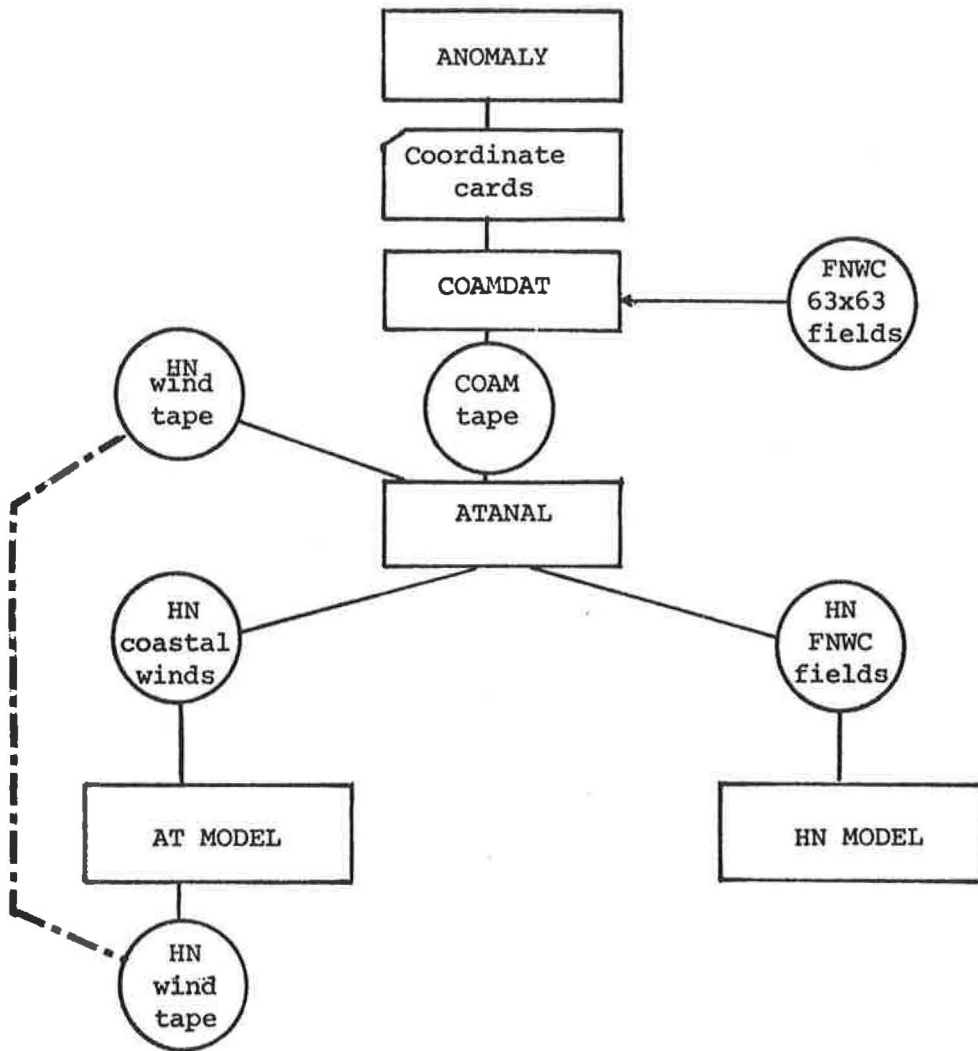
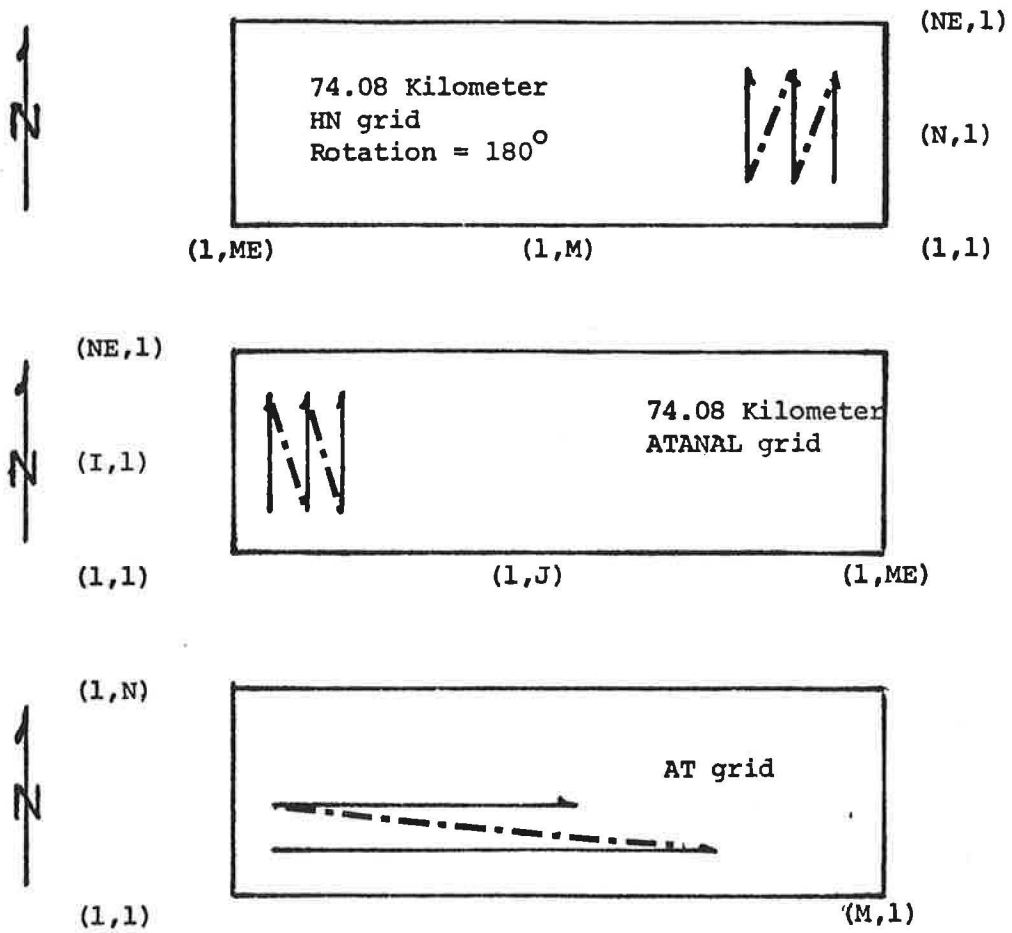

Figure 1. Program sequence





Arrows show order of data storage in a single dimensioned array.

Figure 2. Grid conventions

have 14.816 kilometer grids. To distinguish between the HN models the 74.08 kilometer grid will be assumed unless the area is also specified.

Programs ANOMALY and COAMDAT both use HN grid M,N coordinates. FNWC 63x63 grid points in the programs are in FNWC standard I,J notation. The HN convention is for the upper left corner of the grid to be identified as (1,1) with the row index varying faster. However, the 74.08 kilometer HN grid was rotated 180° so that (1,1) is in the southeast corner.

The HN grid convention indices are used on all tapes in the linkage. The input sections of the ATANAL and AT programs convert from the HN coordinate sequence to the indices used in the models. The output sections of these programs restore the local indices to the HN grid conventions. In the case of ATANAL when the wind fields are being processed the outputted fields match the HN grids for the three coastal areas.

Within the ATANAL program the row index varies faster and the origin is in the southwest corner. The AT model has the same origin as the ATANAL program but the column index varies faster.

All three coastal grids are rotated HN grids. The east coastal grid is rotated counterclockwise 309° with the northern corner as the origin. The western and central grids are rotated 39° so their western corners are their origin.

#### 1.2.1 Description of the 74.08 Kilometer Grid

The 74.08 kilometer grid is defined by the base lines 40° North and center line 143.86333333° West, which corresponds to row 1 and column

TABLE 1

HN Grid Relationships

	HN	HN Western	HN Central	HN Eastern
Model Number	1000	100	70	1
Grid Length (Kilometers)	74.08	14.816	14.816	14.816
Rotation Angle	180	39	39	309
No. Rows	32	27	32	18
No. Columns	47	60	50	40

24, as shown in Figure 3. The distance between rows is  $2/3^\circ$  latitude (74.08 kilometers) and columns are spaced at  $2/3^\circ$  of latitude intervals measured out from the center line. This grid preserves distance measurements but distorts angles at the edge of the grid. This distortion was not considered important.

### 1.2.2 Description of the Coastal Grids

The coastal grids have grid lengths of 14.816 kilometers and overlap. The specifications for the grids are given in Table 1 and are shown in Figures 4 through 6.

## 1.3 TAPE FORMATS

There are three tape formats involved in the sequence. The first is an extract of FNWC 63x63 fields. The second is the COAM tape and the third is the HN format tapes. All tapes are recorded at 556 BPI in 7 tracks, in binary mode, as a single file.

### 1.3.1 FNWC 63x63 Field Tapes

The field format on the FNWC tapes is described in the FNWC User Guide (6). The fields required by the AT model in order for a date-time group set are: the sea temperature (TSEA), the 1000 mb pressure level (D1000), the 500 mb pressure level (D500), the 300 mb pressure level (D300) and the dew point depression (TP850).

### 1.3.2 The COAM Tape

The COAM tape format is shown in Figure 7. The file contains records which are all identical in length but the length may vary

B

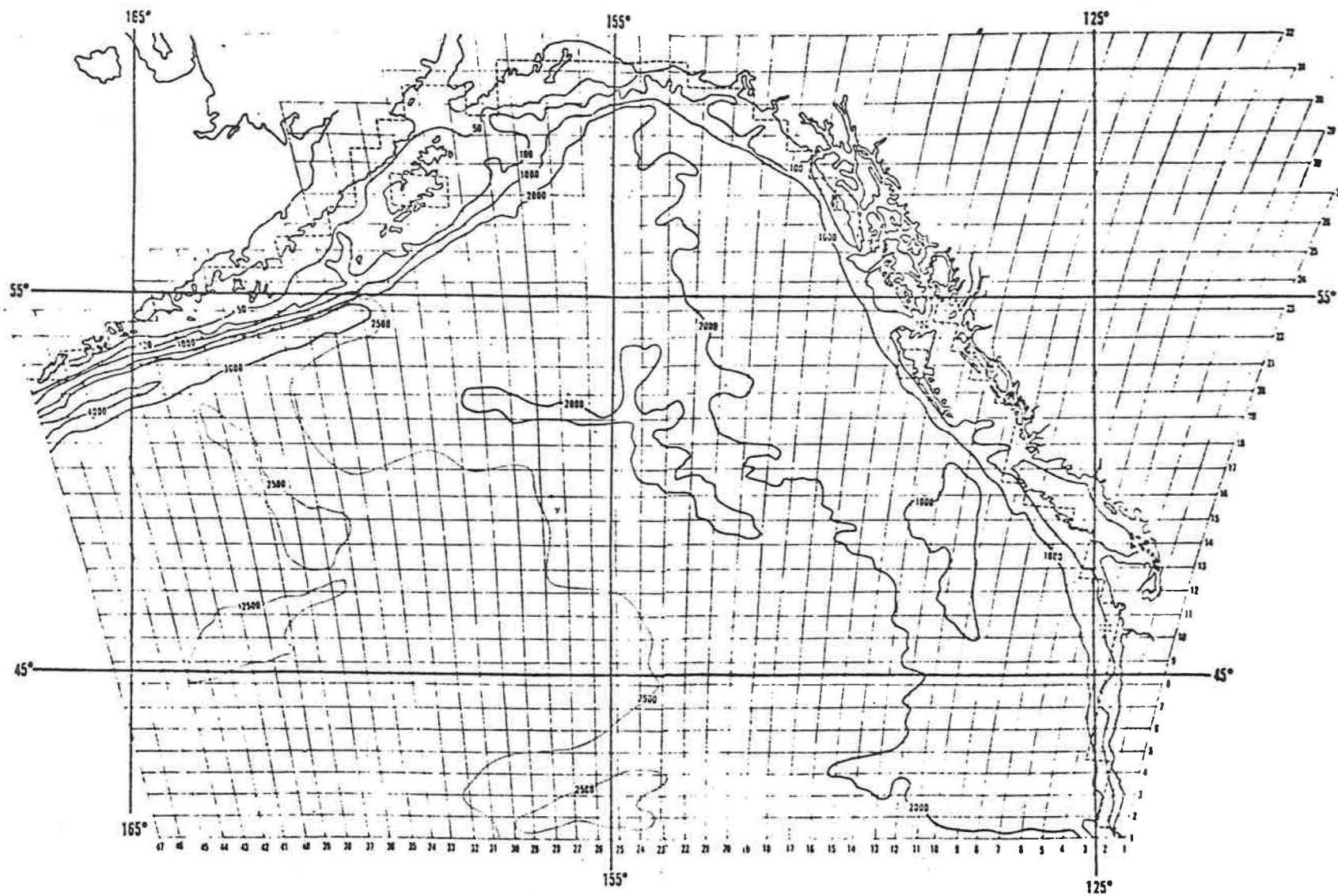

Figure 3. HN 74.08 kilometer grid

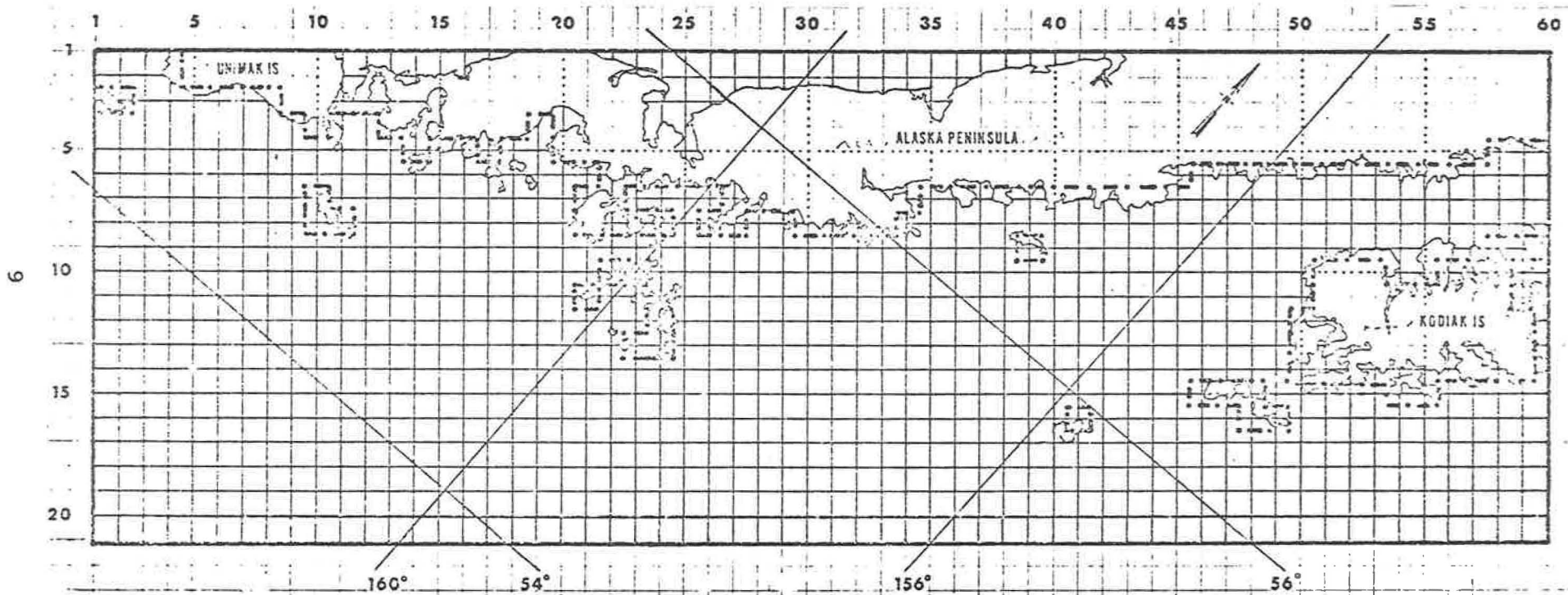

Figure 4. HN 14.816 kilometer western grid

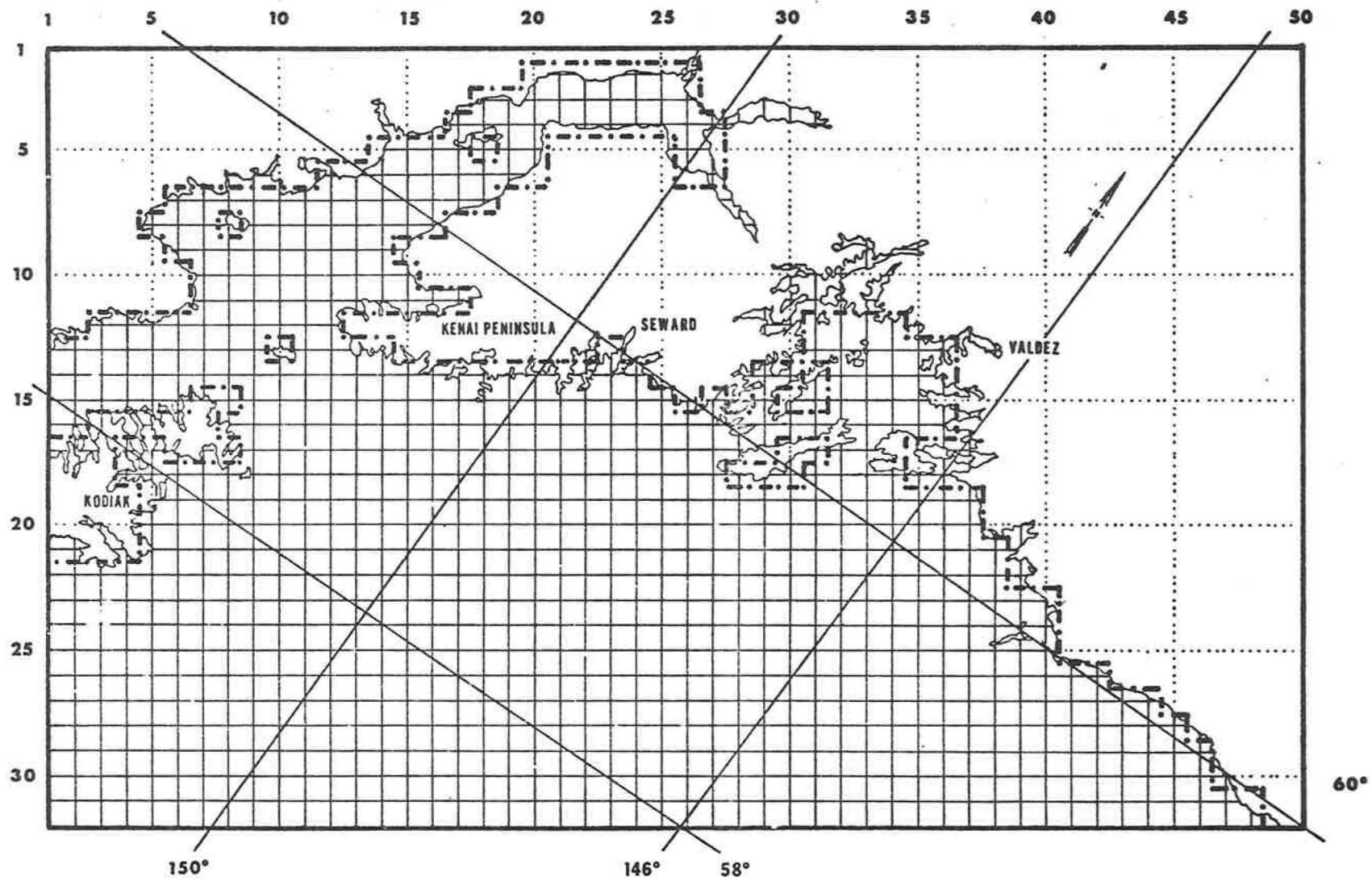

Figure 5. HN 14.816 kilometer center grid

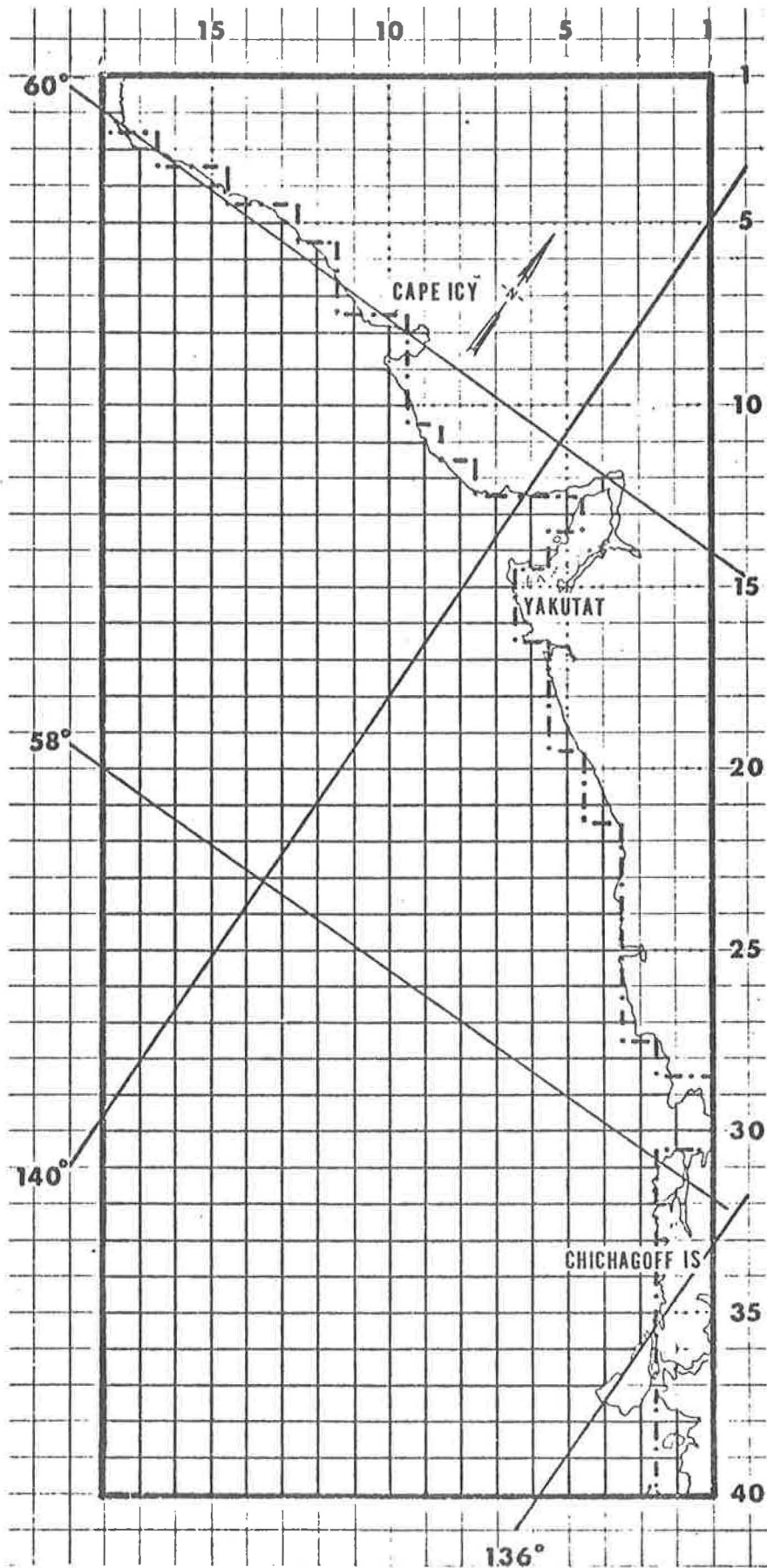

Figure 6. HN 14.816 kilometer eastern grid



556 BPI

Odd parity

48 bit logical record blocked so that there is 1 field in each physical record.

1 file on each tape

For Gulf of Alaska grid there are 75 logical records per physical record.

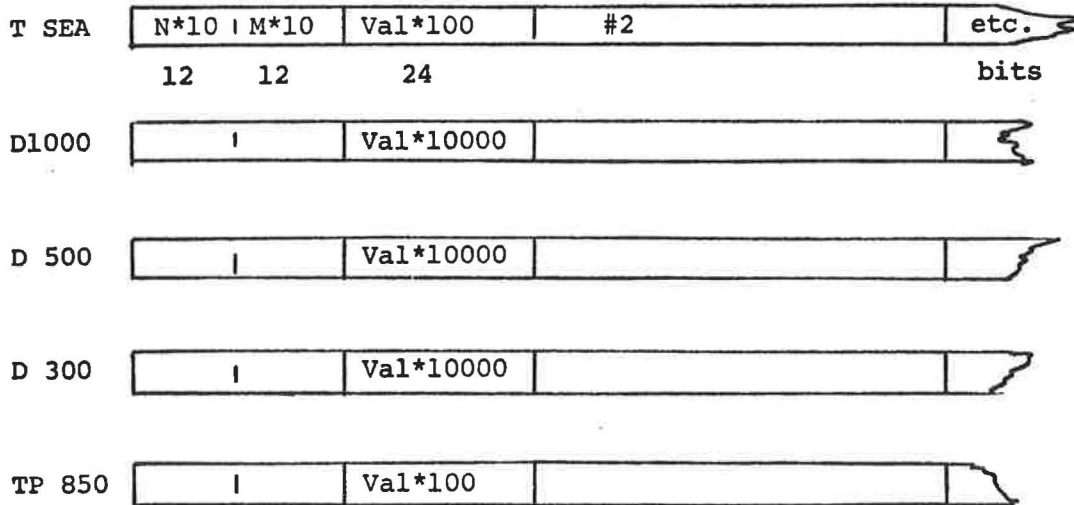

All fields are binary integers

0 = N = NE+1

0 = M = ME+1

Val maybe + or -. Final Val = Val \* Scale + offset

T SEA	.01	.0	°C
D1000	.0001	111.	Z height Meters
D 500	.0001	5574.	"
D 300	.0001	9164.	"
TP 850	.01	.0,	°C

Figure 7. COAM format

depending on the number of coordinate cards in the COAMDAT deck. The file consists of a single record for each FNWC field processed and is composed of 48 bit fields with the M,N coordinate and the value in two 12 and one 24 bit field. All fields represent scaled integers. The coordinate fields are always positive but the value field may be positive or negative. The COAM tape presently serves as a bridge between the 24 bit CDC 3100 computer and the 60 bit CDC 6500 computer.

### 1.3.3 HN Tape Format

The HN tape has records which are of variable length from 144 bits to 30000 bits with a fixed length header of 120 bits. The header bits, as shown in Figure 8, are divided into 24 and 12-bit fields. All values in the header are positive binary integers. The header is followed by from 1 to 1245, 24-bit fields. These data fields contained scaled integers which may be positive or negative. Negative numbers are expressed in CDC 1's complement (in octal (B):0001B=1, 0000B=0, 7777B=-0, 7776B=-1).

A logical record will require more than one physical record if the grid contains more than 1245 values. Any number of physical records can make up a logical record but no logical records share a physical record. Records with type numbers less than 8 are assumed to be grouped logical records with 3 logical records per group. In grouped records, since all logical records have identical headings, the Z logical record must be first followed by the U and then the V logical record.

Logical records are ordered on the tape in ascending type sequence within the time group.

### HEADER FORMAT

TIME in seconds	LAYER OR LEVEL	TYPE*	ROWS	COLS	MODEL NO.	No of bits
24	24	24	12	12	24	

Layer or Level	Type	Scaling
1 2 3	1 = symbolic HTZ, depth HTU and HTV   2 = water height Z, U and V vectors	*10 *1000
0	8    Wind component U and V	*10
0	11   TSEA	*10
1000	12   D1000	*10000
500	12   D500	*10000
300	12   D300	*10000
0	14   TP850	*10

\*types 1-7 reserved for grouped records (Z,U,V)

Value = tape field integer/scale

Figure 8. HN tape format

Type 8 records are reserved for wind components and are paired with the U component field followed by the V component field.

## 2. HINDCAST DATA PREPARATION

The two sets of hindcast data selected for this trial effort consist of two storm periods in the Gulf of Alaska from 1-7 June 1973 and 17-23 November 1973. The FNWC 63x63 fields for these periods at 0000 and 1200 GMT were processed through the sequence into the HN format tape for input to the AT model. The AT model runs were started at 0000, 1 July 1973 and 0000 17 November 1973, using as the initial state the analyzed grid obtained from the FNWC values. The edge values for variable boundary conditions were interpolated between the 12 hour pressure fields for each time step. The TSEA and TP850 were not considered in the variable boundary conditions.

The AT model was run out to 36 hours saving the wind component fields at 6 hour intervals in HN format. The wind components were then analyzed into the coastal grids at 6 hour intervals and linearly interpolated into 1 hour fields for input to the coastal HN models starting at 6 hours.

The three linking programs required to prepare the hindcast data are described in this section. The AT model and HN model instructions are described in the following sections of this report.

### 2.1 GENERAL PROGRAM NOTES

All programs are written in FORTRAN and could be modified to run on other configurations by revising the relatively small sections involving input and output activities that are computer word size dependent. The general description of the programs, the grid convention

and the tape formats has already been given in section 1 of this report. This section contains the run instructions, program organization, methods and variable description.

After the conversion of the analysis program from the CDC 3100 to the CDC 6500 computer was completed, the need for separating the grid calculation, data extraction steps and data analysis steps disappeared, but in the present research effort there was nothing to be gained by converting and combining the functions of the grid preparation and extraction procedures with the input phase of the AT field generation. Consequently, streamlining of procedures will have to await a new application.

## 2.2 PROGRAM ANOMALY

Program ANOMALY was borrowed from another project and was modified to compute the HN grid values from the FNWC I,J latitude longitude coordinates. The program produces both a listing and a deck of coordinate cards.

The relevant part of program ANOMALY consists of the main program ANOMALY, routines IJTOLL and TOLL.

### 2.2.1 Run Instructions

To run program ANOMALY the user must determine the FNWC I,J grid window containing the area to be extracted. When choosing the I,J minimum and maximum values the user should be sure to include the I,J points that lie within one grid cell interval outside the final grid to be used by the AT model. Values in this band outside the grid

row and column are used to determine the boundary values in the final grid and to minimize the distortion on the edge caused by relaxation in the ATANAL program.

The I;J limits are used as limits on loops 999 in program ANOMALY. The parameters given in the call to TOST (an initialization entry for TOLL) specifies the base line latitude, the center line longitude, the HN grid row number for the base latitude and the HN grid column number for the center line. The spacing is set in routine TOLL.

This program punches extra cards that are outside the final grid by more than one row and column. These cards are discarded.

### 2.2.2 Routine Descriptions

#### ANOMALY

This is the main program. It calls routine TOLL twice: once through entry TOST to start the calculations and once for each coordinate point through entry TOMN to get the HN M,N coordinates for a latitude longitude pair. The routine calls IJTOLL once each for each coordinate point to convert from FNWC I,J coordinate indices to latitude longitude. The routine lists the coordinates and punches coordinate cards for use in program COAMDAT.

#### IJTOLL

This routine is given an I,J index in the FNWC northern hemisphere polar stereographic grid and then it returns the latitude longitude coordinates in degrees.

## TOLL

This routine computes the HN grid M,N index for the Gulf of Alaska grid. It is not a general purpose routine in the normal sense; since the indices are computed directly for the HN grid rotated 180°. The routine requires an initial call giving the correspondence between latitude-longitude base and center lines and the N,M grid numbers. In the Gulf of Alaska grid these are 40°N=row 1, 143.863333=column 24. In successive calls to TOMN the routine computes the M,N coordinates using the method described in Bowditch (3) to compute distance along a latitude line.

### 2.2.3 Variables

I,J	FNWC Northern Hemisphere polar stereographic grid indices
XLAT,YLONG	Latitude and longitude of an FNWC grid point
XN,YM	HN grid indices
N,M	Scaled HN grid values=XN*10,YM*10
X1 Y1	Factors to compute distances between longitudes from Bowditch (3).

### 2.3 PROGRAM COAMDAT

Program COAMDAT was written to extract the required I,J values from the tape containing FNWC 63x63 fields using a preexisting standard NEPRF subroutine, READ63. The program as it presently exists processes the PS and D850 fields which are not needed by the AT model. This



routine is not a general purpose routine since it will require code modification to change areas from the Gulf of Alaska HN grid to any other grid.

### 2.3.1 Run Instructions

The program requires card input on the standard input unit, the FNWC 63x63 fields on logical unit 1 and the output COAM tape on logical unit 2.

The data used to locate the field on the FNWC tape is computed as follows:

Year	Set into XI
Month	Computed into XJ using loop 500
Day	Computed into XK using loop 400 with limits given in the data statement to KD and KE
Hour	Computed into XL using loop 300

The fields extracted are given in the data statement using variables NAME, ITAU and ISK and are controlled by loop 200.

The program is set to extract the 75 I,J points in the Gulf of Alaska HN grid. The coordinate cards produced by program ANOMALY are read in loop 10. The points are selected out of the FNWC field in loop 100, are buffered out to unit 2 and are printed with format 1220. All of these coordinate related operations have fixed indexing for 75 points.

### 2.3.2 Routine Description

#### COAMDAT

This routine is described by the run instructions.

#### READ63

This routine is a standard NEPRF CDC 3100 subroutine to read FNWC 63x63 fields.

### 2.3.3 Variables

A	FNWC 63x63 field
IA	Double subscript array equal in length to the floating point array B. Used to store values in the lower 24 bits and the prepared coordinates in the upper 24 bits of the B array. (On the CDC 3100 integers are 24 bits; floating point values are 48 bits). Note: In the Gulf of Alaska grid IA is overlying part of the A array that is not referenced.
B	Output array of M,N and value logical records.

Other relevant variables are given in the run instructions.

### 2.4 PROGRAM ATANAL

Program ATANAL is the program in the linkage that converts fields from one grid to another. It is used both before and after the AT model is the sequence. The program consists of a main program ATANAL and the subroutines FLDANL, READIN, OUTPUT, PRTMAE, INFLD, TIMINT and XMIT.

#### 2.4.1 Run Instructions

The program uses stored input for the control cards described

below. It uses ECS to store the wind component fields where time interpolation is required between the 6 hour fields. The program uses logical unit 1 for the input tape which is either the COAM tape or the HN grid tape generated by the AT model. The program writes the fields generated on logical unit 5. No provisions are made to reposition the tapes within the program, but this can be accomplished with standard CDC Scope control cards.

There are two separate control cards. Only the grid card is required to run the program in the mode to convert from the FNWC grid values to the HN grid. Both the grid and the transform card are required to convert from the HN grid wind component fields to the coastal HN grids.

#### Grid Card

The grid card specifies the grid and analysis constants required on output.

Col	Variable	Format(6I5,4F10.3)
1-5	IGRID	Type of grid process 0= convert from FNWC I,J values to HN grid 1=convert wind components in HN grid to coastal HN grid
6-10	NPASS	Number of iterations allowed in the relaxation
11-15	NE	Number of rows
16-20	ME	Number of columns
21-25	IDBG	Debugging option 0=no debug printouts, 1=debug
26-30	MODEL	Model number to be used on the output tape

31-40	PI	Smoothing parameter
41-50	EPS	Convergence tolerance for relaxation
51-60	ZLMBD4	Convergence factor/4 for relaxation

Transform Card

The transform card is used to specify the grid dimension of the HN grid being inputted, the scaling and rotation factors and the interval between output fields.

Col		Format(2I5,I10,6F5.0,2F10.0)
1-5	NEI	Number of rows in input grid
6-10	MEI	Number of columns in input grid
11-20	ITINT	Interval between output fields If=0 no time interpolation is performed and only 10 words of ECS are used by the program
21-25	YOF	Row index
26-30	XOF	Column index
		Point of rotation in the input grid coordinates*
31-35	ROTIN	Rotation of input HN grid
36-40	YC	Row index
41-45	XC	Column index
		Point of rotation in output grid coordinates*
46-50	ROTOUT	Rotation of output grid
51-60	OLDGRDL	Grid length of input grid
61-70	GRDLENN	Grid length of output grid

\*Rotation angles are specified as counter-clockwise angles in degrees from North to the +Y axis.

## 2.4.2 Routine Description

### ATANAL

This is the main program where the control cards are read and printed. If the program is processing FNWC data into the HN grid, the program assigns the time and type on the basis of COAM tape position. The COAM data are read by routine READIN. When the program is converting from one HN grid to another the data are read by routine INFLD. In both cases the data are placed in the DATA array containing values identified by the output grid coordinates.

Array DATA is passed to routine FLDANL where the data are placed at the grid points using a weight based on distance, are interpolated to obtain a guess field, are relaxed and finally smoothed.

The result field is returned in array GUESS, which is printed and then placed on the output tape together with any preceding time interpolated field by routines PRTMAE and OUTPUT.

### FLDANL

This routine uses a modified FNWC field analysis technique with no guess field and no error checking. The data values are weighted by distance from a grid point and are applied to any grid point within a circle of grid unit radius. Input values within one grid unit outside the final grid are permitted.

To reduce the time required to relax the field after all data points are placed in the grid, guess values are computed at the no data intersection using a normalized squared distance weighted to the neighboring

observed data points in the row and column.

The relaxation procedure is then applied to the field allowing the Laplacian to be recomputed during each iteration until the residual is less than the tolerance specified.

When the smoothing factor is specified (not zero) the field is smoothed using a 4 point smoother. In this smoother the points outside the border are given the value at the border.

#### INFLD

This routine reads an HN tape containing wind components and translates the coordinates based on the values given on the transform card. Values on the input tape that lie more than a grid length outside the final output grid are discarded. Other values are stored in array DATA.

This routine does not check the model or grid size of the input field. If the grid size does not match the NEI, NEI values given on the transform card all data and index returned will be incorrect.

#### PRTMAE

This routine prints out the final field. The indices are in the ATANAL grid not the HN grid. The origin for the ATANAL grid is the lower left corner. In the case of the FNWC to HN grid translation the READIN routine places the data in the ATANAL grid so that the grid is printed geographically correct with North at the top and East to the right. Because of this convention in the HN to HN grid conversion, the coastal HN grid are printed with grid position 1,1 in the lower right hand corner.

## READIN

This routine reads the COAM tape and places the coordinates and values in the DATA array. This read in process is dependent on the COAM tape being in the proper sequence.

## TIMINT

This routine stores and reads the wind component fields to and from ECS and interpolates fields at the interval specified on the transform card.

## XMIT

This routine transfers data from one array to another. The from array (or element) is the first parameter. The to array is the second parameter. The number of words to transfer is the third. The increment between words in the from array is next (0 is used if the from array is a single word). The last parameter is the increment between words being stored in the to array.

### 2.4.3 Variables

CO	Cosine of the rotation angle between HN grids
D	Array of 4 values containing the weighted contribution of an observation to the 4 surrounding grid points
DATA	Values to be passed to FLDANL (1,n)=Y coordinate   in ATANAL coordinates (2,n)=X coordinate   (3,n)=value
EPS	See grid card
FA	Array being placed on output tape
GRDLENN	See transform card

GUESS	Work array for FLDANL containing final field
IA	Base address of array data is being transferred from
IB	Base address of array data in being placed in
IBUF	Tape input buffer
ICNT	Counter to match COAM tape records with HN header data
IDBG	See grid card
IGRID	See grid card
IK	Page counter index
IREC	Number of records read/written on tape
IT	Number of output tapes per input field
ITIM	Time of the output field
ITINT	See transform card
ITNEW	Time of present field
ITOLD	Time of oldest field
ITY	Type code for the output field
ITYP	Array of ITY values used for field being processed for input to AT model
IW	Work array used to write HN fields
IWW	Byte counter for 12 bit bytes in READIN. Word of the array being processed
J	Index used to unpack 24 bit bytes from 60 bit words
JA	Index for incrementing base address of IA array between transfers



JB	Index for incrementing base address of IB between transfers
JJ	Index to reverse the row index to a line number
JM	Index equal to (I,J-1) if inside the grid, otherwise set to (I,J)
JP	Index equal to (I,J+1) if inside the grid, otherwise set to (I,J)
K	Unpacked integer quantity from a for HN tape. Column index in PRTMAE
KA	Index used in XMIT for the next value to be transferred
KB	Index used in XMIT for the next value to be stored
KKM	Squared distance from KM to the point being interpolated
KKP	Squared distance from KP to the point being interpolated
KM	Index of the last grid point influenced by an observed value in the column
KP	Index to the next grid point influenced by an observed value in the column
L	Length of the COAM tape record
LAYER	Layer number for output field
LEN	Number of words in tape buffer IBUF
LEV	Array of layer numbers used in HN headers
LLM	Squared distance from LM to the point being interpolated
LLP	Squared distance from LP to the point being interpolated

LM	Index to the last grid point influenced by an observed value in the row
LP	Index to the next grid point influenced by an observed value in the row
M	Used in some subroutines in place of ME
MAXOBS	Size of the DATA array
ME	See grid card
MEI	See transform card
MF	First column to be printed on page
ML	Last column to be printed on page
MMF	Index offset for first column to be printed on the page
MN	Number of words in input field
MODEL	See grid card
M12	12 bit mask used to format HN tapes
M24	24 bit mask used to format HN tapes
N	Used in some subroutines in place of NE Date-time group increment switch in ATANAL Index for DATA array in READIN Number of transfers in XMIT
NAME	Title for matrix printout
NCNT	Number of field being written to ECS
NE	See grid card
NECS	Array in ECS for 4 fields (a U and a V component field for each time ITOLD and ITNEW)
NEI	See transform card
NEW	Field at ITNEW

NM	Number of elements in output field
NN	Index relating the HN tape output buffer to the ATANAL grid
NOBS	Number of values stored in DATA
NOP	Number of pages required to print array
NPASS	See grid card
NW	Word being packed or unpacked in IW array
OFFSET	Scale offset for integer values on HN tape
OLD	Field at ITOLD
OLDGRDL	See transform card
P1	See grid card
P2	(1.-P1)/4.
R	Array of 4 values containing weights for the 4 grid points surrounding the observed value
RDIFF	Sum of the squared distances passing the unit circle test
RMAX	Maximum change between iteration of the relaxation procedure
RTIME	Ratio of time to interpolate for intermediate wind component fields
ROTATE	Rotation angle between HN grids
ROTIN	See transform card
ROTOLD	See transform card
S	Sum of the squared distances in FLDANL Array to be printed
SC	Ratio of grid scales=input grid size/output grid size

SCALE	Scale factor for integer values on HN tape
SI	Sine of the rotation angle between HN grids
W	Work array required by FLDANL to weight the observed values. In other routines used as a buffer space
X	Input grid index
XC	See transform card
XINC	Fractional difference between XI and the truncated index $I=XI$
XINCL	$1-XINC$
XJ	Coordinate of an observed value
XLAP	Contribution to the relaxation field in one iteration
XMA	Number of column in the rotated array+1
XOF	See transform card
XS	$XINC*XINC$
XX	Rotate grid coordinate
XZ	$XINC*XINCL$
Y	Input grid coordinate
YC	See transform card
YINC	Fractional difference between YJ and the truncated index $J=YJ$
YINCL	$1-YINC$
YJ	Coordinate of an observed value
YMA	Number of rows in the rotated array+1
YOF	See transform card

YS	YINC*YINC
YY	Rotated grid coordinate
YZ	YINC*YINC1
ZLMBD4	See grid card

### 3. LIMITED AREA ATMOSPHERIC FORECAST MODEL

The Bengtsson model (2) was adopted for this project to produce the local wind data. Since only minor changes have been made in the formulation of the model since 1974 this report will concentrate on the instructions to run the model and the way the model is organized and coded, all of which have changed considerably.

Since 1974 the Bengtsson model has been almost completely re-coded at NEPRF to eliminate options reported earlier that were not needed for this project or were no longer needed, to provide a linkage with the FNWC fields through HN formatted tape, to generate and save the wind components, to change the formulation of the stream function, and to add experimental surface heating effects.

#### 3.1 SUMMARY OF CHANGES

The polar stereographic grid used in the earlier model with the options to cut off the corners of the grid has been replaced by the equal distance grid, described in Section 1.2, which is always rectangular.

The experimental optional terms in the vorticity equation have been reduced from 4 to 2 by eliminating the advection of vorticity by divergent winds and the product of relative vorticity and divergence.

Since the model is being used in this project to forecast in a very small area that is nested within the hemispheric grid, the assumption that there was no net inflow or outflow used in the stream function

computation has been discarded in favor of a much simpler numerical relationship between  $F$  and  $\Psi$  given by  $\Psi = Zg/f$ .

The linkages with the FNWC fields and the HN model using HN format tapes through program ATANAL have been added using code borrowed from the HN model.

The wind computation routine added to compute the surface winds was adapted from Larson (5).

The channel data cases coded into the initialization routine have been changed to a simplified test case for use with the new surface heating routine based on Laevastu (4).

### 3.2 RUN INSTRUCTION FOR AT MODEL

The AT model was developed for operational use in a fixed area so all control variables have been compiled into the program rather than being supplied on control cards. The two modes that have been used during the project are the real data case and a channel case with cyclic boundaries. Although the real data case has the option of using static or variable boundaries, in the real data case the boundaries have been varied. In the channel case mode there have been several sets of data used, including both barotropic and baroclinic cases with and without latent and sensible heating. In both modes the step extended calculations have been optional.

To define these different modes and cases the model employs the CDC UPDATE system, which allows temporary modification of a source deck through a correction deck. Unfortunately, this technique, while very

simple to use, is difficult to document in a way that is independent of a particular UPDATE program library. Instead of a card by card description of the UPDATE sets, the following sections provide checklists for the data that must be provided and functions that are required.

### 3.2.1 Real Data Case Checklist

#### Variables Set in PROG3P

Setting	Meaning
KIND=0	Real data case
IVAR=1	Variable boundaries (see input tape rules)
DS=7.408E+4	Size of the Gulf of Alaska grid
N=32	Number of rows in Gulf of Alaska grid
M=47	Number of columns in Gulf of Alaska grid
MODEL=1000	Model number used on HN tape to identify Gulf of Alaska grid
ROT=180.	Rotation of HN input grid. Used to compute wind direction.
NEND=36	Length of forecast period in hours
NTSTEP=12	Number of time steps in the forecast interval
NBLOCK=3	Forecast interval in hours (see input tape rules)
MAPHOUR=0,72,6	Start printouts at time 0, printout at 6 hour intervals until NEND or 72 hour have passed. (also see output tape rules).
LETACC NSMUTT MSMUTT NELLIPT MELLIPT	All must be set to appropriate values that are even multiples of NBLOCK to zero accumulated precipitation, to smooth the field and to check for ellipticity.



IEXT3=1 or=0	Option to include the vertical advection of vorticity and divergence terms
IEXT4=1 or=0	Option to include the twisting term in the vorticity equation
ITIME=0	Initial time on the HN tape in seconds
NTIME=0	Initial time for computation (matching ITIME) in hours

Variables set in INITIAL

For the real data case no variables need be set in INITIAL unless the grid size is changed to 14.816E+4 meters. In this case the grid indices are modified before calls to INOUT and the number of grid points is reduced by the elimination of every other grid point. The reduced grid has been used for a number of tests during the project since it more closely matches the Atlantic grid size for which the model was developed.

Input Tape Rules

The two input tapes used for the project contain a single set of data for either the 1 June 1973 or 17 November 1973 cases and since they contain only relative times they could be used interchangeably by simply changing the tape assigned to logical unit 1. The relative time of the initial fields must match the time specified by ITIME. When variable boundary conditions are used the input tape must have fields in the proper sequence at 12 hour intervals. To have the proper calls 12 must be an integer multiple of NBLOCK.

Output Tape Rules

The output tape is used to store the wind components and is called

from within MAP3P. It is called each time the surface pressure field is printed when the first parameter in the call sequence to MAP3P is equal to 2. The data are written directly on the tape if a tape is pre-assigned to TAPE2.

#### Land Elevation Table

The land elevation table is read by routine INITIAL when it is entered for the real data case. The land elevation table has been read from a card deck where each card represents a row of the Gulf of Alaska grid and each column is a column in the grid. Punches in the land elevation table are the index to the surface pressure table STANPS, which gives the pressure for 0, 200, 500, 1000, 2000, 3000, 4,000 5,000 6,000 and 7,000 meters--the levels on the MONACO charts for the Gulf of Alaska.

#### 3.2.2 Channel Case Checklist

Setting	Meaning
KIND=1	Channel case
IVAR=0	The boundaries are not updated with real data. The channel is connected on the right-left ends.
DS=200km or 100 km	Grid sides used in experimental grids
N=15	Number of rows
M=30	Number of columns
MODEL=0	No input tape is used so the model number does not matter

ROT=0	This does not matter if the winds are not computed.
NEND=36 or 72	Length of forecast period in hours
NTSTEP=12 NBLOCK=6	Number of time steps in the forecast interval and forecast period
MAPHOUR=0, 72,6	Start printout at time 0. Printout at 6 hour intervals until NEND hours or 72 hours have passed.
NSMUTT, MSMUTT=72,0,0	In the channel cases no smoothing is used
LETACC NELLIPT MELLIPT	All must be set to even multiples of NBLOCK
IEXT3=1 or 0 IEXT4=1 or 0	Option to include or exclude extended calculations
ITIME=0 NTIME=0	Time counters should both be equal =0 for the channel case start

For the channel case all data are generated during the execution of routine INITIAL. The calls to routine GENCH are used to create the initial stream function and the calls to FILL are used to generate the surface pressure and temperature fields.

Table 2 shows several test cases using the channel option that were used in conjunction with the optional extended calculations and heating. The dimensions of the in core arrays must be large enough to contain the M\*N array.

Test Cases	1 (Barotropic)	2	3 (Baroclinic 2 wave)	4
Variable				
UPS	30.	7.	5.,5.	0.,3.,4.,6., 5.,4.,3.,2., 0.
UPM	30.	20.	35.,35.	0.,12.22,16.26, 21.31,18.31,15.31 12.12,8.92,0.
UPL	30.	35.	50.,50.	0.,24.,32.,42., 36.,30.,24.,17., 0.
PSIS		0.		.2E7
PSIM		5.4E8		5.144E8
PSIL		9.2E8		9.04E8
FIM		50.		60.
BETA	1.14542E-11		16.E-12	1.14542E-11
NWAVE	1		2	0
NU	1		2	9
NX	1		1,4	0
NY	0		1,1	0
PSIC	0.		0.,0.	0.
PSIS	0.		1.5E5,1.5E5	0.
LAMC	0.		0.,0.	0.
LAMS	0.		-90.,-90.	0.
DS		200./100.		
M		30/60		
N		15/30		
IDIM		450/1800		
IEXT3		0/1		
IEXT4		0/1		

Table 2. Specifications of channel test cases

### 3.3 DESCRIPTION OF ROUTINES

The following routines are described in the order shown in the program organization, Figure 9.

#### PROG3P

This is the main program which contains most of the DATA statements that control the functioning of the program. The program sequence is to set initial constants, call INITIAL to read or generate the time 0 fields, convert the initial fields into the forms required by the computation, initialize and store initial fields in ECS fields and then loop for each forecast interval. Within the forecast loop the fields are mixed with boundary values, smoothed, checked for ellipticity and printed.

#### BMOVE

This routine is used to impose the cyclic boundary on the channel computation. It is used when KIND=0. It moves the next to last column in the array to the first column, and the second column to the last column position.

#### XMIT

This routine is used to move data vectors and zero data arrays within core.

#### RANWT/RANRD

Routine to link the program with an external storage device capable of storing the work arrays. Presently used to transmit to and read data from ECS.

#### FIELD

Debugging aid that prints the entire set of incore work arrays F1-F10.

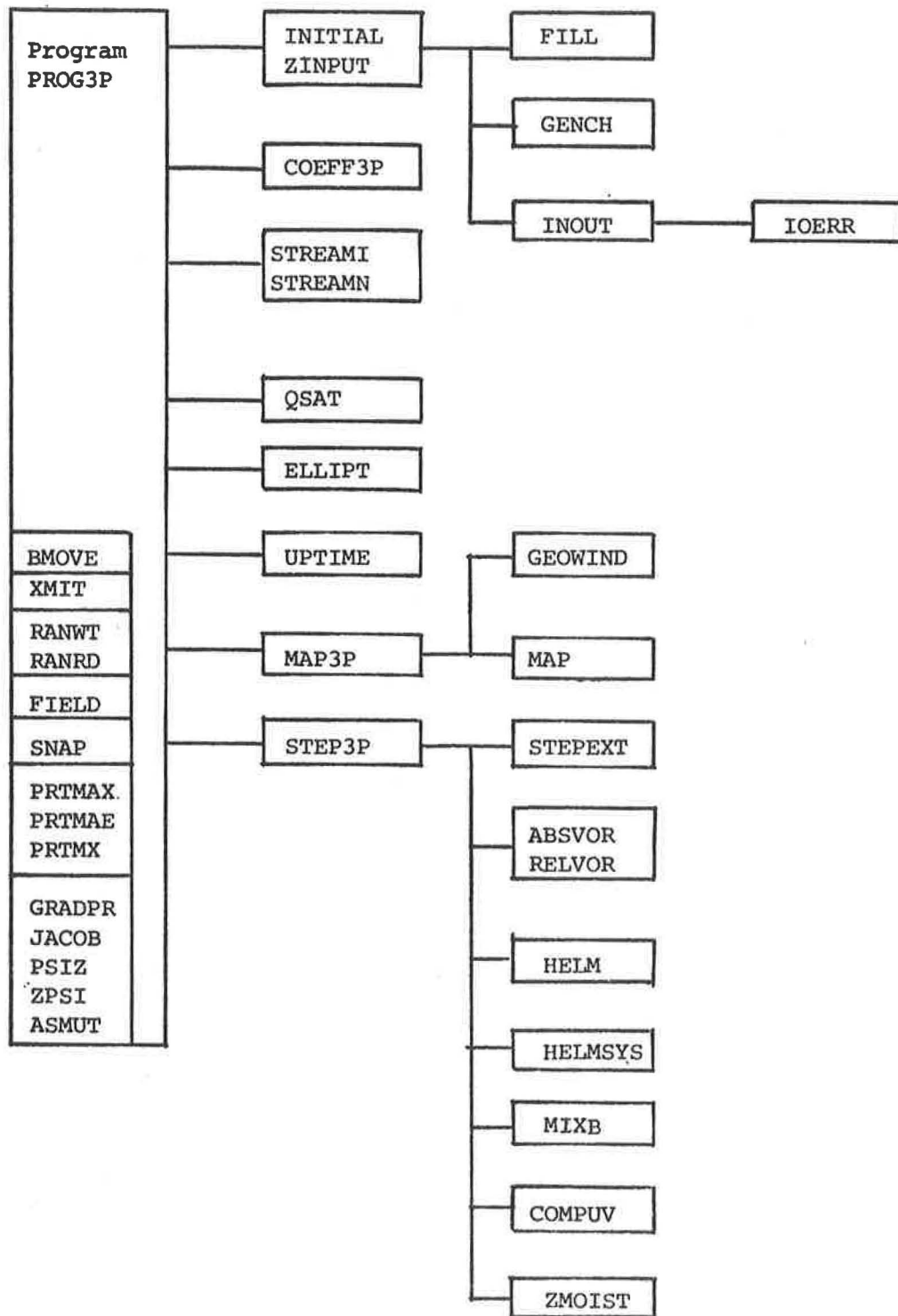

Figure 9. AT model call sequences

## SNAP

Debugging aid. Prints a 10x10 corner of the specified sequential set of the work arrays F1-F10.

## PRTMAX/PRTMAE/PRTMX

Routine to print an array with title, row and column numbers. The three entires provide F12.2, E12.6 and I12 formats for the array values.

## GRADPR/JACOB/PSIZ/ZPSI/ASMUT

This routine combines a number of array to array mathematical processes. Entry GRADPR computes  $\nabla A \cdot \nabla B$  as a finite difference.

$$\begin{aligned} \text{GRADPR}(I,J) &= (A(I+1,J)-A(I,J)) * (B(I+1,J)-B(I,J)) + (A(I,J) \\ &\quad -A(I-1,J)) * (B(I,J)-B(I-1,J)) + (A(I,J+1) \\ &\quad -A(I,J)) * (B(I,J+1)-B(I,J)) + (A(I,J) \\ &\quad -A(I,J-1)) * (B(I,J)-B(I,J-1)) \end{aligned}$$

Entry JACOB computes the Jacobian operator

$$\begin{aligned} J(A,B) &= ((A(I+1,J)-A(I-1,J)) * (B(I,J+1)-B(I,J-1)) \\ &\quad - ((B(I+1,J)-B(I-1,J)) * A(I,J+1)-A(I,J-1))) \end{aligned}$$

Entry PSIZ converts heights to thicknesses.

Entry ZPSI converts thicknesses to heights.

Entry ASMUT smooths the field

## INITIAL/ZINPUT

This routine contains the portion of the initialization process not included in program PROG3P. The data statements in this subroutine are used to control the generation of "canned" channel cases or the reading of

real data.

In the real data case (KIND=1) the surface elevations are read and converted to pressures, the input tape is read and the vapor pressure is computed from the 850 mb dew point temperature. The MARK, MY and F arrays are created and selected data are printed. In the variable boundary cases (IVAR=1) the routine is re-entered through ZINPUT to read the boundary fields that are to be mixed with the forecast field.

In the canned data case, the MARK, MY and F fields are computed and then routine GENCH is called to generate the height fields. Routine FILL is used to create the surface temperature and pressure fields.

#### FILL

This routine is used to fill a selected part of an array with a value that is constant for each column and may vary with the row index by a constant interval.

#### GENCH

This routine is used to generate a 2 dimensional array containing a sine-cosine wave form.

#### INOUT

This routine is used to read and write the fields in or out to tape. The tape format used is described separately. The routine is called by INITIAL to read data and by GEOWIND to write the wind component tape.

#### IOERR

This routine is called by INOUT whenever a parity error or end of



file is detected on input or output tapes.

COEFF3P

This routine precomputes the simple variable constants used by STEP3P and STEPEXT.

STREAMI/STREAMN

This routine rescales pressure fields by the constant  $g/f$ .

QSAT

Computes the integrated mixing ratio at saturation given the mean temperature.

ELLIPT

Modifies the array so that the criterion of ellipticity is satisfied.

UPTIME

Increments the action time by the time interval and then sets the time to a large number if the new time is greater than the end time specified.

MAP3P

Retrieves desired fields from ECS and calls MAP to print the zebra grid points for selected fields. Also calls GEOWIND.

GEOWIND

Routine using Larson formula to compute wind components, speed and direction for use in the HN model.

MAP

Routine to make zebra pattern grid printouts.

STEP3P

Main computation forecasting routine.

STEPEXT

Routine for extended terms

RELVOR

Computes relative and absolute vorticity terms

HELMSYS

Solves the couple set of Helmholtz equations

HELM

Solves the single Helmholtz equations

MIXB

Mixes the forecast field with the input fields on the outer three rows and columns.

COMPUV

Computes the heating effects from the sea surface temperature in the surface layer if the air temperature is colder than the sea.

ZMOIST

Routine to simulate sensible heating based on the sea surface temperature. It is the elevation in meters at which the wind or stream function representative of the wind is calculated, essentially the mid-point of the surface layer ( $\approx 750$  mb).

### 3.4 DESCRIPTION OF VARIABLES

A	A formal parameter array in GRADPR, XMIT, BMOVE	
AB4	Intermediate variable used in solving HELMSYS	
ADIFF	Diffusion coefficient for humidity	
ALFA	Overrelaxation coefficient	
ALFAM	Overrelaxation coefficient used in HELM	
ALFAPSI	Not used	
ANG	Latitude in degrees of a grid point used in GEOWIND	
ARG	Ratios of pressure level used in COEFF3P to compute the ALOG of the ratios	
AX	Angle between pure geostrophic and surface wind vectors	
A1	Used in computation of divergence, $a_1$	$=2.0828 \cdot 10^{-3}$
A2	$a_2$	$=1.3546 \cdot 10^{-3}$
A3	$a_3$	$=0.044374$
B	Output array in XMIT Input array in GRADPR	
BETA	Constant used to compute Beta plane for channel case	
B1	Used in computation of divergence, $b_1$ ,	$=1.0475 \cdot 10^{-3}$
B2	$b_2$	$=1.6261 \cdot 10^{-3}$
B3	$b_3$	$=0.012258$

C	Formal parameter used in GRADPR call sequence for result and work arrays. Constant in COMPUV	= .12
CC1	$1./T0$	
CC2	$e \cdot L/R$	
CC3	$e \cdot L/C_p$	
CC4	CC2·CC3	
CC5	DEL1·DEL2	
CF	Friction over land or over ocean =FCONT or FOCEAN	
CK	Constant used in COMPUV	= .35
CLX	Height of a print character on a CDC printer in meters	= .00425
CLY	Width of a print character on a CDC printer in meters	= .00254
CO	Cosine of geostrophic wind vectors	
CONV	Convergence parameter used in ELLIPT	= .43
COS1	Cosine of angle between geostrophic and surface wind vectors	
CP	Specific heat at constant pressure $C_p$	=1004.
CX	Interpolation interval for computing values at zebra grid print position	
CY	Interpolation interval for computing values at zebra grid print position	
C1	$c_1 = \frac{2P_m}{2P_0 - P_1} = \frac{10}{17}$	=0.588235

C2	$c_2 = \frac{2(P_0 - P_m)}{2P_0 - P_1} = \frac{10}{17}$	=0.588235
C3	$c_3 = \frac{6P_0 - 4P_1}{6P_0 - 3P_1} = \frac{48}{51}$	=0.941176
C4	$c_4 = \frac{6P_m - 2P_1}{6P_0 - 3P_1} = \frac{24}{51}$	=0.470588
C5	$c_5 = \frac{8P_0 - 8P_m}{6P_0 - 3P_1} = \frac{40}{51}$	=0.784314
C6	$c_6 = \frac{8P_m}{6P_0 - 3P_1} = \frac{40}{51}$	=0.784314
C7	$c_7 = \frac{P_1}{6P_0 - 3P_1} = \frac{3}{51}$	=0.0588235
C8	$c_8 = \frac{2}{2P_0 - P_1} = \frac{2}{170}$	=0.0117647

D Combined scaling constant in MAP

DELP  $\Delta_p$  used to compute rainfall

DELT Time step in seconds  
 $\Delta t = \text{NBLOCK} \cdot 3600 / \text{NTSSTEP}$

DEL1  $\delta_2$  tolerance =.0001

DEL2  $\delta_2$  tolerance =.001

DEW Used in advection formula in  
 COMPUV

DIV  $M1 \cdot N2 - N2 \cdot M2$

DIV1 ECS storage array for divergence  
 field  $D_1$

DIV 2 ECS storage array for divergence  
 field  $D_2$

DEPS Time between fields being integ-  
 rated = DELT \* EPS

DS Grid distance (meters)

DSS	.5/DS used in GEOWIND	
DT	Time step in hours =DELTA/3600.	
DX	North-South dimension of a cell in meters represented by a print character in the zebra grid print	
DY	East-West dimension of a zebra cell in meters	
D1	Wind contraction factor	
E	Entry flag used in INITIAL to distinguish between the initial entry and calls to ZINPUT 1.=INITIAL entry 0.=ZINPUT entry	
EC2	ECS address of forecast field to be mixed	
EC3	ECS address of boundary value field to be mixed	
EE	E	=.622
EM	Coefficient for computing mean stream function, $e_m$	=0
EPS	Number of time steps between fields in the time integration	
EP	$E_0$	=.611
E1	Coefficients for computing mean stream functions, $e_1$	=-1.3589
E2	$e_2$	=0
F	Coriolis parameter field = $F_0 \cdot 2 \cdot \text{SIN}(\text{lat degrees})$	
FA	Array contains data to be written on the output tape or array to be filled from data on the input tape.	
FACT	Time ratio used to mix boundary values into field at each integration step	

FCONT	Friction coefficient over land	=1.
FF	In routine INITIAL latitude in degrees, Coriolis parameter at a grid point	
FIM	Mid-latitude of channel	
FLD	Surface pressure field given to GEOWIND	
FM	Mean latitude Coriolis parameter used in computing Beta plane for channel case	
FMY	$f^2/M$	
FOCEAN	Friction coefficient over oceans	=.62
FORC	2D array for the forcing function	
FORC1 FORC2	Formal parameters in HELMSYS routine representing forcing function arrays	
F0	Radial velocity of the earth	=1.03E-4
FOFO	F0 squared	
F1-F10	In core work arrays. All must be of equal size equal to IDIM words	
G	Gravity	=9.806
GDFO	$g/F_0$	
HEAT	ECS storage array for Heating	
HL	L	=2.5.10 <sup>6</sup>
HM3	ECS storage array for the twisting terms for the mean field	
HUM1	ECS storage array for humidity field	
HUM2	ECS storage array for humidity field	

H1	$h_1 = \frac{R}{4c_p} \ln \left( \frac{p_0}{p_m} \right)$	$= 0.495351 \cdot 10^{-1}$
H2	$h_2 = \frac{2f_0}{R \ln \left( \frac{p_0}{p_m} \right)} \left( 1 + \frac{0.75 R (p_0 - p_m)}{c_p (p_0 + p_m)} \right)$	$= 0.110953 \cdot 10^{-5}$
H3	$h_3$	$= 1.03552 \cdot 10^{-6}$
H4	$h_4$	$= 0$
H6	$h_6$	$= 1.03552 \cdot 10^{-6}$
H13	ECS storage array for the twisting terms for the thickness field 1	
H23	ECS storage array for the twisting terms for the thickness field 2	
IA	Increment for array index for the array data is being taken from in XMIT	
IB	Increment for array index for the array data is placed into in XMIT	
IDAY	Day number	
IDIM	True dimensional size of the arrays	
ID1 ID2	Two word ident used to find data on input tapes and to identify output records	
IERR	Index to tape messages in IOERR 1=parity error on input 2=eof input 3=parity error on output 4=eof output	
IEXT3	Switch to include or exclude the vertical advection of vorticity, $\omega \partial \zeta / \partial p$ , in forecasting equation 0=exclude 1=include	



IEXT4            Swith to include or exclude the  
                  twisting term in the forecast-  
                  ing equation  
                  0=exclude  
                  1=include

IFMT            Array used for variable format in  
                  PRTMAX

IMM             Simple index = (1,n)

IND             Simple index to locate the two  
                  points before and following a grid  
                  point I in the row or column. Used  
                  in GEOWIND to compute the second or-  
                  der approximation to the gradient.

IP              Simple index = (I+1,J)

IPOINT         Number of points that fail the  
                  criterion of ellipticity in ELLIPT

IPP             Simple index = (M,n)

IQ              Print value and then the position  
                  index in the zebra grid print row

IREC            Number of records read from input  
                  tape

IS              Line spacing control in PRTMAX  
                  LH, no extra spacing  
                  LHO double space

ISL             Index used to build LS table

IT              Time in seconds of the desired in-  
                  put field

ITIME          Time in seconds when reading or  
                  writing tapes. Time in hours dur-  
                  ing remainder of the program

ITY             Type of field on tape  
                  -indicates field is to be read  
                  +indicates field is to be written  
                  11=FNWC Sea temperature field T SEA  
                  12=FNWC Pressure field D1000,D500  
                  or D300  
                  14=FNWC TP850 field  
                  8=U or V wind component

IVAR           Indicator for constant or  
variable boundary conditions  
0=constant boundaries  
1=variable boundaries

IW             500 word buffer used to read and  
write tape

IWW            The word that is presently being  
packed or unpacked for or from the  
tape buffer in INOUT

I1             In QSAT index to precomputed values  
of integrated mixing ratios in the  
range 1 to 71 from temperature in  
the range -20 to +50.  
InPROG3P =0 if no smoothing this time  
step  
              =1 if smoothing is required  
In GRADPR=beginning point in array  
for storing smoothed  
values. Excludes first  
rows from computation.

I2             In PROG3P =0 if ellipticity is by-  
passed this time step  
              =1 if fields are modified  
to meet ellipticity cri-  
terion  
In GRADPR=end point in array for stor-  
ing smoothed values. Ex-  
cludes last row from com-  
putation

              Indicator for when zebra grids are  
to be printed 0=no print, 1=print

I1             Surface pressure (2=print and call GEOWIND)

I2             Height for level  $p_m$

I3             Height for level  $p_1^m$

I4             Thickness ( $p_m - p_1$ )

I5             Lower vertical velocity  $\omega_1$

I6             Precipitable water

I7             Accumulated precipitation

I8             Relative humidity

I9             Stream function for level  $p_s$

I10            Stream function for level  $p_m$

I11            Stream function for level  $p_1$

JJ             Row number in PRTMAX

JK	Index to first column being printed on the page in PRTMAX	
JMA	Maximum row index for the page	
JMI	Minimum row index for the page	
JMP	Number of column being printed in this page of the zebra grid print	
J3	ECS storage array for $J_3 = J(\Psi_m; \Psi_1)$	
J4	ECS storage array for $J_4 = J(\Psi_m; \Psi_2)$	
J12	ECS storage array for $J_1 + J_2 = J(\Psi_m; \zeta_1) + J(\Psi_1; \beta_2)$	
J56	ECS storage array for $J_5 + J_6 = J(\Psi_m; \zeta_2) + J(\Psi_2; \beta_6)$	
J789	ECS storage array for $J_7 + J_8 + J_9 = J(\Psi_m; \beta_7) + J(\Psi_1; \beta_8) + J(\Psi_2; \beta_9)$	
KIND	Type of run flag 1=canned data channel case (cyclic boundary conditions) 0=real data	
KT	In STEP3P Index in the integration loop In MAP Array of print characters used for the zebra print	
K1	$k_1 = c_2(c_2 - \frac{4}{3})$	=-0.438291
K2	$k_2 = -c_2c_4$	=-0.276816
K3	$k_3 = c_2c_7$	=-0.034602
K4	$k_4 = -c_1c_2$	=-0.346020
K10	$k_{10} = 2t_2c_8$	=-0.438294
K11	$k_{11} = -2(t_3 + t_7)c_8$	=-0.276817
K12	$k_{12} = -t_7c_8$	=0.034602
K13	$k_{13} = -2t_3c_8$	=-0.346021

K14	$k_{14} = 2(t_5 - t_8)c_8$	=-0.507498
K15	$k_{15} = -t_8c_8$	=0.083045
K16	$k_{16} = 2t_1c_8$	=0.016609
K17	$k_{17} = 2(t_4 - t_6)c_8$	=0.005536
K18	$k_{18} = -t_6c_8$	=-0.000692
K19	$k_{19} = 2t_2c_8$	=-0.438293
K20	$k_{20} = 2t_3c_8$	=-0.346021
K21	$k_{21} = 2t_1c_8$	=0.016609
K22	$k_{22} = -2(t_3 + t_7)c_8$	=-0.276817
K23	$k_{23} = 2(t_5 - t_8)c_8$	=-0.507497
K24	$k_{24} = 2(t_4 - t_6)c_8$	=0.005536
K25	$k_{25} = -t_7c_8$	=0.034602
K26	$k_{26} = -t_8c_8$	=0.083045
K27	$k_{27} = -t_6c_8$	=-0.000692
K31	$k_{31} = -\frac{t_{10}}{(p_0 - p_m)}$	=0.411765
K32	$k_{32} = -\frac{t_{11}}{(p_0 - p_m)}$	=0.588235
K33	$k_{33} = \frac{1 - t_9}{(p_0 - p_m)}$	=0.0117647
K36	$k_{36} = \frac{t_{10} - t_{13}}{(p_m - p_1)}$	=-0.588235
K37	$k_{37} = \frac{t_{11} - t_{14}}{(p_m - p_1)}$	=-0.411765
K38	$k_{38} = \frac{t_9 - t_{12}}{(p_m - p_1)}$	=0.0117647

LAMC Phase differences for the cosine functions ( $\lambda c$ )

**LAMS** Phase differences for the sine functions ( $\lambda_s$ ).

**LCM** Address of ECS where array transfer starts

**LEN** Length of input output buffer in INOUT=500 words on CDC 6000-7000 series machine

**LETACC** (1) Times when the accumulated precipitation shall be interrupted in hours (multiple of NBLOCK)  
(2) End time after which no interruption takes place  
(3) Time interval between interruption (multiple of NBLOCK)

**LEV** Level in tape record header  
300 for D300  
500 for D500  
1000 for D1000  
0 for all other fields

**L** Counter used in COMPUV indicating the number of times the routine has been entered

**LS** ECS array contains the flag field used by COMPUV

**LU** Logical unit number for output tape in INOUT, for zebra grid prints in MAP

**M** Row dimension

**MAPHOUR** (1) Time when forecast is to be printed in hours (multiple of NBLOCK)  
(2) Time of last printout desired  
(3) Time interval between forecast printouts (multiple of NBLOCK)

**MARK** Flag field used to control computations in the outside 3 rows and columns of the arrays defined as follows (origin of grid=lower left corner):

```
20 10 10 10 10 10 10 19
14 -9 -8 -8 -8 -8 -7 6
14 -9-10-10-10-10 -7 6
14 -9-10 -1 -1-10 -7 6
14 -9-10 -1 -1-10 -7 6
14 -9-10-10-10-10 -7 6
14 -9 -6 -6 -6 -6 -7 6
17 2 2 2 2 2 2 18
```

**MAXNAME** Maximum number of words in matrix header line = 10

**MELLIPT** (1) Time at which ellipticity correction is to be made in hours (multiple of NBLOCK)  
(2) Time of last correction  
(3) Time interval between corrections (multiple of NBLOCK)

**MF** Index to the first column being printed on the page in PRTMAX

**MI** In FILL number of columns to be filled

**ML** Index to last column being printed on the page in PRTMAX

**MN** Number of elements used in the arrays=number of rows times number of columns

**MODEL** Model number used when reading or writing tapes. Used to uniquely define the data tapes.

**MSMUTT** Same as NSMUTT for a second time sequence except it cannot be used to control smoothing at time 0.

MT	UPTIME parameter (1) Time action desired (multiple of NBLOCK) (2) Last time action desired (3) Time interval between actions (multiple of NBLOCK)	
MY	Map scale factor $\mu$	
M1	Number of columns-1, $m_1$	==826.330
M2	$m_2$	==688.40
M12	12 bit mask used to pack and unpack tapes	
M24	24 bit mask used in packing and unpacking tapes	
N	Column dimension	
NAME	Page header word in SNAP and FIELD	
NAME1	Header for the matrix printout NC characters in length 1 to 80 characters long	
NBLOCK	Forecast interval in hours (usually 6)	
NC	Number of characters in NAME1 header line $1 < NC < 80$	
NCNT	Counter for the number of times SNAP has been called	
NCPW	Number of characters per word=10	
ND	NTSTEP+1 Number of times the integration loop is executed during one forecast computation	
NELLIPT	Same as MELLIPT but used for a second time sequence	
NEND	End time for forecast in hours	

NI	In FILL number of rows to be filled	
NN	Number of print column available for zebra print grid	
NOP	Number of pages required to print a matrix in PRTMAX	
NSMUTT	(1) Time of the first smoothing, may be 0 if the initial fields are to be smoothed (in hours) (2) Last time for a smoothing operation (3) Time interval between smoothing operations	
NTIME	Time in hours	
NTSTEP	Number of time steps for an integration interval	
NU	Resolution of zonal wind speed	
NW	Number of words being packed or unpacked in INOUT, in PRTMAX number of words in heading	
NWAVE	Number of waves	
NX	Wave numbers as a function of channel length in X direction (nx)	
NY	Wave numbers as a function of channel width in Y direction (ny)	
N1	Number of rows-1, $n_1$	=-532.92
N2	$n_2$	
OFFSET	Constant added to input values from tape after the values are scaled and subtracted from output values before scaling	
PI	Radians in 180°	=3.141593
PNIVM	Pressure level $p_m$	=50CB



PNIVS	Pressure level $p_0$	=100CB
PNIV1	Pressure level $p_1$	=30CB
PM	$p_m$ Intermediate pressure level that divides the atmosphere into 2 layers	=50CB
PMEAN	$.5 \cdot p_m + p_s$	
PP	Intermediate value used in STEP3P computations. Ratio of time step to grid size used in COMPUV	
PPM	$2. / (p_0 - p_m)$	
PQ	Intermediate value used in STEP3P computation	
PREC	ECS storage array for accumulated precipitation	
PS	ECS storage array for surface pressure field	
PSI	Result field $\Psi$ field Array being modified to satisfy the criterion of ellipticity in ELLIPT	
PSIC	Amplitudes of the cosine functions ( $\Psi_c$ )	
PSIM1	ECS storage array for $\Psi_m$ at time 1	
PSIM2	ECS storage array for $\Psi_m$ at time 2	
PSIPM	Pressure levels for channel case	
PSIPS		
PSIP1		
PSIS	Amplitudes of the sine function ( $\Psi_s$ )	
PSI11	ECS storage array for $\Psi_1$ at time 1	

PSI12	ECS storage array for $\Psi_1$ at time 2	
PSI21	ECS storage array for $\Psi_2$ at time 1	
PSI22	ECS storage array for $\Psi_2$ at time 2	
P0	$P_0$ Lower pressure level near the surface of the earth	=100 CB
P1	$P_1$ Upper pressure level near the tropopause	= 30 CB
Q	Field to be printed	
QD	Resolution indicator for isolines	
QZ	Isoline corresponding to 000 on the printed grid	
R	Gas constant for air	=287.
RESIDUE	Formal parameter in HELMSYS=RESM Formal parameter in HELMSYS= RESSYS	
RESM	Allowed residual in the HELM routine	$=.5 \cdot 10^5$
RESPSI	Not used	
RESSYS	Allowed residual in the HELMSYS routine	$=.5 \cdot 10^5$
RESZ	Not used	
RMAX	Maximum residual remaining at the end of an iteration in HELM	
ROT	Grid rotation defined as counter clockwise angle from the North to the +Y axis in degrees	
RPD	Radians per degree. Constant used to convert to and from degrees	
RW	Precomputed values mixing ratios at saturation	

S	Array to be printed in PRTMAX Vorticity term at one grid point in ABSVOR	
SATUR	Saturation temperature	
SCALE	Map scale factor for grid print (unit 10° m) Scale factor in INOUT = .01 for all input fields except for ITY=12 (D300, D500, D1000) when the factor is .0001	
SCM	Beginning word of an array to be transferred to or from ECS	
SI	Sine of the geostrophic wind vector	
SIN1	Sine of the angle between the geo- strophic and surface wind vectors	
SS1	Coefficients for computing mean divergences	=E1+EM•C2
SS2		=E2-EM•C1
SS3		=-EM•C8
STANPS	Standard pressures at mean levels defined on Monoco charts.	
SURPS	Standard atmospheric pressure at sea level	=101.325 CB
STAB1	$(\Gamma_d - \Gamma)_1$ the dry adiabatic lapse rate-lapse rate; assume	=.422222
STAB2	$(\Gamma_d - \Gamma)_2$ $\Gamma = .75 \Gamma_d$	=.511111
S1	Used in computations of diver- gence, $s_1$	=28.230856
S2	$s_2$	=10.645832
TA	ECS storage array for the air temperature	

TERM1	Values used in the computation of divergence	
TERM2		
TM	Temperature in °K	
TOL	Tolerance	
TS	ECS storage array for surface temperature in °K	
TWT	Air-sea temperature difference	
TO	Conversion factor to convert from °C to Kelvin=273.	
T1	$t_1 = \frac{P_0 + P_m - P_1}{2P_0 - P_1}$	=0.705882
T2	$t_2 = \frac{1}{3} \frac{(2P_1 - 3P_m - P_0)(P_0 - P_m)}{2P_0 - P_1}$	=-18.627500
T3	$t_3 = \frac{P_m(P_0 - P_m)}{2P_0 - P_1}$	=14.705900
T6	$t_6 = c_8 \frac{P_1}{6}$	=0.0588235
T7	$t_7 = -c_2 \frac{P_1}{6}$	=-2.941175
T8	$t_8 = (c_1 - 2) \frac{P_1}{6}$	=-7.058825
T10	$t_{10} = (c_2 - 1)(P_0 - P_m)$	=-20.588250
T11	$t_{11} = -c_1(P_0 - P_m)$	=-29.411750
T12	$t_{12} = c_8 \frac{P_1}{2}$	=0.176471
T13	$t_{13} = -c_2 \frac{P_1}{2}$	=-8.823525

T14	$t_{14} = (c_1 - 2) \frac{p_1}{2}$	=-21.176475
U	Zonal wind speed	
UKUA	Air temperature gradient in the U direction	
UKUW	Water temperature gradient in the U direction	
UPM	Zonal wind profiles at the levels $p_s$ , $p_m$ and $p_1$ for the initial fields in the channel case	
UPS		
UPL		
V	In FILL value placed in the row	
VKVA	Air temperature gradient in the V direction	
VKVV	Water temperature gradient in the V direction	
VI	In FILL value that the initial value is incremented by when incrementing to next row	
VM	ECS storage array for the velocity potential for the mean field	
VOR	$\eta$ or $\zeta$ field	
VS	In FILL initial value to be placed in the row	
V1	ECS storage array for the velocity potential for the thickness field 1	
V2	ECS storage array for the velocity potential for the thickness field 2	
WF	Weighting factor used to interpolate between boundary value fields in time	

	Weights for mixing the boundary fields
WGT1	Outside row or column
WGT2	Next inner row or column
WGT3	Third row or column inside boundary
WI	Easterly component of wind vector
WJ	Northerly component of wind vector
WS	ECS sotrage array for $\omega_s$ , the vertical velocity at the lower boundary
WT	Wind speed
WX	Adjustment of wave near rigid boundaries Boundary WX=0 +1 row from the boundary, wx=0.33 +2 rows from the boundary, wx=.64 +3 or more rows from the boundary, wx=1.
XIX	Row in index-1 used to compute latitude in GEOWIND
XP	Midpoint in a zebra grid print position
YP	Midpoint in a zebra grid print position
YZ	Midpoint in a zebra grid print position
Z	Formal parameter in STREAM1 routine= height field
ZD	Wind direction computed in GEOWIND
ZM	Data array used to store precomputed values for ZMOIST

ZM1	$Z_m$ fields stored in ECS for boundary mixing at times 1 and 2
ZM2	
ZS	Wind speed computed in GEOWIND
Z1	Arrays used in HELMSYS
Z2	
Z11	$Z_1$ fields stored in ECS for boundary mixing at times 1 and 2
Z12	$Z_1 = .5(Z_m - Z_{1000})$
Z21	$Z_2$ fields stored in ECS for boundary mixing at times 1 and 2
Z22	$Z_2 = .5(Z_{300} - Z_m)$

#### 4. HYDRODYNAMICAL-NUMERICAL MODEL

The Optimized HN model run instructions are contained in Bauer (1) and additional documentation of the model is in preparation for the Environmental Protection Agency, Corvallis Environmental Research Laboratory so it is not repeated in this report. Figure 10 is an overview of the HN model program sequence showing where the AT model links in. The HN model requires a preprocessed initial grid contained on an HN format tape. This tape is prepared by a program on the NEPRF CDC 3100 computer by Phase I. The HN model reads the initial tape and the optional wind component tape generated by the ATANAL program from the water heights and and velocity fields. The output tape can then be processed by the display program Phase III which produces pen plots on CalComp plotters, by HNCNTR which produces contour plots of the fields on the NEPRF 3100 Varian plotter or by ADVECT which is a program to advect pollutants based on the velocity fields.

##### 4.1 SUMMARY OF CHANGES

The HN model reported in (1) has undergone a number of revisions since the report was prepared. Most of the changes were to add capabilities to the model or to alter the boundary conditions that are treated in detail in the forthcoming EPA report. The only change made specifically for this project was the addition of the variable wind input option. This change was made using the CDC UPDATE system to replace the source program statements that converted the WIND card parameters



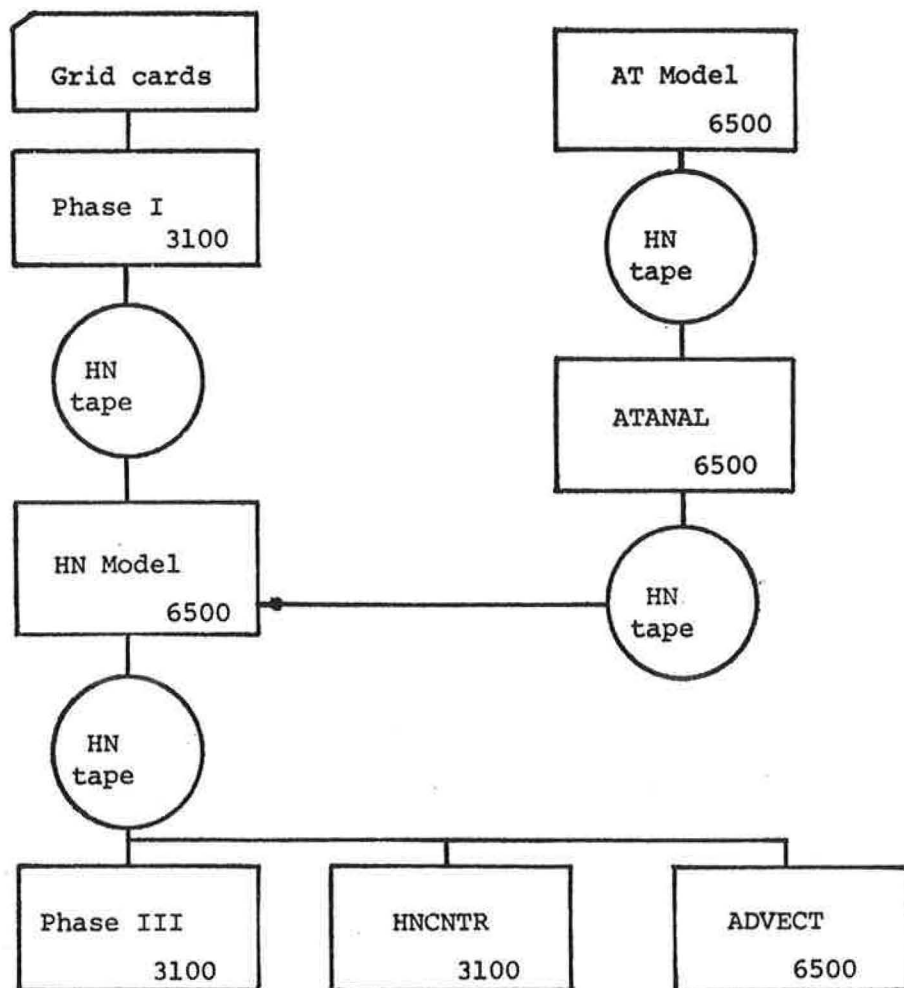

Figure 10. HN program sequence

into constant wind fields with a call to INPOUT to read the wind component fields, to add the capability to INPOUT to read a second tape, and to update the field each hour once it is turned on. The facilities of starting and ending the wind field were left under the control of the WIND card.

#### 4.2 ADDITIONAL NOTES ON VARIABLE WIND DATA INPUT

The wind component tape contains components of the wind expressed as force vectors relative to the HN model grid and does not require additional rotations. The start time and update times, grid size, and model number must all match those supplied to the Phase I card ATANAL programs or the records will be bypassed by INPOUT routine. Normally the wind is not started in the HN model until at least 6 hours to avoid initial program shock which can cause the HN model to become numerically unstable.

