

Assessment of WaterLog[®] Microwave Water Level Sensors in the Great Lakes

National Water Level Observation Network

Silver Spring, Maryland
November 2022



noaa National Oceanic and Atmospheric Administration

U.S. DEPARTMENT OF COMMERCE
National Ocean Service
Center for Operational Oceanographic Products and Services

Center for Operational Oceanographic Products and Services
National Ocean Service
National Oceanic and Atmospheric Administration
U.S. Department of Commerce

The National Ocean Service (NOS) Center for Operational Oceanographic Products and Services (CO-OPS) provides the National infrastructure, science, and technical expertise to collect and distribute observations and predictions of water levels and currents to ensure safe, efficient and environmentally sound maritime commerce. The Center provides the set of water level and tidal current products required to support NOS' Strategic Plan mission requirements, and to assist in providing operational oceanographic data/products required by NOAA's other Strategic Plan themes. For example, CO-OPS provides data and products required by the National Weather Service to meet its flood and tsunami warning responsibilities. The Center manages the National Water Level Observation Network (NWLON), a national network of Physical Oceanographic Real-Time Systems (PORTS[®]) in major U.S. harbors, and the National Current Observation Program consisting of current surveys in near shore and coastal areas utilizing bottom mounted platforms, subsurface buoys, horizontal sensors and quick response real time buoys. The Center: establishes standards for the collection and processing of water level and current data; collects and documents user requirements, which serve as the foundation for all resulting program activities; designs new and/or improved oceanographic observing systems; designs software to improve CO-OPS' data processing capabilities; maintains and operates oceanographic observing systems; performs operational data analysis/quality control; and produces/disseminates oceanographic products.

A critical subset of that mission is the collection and measurement within the Great Lakes. Microwave water level measurement sensors have become a cost effective, highly accurate, and easy to maintain tool in the coastal areas of the United States, including areas within coastal rivers, bays, and harbors which experience similar environmental conditions to the Great Lakes. This report is an analysis of the application of microwave water level sensors in the Great Lakes.

Assessment of WaterLog[®] Microwave Water Level Sensors in the Great Lakes

Robert Loesch
Gregory Dusek
Robert Heitsenrether
Lindsay Abrams
Albert Sanford
Jeff Oyler
Adam Grodsky

November 2022



U.S. DEPARTMENT OF COMMERCE

Gina M. Raimondo, Secretary

National Oceanic and Atmospheric Administration

Dr. Richard Spinrad, Under Secretary of Commerce for Oceans and Atmosphere

National Ocean Service

Nicole LeBoeuf, Assistant Administrator

Center for Operational Oceanographic Products and Services

Richard Edwing, Director

NOTICE

Mention of a commercial company or product does not constitute an endorsement by NOAA. Use of information from this publication for publicity or advertising purposes concerning proprietary products or the tests of such products is not authorized.

TABLE OF CONTENTS

LIST OF FIGURES	1
LIST OF TABLES	3
EXECUTIVE SUMMARY	4
1. Purpose.....	5
2. Background	5
3. CO-OPS Operational Applications of Radar Water Level Sensors.....	6
4. Microwave Radar Configuration and Setup	8
5. Initial Great Lakes Microwave Radar Field Tests	10
5.1 First Test Location: Fort Gratiot, MI	10
5.2 Second Test Location: Buffalo, NY	15
6. Recent Microwave Radar Comparisons	21
6.1 Comparison Methods	22
6.2 Marblehead, OH	23
6.3 Green Bay East, WI.....	24
6.4 Ogdensburg, NY.....	26
6.5 Duluth, MN	28
7. Recommendations	30
8. Conclusion	30
9. References.....	32

LIST OF FIGURES

Figure 1. Waterlog radar sensor’s survey reference point location 9

Figure 2. Radar sensor survey collar drawing and field level survey process photos. 9

Figure 3. Location of Fort Gratiot, MI, field test site. 11

Figure 4. Fort Gratiot, MI, (gauge house atop the concrete well) leveling survey..... 11

Figure 5. Fort Gratiot, MI, Microwave Water Level (MWWL) mounting frame. 12

Figure 6. Fort Gratiot, MI, Microwave Water Level (MWWL) installation inside sump..... 12

Figure 7. Schematic of Microwave Water Level (MWWL) sensor installation in the well, looking downward..... 13

Figure 8. October 2009 time series of (a) hourly wind; (b) water levels, 1-Hz WaterLog® (blue line), 6-min average WaterLog® (black dots), and BEI (red dots); and (c) WaterLog® versus BEI Δ WL at the Fort Gratiot, MI, National Water Level Observation Network (NWLON) site..... 14

Figure 9. Monthly root mean square differences (RMSDs) between WaterLog® and BEI 6-min water level series (red) and differences between WaterLog® and BEI monthly mean water levels (blue). 14

Figure 10. Location of Buffalo, NY, National Water Level Observation Network (NWLON) station..... 16

Figure 11. Zoomed in Google Maps view of Buffalo, NY, National Water Level Observation Network (NWLON) station, with locations of the 2 radar water level test systems annotated.... 16

Figure 12. Photos of the two radar water level test systems following installation..... 17

Figure 13. Level survey immediately following installation. 17

Figure 14. Meteorological and water level data recorded at the National Water Level Observation Network (NWLON) station over the entire course of the test period, Jun 1-Oct 31, 2013 18

Figure 15. Sample of 6-minute test radar results for June, the first month of testing: wind speed (top); 6-minute water level differences, National Water Level Observation Network (NWLON) inner test radar (middle); 6-minute water level differences, NWLON outer test radar (bottom). 19

Figure 16. Comparisons of inner versus outer test radar sensors 6-minute tests with standard deviations of 1 Hz measurements versus wind speed..... 20

Figure 17. Distributions of National Water Level Observation Network (NWLON) test radar sensors 6-minute water level differences in the outer station (top) and inner station (bottom).... 20

Figure 18. Monthly Primary National Water Level Observation Network (NWLON) microwave water level (MWWL) differences for all stations. 21

Figure 19. Comparison of primary and microwave water level (MWWL) data with air temperature at Marblehead, OH, in February 2021. 22

Figure 20. Locations of the sump house where the primary National Water Level Observation Network (NWLON) station is located and the microwave water level (MWWL) station at Marblehead, OH..... 23

Figure 21. Time series of primary (National Water Level Observation Network [NWLON]) and microwave water level (MWWL) differences for 6-minute, hourly, and daily values at Marblehead, OH..... 24

Figure 22. Locations of the original primary National Water Level Observation Network (NWLON) station and the microwave water level (MWWL) station at Green Bay, WI. 25

Figure 23. Time series of primary (National Water Level Observation Network [NWLON]) and microwave water level (MWWL) differences for 6-minute, hourly, and daily values at Green Bay, WI. 26

Figure 24. Locations of the primary National Water Level Observation Network (NWLON) station and the microwave water level (MWWL) station at Ogdensburg, NY. 27

Figure 25. Picture of the temporary Ogdensburg microwave water level (MWWL) station and 3-D diagram of the proposed permanent station. 27

Figure 26. Time series of primary (National Water Level Observation Network [NWLON]) and microwave water level (MWWL) differences for 6-minute, hourly, and daily values at Ogdensburg, NY. 28

Figure 27. Locations of the original primary National Water Level Observation Network (NWLON) station and the microwave water level (MWWL) station at Duluth, MN. 29

Figure 28. Time series of primary (National Water Level Observation Network [NWLON]) and microwave water level (MWWL) differences for 6-minute, hourly, and daily values at Duluth, MN. 30

LIST OF TABLES

Table 1. November 1983 Table of Standard Water Level Data Quality Assurance Procedure.....	6
Table 2. Excerpt from CO-OPS Measurement Specification (updated in 2022; Heitsenrether, et al. 2013).	6
Table 3. Stats for recent microwave water level (MWWL) comparisons at Great Lakes stations over the selected comparison periods (ranging from 4 months to 1 year).....	21

EXECUTIVE SUMMARY

The Great Lakes Water Level Measurements have been continuously taken since the 1800s. In 1970, the Great Lakes Water Level Stations carrying out those measurements were transitioned from the U.S. Army Corps of Engineers (USACE) to the newly formed National Oceanic and Atmospheric Administration (NOAA). This responsibility resides with the NOAA National Ocean Service (NOS) Center for Operational Oceanographic Products and Services (CO-OPS).

The purpose of this report is to document NOAA NOS CO-OPS multi-year evaluation and subsequent findings of use of new microwave water level (MWWL) radars as a promising long-term water level measurement sensor in the Great Lakes. As a temporary short-term (under 6 months) sensor, the sensor has been deployed many times in the Great Lakes and interconnecting rivers for hydrographic, photogrammetric, and hydraulic analysis, as well as in support of the International Great Lakes Datum 2020 Update (by both Canada and United States).

MWWL radars have also been deployed as long term sensors at locations where NOAA has had to relocate because of marine construction or site demolition and conditions are favorable for its use. The locations were Fort Gratiot, MI, Buffalo, NY, Marblehead, OH, Green Bay, WI, Ogdensburg, NY, and Duluth, MN. This report documents the comparison work accomplished at the long-term locations between the different sensor technologies. The findings from those cold environment installations show that the MWWL radar sensor meets the precision and accuracy requirements of the Great Lakes region and have been recommended for operational use.

Although measurements collected from MWWL sensors are shown to be highly accurate and precise (Park and Heitsenrether 2013), one known limitation is the sensor's inability to meet performance requirements in the presence of significant surface ice. The sensor typically experiences loss of target due to the significant change in dielectric constant from water to ice. Since ice in the lakes starts building from the shore, where these sensors will be mounted, consideration must be made for the best placement of the MWWL sensor and the associated MWWL infrastructure. The MWWL sensor can be used where the conditions permit.

1. PURPOSE

The purpose of this report is to document NOAA National Ocean Service (NOS) Center for Operational Oceanographic Products and Services (CO-OPS) multi-year evaluation and subsequent findings that the new microwave water level radars used in ocean coastal environments can be used in the Great Lakes. The sensor has been deployed many times in the Great Lakes and interconnecting rivers as a temporary sensor in support of multiple missions including: hydrographic surveys, photogrammetric surveys, hydraulic analysis, and the International Great Lakes Datum 2020 update.

2. BACKGROUND

The National Oceanic and Atmospheric Administration (NOAA) National Ocean Service (NOS) Center for Operational Oceanographic Products and Services (CO-OPS) is the authoritative source for accurate, reliable, and timely tide, water level, and other oceanographic information to support safe and efficient maritime navigation, coastal hazard preparedness and response, and sound ecosystem management. To achieve this mission, CO-OPS operates and maintains the National Water Level Observation Network (NWLON), a network of highly precise, long-term tide and water level monitoring stations along the shorelines of the United States and its territories.

The NWLON supports the essential functions of NOAA’s primary mission. Specifically, NWLON water level observations provide the foundation of the nation’s coastal vertical reference framework—that is, authoritative tidal and Great Lakes datums. NWLON observations also support many other NOAA mission areas, as well as other federal agency missions, including coastal weather forecasting, emergency response, storm surge and tsunami warnings, climate monitoring, coastal resilience planning, and habitat restoration. Required by Congress and Treaties, the observations provide a hydraulic vertical reference datum through which the governments of Canada and the United States manage the water resources in the Great Lakes Basin.

The NOAA Great Lakes Water Level Measurement Requirements date back to 1970 when the Great Lakes Stations were transitioned from the U.S. Army Corps of Engineers (USACE) to NOAA at the creation of NOAA. “In 1976 when the Lake Survey Center was closed by NOAA and transferred to Rockville, MD, some confusion existed as to the exact use and purpose of the water level program. It was widely believed that the water level measurements were exactly like tidal procedures and were used only for hydrography and some navigation” (Heitsenrether et al. 2009). Subsequent agreements with the USACE corrected these concepts. The 1983 update, on page B-4, a table provided the standard water level data quality assurance procedure. This table (recreated in Table 1 in this report) shows the required measured data quality. It states: less than or equal to 0.1 foot and less than or equal to 0.05 feet (in monthly means; Heitsenrether and Davis 2011).

Table 4 STANDARD FOR WATER LEVEL DATA QUALITY ASSURANCE PROCEDURE

Required Service	Standard	Maximum Allowable Deviation	Method of Surveillance
Collect water level data from 54 permanent water level sites including 13 special hydraulic water level gages (473,900 hrs per year).	Timeliness: <ul style="list-style-type: none"> Data from all 13 channel water level gages received by the 7th of each month. 	<ul style="list-style-type: none"> Data from 10% of the gages be up to 3 days late Data from 10% of the gages 	<ul style="list-style-type: none"> Processing “report card.” Processing “report card.”

<p>Completely process and analyze data from 54 permanent water level sites including 13 special hydraulic water level gages.</p>	<ul style="list-style-type: none"> Data from all 41 lake water level gages received by the 10th of each month. <p>Quality:</p> <ul style="list-style-type: none"> All data points are collected. All data is free of severe errors ($\geq .1$ ft, $\geq 2\text{-}1/2$ minutes for digital data, ≥ 15 minutes analog data, ≥ 30 sec. telemetry data.) <p>Timeliness:</p> <ul style="list-style-type: none"> Process 13 river channel records by the 10th of each month. Process 41 lake level records by the 20th of each month. <p>Quality:</p> <ul style="list-style-type: none"> All data is reviewed, registered, and entered into the database. No severe errors remain in the data after editing ($\geq .1$ ft. in HH, $\geq .05$ ft. in monthly means.) 	<p>may be up to 5 days late.</p> <p>$\leq 5\%$ of the data points are lost.</p> <p>$\leq 5\%$ of the data points are defective.</p> <p>$\leq 1\%$ not completed by the deadline.</p> <p>Processing may be extended for the entire set ≤ 2 non-consecutive months per year.</p> <p>$\leq .5\%$ severe errors remaining in HH after processing, $\leq .05\%$ severe errors remaining in HH after verification, $\leq .025\%$ errors remaining in the final database.</p>	<ul style="list-style-type: none"> Processing "report cards." Water level data analysis QC check. <p>COE monitoring processing log.</p> <p>COE monitoring processing log.</p> <p>2-step internal QC process. <u>Step 1:</u> data processed with QC check. <u>Step 2:</u> processing verified. <u>Final QC checks</u> - weekly COE review station mean comparisons.</p>
--	---	--	---

Note: All time deadlines are in work days unless otherwise noted.

November 1, 1983

Table 1. November 1983 Table of Standard Water Level Data Quality Assurance Procedure.

(The word "gages" is spelled as it was spelled in the original 1983 table. QC stands for QualityControl. COE stands for U.S. Army Corps of Engineers. HH stands for Hourly Heights.).

We are exceeding the accuracy shown in Table 1. The current NOAA water level measurement specification for a Great Lakes Station is shown in Table 2. Lake wide averages are officially reported monthly and annually by the International Joint Commission and US Army Corps of Engineers. These lake wide averages are reported out in hundredths of a foot.

<p>Great Lakes Water Level Stations (Primary)</p>	<p>Absolute Shaft Angle Encoder (Float)</p>	<p>BEI Model # MT-40D (Float) Part No. 802-05-0143, MT40D-X-HSS1024N-64T-XD13-X-SC14-X-12, Multi-turn Absolute-Position Encoder</p>	<p>Relative to Datum ± 0.006 m (Individual measurement) ± 0.0003 m (monthly means)</p>	<p>181 one-second water level samples centered on each tenth of an hour are averaged, a three standard deviation outlier rejection test applied, the mean and standard deviation are recalculated and reported along with the number of outliers.</p>
---	---	---	--	---

Table 2. Excerpt from CO-OPS Measurement Specification (updated in 2022; Heitsenrether, et al. 2013).

3. CO-OPS OPERATIONAL APPLICATIONS OF RADAR WATER LEVEL SENSORS

NOAA CO-OPS has been investing in the research, development, test, and evaluation of radar sensor-based water level measurement systems over the past 20 years in the coasts, ports, rivers, inlets, and harbors of the United States. These efforts are motivated by the many advantages of radar water level sensor technology and initial success of many other users throughout the international water level observing community.

The use of MWWL as a long term sensor in the Great Lakes is new. Traditionally, water levels within sumps (stilling wells) are measured using shaft angle encoders (SAEs) connected to float and counterweight systems. Microwave Water Level (MWWL) radar applications include measuring clearance beneath bridges for safe passage of ships below and measuring water levels in NOAA's long-term, real-time monitoring systems throughout the coastal United States. In 2005, CO-OPS began using radar range sensors operationally for bridge clearance measurements at Physical Oceanographic Real Time Systems (PORTS[®]) observatories starting and, in 2012, for water level monitoring throughout the NWLON and PORTS starting.

Recurring maintenance of the brick-and-mortar sump intake is carried out every 1 to 3 years by way of underwater inspections using divers to clean clogged intakes of invasive mussels or sediment. Large diameter concrete sumps are periodically drained to be scrubbed clean of sediment deposited at the base. Recurring average annual maintenance costs are about \$5K per year for fiberglass sumps and about \$10K for concrete sumps in FY22 dollars.

The MWWL radar may be another tool in the Great Lakes tool box. By doing this study, we are able to explore the use of all the approved water level sensors in use. The MWWL radars have been installed in existing sumps and outside of sumps in open waters. With MWWL radars, CO-OPS has been exploring whether or not we can reduce our initial and recurring annual costs over the life of the station. Through this experience and the experience of many other users throughout the international water level observing community with radar water level sensor technology, we may be able to improve our capability.

Since 2009, starting at Fort Gratiot, MI (Heitsenrether et al. 2009), CO-OPS has been examining the use of WaterLog[®] MWWL sensors in the Great Lakes. In 2013, CO-OPS' Ocean Systems Test and Evaluation Program (OSTEP) conducted a 4-month field test in Buffalo, NY, to support use of MWWL for Great Lakes seasonal and V-Datum gauge applications. Early tests showed excellent comparisons between the existing water level technology—BEI Precision shaft angle (optical) encoders—and the MWWL sensors with monthly mean differences +/- 0.5 cm.

The first longer-term MWWL installation was at Marblehead, OH, in May 2018 to evaluate alternative water level technologies in the Great Lakes region due to concern of potential failure of the existing sump/intake system. Three additional MWWL sensors were installed in 2020-2021 because of imminent construction at the existing NWLON stations, including Green Bay, WI, Ogdensburg, NY, and Duluth, MN. These stations are all well-protected stations that are mostly free of ice and where MWWL radar sensors were considered the most cost effective water level sensor. This assessment on a case-by-case, site-by-site basis documented the performance (precision and accuracy), environmental and infrastructure conditions, and cost benefit requirements for deciding whether or not a MWWL radar can or should be used. These four stations have been undergoing data comparisons since 2018-2020 and show monthly mean differences with the accepted tolerances of +/- 1 cm per NWLON Requirements (Lippincott 1978). The results are outlined in this report.

Large diameter concrete sumps (stilling wells), while desired, are not feasible and are very expensive to maintain at some stations. MWWL radars do not require stilling wells and can be deployed in open air systems. MWWL radars have also been used by CO-OPS for temporary locations with good results, including vertical datum and International Great Lakes Datum (IGLD) control, and used by the USACE for hydraulic step analysis in the interconnecting rivers. Additionally, MWWL sensors allow new capabilities to measure 1-minute water levels and better resolve meteotsunami and wind wave observations.

4. MICROWAVE RADAR CONFIGURATION AND SETUP

Measurements from all field test results presented here were collected with a Xylem\YSI Waterlog radar sensor interfaced to a Hach\Hydromet Sutron Xpert data logger. Data presented from 2008 through 2017 were collected using the H3611 model radar, and data from approximately 2017 to date were collected using the H3611 model replacement, the NOAA Nile. For the purposes of data analysis and summary presented here, the 2 models can be considered as capable of collecting identical measurements.

The installation was accomplished per the CO-OPS Microwave Radar Water Level Sensor: Field Installation Guide (Morris 1983). This is important because this means that for all field data, For all field data, the Waterlog radar sensors' "Process Condition" configuration parameter was set to "FastChange" and the "Dampening" set to 0 seconds. Radar sensors were configured to the Xpert data logger via SDI12 interface, and raw range to water surface data were measured and logged at a 1 Hz rate. CO-OPS' standard Data Quality Assurance Processing (DQAP) algorithm was applied to generate 6-minute range averages:

- calculate mean and standard deviation of 360, 1 Hz samples centered on the sample time;
- remove any points +/- 3 standard deviations from the mean; and
- recompute mean following wild point removal; record number of points removed for each sample.

All field systems were equipped with both a Geostationary Operational Environmental Satellite (GOES) transmitter and cellular modem for real-time data telemetry. Six-minute average measurements were transmitted, near real-time, at the same 6-minute rate. A sensor offset (obtained in laboratory) and datum offset (obtained from level survey) are applied to the raw range data following ingestion of transmitted data into CO-OPS data server.

For CO-OPS vertical referencing methods, the radar sensor's survey reference point is at the base of the sensor's circular mounting flange (Figure 1). Although the vendor claims that this location is equivalent to the sensor's 0 range point, experience has indicated that the location of sensor 0 varies slightly for each individual sensor and can be several millimeters or more above or below that point. For this reason, CO-OPS conducts a series of laboratory measurements using a special reference mount to determine the true location of the sensor's 0 range location relative to the survey reference point shown in Figure 1. This value is referred to as the sensor offset (SO).



Bob Heitsenrether, 2013
 Robert.Heitsenrether@noaa.gov

Figure 1. Waterlog radar sensor's survey reference point location

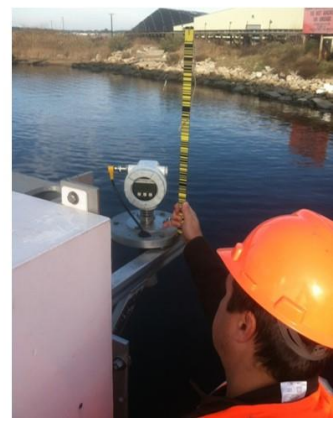
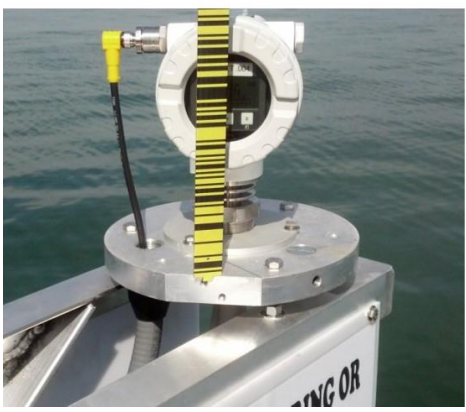
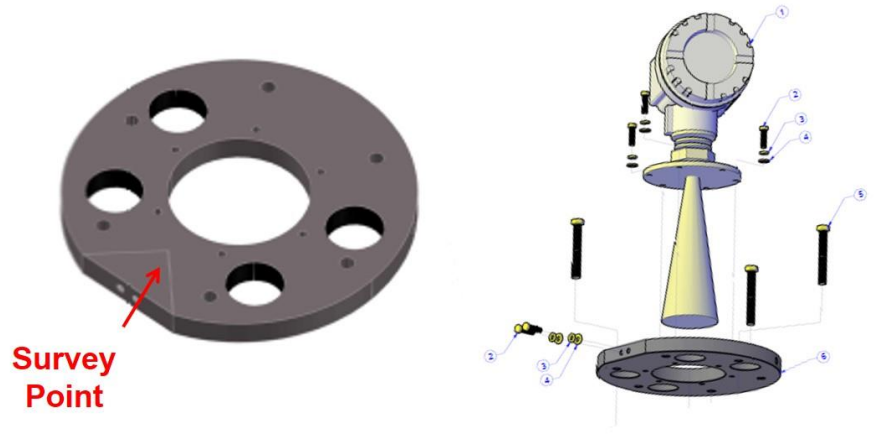

Figure 2. Radar sensor survey collar drawing and field level survey process photos.

5. INITIAL GREAT LAKES MICROWAVE RADAR FIELD TESTS

Significant accomplishments completed during initial microwave radar sensor testing in the Great Lakes are summarized in this section. Results from CO-OPS' early Great Lakes radar water level field test efforts, conducted from 2008-2013, have been reported in various sections of multiple documents over the years, all of which cover broader CO-OPS radar water level sensor efforts (NOAA NOS CO-OPS 2013, 2017, 2020; Park and Heitsenrether 2013; Park et al. 2014). The purpose of this section is to provide a comprehensive summary of key results from all early Great Lakes region test efforts, in one location.

For the first time, this section documents these early Great Lakes NWLON station results from the first phase of MWWL radar test and evaluation efforts. From 2009-2010, MWWL radar tests and evaluations were conducted at the Fort Gratiot, MI, station on Lake Huron; and in 2013 at the Buffalo, NY, station on Lake Erie. Results from the 2013 Buffalo, NY, test led to wider operational use of radar water level sensors throughout the Great Lakes but only for short-term (May through October) seasonal gauging applications.

5.1 First Test Location: Fort Gratiot, MI

CO-OPS OSTEP's first phase of radar water level sensor field testing commenced during the 2008-2009 timeframe with the installation of radar sensor test platforms at 4 NWLON station sites (NOAA NOS CO-OPS 2013, 2017). One of these initial field test locations included an NWLON site in the Great Lakes—Fort Gratiot, MI. This NWLON station is located on the southern banks of Lake Huron (Figure 3). The station consists of a typical Great Lakes gauge house setup installed at the edge of the shoreline with an in-ground cylindrical concrete well connected to an intake on the lake, all enclosed in a small brick building which contains heat lamps. All of the NWLON station's water level sensor and data collection platform (DCP) components are located inside of the gauge house. The primary sensor at this site, which was used as the reference for the test radar sensors, is a BEI float/shaft angle encoder system with a float that rests on the water surface in the well. The site also includes a suite of standard meteorological sensors installed on a mast just outside of the gauge house (Figures 2-5).

During CO-OPS' initial phase of radar water level sensor field testing, 4 make/model sensors were being evaluated. As such, a multi-sensor test platform including all 4 sensor types was deployed at the Fort Gratiot, MI, site. The four radar sensors were installed in a prototype mount, below the gauge house floor, aiming directly downward to measure water level within the gauge house well (Figures 4-7). Figure 5 shows the added frame over the Fort Gratiot sump before the MWWL installation, as viewed from inside the gauge house looking downward into the in-ground well. Figure 6 was taken from the same perspective as Figure 5 showing the completed sensor mounting frame with the sensor platform installed.

During the time period of initial radar water level sensor testing, OSTEP was still in the midst of sensor familiarization and learning to optimize radar sensor software configurations, filtering and averaging algorithms, prototype mounting hardware, and level survey and vertical reference techniques. During initial months of radar sensor test data collection at the Fort Gratiot station, several changes and modifications were made to the sensors and test platform throughout the test period. As such, results were considered preliminary and not sufficient to support wider operational use of radar sensors for long term measurements inside gauge house wells. However, results from the one particular sensor that CO-OPS ultimately selected for operational use for ocean coast applications, the Waterlog H3611, showed very promising initial results and led to an

expectation that results from further testing in a similar application have a high likelihood of meeting NWLON performance requirements.

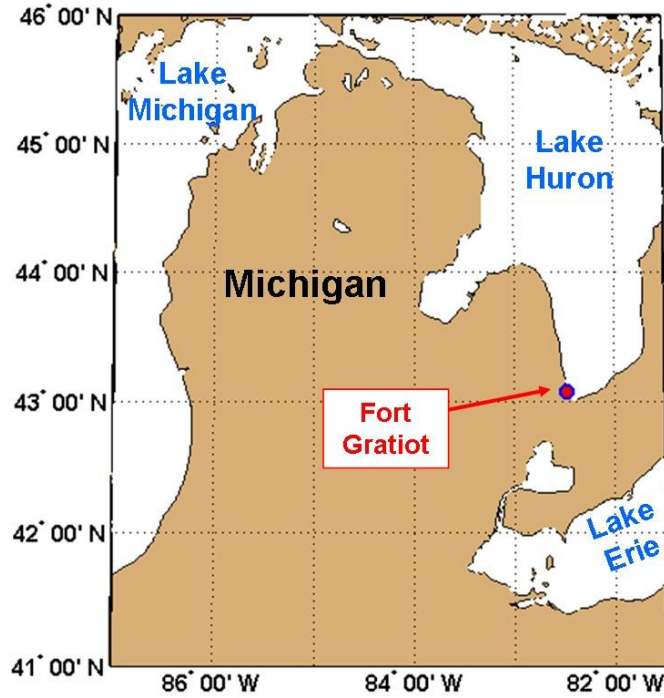

Figure 3. Location of Fort Gratiot, MI, field test site.



Figure 4. Fort Gratiot, MI, (gauge house atop the concrete well) leveling survey.

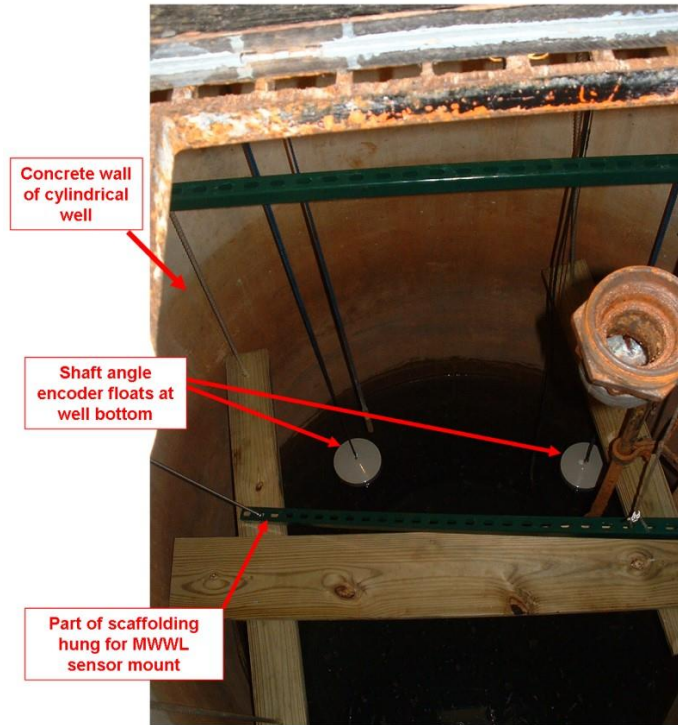

Figure 5. Fort Gratiot, MI, Microwave Water Level (MWWL) mounting frame.



Figure 6. Fort Gratiot, MI, Microwave Water Level (MWWL) installation inside sump.

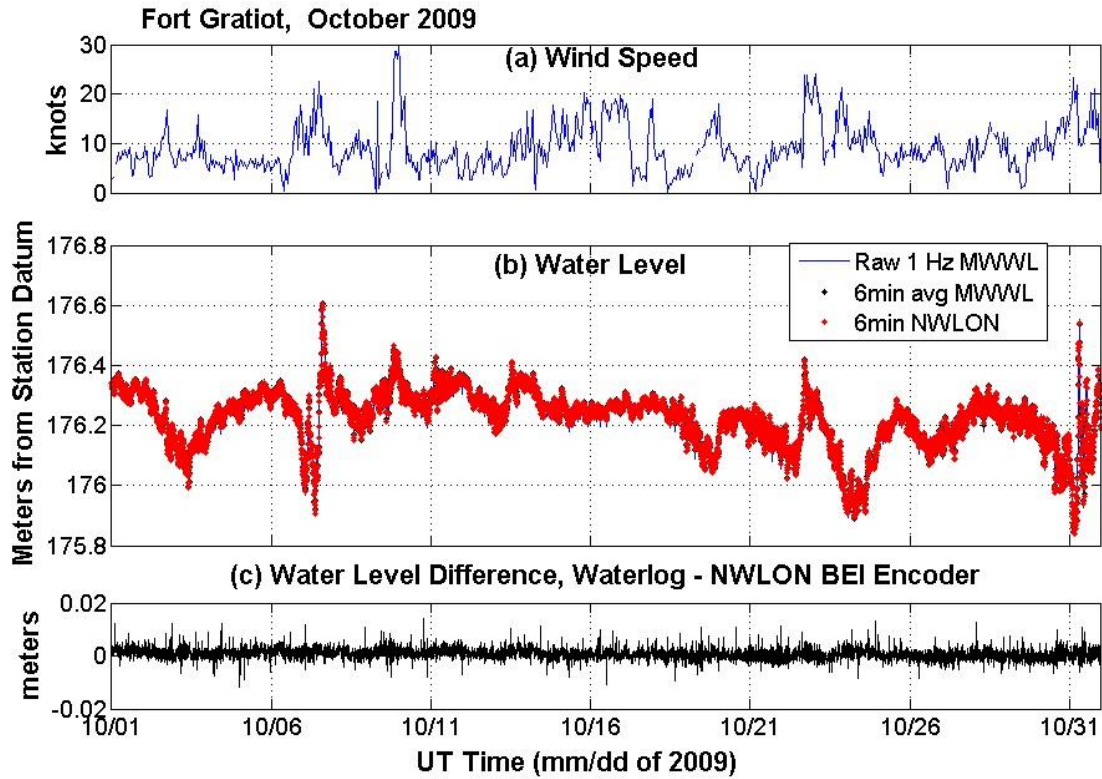

Figure 8. October 2009 time series of (a) hourly wind; (b) water levels, 1-Hz WaterLog® (blue line), 6-min average WaterLog® (black dots), and BEI (red dots); and (c) WaterLog® versus BEI Δ WL at the Fort Gratiot, MI, National Water Level Observation Network (NWLON) site.

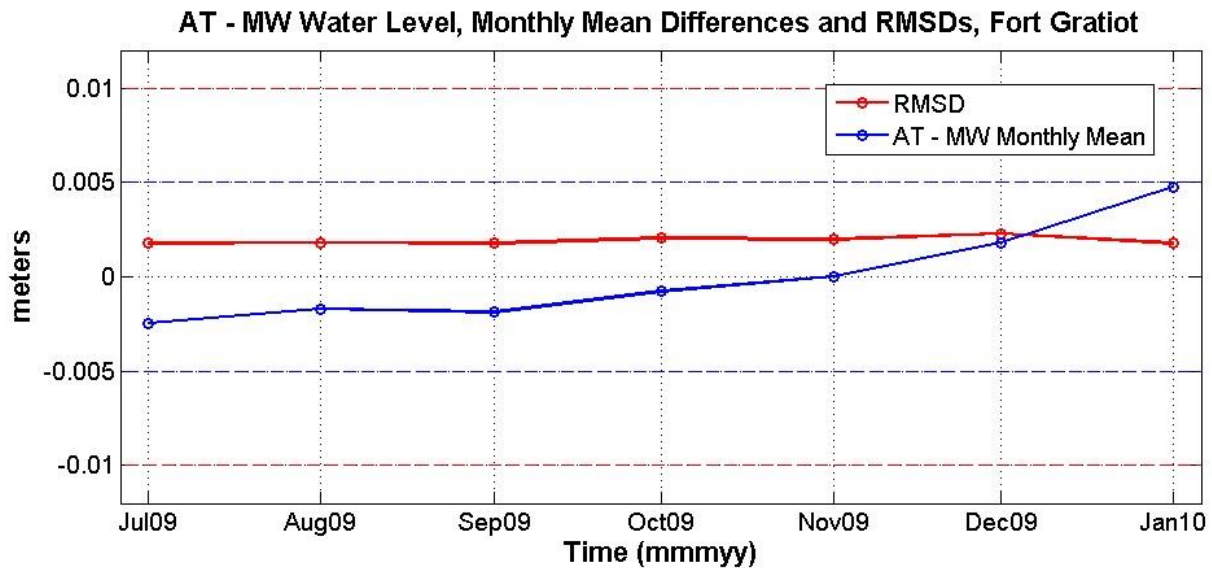

Figure 9. Monthly root mean square differences (RMSDs) between WaterLog® and BEI 6-min water level series (red) and differences between WaterLog® and BEI monthly mean water levels (blue).

5.2 Second Test Location: Buffalo, NY

In 2012, CO-OPS started to gain interest in the possibility of using radar water level sensors in the Great Lakes for short-term seasonal and VDatum gauge applications for the purpose of datum determination. In order to further assess the suitability of using the relatively new (at the time) water level sensing technology, OSTEP conducted a 4-month field test with 2 radar water level sensor based systems at the Buffalo, NY, NWLON station from May-October 2013.

The Buffalo NWLON station was selected as the test site for a radar based seasonal gauge for several reasons, including:

- The region is representative of a typical Great Lakes seasonal gauge installation site.
- The site is easy to access, and travel is relatively simple and low cost.
- The site is located on a U.S. Coast Guard (USCG) base, offering a secure location for the outdoor test system installation.
- The sump intake is right along an accessible section of seawall, allowing easy collocation of the radar sensor's water surface measurement location.

Figure 10 includes 2 map views that show the Buffalo NWLON station's location on Lake Erie and a benchmark diagram that covers the area of the USCG base. Figure 11 shows a series of pictures taken at the station site. The first 2 pictures show a view of the gauge house; the look directions are approximately northward and westward in (a) and (b), respectively. The gauge house's well intake is located approximately 18 feet beneath the top of the seawall or 12 to 13 feet below the present water surface. It is a 6-inch diameter intake pipe that protrudes 3 inches through the face of the seawall. Approximate location is seen to the right of the gauge house in Figure 11(b).

For reasons discussed in Heitsenrether (2013), it was decided to install 2 test radar gauges at this test site in 2 locations: 1) on the outer sea wall, directly over the sump intake and 2) along a bulkhead inside the protected USCG station harbor. Figures 11-13 show the locations and installations of the 2 systems, hereinafter referred to as the "inner" and "outer" station, respectively.



Figure 10. Location of Buffalo, NY, National Water Level Observation Network (NWLON) station.

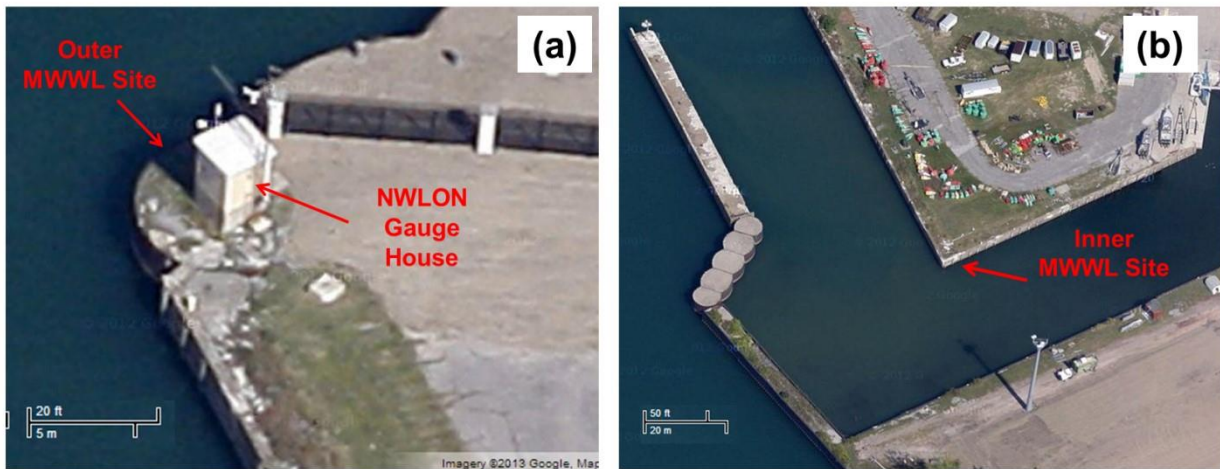

Figure 11. Zoomed in Google Maps view of Buffalo, NY, National Water Level Observation Network (NWLON) station, with locations of the 2 radar water level test systems annotated.

Inner System



Outer System



Figure 12. Photos of the two radar water level test systems following installation.



Figure 13. Level survey immediately following installation.

Figure 14 shows the water time series of each station, along with reference water levels from the NWLON station's primary sensor, the BEI float/shaft encoder system, and wind speed

from the NWLON meteorological station. An initial qualitative look at time series plots shows water levels from both test systems, and the reference NWLON compares excellently.

Figure 15 shows the sample of 6-minute test radar results for June, the first month of testing: wind speed (top); 6-minute water level differences, National Water Level Observation Network (NWLON) inner test radar (middle); 6-minute water level differences, NWLON outer test radar (bottom). The results compare excellently.

Figure 16 shows scatter plots of the radar sensors' 1 Hz range standard deviations (6-minute windows) versus corresponding wind speed. The correlation between wind speed increases and higher standard deviations of the outer test radar station indicates that the sensor resolved more high frequency water surface roughness associated with wind generated gravity waves. This was expected based on the stations' locations—outer sea wall versus inner harbor. Regardless, averaged water level values from both test radar gauge stations compared excellently with those from the reference NWLON sensors.

Figure 17 shows the distribution of 6-minute NWLON test radar water level differences for both stations, along with the average and RMSDs. Results show that from both stations, 6-minute NWLON radar differences were within +/- 2 cm more than 95 % of the time. The average NWLON radar difference over the entire test period was 0 mm for the outer station and 8 mm for the inner station. The slightly larger difference for the inner station is likely a result of being farther away from the NWLON station sump intake where the primary water level sensor will respond to water level changes. The significantly high precision between the reference NWLON sensor and test radar sensors summarized in Figure 15 led to wider operational use of radar water level sensors throughout the Great Lakes for short-term seasonal gauging applications.

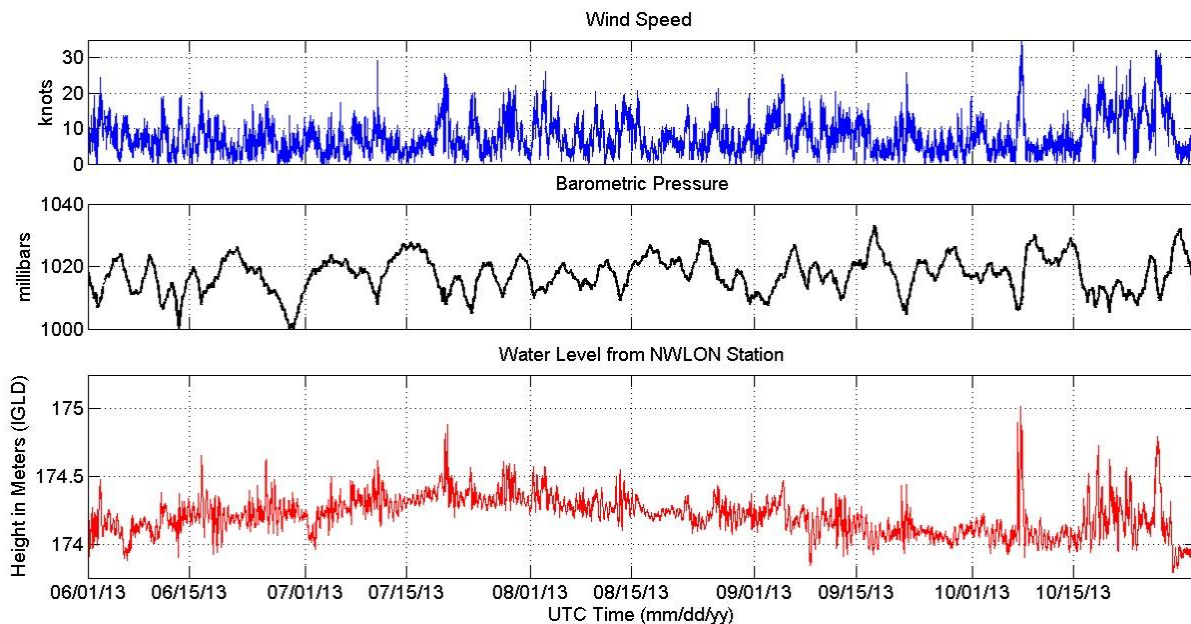

Figure 14. Meteorological and water level data recorded at the National Water Level Observation Network (NWLON) station over the entire course of the test period, Jun 1-Oct 31, 2013

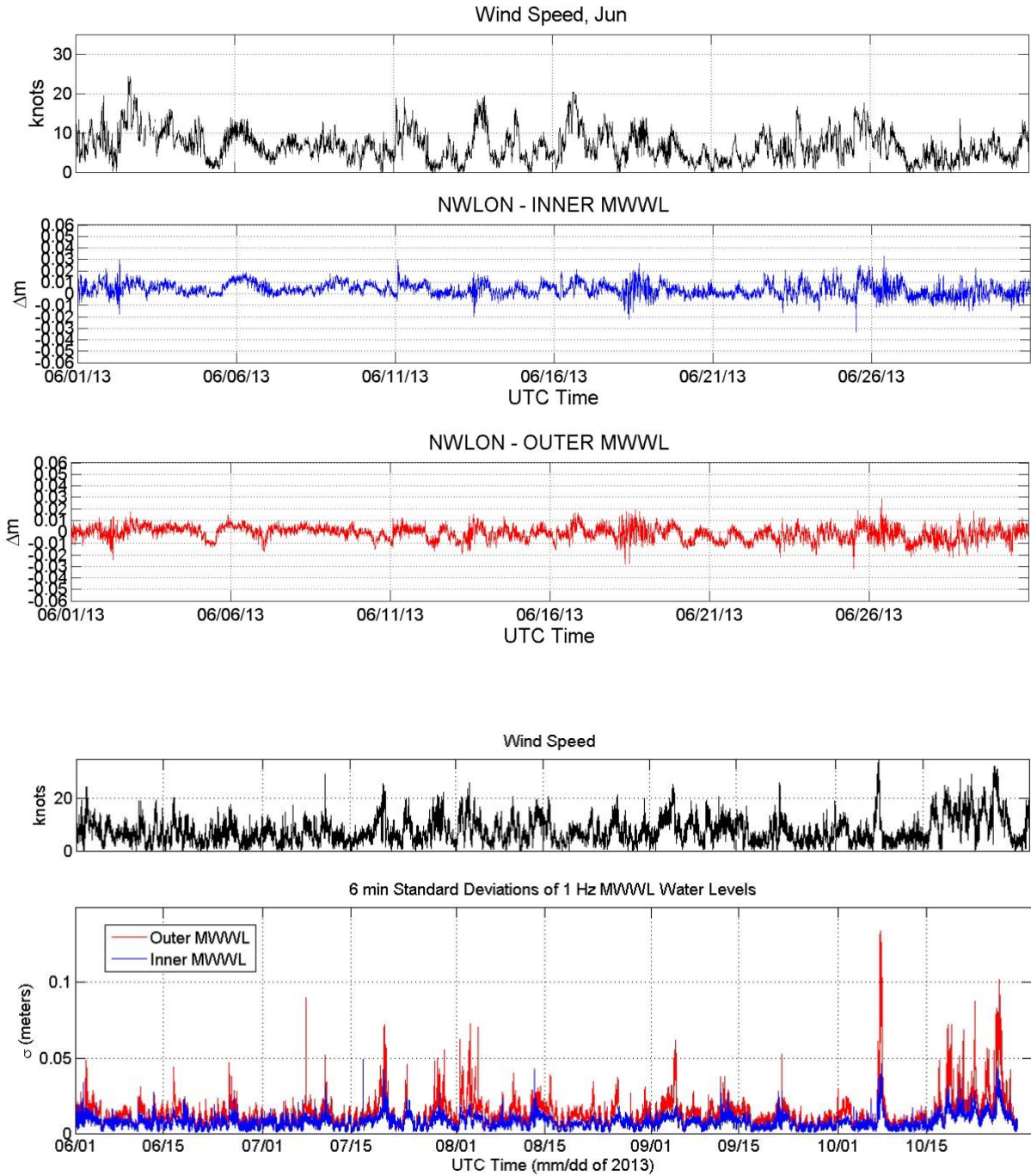

Figure 15. Sample of 6-minute test radar results for June, the first month of testing: wind speed (top); 6-minute water level differences, National Water Level Observation Network (NWLON) inner test radar (middle); 6-minute water level differences, NWLON outer test radar (bottom).

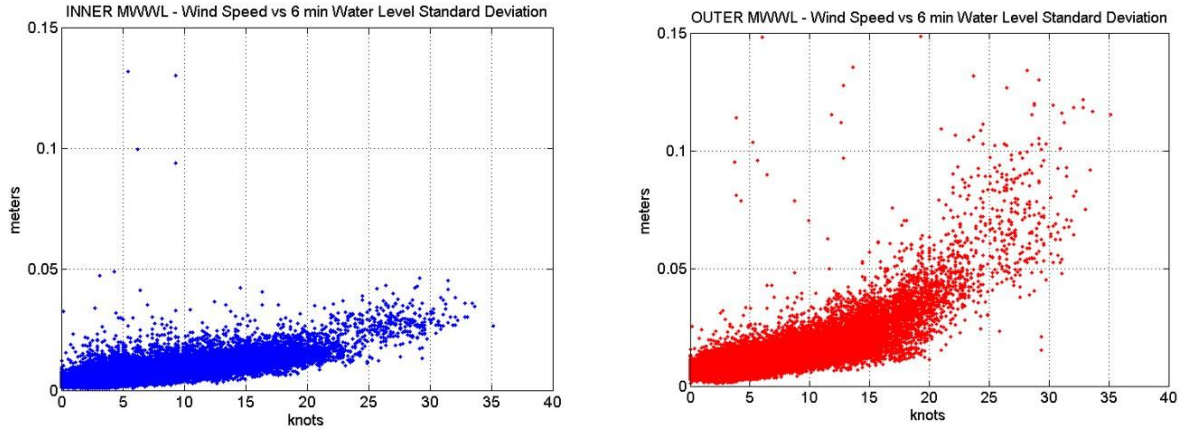

Figure 16. Comparisons of inner versus outer test radar sensors 6-minute tests with standard deviations of 1 Hz measurements versus wind speed.

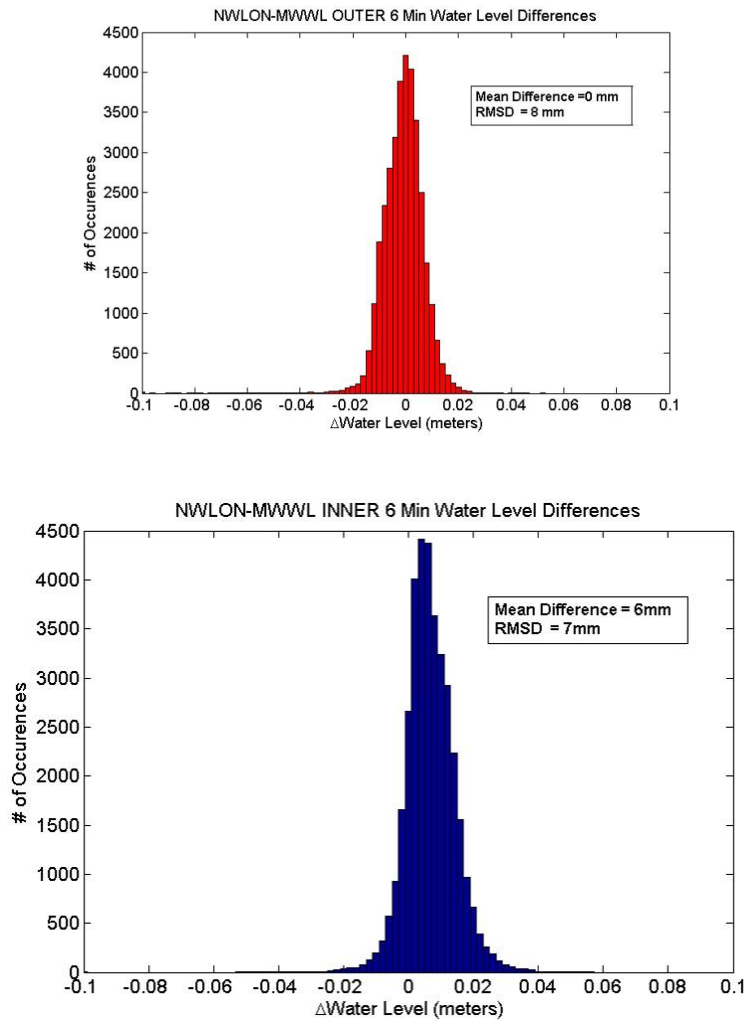

Figure 17. Distributions of National Water Level Observation Network (NWLON) test radar sensors 6-minute water level differences in the outer station (top) and inner station (bottom).

6. RECENT MICROWAVE RADAR COMPARISONS

More recently, CO-OPS has been conducting routine comparison analyses on radar water level sensors that are installed year round in the Great Lakes. As of 2022, there are 4 “long-term” microwave radar water level sensors installed at the following NWLON stations: Marblehead, OH, Green Bay, WI, Ogdensburg, NY, and Duluth, MN. Overall mean NWLON MWWL differences at these 4 stations were +/- 0.1 cm at all stations except Marblehead, OH, where average differences were 1.2 cm (Table 3). Monthly average primary-MWWL differences range from -0.8 to +1.4 cm per month (Figure 18). In comparison, CO-OPS has been conducting routine comparison analyses on NWLON coastal stations since 2011, and overall mean primary NWLON-MWWL differences at coastal stations range between 0-3 cm. Because coastal stations are exposed to larger water level changes, differences are expected to be larger.

Station	Comparison Period	6-Min Mean Difference (cm)	Standard Deviation (cm)	RMS (cm)
9063079 Marblehead, OH	Dec 2020 - Nov 2021	+1.2	0.8	1.4
9087077 Green Bay East, WI	Jul - Oct 2020	-0.1	0.9	0.9
8311030 Ogdensburg, NY	Dec 2020 - Nov 2021	+0.0	0.6	0.6
9099064 Duluth, MN	Jan - Jul 2021	-0.1	0.7	0.7

Table 3. Stats for recent microwave water level (MWWL) comparisons at Great Lakes stations over the selected comparison periods (ranging from 4 months to 1 year).

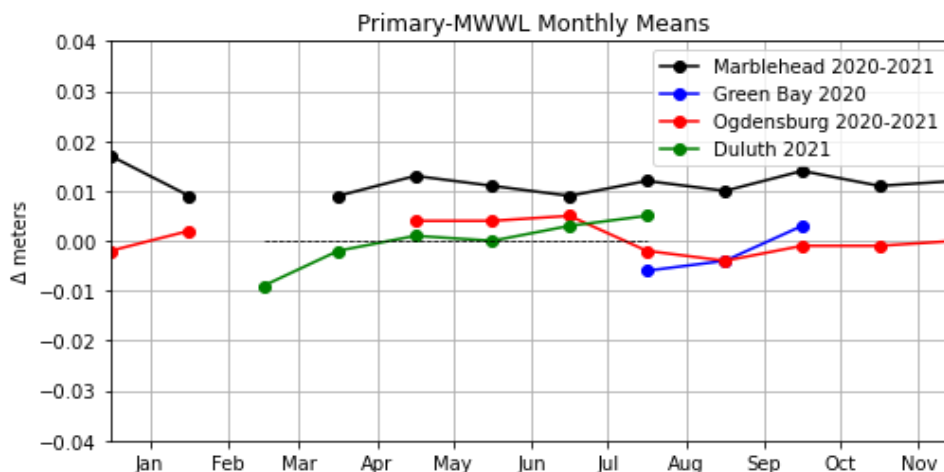

Figure 18. Monthly Primary National Water Level Observation Network (NWLON) microwave water level (MWWL) differences for all stations.

CO-OPS has observed that the MWWL radar measurements are susceptible to interference by excessive rain, marine vegetation, and water surface icing (NOAA NOS CO-OPS 2013). As a result, we conduct additional analyses on MWWL data quality during excessive rain and winter season conditions. CO-OPS analyzes available air and water temperature data to assess the conditions during periods of icing and flag MWWL data impacted by icing to estimate the percentage of suspect data during the winter.

The purpose of these comparison analyses is to ensure data and datum continuity at CO-OPS water level stations when sensor technology is changed. Our standard for ensuring continuity is completing an approximate 12-month comparison of data from the new MWWL sensor and the existing primary sensor before the MWWL sensor can be transitioned to operations, ultimately replacing the previous primary sensor technology.

6.1 Comparison Methods

CO-OPS conducts routine monthly analyses on 6-minute data from both the primary and microwave radar water level sensors. These analyses include simultaneous comparison plots of 6-minute primary and MWWL sensor data relative to station datum. Monthly (and full-period) mean differences, standard deviation, and root mean square (RMS) error are also generated, along with histograms and scatter plots of primary versus MWWL data. For this report, we used the most recent full year of comparison data up to 1 year for ease of comparison across stations. However, multiple years of comparison data are available for some of these stations.

To analyze impacts from icing, our routine analysis includes assessing the average number of days per year where temperature is below 32° F (0°C), where air and/or water temperature data is available. We also assess the percentage of suspect MWWL data due to icing for each month during the winter. When the MWWL sensor is impacted by icing, the data deviates from the primary sensor data and occasionally flatlines. For example, MWWL data at Marblehead, OH, was impacted by icing during February 2021 (Figure 19). The largest primary-MWWL deviations correspond to when air temperatures were mostly below 0°C.

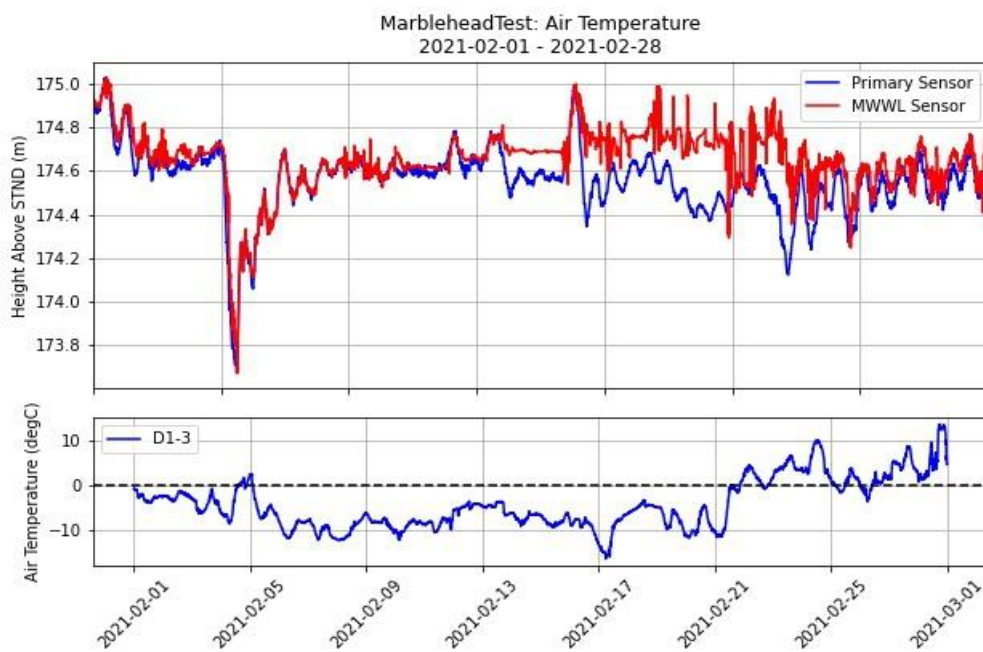

Figure 19. Comparison of primary and microwave water level (MWWL) data with air temperature at Marblehead, OH, in February 2021.

6.2 Marblehead, OH

The first longer-term MWWL installation in the Great Lakes was at Marblehead, OH, in May 2018. This site was chosen to further evaluate alternative water level technologies in the Great Lakes region after a 2015 station inspection found a severe crack in the sump/intake permitting USCG vessel wakes to impact the measurements. This location was also selected for a microwave radar installation due to its relative southern position, available space, and existing condition. NOAA also installed a dual pressure system the following year for the evaluation of additional alternative technologies. At the Marblehead station, the microwave was installed as a test setup and is located outside of the sump house on the other side of the concrete pier (Figure 20).

For easier comparison of station data, a full year of comparison data was selected from the almost 4 years of data we have collected thus far. Average primary-MWWL differences over this period (December 2020 to November 2021) were 1.2 cm (Figure 21), which is higher than what is seen at other Great Lakes stations, likely due to the station setup outlined above. We also see differences in the water level readings from the 2 SAEs at this station because they are located in separate wells. Average primary-2nd SAE differences were -0.8 cm over this same time period. The standard deviation and RMS of primary-MWWL differences were 0.8cm and 1.4 cm over the comparison period, respectively. Monthly average primary-MWWL differences range from +0.9 cm to +1.4 cm per month. MWWL data in January 2021 was impacted by icing and thus was removed from this analysis. Impacts from icing were noted again in MWWL data beginning January 2022.



Figure 20. Locations of the sump house where the primary National Water Level Observation Network (NWLON) station is located and the microwave water level (MWWL) station at Marblehead, OH.

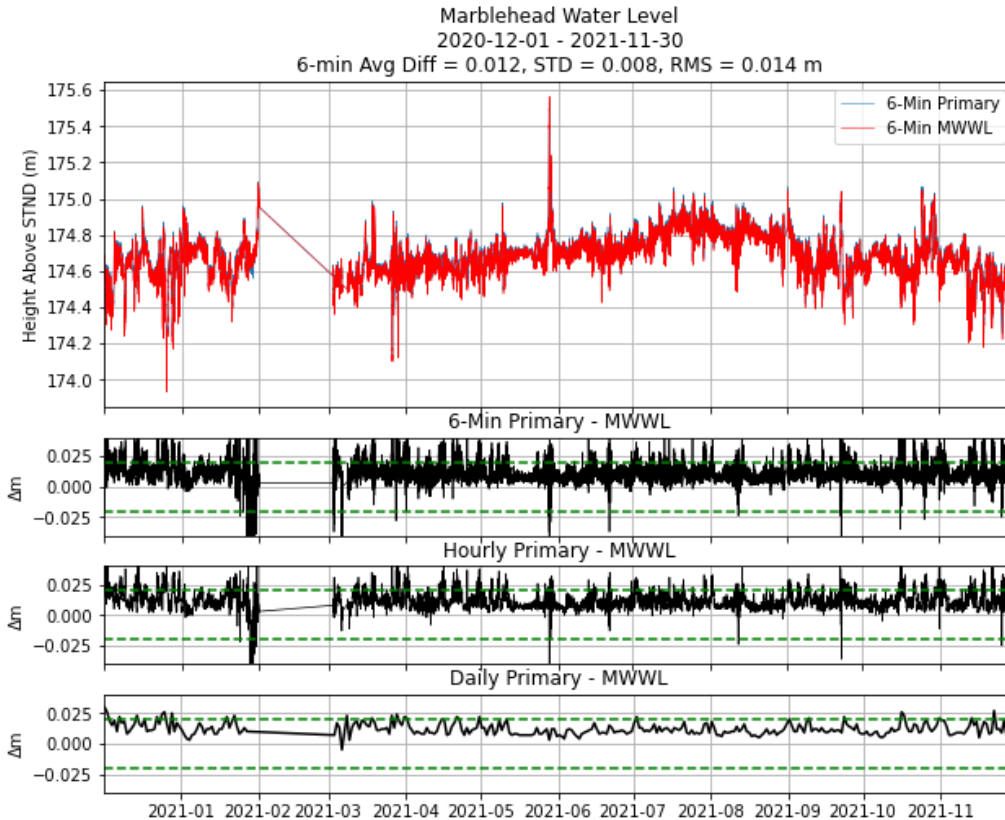

Figure 21. Time series of primary (National Water Level Observation Network [NWLON]) and microwave water level (MWWL) differences for 6-minute, hourly, and daily values at Marblehead, OH.

6.3 Green Bay East, WI

The second long-term MWWL installation in the Great Lakes was at Green Bay, WI, in June 2020. NOAA received a lease termination letter from the property owner in March 2020 and NOAA installed a MWWL sensor as quickly as possible at a nearby marina, approximately 0.5 kilometers across the river from the original location (Figure 22). The ease of installation of the MWWL sensor compared to a traditional Great Lakes station is the only reason NOAA had any data comparisons at all for this relocation. The marina location was also selected due to a submersible bubbler system they have in place that helps keep the area free of ice. There was also short-term (4-month) installation of a WaterLog® encoder just outside of the marina in 2009, providing an initial set of comparison data and confidence in the MWWL sensor as a reliable option at this location.

While only 4 months of data overlap occurred from July to October 2020, the data agreed well with average primary-MWWL differences of -0.1 cm (Figure 23). The standard deviation and RMS of primary-MWWL differences were both 0.9 cm over the comparison period. Monthly average primary-MWWL differences range from -0.8 to +0.6 cm per month. The station is currently also equipped with a bubbler pressure sensor as a backup.



Figure 22. Locations of the original primary National Water Level Observation Network (NWLON) station and the microwave water level (MWWL) station at Green Bay, WI.

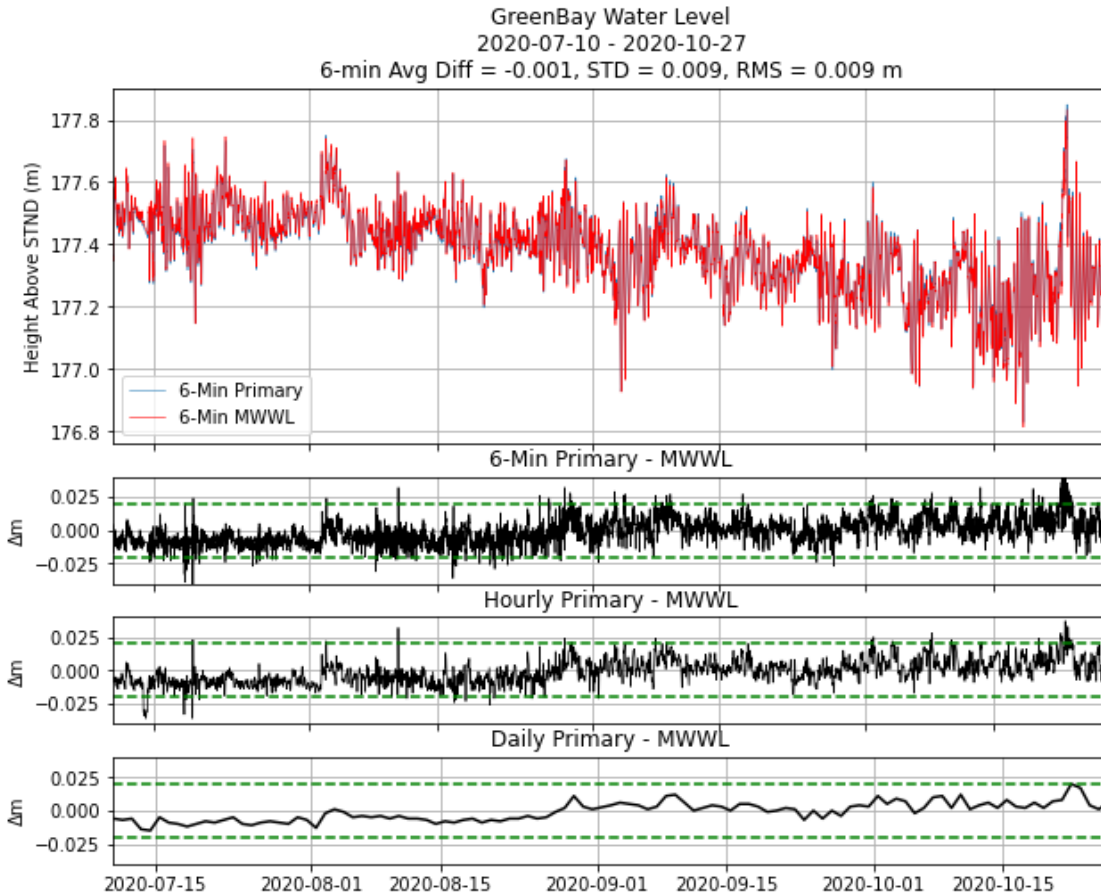

Figure 23. Time series of primary (National Water Level Observation Network [NWLON]) and microwave water level (MWWL) differences for 6-minute, hourly, and daily values at Green Bay, WI.

6.4 Ogdensburg, NY

The third long-term MWWL installation was at Ogdensburg, NY, in September 2020. This installation was originally a temporary install to accommodate demolition and construction of the old gauge house and sump. However, the reconstruction project was canceled after a significant cost increase, and upgrading the temporary site to a permanent status became our best alternative plan and is currently underway. The temporary MWWL was installed about 0.5 kilometers away from the sump house where the original station is installed at the U.S. Customs and Border Protection (CBP) property (Figure 24). The proposed configuration of the permanent MWWL station, as reviewed by the New York Power Authority (NYPA), International Joint Commission, and General Services Administration (CBP property owner), is shown in Figure 25.



Figure 24. Locations of the primary National Water Level Observation Network (NWLON) station and the microwave water level (MWWL) station at Ogdensburg, NY.

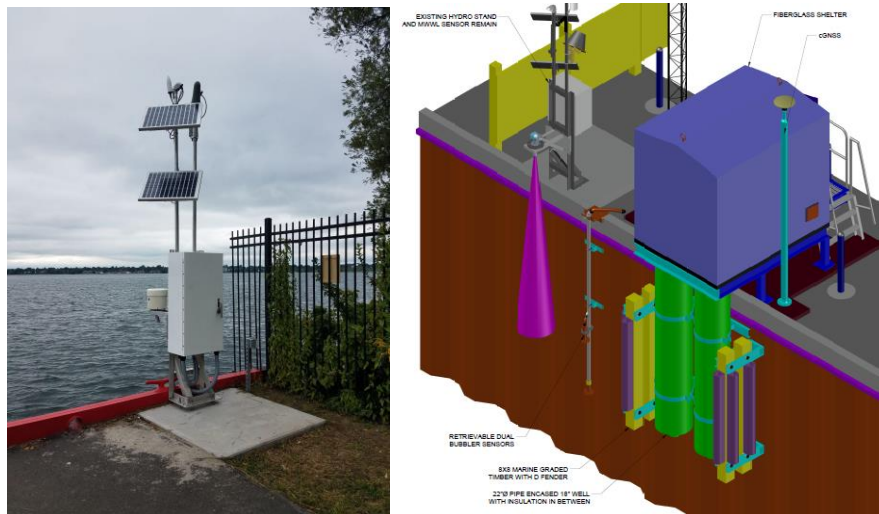

Figure 25. Picture of the temporary Ogdensburg microwave water level (MWWL) station and 3-D diagram of the proposed permanent station.

Average primary-MWWL differences over a full year comparison period from December 2020 to November 2021 were +0 cm (Figure 26). The standard deviation and RMS of primary-MWWL differences were both +0.6 cm over the comparison period. Monthly average primary-MWWL differences range from -0.4 to +0.4 cm per month. MWWL data from January to March

2021 was impacted by icing and thus was removed from this analysis. The MWWL data was again impacted by icing beginning January 2022.

The permanent NWLON station design will include an insulated fiberglass shelter on an elevated frame with 2 double-walled fiberglass sumps underneath. CO-OPS will install an SAE and an Electronic Tape Gauge (ETG) in 1 well, and the second well will be designated for use by the NYPA. The NYPA plans to operate an SAE and bubbler system in their well. In addition to maintaining the MWWL sensor, CO-OPS plans to install a dual-pressure gauge water level measuring system outside of the house, independent of the well system (Figure 25).



Figure 26. Time series of primary (National Water Level Observation Network [NWLON]) and microwave water level (MWWL) differences for 6-minute, hourly, and daily values at Ogdensburg, NY.

6.5 Duluth, MN

Another MWWL sensor was installed at Duluth, MN, in December 2020 as a temporary gauge. This sensor was installed at the USCG property approximately 0.5 kilometers south of the NWLON site (Figure 27). USACE is rebuilding the seawall, and this will impact the permanent gauge operation for a period of time. The temporary gauge will minimize any loss of data.

Average primary-MWWL differences from January to July 2021 were -0.1 cm (Figure 28). The standard deviation and RMS of primary-MWWL differences were both +0.7 cm over the

comparison period. Monthly average primary-MWWL differences range from -0.8 to +0.4 cm per month.



Figure 27. Locations of the original primary National Water Level Observation Network (NWLON) station and the microwave water level (MWWL) station at Duluth, MN.

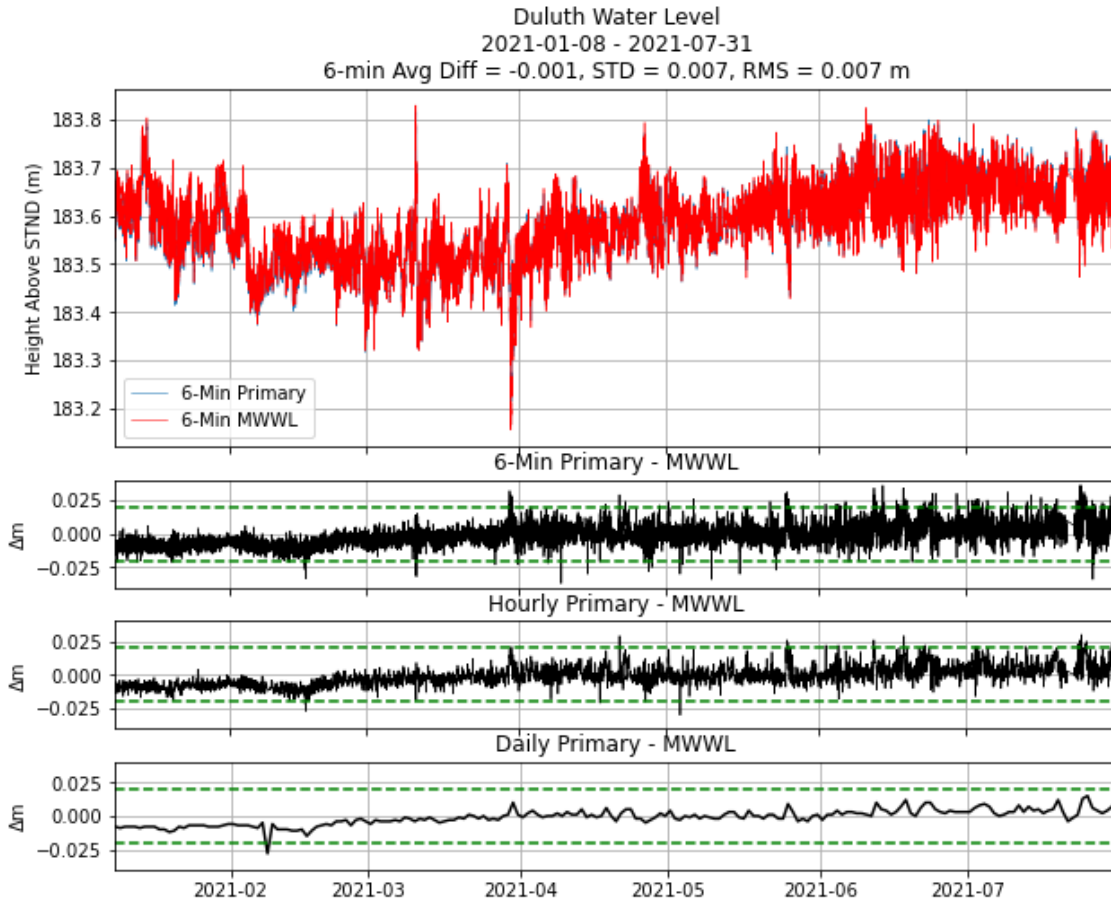

Figure 28. Time series of primary (National Water Level Observation Network [NWLON]) and microwave water level (MWWL) differences for 6-minute, hourly, and daily values at Duluth, MN.

7. RECOMMENDATIONS

- a) Whenever the opportunity arises, present the results of our findings and promote the situational use of MWWL to our counterparts on the Regulatory Committee(s) and the International Joint Commission in order to build consensus.
- b) Include potential longer term (3- to 5-year) comparisons conducted in the future—sensor drift, icing impacts over multiple winter seasons, need to discuss with Canada for cross-lake pairing.
- c) Continue analysis and development of methods for detecting and handling ice-induced issues that may occur at an operational radar sensor installation, including methods for automated error detection and classification in radar sensor data records and standard procedures for changing to an alternative/backup sensor (for example, pressure) during periods of intermittent ice cover.

8. CONCLUSION

The Microwave Radar Water Level is a sensor and an excellent tool that can meet water level requirements for the Great Lakes and coastal regions of the United States on a case-by-case

basis as environmental conditions permit or within protected sumps. It has been successfully used for spring, summer, and fall hydrographic surveys in the lakes and hydraulic step measurements in the interconnecting rivers. While it is susceptible to interference from shore fast ice and slush ice conditions during seasonal winter conditions when navigation channels are closed to marine traffic, it is an acceptable tool for measuring water levels in the Great Lakes.

9. REFERENCES

- Bushnell, M. 2007. Microwave water level sensor operational capability test and evaluation plan. US Dept Commer NOAA NOS CO-OPS Technical Report No. 052.
- Heitsenrether R, Bushnell M, Krug W. 2009. Microwave water level sensor test and evaluation interim report 1. US Dept Commer NOAA NOS CO-OPS Technical Report No. 054.
- Heitsenrether R and Davis E. 2011. Test and evaluation report: limited acceptance of the design analysis WaterLog® H-3611i Microwave Radar Water Level Sensor. US Dept Commer NOAA NOS CO-OPS Technical Report No. 061. 97 p. Accessible at: https://tidesandcurrents.noaa.gov/publications/Technical_Report_NOS_CO-OPS_061.pdf
- Heitsenrether R, Krug W, Oyler J, Haith C. 2013. Field test installation plan – microwave radar-based seasonal water level gauge in the Great Lakes. US Dept Commer NOAA NOS CO-OPS internal report. Available upon request: <https://drive.google.com/file/d/1mw6-UZv78xxOib2I816mKzR73BmO5H1h/view>
- Lippincott HA. 1978. Great Lakes water levels standard operating procedures. Great Lakes Acquisition Unit, N/OMA1211.
- Morris P. 1983. Great Lakes water levels historical scope and program authority. Office of Oceanography and Marine Services, National Ocean Service, Water Level Section. N/OMS124.
- NOAA NOS-CO-OPS. 2013. Ocean systems test and evaluation program, microwave radar water level sensor: field installation procedures for Design Analysis WaterLog® H3611i Microwave Radar Water Level Sensor using the Sutron Data Collection Platform. Version 1.0
- National Water Level Observation Network Requirements, NOAA NOS CO-OPS, October 16, 2018, Version 1.1.
- NOAA NOS CO-OPS. 2020. Environmental measurement systems: sensor specifications and measurement algorithms. Tables. Accessible at: https://tidesandcurrents.noaa.gov/publications/CO-OPS_Measurement_Spec.pdf
- Park J and Heitsenrether R. 2013. WaterLog® H-3611i test results part I: sensor characterization. US Dept Commer NOAA NOS CO-OPS. Internal document. Available upon request.
- Park J, Heitsenrether R, Sweet W. 2014. Water level and wave height estimates at NOAA tide stations from acoustic and microwave sensors. J Atmos Ocean Technol. 31(10):2294-2308. Accessible at: https://journals.ametsoc.org/view/journals/atot/31/10/jtech-d-14-00021_1.xml