

Detection of PIT-tagged juvenile salmonids in the Columbia River estuary using a pair-trawl, 2000 and 2001

***Fish Ecology
Division***

***Northwest Fisheries
Science Center***

***National Marine
Fisheries Service***

Seattle, Washington

by
Richard D. Ledgerwood, Seth W. Naman,
Brad A. Ryan, Benjamin P. Sandford,
C. Zoe Banks, and John W. Ferguson

March 2004

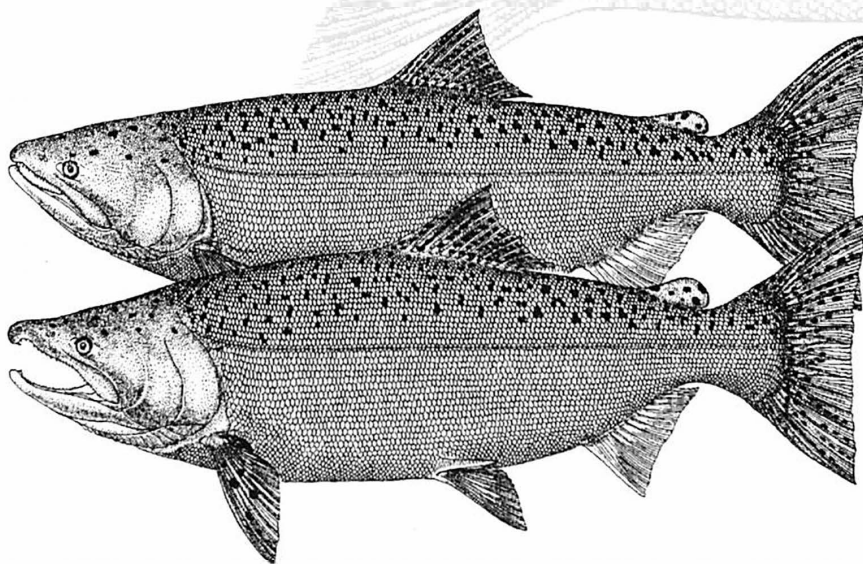

**Detection of PIT-Tagged Juvenile Salmonids in the Columbia River Estuary
using a Pair-Trawl, 2000 and 2001**

Richard D. Ledgerwood, Seth W. Naman, Brad A. Ryan, Benjamin P. Sandford,
C. Zoe Banks, and John W. Ferguson

Report of research by

Fish Ecology Division
Northwest Fisheries Science Center
National Marine Fisheries Service
National Oceanic and Atmospheric Administration
2725 Montlake Boulevard East
Seattle, Washington 98112-2097

for

Walla Walla District
North Pacific Division
U.S. Army Corps of Engineers
201 North 3rd
Walla Walla, Washington 99362-1875
Contract W68SBV80622741

March 2004

EXECUTIVE SUMMARY

In 2000 and 2001, National Marine Fisheries Service (NMFS) researchers continued sampling juvenile salmonids tagged with passive integrated transponder (PIT) tags using a surface pair-trawl fitted with a PIT-tag detection antenna. Here we report and compare detection data from two dissimilar years: 2000, which was characterized by high river-flows, and 2001, which was characterized by near-record low river-flows.

Our sampling efforts targeted several large annual release groups of PIT-tagged fish: about 150,000 tagged fish from the Snake River transportation study, about 135,000 tagged fish from The Dalles Dam survival study (2000 only), and about 180,000 tagged fish from the comparative hatchery survival study. Estuarine detections of many other release groups of PIT-tagged fish were also recorded both years. The following were specific goals of sampling during 2000 and 2001.

- 1) Compare migrational timing and relative survival to the estuary between in-river migrant and transported juvenile chinook salmon *O. tshawytscha* and steelhead *O. mykiss*.
- 2) Assess migrational timing to the estuary for estuary detections of fish previously detected at Bonneville Dam, and contribute these data for use in passage-route survival estimates.
- 3) Estimate in-river survival from McNary and Lower Granite Dam to Bonneville Dam for major groups of juvenile salmonids.
- 4) Compare migrational timing between radio-tagged and PIT-tagged juvenile salmonids.

The surface-trawl detection system operated on a 134.2-kHz frequency in both 2000 and 2001; this frequency extended tag reading range over the 400-kHz used in previous years. In 2001, we added a second antenna coil to increase detection efficiency.

In both years, we released PIT-tagged fish directly into the trawl to evaluate detection efficiency. Detection rates for head-rope releases during daylight were significantly higher in 2001 (72%) than in 2000 (41%). In 2001, detection rates of fish released at the head rope were significantly higher during darkness (83%) than daylight (72%), but effects of tag density were not significant: mean detection rates were 78% for releases of 10 fish and 74% for releases of 30 fish.

We also calculated the percentage of fish detected only on the rear coil in 2001. The effect of tag density on the rear coil detection rate was significant, averaging 17% for releases of 10 and 23% for releases 30 fish. Out of 4,992 river-run migrating fish detected on the front coil, 87% were subsequently detected on the rear coil, and 11% of all detections occurred only on the rear coil.

In 2000, the trawl detection system operated for 553 h between 18 April and 21 June, and a total of 5,940 juvenile salmonids were detected. In 2001, the system was deployed for a total of 646 h between 19 April and 22 June resulting in 5,542 detections. During extended sampling periods (16 h d⁻¹) in 2000, we detected 1.4% of yearling chinook salmon and 2.1% of steelhead previously detected at Bonneville Dam. During extended sampling in 2001, we detected 2.5% of yearling chinook and 3.9% of steelhead detected at Bonneville Dam.

For Snake River yearling chinook salmon, average weekly survival from the tailrace of McNary Dam to the tailrace of Bonneville Dam was estimated at 64% (SE, 12.2) and 50.1% (SE, 2.7) during the 2000 and 2001 migration seasons, respectively. For Snake River steelhead, mean survival was 58% (4.7) in 2000 and 25% (1.6) in 2001. Mean survival for mid-Columbia River steelhead stocks was 41% (11.1) in 2000. Mean survival was calculated only for fish groups with sufficient numbers of detections for a precise estimate.

In 2000, we detected 647 yearling chinook salmon, 317 coho salmon, and 96 subyearling chinook salmon released for a study at The Dalles Dam. Migration rates from Bonneville Dam to the upper estuary for yearling chinook salmon released from The Dalles Dam were 82 km d⁻¹, significantly slower than the 89 km d⁻¹ over the same distance for yearling chinook released from Lower Granite Dam.

Mean travel time of chinook salmon released at The Dalles Dam and subsequently detected at Bonneville Dam was also longer than that of their cohorts not detected at Bonneville Dam, (3.9 vs. 3.5 d). However, the difference in mean travel time of coho salmon from the same comparison groups was not significant (3.9 vs. 3.7 d).

In 2001, most fish were transported due to low river-flows, and no in-river migrant group was released for NMFS transportation study. Therefore, we matched trawl system detections to detection histories available from the Columbia Basin PIT-Tag Information Systems to evaluate migration behavior of transported vs. in-river migrant fish from Bonneville Dam to Jones Beach. We found significant interaction between date of detection at Bonneville Dam and migration history: in early May, estimated detection

efficiency for in-river migrants (1.4%) was higher than for transported fish (0.6%), but the difference disappeared by the end of May (both around 2.0%). For steelhead, there was no interaction between date and migration history, but there was a significant effect of date. Detection efficiency for both transported and in-river migrant steelhead was around 1% in late April and increased to more than 4% by late May.

Daily detection percentages in 2001 showed that for chinook salmon, date of barge release or detection at Bonneville Dam was not a factor affecting estuary detection rates, and there were no interactions between date and migration history. However, estuary detection efficiency was about 1% higher for in-river migrant chinook salmon detected at Bonneville Dam (2.2-2.6%) than for chinook salmon released from barges (1.4-1.6%). Results for steelhead were similar, with detection efficiency about 1.5% higher for in-river migrants detected at Bonneville Dam (4.1%) than for fish released from barges (2.6%).

Median travel speed from Bonneville Dam to Jones Beach in 2000 was significantly slower for yearling chinook salmon released from barges (75 km d⁻¹) than for those detected at Bonneville Dam (92 km d⁻¹). However, median travel speed was 92 km d⁻¹ for both transported and in-river migrant steelhead in 2000.

In 2001, yearling chinook salmon released from barges traveled to Jones Beach slower (51 km d⁻¹) than those detected at Bonneville Dam (69 km d⁻¹). For steelhead, the difference in median travel speed to Jones Beach for transported fish (67 km d⁻¹) and fish detected at Bonneville Dam (65 km d⁻¹) was not significant. Travel speeds of yearling chinook salmon and steelhead from Bonneville Dam to Jones Beach were significantly slower in 2001 than in 2000, regardless of migration history.

We also compared travel speeds of radio- and PIT-tagged steelhead from Bonneville Dam or barge release site to the upper Columbia River estuary. In both cases, radio-tagged fish appeared to travel slower than PIT-tagged fish.

Intermittently, between 1 June and 12 July 2001, we operated a small trawl fitted with a prototype, single-coil, saltwater-tolerant, 134.2-kHz PIT-tag antenna; a total of 55 detections were recorded (all in fresh water). During deployments in the brackish-water portion of the lower Columbia River estuary, no major problems with entanglements of bait-type fishes or salmonids occurred. Several equipment-related difficulties were identified and resolved. We concluded that the small trawl system is useful for detecting PIT-tagged fish in salt water and areas otherwise inaccessible to the large trawl system.

CONTENTS

EXECUTIVE SUMMARY.....	iii
INTRODUCTION.....	1
METHODS.....	5
Study Site.....	5
Net Selection and System Design.....	5
Vessels and Crew.....	8
Net Deployment, Operation, and Retrieval.....	8
Electronic Equipment and Operation.....	9
Data Acquisition and Recording.....	11
Detection Efficiency Tests.....	12
Study Fish.....	12
Sample Period.....	15
Statistical Analyses.....	15
RESULTS.....	19
Detection Efficiency.....	19
Impacts on Fish.....	27
Diel Detection Patterns.....	27
Timing and Migration History Comparisons.....	29
Transportation Evaluation.....	39
Survival Estimates of In-river Migrants to Bonneville Dam.....	44
Delay of Fish Detected at Bonneville Dam.....	49
DISCUSSION.....	51
ACKNOWLEDGMENTS.....	54
REFERENCES.....	55
APPENDIX A: Development of a Small Surface-Trawl PIT-Tag Interrogation System.....	60
APPENDIX B: Data Tables.....	74

INTRODUCTION

In 2000 and 2001, the National Marine Fisheries Service (NMFS) continued sampling juvenile anadromous salmonids *Oncorhynchus* spp. implanted with passive integrated transponder (PIT) tags using a surface pair-trawl fitted with a PIT-tag-detection antenna. The study began in 1995 and has continued annually (except 1997) in the estuary at Jones Beach, approximately 75 km upstream from the mouth of the Columbia River (Ledgerwood et al. 1997, 2000, 2003).

Here we report detection data from two years: 2000, which was characterized by high river-flows, and 2001, which was characterized by near record low river-flows. Low flows in 2001 resulted from a severe regional drought, which changed the strategy used by fishery managers to maximize survival of downstream migrant fish past dams. Instead of the “spread the risk” approach, wherein a combination of spill at dams and transportation are used, a “maximize transport” strategy was adopted, wherein spill was reduced and most downstream migrant fish were collected for transport below Bonneville Dam (RKm 234). The surface trawl detection system provides the only opportunity to detect transported fish prior to their return as adults.

In the Columbia River Basin, releases of juvenile salmonids implanted with PIT tags began in the 1980s (Prentice et al. 1990b). During the 1990s, the NMFS and the U.S. Army Corps of Engineers (USACE) installed detectors at hydroelectric facilities throughout the basin to monitor downstream migrations of PIT-tagged juvenile salmon (Prentice et al. 1990a,b,c). Shortly after these installations began, the PIT Tag Information System (PTAGIS) was established as a regional database to store and disseminate release and detection times and locations, as well as species, origin, and migration history of individual PIT-tagged fish (PSMFC 2002).

The tagging and release program has grown over the years: between 1995 and 1998, over 500,000 PIT-tagged juvenile salmonids were released annually, and since 1999, annual releases have exceeded more than 1 million (Ryan et al. 2001; Table 1). Such large releases made feasible the development and use of a mobile PIT-tag detector in the estuary, independent of hydroelectric facilities (Ledgerwood et al. in press).

In 2000 and 2001, we continued detection efforts in the estuary, targeting large groups of PIT-tagged fish released from April through June. These groups included over 235,000 PIT-tagged fish released from a transportation study on the Snake River (Marsh et al. 1996, 1997, 1998, 2000, 2003), over 224,000 PIT-tagged fish released from a comparative survival study (Berggren and Basham 2000), and over 139,000 PIT-tagged fish released from a survival study at The Dalles Dam in 2000 (Absolon et al. 2002).

Table 1. Annual releases of PIT-tagged juvenile salmonids in the Columbia River Basin, 1995-2001. Data for basin-wide releases obtained from PTAGIS database (PSMFC 2002).

Migration year	Total PIT-tagged salmonids released	Chinook salmon	Coho salmon	Steelhead	Sockeye salmon
1995	567,151	478,488	10	80,519	8,134
1996	435,235	333,242	5,275	80,371	16,347
1997	619,058	440,354	47,359	127,078	4,267
1998	1,854,234	1,508,175	151,616	164,184	30,259
1999	1,670,503	1,216,620	65,616	368,092	20,175
2000	1,196,789	884,278	89,702	219,217	3,592
2001	1,066,058	888,599	47,605	123,960	5,894
Totals:	7,409,028	5,749,756	407,183	1,163,421	88,668

To study the characteristics of juvenile salmonid migrations through the lower estuary, we began development of a small surface trawl system for sampling PIT-tagged juvenile salmonids in the brackish-water portion of the estuary (0-35 km upstream from the mouth) in 2001. Prior to this research, no such salt-water tolerant detection equipment was available. A small, mobile PIT-tag detection system that could be deployed rapidly would have application in smaller rivers, high-volume bypass channels, the ocean, and areas of the Columbia River that are unsafe for the larger pair-trawl system. Information regarding the development of the small trawl and associated electronic equipment is presented in Appendix A.

Detection data from pair-trawl sampling in 2000 and 2001 was collected with the following objectives:

- 1) Compare migrational timing and relative survival to the estuary between in-river migrant and transported juvenile chinook salmon *O. tshawytscha* and steelhead *O. mykiss*.
- 2) Assess migrational timing to the estuary for fish detected at Bonneville Dam and contribute data to estimates of passage-route survival.
- 3) Estimate in-river survival from McNary and Lower Granite Dam to Bonneville Dam for major groups of yearling salmonids.
- 4) Compare migrational timing between radio-tagged and PIT-tagged juvenile salmonids.

Combining data from two sampling years in this report afforded an added opportunity to contrast effects of the 2001 drought on the study objectives listed above.

METHODS

Study Site

Trawling operations ranged from the Eagle Cliff area (around River Kilometer (RKm) 83), to the west end of Puget Island (RKm 61; Figure 1). This is a freshwater reach characterized by frequent ship traffic, occasional severe weather, and river currents often exceeding 1.5 m s^{-1} . Tides in this area are semi-diurnal with about 7 h of ebb and 4.5 h of flood. During the spring freshet period (April-June), little or no flow reversal occurred at the study site during flood tides, particularly during years of medium to high river flow. In 2001, a severe regional drought produced low river-flows with flow reversal on flood tides. The net was deployed adjacent to a 200-m-wide navigation channel which is maintained to a depth of 14 m.

Net Selection and System Design

A surface pair-trawl was initially chosen for development in 1995 because flow in the trawl guided fish directly to the cod end of the net, a logical location for the detection antenna. The trawl could also be deployed safely in the high-current area of the upper estuary, and it allowed for longer periods of uninterrupted sampling than other types of nets (Dawley et al. 1986, Ledgerwood et al. 1990).

The trawl components are described below, and their basic configuration remained fairly constant through the study period (Ledgerwood et al. in press; Figure 2). To prevent turbulence on the net from the tow vessels, 73-m-long tow lines were used. The upstream end of each wing of the trawl initiated with a 3-m-long spreader bar, which was shackled to the wing section. The end of each wing was attached to the 14-m-long trawl body, for a total length of 105.5 m along each side of the trawl. The mouth of the trawl body opened between the wings and from the surface to a depth of 6.1 m; a floor extended 4.6 m forward from the mouth.

In previous years, divers observed that fish were attracted to any visible or hydraulic transition areas between sections of the trawl and delayed in these areas rather than exiting the trawl. Therefore, we removed all materials that interrupted the hydraulic transition from the trawl mouth to the antenna, and any materials that produced visual cues that may have motivated fish to linger near the mesh interface.

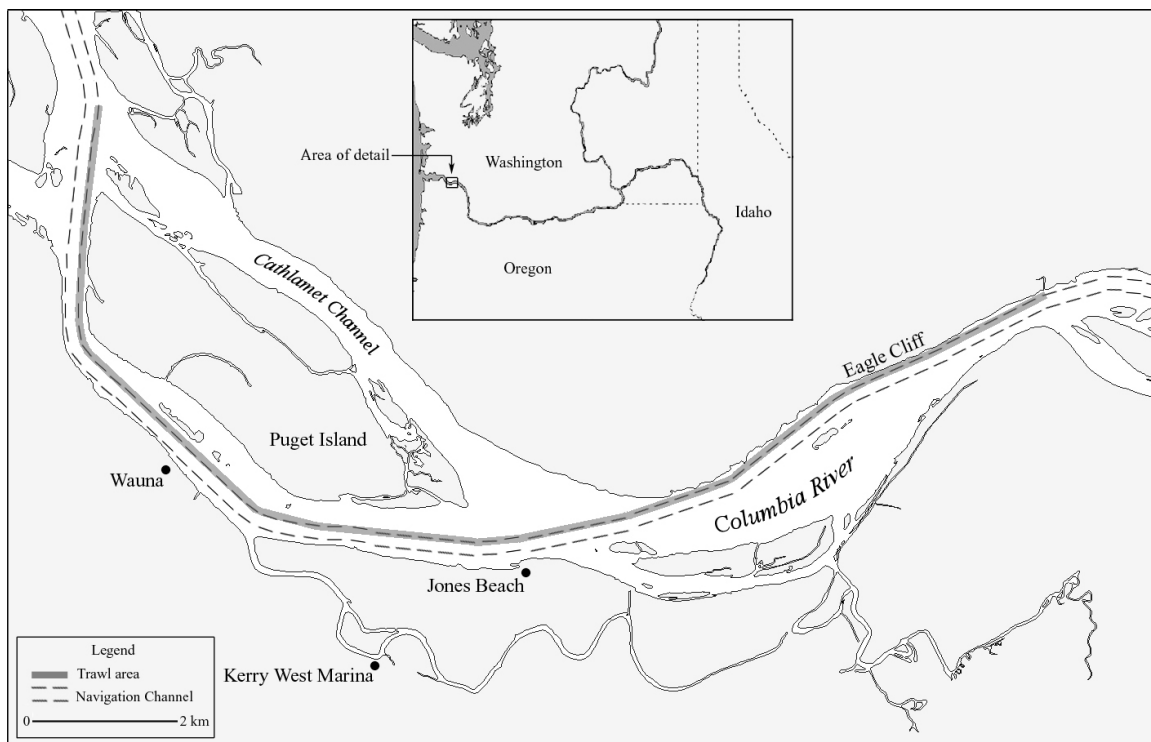

Figure 1. Trawling area adjacent to the ship navigation channel in the upper Columbia River estuary near Jones Beach at Columbia River Kilometer 75.

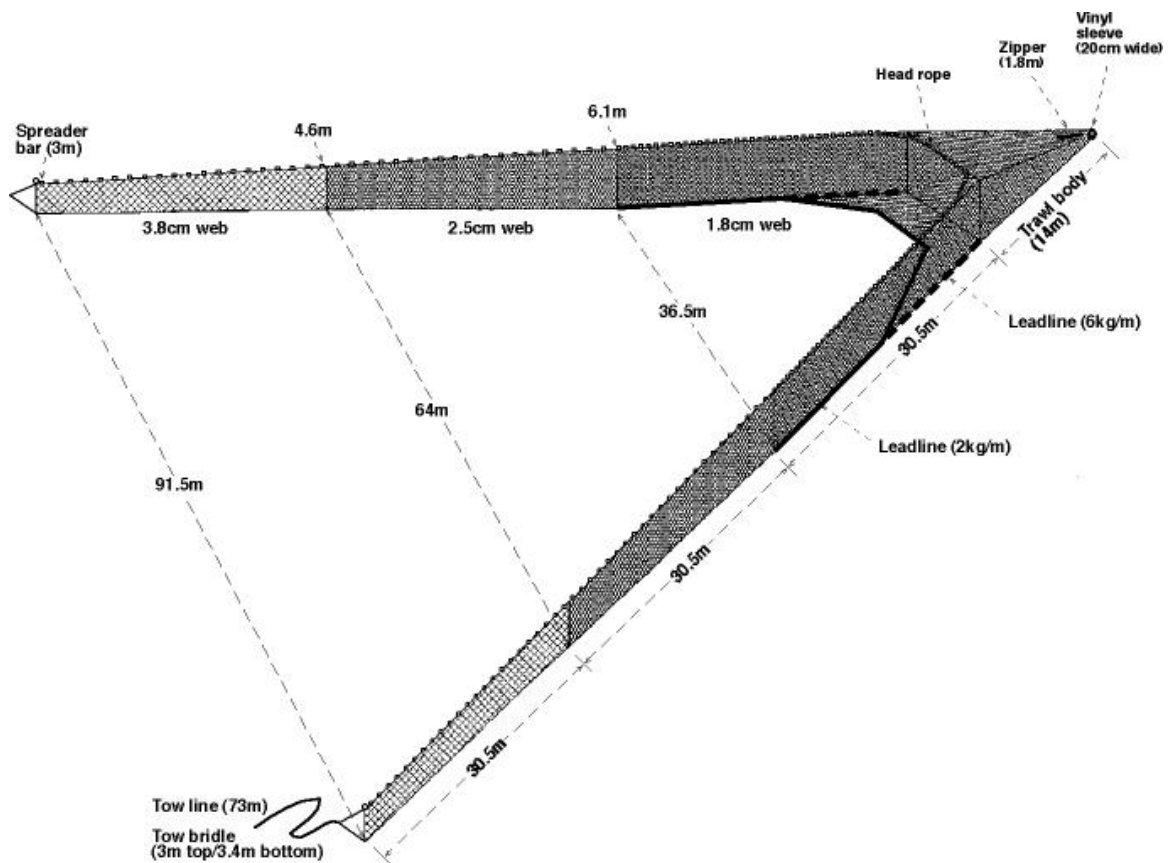

Figure 2. Basic design of the surface pair trawl used in 2000 and 2001 to sample PIT-tagged juvenile salmonids in the Columbia River estuary at Jones Beach, RKm 75.

The detection antenna was centered at a depth of 1.8 m, and the trawl wings tapered upward from a sample depth of 6.1 m at the floor of the trawl body to 3 m at the tow bridle. However, drag on the trawl body when under tow tended to align the net components to the same depth, raising the trawl floor and causing curvature of the wing walls. This reduced the sample depth in earlier years to 3.5 m. To compensate for the lift and curvature, we attached additional lead line to the perimeter of the trawl. Adaptation of a detector antenna with a larger opening in 2000 further reduced drag and lift, and thus increased sample depth of the trawl to 4.6 m.

Vessels and Crew

Both 12.5-m-long tow vessels were powered by twin diesel engines. Each engine produced 318 shaft horsepower (shp) at 2,300 RPM and about 200 shp at 1,250 RPM, the power required to maintain a tow speed of 0.8 m/s.

An 8-m-long pontoon barge housed the generator and detector electronics. The barge was maneuvered into place using an outboard motor and then tethered to the head rope during towing operations. A 5.5-m skiff with an outboard motor was used for net deployment and retrieval and to move crew members between vessels. Generally, a seven-person crew was required for sampling: two on each tow vessel, one to operate the skiff, and one to operate the pontoon barge. A seventh person assisted with attaching the detector, cleaning debris from the net, untangling lines, and operating the reel.

Net Deployment, Operation, and Retrieval

During a typical surface pair-trawl deployment, both wings were towed upstream as the net was spooled out from a reel on the stern of one of the tow vessels. When the trawl was fully deployed, the pontoon barge was maneuvered to a position above and slightly behind the trawl body and tethered in place. The cod end of the trawl was then pulled to the surface, and the detection antenna, cabling, and video camera were attached. The complete apparatus was then lowered into the water, and a buoy was used to position the detection antenna at a depth of 1.8 m on center.

With the detector and camera in place, the wings of the trawl were towed laterally to establish a 91.5-m opening, and the vessels were brought up to sampling speed (0.8 m/s). The wings of the net were brought together every 15 min to flush

additional water through the antenna passage openings and help evacuate fish that delayed near the head rope or directly in front of the antenna. Each flush cycle required about 9 min to close, vacate, and reopen the net.

To retrieve the trawl, the detection antenna was brought to the surface and placed on the barge, and the barge was detached from the net. The skiff was then used to retrieve a line from the upstream end of the trawl while the tow vessels reversed direction, towing both wings downstream and away from the center of the trawl body. As the net inverted, the skiff pulled the cod end and trawl body inside out. The net was then reeled in, cod-end first, with the spreader bars and tow lines left on deck for subsequent deployment.

Electronic Equipment and Operation

In 2000, the frequency of all PIT-tag detection systems at dams throughout the Columbia River Basin was converted from 400 to 134.2 kHz (Prentice et al. 1999). At this frequency, tags have greater reading range and detection efficiency when passing a detection antenna at suboptimal angles. We redesigned our antenna, adapting components of the 134.2-kHz systems used at dams. This increased tag reading range to 46 cm, and allowed for a 91 cm-diameter passage opening through the antenna (Figure 3a). The antenna was 24-cm-long and weighed 40 kg.

Under tow, we measured a flow of 0.7 m s^{-1} through the enlarged fish passage opening. We also observed a considerable improvement in fish egress from the trawl as compared to previous years. Pacing and delay of fish near the antenna was reduced. A portion of the fish were observed to turn and actively swim downstream through the antenna. The increased flow through the antenna also stabilized and improved its alignment with the trawl during high winds.

In 2001, a second antenna coil was added to duplicate the detection field and increase detection efficiency. To eliminate interference between the two coils, we installed a 152-cm-long spacer, which increased the antenna length to 2.1 m and its weight to 200 kg (Figure 3b). To improve the ability to read PIT tags oriented at sub-optimal angles, the antenna coils were insulated inside and out with an additional 2.5 cm layer of foam and encased in fiberglass. The insulation expanded the detection field under water, but also reduced the inside diameter of the fish passage opening from 91 to 86 cm.

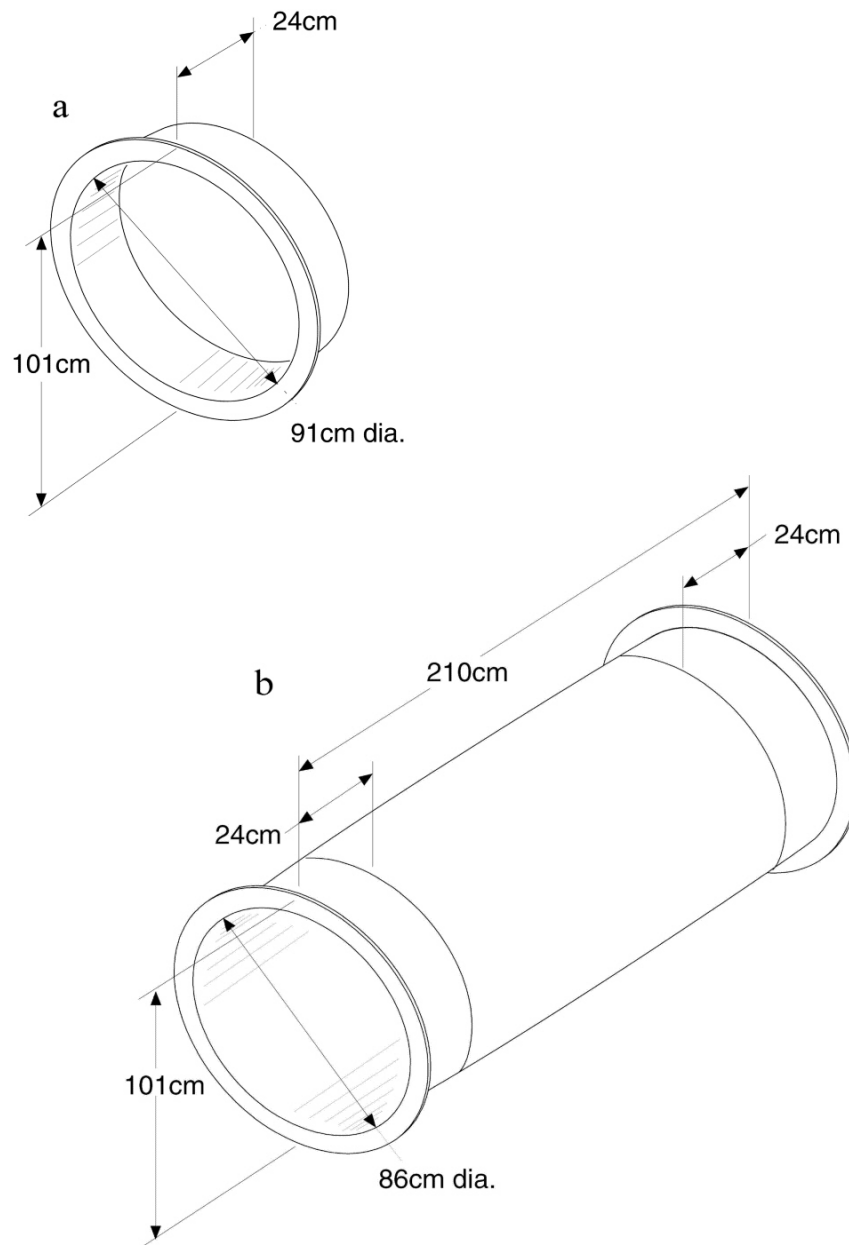

Figure 3. Basic design of the antennas used in 2000 (a) and 2001 (b) with a surface pair-trawl to sample PIT-tagged juvenile salmonids in the Columbia River estuary at Jones Beach, Rkm 75.

Data Acquisition and Recording

PIT-tag detection and recording electronics were mounted in the cabin of the barge, and cables led underwater to a tuner port on each detection coil. A video camera mounted near the antenna tunnel was used to monitor fish passage on a VCR/TV housed in the electronics barge. Once the antenna was energized, a computer software program (Multimon) automatically recorded time, date, and detection data (Downing et al. 2001). A gasoline generator powered all electronic equipment.

For each sampling cruise, written logs were maintained noting the time and duration of net deployment, total detections, the number of impinged or injured fish, and the start and end of each net-flushing period. Global positioning system (GPS) coordinates of the tow vessels were recorded by crews at the beginning of each net-flushing period. Beginning in 2001, the GPS coordinates of the electronics barge, and the date and time were automatically recorded in the PIT-tag data file using an updated version of Multimon.

PIT-tag-detection data files were periodically (about weekly) uploaded to PTAGIS using standard methods described in the *PIT-tag Specification Document* (Stein et al. 2001). The specification document, PTAGIS operating software, and user manuals are available via the Internet (PSMFC 2002). Pair-trawl detections in the PTAGIS database were identified with site code “TWX” (towed array-experimental).

Records of PIT-tagged fish detected at Bonneville Dam were downloaded from PTAGIS for comparison with our detections (PSMFC 2002). In addition, the transport barge loading sites, dates, and times and corresponding barge release sites, dates, and times were provided by the USACE. An independent database (Microsoft Access¹) of detection information was also maintained to facilitate data management and analysis. We modified our data to include the barge release location (river kilometer), date, and time of release for fish transported past Bonneville Dam.

1 Reference to trade name does not imply endorsement by National Marine Fisheries Service.

Detection Efficiency Tests

In both years, we released PIT-tagged fish directly into the trawl to evaluate detection efficiency. Groups of about 30 PIT-tagged yearling chinook salmon were diverted from the juvenile bypass system at Bonneville Dam and transported by truck to the study site. In 2000, we released fish in groups of 30 during daylight from various points along the trawl body and individually through a hose positioned 0.3 m in front of the antenna. In 2001, releases were made only at the head rope and extended from daylight into darkness, with replicate sizes alternated between groups of 10 fish (three batches) and 30 fish (one batch).

In 2001, we developed a procedure for evaluating electronic performance of the antenna that did not require the release of test fish. A 2.5-cm diameter polyvinyl chloride (PVC) pipe with a small plastic funnel on each end was positioned through the center of the antenna. The pipe extended past each end of the antenna about 0.5 m beyond the range of the electronic field. We attached 50 PIT tags at known intervals and orientations to a vinyl-coated tape measure (Appendix Table B1). We chose densities and orientations along the tape such that not all tags would be read. The relative consistency of tag detection helped validate electronic tune and identify possible problems with the electronics.

We suspended the antenna underwater from the barge and repeatedly pulled the PIT-tagged tape back and forth through the PVC pipe between the barge and skiff. The start time of each pass was recorded in a logbook, and we used standard PIT-tag software to record detections. Efficiency was calculated as the total number of unique tags decoded during each pass divided by the total tags passed through the antenna.

Study Fish

Target fish were the juvenile yearling chinook salmon and steelhead collected and PIT tagged at Lower Granite Dam (Rkm 695) on the Snake River for NMFS transportation study (Figure 4; Marsh et al. 1996, Harmon et al. 2000). These releases provided large groups of PIT-tagged migrants with known release locations and times that could be coordinated with trawl system operation. After tagging, transportation study fish were either released below Lower Granite Dam to continue migration in the river or transported and released downstream from Bonneville Dam.

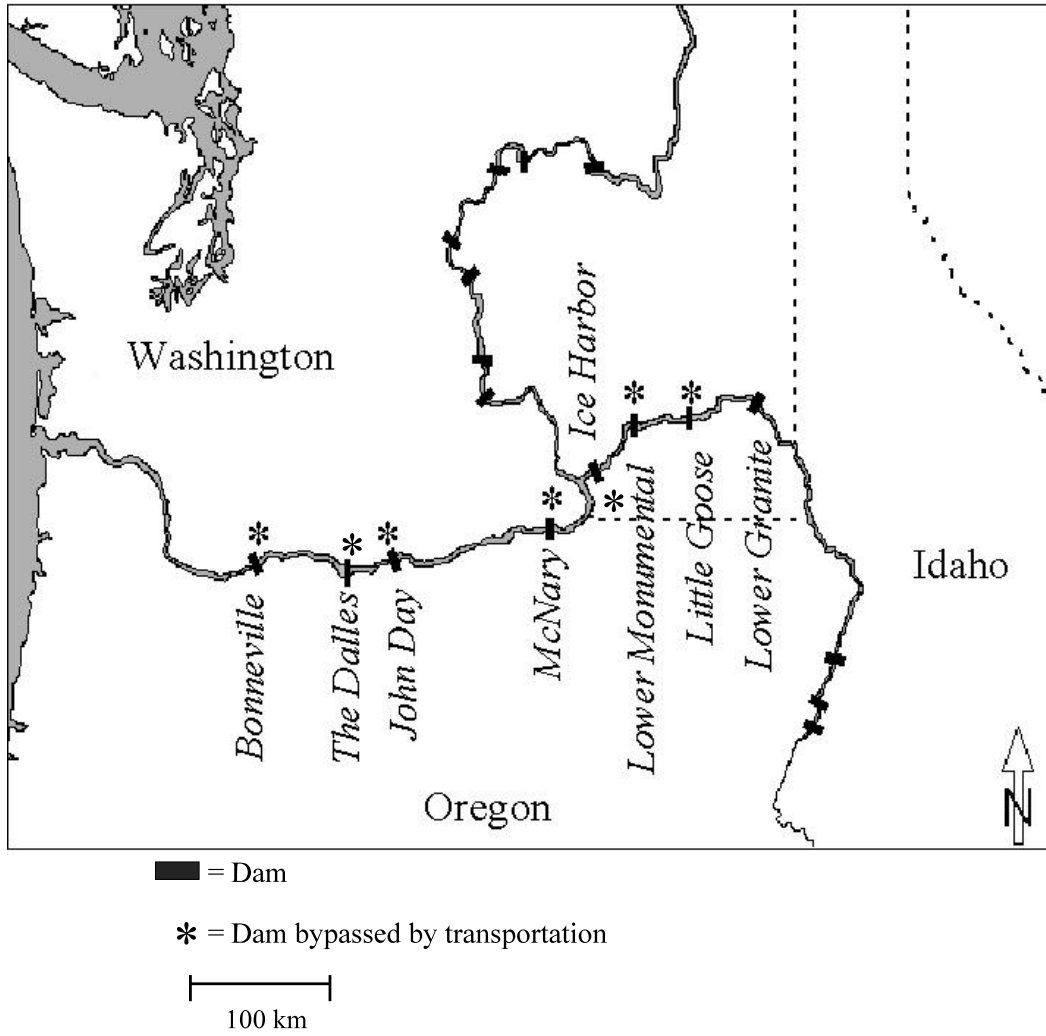

Figure 4. Overview of the Columbia River Basin and the major dams of the region.

In 2000, only wild fish were collected and tagged for the transportation study. Furthermore, fish designated for transport were released at Lower Granite Dam and collected again Little Goose Dam (Rkm 635) for loading to a transport barge. In 2001 the transport study again used only wild fish, and in addition, all fish were transported from Lower Granite Dam; no fish were released to migrate in the river because of low river flows.

Because of these changes in protocol, the pool of fish targeted for estuary detection was reduced. To compensate, we included in our analyses all PIT-tagged fish diverted to barge loading raceways, including hatchery fish and others not tagged and released specifically for the transportation study. We created a database containing the records of PIT-tagged fish that had been diverted for transportation according to PTAGIS. Intentional diversions were accomplished according to a separation-by-code procedure at specific dams (Stein et al. 2001).

Diversion to transportation barges both intentionally and unintentionally (i.e., missed being diverted back to the river at slide gates) was confirmed by comparing the last monitor name listed for a PIT-tagged fish to the PTAGIS site map to the route ending at a transport raceway or barge. Since 1987, over 1 million PIT-tagged fish have been assigned to this database. We have worked with the USACE to obtain accurate barge loading dates and times to enable us to assign PIT-tagged fish to specific transport barges by matching the last facility detection date and time with the next available barge at that facility.

In addition to the Snake River transportation study, there were several other studies in the Columbia River Basin that released large numbers of spring-migrating, PIT-tagged salmonids. Here we focus our analyses on the more numerous detections of PIT-tagged yearling chinook salmon and juvenile steelhead; detections of PIT-tagged coho salmon *O. kisutch*, sockeye salmon *O. nerka*, and subyearling chinook salmon were also recorded, but there were too few detections for accurate statistical analyses of these species.

To assess impacts of the trawl on fish, we used nearly continuous video monitoring of fish exiting the antenna and periodic (about weekly) diver observations to assess impacts of trawling on fish. When debris accumulations or other problems were observed near the antenna on the video monitor, tow speed was reduced and the cod end and antenna pulled up to the surface for cleaning. During debris-removal activities and net-collection and redeployment procedures, we recorded impinged or trapped fish as mortalities in operations log books.

Sample Period

Each year, sampling began in mid-April and continued through mid-June, coincident with the passage of PIT-tagged fish from the Snake River transportation study. Beginning in May and extending through the first week of June, sampling increased from a single daily sampling crew to two daily crews. Generally, one crew began before daylight and sampled for 8-10 h, and a second crew began in late afternoon and sampled until dark.

In 2001, we conducted extended sampling sessions to determine diel availability on four occasions during the middle of the season. Sampling was nearly continuous during these weekly sessions except for brief periods of net cleaning or when it was necessary to retrieve the net and move back upstream. We rotated a third tow vessel into the operation to allow for refueling.

Statistical Analyses

Direct Evaluation of the Trawl

Detection data from PIT-tagged fish released directly into the trawl in 2001 (efficiency releases) were evaluated using a two-factor randomized block ANOVA, with day of release as blocks and time of day (diel) and density of release (10 or 30 fish groups) as factors 1 and 2, respectively. There was no significant interaction between diel hour of detection and density of fish (number of fish detected/h) in these analyses. Front and rear coil detection rates of fish used for detection efficiency tests were compared to front and rear coil detection rates of river-run migrating fish. We used a paired *t*-test with the data grouped by the daily detection percentages of the rear coil.

Diel Catch Patterns

Diel catch patterns (detections/h) of yearling chinook salmon and steelhead during daylight hours vs. dark hours were evaluated using one-way ANOVA (Zar 1999). The number of detections and the minutes within each hour that the detector was energized for each of the four diel sampling periods were separated into daylight- and darkness-hour categories, and mean hourly detection rates were pooled for wild and hatchery rearing types of each species for each sampling period. These mean hourly detection rates were used as the source for the ANOVA. Diel detection curves were prepared for yearling chinook salmon and steelhead based on the average number of fish detected each hour weighted by the minutes within each hour that the detectors were energized.

Travel Time

We plotted travel-time distributions and compared detection rates for subsets of yearling chinook salmon and steelhead marked and released at Lower Granite Dam and detected in the estuary, in-river migrants detected at both Bonneville Dam and Jones Beach, and transported fish released just downstream from Bonneville Dam and detected at Jones Beach. The plots represent the seasonal durations of availability in the estuary for their respective groupings, and differences in distributions for groups of interest were fairly obvious, particularly those comparing distributions in 2000 and 2001. The periods of availability in the estuary for the various subsets of data were compared using analyses of travel-time distributions. Travel time (in days) to the estuary was calculated for each fish by subtracting date and time of release (at location of release or detection at Bonneville Dam) from date and time of detection at Jones Beach.

Travel-time distributions for release groups of interest were compared using the 10th through 90th percentiles and the middle 80th percentile range. These two sets of statistics characterize the location, width, and shape of the distributions. Standard errors were estimated using bootstrap re-sampling techniques (Efron and Tibshirani 1993). For each data set, 1,000 individual tagged fish were sampled with replacement from the original data set. Each bootstrap sample was the same size as the original data set.

Travel time estimates were calculated by percentile for each bootstrap sample in increments of 10, similar to the analysis presented for 1999 (Ledgerwood et al. 2003). We used 1,000 samples to obtain reasonable variance estimates (Efron and Tibshirani 1993). The 95% confidence interval estimates were calculated as the 25th and 975th values of the ordered bootstrap estimates. Percentile or range difference estimates were considered significant at the $\alpha = 0.05$ level, if the value "0" was not contained in the intervals.

Multiple linear regression was used to evaluate differences in travel speed to Jones Beach between in-river migrants and transported fish each year. Factors used in the regression models of travel speed included Julian date, flow, migration history (in-river migrants vs. transported fish), and two-way interaction terms for the three main effects. Flow data were daily average discharge rates at Bonneville Dam (Figure 6). When interaction terms for Julian date and flow were not significant, they were removed from the models. The travel speed data were presented graphically showing 5-d mean values, but all regression analyses were performed using data from individual fish.

Transportation Evaluations

Binary logistical regression analyses were used to compare daily detection rates among in-river migrants previously detected at Bonneville Dam to those released from transportation barges on the same dates as detection at Bonneville Dam. The daily groupings were treated as “cohorts” in the analysis (Hosmer and Lemeshow 1989). Paired groups included only PIT-tagged fish that had been released from McNary Dam or from farther upstream.

Early season barge releases often occurred before there were sufficient detections of in-river migrants at Bonneville Dam for comparison. Recovery percentages were calculated for both migration-history groups over the entire season, but daily groups were not used for analysis unless both groups were present. Transported or in-river migrant groups defined by date of barge release or detection at the dam were treated as “cohorts” rather than individually. Potential covariates of the logistic regression model were migration history as a factor and date as a covariate. The model estimated the log odds of detection of the daily cohorts (i.e., $\ln[p/(1-p)]$) as a linear function of the covariates, assuming a binomial distribution for the errors.

A stepwise procedure was used for model selection. First, a model containing interaction between migration history and date was fitted (i.e., estimated). If the interaction term was not statistically significant ($\alpha > 0.05$), a reduced model without the interaction term was fitted to the data. The model was further reduced depending on the significance of migration history and date.

Various diagnostic tests (e.g., delta deviance for estimated probability and leverage statistic for original values) were used to assess the appropriateness of the model. Extreme or highly influential data points were identified and included in, or excluded from, the analyses on an individual basis depending on the particular aspects of each point. Data for yearling chinook salmon appeared adequate for all years; data for steelhead were also provided, but the sample size in 2001 was insufficient for analyses.

Daily groups of transported and in-river migrant fish presumably passed the sample area at similar times and were thus subject to the same sampling biases. If these assumptions are correct, the differences in their relative detection rates reflect differences in survival between the two groups from the area of release (near or at Bonneville Dam) to the estuary.

Tests of Assumption

To test the assumption that transported fish and in-river migrants passed the sample area with similar diel timing, we divided total seasonal detections for each group into 1-h intervals based on estuary detection time. Detection proportions among intervals were compared, and average differences for each interval were calculated. If no significant difference was found between groups within a 1-h interval, similar proportions of transported and in-river migrant fish had passed during that hour. A positive difference between groups indicated that higher proportions of transported fish passed during that hour, while a negative difference indicated a higher proportion of in-river migrants passed.

Detection data from the estuary are also essential to estimate survival of juvenile salmonids to Bonneville Dam, the last dam encountered by seaward migrants (Muir et al. 2001, Williams et al. 2001, Zabel et al. 2002). The probability of survival through an individual river reach is estimated from PIT-tag detection data using a multiple-recapture model for single release groups (Cormack 1964, Seber 1965, Skalski et al. 1998). This model requires detection probability estimates for the lowest downstream detection site (i.e., Bonneville Dam), and these estimates are calculated using detections below this site. The basis for such estimates was lacking until we acquired estuary detection data, which allowed estimates of weekly average survival probability for yearling chinook salmon and steelhead migrating in the Snake and mid-Columbia Rivers.

Estimates were obtained using component reach survival probabilities for migration from Lower Granite reservoir to McNary Dam and from McNary Dam to Bonneville Dam (Williams et al. 2001). Estuary detection data contributed to these estimates and provided the only data for survival estimates to Bonneville Dam.

The modified-single-release model used to estimate survival for in-river migrants to Bonneville Dam assumes that the probability of estuary detection is equal for all fish arriving in the estuary; that is, fish not detected at Bonneville Dam have an equal probability of estuary detection as those detected at the dam. To examine this assumption, we used multiple linear regression to compare travel time to Jones Beach for PIT-tagged fish released at The Dalles Dam and detected or not detected at Bonneville Dam. We pooled detection data for consecutive days until we had a minimum of five fish in each comparison group, and then we averaged the travel times for the groups.

RESULTS

We detected 5,940 and 5,542 PIT-tagged juvenile salmonids of various species, runs, and rearing types in 2000 and 2001, respectively (Appendix Tables B2-B3). However, proportional representation among stocks and rearing types varied greatly between years. For example, in 2000, yearling chinook salmon and steelhead represented 57 and 32% of the total estuarine detections, respectively, and other species/run types represented 11%. In 2001, 88 and 9% of the total detections were yearling chinook salmon and steelhead, respectively, and other species/run types made up the remaining 3%. In 2000, 31% of the detections were wild fish compared to 17% in 2001.

Contributions of PIT-tags to the estuary from the different river basins also varied between years (Figure 5). These variations in catch composition resulted primarily from differences in PIT-tagging strategies between years and complicate multi-year comparisons among species and run or rearing types.

Flow volume in the Columbia River during the spring migration season in 2000 was approximately double that of 2001; mean flows during the study period were $7,511 \text{ m}^3 \text{ s}^{-1}$ in 2000 and only $3,930 \text{ m}^3 \text{ s}^{-1}$ in 2001 (Figure 6). Also, the lack of a strong spring runoff in 2001 resulted in a perceptibly lower debris load, and as a result, sampling crews spent less time removing debris and more time sampling: equipment was energized for 553 h in 2000 and 646 h in 2001 (Figure 7). As a result of low river volume in 2001, fish were likely available in the sample area longer, increasing sample efficiency and further complicating direct comparisons of detection efficiencies between years.

Detection Efficiency

In 2000, detection rates of PIT-tagged test fish released directly into the trawl at various locations were variable and generally low, ranging from 12 to 79% (Table 2). All releases in 2000 were made during daylight. After adding a second coil to the detection antenna in 2001, we again released test fish directly into the trawl from the head rope only, and about one-third of the fish were released during darkness.

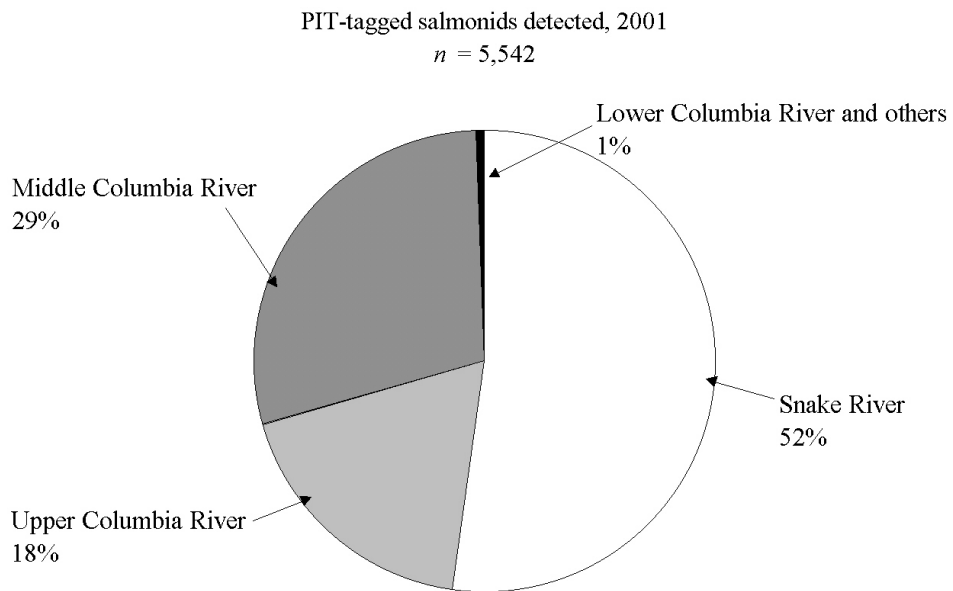
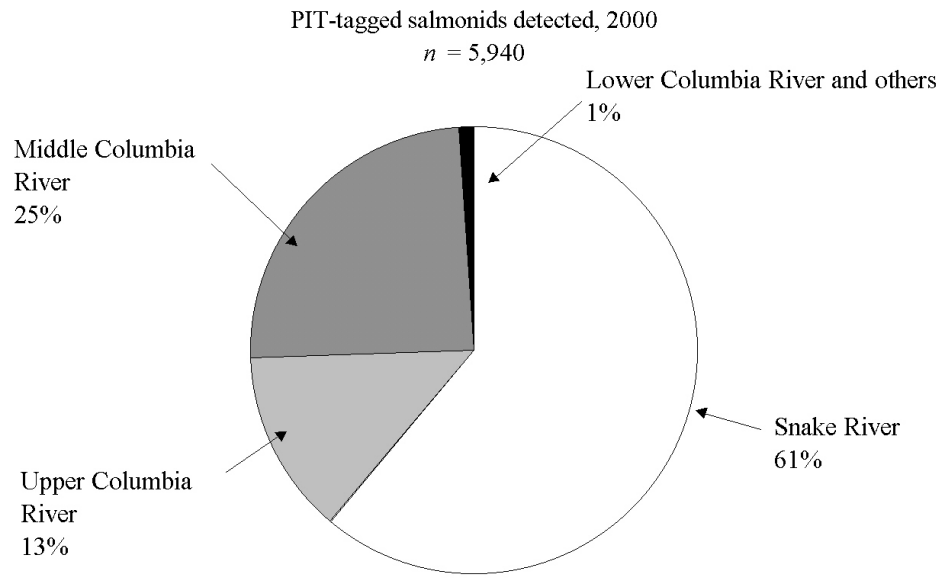

Figure 5. River basin sources of PIT-tagged fish detected in the Columbia River estuary at Jones Beach, Rkm 75, using a surface pair-trawl in 2000 and 2001.

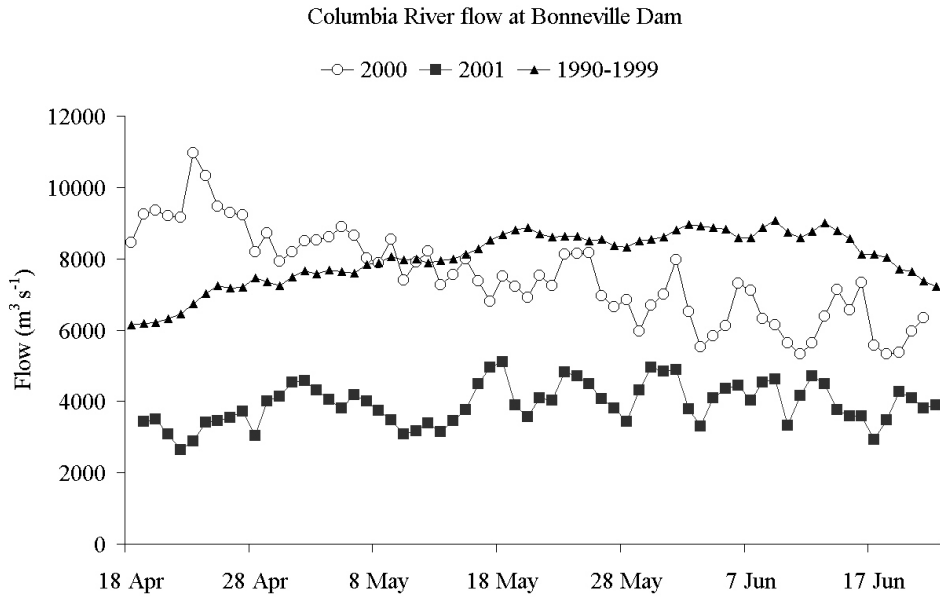

Figure 6. Columbia River flow at Bonneville Dam during the study periods of 2000 and 2001 and average flow during a ten year period from 1990-1999.

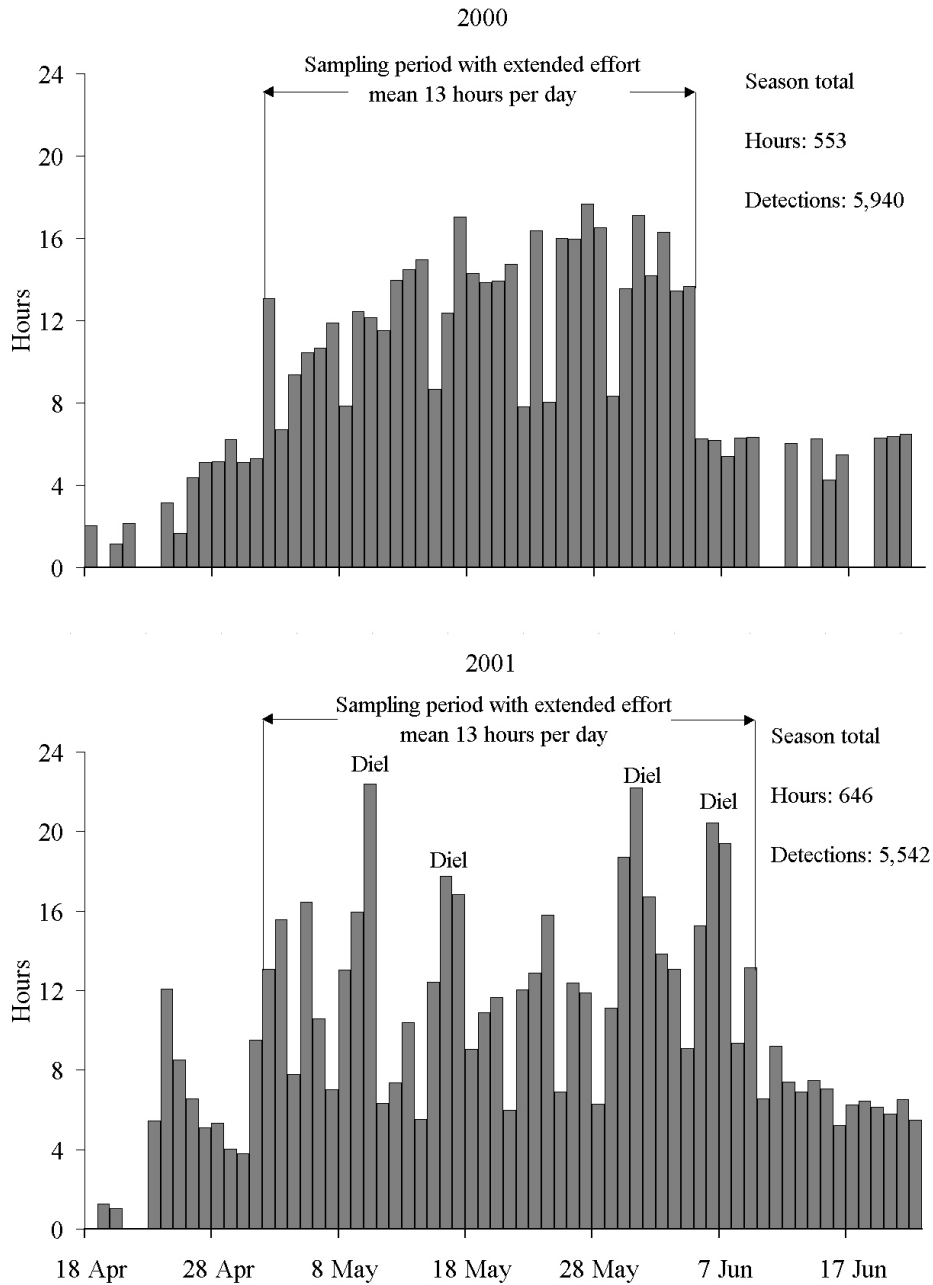

Figure 7. Sampling time during the 2000 and 2001 study periods using a PIT-tag detector surface pair-trawl in the Columbia River estuary at Jones Beach, Rkm 75.

Table 2. Detection rates of PIT-tagged yearling chinook salmon released directly into the surface trawl with the single-coil antenna in 2000 and the double-coil antenna in 2001. Head-rope releases were made from the centerline directly in front of the detector unit. Hose releases were from a 3.8-cm-diameter hose in the cod end of the trawl. Pipe releases were between the spreader bars on center. Wing releases were made along one side (wing) of the net mouth.

Release location	Diel period	Total number of fish released (n)	Number of release groups (n)	Distance from antenna (m)	Total detections (n)	Detection percent (SE)
2000						
Head rope	daylight	331	11	15	137	41 (3.9)
Hose	daylight	47	47	0.3	37	79 (–)
Pipe	daylight	330	11	107	40	12 (5.4)
Wing	daylight	84	3	61	17	20 (16.3)
Total	daylight	792	72		231	38 (15.0)
2001						
Head rope	daylight	744	25	15	537	72 (1.4)
Head rope	darkness	330	11	15	274	83 (2.5)
Total		1,074	36*		811	76 (2.0)

* Every other batch of 30 fish were divided roughly into thirds for release to create 10-fish batches to evaluate effects of density on detection efficiency.

Detection rates of fish released at the head rope in 2001 were significantly higher than in 2000 (72 vs. 41%; $P < 0.05$). In 2001, detection rates of fish released at the head rope were significantly higher during darkness than daylight (83 vs. 72%; $P < 0.05$), but effects of tag density were not significant, with mean detection rates of 78 and 74% for releases of 10 and 30 fish, respectively ($P = 0.107$).

To further evaluate performance of the second antenna coil added in 2001, we calculated the percentage of fish detected only on the rear coil. The effect of tag density was significant; means were 17 and 23% for releases of 10 and 30 fish, respectively (Table 3; $P = 0.05$). For non-test fish, 87% of the 4,992 detected on the front coil were subsequently detected on the rear coil, while 11% of all detections were only on the rear coil.

In 2001, we also implemented a procedure to evaluate electronic system and antenna performances that did not require the release of test fish. A properly tuned detection system read about 57% of test tags spaced 30-cm apart and perpendicular to the electronic field, but read only 32% of tags spaced the same distance but oriented at a 45-degree angle to the field (Figure 8). When spacing between tags was increased to 61 cm or more, detection efficiency increased to about 90% for perpendicular tags and to greater than 50% for 45 degree tags.

Various modifications to the testing procedure were made during the season. By the end of the season, we had developed a reliable in situ procedure for passing test tags through the exact center of the antenna. These tests were repeated about weekly, or more frequently when problems were indicated.

If the pipe through which tags were passed was positioned about 20 cm from the antenna wall rather than in the exact center, then about 98% of tags were decoded, regardless of density or orientation. Since most fish do not swim through the exact center of the antenna, we believe that our general detection efficiency for fish was greater than 95%. The tape tests provided an empirical measurement of the worst-case scenario for fish passage.

Table 3. Total first-time detections vs. detections on the rear coil only for PIT-tagged yearling chinook salmon released into the surface trawl with a double-coil detection antenna in May 2001. Mean detection percentages for the rear coil only were significantly different between release groups of 10 vs. 30 fish (paired *t*-test; *P* = 0.005).

Release date	Batches of 10 fish			Batches of 30 fish		
	Released (n)	Front and rear coil detections (%)	Rear coil only detections (%)	Released (n)	Front and rear coil detections (%)	Rear coil only detections (%)
4 May	119	83.2	20.2	180	83.9	29.6
10 May	145	77.2	15.2	150	71.3	20.6
18 May	150	73.3	15.5	150	66.7	20.0
24 May	90	78.9	16.9	90	67.8	23.0
Total/Mean	504	78.2	17.0	570	73.5	23.3

Detection Rates of Pit-tags
Attached to a Test Tape, 2001

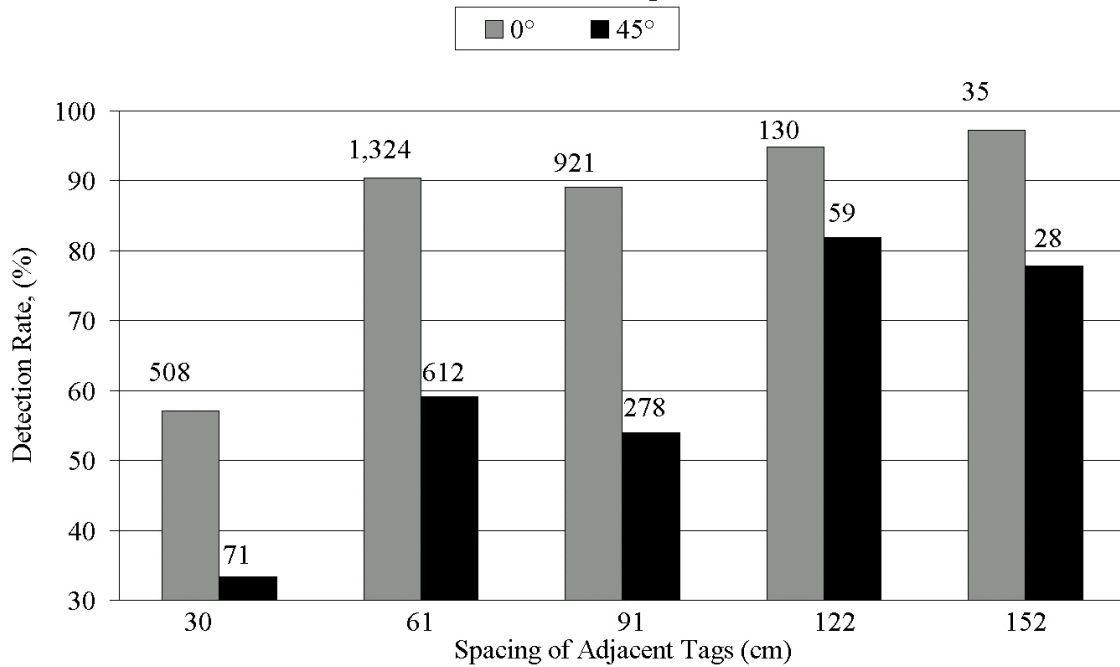

Figure 8. Antenna performance evaluation using PIT tags attached to a vinyl tape measure. Various spacings between tags and orientations to the electronic field (in-line with the tape = 0° or at an angle of 45°) were used. The tape was passed through the antenna repeatedly on different dates. Total detections (number of reads) used to evaluate spacing and orientation effects are shown above bars.

Impacts on Fish

We used nearly continuous (daylight) video and periodic diver observations to visually assess impacts to fish and adjusted sampling operations accordingly. When debris accumulations or other problems were observed, we reduced tow speed and pulled the detection antenna to the surface to clean the cod end of the net. To clean debris in extreme conditions, we disconnected the electronics and inverted the entire net.

Less than 100 salmonids were recorded as impinged, gilled, or otherwise injured in the netting during the trawl inspections or upon retrieval of the net in 2000 and 2001 (Appendix Table B4). It is possible that other mortalities and injuries to fish occurred but were not observed due to the net inversion process. However, divers inspecting the trawl body and wing areas of the net reported that it was rare to observe fish swimming close to the webbing except near the antenna. Rather, fish tended to linger near the entrance to the trawl body and directly in front of the antenna, according to divers.

In previous years, we eliminated web size and color transitions in the trawl body and cod end that appeared to provide an area of orientation to fish and delayed their passage out of the net. We continued to flush the net to reduce pacing and expedite fish passage through the antenna.

Diel Detection Patterns

We conducted four diel sampling efforts during May and June 2001 and detected 2,269 yearling chinook salmon and 124 steelhead (Figure 9). Detections of juvenile sockeye and coho salmon were too few (< 30) to provide meaningful comparisons. During these sampling sessions, the detector was energized and recording data for a total of 173 h, with effort in the four periods ranging from 35 to 59 h (Appendix Table B5). Detections rates of yearling chinook salmon were greater during dark than during daylight (19.1 vs. 8.4 fish/h, respectively; $P < 0.01$), whereas detection rates of steelhead decreased slightly during darkness compared to daylight, but the difference was not significant (0.5 vs. 0.9, respectively; $P = 0.22$).

Yearling chinook salmon, 2001
n = 2,269

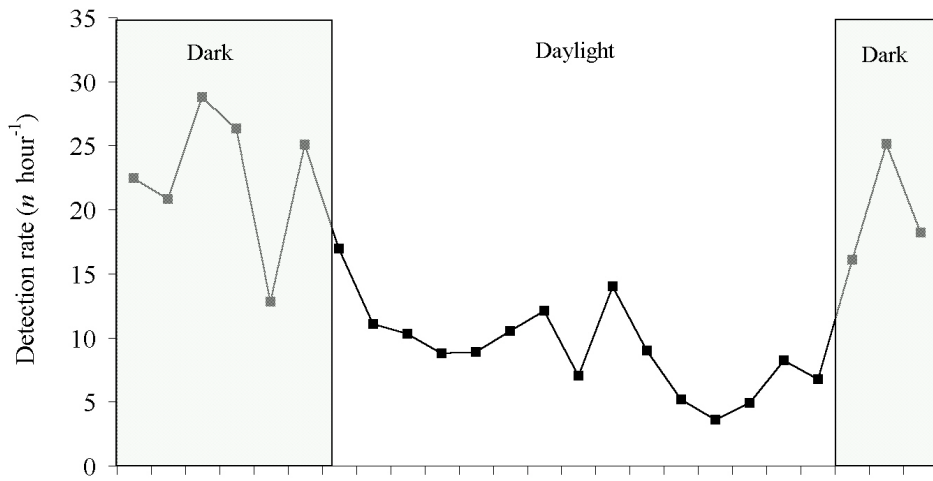

Steelhead, 2001
n = 124

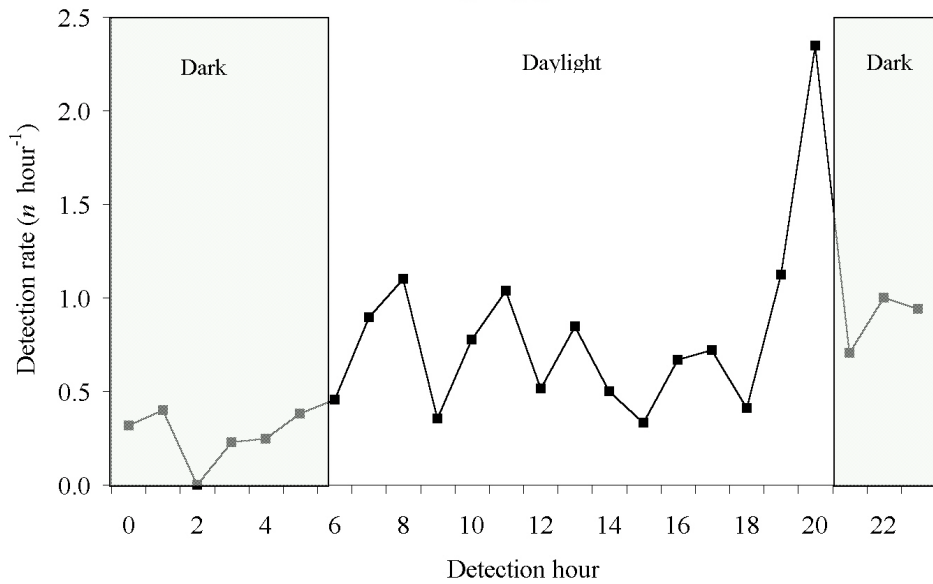

Figure 9. Average hourly detection rates of yearling chinook salmon and steelhead during four continuous diel sampling periods (35 h) in the Columbia River estuary at Jones Beach, Rkm 75.

Timing and Migration History Comparisons

For both yearling chinook and steelhead, travel time for in-river migrating fish from the tailrace of Lower Granite Dam to Jones Beach was nearly twice as fast in 2000 as in 2001. In 2000, median travel time was 17 d for both species, while in 2001, median travel time was 33 d for yearling chinook salmon and 30 d for steelhead (Figure 10). Travel time for in-river migrants from detection at Bonneville Dam to detection in the estuary was similar, with median travel times of 1.7 d for both species in 2000 and 2.3 and 2.5 d for yearling chinook salmon and steelhead, respectively in 2001.

Slower travel times from barge-release sites to the estuary in 2001 than in 2000 were also observed from barge-release sites to the estuary: median travel time was 2.0 d for yearling chinook and 1.6 d for steelhead in 2000 and was 2.9 and 2.3 d respectively for these two species in 2001. All between-year differences in median travel time were significant ($P < 0.05$; Figures 11-12). Further comparisons of travel time distributions among and between years, species, and rear types are presented in Appendix Table B6.

We also compared the daily differences in travel speed of fish based on migration history. Fish released from barges generally traveled to the estuary more slowly than those detected at Bonneville Dam on the same date (i.e., compared with fish thought to migrate to the estuary from Bonneville Dam in similar conditions; Figures 13-14). However, interactions between date of release from a barge or detection at Bonneville Dam, flow, and migration history (transported vs. in-river) were present in some comparisons.

Yearling chinook salmon and steelhead, 2000

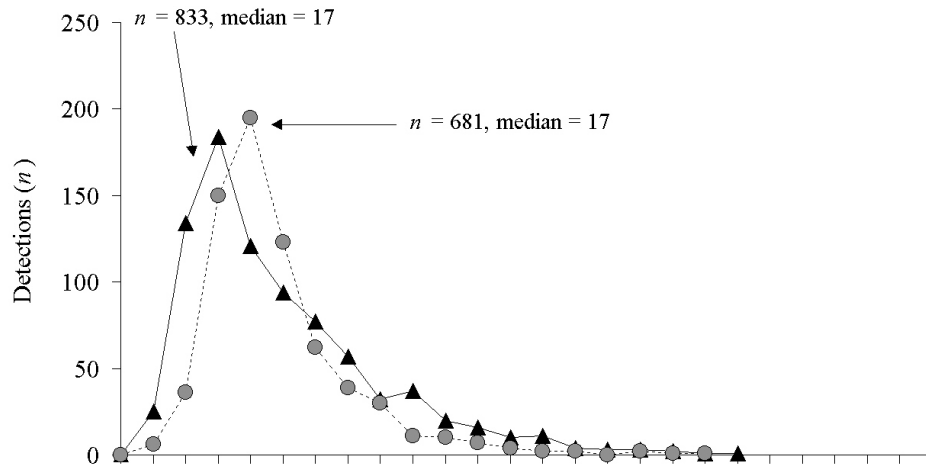

Yearling chinook salmon and steelhead, 2001

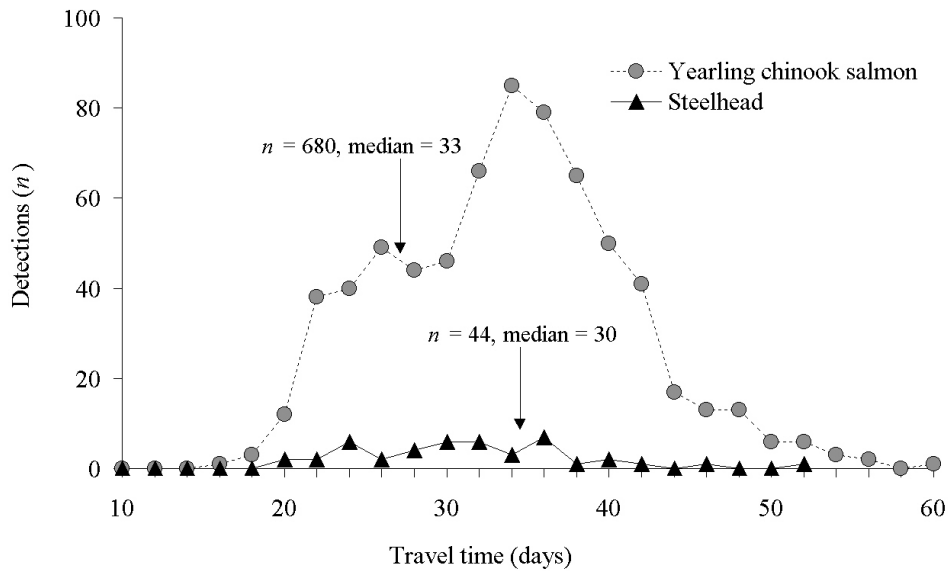
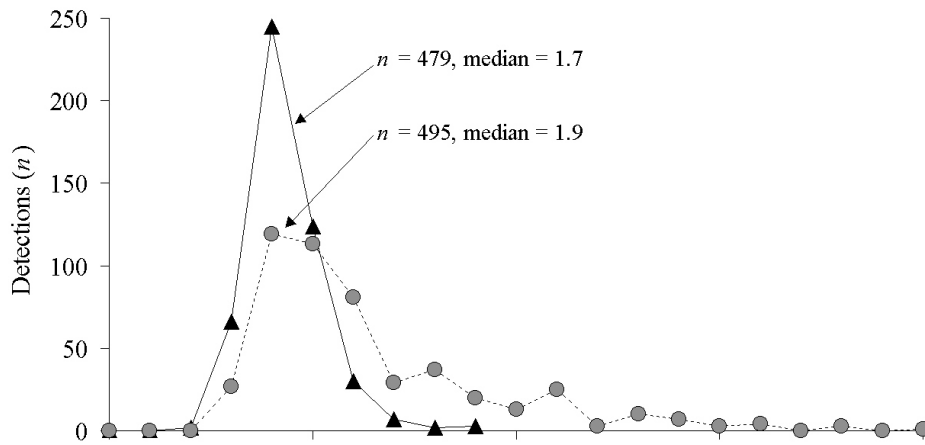

Figure 10. Travel time of in-river migrant yearling chinook salmon and steelhead from Lower Granite Dam to Jones Beach, 2000 and 2001.

Yearling chinook salmon, 2000



Steelhead, 2000

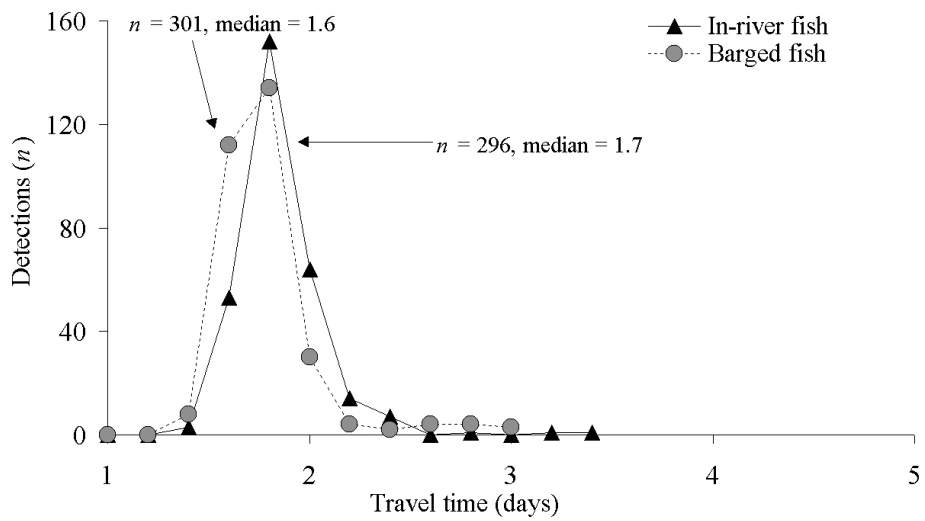
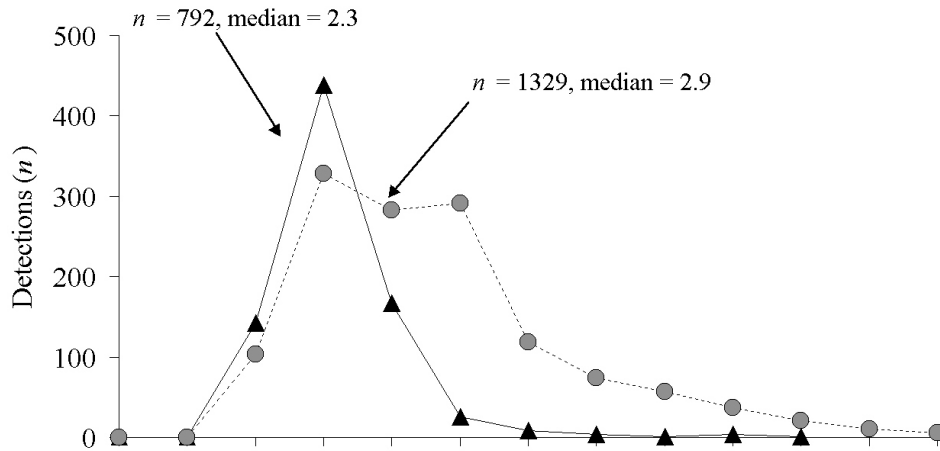

Figure 11. Travel time of in-river migrant and barge-transported yearling chinook salmon and steelhead from Bonneville Dam or barge release site to Jones Beach, 2000.

Yearling chinook salmon, 2001



Steelhead, 2001

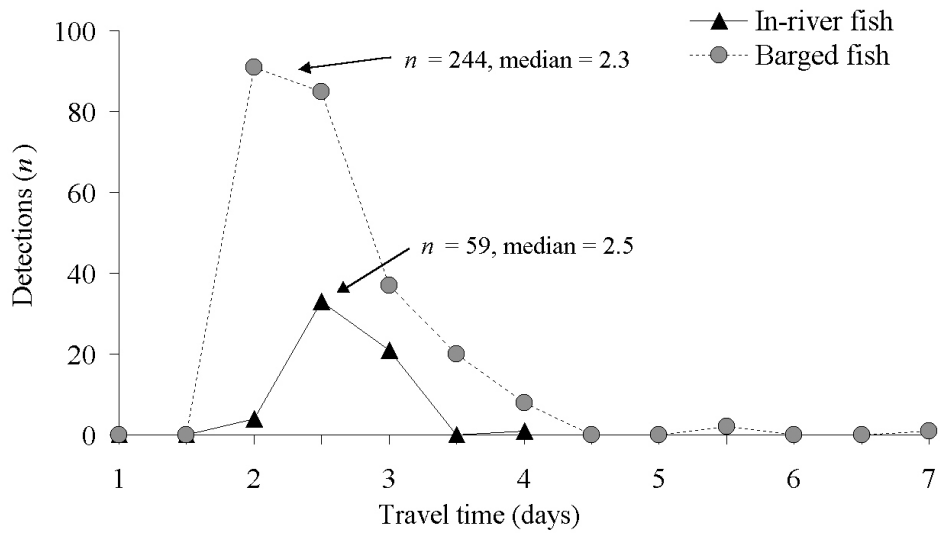

Figure 12. Travel time of in-river migrant and barge-transported yearling chinook salmon and steelhead from Bonneville Dam or barge release site to Jones Beach, 2001.

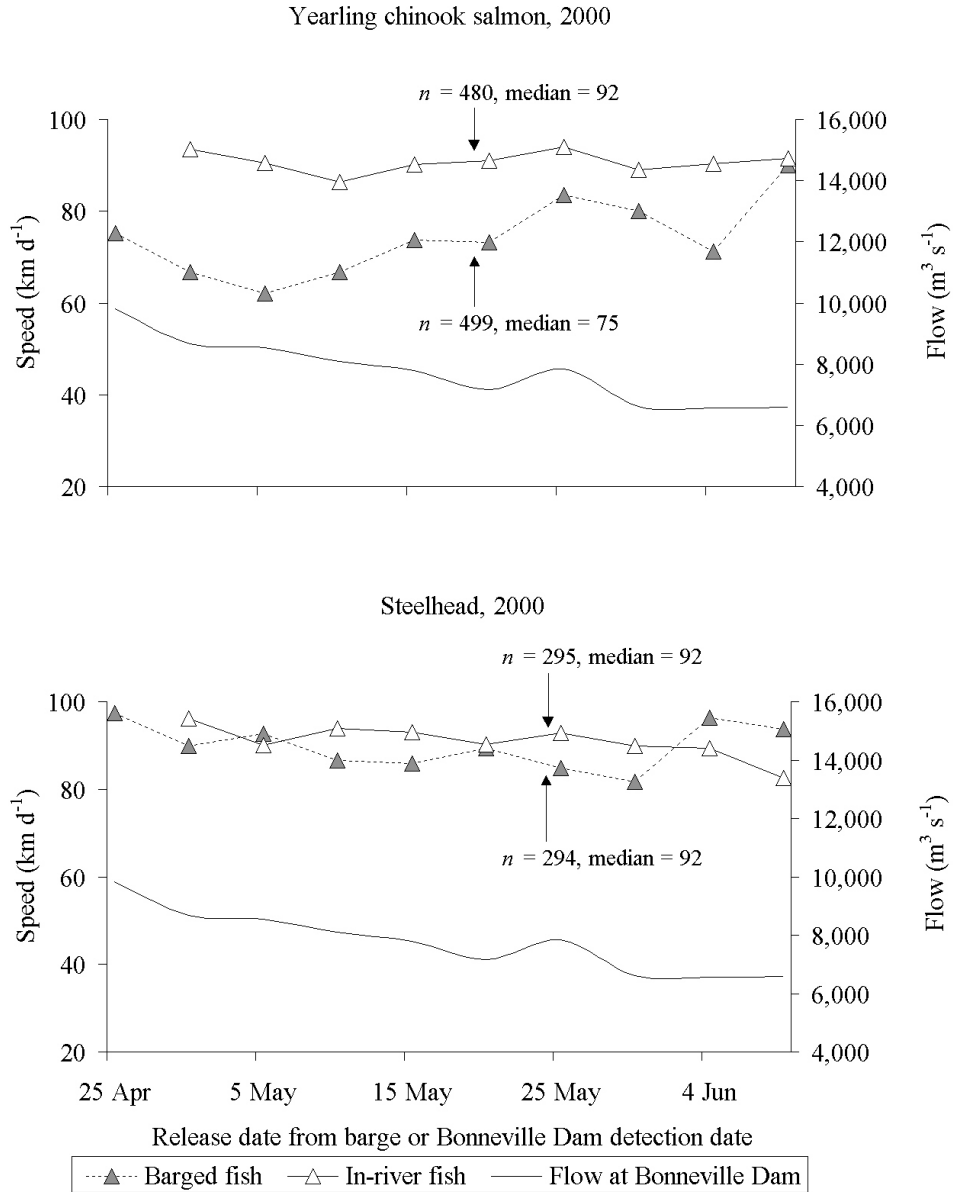

Figure 13. Travel speed of in-river migrant and barge-transported yearling chinook salmon and steelhead from Bonneville Dam or barge release site to Jones Beach, 2000.

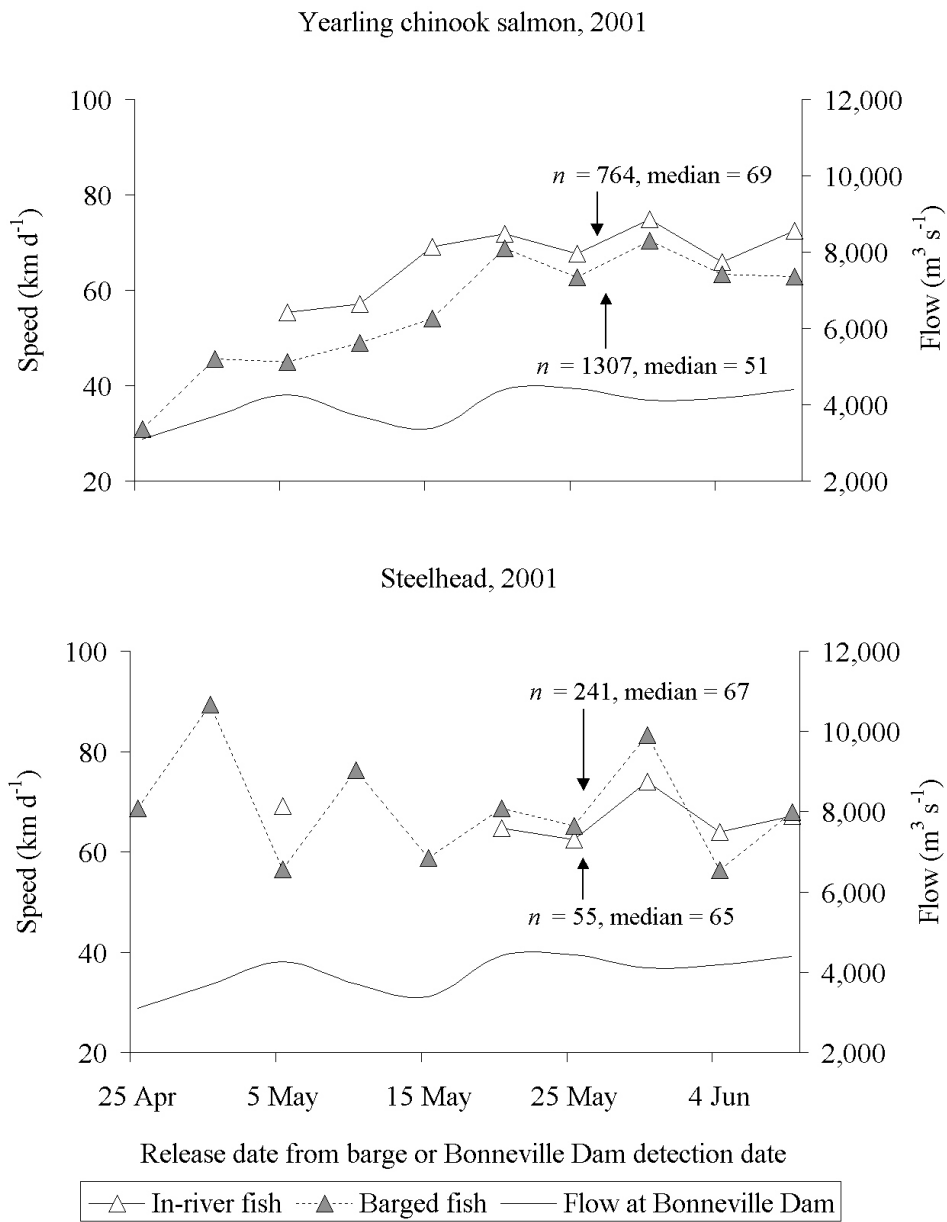

Figure 14. Travel speed of in-river migrant or barge-transported yearling chinook salmon and steelhead from Bonneville Dam or barge release site to Jones Beach, 2001.

In 2000, mean travel speed was 73 km d⁻¹ for transported and 91 km d⁻¹ for in-river migrant yearling chinook salmon. Travel speed in 2000 was 88 and 93 km d⁻¹ for transported and in-river steelhead, respectively. However, the average travel speed of transported chinook salmon increased during the migration season from about 60 to 80 km d⁻¹, while that of in-river migrant chinook remained fairly constant at about 90 km d⁻¹. For steelhead, there were no interactions between date and travel speed, although a decrease in travel speed of about 5 km d⁻¹ was correlated with a decrease in flow (a decrease of 2832 m³ produced a decrease in travel speed of 10 km d⁻¹).

In 2001, mean travel speeds of transported and in-river migrant fish were 61 and 68 km d⁻¹ for yearling chinook salmon and 67 and 66 km d⁻¹ for steelhead. These rates of movement were all considerably slower than in 2000. Interaction terms between date of release or detection at Bonneville Dam, flow and migration history (barge vs. in-river) existed such that for chinook salmon the difference between barged and inriver histories decreased from 10 km d⁻¹ early in the season to 5 km d⁻¹ later in the season. For steelhead, there were no interaction terms and the differences were not significant, though the small sample size (n = 60) for in-river migrants resulted in low power.

Travel speeds of yearling chinook salmon and steelhead migrating from the tailrace of Lower Granite Dam through seven dams and reservoirs to the estuary were not significantly different. Within-year comparisons of travel speeds from Lower Granite Dam to the estuary for yearling chinook salmon and steelhead were not significant ($P > 0.05$); travel speed means were 36 and 36 km d⁻¹ in 2000 and 19 and 21 km d⁻¹ in 2001, respectively (Figure 15).

Travel speed from detection at Bonneville Dam to the upper estuary appeared faster for steelhead with PIT-tags than for their cohorts implanted with radio tags. Both tagging groups were detected or released at Bonneville Dam during the same period. Respective median travel speeds from Bonneville Dam to the estuary for PIT-tagged and radio-tagged fish were 92 and 83 km d⁻¹ in 2000 and 65 and 61 km d⁻¹ in 2001 (Figure 16). PIT-tagged steelhead released from transport barges also appeared to travel to the estuary faster than radio-tagged fish transported during the same period. Respective median travel speeds for PIT-tagged and radio-tagged steelhead released from transport barges were 92 and 78 km d⁻¹ in 2000 and 67 and 56 km d⁻¹ in 2001 (Figure 17).

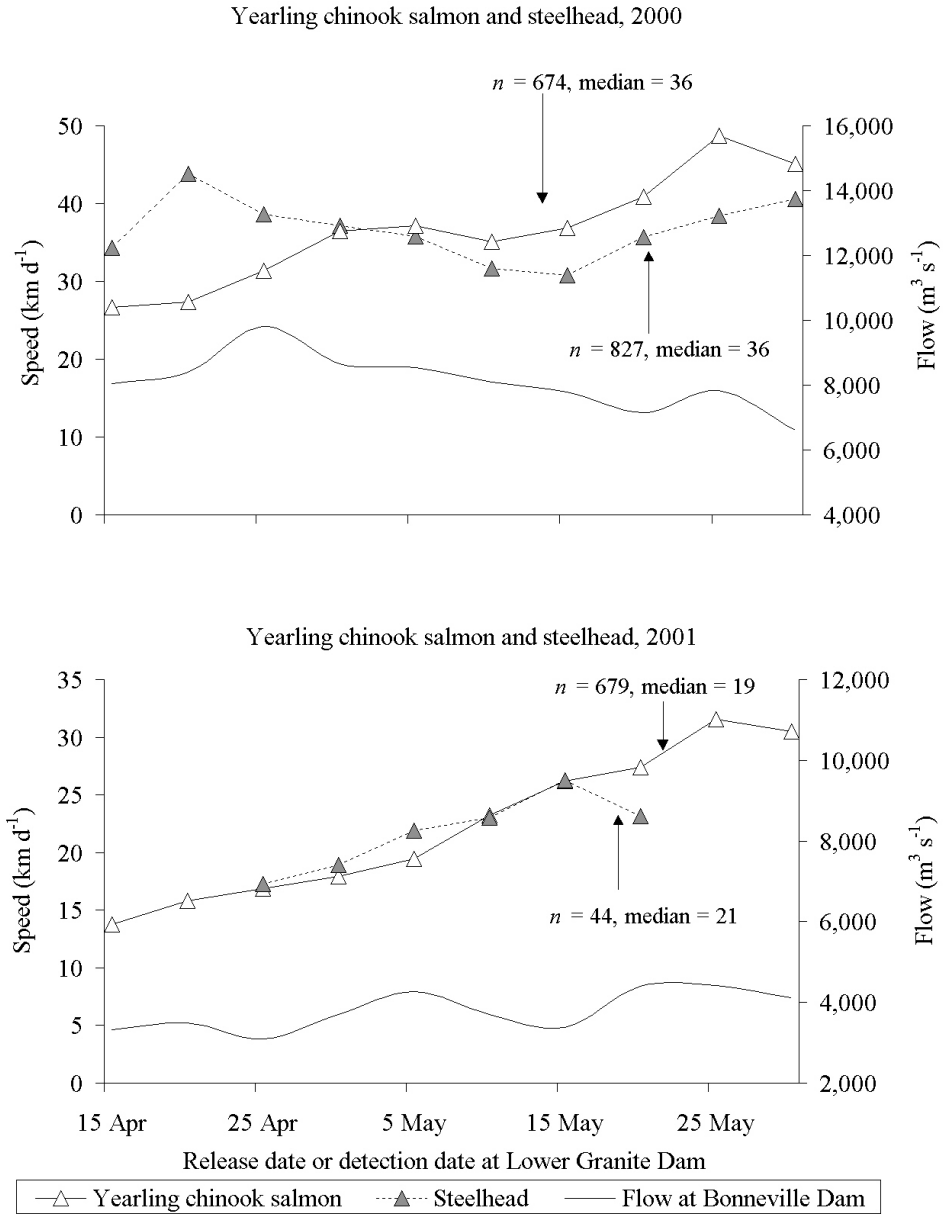

Figure 15. Travel speed of in-river migrant yearling chinook salmon and steelhead from Lower Granite Dam to Jones Beach, 2000 and 2001.

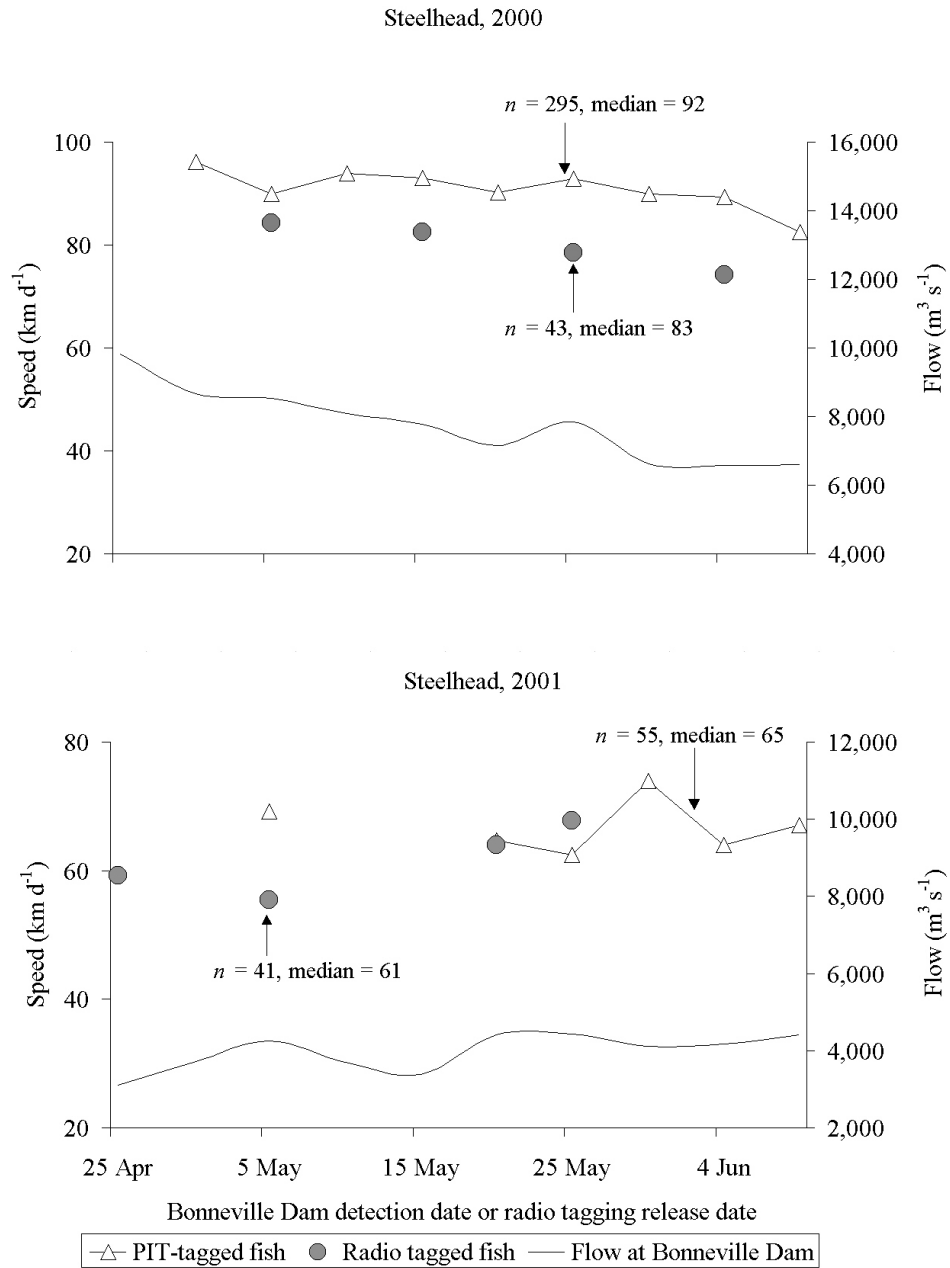

Figure 16. Travel speed of in-river migrant PIT-tagged and radio-tagged steelhead from Bonneville Dam to the upper Columbia River estuary, 2000 and 2001.

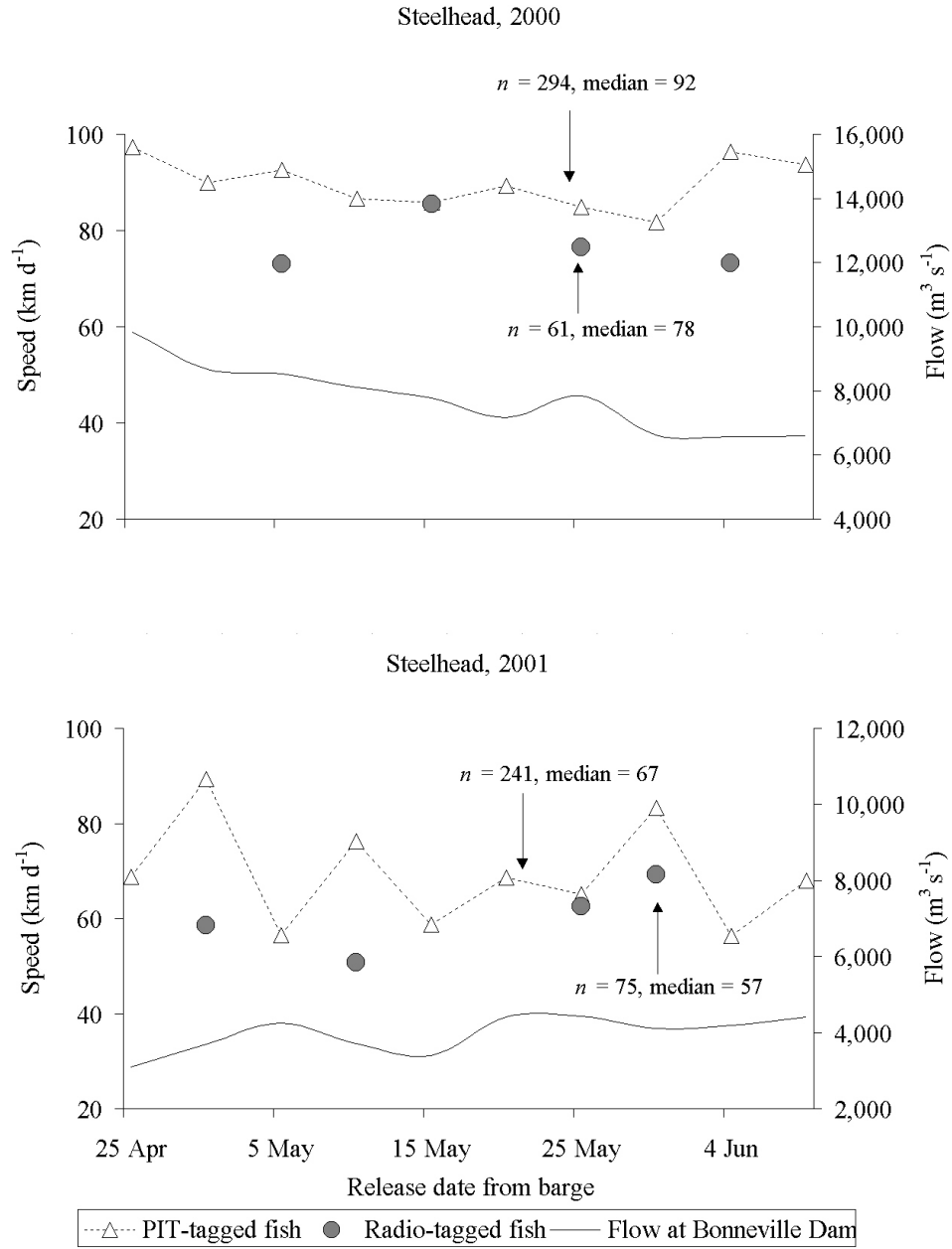

Figure 17. Travel speed from barge-release site to the upper Columbia River estuary of transported steelhead tagged with PIT vs. radio-tags in 2000 and 2001.

Transportation Evaluation

Despite curtailment of the Snake River transportation study due to the drought, the numbers of PIT-tagged fish transported from all dams in 2001 (171,373) was greater than the number transported in 2000 (105,262; Appendix Tables B7-B10). Similarly, the number of transported PIT-tagged fish detected in the estuary in 2001 (1,750) was more than double the number detected in 2000 (819).

Using logistic regression analysis, we compared the daily detection percentages of transported fish to the daily detection percentages of in-river migrant fish previously detected in the juvenile sampling facilities at Bonneville Dam (Appendix Tables B11 and B12). We also compared the detection rates of fish released from the same barge but loaded at different dams. Barge releases early in the season often occurred before there were sufficient in-river migrant fish detected at Bonneville Dam for comparison.

Transported vs. In-river Migrant Fish Detected at Bonneville Dam

During intensive sampling in 2000, 73,731 PIT-tagged yearling chinook salmon were released from transportation barges and 30,840 were detected at Bonneville Dam. Of these, we detected 501 (0.7%) of the transported and 480 (1.6%) of the in-river migrant fish. Logistic regression analysis showed a significant interaction between date of barge release or Bonneville Dam detection and migration history ($P = 0.004$). Estimated sampling efficiency was higher in early May for in-river migrants previously detected at Bonneville Dam than for fish released from barges (1.6 and 0.8%, respectively), but that difference disappeared by the end of May (both around 2.0%; Figure 18).

Of the 24,056 PIT-tagged steelhead released from transportation barges and the 16,602 detected at Bonneville Dam in 2000, we detected 302 (1.3%) and 297 (1.8%), respectively. Analysis showed no interaction between migration history and date of estuary detection ($P = 0.441$), and although its effect was not significant at $P < 0.05$, ($P = 0.098$), we left migration history in the model because it was significant at the 0.10 level and because it had been a significant effect in previous years. Also, detection efficiencies for both migration history groups increased steadily through the season ($P < 0.001$) from about 1% in late April to about 4% by late May (Figure 18). This increase may have been related to a corresponding decrease in river flow.

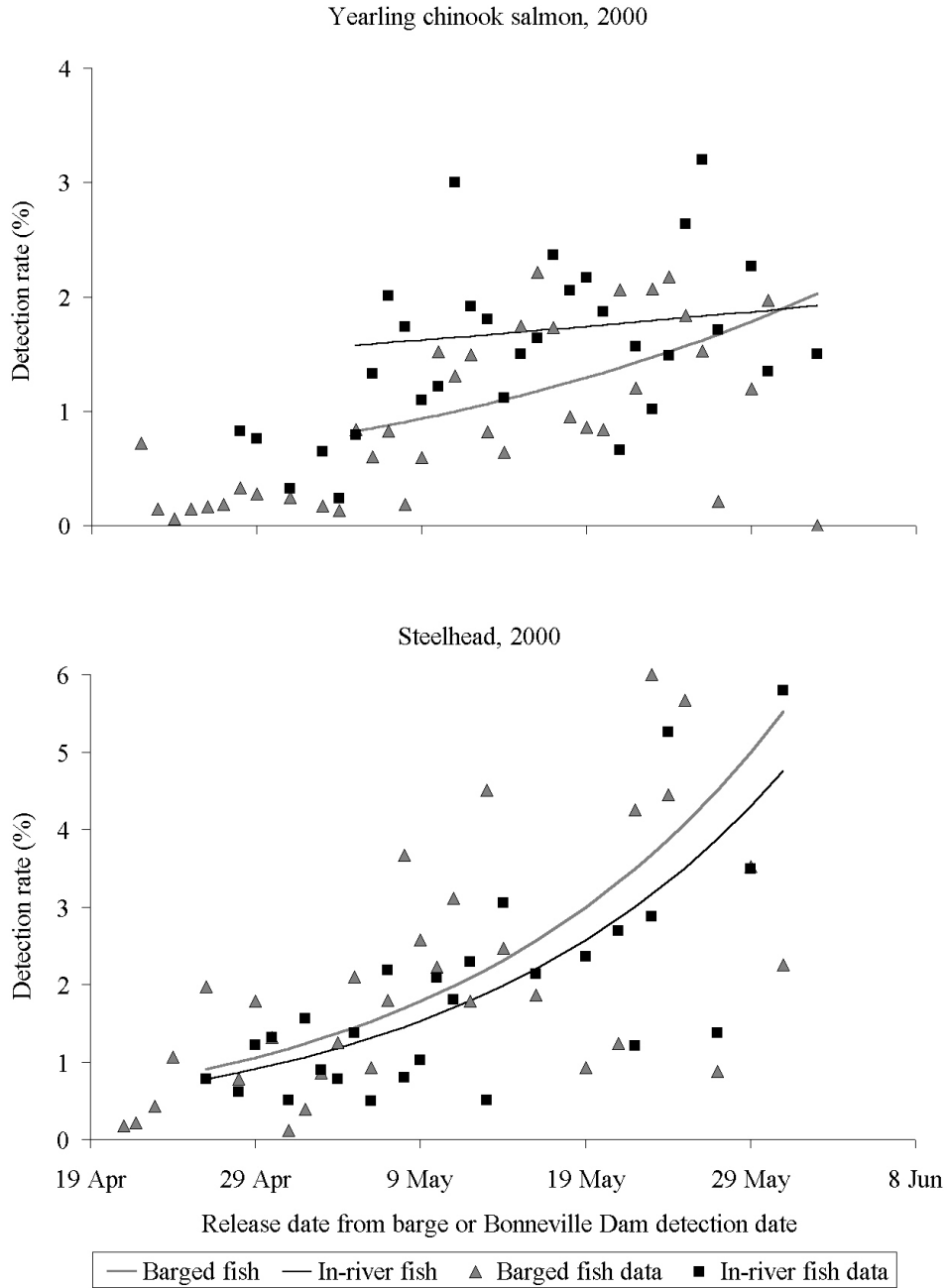

Figure 18. Logistic regression analysis of the daily detection percentages of barge-transported and in-river chinook salmon and steelhead detected at Bonneville Dam, 2000.

During our sampling period in 2001, 100,533 PIT-tagged yearling chinook salmon were released from transportation barges and 32,073 were detected in the bypass system at Bonneville Dam. Of these, we detected 1,403 (1.4%) of the transported and 793 (2.5%) of the in-river migrant fish. Analysis showed no significant interaction between date of barge release or detection at the dam and migration history ($P = 0.986$), and there was no seasonal trend in overall detection rates ($P = 0.097$). However, date of release or detection at Bonneville Dam was left in the regression model because the P value was significant at the 0.10 level and because date was significant in previous years. Detection efficiency was about 1% higher for in-river migrants previously detected at Bonneville Dam through the season (range 2.2 to 2.6%) than for fish released from barges (1.4 to 1.6%; $P < 0.001$; Figure 19).

Of the 17,191 PIT-tagged steelhead released from transportation barges and the 1,653 detected at Bonneville Dam, we detected 333 (2.0%) and 59 (3.6%), respectively. Analysis showed no interaction between date and treatment ($P = 0.618$) and date was not a significant factor in the season trend ($P = 0.897$). There was a significant treatment effect ($P = 0.005$), and the detection efficiency through the season was about 1.5% higher for in-river migrants previously detected at Bonneville Dam (4.1%) than for fish released from barges (2.6%; Figure 19).

Detections of Transported Fish by Barge Loading Site

In the following analysis, we compared estuarine detection rates of fish released from the same barge but loaded at different dams. Detection rates of fish loaded at the uppermost dam, Lower Granite Dam, were generally compared to the pooled detection data for fish loaded at the downstream dams, Little Goose, Lower Monumental, and McNary Dams in 2001 only.

In 2000, we detected 171 (0.5%) of the 33,551 PIT-tagged yearling chinook salmon loaded at Lower Granite Dam and 330 (0.8%) of the 40,220 loaded at Little Goose and Lower Monumental Dams (Figure 20). There was no significant interaction between barge release date and loading site ($P = 0.494$). There was an increase in detection percentages through the season ($P < 0.001$), and fish loaded at Lower Granite Dam were detected at lower rates than fish loaded at downstream dams ($P < 0.001$). The difference in detection rates between loading sites was around 0.2% in mid-April and increased to around 1.0% in mid-May, but the relative difference (i.e., ratio) was constant at 0.6.

Yearling chinook salmon, 2001

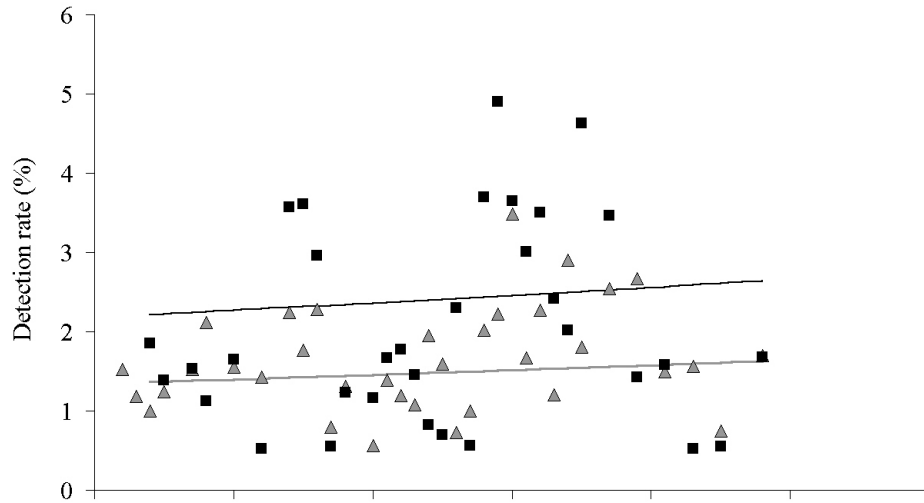

Steelhead, 2001

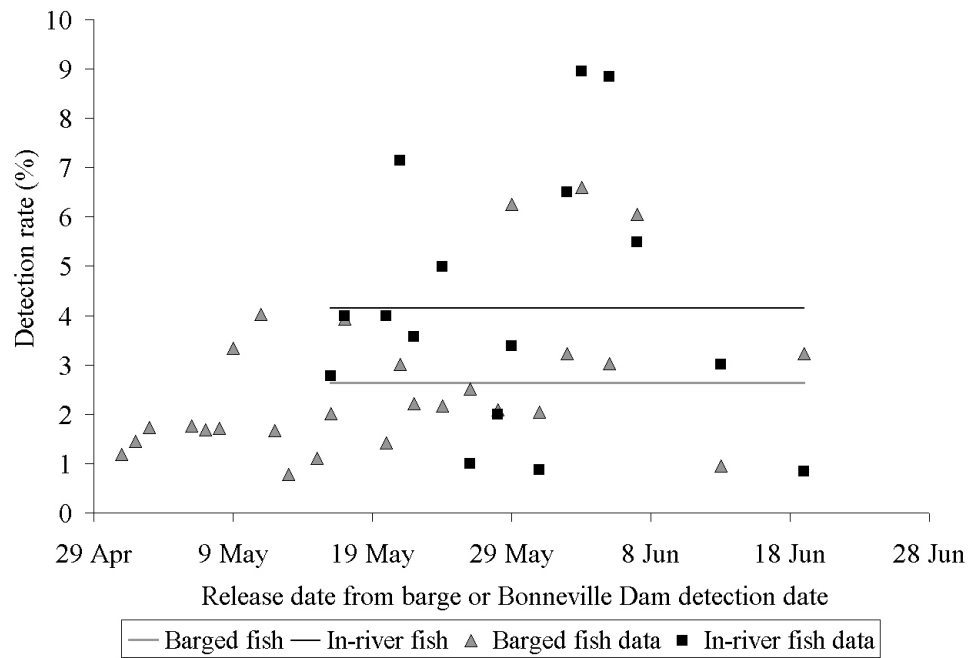
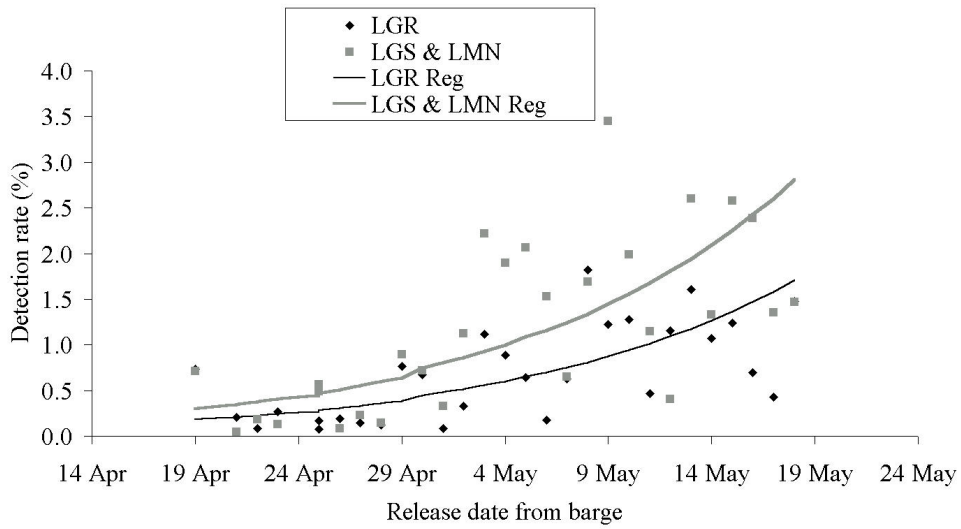

Figure 19. Logistic regression analysis of the daily detection percentages of barge-transported and in-river chinook salmon and steelhead detected at Bonneville Dam, 2001.

Transport Dam Comparison
Yearling chinook salmon, 2000



Transport Dam Comparison
Steelhead, 2000

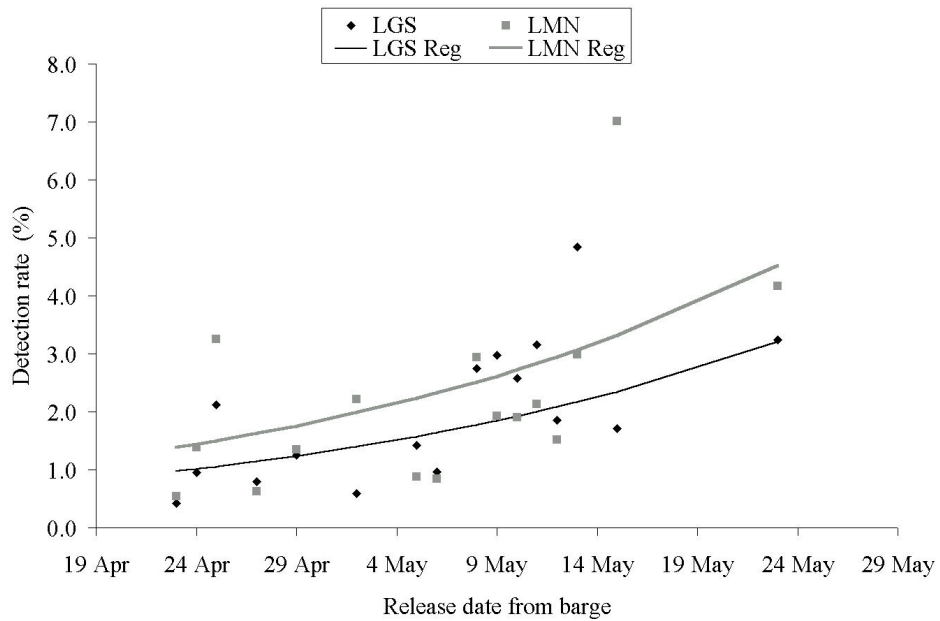

Figure 20. Daily recovery rates of yearling chinook salmon and steelhead released from barges loaded at Lower Granite (LGR) or other downstream dams (LGS = Little Goose Dam; LMN = Lower Monumental Dam), 2000.

In 2000, we detected 7 (1.2%) of the 599 PIT-tagged steelhead loaded at Lower Granite Dam and 295 (1.3%) of the 23,457 loaded at downstream dams. Possible seasonal trends are presented in Figure 20, but were not analyzed due to the small sample size of fish loaded at Lower Granite Dam (Figure 20).

In 2001 we detected 986 (1.3%) of the 73,263 transported yearling chinook salmon loaded at Lower Granite Dam 417 (1.5%) of the 27,270 loaded at Little Goose, Lower Monumental, and McNary Dams. There was no significant interaction between date of estuary detection and loading site ($P = 0.645$) and no increase through the season ($P = 0.774$). The estuary detection rate of fish loaded at Lower Granite Dam was 0.2% lower than that of fish loaded at the downstream dams ($P = 0.044$; Figure 21).

In 2001, we detected 296 (1.9%) of the 15,731 PIT-tagged steelhead loaded at Lower Granite Dam and 37 (2.5%) of the 1,460 loaded at downstream dams. Neither date nor loading site were related to detection percentage ($P = 0.240$; Figure 21).

Survival Estimates of In-river Migrants to Bonneville Dam

Detection data from the trawl are essential for calculating survival probabilities for juvenile salmonids to Bonneville Dam, the last dam encountered by seaward migrants (Muir et al. 2001, Williams et al. 2001, Zabel et al. 2002). Detections of yearling chinook salmon and steelhead arriving at McNary Dam were pooled weekly, and survival probabilities of fish released in the Snake and mid-Columbia Rivers were estimated from McNary to John Day, John Day to Bonneville, and McNary to Bonneville Dams (Table 5). Estimated survival probabilities were lower in 2001 than in 2000 in every instance where sample sizes were adequate for an estimate.

For Snake River stocks, survival estimates in 2000 and 2001 were 64 and 50% for yearling chinook salmon and 58 and 25% for steelhead, respectively. For mid-Columbia River stocks, survival of steelhead from McNary to Bonneville Dam was estimated at 40%. Sample sizes were insufficient in both years for survival estimates of other stocks or reaches. Seasonal average survival of in-river migrants from the tailrace of Lower Granite to the tailrace of Bonneville Dam was 48.6 and 27.6% for yearling chinook salmon and 39.3 and 3.6% for steelhead in 2000 and 2001, respectively (Table 6). Survival probabilities through the entire hydropower system for both species in 2000 were similar to those in 1998-1999. In 2001, estimated survival probabilities for in-river migrants from Lower Granite Dam were considerably lower than in previous years, presumably due to drought conditions. However, most fish in the general population were transported that year.

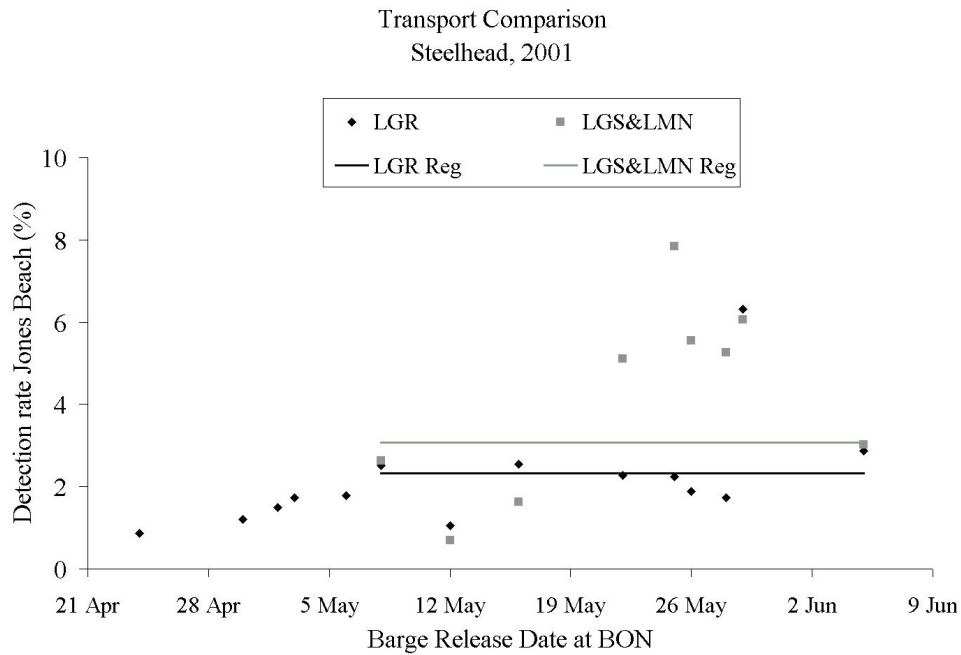
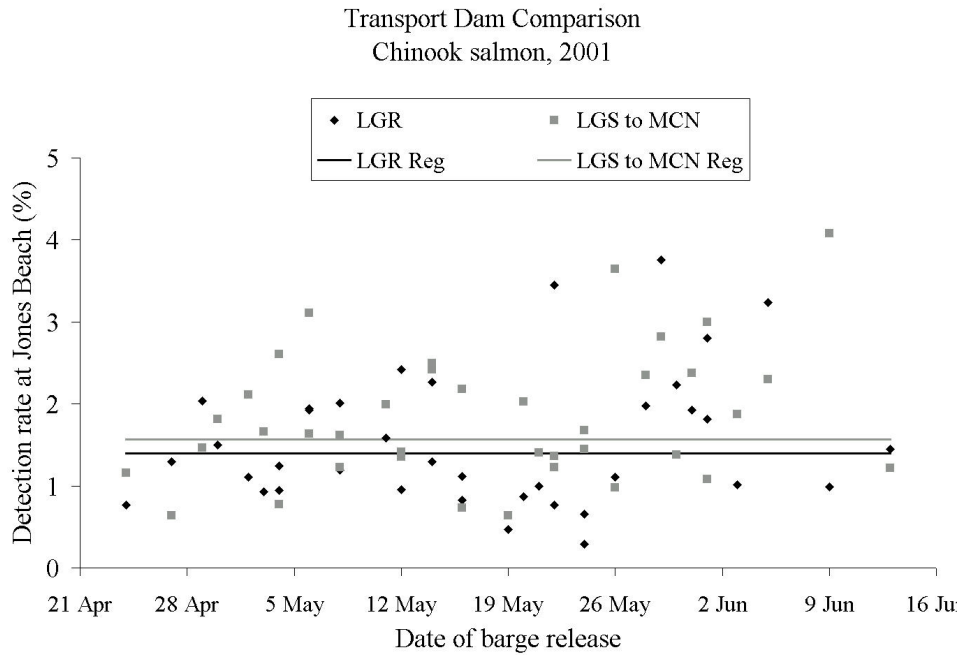

Figure 21. Daily recovery rates of yearling chinook salmon and steelhead released from barges loaded at Lower Granite (LGR) or other downstream dams (LGS=Little Goose Dam; LMN= Lower Monumental Dam), 2001.

Table 5. Weekly average survival percentages from the tailrace of McNary to Bonneville Dam for yearling chinook salmon and steelhead, 2000 and 2001. Total fish used in the survival estimates and weighted average survivals for each species, year, and water basin are presented.

Year	Week	<i>n</i>	McNary to John Day Dam		John Day to Bonneville Dam		McNary to Bonneville Dam	
			%	SE	%	SE	%	SE
Snake River Yearling Chinook salmon								
2000	20 Apr-26 Apr	1,392	89.8	6.9	NA	NA	NA	NA
	27 Apr-03 May	4,494	84.5	4.8	50.9	8.8	43.0	7.0
	04 May-10 May	8,391	98.3	8.7	108.6	24.7	106.8	22.4
	11 May-17 May	8,252	85.8	9.4	70.9	13.7	60.8	9.7
	18 May-24 May	5,151	121.9	23.1	51.0	13.3	62.2	11.1
	25 May-31 May	4,717	210.8	101.2	44.0	25.1	92.8	28.4
	Total/mean	32,397	89.8	4.2	68.4	9.9	64.0	12.2
2001	27 Apr-03 May	359	57.5	7.6	46.0	17.7	26.5	9.7
	04 May-10 May	2,642	68.9	3.2	74.7	17.8	51.5	12.1
	11 May-17 May	9,901	72.2	2.1	73.3	8.7	52.9	6.1
	18 May-24 May	18,902	78.9	2.4	59.7	4.8	47.1	3.5
	25 May-31 May	10,353	83.1	3.4	68.8	7.2	57.2	5.5
	01 Jun-07 Jun	4,052	79.5	5.4	47.0	10.6	37.4	8.0
	Total/mean	46,209	75.8	2.4	64.5	3.4	50.1	2.7
Snake River Steelhead								
2000	20 Apr-26 Apr	1,575	85.0	5.5	89.9	33.6	76.4	28.2
	27 Apr-03 May	2,112	89.9	5.1	74.8	20.8	67.2	18.3
	04 May-10 May	2,242	78.1	7.7	68.5	15.6	53.4	11.0
	11 May-17 May	1,486	72.0	12.0	89.1	29.5	64.2	18.4
	18 May-24 May	662	50.8	17.7	80.6	44.4	40.9	17.6
	25 May-31 May	708	46.6	29.6	81.8	73.2	38.1	24.1
	Total/mean	8,785	85.1	3.5	75.4	3.5	58.0	4.7
2001	04 May-10 May	181	40.8	6.3	86.8	61.5	35.4	24.9
	11 May-17 May	710	31.1	2.8	76.4	21.3	23.8	6.5
	18 May-24 May	2,034	31.9	3.7	81.6	22.2	26.0	6.5
	25 May-31 May	1,013	44.6	11.8	49.8	22.6	22.2	8.2
	Total/mean	3,938	33.7	2.5	75.3	6.3	25.0	1.6

Table 5. Continued.

Year	Week	<i>n</i>	McNary to John Day Dam		John Day to Bonneville Dam		McNary to Bonneville Dam	
			%	SE	%	SE	%	SE
Snake River Steelhead								
2000	20 Apr-26 Apr	105	61.9	15.8	NA	NA	NA	NA
	27 Apr-03 May	374	107.0	29.2	NA	NA	NA	NA
	04 May-10 May	923	58.4	12.0	NA	NA	NA	NA
	11 May-17 May	692	73.5	27.4	NA	NA	NA	NA
	18 May-24 May	585	48.4	19.0	NA	NA	NA	NA
	25 May-31 May	1,122	94.1	49.5	NA	NA	NA	NA
Total/mean		3,801	71.0	8.9				
2001	03 May-09 May	125	74.1	18.2	NA	NA	NA	NA
	10 May-16 May	573	72.9	7.0	NA	NA	NA	NA
	17 May-23 May	1,216	75.1	6.8	NA	NA	NA	NA
	24 May-30 May	2,297	96.2	7.5	NA	NA	NA	NA
	31 May-06 Jun	609	77.5	11.4	NA	NA	NA	NA
	07 Jun-13 Jun	63	37.0	13.4	NA	NA	NA	NA
	14 Jun-20 Jun	16	46.9	19.4	NA	NA	NA	NA
Total/mean		4,899	81.2	5.1				
Mid-Columbia River Steelhead								
2000	27 Apr-03 May	283	112.5	21.6	NA	NA	NA	NA
	04 May-10 May	1,390	122.3	15.4	62.3	32.5	77.3	38.4
	11 May-17 May	1,558	123.5	24.1	29.1	8.9	36.0	8.2
	18 May-24 May	770	89.7	21.6	NA	NA	NA	NA
	25 May-31 May	769	79.2	32.0	32.9	20.7	26.0	12.5
	01 Jun-07 Jun	281	41.6	25.7	NA	NA	NA	NA
Total/mean		5,051	113.4	7.3	36.9	9.5	40.5	11.1

Table 6. Estimated survival probabilities from the tailrace of Lower Granite Dam to Bonneville Dam for yearling chinook salmon and steelhead, 1998-2001.
SE = standard error, and 95% confidence limits for the respective means.

Migration year	Survival estimates					
	Yearling chinook salmon			Steelhead		
	(%)	SE	95% CI	(%)	SE	95% CI
1998	53.8	4.6	44.8-62.8	50.0	5.4	39.4-60.6
1999	55.7	4.6	46.7-64.7	44.0	1.8	40.5-47.5
2000	48.6	9.3	30.4-66.8	39.3	3.4	32.6-46.0
2001	27.6	1.6	24.5-30.7	4.2	0.3	3.6-4.8

Delay of Fish Detected at Bonneville Dam

To examine the assumption that treatment and control groups used in the single-release mark-recapture model for estimating survival were mixed downstream from Bonneville Dam, we analyzed travel time to Jones Beach of PIT-tagged fish released at The Dalles Dam in 2000 and detected (control group) or not detected (treatment group) at Bonneville Dam (Figure 22). Yearling chinook salmon not detected at the dam arrived at Jones Beach an average of 9.0 h sooner than those detected at the dam ($P < 0.01$); for coho the average difference of 4.2 h was not significant ($P = 0.29$). These differences in travel time were similar to those observed in 1999 for yearling chinook (5.8 h, $P < 0.01$) and coho salmon (4.4 h, $P = 0.09$; Ledgerwood et al. 2003). There was no PIT-tag fish study at The Dalles Dam in 2001 for comparison.

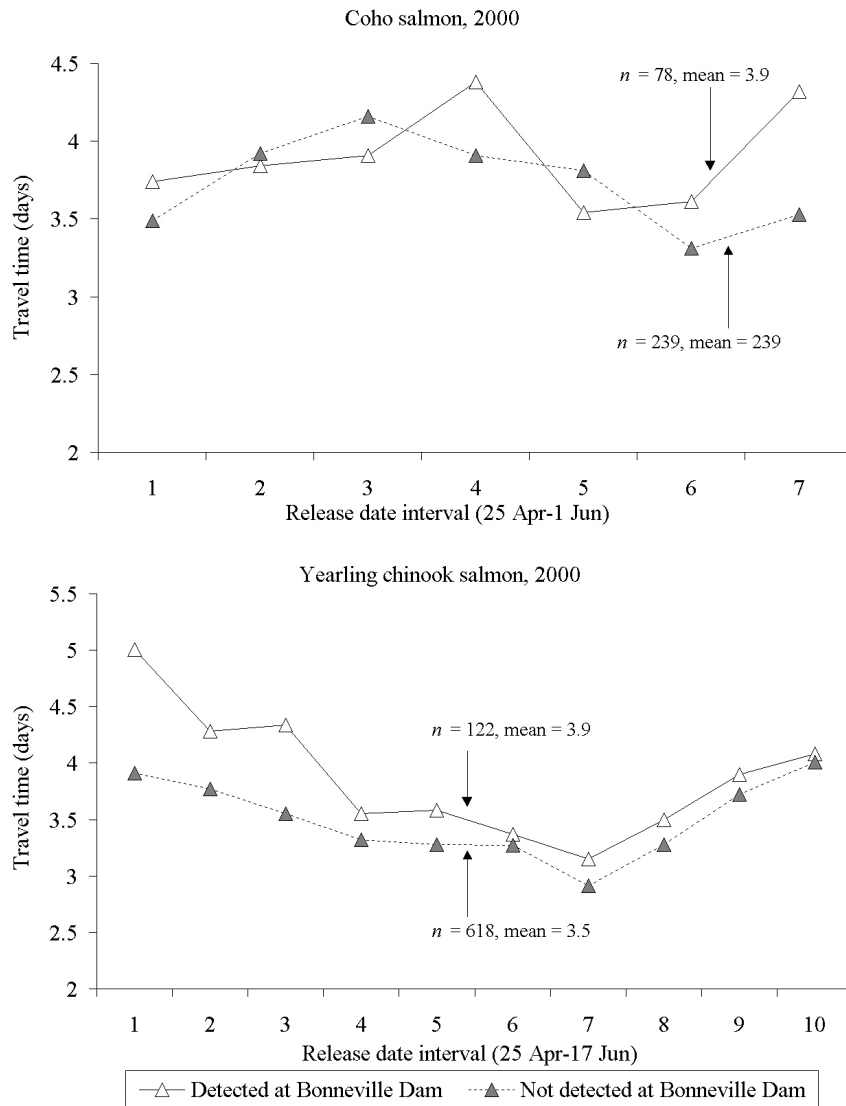

Figure 22. Travel time of in-river migrant coho salmon and yearling chinook salmon detected at Bonneville Dam or not detected at Bonneville Dam from The Dalles Dam to Jones Beach, 2000.

DISCUSSION

Although similar numbers of PIT-tagged fish were detected in the estuary in 2000 and 2001, major differences in detection efficiency, river flow volume, fish management, and tagging strategies affected our detection results.

Compared to previous years, the larger fish passage opening through the antenna afforded by 134.2-kHz technology in 2000 appeared to reduce delay of fish near the antenna. While flow through the antenna increased dramatically compared to 400-kHz antennas used in previous years, we continued to flush the net to avoid fatiguing fish that delayed near the head rope. The short antenna length (two or three fish body lengths) encouraged a portion of the fish to turn and actively swim downstream through the detection coil. Some fish were undoubtedly missed due to turning, which resulted in poor orientation of their PIT tag to the detection field.

Detection rates of test fish released at various locations in the trawl were generally low in 2000. However, it is possible that fish released from buckets, especially at sites far forward of the trawl body and net floor, escaped at high rates from the net. When multiple tagged fish were within the single coil electronic field, it is also likely that poor tag orientation and density compromised detection efficiency. This probably resulted in the low detection rate (41%) for batches of fish released just in front of the head rope, since these fish had less opportunity to escape than those released farther forward. The detection rate of individual fish released through a pipe directly in front of the antenna was 79%. We concluded that the single-coil PIT-tag antenna had a lower detection efficiency than desired.

The second coil and spacer added to the antenna in 2001 provided an additional opportunity to detect fish and appeared to improve orientation of fish during exit. Few fish were observed to turn in the longer antenna and exit facing downstream. Fish detected only on the downstream coil in 2001 would probably have been missed by the single-coil detection system used in 2000. These factors undoubtedly contributed to a generally higher detection rate of non-test fish in 2001 (i.e., higher detection rates of fish previously detected at Bonneville Dam).

Lower river volumes in 2001 resulted in noticeably less debris in the river, and thus considerably less time was spent cleaning and repairing the net than in 2000. Lower flows also contributed to slower travel speed of fish to the estuary and longer availability of fish to the trawl sampling (and to predators). For example, the median travel times from Lower Granite Dam to Jones Beach for yearling chinook salmon from 1996 to 2000

ranged from 15 to 19 d compared to 33 d in 2001. Therefore, we conclude that the factors associated with lower flow in 2001 contributed to increased sampling efficiency, but also contributed to the dramatic decrease in survival estimates of in-river migrants to Bonneville Dam in 2001.

To offset high expected mortality for in-river migrants due to drought in 2001, fishery managers increased the proportion of fish transported by barge. Consequently, the proportion of transported PIT-tagged fish we detected in the estuary increased from 13% in 2000 to 31% in 2001.

By comparing detection percentages of barge-transported fish to those of fish detected in-river passing Bonneville Dam, we assumed that the distributions in the sample area were similar. Visual inspection of travel-time distribution plots supported this assumption, although additional analyses of these distributions is warranted. Comparison of trawl detections from fish released from barges with those from fish detected at Bonneville Dam on the same day should properly reflect differences in survival to the estuary. Assuming that both groups were present on a given day, they were subject to the same sampling bias and river conditions.

The ratio of daily detections between transported and in-river migrant yearling chinook salmon decreased steadily in 2000, from 0.4:1.0 early in the season to 1.0:1.0 by season's end. However, the ratio of relative survival to the estuary remained nearly constant and high through the entire season in 2001, at about 0.5 transported fish to 1.0 in-river migrant. PIT-tagged steelhead were released in lower numbers than yearling chinook salmon, and comparisons of detection efficiency between transported and in-river migrants were inconsistent between years.

These differences in relative survival may reflect the degree of delayed mortality experienced by fish following transportation, and it is possible that for steelhead in 2000 there was little delayed mortality between barge release and the estuary. Bonneville Dam and other dams now have detection systems designed for monitoring upstream migrating adult salmon containing 134.2-kHz PIT tags. Detections of adult fish at these sites will facilitate comparison of smolt to adult return ratios by date of transport and release.

Following release at The Dalles Dam in 2000, both yearling chinook and coho salmon detected in the juvenile bypass system at Bonneville Dam took longer to reach Jones Beach than those not detected at Bonneville Dam, a trend similar to that seen in 1999. We believe that the mechanism for the observed differences in travel time was delay of fish passing Bonneville Dam through the powerhouse (detected group) compared to the non-detected group.

The majority of the non-detected group presumably passed through the spillway or through turbines. Radio-tracking information of fish arriving in the forebay at Bonneville Dam during daylight showed little delay of fish passing via the spillway and delays of up to several hours for fish entering the powerhouse (H. Hansel, USGS, personal communication). These differences in travel time seemingly affect the single-release survival assumption that there is equal probability of detecting both groups of fish downstream from Bonneville Dam.

Because of its size, the Columbia River estuary is difficult to sample with sufficient consistency to discern migration timing or survival trends among the juvenile salmonids passing through it. PIT-tag technology has proven a useful tool at hydroelectric facilities to specifically identify and evaluate fish groups of interest. Development of the surface trawl PIT-tag detection system has proven valuable to understanding differences in migration behavior and survival between a variety of fish populations with differing life histories that enter the Columbia River estuary.

ACKNOWLEDGMENTS

We gratefully acknowledge the NOAA Dive Team for the many low-visibility and cold dives provided which were essential for the successful application of PIT-tag technology to a trawl sampler. We thank David Marvin of PSMFC, Portland, Oregon for his assistance in obtaining information from the PTAGIS database. Mike Halstead, Research Nets, Inc., is gratefully acknowledged for the many discussions freely provided through the years of development of the trawl.

We thank Lyle Gilbreath, Randy Absolon, Bruce Monk, and David Miller and NMFS Bonneville Dam for supplying us with batches of known PIT-tagged fish for test releases into our trawl. Special thanks go to the boat operations crews for their personal flexibility while keeping us safe and “underway” for the extended sampling periods each year. We also gratefully acknowledge Rebecca Kalamaz of the U.S. Army Corps of Engineers for helping fund this project.

REFERENCES

- Absolon, R. F., E. M. Dawley, B. P. Sandford, J. W. Ferguson, and D. A. Brege. 2002. Relative survival of juvenile salmon passing through the spillway of The Dalles Dam, 1997-2000. Report of the National Marine Fisheries Service to the U.S. Army Corps of Engineers, Portland, Oregon.
- Berggren, T. J., and L. R. Basham. 2000. Comparative survival rate study (CSS) of hatchery PIT tagged chinook: status report for migration years 1996-1998 mark/recapture activities. Report to Bonneville Power Administration. Available from Fish Passage Center, Portland, Oregon.
- Cormack, R. M. 1964. Estimates of survival from the sightings of marked animals. *Biometrika* 51:429-438.
- Dawley, E. M., R. D. Ledgerwood, T. H. Blahm, C. W. Sims, J. T. Durkin, R. A. Kim, A. E. Rankis, G. E. Monan, and F. J. Ossiander. 1986. Migrational characteristics, biological observations, and relative survival of juvenile salmonids entering the Columbia River estuary, 1966-1983. Report of the U.S. National Marine Fisheries Service to the U.S. Department of Energy, Bonneville Power Administration, Portland, Oregon.
- Downing, S.L., E. F. Prentice, R.W. Frazier, J. E. Simonson, and E. P. Nunnallee. 2001. Technology developed for diverting passive integrated transponder (PIT) tagged fish at hydroelectric dams in the Columbia River Basin. *Aquacultural Engineering* 25:149-164.
- Efron, B., and R. J. Tibshirani. 1993. An introduction to the bootstrap. Chapman and Hall, New York.
- Harmon J. R., D. M. Marsh, N. N. Paasch, K. L. Thomas, K. W. McIntyre, B. P. Sandford, and -G. M. Matthews. 2000. Research related to transportation of juvenile salmonids on the Columbia and Snake Rivers, 1999. Report of the U.S. National Marine Fisheries Service to the U.S. Army Corps of Engineers, Walla Walla, Washington.
- Hosmer, D. W., and S. Lemeshow. 1989. Applied logistic regression. Wiley, New York.

- Ledgerwood, R.D., E. M. Dawley, L. G. Gilbreath, P. J. Bentley, B. P. Sanford, and M. H. Schiewe. 1990. Relative survival of subyearling chinook salmon which have passed through Bonneville Dam via the spillway or the Second Powerhouse turbines or bypass system in 1989, with comparisons to 1987 and 1988. Report of the National Marine Fisheries Service to the U.S. Army Corps of Engineers, Portland, Oregon.
- Ledgerwood, R. D., E. M. Dawley, B. W. Peterson, and R. N. Iwamoto. 1997. Estuarine recovery of PIT-tagged juvenile salmonids from the Lower Granite Dam Transportation Study, 1996. Report of the National Marine Fisheries Service to the U.S. Army Corps of Engineers, Walla Walla, Washington.
- Ledgerwood, R. D. J. W. Ferguson, B. A. Ryan, E. M. Dawley, and E. P. Nunnallee. In press. A surface trawl to detect migrating juvenile salmonids tagged with passive integrated transponder tags. North American Journal of Fisheries Management.
- Ledgerwood, R. D., B. A. Ryan, C. Z. Banks, E. P. Nunnallee, B. P. Sanford, S.G. Smith, and J. W. Ferguson. 2003. Detection of PIT-tagged juvenile salmonids in the Columbia River estuary using a surface-trawl detection system, 1999. Report of the National Marine Fisheries Service to the U.S. Army Corps of Engineers, Walla Walla, Washington.
- Ledgerwood, R. D., B. A. Ryan, E. P. Nunnallee, and J. W. Ferguson. 2000. Estuarine recovery of PIT-tagged juvenile salmonids from the Lower Granite Dam Transportation Study, 1998. Report of the National Marine Fisheries Service to the U.S. Army Corps of Engineers, Walla Walla, Washington.
- Marsh, D. M., J. R. Harmon, K. W. McIntyre, K. L. Thomas, N. N. Paasch, B. P. Sandford, D. J. Kamikawa, and G. M. Matthews. 1996. Research related to transportation of juvenile salmonids on the Columbia and Snake Rivers, 1995. Report of the National Marine Fisheries Service to the U.S. Army Corps of Engineers, Walla Walla, Washington.

- Marsh, D. M., J. R. Harmon, N. N. Paasch, K. L. Thomas, K. W. McIntyre, B. P. Sandford, and G. M. Matthews. 1997. Research related to transportation of juvenile salmonids on the Columbia and Snake Rivers, 1996. Report of the National Marine Fisheries Service to the U.S. Army Corps of Engineers, Walla Walla, Washington.
- Marsh, D. M., J. R. Harmon, N. N. Paasch, K. L. Thomas, K. W. McIntyre, B. P. Sandford, and G. M. Matthews. 1998. Research related to transportation of juvenile salmonids on the Columbia and Snake Rivers, 1997. Report of the National Marine Fisheries Service to the U.S. Army Corps of Engineers, Walla Walla, Washington.
- Marsh, D. M., J. R. Harmon, N. N. Paasch, K.L. Thomas, K.W. McIntyre, B. P. Sandford, and G. M. Matthews. 2000. Research related to transportation of juvenile salmonids on the Columbia and Snake Rivers, 1998. Report of the National Marine Fisheries Service to the U.S. Army Corps of Engineers, Walla Walla, Washington.
- Marsh, D. M., J. R. Harmon, N. N. Paasch, K. L. Thomas, K. W. McIntyre, B. P. Sandford, and G. M. Matthews. 2003. Research related to transportation of juvenile salmonids on the Columbia and Snake Rivers, 2001. Report of the National Marine Fisheries Service to the U.S. Army Corps of Engineers, Walla Walla, Washington
- Muir, W. D., S. G. Smith, J. G. Williams, E. E. Hockersmith, and J. R. Skalski. 2001. Survival estimates for migrant yearling chinook salmon and steelhead tagged with passive integrated transponders in the lower Snake and lower Columbia Rivers, 1993-1998. *North American Journal of Fisheries Management* 21:269-282.
- Prentice, E. F., S. L. Downing, E. P. Nunnallee, B. W. Peterson, and B. F. Jonasson. 1999. A study to determine the biological feasibility of a new fish-tagging system, 1997-1998. Report of the U.S. National Marine Fisheries Service to the Bonneville Power Administration, Portland, OR.
- Prentice, E. F., T. A. Flagg, and C. S. McCutcheon. 1990a. Electronic tags. *American Fisheries Society Symposium* 7:317-322.
- Prentice, E. F., T. A. Flagg, C. S. McCutcheon, and D. F. Brastow. 1990b. PIT-tag monitoring systems for hydroelectric dams and fish hatcheries. *American Fisheries Society Symposium* 7:323-334.

- Prentice, E. F., T. A. Flagg, C. S. McCutcheon, D. F. Brastow, and D. C. Cross. 1990c. Equipment, methods, and an automated data-entry station for PIT tagging. *American Fisheries Society Symposium* 7:335-340.
- PSMFC (Pacific States Marine Fisheries Commission). 2002. The Columbia Basin PIT Tag -Information System (PTAGIS). Online interactive database, Pacific States Marine Fisheries Commission, Gladstone, Oregon (available via the internet at www.psmfc.org/pittag).
- Ryan, B. A., J. W. Ferguson, R. D. Ledgerwood, and E. P. Nunnallee. 2001. Detection of passive integrated transponder tags from juvenile salmonids on piscivorous bird colonies in the Columbia River Basin. *North American Journal of Fisheries Management* 21:417-421.
- Seber, G. A. F. 1965. A note on the multiple recapture census. *Biometrika* 52:249-259.
- Skalski, J. R., S. G. Smith, R. N. Iwamoto, J. G. Williams, and A. Hoffman. 1998. Use of passive integrated transponder tags to estimate survival of migrant juvenile salmonids in the Snake and Columbia Rivers. *Canadian Journal of Fisheries and Aquatic Sciences* 55:1484-1493.
- Stein, C., D. Marvin, J. Tenney, and K. Shimojima, editors. 2001. 2001 PIT tag specification -document. Report of the Pacific States Marine Fisheries Commission to the PIT tag Technical Steering Committee. Gladstone, Oregon (available via the internet at www.psmfc.org/pittag).
- Williams, J. G., S. G. Smith, and W. D. Muir. 2001. Survival estimates for downstream migrant -yearling juvenile salmonids through the Snake and Columbia River hydropower system, 1966 to 1980 and 1993 to 1999. *North American Journal of Fisheries Management* 21:310-317.
- Zabel, R. W. and J. G. Williams. 2002. Selective mortality for fish length and migrational timing in chinook salmon: what is the role of human disturbance? *Ecological Applications* 12:173-183.
- Zar, J. H. 1999. *Biostatistical analysis*, 4th edition. Prentice Hall, Upper Saddle River, New Jersey.

APPENDIX A

Development of a Small Surface-Trawl PIT-Tag Interrogation System

Abstract

Intermittently, between 1 June and 12 July 2001, we operated a small trawl fitted with a prototype, single-coil, saltwater-tolerant, 134.2-kHz PIT-tag antenna; a total of 55 detections were recorded (all in fresh water). During several deployments in the brackish-water portion of the lower Columbia River estuary, no major problems with entanglements of bait-type fishes or salmonids occurred. Several equipment-related difficulties were identified and resolved. We believe the small trawl system is a useful tool for detecting PIT-tagged fish in salt water and areas otherwise inaccessible using our large trawl system.

Introduction

In 2001, the National Marine Fisheries Service (NMFS), with funding from the U.S. Army Corps of Engineers, began development of a small surface pair-trawl system for sampling juvenile salmonids containing passive integrated transponder (PIT) tags. We intended to use this small trawl system in the lower Columbia River estuary to complement ongoing PIT-tag sampling with a larger surface pair-trawl system in the upper estuary at Jones Beach, River Kilometer (Rkm) 75 (Ledgerwood et al. in press).

Our goal for the small trawl net and associated electronics equipment was to sample PIT-tagged fish in areas inaccessible to the large vessel trawl. Detections of PIT-tagged fish in the brackish-water portion of the estuary (Rkm 0 to 35) would be helpful in determining estuarine utilization and habitat preferences of juvenile salmonids and migrational timing through the lower estuary. However, no such saltwater-tolerant equipment was available to sample brackish water. A small, rapidly deployable, mobile, PIT-tag detection system would also have application in smaller rivers, high volume bypass channels, other areas of the Columbia River, or in the ocean. A number of technical and logistic difficulties needed to be resolved before successful implementation of the small trawl system was possible.

Initially, we deployed and tested the equipment in fresh water at Jones Beach. Adequate net handling procedures and electronic components were developed by early July, and we moved the small trawl equipment downstream to Rkm 10 near Chinook, Washington for test deployments in brackish water.

Methods

Background

In 1995, we began development of a prototype surface pair-trawl containing a PIT-tag antenna for submerged detection of PIT-tagged juvenile salmonids (Ledgerwood et al. in press). The length of the trawl, as measured from the end of one wing to the end of the opposite wing, was 213 m. The trawl size, coupled with its small-mesh design, necessitated two large tow vessels.

During net testing activities near Rkm 10 in 1998 it became apparent that sampling in the lower estuary would only be possible using a smaller trawl. Deployment and retrieval operations for the large trawl required ample maneuvering room not routinely available in the lower estuary. Furthermore, the antenna used with the large trawl system was not designed for use in brackish water. To effectively detect PIT-tagged fish in brackish water, the antenna, in theory, would require a smaller diameter opening and receive more power than a freshwater antenna.

A 134.2-kHz PIT-tag system was implemented in the Columbia River Basin in 2000. The 134.2-kHz technology provided longer reading ranges of PIT-tagged fish and thus enabled us to increase the diameter of the fish passage tunnels through our antennas. Theoretically, 134.2-kHz technology also offered a new potential for detecting fish in brackish water.

For example, during a typical deployment of the large trawl equipment at Jones Beach, the net is towed upstream facing into the current with a spread of about 91 m between the wings of the trawl. Fish that enter between the wings are guided to the trawl body to exit through an antenna situated where the cod end is normally located. During net retrieval, the freshwater antenna is removed and then the net is inverted in the current to flush debris and release fish from between the small-mesh wings.

The deployment/retrieval process of the large trawl requires about 30 min, during which time the vessels and net are adrift in tidal and river currents often exceeding 1.5 m/sec (3 knots). Currents are stronger in the lower estuary than they are at Jones Beach, often exceeding 2 m/sec (4 knots). Also, in the lower estuary, currents are bi-directional with strong daily ebb and flood tides. There are few, if any, unobstructed areas that would allow for the undirected drift of vessels required for deploying and retrieving our large-trawl system.

Another consideration when sampling PIT-tagged salmonids in the lower estuary was salinity. To our knowledge, no one had designed a PIT-tag detection antenna for saltwater applications. Fishery scientists from Norway¹ came to Jones Beach in June 2000 to observe our large trawl system and antenna designs and to further discuss our mutual interests in modifying the equipment for saltwater applications. Additional testing of 134.2-kHz equipment through the fall and winter suggested that adding insulation between the antenna coil wires and the water would limit the drain in field strength experienced in salt water (Ed Nunnallee, NMFS, personal communication).

Schedule

During late June 2001, the small trawl and an incomplete saltwater-capable detection antenna (missing 5 cm of insulation) were deployed and tested at Jones Beach. Most yearling migrant fish, including targeted PIT-tagged fish, had passed the study site by that date, but we wanted to test the equipment while some fish were still present. Initially, we were able to sample for 2 d and successfully detected PIT-tagged fish.

The associated equipment seemed to perform well in fresh water, but following the 2-d sampling period, we experienced intermittent and persistent periods of high and unexplained electronic noise that interfered with our ability to decode PIT-tags. A series of tests were conducted in air and in water in order to resolve the noise problems. We determined that an electronic DC to AC inverter used for the transceiver increased background noise levels, thus a DC powered transceiver was obtained that eliminated the previous inverter.

In early July, despite continuing intermittent and unexplained noise problems, we moved the equipment to brackish water in the lower estuary near Chinook, Washington (Rkm 10 to 16). Again, we experienced a series of equipment failures (PIT-tag electronics, computer, and vessel related) that limited sampling and impeded detection of PIT-tagged fish. In the fall, we continued to test antenna performance in brackish water near Rkm 10, without the net attached. For two, 36-h periods, we suspended the antenna over the side of an anchored vessel while PIT tags were periodically passed through the center of the antenna. During this time, we recorded PIT-tag reading efficiency, electronic tuning parameters (noise, phase, and current), salinity, and water temperature.

¹ Jan Tore Øvredal and Terje Jørgensen, Fish Capture Division, Institute of Marine Research, Bergen, Norway.

Net Design

The design of the small trawl was based upon the large surface pair-trawl, but there were some basic changes required to allow for safe operations in the strong-current and confined areas of the lower estuary. To operate in the lower estuary, we wanted to avoid inverting the trawl prior to retrieval, as required for the larger trawl. To accomplish this, we eliminated the small mesh in the wings which could entrap fish if they were collapsed together for retrieval without inversion. A larger mesh size in the wings would also help reduce drag, facilitating use of smaller vessels.

We had little information on what optimal mesh size for wings would be required to guide juvenile salmonids into the trawl body. Field observations in 1997 at Jones Beach indicated that if the wings of the trawl were not positioned abruptly against the current (spread too wide), 30-cm stretch-mesh would guide salmonids into the trawl body (Ledgerwood et al. 2000, Appendix A).

To further reduce drag and thus facilitate the use of smaller vessels, we also designed a smaller trawl body. To simplify construction we decided on a symmetrical design, 3.6 m tall by 3.6 m wide at the entrance to the trawl body, tapering evenly to the antenna attachment centered at 1.8 m beneath the surface. The exit depth (antenna attachment depth) for the small and large trawls were the same, but the trawl body of the large trawl was asymmetric in that the sidewalls began at a 6.1-m depth and created trawl construction difficulties.

The small trawl, as delivered, consisted of a 9.1-m long symmetrical trawl body having 15-m long wings. The trawl body was constructed with 1.8 cm stretch mesh, the same mesh size used in the trawl body of our larger trawl. The wings of the small trawl were 30-cm stretch-mesh webbing that tapered in depth from 3.6 m, where they attached to the trawl body, to 3 m where they attached to spreader bars and towing bridles. The spreader bars and towing bridles were similar to those of the larger trawl system and were used to hold the wings at their full sample depth. We used 70-m-long tow lines to minimize the influence of prop wash from the towing vessels on the net. We first tested the net in the relatively clear and current-free waters of Lake Washington, where divers could easily observe its orientation. No major adjustments were required after this initial testing.

Antenna Design

Preliminary testing necessary for fabrication of a saltwater-capable antenna was conducted at the NMFS electronics lab in Seattle, Washington and at our Manchester Field Station on Puget Sound (Ed Nunnallee, NMFS, pers. commun., June 2000). Standard freshwater antennas were found to lose about half their reading range and current when immersed in salt water. Norwegian scientists developed and tested a prototype, saltwater-capable, 134.2-kHz antenna, with a 30-cm diameter fish passage tunnel. Their antenna, which showed disappointing detection performance, had 15 cm of insulation (air encased in epoxy) on the outside and on the ends of the coil windings, but only 5 cm on the inside toward the fish-passage tunnel (Jan Tore Øvredal and Terje Jørgensen, Fish Capture Division, Institute of Marine Research, Bergen, Norway, pers. commun., January 2001).

Our tests results suggested that 5 to 10 cm of insulation between the antenna coil windings and the water, both inside and outside of the coil windings, were needed for adequate field strength in salt water. Additionally, results indicated that detection efficiency would be maximized by using an elliptical rather than a circular antenna design like our freshwater antenna.

Based on these preliminary tests, we constructed an elliptical antenna with an inside opening 81 cm wide by 30 cm tall (fish passage tunnel with 2,430 cm² of open area) (Figure A1 top). The antenna was partially completed by late June, with 10 cm of insulation on the inside toward the fish passage tunnel but only 5 cm of insulation toward the outside of the antenna. We wanted to test the trawl and electronics components in situ while migrating PIT-tagged fish were available, so we began sampling with the small trawl system before the antenna was finished. Following the migration period of fish, we continued to test the electrical components without the trawl, and eventually added the final 5 cm of insulation to the outside of the antenna.

Data Recording

PIT-tag-detection electronic components were contained in a 0.8-m long by 0.5-m wide by 0.3-m deep water-tight box mounted on a 1.9-m long by 1.2-m wide pontoon raft (Figure A1 bottom). A Destron-Fearing model FS-1001A PIT-tag transceiver was used to power the underwater antenna and interrogate tagged fish. The FS-1001A transceiver was specifically designed for permanent installations and typical of PIT-tag detection



Figure A1. Saltwater tolerant single-coil PIT-tag-detection antenna (top) and electronics raft housing detection transceiver used with the small trawl detection system, 2001.

systems used at hydroelectric facilities on the Columbia and Snake Rivers. The unit included a serial maintenance port and a high-speed serial port for connection to a computer to monitor the status of the installation and for logging of individual PIT tags.

During sampling, we used a direct cable connection between the transceiver and the serial port on a portable computer. Having both units within the water-tight box generated heat, added an electronic noise source near the transceiver (computer monitor), and made it difficult to monitor performance. Further testing in the fall (without nets) proved that a fiber-optic connection or wireless modem connection between transceiver and computer were possible, thus enabling the computer to be mounted in the tow vessel and making real-time monitoring of detector performance possible.

Two 12-volt deep-cycle batteries were used to provide power to both the transceiver and portable computer. One battery was mounted on each pontoon of the raft for added stability in rough water. Fully-charged batteries provided sufficient power to both the computer and transceiver for 8 h. Initially, a DC to AC power inverter was utilized to convert the 12-volt power to AC as required by the transceiver.

However, the inverter system generated electronic noise and decreased detection performance. We eliminated the inverter after a prototype 12-volt DC module for the transceiver was received from the transceiver manufacturer. A 15-m long cable connected the transceiver to the underwater antenna. The antenna was strapped to the cod end of the trawl and suspended on a buoy 1.8 m beneath the surface. A strain-relief line, wrapped with the cable and bridled to the raft and the antenna, served to tow the raft and detection electronics with the trawl.

PIT-tag detection and transceiver status monitoring software (Multimon) was utilized for recording purposes. In addition to the date, time, and tag number of PIT-tagged fish, the software also recorded internal transceiver, diagnostic, and status reports. These reports were set to generate every 2 min and were recorded automatically as part of the standard Multimon data files. Because of the preliminary nature of the sample effort in 2001, we did not submit these files to PTAGIS. Multimon files were also incorporated into an independent database (Microsoft Access) and correlated with non-Multimon data.

During unplanned power outages or computer failures, the internal buffering capability of the transceiver provided backup PIT-tag detection records, but the date and time of detection and the status and diagnostic reports for the transceiver were lost. We also used status reporting options to test equipment and observe impacts on detection performance caused by changes in environmental variables (salinity, wind, waves, etc.).

Status monitoring was possible with the antenna tuned to record PIT tags in air or water. Tune changes for different environments were accomplished using a combination of electronic jumpers and tuning screws located inside the transceiver case.

Testing and sampling activities were also recorded in a hand-written log. Entries were made for the data and time of deployment/retrieval of the trawl, net flushes, coordinates via Global Positioning System (GPS), salinity, temperature, diver observations, and impacts to fish (numbers of salmonids and non-salmonids entrapped or killed in the trawl).

Results

Trawl Design

Through the entire season, few fish were observed impinged or otherwise impacted by the trawl. We attribute the low fish impacts to the symmetry of the trawl body, and because the exit depth was one-half the total mouth opening, which also facilitated construction. The effective sampling depth, measured at the leading edge center of the trawl floor, was about 3.2 m. However, during deployment and retrieval operations, when the wings of the trawl were collapsed letting the floor hang down, nearly 8 m of depth were required.

The trawl also proved highly maneuverable in the unpredictable waters of the lower estuary. The large-mesh wings allowed us to retrieve the net directly onto a tow vessel without having to invert the trawl to release fish. One drawback in the trawl design was the occasional accumulation of significant quantities of debris. Since the net was not inverted for retrieval, debris had to be removed by hand either during the retrieval process, requiring longer drifts, or back at the dock.

Detection Results

We operated the small trawl fitted with the prototype saltwater-tolerant PIT-tag-detection antenna intermittently between 1 June and 11 July (Figure A2). During this period, we recorded a total of 55 PIT-tagged fish in fresh water at Jones Beach. We had hoped to evaluate detection efficiency relative to the large trawl at Jones Beach by simultaneous sampling in the same reach of the river. However, beginning in mid-June, sampling was severely compromised by intermittent electronic interference problems in the PIT-tag recording circuitry.

To determine if the noise source was environmentally-induced or equipment-related, we used the recording software available through MULTIMON to conduct a series of in-air and in-water noise tests. These tests were conducted without the trawl attached, and, as various equipment problems were resolved, we again attempted trawling for PIT-tagged fish.

In early July, we deployed the trawl and electronics in the brackish-water portion of the lower estuary, near Chinook, Washington. No major problems with entanglements of bait-type fishes or salmonids were encountered, but the late season deployment and several ongoing equipment-related difficulties made it unlikely that PIT-tagged fish would be recorded (and none were). In addition, these brackish-water trials were conducted using an antenna lacking the final 5 cm of outside insulation. Intermittently, high background noise that persisted and overheating problems with the computer in the electronics box prevented us from monitoring the change in electronic tune with salinity in the lower estuary.

Therefore, in October and November, we initiated a series of electronics performance tests in the lower estuary without a trawl attached, deploying the antenna from an anchored vessel near Rkm 10. Approximately hourly, and as the speed of the current allowed, we conducted a series of electronic tests from the anchored vessel to measure tag-reading performance related to the change in electronic tune associated with changing salinity. MULTIMON software was used to record electronic background noise levels and diagnostic reports from the transceiver.

We also recorded water temperature and salinity at the depth of the antenna using a Hydrolab Datasonde 4 salinometer. The first tests were conducted from 17 to 18 October while the antenna still lacked the final 5-cm of outside insulation, as was used during the June and July sampling period. We repeated tests near the same location from 31 October to 1 November after the antenna was completely insulated. The added insulation proved effective at stabilizing the electronic tune in variable salinity (Figure A3).

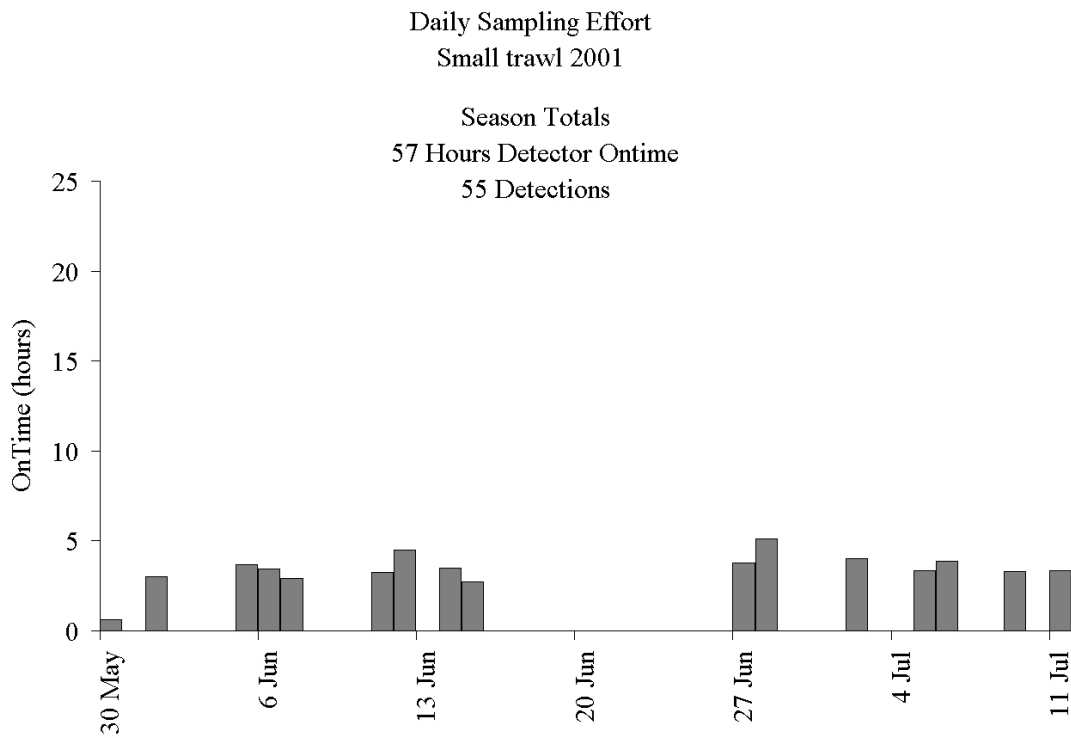

Figure A2. Daily sampling effort and detections using the small trawl in fresh water, 2001.

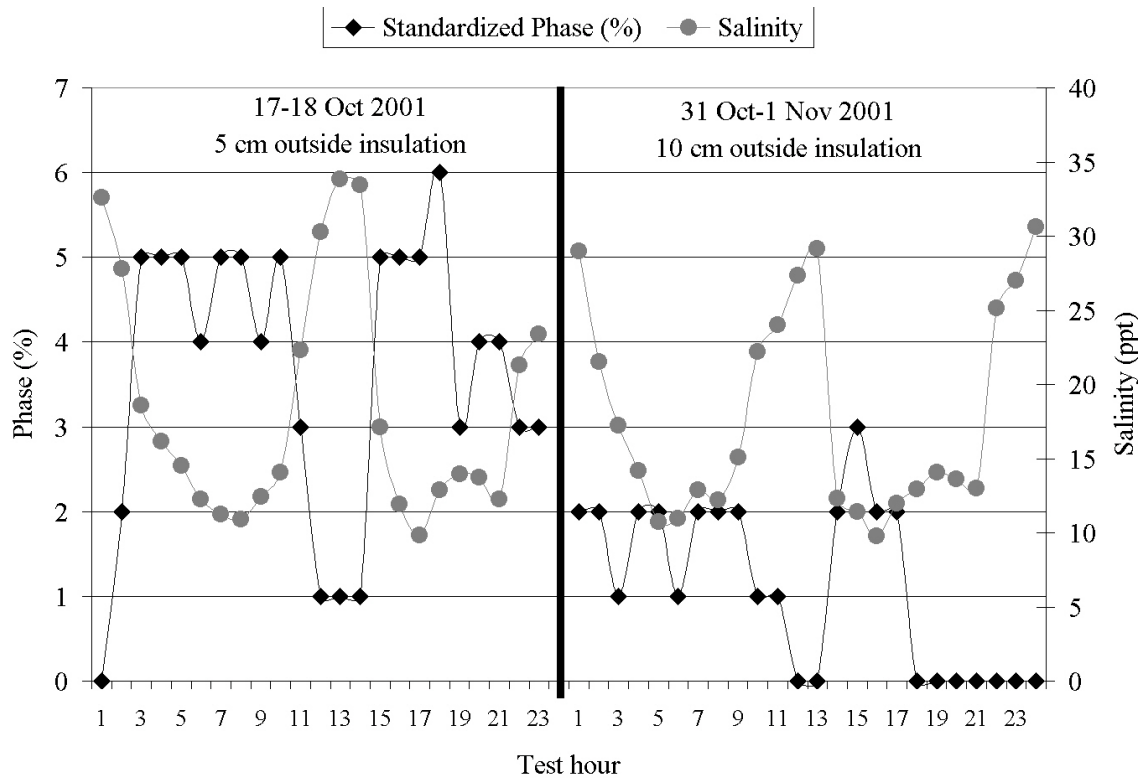

Figure A3. Change in electronic tune (standardized phase) vs. change in salinity during two 24-h test periods of the saltwater PIT-tag detection antenna in the fall of 2001. Test on left panel shows variable phase shift prior to the addition of the final 5 cm of outside insulation, compared to test on right panel after antenna was fully insulated. Phase numbers were standardized to the same beginning point (1%) for both test periods.

Discussion

After resolving several issues with equipment design and logistics, the prototype system was safely deployed in the brackish-water portion of the estuary using small vessels. The required drift distances needed for deploying and retrieving the system in the constricted waters of the lower estuary were documented. The net had low impact on salmonid and bait fishes, and any fish remaining in the net upon retrieval were easily shaken out through the antenna without inverting the trawl.

By converting the PIT-tag electronics to a DC power source and housing the above-water electronics in a small pontoon barge attached to the head rope, we eliminated power generators and the robust surface support vessel required for our large-trawl system. During the tune tests in October and November, we used a wireless communication link between the detection electronics and the computer. This procedure allowed the computer to be placed on board one of the tow vessels for real-time monitoring of the electronic tune and detection results.

These tests also demonstrated the value of having a full 10 cm of insulation around the antenna coil wires. While the missing insulation did not affect sampling results in fresh water, detection of PIT-tagged fish during brackish-water sampling was problematic. During post-season testing, detection of control PIT tags passed through a funnel mounted in the center of the antenna demonstrated that a high percentage of PIT tags could be decoded with a fully-insulated antenna in brackish water. The post-season tests also demonstrated that the change in electronic tune with variable salinity was greatly reduced with a fully-insulated antenna and that the periodic re-tuning of the electronic equipment during prolonged daily sampling in such water may not be necessary.

We believe the small trawl system is a useful tool for monitoring juvenile salmonid behavior in salt water and areas inaccessible to our large trawl system. Detection of PIT-tagged fish in the lower estuary should provide information on travel time of fish between upper and lower estuary areas under various conditions of tidal flow reversal and salinity fluctuations. By sampling with the small trawl directly in front of the large trawl at Jones Beach, we can also evaluate fish passage timing between the two trawls, which would provide useful information regarding detection efficiency and the possible delay of fish entering the large trawl.

Recommendations

1. Develop a method to monitor electronic performance and detections of the small trawl in real time. Wireless modem or fiber optic cable connections between the transceiver housed in the pontoon barge and a computer mounted in a tow vessel seem practical.
2. Add real-time global-positioning-satellite-recording capability to monitor sampling and positions of detected fish.
3. Conduct sampling with the small trawl fitted with extended large-mesh wings and normal length wings to determine the value of the former in guiding juvenile salmonids into the trawl body.

APPENDIX B

Data Tables

Appendix Table B1. Design of the tape measure used to test antenna performance, 2000-2001.

Position on tape measure (ft)	Orientation (°)	Distance from previous tag (ft) ^a	PIT-tag code ^b
21	45	0	3D9.1BF100A080
23	45	2	3D9.1BF100B30D
25	45	2	3D9.1BF100A750
28	0	3	3D9.1BF100A657
34	0	6	3D9.1BF100B82B
37	45	3	3D9.1BF100A54C
40	45	3	3D9.1BF1009B87
43	45	3	3D9.1BF101365E
45	0	2	3D9.1BF100A2BC
47	0	2	3D9.1BF10095E8
49	0	2	3D9.1BF10090F2
50	0	1	3D9.1BF10092B8
51	0	1	3D9.1BF100BF51
52	0	1	3D9.1BF1009E6E
55	0	3	3D 9.1BF1009728
58	0	3	3D9.1BF100A072
59	0	1	3D9.1BF100B67F
62	0	3	3D9.1BF100A06F
63	0	1	3D9.1BF100991F
66	0	3	3D9.1BF1009CA5
69	45	3	3D9.1BF100A164
70	0	1	3D9.1BF100974F
72	0	2	3D9.1BF1008AA0
73	0	1	3D 9.1BF1009731
75	0	2	3D9.1BF1009A7F
77	0	2	3D9.1BF100BE92
81	0	4	3D9.1BF100A21E
83	0	2	3D 9.1BF1011018
85	0	2	3D9.1BF100A72D
88	45	3	3D9.1BF10096DB
89	45	1	3D 9.1BF1009884
91	45	2	3D9.1BF101362B
92	45	1	3D9.1BF1008A57

Appendix Table B1. Continued.

Position on tape measure (f)	Orientation (°)	Distance from previous tag (f) ^a	PIT-tag code ^b
94	45	2	3D 9.1BF1013073
96	45	2	3D9.1BF1012B05
100	45	4	3D9.1BF100A2D4
102	45	2	3D9.1BF1009D44
104	45	2	3D9.1BF10139F9
106	0	2	3D9.1BF10139A7
108	0	2	3D9.1BF1008BF5
112	0	4	3D9.1BF1008B3A
114	45	2	3D9.1BF1008C11
116	45	2	3D9.1BF1008E3C
118	45	2	3D9.1BF10135E0
120	45	2	3D9.1BF100A96F
125	0	5	3D9.1BF1008E41

a Distance from previous tag as measured in the direction from 21 to 125 ft.

b PIT tags were tested after each antenna evaluation with a hand-held reader and replaced as needed.

Appendix Table B2. Daily total PIT-tag detections for each salmonid species at Jones Beach using a pair-trawl, 2000.

Detection date	Unknown	Chinook salmon	Coho salmon	Steelhead	Sockeye salmon	Total
18 Apr	0	1	0	0	0	1
21 Apr	0	1	0	8	0	9
24 Apr	1	8	0	4	0	13
25 Apr	0	1	0	5	0	6
26 Apr	0	3	0	18	0	21
27 Apr	0	5	0	57	0	62
28 Apr	0	5	0	13	0	18
29 Apr	0	11	1	22	0	34
30 Apr	0	9	0	17	0	26
1 May	0	14	2	18	0	34
2 May	0	17	0	39	0	56
3 May	0	2	0	6	0	8
4 May	0	16	0	16	0	32
5 May	0	15	1	27	0	43
6 May	0	26	0	25	0	51
7 May	1	46	0	43	0	90
8 May	1	60	7	21	0	89
9 May	0	127	10	26	0	163
10 May	1	59	17	52	1	130
11 May	1	53	4	48	0	106
12 May	2	121	10	45	0	178
13 May	3	186	41	84	0	314
14 May	4	201	10	54	0	269
15 May	2	157	20	41	2	222
16 May	0	109	5	39	0	153
17 May	2	137	21	73	0	233
18 May	2	91	0	36	0	129
19 May	2	118	17	52	0	189
20 May	2	90	13	47	5	157
21 May	0	123	8	49	2	182
22 May	3	49	8	28	1	89

Appendix Table B2. Continued.

Detection date	Unknown	Chinook salmon	Coho salmon	Steelhead	Sockeye salmon	Total
23 May	0	105	11	40	0	156
24 May	0	43	9	24	0	76
25 May	3	116	2	43	1	165
26 May	5	264	21	54	4	348
27 May	2	232	10	109	1	354
28 May	2	175	28	89	4	298
29 May	1	53	12	46	0	112
30 May	1	106	7	62	1	177
31 May	3	147	16	65	2	233
1 Jun	1	52	0	50	1	104
2 Jun	1	117	4	52	1	175
3 Jun	1	52	4	48	3	108
4 Jun	2	61	1	44	7	115
5 Jun	0	22	12	46	1	81
6 Jun	0	6	3	9	1	19
7 Jun	0	12	1	44	1	58
8 Jun	0	10	3	26	1	40
9 Jun	0	7	2	9	0	18
12 Jun	0	10	2	10	0	22
14 Jun	0	33	0	13	0	46
15 Jun	0	6	2	6	0	14
16 Jun	0	3	2	7	0	12
19 Jun	0	33	3	3	1	40
20 Jun	0	17	5	4	0	26
21 Jun	0	31	3	2	0	36
To18tals	49	3,574	358	1,918	41	5,940

Appendix Table B3. Daily total PIT-tag detections for each salmonid species at Jones Beach using a pair-trawl, 2001.

Detection date	Unknown	Chinook salmon	Coho salmon	Steelhead	Sockeye salmon	Total
20 Apr	0	1	0	0	0	1
23 Apr	0	2	0	0	0	2
24 Apr	0	4	0	0	0	4
25 Apr	0	3	0	3	0	6
26 Apr	0	6	0	6	0	12
27 Apr	0	5	0	0	0	5
28 Apr	0	6	0	3	0	9
29 Apr	0	12	0	0	0	12
30 Apr	0	1	0	0	0	1
May 1	0	24	0	0	0	24
May 2	0	127	0	20	0	147
May 3	0	100	0	3	0	103
May 4	0	41	0	0	0	41
May 5	1	60	0	33	0	94
May 6	1	60	0	26	0	87
May 7	0	23	0	20	0	43
May 8	0	65	0	21	0	86
May 9	1	54	0	12	0	67
May 10	0	156	0	45	0	201
May 11	0	38	0	8	0	46
May 12	0	31	0	2	0	33
May 13	0	78	0	10	0	88
May 14	0	25	0	10	0	35
May 15	0	120	0	3	0	123
May 16	0	79	0	6	0	85
May 17	0	127	0	3	0	130
May 18	0	60	0	8	0	68
May 19	0	63	0	5	0	68
May 20	0	46	0	0	0	46
May 21	1	38	1	1	0	41
May 22	0	97	0	7	0	104
May 23	2	32	0	22	0	56
May 24	3	122	0	16	0	141

Appendix Table B3. Continued.

Detection date	Unknown	Chinook salmon	Coho salmon	Steelhead	Sockeye salmon	Total
May 25	0	21	0	2	0	23
May 26	0	57	0	26	0	83
May 27	0	57	1	13	0	71
May 28	0	45	0	8	0	53
May 29	1	97	0	5	0	103
May 30	0	316	0	13	0	329
May 31	1	325	0	6	0	332
1 Jun	0	178	0	4	0	182
2 Jun	0	228	1	4	0	233
3 Jun	1	158	1	5	0	165
4 Jun	2	135	1	11	0	149
5 Jun	1	300	4	13	0	318
6 Jun	3	438	7	15	0	463
7 Jun	1	474	2	11	0	488
8 Jun	0	95	0	4	1	100
9 Jun	0	63	3	4	0	70
10 Jun	0	35	1	1	0	37
11 Jun	0	38	0	4	0	42
12 Jun	0	17	1	1	0	19
13 Jun	0	60	0	2	0	62
14 Jun	0	33	3	2	1	39
15 Jun	0	29	1	1	0	31
16 Jun	0	9	0	1	0	10
17 Jun	0	16	2	2	0	20
18 Jun	0	23	0	1	1	25
19 Jun	1	54	1	3	0	59
20 Jun	0	8	1	3	0	12
21 Jun	0	6	0	3	0	9
22 Jun	0	5	0	0	1	6
Totals	20	5,026	31	461	4	5,542

Appendix Table B4. Daily total of impinged fish at Jones Beach using a PIT-tag detector trawl at Jones Beach, Columbia River kilometer 75, 2000 and 2001.

Date	Chinook salmon							
	Yearling		Subyearling		Coho salmon		Steelhead	
	2000	2001	2000	2001	2000	2001	2000	2001
18-20 Apr	0	0	0	0	0	0	0	0
21 Apr	2	0	0	0	0	0	1	0
22-30 Apr	0	0	0	0	0	0	0	0
1-10 May	0	0	0	0	0	0	0	0
11 May	0	0	0	0	0	1	0	0
12-17 May	0	0	0	0	0	0	0	0
18 May	0	7	0	0	0	0	0	0
19-20 May	0	0	0	0	0	0	0	0
21 May	0	0	0	0	0	0	1	0
22-23 May	0	0	0	0	0	0	0	0
24 May	0	2	2	0	0	0	0	0
25 May	0	0	0	0	0	0	1	0
26-31 May	0	0	0	0	0	0	0	0
1-2 Jun	0	0	0	0	0	0	0	0
3 Jun	1	0	0	0	0	0	1	0
4-9 Jun	0	0	0	0	0	0	0	0
13-22 Jun	0	0	0	0	0	0	0	0
Totals	3	10	3	0	0	1	4	0

Appendix Table B4. Continued.

Date	Sockeye salmon		Unknown salmonid		Non-salmonid (quantity/species)	
	2000	2001	2000	2001	2000	2001
18-22 Apr	0	0	0	0	0	0
23 Apr	0	0	0	0	0	1 stickleback
24 Apr	0	0	0	0	0	0
25 Apr	0	0	0	1	0	1 peamouth, 1 eulacon
26-30 Apr	0	0	0	0	0	0
1 May	0	0	0	0	0	0
2 May	0	0	0	1	0	0
3 May	0	0	0	1	0	0
4 May	0	0	0	0	0	0
5 May	0	0	15	0	0	0
6-7 May	0	0	0	0	0	0
8 May	1	0	0	0	0	0
9-10 May	0	0	0	0	0	0
11 May	0	0	0	0	0	4 shad
12-18 May	0	0	0	0	0	0
19 May	0	0	1	0	0	0
20-21 May	0	0	0	0	0	0
May 22	0	0	0	1	0	0
1-6 Jun	0	0	0	0	0	0
7 Jun	0	0	0	2	0	0
8 Jun	0	0	0	1	0	0
9 Jun	0	0	0	0	0	0
13 Jun	0	0	0	0	0	0
14 Jun	0	0	0	2	0	0
15-22 Jun	0	0	0	0	0	0
Totals	1	0	16	7	0	7

Appendix Table B5. Diel sampling of yearling chinook salmon and steelhead using a PIT-tag detector surface pair-trawl at Jones Beach, Columbia River kilometer 75, 2001.

Hour	Effort (decimal hour)	Yearling chinook salmon		Steelhead	
		<i>n</i>	<i>n/h</i>	<i>n</i>	<i>n/h</i>
Diel Period 1: 9-10 May					
0	1.35	14	10.4	0	0.0
1	1.00	12	12.0	1	1.0
2	1.00	14	14.0	0	0.0
3	1.00	26	26.0	1	1.0
4	1.00	13	13.0	1	1.0
5	1.00	14	14.0	0	0.0
6	1.88	12	6.4	1	0.5
7	2.00	5	2.5	1	0.5
8	2.00	8	4.0	5	2.5
9	2.00	2	1.0	0	0.0
10	2.00	2	1.0	1	0.5
11	2.00	0	0.0	2	1.0
12	1.92	0	0.0	1	0.5
13	1.75	0	0.0	3	1.7
14	1.00	0	0.0	0	0.0
15	1.77	3	1.7	1	0.6
16	2.00	4	2.0	1	0.5
17	2.00	2	1.0	3	1.5
18	1.50	5	3.3	2	1.3
19	1.00	4	4.0	5	5.0
20	1.17	7	6.0	16	13.7
21	2.00	23	11.5	6	3.0
22	2.00	26	13.0	5	2.5
23	2.00	10	5.0	1	0.5

Appendix Table B5. Continued.

Hour	Yearling chinook				
	Effort (decimal hour)	salmon		Steelhead	
		<i>n</i>	<i>n/h</i>	<i>n</i>	<i>n/h</i>
Diel Period 2: 16-17 May					
0	0.98	6	6.1	0	0.0
1	1.00	3	3.0	0	0.0
2	1.00	2	2.0	0	0.0
3	1.00	2	2.0	0	0.0
4	1.00	13	13.0	0	0.0
5	1.00	22	22.0	0	0.0
6	1.90	27	14.2	0	0.0
7	2.00	6	3.0	1	0.5
8	2.00	6	3.0	0	0.0
9	2.00	16	8.0	0	0.0
10	2.00	9	4.5	1	0.5
11	1.98	6	3.0	1	0.5
12	0.85	2	2.4	0	0.0
13	0.53	1	1.9	0	0.0
14	1.00	2	2.0	0	0.0
15	1.00	3	3.0	1	1.0
16	1.00	1	1.0	1	1.0
17	1.00	2	2.0	0	0.0
18	1.83	2	1.1	0	0.0
19	2.00	7	3.5	1	0.5
20	2.00	11	5.5	1	0.5
21	2.00	17	8.5	0	0.0
22	2.00	31	15.5	1	0.5
23	1.50	9	6.0	1	0.7

Appendix Table B5. Continued.

Hour	Yearling chinook				
	Effort (decimal hour)	salmon		Steelhead	
		<i>n</i>	<i>n/h</i>	<i>n</i>	<i>n/h</i>
Diel Period 3: 30-31 May					
0	1.00	18	18.0	0	0.0
1	1.00	6	6.0	0	0.0
2	1.00	5	5.0	0	0.0
3	1.00	4	4.0	0	0.0
4	1.00	3	3.0	0	0.0
5	1.23	49	39.7	1	0.8
6	2.00	38	19.0	0	0.0
7	2.00	12	6.0	1	0.5
8	1.17	22	18.9	1	0.9
9	1.50	22	14.7	0	0.0
10	2.00	26	13.0	1	0.5
11	2.00	39	19.5	2	1.0
12	2.00	31	15.5	2	1.0
13	2.00	22	11.0	1	0.5
14	2.00	22	11.0	1	0.5
15	2.00	18	9.0	0	0.0
16	2.00	19	9.5	1	0.5
17	2.00	13	6.5	1	0.5
18	2.00	22	11.0	1	0.5
19	2.00	32	16.0	0	0.0
20	2.00	17	8.5	0	0.0
21	2.00	79	39.5	0	0.0
22	2.00	63	31.5	3	1.5
23	2.00	59	29.5	3	1.5

Appendix Table B5. Continued.

Hour	Yearling chinook				
	Effort (decimal hour)	salmon		Steelhead	
		<i>n</i>	<i>n/h</i>	<i>n</i>	<i>n/h</i>
Diel Period 4: 5-7 June					
0	2.98	107	35.9	1	0.3
1	3.00	96	32.0	1	0.3
2	2.97	145	48.9	1	0.3
3	2.37	105	44.4	0	0.0
4	1.07	23	21.6	0	0.0
5	2.03	47	23.1	1	0.5
6	2.73	72	26.3	3	1.1
7	2.93	76	25.9	5	1.7
8	3.00	48	16.0	3	1.0
9	2.93	34	11.6	3	1.0
10	3.00	43	14.3	4	1.3
11	2.53	46	18.2	4	1.6
12	3.00	61	20.3	1	0.3
13	2.80	27	9.6	2	0.7
14	2.00	60	30.0	2	1.0
15	1.25	30	24.0	0	0.0
16	1.00	7	7.0	1	1.0
17	1.58	3	1.9	0	0.0
18	2.27	7	3.1	0	0.0
19	3.00	23	7.7	3	1.0
20	2.50	17	6.8	1	0.4
21	2.52	18	7.2	0	0.0
22	3.00	106	35.3	0	0.0
23	3.00	73	24.3	4	1.3
subtotal		1,274		40	

Appendix Table B5. Continued.

Hour	Yearling chinook				
	Effort (decimal hour)	salmon		Steelhead	
		<i>n</i>	<i>n/h</i>	<i>n</i>	<i>n/h</i>
Average of 4 Diel Periods					
0	6.32	145	23.0	1	0.2
1	6.00	117	19.5	2	0.3
2	5.97	166	27.8	1	0.2
3	5.37	137	25.5	1	0.2
4	4.07	52	12.8	1	0.3
5	5.27	132	25.1	2	0.4
6	8.52	149	17.5	4	0.5
7	8.93	99	11.1	8	0.9
8	8.17	84	10.3	9	1.1
9	8.43	74	8.8	3	0.4
10	9.00	80	8.9	7	0.8
11	8.52	91	10.7	9	1.1
12	7.77	94	12.1	4	0.5
13	7.08	50	7.1	6	0.9
14	6.00	84	14.0	3	0.5
15	6.02	54	9.0	2	0.3
16	6.00	31	5.2	4	0.7
17	6.58	20	3.0	4	0.6
18	7.60	36	4.7	3	0.4
19	8.00	66	8.3	9	1.1
20	7.67	52	6.8	18	2.4
21	8.52	137	16.1	6	0.7
22	9.00	226	25.1	9	1.0
23	8.50	151	17.8	9	1.1
Total or Mean	173.28	3,601	13.4	165	0.7

Appendix Table B6. Analyses of travel time distributions for yearling chinook salmon and steelhead detected in the Columbia River estuary, 2000-2001. Distributions in days of the 10th-90th and percentile and middle 80 percent range were compared by species, rearing type, and migration history. Standard errors (SE) were constructed using bootstrap techniques (Efron and Tibshirani 1993). Percentile or range difference estimates were considered significant at the $\alpha = 0.05$ level if the value "0" was not contained in the interval.

Species/ Rearing type/ Migration history	n	Bootstrap analysis of the Comparison	Travel time distribution by percentiles									
			10	20	30	40	50	60	70	80	90	mid 80
2000 Inriver migrants												
1) Hatchery yearling chinook vs. wild yearling chinook												
Hatchery	290	Travel time	1.6	1.6	1.7	1.7	1.7	1.8	1.8	1.8	2.0	0.4
Wild	187	Travel time	1.6	1.6	1.7	1.7	1.8	1.8	1.9	1.9	2.0	0.4
		Difference	-0.0	-0.0	-0.0	-0.0	-0.1	-0.1	-0.1	-0.1	-0.1	0.0
		Lower	-0.1	-0.1	-0.1	-0.1	-0.1	-0.1	-0.1	-0.1	-0.1	-0.1
		Upper	-0.0	-0.0	0.0	-0.0	-0.0	-0.0	-0.0	0.0	0.0	0.1
2001 Inriver migrants												
2) Hatchery yearling chinook vs. wild yearling chinook												
Hatchery	693	Travel time	1.9	2.0	2.1	2.2	2.3	2.4	2.5	2.6	2.8	0.9
Wild	99	Travel time	2.0	2.0	2.1	2.2	2.3	2.4	2.4	2.5	2.8	0.8
		Difference	-0.0	-0.0	-0.0	0.0	0.0	0.0	0.0	0.0	-0.0	0.0
		Lower	-0.1	-0.1	-0.1	-0.1	-0.1	-0.0	-0.1	-0.1	-0.5	-0.4
		Upper	0.0	0.0	0.1	0.1	0.1	0.1	0.1	0.2	0.2	0.3
2000 Transported fish												
3) Hatchery yearling chinook vs. wild yearling chinook												
Hatchery	370	Travel time	1.7	1.8	1.9	2.0	2.0	2.1	2.4	2.8	3.3	1.7
Wild	131	Travel time	1.6	1.7	1.7	1.8	1.8	1.9	2.0	2.1	2.4	0.8
		Difference	0.1	0.1	0.1	0.2	0.2	0.2	0.5	0.7	0.9	0.8
		Lower	0.0	0.0	0.1	0.1	0.1	0.1	0.3	0.5	0.6	0.5
		Upper	0.1	0.1	0.2	0.2	0.3	0.5	0.6	1.0	1.2	1.2
2001 Transported fish												
4) Hatchery yearling chinook vs. wild yearling chinook												
Hatchery	1,079	Travel time	2.1	2.3	2.5	2.8	3.0	3.2	3.4	4.0	4.8	2.8
Wild	272	Travel time	1.9	2.1	2.2	2.3	2.5	2.9	3.0	3.3	3.7	1.8
		Difference	0.2	0.2	0.4	0.5	0.5	0.3	0.4	0.7	1.1	0.9
		Lower	0.1	0.1	0.3	0.3	0.4	0.2	0.2	0.5	0.7	0.5
		Upper	0.3	0.3	0.5	0.6	0.6	0.6	0.6	0.9	1.5	1.3

Appendix Table B6. Continued.

Species/ Rearing type/ Migration history	n	Bootstrap analysis of the Comparison	Travel time distribution by percentiles									
			10	20	30	40	50	60	70	80	90	mid 80
2000 Yearling chinook salmon												
5) Inriver migrants detected at Bonneville Dam vs. transported fish												
Transported	501	Travel time	1.7	1.7	1.8	1.9	2.0	2.1	2.3	2.6	3.1	1.4
Inriver	480	Travel time	1.6	1.6	1.7	1.7	1.7	1.8	1.8	1.9	2.0	0.4
		Difference	0.1	0.1	0.1	0.2	0.3	0.3	0.5	0.7	1.1	1.0
		Lower	0.0	0.1	0.1	0.2	0.2	0.2	0.3	0.6	1.0	0.9
		Upper	0.1	0.1	0.2	0.3	0.3	0.3	0.6	0.8	1.2	1.1
2001 Yearling chinook salmon												
6) Inriver migrants detected at Bonneville Dam vs. transported fish												
Transported	1,351	Travel time	2.0	2.2	2.4	2.7	2.9	3.1	3.2	3.9	4.6	2.6
Inriver	793	Travel time	1.9	2.0	2.1	2.2	2.3	2.4	2.5	2.6	2.8	0.8
		Difference	0.1	0.2	0.3	0.5	0.6	0.7	0.8	1.3	1.8	1.7
		Lower	0.1	0.1	0.2	0.4	0.6	0.7	0.7	1.1	1.6	1.5
		Upper	0.1	0.2	0.4	0.6	0.7	0.8	0.9	1.4	2.1	1.9
2000 Steelhead												
7) Inriver migrants detected at Bonneville Dam vs. transported fish												
Transported	302	Travel time	1.5	1.5	1.6	1.6	1.6	1.7	1.7	1.8	1.9	0.4
Inriver	297	Travel time	1.6	1.6	1.6	1.7	1.7	1.8	1.8	1.8	2.0	0.4
		Difference	-0.1	-0.1	-0.1	-0.1	-0.1	-0.1	-0.1	-0.1	-0.1	0.0
		Lower	-0.1	-0.1	-0.1	-0.1	-0.1	-0.1	-0.1	-0.1	-0.2	-0.1
		Upper	-0.0	-0.0	-0.0	-0.1	-0.1	-0.1	-0.1	-0.1	0.0	0.1
2001 Steelhead												
8) Inriver migrants detected at Bonneville Dam vs. transported fish												
Transported	244	Travel time	1.7	1.9	1.9	2.1	2.3	2.3	2.4	2.7	3.1	1.5
Inriver	59	Travel time	2.0	2.3	2.4	2.4	2.4	2.5	2.5	2.6	2.7	0.7
		Difference	-0.4	-0.4	-0.4	-0.4	-0.2	-0.1	-0.1	0.1	0.4	0.8
		Lower	-0.6	-0.5	-0.5	-0.5	-0.3	-0.2	-0.2	-0.1	0.2	0.5
		Upper	-0.2	-0.2	-0.3	-0.2	-0.1	-0.1	0.0	0.3	0.8	1.2
2000 Transported fish												
9) Yearling chinook salmon vs. steelhead												
Chinook	278	Travel time	1.7	1.7	1.8	1.9	2.0	2.1	2.3	2.6	3.1	1.4
Steelhead	24	Travel time	1.5	1.5	1.6	1.6	1.6	1.7	1.7	1.8	1.9	0.4
		Difference	0.2	0.2	0.2	0.3	0.4	0.4	0.6	0.8	1.2	1.0
		Lower	0.1	0.2	0.2	0.3	0.3	0.4	0.4	0.7	1.0	0.9
		Upper	0.2	0.2	0.3	0.4	0.4	0.4	0.7	1.0	1.4	1.2

Appendix Table B6. Continued.

Species/ Rearing type/ Migration history	n	Bootstrap analysis of the Comparison	Travel time distribution by percentiles									
			10	20	30	40	50	60	70	80	90	mid 80
2001 Transported fish												
10) Yearling chinook salmon vs. steelhead												
Chinook	219	Travel time	2.0	2.2	2.4	2.7	2.9	3.1	3.2	3.9	4.6	2.6
Steelhead	25	Travel time	1.7	1.9	1.9	2.1	2.3	2.3	2.4	2.7	3.1	1.5
		Difference	0.4	0.3	0.5	0.7	0.7	0.8	0.8	1.1	1.5	1.1
		Lower	0.2	0.3	0.4	0.5	0.6	0.7	0.7	1.0	1.1	0.7
		Upper	0.5	0.4	0.6	0.8	0.8	0.8	1.0	1.4	1.8	1.4
2000 Inriver migrant												
11) Yearling chinook salmon vs. steelhead												
Chinook	144	Travel time	1.6	1.6	1.7	1.7	1.7	1.8	1.8	1.9	2.0	0.4
Steelhead	153	Travel time	1.6	1.6	1.6	1.7	1.7	1.8	1.8	1.8	2.0	0.4
		Difference	0.0	0.0	0.0	0.0	0.0	0.0	0.0	0.0	0.0	0.0
		Lower	-0.0	0.0	0.0	-0.0	-0.0	0.0	-0.0	0.0	-0.1	-0.1
		Upper	0.0	0.0	0.0	0.0	0.0	0.1	0.1	0.1	0.1	0.1
2001 Inriver migrant												
12) Yearling chinook salmon vs. steelhead												
Chinook	26	Travel time	1.9	2.0	2.1	2.2	2.3	2.4	2.5	2.6	2.8	0.8
Steelhead	33	Travel time	2.0	2.3	2.4	2.4	2.4	2.5	2.5	2.6	2.7	0.7
		Difference	-0.1	-0.3	-0.2	-0.2	-0.1	-0.1	-0.1	-0.0	0.1	0.2
		Lower	-0.3	-0.4	-0.3	-0.3	-0.2	-0.2	-0.1	-0.1	-0.1	0.0
		Upper	0.0	-0.1	-0.1	-0.1	-0.1	-0.0	-0.0	0.1	0.2	0.4
Transported fish												
13) 2000 yearling chinook salmon vs. 2001 yearling chinook salmon												
2000	501	Travel time	1.7	1.7	1.8	1.9	2.0	2.1	2.3	2.6	3.1	1.4
2001	1,351	Travel time	2.0	2.2	2.4	2.7	2.9	3.1	3.2	3.9	4.6	2.6
		Difference	-0.4	-0.5	-0.6	-0.8	-0.9	-1.1	-0.9	-1.3	-1.5	-1.2
		Lower	-0.4	-0.5	-0.7	-0.9	-1.0	-1.1	-1.2	-1.4	-1.8	-1.4
		Upper	-0.3	-0.4	-0.5	-0.7	-0.9	-1.0	-0.8	-1.1	-1.3	-0.9
Inriver migrant												
14) 2000 yearling chinook salmon vs. 2001 yearling chinook salmon												
2000	480	Travel time	1.6	1.6	1.7	1.7	1.7	1.8	1.8	1.9	2.0	0.4
2001	793	Travel time	1.9	2.0	2.1	2.2	2.3	2.4	2.5	2.6	2.8	0.8
		Difference	-0.4	-0.4	-0.4	-0.5	-0.6	-0.6	-0.6	-0.7	-0.8	-0.4
		Lower	-0.4	-0.4	-0.5	-0.6	-0.6	-0.6	-0.7	-0.7	-0.9	-0.5
		Upper	-0.3	-0.4	-0.4	-0.5	-0.5	-0.6	-0.6	-0.6	-0.7	-0.3

Appendix Table B6. Continued.

Species/ Rearing type/ Migration history	n	Bootstrap analysis of the Comparison	Travel time distribution by percentiles									
			10	20	30	40	50	60	70	80	90	mid 80
Transported fish												
15) 2000 steelhead vs. 2001 steelhead												
2000	302	Travel time	1.5	1.5	1.6	1.6	1.6	1.7	1.7	1.8	1.9	0.4
2001	244	Travel time	1.7	1.9	1.9	2.1	2.3	2.3	2.4	2.7	3.1	1.5
		Difference	-0.2	-0.3	-0.4	-0.4	-0.6	-0.7	-0.7	-1.0	-1.3	-1.1
		Lower	-0.3	-0.4	-0.4	-0.6	-0.7	-0.7	-0.9	-1.1	-1.6	-1.4
		Upper	-0.1	-0.3	-0.3	-0.3	-0.5	-0.6	-0.7	-0.8	-1.0	-0.9
Inriver migrant												
16) 2000 steelhead vs. 2001 steelhead												
2000	297	Travel time	1.6	1.6	1.6	1.7	1.7	1.8	1.8	1.8	2.0	0.4
2001	59	Travel time	2.0	2.3	2.4	2.4	2.4	2.5	2.5	2.6	2.7	0.7
		Difference	-0.5	-0.7	-0.7	-0.7	-0.7	-0.7	-0.7	-0.7	-0.7	-0.2
		Lower	-0.7	-0.8	-0.8	-0.8	-0.8	-0.8	-0.8	-0.8	-0.9	-0.4
		Upper	-0.4	-0.5	-0.6	-0.6	-0.7	-0.7	-0.7	-0.7	-0.6	0.0

Appendix Table B7. Number of PIT-tagged yearling chinook salmon loaded at each of three dams and number and rate of fish detected in the estuary at Jones Beach, 2000. Dams: LGR, Lower Granite; LGO, Little Goose, LMO, Lower Monumental.

2000 release date and time	Number of PIT-tagged yearling chinook salmon loaded			Totals (n)	Jones Beach detection rate (%)			Totals	
	LGR	LGO	LMO		LGR	LGO	LMO	(n)	(%)
19 Apr 19:32	264	791	22	1,077	0.0	0.1	0.0	1	0.1
21 Apr 15:30	254	958	68	1,280	0.0	0.0	0.0	0	0.0
22 Apr 18:25	272	933	48	1,253	0.7	0.6	2.1	9	0.7
23 Apr 21:33	475	778	102	1,355	0.4	0.0	0.0	2	0.1
25 Apr 00:01	486	729	416	1,631	0.0	0.0	0.2	1	0.1
25 Apr 18:40	505	1,002	527	2,034	0.0	0.2	0.2	3	0.1
26 Apr 20:00	662	943	231	1,836	0.2	0.1	0.4	3	0.2
27 Apr 21:30	1,133	1,392	132	2,657	0.3	0.1	0.0	5	0.2
28 Apr 22:45	597	749	164	1,510	0.0	0.5	0.6	5	0.3
29 Apr 18:15	707	616	102	1,425	0.1	0.5	0.0	4	0.3
30 Apr 17:30	1,202	1,085	160	2,447	0.2	0.6	0.0	9	0.4
1 May 20:38	1,227	954	234	2,415	0.2	0.0	0.0	3	0.1
2 May 22:10	1,424	929	189	2,542	0.1	0.2	0.0	4	0.2
3 May 19:00	2,058	1,408	344	3,810	0.1	0.3	0.0	7	0.2
4 May 19:20	1,665	1,774	334	3,773	0.1	0.2	0.0	5	0.1
5 May 19:38	2,093	1,903	661	4,657	0.8	0.8	1.1	39	0.8
6 May 23:30	2,617	1,424	603	4,644	1.0	0.1	0.0	28	0.6
7 May 20:55	1,679	1,084	381	3,144	0.2	1.3	2.4	26	0.8
8 May 19:10	1,240	671	248	2,159	0.1	0.3	0.4	4	0.2
9 May 18:46	1,804	538	350	2,692	0.3	0.9	1.4	16	0.6
10 May 20:40	1,787	806	230	2,823	1.1	2.2	2.2	43	1.5
11 May 20:40	1,584	879	282	2,745	0.9	1.8	2.1	36	1.3
12 May 20:40	1,239	1,366	477	3,082	0.6	1.9	2.5	46	1.5
13 May 20:35	1,144	698	347	2,189	0.2	1.1	2.3	18	0.8
14 May 19:44	957	648	273	1,878	0.6	0.3	1.5	12	0.6
15 May 20:00	439	499	152	1,090	1.8	1.4	2.6	19	1.7
16 May 20:30	653	423	99	1,175	1.2	3.3	4.0	26	2.2
17 May 21:00	313	507	47	867	1.3	2.2	0.0	15	1.7
18 May 19:05	213	401	17	631	0.0	1.2	5.9	6	1.0
19 May 21:10	214	336	30	580	0.9	0.9	0.0	5	0.9

Appendix Table B7. Continued.

2000 Release date and time	Number of PIT-tagged yearling chinook salmon loaded				Totals (n)	Jones Beach detection rate (%)			Totals	
	LGR	LGO	LMO	LGR		LGO	LMO	(n)	(%)	
	20 May 19:15	347	226	21		594	1.2	0.4	0.0	5
21 May 21:10	312	244	25	581	1.6	2.5	4.0	12	2.1	
22 May 17:50	281	244	56	581	1.1	1.6	0.0	7	1.2	
23 May 19:00	239	410	77	726	2.5	2.2	0.0	15	2.1	
24 May 20:23	246	277	167	690	0.0	3.6	3.0	15	2.2	
25 May 20:00	286	432	154	872	0.7	1.9	3.9	16	1.8	
26 May 18:30	263	284	108	655	0.8	2.5	0.9	10	1.5	
27 May 19:15	205	170	101	476	0.0	0.0	1.0	1	0.2	
29 May 20:20	208	345	198	751	1.9	1.2	0.5	9	1.2	
31 May 21:00	63	301	42	406	0.0	2.3	2.4	8	2.0	
2 Jun 17:15	68	197	0	265	0.0	0.0	--	0	0.0	
4 Jun 18:20	10	99	24	133	0.0	0.0	0.0	0	0.0	
6 Jun 18:20	22	119	28	169	0.0	0.8	3.6	2	1.2	
8 Jun 19:15	30	196	27	253	0.0	0.0	0.0	0	0.0	
10 Jun 19:50	16	469	37	522	0.0	0.0	0.0	0	0.0	
12 Jun 19:56	5	571	12	588	0.0	0.2	0.0	1	0.2	
14 Jun 18:00	3	62	3	68	0.0	0.0	0.0	0	0.0	
Total/Mean	33,511	31,870	8,350	73,731	0.5	0.8	1.1	501	0.7	

Appendix Table B8. Number of PIT-tagged steelhead loaded at each of three dams and number and rate of fish detected in the estuary at Jones Beach, 2000. Dams: LGR, Lower Granite; LGO, Little Goose, LMO, Lower Monumental.

2000 release date and time	Number of PIT-tagged steelhead loaded			Totals (n)	Jones Beach detection rate (%)			Totals	
	LGRL	GO	LMO		LGR	LGO	LMO	(n)	(%)
19 Apr 19:32	17	1,589	41	1,647	0.0	0.4	0.0	7	0.4
21 Apr 15:30	21	2,330	87	2,438	0.0	0.0	0.0	0	0.0
22 Apr 18:25	11	1,772	44	1,827	9.1	0.2	0.0	4	0.2
23 Apr 21:33	23	961	184	1,168	0.0	0.4	0.5	5	0.4
25 Apr 00:01	15	1,253	432	1,700	0.0	1.0	1.4	18	1.1
25 Apr 18:40	11	1,365	646	2,022	0.0	2.1	3.3	50	2.5
26 Apr 20:00	20	707	92	819	0.0	0.8	0.0	6	0.7
27 Apr 21:30	14	432	69	515	7.1	0.7	1.4	5	1.0
28 Apr 22:45	12	195	51	258	0.0	0.5	0.0	1	0.4
29 Apr 18:15	8	362	23	393	0.0	1.7	4.3	7	1.8
30 Apr 17:30	8	815	12	835	0.0	1.2	8.3	11	1.3
1 May 20:38	10	820	7	837	0.0	0.1	0.0	1	0.1
2 May 22:10	8	735	26	769	0.0	0.4	0.0	3	0.4
3 May 19:00	8	1,121	36	1,165	0.0	0.9	0.0	10	0.9
4 May 19:20	19	844	21	884	5.3	1.2	0.0	11	1.2
5 May 19:38	14	910	170	1,094	0.0	2.3	1.2	23	2.1
6 May 23:30	14	623	118	755	0.0	1.0	0.8	7	0.9
7 May 20:55	28	618	21	667	0.0	1.8	4.8	12	1.8
8 May 19:10	37	549	13	599	2.7	3.8	0.0	22	3.7
9 May 18:46	36	403	260	699	2.8	3.0	1.9	18	2.6
10 May 20:40	16	194	105	315	0.0	2.6	1.9	7	2.2
11 May 20:40	7	253	94	354	14.3	3.2	2.1	11	3.1
12 May 20:40	10	485	66	561	0.0	1.9	1.5	10	1.8
13 May 20:35	12	165	67	244	8.3	4.8	3.0	11	4.5
14 May 19:44	6	127	29	162	0.0	0.8	10.3	4	2.5

Appendix Table B8. Continued.

2000 release date and time	Number of PIT-tagged steelhead loaded by dam			Totals (n)	Jones Beach detection rate (%)				
	LGR	LGO	LMO		Totals			(n)	(%)
					LGR	LGO	LMO		
15 May 20:00	5	48	28	81	0.0	4.2	3.6	3	3.7
16 May 20:30	12	31	37	80	0.0	0.0	0.0	0	0.0
17 May 21:00	10	23	30	63	0.0	0.0	0.0	0	0.0
18 May 19:05	4	10	5	19	0.0	0.0	0.0	0	0.0
19 May 21:10	5	20	1	26	0.0	5.0	0.0	1	3.8
20 May 19:15	11	24	4	39	0.0	0.0	0.0	0	0.0
21 May 21:10	23	13	6	42	0.0	0.0	16.7	1	2.4
22 May 17:50	18	22	7	47	0.0	9.1	0.0	2	4.3
23 May 19:00	13	35	2	50	0.0	5.7	50.0	3	6.0
24 May 20:23	11	23	11	45	0.0	4.3	9.1	2	4.4
25 May 20:00	14	103	77	194	0.0	4.9	7.8	11	5.7
26 May 18:30	15	26	25	66	0.0	3.8	0.0	1	1.5
27 May 19:15	11	19	18	48	0.0	0.0	0.0	0	0.0
29 May 20:20	21	146	32	199	0.0	3.4	6.3	7	3.5
31 May 21:00	8	92	33	133	0.0	2.2	3.0	3	2.3
2 Jun 17:15	10	28	0	38	0.0	3.6	--	1	2.6
4 Jun 18:20	2	13	14	29	0.0	0.0	0.0	0	0.0
6 Jun 18:20	2	25	22	49	0.0	8.0	0.0	2	4.1
8 Jun 19:15	10	22	6	38	0.0	0.0	0.0	0	0.0
10 Jun 19:50	5	13	9	27	0.0	0.0	0.0	0	0.0
12 Jun 19:56	3	5	2	10	0.0	0.0	0.0	0	0.0
14 Jun 18:00	1	4	1	6	0.0	0.0	100.0	1	16.7
Total/Mean	599	20,373	3,084	24,056	1.2	1.1	2.1	302	1.3

Appendix Table B9. Number of PIT-tagged yearling chinook salmon loaded at each of four dams and number and rate of fish detected in the estuary at Jones Beach by dam, 2001. Dams: LGR, Lower Granite; LGO, Little Goose, LMO, Lower Monumental; MCN, McNary.

2001 release date and time	Number of PIT-tagged yearling chinook salmon loaded				Totals n	Jones Beach detection rate (%)				Totals	
	LGR	LGO	LMO	MCN		LGR	LGO	LMO	MCN	n	%
15 Apr 22:30	444	17	1	0	462	0.2	0.0	0.0	--	1	0.2
17 Apr 18:45	494	31	1	0	526	0.4	0.0	0.0	--	2	0.4
19 Apr 18:00	530	32	2	0	564	0.4	0.0	0.0	--	2	0.4
21 Apr 18:00	1,433	35	2	0	1,470	1.0	0.0	0.0	--	14	1.0
23 Apr 18:00	1,647	84	5	0	1,736	0.8	0.0	0.0	--	13	0.7
24 Apr 18:00	1,573	167	6	0	1,746	0.8	1.2	0.0	--	14	0.8
27 Apr 18:00	2,479	156	0	0	2,635	1.3	0.6	--	--	33	1.3
29 Apr 18:00	5,020	586	30	0	5,636	2.0	1.5	0.0	--	111	2.0
30 Apr 18:00	6,071	458	37	0	6,566	1.5	2.0	0.0	--	100	1.5
2 May 07:30	6,068	448	60	12	6,588	1.1	2.2	1.7	0.0	78	1.2
3 May 08:30	6,801	724	59	0	7,584	0.9	1.4	5.1	--	76	1.0
4 May 04:20	2,527	421	65	52	3,065	1.0	2.6	4.6	0.0	38	1.2
4 May 20:15	1,366	326	59	0	1,751	1.2	0.3	3.4	--	20	1.1
6 May 03:10	1,555	270	80	140	2,045	1.9	1.9	2.5	0.7	38	1.9
6 May 22:00	2,626	361	89	0	3,076	1.9	3.0	3.4	--	65	2.1
8 May 01:15	2,192	395	124	100	2,811	2.0	1.8	1.6	1.0	54	1.9
8 May 21:55	2,430	392	97	0	2,919	1.2	1.3	1.0	--	35	1.2
11 May 03:30	1,765	572	253	281	2,871	1.6	2.3	2.4	1.1	50	1.7
12 May 01:15	1,786	463	106	168	2,523	1.0	1.3	2.8	0.6	27	1.1
12 May 21:00	2,936	511	125	0	3,572	2.4	1.2	2.4	--	80	2.2
14 May 02:57	925	305	92	203	1,525	1.3	3.6	2.2	1.0	27	1.8
14 May 21:55	2,822	277	95	0	3,194	2.3	3.2	0.0	--	73	2.3
16 May 02:15	1,943	350	98	233	2,624	0.8	0.9	1.0	0.4	21	0.8

Appendix Table B9. Continued.

2001 release date and time	Number of PIT-tagged yearling chinook salmon loaded by dam				Totals n	Jones Beach detection rate (%)				Totals	
	LGR	LGO	LMO	MCN		LGR	LGO	LMO	MCN	n	%
16 May 21:45	3,943	643	230	0	4,816	1.1	2.0	2.6	--	63	1.3
19 May 06:36	2,342	1,636	304	1,020	5,302	0.5	0.6	0.0	0.9	30	0.6
20 May 06:00	1,153	834	102	0	2,089	0.9	1.9	2.9	--	29	1.4
21 May 01:50	1,104	841	157	0	2,102	1.0	1.4	1.3	--	25	1.2
22 May 07:00	783	419	96	1,030	2,328	0.8	1.0	2.1	1.3	25	1.1
22 May 20:05	145	315	53	0	513	3.4	1.3	1.9	--	10	1.9
24 May 03:45	153	300	364	1,005	1,822	0.7	0.7	3.0	1.5	29	1.6
24 May 23:30	346	158	49	0	553	0.3	1.3	2.0	--	4	0.7
26 May 03:50	362	164	103	2,180	2,809	1.1	0.6	0.0	1.1	28	1.0
26 May 22:20	540	201	101	0	842	1.1	4.0	3.0	--	17	2.0
28 May 04:45	304	254	92	250	900	2.0	2.4	1.1	2.8	20	2.2
29 May 02:20	532	147	66	0	745	3.8	4.1	0.0	--	26	3.5
30 May 06:00	224	152	84	198	658	2.2	0.7	3.6	1.0	11	1.7
31 May 06:00	104	258	79	0	441	1.9	2.7	1.3	--	10	2.3
1 Jun 06:00	55	223	55	0	333	1.8	1.3	0.0	--	4	1.2
1 Jun 18:45	107	38	62	0	207	2.8	5.3	1.6	--	6	2.9
3 Jun 05:20	99	78	51	1,046	1,274	1.0	0.0	2.0	2.0	23	1.8
5 Jun 05:30	180	143	123	104	550	2.8	4.2	1.6	1.0	14	2.5
7 Jun 01:15	36	35	71	45	187	5.6	2.9	1.4	2.2	5	2.7
9 Jun 03:50	504	23	21	54	602	1.0	4.3	9.5	1.9	9	1.5
11 Jun 02:05	79	55	19	39	192	0.0	3.6	0.0	2.6	3	1.6
13 Jun 01:45	633	188	56	55	932	0.5	1.6	1.8	0.0	7	0.8
16 Jun 13:10	1,700	140	55	50	1,945	1.9	0.0	1.8	0.0	33	1.7
19 Jun 04:00	402	334	91	75	902	0.0	0.0	0.0	0.0	0	0.0
Tot/Mean	73,263	14,960	3,970	8,340	100,533	1.3	1.6	1.9	1.2	1,403	1.4

Appendix Table B10. Number of PIT-tagged steelhead loaded at each of four dams and number and rate detected in the estuary at Jones Beach by dam, 2001. Dams: LGR, Lower Granite; LGO, Little Goose, LMO, Lower Monumental; MCN, McNary.

2001 release date and time	Number of PIT-tagged steelhead loaded by dam					Jones Beach detection rate (%)					
	LGR	LGO	LMO	MCN	Totals	LGR	LGO	LMO	MCN	Totals	
					(n)					(n)	(%)
15 Apr 22:30	173	1	0	0	174	0.0	0.0	--	--	0	0.0
17 Apr 18:45	162	0	0	0	162	0.0	--	--	--	0	0.0
19 Apr 18:00	1	6	0	0	7	0.0	0.0	--	--	0	0.0
21 Apr 18:00	191	4	1	0	196	0.5	0.0	0.0	--	1	0.5
23 Apr 18:00	203	6	0	0	209	2.0	0.0	--	--	4	1.9
24 Apr 18:00	221	10	1	0	232	2.3	0.0	0.0	--	5	2.2
27 Apr 18:00	304	8	0	0	312	0.3	0.0	--	--	1	0.3
29 Apr 18:00	363	43	1	0	407	0.0	0.0	0.0	--	0	0.0
30 Apr 18:00	997	17	3	0	1,017	1.2	0.0	0.0	--	12	1.2
2 May 07:30	668	16	2	1	687	1.5	0.0	0.0	0.0	10	1.5
3 May 08:30	2,587	14	9	0	2,610	1.7	0.0	0.0	--	45	1.7
4 May 04:20	35	11	13	0	59	0.0	0.0	0.0	--	0	0.0
4 May 20:15	16	7	10	0	33	0.0	0.0	0.0	--	0	0.0
6 May 03:10	1,848	3	13	2	1,866	1.8	0.0	0.0	0.0	33	1.8
6 May 22:00	1,468	6	6	0	1,480	1.6	0.0	16.7	--	25	1.7
8 May 01:15	670	7	18	3	698	1.8	0.0	0.0	0.0	12	1.7
8 May 21:55	1,371	12	54	0	1,437	3.5	0.0	0.0	--	48	3.3
11 May 03:30	308	29	58	2	397	3.9	10.3	1.7	0.0	16	4.0
12 May 01:15	145	27	6	2	180	2.1	0.0	0.0	0.0	3	1.7
12 May 21:00	485	19	8	0	512	0.8	0.0	0.0	--	4	0.8
14 May 02:57	6	15	10	3	34	0.0	0.0	0.0	0.0	0	0.0
14 May 21:55	213	26	33	0	272	0.9	0.0	3.0	--	3	1.1
16 May 02:15	146	12	36	5	199	2.7	0.0	0.0	0.0	4	2.0

Appendix Table B10. Continued

2001 release date and time	Number of PIT-tagged steelhead loaded by dam				Jones Beach detection rate (%)						
	LGR	LGO	LMO	MCN	Totals				Totals		
					n	LGR	LGO	LMO	MCN	n	%
16 May 21:45	149	8	21	0	178	4.7	0.0	0.0	--	7	3.9
19 May 06:36	15	61	43	9	128	0.0	0.0	0.0	0.0	0	0.0
20 May 06:00	160	26	39	0	225	0.6	7.7	5.1	--	5	2.2
21 May 01:50	619	33	47	0	699	2.4	9.1	6.4	--	21	3.0
22 May 07:00	503	12	18	7	540	2.2	0.0	5.6	0.0	12	2.2
22 May 20:05	14	2	9	0	25	0.0	0.0	0.0	--	0	0.0
24 May 03:45	7	5	50	5	67	0.0	0.0	4.0	0.0	2	3.0
24 May 23:30	314	8	8	0	330	3.8	12.5	25.0	--	15	4.5
26 May 03:50	580	18	17	10	625	1.4	5.6	0.0	0.0	9	1.4
26 May 22:20	265	12	6	0	283	1.9	0.0	16.7	--	6	2.1
28 May 04:45	116	14	5	12	147	1.7	7.1	0.0	0.0	3	2.0
29 May 02:20	95	11	22	0	128	6.3	0.0	9.1	--	8	6.3
30 May 06:00	5	4	9	2	20	0.0	0.0	0.0	50.0	1	5.0
31 May 06:00	2	12	15	0	29	0.0	0.0	0.0	--	0	0.0
1 Jun 06:00	0	8	8	0	16	--	0.0	0.0	--	0	0.0
1 Jun 18:45	65	3	9	0	77	3.1	0.0	11.1	--	3	3.9
3 Jun 05:20	52	3	10	26	91	7.7	0.0	10.0	3.8	6	6.6
5 Jun 05:30	79	8	10	2	99	2.5	12.5	0.0	0.0	3	3.0
7 Jun 01:15	0	16	16	1	33	--	6.3	6.3	0.0	2	6.1
9 Jun 03:50	31	18	11	6	66	0.0	0.0	0.0	0.0	0	0.0
11 Jun 02:05	5	10	22	6	43	0.0	0.0	0.0	0.0	0	0.0
13 Jun 01:45	60	14	17	9	100	1.7	0.0	5.9	0.0	2	2.0
16 Jun 13:10	11	23	8	3	45	0.0	4.3	0.0	0.0	1	2.2
19 Jun 04:00	3	3	8	3	17	0.0	33.3	0.0	0.0	1	5.9
Totals/means	15,731	631	710	119	17,191	1.9	2.4	2.8	1.7	333	1.9

* YCS = yearling chinook salmon, STL = juvenile steelhead

Appendix Table B11. Detection rates of PIT-tagged juvenile chinook salmon and steelhead previously detected at Bonneville Dam using a pair trawl in the Columbia River estuary at Jones Beach (Rkm 75), 2000.

2000 detection date at Bonneville Dam	Bonneville Dam detections (n)		Jones Beach detections			
			(n)		(%)	
	chinook salmon	steelhead	chinook salmon	steelhead	chinook salmon	steelhead
24 Mar	301	598	0	1	0.0	0.2
18 Apr	29	19	0	0	0.0	0.0
19 Apr	23	41	0	1	0.0	2.4
20 Apr	41	49	0	0	0.0	0.0
21 Apr	96	82	0	0	0.0	0.0
22 Apr	178	59	0	0	0.0	0.0
23 Apr	393	103	1	0	0.3	0.0
24 Apr	448	114	2	0	0.4	0.0
25 Apr	290	121	1	0	0.3	0.0
26 Apr	300	295	2	5	0.7	1.7
27 Apr	627	349	1	0	0.2	0.0
28 Apr	627	537	2	5	0.3	0.9
29 Apr	660	444	3	1	0.5	0.2
30 Apr	611	412	1	5	0.2	1.2
1 May	835	455	1	6	0.1	1.3
2 May	784	396	0	2	0.0	0.5
3 May	807	449	5	7	0.6	1.6
4 May	1,180	558	3	5	0.3	0.9
5 May	1,420	773	6	6	0.4	0.8
6 May	1,850	731	18	10	1.0	1.4
7 May	1,281	405	20	2	1.6	0.5
8 May	1,463	503	12	11	0.8	2.2
9 May	1,404	502	10	4	0.7	0.8
10 May	860	389	9	4	1.0	1.0
11 May	1,406	576	29	12	2.1	2.1
12 May	1,567	444	24	8	1.5	1.8
13 May	1,790	436	29	10	1.6	2.3
14 May	1,622	398	14	2	0.9	0.5
15 May	1,820	654	24	20	1.3	3.1
16 May	1,299	560	17	12	1.3	2.1
17 May	852	424	15	9	1.8	2.1

Appendix Table B11. Continued.

2000 detection date at	Bonneville Dam		Jones Beach detections			
	detections (n)		(n)		(%)	
	chinook		chinook		chinook	
Bonneville Dam	salmon	steelhead	salmon	steelhead	salmon	steelhead
18 May	1,634	515	25	15	1.5	2.9
19 May	1,259	422	24	9	1.9	2.1
20 May	1,224	292	20	5	1.6	1.7
21 May	1,259	253	13	6	1.0	2.4
22 May	1,255	193	21	6	1.7	3.1
23 May	1,532	413	13	5	0.8	1.2
24 May	2,456	383	32	11	1.3	2.9
25 May	2,974	534	79	28	2.7	5.2
26 May	1,406	321	40	20	2.8	6.2
27 May	999	167	13	2	1.3	1.2
28 May	840	200	14	3	1.7	1.5
29 May	736	98	14	3	1.9	3.1
30 May	755	162	12	6	1.6	3.7
31 May	1,082	226	14	8	1.3	3.5
1 Jun	1,448	172	23	15	1.6	8.7
2 Jun	811	136	11	1	1.4	0.7
3 Jun	428	75	2	3	0.5	4.0
4 Jun	203	113	1	0	0.5	0.0
5 Jun	143	60	0	2	0.0	3.3
6 Jun	317	240	1	1	0.3	0.4
7 Jun	327	115	1	0	0.3	0.0
8 Jun	199	70	0	0	0.0	0.0
9 Jun	132	51	0	0	0.0	0.0
10 Jun	127	31	0	0	0.0	0.0
11 Jun	156	29	0	0	0.0	0.0
12 Jun	467	12	2	1	0.4	8.3
13 Jun	807	38	1	0	0.1	0.0
14 Jun	277	46	0	0	0.0	0.0
15 Jun	598	10	0	0	0.0	0.0
16 Jun	507	2	0	0	0.0	0.0
17 Jun	229	2	4	0	1.7	0.0
18 Jun	96	3	0	0	0.0	0.0
19 Jun	171	1	2	0	1.2	0.0
Total/Mean	26,854	5,385	382	150	1.2	1.7

Appendix Table B12. Detection rates of PIT-tagged juvenile chinook salmon and steelhead previously detected at Bonneville Dam using a pair trawl in the Columbia River estuary at Jones Beach (Rkm 75), 2001.

2000 detection date at Bonneville Dam	Bonneville Dam detections (n)		Jones Beach detections			
			(n)		(%)	
	chinook salmon	steelhead	chinook salmon	steelhead	chinook salmon	steelhead
9 Apr	251	245	3	2	??	0.8
19 Apr	0	2	0	0	--	0.0
20 Apr	2	1	0	0	0.0	0.0
21 Apr	15	1	0	0	0.0	0.0
22 Apr	55	1	0	0	0.0	0.0
23 Apr	75	2	0	0	0.0	0.0
24 Apr	147	0	1	0	1.0	--
25 Apr	176	1	2	0	1.1	0.0
26 Apr	118	2	2	0	1.7	0.0
27 Apr	103	6	2	0	1.9	0.0
28 Apr	99	4	3	0	3.0	0.0
29 Apr	122	5	1	0	0.8	0.0
30 Apr	130	2	2	0	1.5	0.0
May 1	303	2	3	0	1.0	0.0
May 2	298	6	4	0	1.3	0.0
May 3	258	35	4	1	1.6	2.9
May 4	173	28	4	0	2.3	0.0
May 5	237	12	5	0	2.1	0.0
May 6	233	18	5	0	2.1	0.0
May 7	409	13	4	0	1.0	0.0
May 8	460	6	6	0	1.3	0.0
May 9	337	16	10	0	3.0	0.0
May 10	509	15	7	0	1.4	0.0
May 11	294	13	2	0	0.7	0.0
May 12	482	11	10	0	2.1	0.0
May 13	302	22	6	0	2.0	0.0
May 14	371	31	9	0	2.4	0.0
May 15	441	50	5	0	1.1	0.0
May 16	649	40	5	1	0.8	2.5
May 17	437	25	6	1	1.4	4.0
May 18	929	31	13	1	1.4	3.2

Appendix Table B12. Continued.

2000 detection date at	Bonneville Dam		Jones Beach detections			
	detections (n)		(n)		(%)	
	chinook		chinook		chinook	
Bonneville Dam	salmon	steelhead	salmon	steelhead	salmon	steelhead
May 19	462	27	3	1	0.6	3.7
May 20	432	18	8	1	1.9	5.6
May 21	726	15	13	1	1.8	6.7
May 22	568	28	7	1	1.2	3.6
May 23	539	66	4	5	0.7	7.6
May 24	574	57	4	1	0.7	1.8
May 25	531	64	12	0	2.3	0.0
May 26	535	37	3	1	0.6	2.7
May 27	652	25	24	0	3.7	0.0
May 28	756	31	37	1	4.9	3.2
May 29	1,592	61	58	2	3.6	3.3
May 30	2,063	76	62	1	3.0	1.3
May 31	1,713	43	61	0	3.6	0.0
1 Jun	2,069	71	50	7	2.4	9.9
2 Jun	1,834	56	37	1	2.0	1.8
3 Jun	2,201	68	102	6	4.6	8.8
4 Jun	2,888	87	115	11	4.0	12.6
5 Jun	2,428	64	69	2	2.8	3.1
6 Jun	1,457	61	20	4	1.4	6.6
7 Jun	927	32	14	1	1.5	3.1
8 Jun	642	42	16	1	2.5	2.4
9 Jun	558	31	3	3	0.5	9.7
10 Jun	318	12	2	0	0.6	0.0
11 Jun	801	41	3	1	0.4	2.4
12 Jun	811	69	6	1	0.7	1.4
13 Jun	623	42	4	1	0.6	2.4
14 Jun	517	19	8	0	1.5	0.0
15 Jun	206	27	4	0	1.9	0.0
16 Jun	262	34	6	0	2.3	0.0
17 Jun	156	20	1	0	0.6	0.0
18 Jun	278	15	0	1	0.0	6.7
19 Jun	288	8	3	0	1.0	0.0
Total/Mean	29,945	1,320	756	54	2.3	3.1