

---

**WHALES**

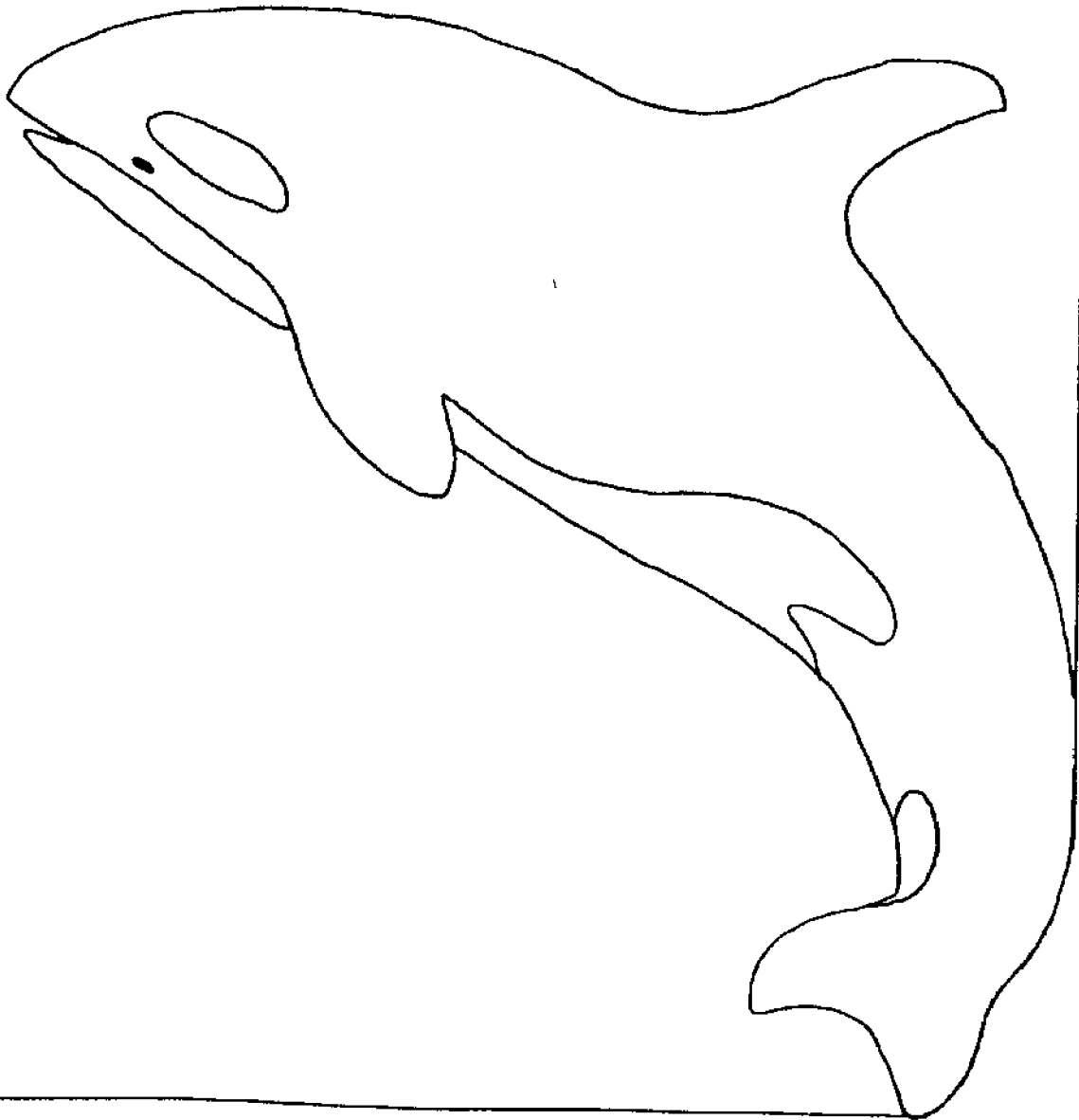

**OCEAN RELATED CURRICULUM ACTIVITIES**

**PACIFIC SCIENCE CENTER / SEA GRANT  
MARINE EDUCATION PROJECT**

**Andrea Marrett, Manager**

**Claire Jones, Writer**

**Susan Lundstedt, Illustrator**

---

## ORCA PUBLICATIONS

### ELEMENTARY

High Tide, Low Tide (4th Grade)  
Life Cycle of the Salmon (3rd - 4th Grade)  
Waterbirds (4th - 5th Grade)  
Whales (4th - 6th Grade)

### JUNIOR HIGH

Beaches  
Beach Profiles and Transects  
Early Fishing Peoples of Puget Sound  
Energy from the Sea  
Literature and the Sea  
Tides  
Tools of Oceanography

### SENIOR HIGH

American Poetry and the Sea  
Marine Biology Activities  
Marine Biology Field Trip Sites  
Marshes, Estuaries and Wetlands  
Squalls on Nisqually: A Simulation Game

© Copyright by Pacific Science Center, 1980.

This activity packet was produced at the Pacific Science Center in cooperation with Washington Sea Grant and Office of the Superintendent of Public Instruction. Permission to reprint these materials is subject to approval by the Pacific Science Center. For permission or further information contact the Pacific Science Center, 200 Second Avenue North, Seattle, WA (206) 625-9333.

## PROJECT ORCA

The ocean? It's 2 miles away; it's 200 miles away; it's 2000 miles away. What does it matter to me? For those students who live close to the ocean, a lake or a stream, the effect of water might be more obvious. For the student who lives on a wheat farm in the arid inlands, the word ocean is remote. It may conjure up images of surf, sand and sea gulls, experiences far removed from their daily lives; or it may have no meaning at all. Yet for that same youngster, the reality of the price of oversea wheat shipments or fuel costs for machinery are very real. The understanding of weather and its effects on the success or failure of crops is a basic fact of everyday life. The need for students to associate these daily problems with the influence of the marine environment exists. It requires exposure to ideas, concepts, skills and problem solving methods on the part of the youngsters. It also requires materials and resources on the part of our educators.

The goals of ORCA (Ocean Related Curriculum Activities) are: 1) to develop a basic awareness of ways in which water influences and determines the lives and environments of all living things; and 2) to develop an appreciation of the relationship of water to the study of the natural sciences, social sciences, humanities and the quality of life.

ORCA attempts to reach these goals by: 1) developing interdisciplinary curriculum materials designed to meet the needs of students and teachers living in Washington State, 2) developing a marine resource center, and 3) providing advisory services for marine educators. In conjunction with these efforts, ORCA is coordinating communication among educators throughout the state and the rest of the nation.

The curriculum materials are developed to be used in many areas including the traditional science fields. They consist of activity packets which fit existing curricula and state educational goals and are designed for use as either a unit or as individual activities.

The ocean affects all our lives and we need to be aware and informed of the interconnections if we are to make sound decisions for the future of the earth, the ocean and our own well being. We hope that through Project ORCA, teachers will be encouraged to work together to help students understand and appreciate the ocean and the world of water as a part of our daily existence.

# ACKNOWLEDGEMENTS

The elementary series of ORCA (Ocean Related Curriculum Activities) is a product of a cooperative effort. The materials were developed at the Pacific Science Center with assistance provided by the National Oceanic and Atmospheric Administration (NOAA) Sea Grant, held by the University of Washington.

## TRIAL TEACHERS

Trial teachers provide the "trial by fire." By testing the materials with students in the classroom, we learn the answer to the question: Does it work? The teachers who gave their time, effort and advice were:

Adrienne Weaver	Zoa Shumway	Ladell Black
Ann Mitchell	Bill Cuthbert	Celia Greenberg
Ellie Weisenbach	Carol Austin	Ann McCracken
Arthur Erickson	Sheryl Hamm	Sylva Driscoll
Serena Allgire	Barbara Nelson	Karin Branchflower
Vickie Dittman	Barbara MacKanness	Karen Whitner
Elaine O'Brien	Gerry Tyler	Geraldine Shelvin
Cathy Profilet	Evelyn Fairchild	Lyn Fiebig
Mary Lou Johnson	Karen Hovland	Norma Jean Howlett
Nani Castor	Judy Blomster	Susan Aaby
Vivian Fuller	Louise Chacartegui	Sandi Hatchett
Janet Richardson	Helene Yorozu	Chris Taylor
Patty Lauterback	Kate Grace	Carolyn Sanders
Shirley Reynolds	Linda Spoor	Carolyn Kyle

## CONSULTANTS

A variety of people were asked for information, advice and help during the development of the curriculum. Their support and interest was greatly appreciated.

The many people and organizations who provided technical assistance and expertise were:

Chuck Flaherty, American Cetacean Society, Puget Sound Chapter  
Pat Higgins, Salmon Enhancement Project, King County Planning  
Vicki Jensen, Anthropologist, University of British Columbia  
Fred Lighter, Ph.D., Project Manager, Environmental Monitoring Center,  
Pacific Science Center  
Dennis Paulson, Ph.D., Author, and Naturalist  
Jay Powell, Anthropologist, University of British Columbia  
Dennis Wilson, Salmon Enhancement Project, METRO  
Discovery Park  
Seattle Aquarium  
Seattle Audubon Society

The aid, advice, and encouragement of the following educators was essential to the successful development of this project:

Cliff Anastasiou, Faculty of Education, British Columbia  
Tony Angell, Supervisor, Environmental Education Programs, NW Section,  
Washington  
Ralph Carlson, Evaluator  
Claire Dyckman, Environmental Education Programs, NW Section, Washington  
State  
Sally Luttrell-Montes, Staff Teacher, Elementary Education, Pacific  
Science Center  
Gary Mozel, Developer, Project Science, Pacific Science Center  
Nan Munsell, Manager, Elementary Education, Pacific Science Center  
Beth Whitehead, Education Programs, American Cetacean Society, Puget  
Sound Chapter

A sincere thank you to two consultants who gave extensive time, support and special expertise:

Alyn Duxbury, Ph.D., Assistant Director of New Programs, Division of  
Marine Resources, University of Washington  
David Kennedy, Supervisor of Science, Environmental Education and  
Marine Education, Office of the Superintendent of Public Instruction

### **ADVISORY COMMITTEES**

The Marine Education project was reviewed annually by the Sea Grant Site Evaluation committee. We thank them for their advice and support.

Continuing guidance for the program direction was provided by the Pacific Science Center Education Committee, the members of which are:

A.D. Ayrault, Jr., Headmaster, Lakeside School  
Levon Balzer, Ph.D., Dean of Instruction, Seattle Pacific University  
Helen Firzzell, Teacher, Northshore School District  
Charles Hardy, Coordinator, Math and Science, Highline School District  
David Kennedy, Supervisor of Science, Environmental Education and  
Marine Education, Office of Superintendent of Public Instruction  
Roger Olstad, Ph.D., Associate Dean of Graduate Studies, University  
of Washington, Committee Chairperson  
Alice Romero, Teacher, West Seattle High School, Seattle School District  
Mark Terry, Associate Director, Environment, The Northwest School of the  
Arts, Humanities, and the Environment, Seattle  
William Stevenson, Superintendent, Shoreline School District

### **STAFF**

Finally, the production of the elementary series could only occur with the immense help of staff members who were instrumental in creating, developing and supporting this project.

A heartfelt thanks to the curriculum writers, who wrote and revised the curriculum:

Claire Jones, Barbara Russell, Gloria Snively, and Kathy Tarabochia.

The efforts of all the people responsible for graphics, design and paste-up are greatly appreciated:

Susan Lundstedt, graphics and paste-up

Valene Starrett, covers

Lisa Tranquada, graphics and paste-up

Reviewing, editing and typing take time and patience. The two people who successfully handled that task were:

Maxine Fischer, typing

Peggy Peterson, editing and typing

I want to most sincerely thank the Project Investigator, Bonnie DeTurck, Director of Education, Laurie Dundie, the Marine Education Assistant, Peggy Peterson, and John Kenning for their special support and efforts for the marine education project.

Andrea Marrett  
Manager, Marine Education Project  
Pacific Science Center  
200 Second Avenue North  
Seattle, WA 98109

# WHALES

## ABSTRACT:

Whales and dolphins are increasingly popular subjects of scientific study and never fail to generate interest and awe among elementary students. This packet consists of six activities which logically follow from one to the other; however, any activity may be done independently of the others. Students are acquainted with Quileute Indian and modern methods of whaling and are invited to compare the two. They investigate the mammalian characteristics of the Cetaceans and learn about some of the aspects of whale biology that suit them to life in the oceans. Students learn techniques and problems of estimating whale populations and, finally, take part in a simulated television news special, "The Battle Over the Bowhead," which brings together much of what they have learned. The activities are meant as seed ideas; individual students, teachers and entire classes may go off on their own tangent using an idea in this packet.

**GRADE LEVELS:** 4 - 6

**READING LEVEL:** 4.56

**WRITTEN BY:** Claire Jones

## TABLE OF CONTENTS AND OVERVIEW

PAGE

### ACTIVITY 1: WHALE HUNT (3-4 DAYS)

6

#### Purpose

Whaling was an integral part of the social and economic life of some Northwest Coast Indian tribes. Modern whaling is very different in that sophisticated hunting methods and technology have enabled people to kill far more whales and severely disrupt whale populations. In this activity, students will:

1. demonstrate understanding of Quileute Indian methods by acting out a whale hunt scenario.
2. compare the Quileute approach to that of modern whalers.

#### Subjects

social studies, anthropology, creative drama

### ACTIVITY 2: WHO'S WHO AMONGST WHALES (6 DAYS)

20

#### Purpose

Whales and dolphins, constituting the order Cetacea, are a diverse group of marine mammals with many features similar to land animals. Many of them are so large they would crush to death under their own weight on land, yet their large size helps them to retain body heat in cold water. In this activity, students will be able to:

1. state why whales are considered mammals.
2. describe the difference between toothed and baleen whales.
3. list several adaptations of Cetaceans to the marine environment.
4. describe several species of Cetaceans.

#### Subjects

general science, biology

### ACTIVITY 3: ECHOLOCATION (5 DAYS)

40

#### Purpose

Cetaceans have developed sensory systems very different from land mammals. Because their water environment may let in very little light and because water is a better conductor of sound than is air many Odontocetes (toothed whales) have been found to possess precise echolocation systems. They send out high frequency clicks and receive the echoes through the lower jaw and/or forehead. During this activity, in which students breathe, act and swim like a whale, students will be able to:

1. identify the importance of hearing to a Cetacean.
2. show how 2 ears are used to orient to a sound.
3. tell how the echo changes as distance from an object changes.

#### Subjects

physical science, biology



**ACTIVITY 4: COMMUNICATION (4 DAYS)**Purpose

Living creatures communicate about many different types of things, using many different means. In Cetaceans, the more studied Odontocetes have a variety of vocalizations, including clicks, whistles, squeaks and grunts, as well as sounds produced by the tail, jaws and other parts of the body. Male Humpback Whales sing long complex songs; no one knows their purpose. In this activity, students will be able to:

1. identify several ways Cetaceans communicate.
2. describe the various means of communication among Cetaceans and our lack of knowledge about them.

Subjects

language arts, biology

**ACTIVITY 5: BEANS AND BALEENS (5 DAYS)**

62

Purpose

This activity uses beans to focus on some of the techniques and problems involved in estimating sizes of whales. The International Whaling Commission, the only worldwide organization with any responsibility for controlling the whaling industry, bases its population estimate on sightings and the number of whales caught compared to the effort involved; the results can be inaccurate. The students will be able to:

1. state one problem of estimating whale populations.
2. explain how the effort expended to capture an individual changes as a population grows or declines.
3. explain how birth and death rates affect population sizes.
4. tell what information can be gained from projects such as Orca Survey.
5. explain a problem facing Humpback Whale populations and offer a possible solution.

Subjects

math, general science, biology

**ACTIVITY 6: BATTLE OVER THE BOWHEAD (3-4 DAYS)**

72

Purpose

The Bowhead Whale is an endangered species, and is now limited to a small population in the Bering Sea. The controversy over limiting Eskimo subsistence hunting of the Bowhead is a complex one, involving issues of conservation, impact of oil and gas development, international politics, the rights of a minority people, and the impact of technology on Eskimo hunting methods. In this activity students will:

1. participate in a simulated television news special about the Bowhead controversy.
2. be able to discuss several of the issues involved.

Subjects

media, drama, social studies

**VOCABULARY AND BIBLIOGRAPHY**

82

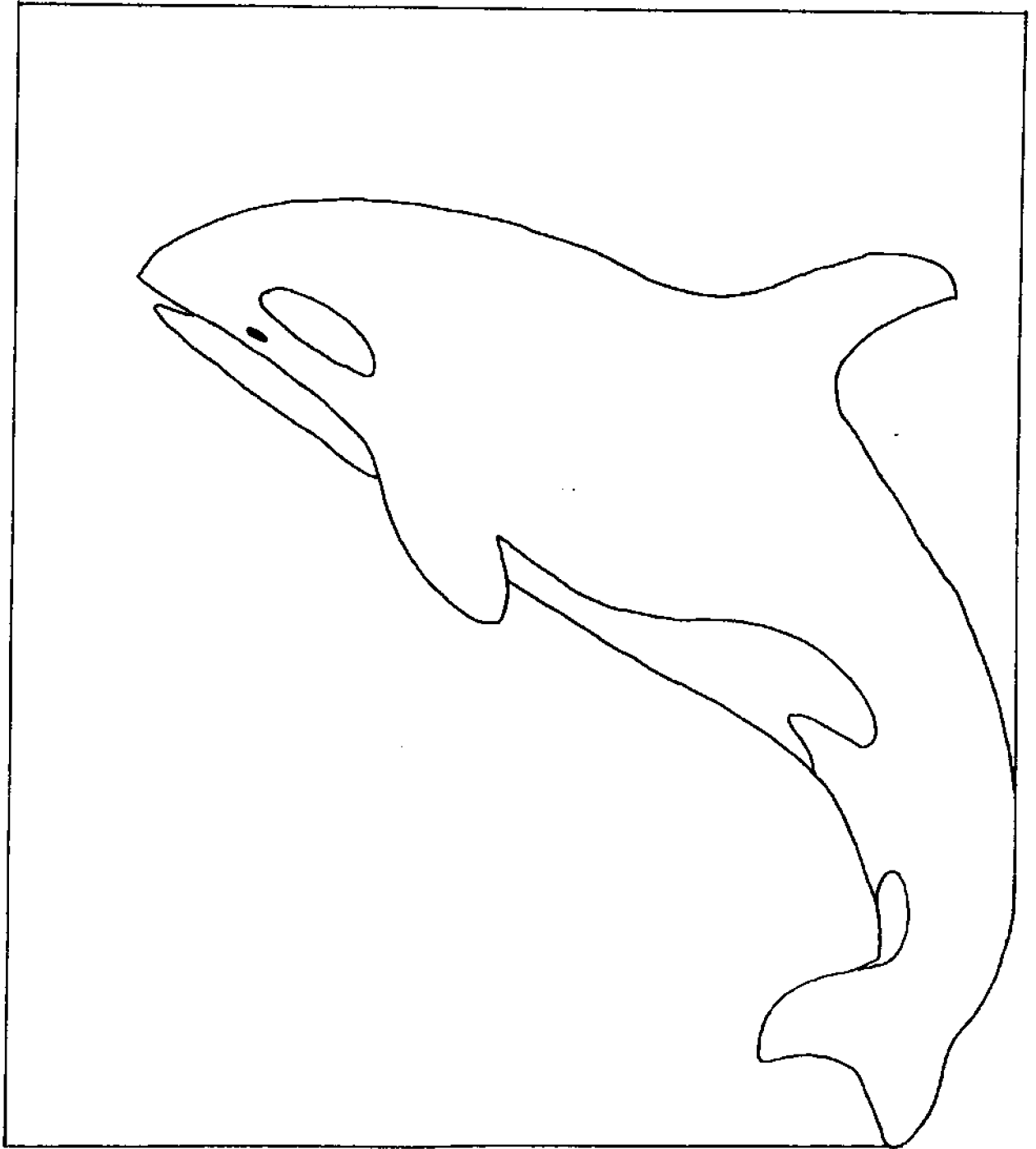

**ACTIVITY 1:  
WHALE HUNT  
(3-4 DAYS)**

## ACTIVITY 1: WHALE HUNT (3-4 DAYS)

### CONCEPTS:

1. The Quileute people used readily available natural resources with great ingenuity and skill to make very effective whale hunting equipment.
2. To perform a task (in whaling or anything else) in Quileute culture, you needed a good relationship with your spirit power.
3. Quileute whaling was a means of proving strength of one's spirit power, as well as providing food.
4. Modern technology and hunting methods (electronic, explosive, and mechanical devices) have made it possible to kill far more whales than did the old Indian ways.
5. Quileute and modern whalers differ in technology and attitudes toward whales and whaling's effect on whale population.

### OBJECTIVES:

- The student will be able to:
1. compare the Quileute approach to that of modern whalers.
  2. demonstrate understanding of methods and technology of Quileute Indian whalers by acting out a whale hunt scenario.

### TEACHER PREPARATION:

1. Read thoroughly Teacher Information, "Quileute Whaling."
2. Make a transparency of layout of Quileute Canoe from "Quileute Whaling"
3. Run off and cut up 1 or 2 copies of the "Role Cards for Quileute Whale Hunt"

### MATERIALS:

1. Class set of "Whale Hunt"
2. These items will need to be brought in or devised from materials on hand: (see procedure 3)
  - 7 paddles
  - 1 bailer
  - 1 harpoon with detachable point
  - 1 stout line
  - 2 'sealskin' floats (try balloons)
  - 1 knife
  - 1 sewing line
  - 1 tow line
  - tape or chalk

### PROCEDURES:

1. Read aloud to the class the teacher information on "Quileute Whaling." (Since it is long, you may wish to split it into two readings or to read excerpts and talk about important points in your own words. You may want to use the transparency of the whaling canoe at this time. Ask for students' reaction to the reading. Be sure to discuss:

What were the attitudes of the Quileute (Pronounced QUILL-lee-yoot) people toward whales and whaling? [Whales were highly respected by the Quileute people as having

strong spirits. Consequently whalers themselves needed strong spirit powers. Tasks involved in whaling, like any other tasks, required one to have a strong relationship with one's spirit power. The hunting of the (Gray) whale was closely tied to its life cycle, and tools used were made from resources at hand. Whaling was an essential economic activity in that it provided portions of the Quileute diet as well as materials for tools and ropes, etc. It was a social activity as well. Prestige, wealth, and membership in certain secret societies were involved.]

Who hunted the whales? [Men of the village. While they needed certain skills (strong paddlers, ability to paddle silently, strong harpooner, knowledge of whale habits, habits, etc.) more important was a good relationship with one's spirit power. The most successful whalers were those with the strongest spirit help.]

What tools and methods were used? [Tools were all made from resources at hand. Large dugout wooden canoes and paddles, harpoons with a detachable point of whale rib, shell or metal, ropes of whale sinew and/or vegetable fibers; floats of sealskin. Much teamwork was involved in the whale hunt.]

How many whales did they kill? [A season only lasted while the whales were passing the coast on their migration. Two or three whales in a single day for a village would have been a remarkably successful hunt.]

What were the whales used for? [Skin, meat and oil for food; bones and baleen for tools; and sinews for ropes and cords. Almost every part had a use and the whale was shared according to accepted rules of distribution.]

2. Pass out "Whale Hunt," for students to read individually. In your discussion, compare with the previous reading on Indian whaling.

How do methods and technology of the Quileutes and modern whalers compare? [Motorized boats, explosive harpoons and floating factory ships allow more whales to be killed in modern times. No species can escape and the possibility of personal danger is much less.]

Who hunts the whales today? [On a large scale, Japanese and Russians.]

What are the attitudes of whalers today? What do students themselves think of killing whales?

What are the effects of modern technology on the stability of whale populations?

What are the whales used for? [See story.]

This reading will hopefully raise more questions than it answers, leading to individual and class study of topics on whales and whaling.

3. Project the transparency of a Quileute whaling canoe overhead and have the class measure out the outline of a canoe on the floor of your classroom. It should be 50 feet long and 6 feet wide (if your classroom is not that big, reduce the scale by one-half so the canoe is 25 X 3 -- still a huge canoe!) Use tape or chalk to outline it. Then put marks where each of the 8 crew would kneel or stand (the harpooner would stand in front, the others kneel).

Have children bring in or prepare the whaling equipment they will need:

- 7 paddles (maybe use straw brooms)
- 1 bailer (used by middleman; i.e. coffee can)
- 1 harpoon (8" long, with a detachable point; i.e. a meter stick)
- 1 stout line attached to the harpoon point (i.e. yarn, string, etc.)
- 2 sealskin floats (use larger yellow or white balloons with ends painted brown. How will you connect them to the harpoon line?)
- 1 knife (i.e. plastic knife)
- 1 line (to sew whale's mouth shut)
- 1 tow-line

In addition, the harpoon line should be connected to the canoe with a thin, easily breakable string. This is in case the whale were to dive so deeply that it used all the line, the canoe would not be swamped.

4. The class is now ready to act out a Quileute whale hunt. Use the 16 role cards that can be run off and cut up.

Split the class into 2 groups; one group can be the audience while the other group acts out their roles, and then the audience and actors can switch. If your class is smaller, you may wish to add extra roles and just have one skit. (Card #16 can be given to several students.)

Pass out role cards to students (run off one set if there is to be only one play, 2 sets if there are to be 2 plays). Explain that they must decide among themselves who has what role, and in what order characters appear. The role cards contain only a brief description of each character's main function; the students

themselves can add dimension to their characters and can participate in other scenes where appropriate. In fact, the activity can be expanded into as detailed a play as the students wish. This activity requires good communication and cooperative skills among students. You may wish to act as director for the groups, or you may wish to assign a director role to a student who has no part.

Once the students have started interacting with one another to plan their skit, ensure that they have identified the role of the narrator. This character, the eldest in the tribe, is to start off the acting out by telling the story of the whale hunt at the potlatch feast. As s/he speaks, the story comes to life enacted by the other students. In order for the narrator as well as the rest of the students to be accurate, you may want to make some copies of the Teacher Information, "Quileute Whaling" available to them. Use the canoe layout of the stage where appropriate, and the 'props' (tools) the children have brought in or devised.

Have the students put on their skit(s). Can the audience understand what is going on? Did it make sense the way the students put it together? Do the students feel that they gained more of a feeling for the Quileute approach to whale hunting?

Optional: The students may also wish to portray a modern whale hunt. They can use their reading, "Whale Hunt" for reference as well as pages 203-215 in The Whale, Crescent Books. These would be appropriate roles: whale gunner, helmsman in whale catcher, lookout in catcher boat, whale tagger, buoy boat crewperson, winch operator on factory ship, flenser (blubber stripper), lemoner (meat cutter), try works tender, bone sawer, engineer, deck manager and deck hands. Be aware that the portrayal of a modern whale hunt would show a highly mechanized division of labor. With the underlying spirituality and sense of ecology that a Quileute Whale hunt has, the modern story can be seen as a grim and inhumane one. Keep the students focused on the efficiency that modern technology has contributed to the hunting of whales.

**EXTENDED  
ACTIVITIES:**

1. If your class can visit the longhouse at the Pacific Science Center in Seattle, or the museum in Neah Bay, Washington, they will see artifacts which were used in whaling. At Neah Bay, there is a great collection of artifacts which were dug up at the Ozette Archeological site. You can see a whale's shoulder blade with a broken off piece of mussel shell harpoon point sticking out of it. It is graphic evidence of how sharp and effective the old techniques and equipment were.

2. For an excellent study of the interrelationships between people, their technology and whaling, see the whaling unit of People and Technology published by the Educational Development Center, Newton, MA. The unit focuses on the growth of the whaling industry in 19th century Nantucket.
  3. Although we have not mentioned it in this unit, much is written of 19th century whaling, often called the 'romantic age.' Read up on it and compare attitudes, technology and method used to those of the Quileute and modern whalers.
  4. Write a play of the 19th century whale hunt that could fit in with those done in this activity.
  5. Read Moby Dick, not only a great novel, but very informational about whales and whaling.
  6. An argument presented by conservationists is that man-made or other natural substances can be substituted for almost every product of whaling. Research the jojoba, a desert shrub whose seeds contain an oil similar in composition and usefulness to sperm whale oil. What arguments are presented by industry or by whale-consuming nations? Can you identify the conflicting points of view, attitudes, data, etc.?
  7. What is culture? Talk about several things that typify your own North American culture. Here are a few of them: the use of money; living in houses that have corners on them rather than round walls; eating with equipment other than fingers except for a few circumstances; belief that ghosts don't really exist; wearing clothes in all seasons of the year; and women and men usually wearing different types of garments. Now you think of other things that characterize our culture. Then on the basis of what you know about the traditional Quileute culture, discuss ways that culture is different from and similar to our own. (See bibliography for other readings on native Pacific Northwest cultures.)
  8. Other topics for research:
    - a. Eskimos and whaling.
    - b. Mythology of whales and dolphins.
-

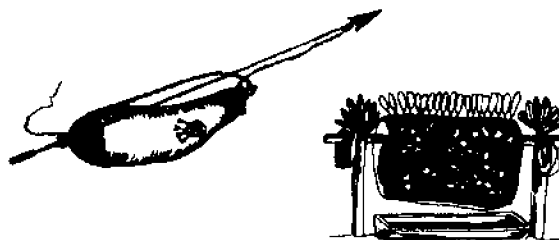

### QUILEUTE WHALING\*

Whales were hunted by some of the coastal Indians long before white people arrived on the Northwest Coast. In this unit, we will study one particular group of whale hunters, the Quileute Indians, who still live at La Push and Lower Hoh River in Washington. What we know about their whaling is described by Albert Reagan (the school teacher at La Push from 1905-08), Ram Singh and Leo Frachtenbert (anthropologists who talked to the old Indians about their whaling) and by Quileute elders Hal George and the late "Big Bill" Penn, who remembered how it was done.

The Quileute (pronounced QUILL-lee-yoot) speak a language that is not related to any other living language in the world. But their culture includes habits and traditions much like other groups around them on the coast. The Quileute split cedar planks for their houses and carved great canoes of cedar (although they did not carve totem poles as groups further to the north did). It was these mighty canoes that were the basic equipment in hunting the California Gray and Humpback whales which migrate close to the Quileute beaches each March and April. But a canoe alone is not enough to hunt and kill the biggest creatures in the sea. In addition, the Quileutes developed a complicated technology and set of whaling customs. One might think that their culture was "primitive" in that it did not include the electronic, explosive, and mechanical devices used in whaling today, but these Indians used the natural resources at hand with great ingenuity and skill to make very effective whale hunting equipment.

Quileute ocean-going canoes measured up to fifty feet long and six to eight feet wide. Although some of these canoes could hold as many as thirty people, a whaling crew was always made up of eight hunters. Each of these eight people had a specific job and particular equipment to use. Look at the diagram of how the canoe was laid out:

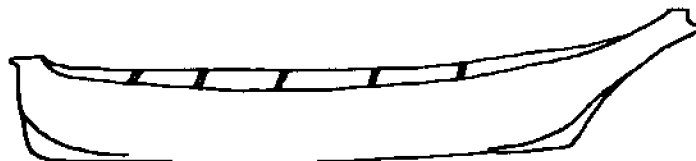

\*Copyrighted. Permission to reproduce granted by Jay Powell and Vickie Jenson from Quileute for Kids: Book 6. We are grateful for their kind contribution to this activity packet.



## Teacher Information

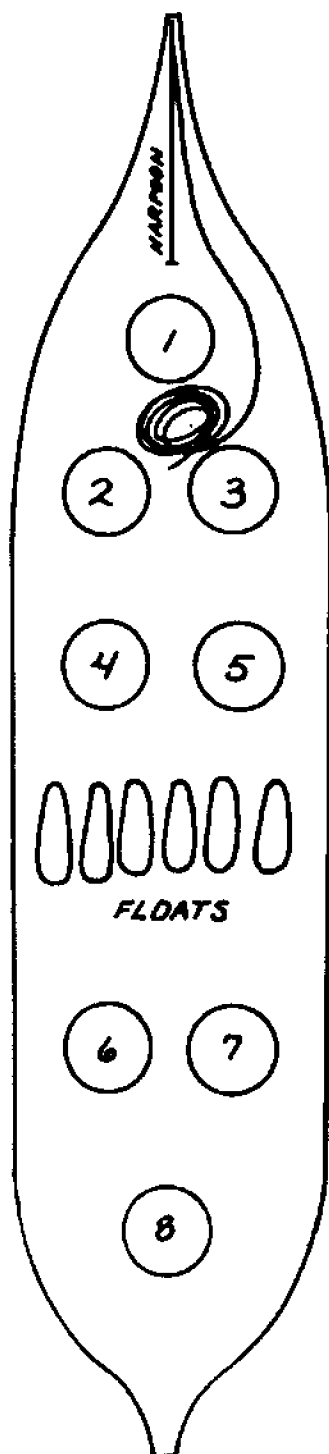

1) The harpooner was leader of the whaling crew and stood in the front (the bow) of the canoe. He used an 8' long harpoon with a detachable point that held a blade made of mussel shell or whale rib. This point was attached to a line about an inch thick, woven from twisted cedar branches and wrapped with sinew from a whale's back. Imagine making a rope strong enough to hold a whale using only what you could find and gather!

(2 & 3) Behind the harpooner sat the two "eye men." They had several tasks. They paddled until the whale was harpooned, and then their job was to quickly attach large floats to the harpoon line, which was coiled neatly in front of them. These floats (called pay-YEE-hwa) were made out of the skins of hair seals and were about three feet long when inflated.

(4 & 5) In the center of the canoe sat two "middle men" who paddled until the whale was spotted, and then they started to blow up the floats (which were stored under the canoe brace behind them). Thus, the floats would be ready for the "eye men" to attach to the line as soon as the harpoon was thrown. For, when the whale felt the harpoon point, it would dive and the rope attached to the harpoon would be dragged down along with it. The floats attached to the line would keep the whale from diving deeply and tire it out so that it would come up to the surface for more air.

(6 & 7) The "power men" were strong paddlers who propelled the canoe into position for harpooning and then paddled in chase of the whale, which might swim half a mile underwater after it was harpooned. Everytime the whale came to the surface, it might be harpooned again, possibly by one of the other canoes on the hunt. (It was common for three to five canoes to hunt together.) Sometimes it took hours and as many as a dozen harpoon wounds before the whale would finally be killed. Just as it died and floated to the surface, one of the "eye men" would have to jump into the water and cut through the whale's lips to tie its mouth shut so that the whale would not fill with water and sink.

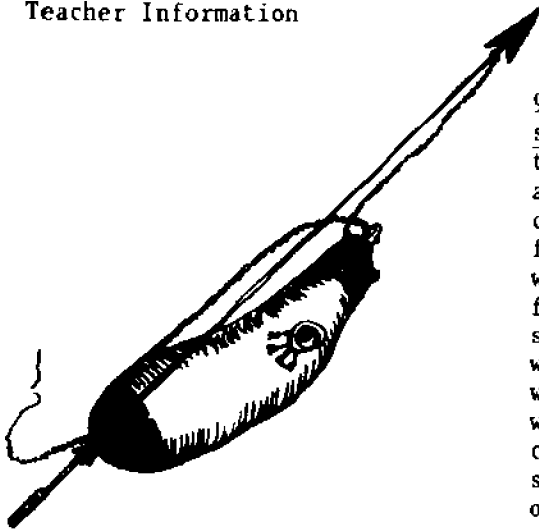

9) The second in command of the crew was the steersman, who sat in the back (the stern) of the canoe and watched for whale spouts. He also kept alert for signals from the other canoes, which would be roving for whales, and followed directions from watchers on shore, who would signal the locations of whales with fires. It was the steersman who silently steered the canoe along the left side of the whale so that it could be harpooned and it was he who tried to predict where the harpooned whale would re-surface so that the harpooner could be in position for a second hit. The steersman had to know a lot about the habits of whales.

In fact, every member of the crew had to be an expert. Paddlers had to know how to paddle silently so that the whale would not hear them approach. Harpooners had to thrust accurately and at just the moment that the whale's tail was on the canoe side. If the tail were pointed away from the canoe, the whale would thrash its tail into the canoe, breaking it into matchsticks. The "eye-men" had to be careful not to get tangled in the harpoon line as it shot out of the canoe. If they were to get caught in the rope, they would be dragged under the water by the diving whale, which might not re-surface for ten minutes.

In our society, being an expert means that one has learned all there is to know about an activity and become skillful at doing it. The old Quileutes would have thought this a very poor preparation indeed. In order to perform any task, from weaving baskets and digging roots to healing the dead or whaling, the Quileute felt that all one needed was a strong "guardian spirit" power and a good relationship with that spirit. You received your spirit power (ta-HEY-lit) by going out alone and allowing a spirit to contact you and teach you what you needed to know in order to be good at tasks. Some spirits taught one how to be an elk hunter, or a medicine man, or a carver . . . or, for a very few lucky ones, a whaler. And some spirits were wiser and stronger than others. If you were taught and empowered by a strong spirit, you got more whales than those harpooners who had weak powers. You can see the difference between the way the Quileutes conceived it and the way that we do, by this example. If you wanted to run the marathon race at the Olympics, you would prepare physically by running every day, eating properly, and getting regular sleep. If you won, you would assume it was because you trained harder than anyone else. A Quileute, on the other hand, felt that you could not even do the most insignificant task without spirit help. And to get that help, you had to get into a good relationship with your guardian spirit and not do anything to make it quit advising and helping you. Spirits disliked grease, so you had to clean your body of all oil (a severe cleaning job for people who ate oily salmon and even dipped berries and roots in oil as they ate them). You cleaned the outside of your body by taking an Indian sauna or seat bath and then by rubbing your skin vigorously with prickly spruce boughs and coarse sand. You cleaned out the inside of your body, flushing it out by eating a leaf or two of the skunk cabbage.

Whalers needed the strongest spirit help of all. Harpooners had to please the spirits by learning the ceremonial chants to Tse-KA-tee, a super-spirit somewhat like Mother Nature, that all other spirits seem to have respected. Harpooners

## Teacher Information

also had to know the old stories (or myths) which bragged about the greatness of their spirits and to please their guardian spirit powers by telling these stories to others. Harpooners also had to please the spirits by singing songs that they had been taught by their spirit power. These harpooners made their whole life seem to be a quest for the whale by such things as dragging a lifesize carving of the back and fin of a whale around behind them everywhere that they went. In return, the spirit made them strong, taught them to "think like a whale," and gave them secrets that helped in whaling. These secrets might be such things as special ways to paint their sealskin float, good luck charms to attach to their harpoon heads or to carry in bags around their necks (often the only thing that a Quileute whaler wore!)

It was not the end of the hunt when one or more whales had been killed and towed to shore. The whale would be beached and cut up according to very precise habit, giving particular parts to each canoe and each member of the harpooners' squad. The harpooners' portions would be honored with eagle feathers and hung up for all to admire while the oil drained from it into a large wooden "feast dish." Then a four-day feast would be hosted by the one who threw the first harpoon. He would give away food and gifts to the guests honoring his own spirit power which had subdued the whale and praising the great whale. Thus, the dead whale's spirit would return to the depths of the sea to report to other whales that it was a fine and appropriately appreciated thing to submit to that harpooner. In the future, other whales would know to surface next to that harpooner's canoe for the honor of being taken by him.

Thus, we can see that although whaling provided food for the Quileutes, it also afforded a means of proving the strength of their spirit power. It was a social practice as well as an economic activity.

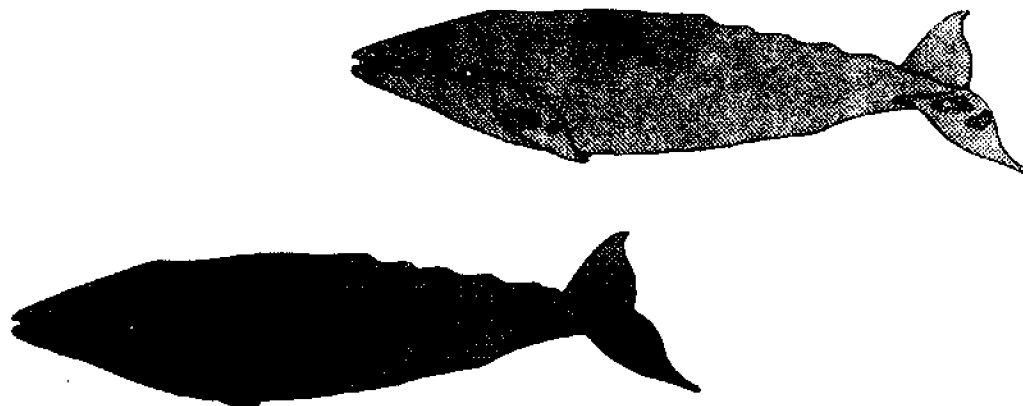

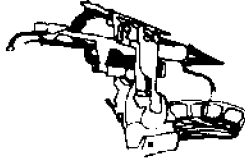
WHALE HUNT<sup>\*</sup>

Hunting whales in a modern whale-catcher is free from the danger met by those who hunted in small canoes, but it is still not easy. These motorized boats can pursue the faster whales, such as the fin whale, that could not be caught in the old days. A whale gunner may have to take his catcher a hundred miles or so from his factory ship, and weathering heavy seas for hours at a time is no joyride.

As the catcher boat nears a whale, the gunner watches the whale each time it comes to the surface and judges its course. He directs the helmsman to steer the ship where he thinks the whale will reappear. If all goes well the whale will be visible like a huge ghost underneath the surface. By then the gunner will have left the bridge and run down the catwalk to the gun platform. The gun, a cannon 45 inches long, stands loaded with a 6 foot harpoon of strong steel. The barbed head is set to explode inside the whale three seconds after striking it.

Everyone on the catcher boat keeps quiet, for the whale is close by and it is easily scared. If it comes up in the proper place, the gunner can look down on the huge blowhole (nostril) as if it were a chimney. Then the hole shuts and the whale goes down. This is the moment of truth; the gunner takes his sight and presses the trigger. The harpoon flies out to hit the whale on the side in front of the dorsal (back) fin. If the wind blows the smoke aside, the gunner can see the harpoon sink into the whale's side and can hear the explosion. The whale dashes away, taking the line with it, but is pulled back as soon as possible. It is often necessary for a second shot to kill it. Once dead, the whale is blown up with air so that it will float. Then a flag and a radar buoy are placed in the body. A buoy boat will come by later to pick up the dead whale and bring it to the factory ship, leaving the catcher ship free to hunt another victim.

Dead whales are dragged by huge winches up a ramp in the side of a factory ship. Then an entire crew of workers set in stripping the blubber, cutting the meat, sawing the bones and sending the different parts of the whale to the proper places on the ship for processing. The blubber is melted down for whale oil and the bones are boiled in huge pots because they too contain large amounts of oil. Whale meat is stored in huge freezers; on Japanese ships this is the most important product as the Japanese people eat a lot of whale meat. Many different uses have been found for whale oil and other whale products. For example, lipsticks, cold creams, lubricating oil, margarine, piano keys, fertilizers and pet food all can be made from whale products if man-made or other sources are not used. In modern factory ships, the baleen (the brushy mouth plates used to filter food from the water) and most of the bones are thrown overboard after the oil has been extracted. Because of the efficiency of modern whaling methods, and the number of whaling fleets in operation, it has been said that a whale is killed every 20 minutes.\*\*

\* Excerpted from The Whale, Tryckare Tre, pp. 203-207  
\*\*The Whale Manual, Friends of the Earth, p. 80.

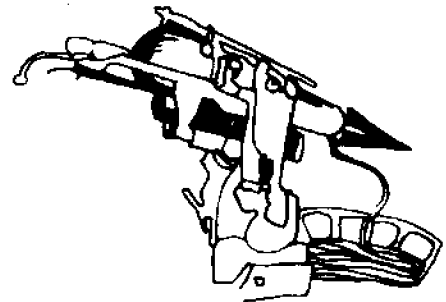

## Teacher Information

## ROLE CARDS FOR INDIAN WHALE HUNT

1. I am a Quileute Indian man with a position of respect as the eldest of the tribe. At the potlatch feast given by the harpoonist who has led a successful whale hunt, I tell the story of the hunt. The people of the village act out their parts as I tell the story. I make sure to praise the strength of the spirit powers of the men who killed and brought home the whale.
2. I am a harpooner. I lead the canoe which took the first whale this season. Afterwards I gave a feast in which I gave away food and gifts to all the guests, honoring my spirit power and praising the great whale it subdued. My whole life is a quest for the whale; I chant the ceremonial chants to Tse-KA-tee, and tell the old stories to please the spirits. My spirit has made me strong and taught me many secrets; I have painted our sealskin floats in the special way my spirit power instructed me. At the moment the whale's tail is on the canoe side I hurl the harpoon with all my strength. If my timing is off, the whale might thrash its tail into the canoe and break it apart.
3. I am an "eye man" in the whaling canoe. I must paddle until a whale is harpooned. Then I attach the sealskin floats to the harpoon line so the whale will be slowed down. I must be careful not to get tangled in the harpoon line as it is pulled out, or I might get dragged into the water with it.
4. I am an "eye man." In addition to the tasks I share with the other "eye man," I must jump into the water when the dead whale has floated to the surface. I cut through the whale's lips with a special knife I bring for this purpose, and sew its mouth shut so the whale will not fill up with water and sink.
5. A "middle man," I paddle until a whale is spotted. Then I blow up the sealskin floats to get them ready for the "eye men." Two of the floats we are using this year are made from the skins of seals I caught this winter. I turned the skins inside out and tied off the holes where the flippers and head used to be, so they can be inflated.
6. My father, the strongest paddler in our village, taught me how to stroke noiselessly yet with great strength, so the whale would not hear our approach. This year I am proud to be in the whaling canoe for the first time. I am a "middle man."
7. I am the strongest paddler in the village. As one of the "power men," I must keep paddling even after a whale is harpooned, and it may take hours and many harpoon wounds for the whale to die.

8. I am a "power man," good at paddling for long periods of time. To please my spirit power, I have cleansed myself in the sweat bath and then rubbed myself with a special spruce branch. In the morning of the hunt I help to prepare the canoe and carry the weapons down the beach to be stored in their proper places.
9. I am a steersman, the second most important man in the whaling canoe. I have to know the habits of the whale very well for I must predict where the whale will surface so that I can position the canoe in the best possible way. I watch for signals from the shore and from other canoes and signal to them when we have struck or killed a whale.
10. I am the best dancer in the village. On the first day of the whale season, I dance a whale being struck, struggling and finally being overcome by our hunters and their spirit powers. I help drag the whale up the beach and I also dance at the potlatch feast.
11. I am a Quileute woman. The crew that my husband hunts with has been successful in bringing us a whale. There is much excitement and activity on the beach as the whale is cut up and people take their share. I am kept busy melting blubber into oil which we will store in skin vessels. Hopefully the oil will last all year until the next Gray Whale migration.
12. A whale has been killed today on my ninth birthday. I help the women of our village by carrying wood to keep the fires going. My favorite part of the whale is the skin and I am rewarded for my part in the work with several pieces.
13. I am not a member of a whaling crew, but I have an important job on the beach. I keep a lookout from above the shore, watching for whales and signals from the whalers. I signal the locations of whales to the canoes with fires and yell to the men on shore to go out and help tow whales that have been killed ashore.
14. With eyes as sharp as an eagle's, I am the first to see the spout of a whale this morning, far out to sea. When the whale is brought to shore, I help to cut off strips of blubber with my long knife and take home a portion for my household.
15. A mature female California Gray whale is swimming with her pod a couple of miles off the coast of the Olympic peninsula. They are on their annual spring migration from the breeding grounds off Baja, California to the summer feeding grounds in the Arctic. An Indian whaling canoe approaches quietly and harpoons the female. She swims away frantically, taking the line with her. More canoes converge and dart her with spears and lances when she surfaces. Soon she is towing several seal skin buoys which make it hard for her to dive. She rests on the surface and the final killing blow is struck by a man from the original canoe.
16. I participate in singing and dancing before the hunters go out. When the signal comes that a whale has been killed, I take my canoe out to help tow it in. At the potlatch I am given a portion of the whale for my household.

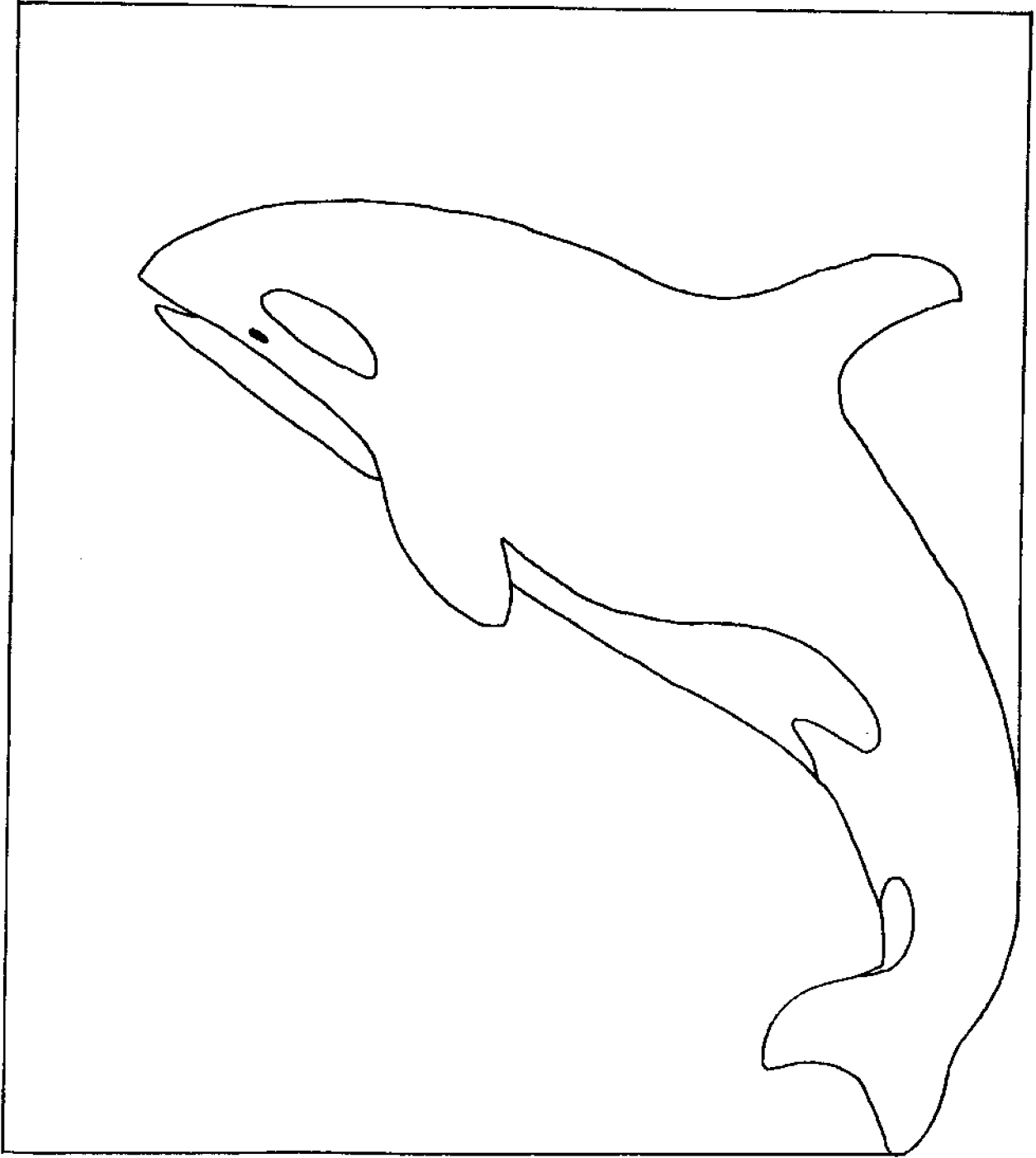

**ACTIVITY 2:**

**WHO'S WHO AMONGST WHALES**

**(6 DAYS)**

## ACTIVITY 2: WHO'S WHO AMONGST WHALES (6 DAYS)

- CONCEPTS:**
1. Whales and dolphins are classified in the order Cetacea, which is split into two groups, the baleen whales and the toothed whales.
  2. Cetaceans are mammals; they bear live young, nurse on mother's milk, are warm-blooded, have hair, and breathe oxygen with lungs.
  3. The large size of some whales makes it necessary for them to live in water, but helps them to conserve body heat in arctic waters.
  4. Cetaceans probably descended from animals that lived on land, and they retain many of the features of land animals.
  5. Cetaceans have many adaptations suiting them to live in the water.
  6. Many species of the great whale are close to extinction because of whaling.

- OBJECTIVES:** The student will be able to:
1. state why whales are considered mammals.
  2. describe the differences between toothed and baleen whales.
  3. list several adaptations of Cetaceans to the marine environment.
  4. describe several individual species of Cetaceans.

### TEACHER

- PREPARATION:**
1. Read Teacher Information, "Whales." If you desire more background information, check the references listed in the bibliography.
  2. Make class set of Student Handouts, "Whales," "Be a Whale," "Two Types of Whales," "Who's Who Amongst Whales." and "Whale Worksheet."

- MATERIALS:**
1. Teacher Information, "Whales."
  2. Class set of Student Handouts:
    - a. "Whales"
    - b. "Be a Whale"
    - c. "Two Types of Whales"
    - d. "Who's Who Amongst Whales"
    - e. "Whale Worksheet"

- PROCEDURES:**
1. Introduce the topic by asking the students what they know about whales, what animals whales are related to, and what their habits are. Be sure to cover the following in the discussion:
    - a. Whales, dolphins and porpoises are mammals; they breathe air, bear their young alive, nurse their young and are warm-blooded.
    - b. Whales are probably the largest animals ever to have lived on earth. Their size makes it impossible to live on land but enables them to keep warm in cold waters.
    - c. Whales probably descended from land animals long ago and share certain features with existing ones. Skeletal features are a good example.



2. During discussion about mammalian characteristics of whales, be sure to describe their breathing. Have the whole class try to breathe like a whale. "Lie on your back and blow all the air out of your lungs. Take a deep breath and hold it as long as you can. How long can you hold it? Sperm whales can hold their breath for as long as one hour. When you can't hold it any longer, blow the air out in a fast puff. Take a quick deep breath and start over."
3. Hand out student worksheet, "Whales" and picture of skeletons. Have the class complete the worksheet as an assignment and discuss after completion.
4. Explain or define adaptations as: structures (or behaviors) that allow an organism to be well suited to the conditions of its environment (where it lives) or life style. For example, wings and feathers are adaptations allowing a bird to fly. Encourage them to come up with their own examples. Present this list of adaptations to the students (on the chalkboard or overhead projector) and have the students choose those which they think might be adaptations of Cetaceans living in a marine environment (as opposed to adaptations for a terrestrial [land] lifestyle.)

Adaptations - Marine or Terrestrial?

- a. glands that oil the eye
- b. fur
- c. young born tail first
- d. sweating
- e. streamlined shape
- f. layer of blubber
- g. large size
- h. arms and legs
- i. concentrated urine
- j. curling up to keep warm
- k. low heart rate while diving
- l. young born head first
- m. echolocation system
- n. tear ducts
- o. tail and flippers

Discuss their choices and ask for reasons why they say what they do. See Teacher Information, "Whales" for background information necessary to lead discussion.

A word of caution: some adaptations may be suitable for certain land animals as well as Cetaceans; for example, desert animals as well as whales excrete a concentrated urine in order to conserve freshwater in the bodies. Bats also have an echolocation system. If these types of issues come up, point out that their answers are perfectly acceptable,

and features that are adaptive to one environment may work equally well in another environment.

5. Hand out student sheet, "Two Types of Whales" and go over the content with the class. Have the class try to eat like a baleen whale. "Take a mouth full of food and water mixed together. Now bite down with your teeth, keeping your lip open. Use your tongue to push the extra water out of your mouth through your teeth. Now you are ready to swallow."
6. Hand out "Who's Who Amongst Whales" to be read as an assignment and kept in the student notebooks.
7. Hand out "Be a Whale" and have the class go through some or all of the activities together. Students can then choose their own medium (drawing, poetry, or whatever) to express, independently or in pairs, how it feels to be a whale.
8. Hand out "Whales Worksheet" to be used as an evaluative tool.

**EXTENDED  
ACTIVITIES:**

1. Study individual species of whales in more detail. Each student may wish to pick a species, do a research project, and become the expert on that whale.
2. Make paper models of whales to scale. Stuff them with newspaper, sew them with yarn.
3. Use the pictures on the grid in order to reduce or enlarge whales' outlines to scale. (For more specific directions, see the Grade 5 volume of the Houghton-Mifflin Series, 1979, p. 101 or #446 in the Pacific Science Center marine education files).
4. Have the students graph their own breathing rates. This will help to emphasize the remarkable ability of whales to dive for long periods of time.
5. Make a key to the classification scheme for Cetaceans.
6. Visit the whale museum at Friday Harbor on San Juan Islands or the aquarium in Seattle, Washington or Vancouver, British Columbia.
7. Show a movie or filmstrip about whales.

## WHALES

There is strong evidence that millions of years ago, animals that developed into whales lived on land, or at least in marshy places. The hint of land origins in the skeleton of the whale is a small undeveloped pair of bones near the rear of the whale, which is where the hip bones would be if the whale had legs. Whales do not have front legs or arms, but the bones inside the front, or pectoral, flippers of a whale have an arrangement very much like the bones in your own hand. Try comparing the number and arrangement of bones in the whale flipper with a human arm and hand.

Although whales live in the ocean and have the same general streamlined shape as fish, their bodies function more like many land animals. Their young are born alive and nurse on mother's milk. They are warmblooded; a thick layer of fat called blubber helps them to maintain a constant body temperature.

Whales cannot get oxygen directly from water as can fish; they have lungs and breathe air. Whales have tubes leading from their lungs to one or two holes on top of their heads. When a whale needs air, it rises to the surface so that only the top of its head is out of the water. It blows water and old air out through the blowhole(s) and then takes several breaths to get its lungs full before diving. An average diving time may be 15-20 minutes. Some whales can hold their breath underwater for over one hour.

Because of the characteristics already mentioned and other similarities in structures (whales have hair, though it is not very useful in water) scientists classify whales and dolphins as mammals, along with human beings, cats, dogs, etc.

Cetaceans (se-TAY-shuns), the scientific name for whales and dolphins, are well adapted to marine life and are incapable of living out of the water. Their bodies are streamlined for efficient movement, and their fore limbs modified into flippers. The external hindlimbs have disappeared completely and the tail has been modified to form a fluke which provides propulsion by up and down movements. Properties of the skin and its underlying layers allow the shape of the body to vary as the animal moves through the water, thus reducing resistance and drag. Many physiological changes, such as decreased respiration and heart rates, allow for deep dives. Whales avoid the condition known as the bends that human divers are subject to by holding their breath for a whole dive.

As an animal increases in size, there is proportionately less skin area exposed, and therefore, less heat loss to the environment. (If this confuses you, visualize a cube. Six sides are exposed to the environment. In our example each side of the small cube is 1 inch square, therefore the volume is 1 cubic inch. The ratio of surface area to volume is 6:1. In the larger cube, the surface area is greater (24 square inches) but so is the volume (8 cubic inches). Therefore, the ratio of surface area to volume is 3:1.

## Teacher Information

MEASUREMENTS  
ARE REPRESENTATIVE,  
NOT EXACT.

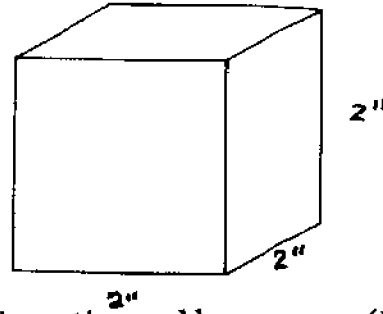
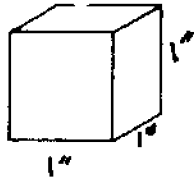

If these cubes were animals, it would be harder to keep the small one warm (because of heat loss) than it would be to keep the larger cube warm. Because of their large size, whales can live in very cold arctic waters.

In addition, a thick layer of blubber underneath the skin insulates against the cold, performing a function similar to fur in terrestrial animals. Other adaptations mentioned in the list from the procedures page, which apply to Cetaceans are: glands that oil the eye (to protect against salt water); young born tail first (because of their shape and their need to be brought to the surface immediately in order to breath) and an echolocation system (more efficient than sight in a dark environment, especially since water is a much better conductor of sound than air. (See Activity III, "Echolocation," for more information and things to do.) Obviously, this is not an exhaustive list of Cetaceans' adaptations to water. If you want to learn more, check one of the references listed.

Many of these beautiful and fascinating creatures are becoming scarce. The pressures of modern technology with its improved hunting methods, have pushed some species of the great whales to near extinction. Without rigid controls on hunting, backed by international cooperation and enforcement, we may reduce their numbers so greatly that they cannot recover.\*

\*See Friends of the Earth, The Whale Manual

## WHALES

Whales are the largest creatures ever to have lived on earth. A Blue Whale may grow to be 100 feet long. Would such a whale fit inside your classroom? Would your classroom fit inside a blue whale? (You may want to measure your classroom or your school building in order to compare.)

Whales are so big that they can only live in the ocean. Like Brontosaurus and other large dinosaurs, they need water to help support themselves. On land they would crush to death under their own weight.

1. Whales and dolphins have many features in common with land mammals. Name at least three.

[hair, skeletal structures, warm-blooded, young born alive, mothers nurse young, lungs]

2. Look at the skeleton of a right whale below. Notice the three bones coming off the backbone towards the rear of the whale. What purpose do you think they serve?

[These bones are where hips bones would be if the whale had legs, but through years of evolution, have decreased in size.]

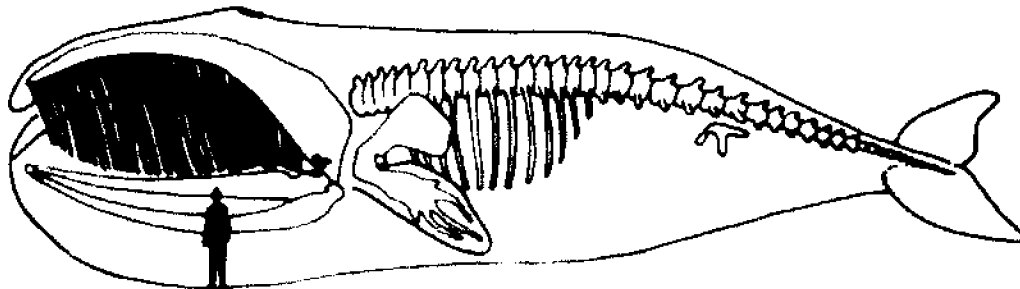

3. Compare the number and arrangement of bones in the whale's flipper with a human arm and hand. What does this tell you about whales and humans?

[They are closely related; the same bones have come to be used for different purposes in humans and whales.]

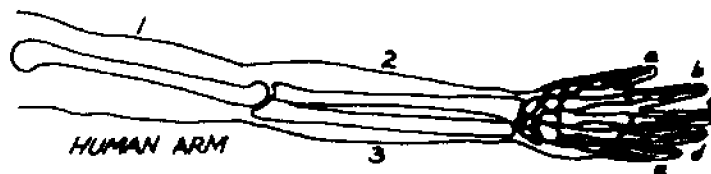
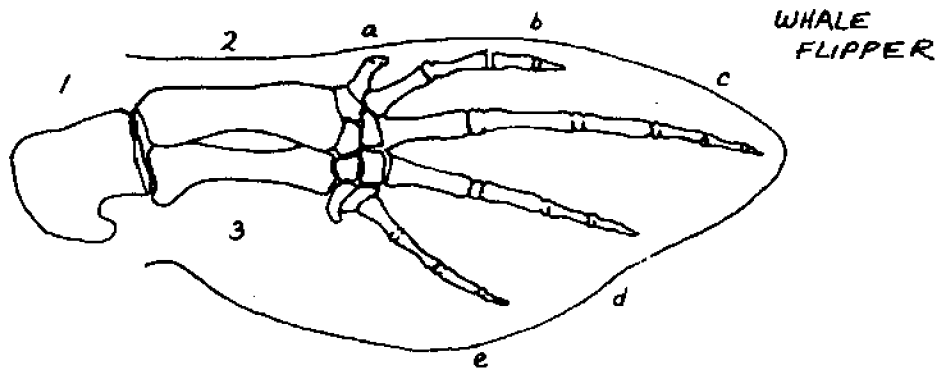

## WHALES

Whales are the largest creatures ever to have lived on earth. A Blue Whale may grow to be 100 feet long. Would such a whale fit inside your classroom? Would your classroom fit inside a blue whale?

Whales are so big that they can only live in the ocean. Like Brontosaurus and other large dinosaurs, they need water to help support themselves. On land they would crush to death under their own weight.

1. Whales and dolphins have many features in common with land mammals. Name at least three.
  - A. \_\_\_\_\_
  - B. \_\_\_\_\_
  - C. \_\_\_\_\_
2. Look at the skeleton of a right whale below. Notice the three bones coming off the backbone towards the rear of the whale. What purpose do you think they serve?

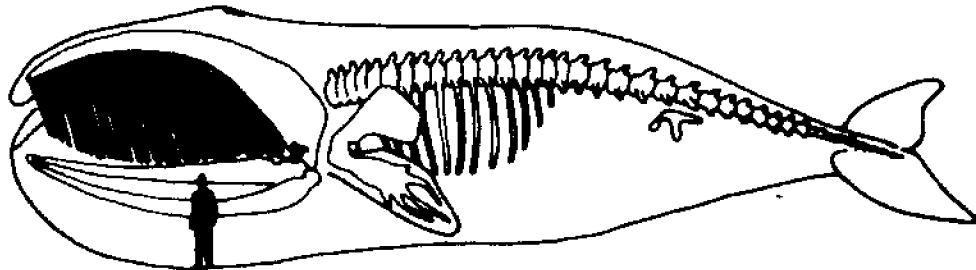

3. Compare the number and arrangement of bones in the whale's flipper with a human arm and hand. What does this tell you about whales and humans?

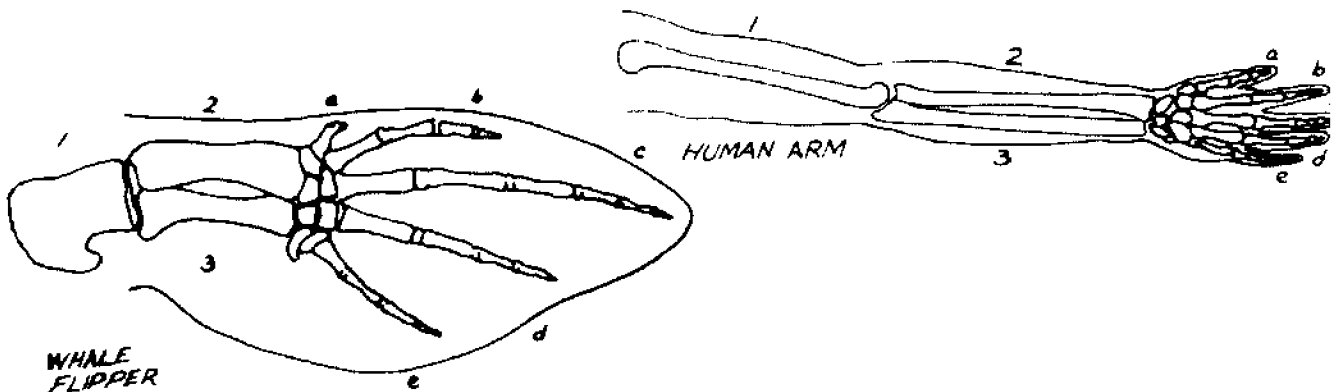

## TWO TYPES OF WHALES

All whales and dolphins are classified as Cetaceans (Se-TAY-shuns), a subgroup of the order mammals. They are divided into two groups. The main differences between the two is how they eat, what they eat and the feeding structures that they have.

## ODONTOCETES (pronounced o-DON-tuh-seets)

These whales have teeth and hunt individual prey, such as fish or squid. They are fast swimmers and seem to have a well-developed language. Except for the giant sperm whale, Odonotcetes are smaller and have smaller head than the whalebone whales.

*Toothed Whale*

## MYSTICETES - (pronounced MIS-tuh-seets)

These are the whalebone or baleen whales. They are not supplied with teeth, but have many (up to 600) filter blades hanging from the upper jaw on either side of the tongue. The blades, called baleen or whalebone, have many stiff hairy fingers that the whales use to filter masses of small food animals out of the water. With its mouth open, a whale swims through areas with great concentration of shrimp like animals. It takes in large mouthfuls of water and then pushes the water out with its tongue. The food animals are left trapped on the fringes of the baleen and the whale then uses its tongue to lick the food off the baleen.

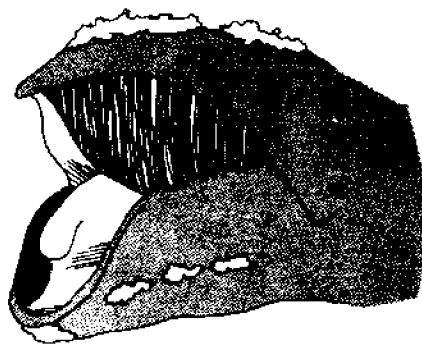
*Baleen Whale**Baleen*



NAME \_\_\_\_\_

WHO'S WHO AMONGST WHALES

MYSTICETES

Humpback Whales (40 ft.) Chunkier in shape than most of the streamlined baleen whales. Humpbacks got their name from the manner in which they lift their backs out of the water before diving. This playful species has attracted considerable attention in recent years because of its complex 'songs'. Today, Humpbacks are very few in number because of over-exploitation and it may be years before their stocks increase.



Gray Whale (45 ft.) - These migrate from the Arctic down the Pacific Coast to the lagoons in Southern California where they give birth to their young. Intense hunting in the 1800's reduced the numbers of Gray Whales drastically but the population is slowly recovering with protection from the International Whaling Commission (IWC).



Right Whale (50 ft.) - Because these whales swim slowly and float when harpooned, early whalers termed them "right" whales to pursue and capture. The Greenland Right whale was one of the first species to be hunted to commercial extinction - which means there are so few left it is not worthwhile hunting them. These rare animals can be identified by a V-shaped double spout.



Fin Whale or Common Rorqual (80 ft.) - Similar in appearance to the Blue Whale, but the Fin is more slender and white underneath. Fins have been hunted heavily since World War II, and their numbers seem to be declining despite quotas on their harvest.



Blue Whale (100 ft.) - The largest animal on earth (perhaps the largest animal that ever lived), the Blue Whale is sometimes called the Sulfur-bottom because its belly is tinged yellow by colonies of microscopic diatoms. The Blue Whale was the preferred species of the whaling industry early in this century and was hunted to near extinction until 1966 when a ban was placed on killing it.



## ODONTOCETES

Bottle-Nosed Dolphin (12 ft.) - Probably the best known of Cetaceans, (a bottle-nosed dolphin played "Flipper" on the television series), more members of this species have been studied and kept in captivity than any of the whale family. They are easily trained, playful and friendly; many instances have been reported of dolphins accompanying humans and befriending them.



Narwhal (15 ft) - In the male Narwhal, one tooth on the upper jaw grows in a spiral to a length of 8 or 9 feet, making the animal resemble the Unicorn of mythology. What the tooth is used for is unknown, and, as the Narwhal is not really hunted anymore, it has not been the subject of much study.

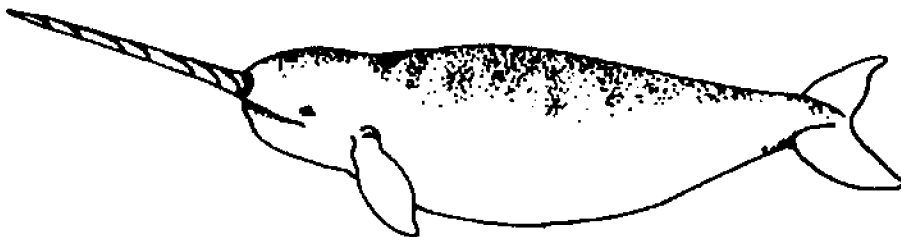

Killer Whale, or Orca (30 ft) - The Orca, actually the largest of the dolphins, is the only Cetacean that preys on warm-blooded animals (seabirds, seals, walruses, and even other Cetaceans), though they also eat fish and squid. Once thought of as bloodthirsty murderers, they have been found to be gentle and highly intelligent animals in captivity. Orcas are native to Puget Sound and are frequently spotted in our waters.

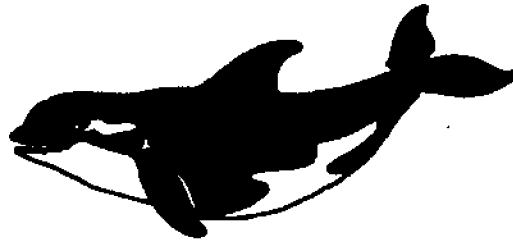

Sperm Whale (60 ft.) - A prime target of both early and modern whalers, Sperm Whales provide not only whale oil, but spermaceti, a clear oil found in their gigantic squared-off heads, and ambergris, a gray sticky material taken from their intestines. The Sperm Whale population has been greatly reduced, and there has been much controversy over the IWC ban on the Sperm Whale catch.



## BE A WHALE

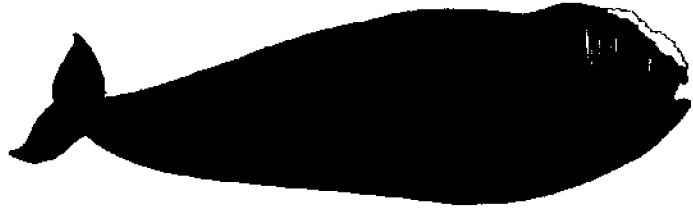

Try to imagine what it would be like to be a whale or dolphin. Think about some of the following and discuss them with your classmates. Get out of your chair and try some of the activities.

## WHAT IF . . . ?

- . . . you had no hands - no thumbs nor fingers - to pick things up or to push buttons?
- . . . you had your nose on top of your head?
- . . . the classroom was full of salt water and all your food floated or swam in it?
- . . . your babies breathed air, but were born in water?
- . . . you had your eyes on either side of your head?
- . . . you had to 'see' with your ears?
- . . . you swam like the whale? Your flukes (try putting your feet together) would propel you by up and down movements

Now, write a poem or draw a picture that shows how it feels to be a whale.

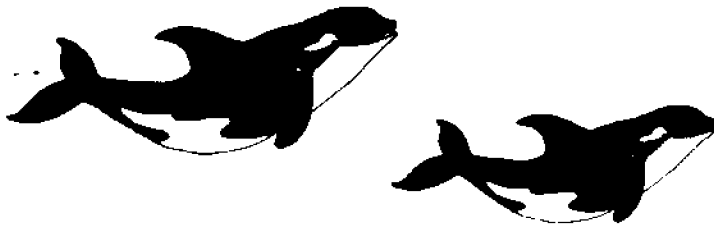

## Teacher Information (Key)

## WHALES WORKSHEET

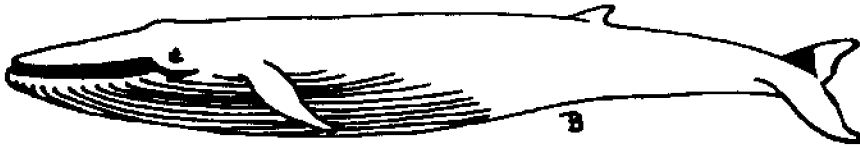

1. Can you name these four animals?
- A. [Sperm Whale]
- B. [Blue Whale]
- C. [Orca - Killer Whale]
- D. [Gray Whale]

2. Which is the largest animal to have ever lived?

[B- Blue Whale]

How might its size be useful to its life style?

[Help it to keep warm in cold waters]

3. Which one might you find in Puget Sound?

[C-Orca]

4. Which one(s) has (have) teeth?

[A- Sperm Whale and C- Orca]

What is the group they belong to called?  
[Odontocetes]

5. Which one(s) doesn't (don't) have teeth?

[B-Blue and D-Gray]

What group do they belong to?

[Mysticetes]

Describe how they feed.

[Mysticetes have filter plates called baleen that hang down the sides of their mouths from the upper jaws. They filter small crustaceans out of the water.]

6. Which one might have been hunted by the Quileute Indians?

[D- Gray Whale]

7. Can you describe some features and behaviors that enable Cetaceans to live in water?

[glands that oil the eye, concentrated urine, young born tail first, echo-location systems, flippers and flukes, blubber, large size, decreased heart rate while diving, ability to hold breath for long periods of time, nostril on top of head.]

## WHALES WORKSHEET

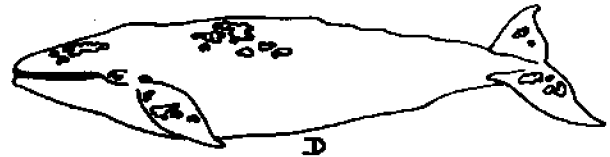
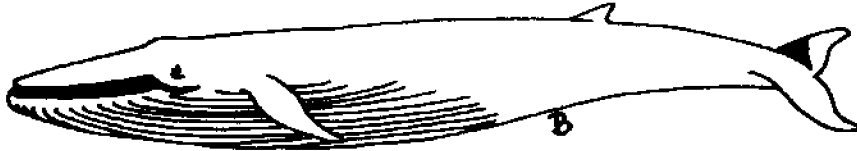

1. Can you name these four animals?

- A. \_\_\_\_\_  
 B. \_\_\_\_\_  
 C. \_\_\_\_\_  
 D. \_\_\_\_\_

2. Which is the largest animal to have ever lived?

How might its size be useful to its life style?

3. Which one might you find in Puget Sound?

4. Which one(s) has (have) teeth?

What is the group they belong to called?



5. Which one(s) doesn't (don't) have teeth?

What group do they belong to?

Describe how they feed.

6. Which one might have been hunted by the Quileute Indians?

7. Can you describe some features and behaviors that enable Cetaceans to live in water?

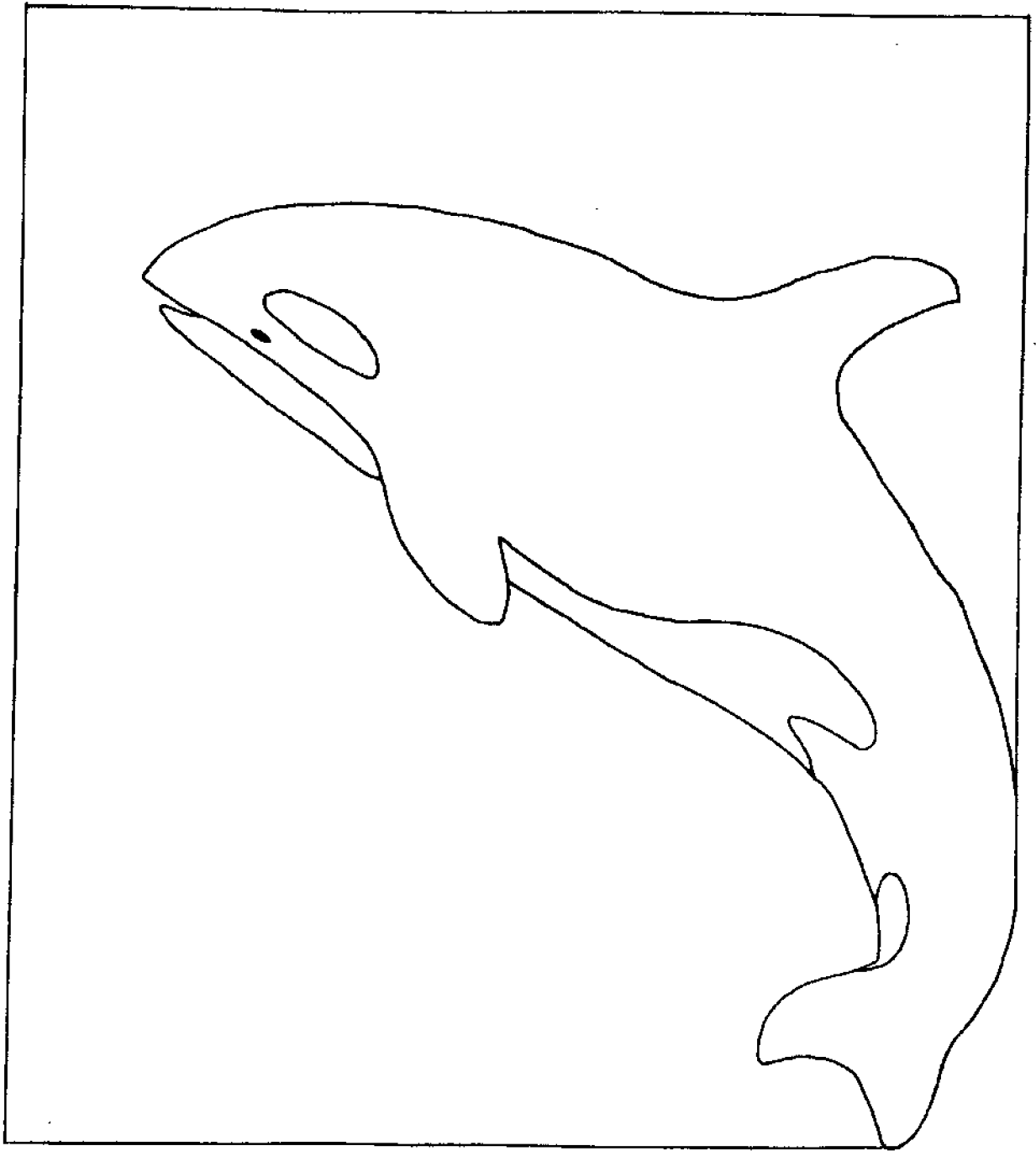

**ACTIVITY 3:**  
**ECHOLOCATION**  
**(5 DAYS)**

## ACTIVITY 3: ECHOLOCATION (5 DAYS)

- CONCEPTS:**
1. Hearing is the most important sense for Cetaceans; in a dark water environment, a highly developed sense of hearing is more useful to an animal than sight.
  2. Many Cetaceans send out high frequency clicks that they use in a precise echolocation system.
  3. Water is a good conductor of sound.
  4. Having 2 separate ears allows animals to determine the direction of a sound source.
  5. The distance to an object can be gauged by timing the echo from it.

- OBJECTIVES:** The students will be able to:
1. identify the importance of hearing to a Cetacean.
  2. show how 2 ears are used to orient to a sound.
  3. tell how the echo changes as distance from an object changes.

### TEACHER

**PREPARATION:** See materials list below.

- MATERIALS:**
1. Class set of student handout, "Experimenting with Echoes"
  2. glass or plastic aquarium tank, about 6 quarts capacity
  3. water
  4. 2 rocks
  5. 2 blocks of wood
  6. stopwatch
  7. comb

- PROCEDURES:**
1. Read the paragraph about the dolphin and trainer out loud to the class. Ask them what they think was happening. They may come up with a variety of explanations (e.g., the dolphin felt the heat from the light bulb, there was electricity, etc.). Ask them how they would test their theory if they were that trainer. [What the trainer finally figured out was that dolphins prefer to listen - to hear the click of the switch - rather than look. This story demonstrates how important hearing is to dolphins; they depend on their hearing in situations in which humans depend on their sight.]

A trainer taught a dolphin to approach a light bulb only when lit. The dolphin always performed correctly but never looked at the light bulb. The confused trainer hid the light bulb. Nothing happened. He turned it on, and sure enough, the dolphin swam towards it.\*

\*Copyright. Permission to reproduce granted by Charles Scribner's Sons, N.Y. from "The Ways of Whales" by Peter Warshall, Mind in the Waters, ed. Joan McIntyre.

2. Read the second anecdote aloud and discuss as before. [Although whalers, fishermen and others coming into contact with whales/dolphins had suspected for years that Cetaceans had some way of 'seeing' other than sight, it was this incident that led to research on the echolocation system of dolphins and porpoises. It was eventually determined that the animals were using a sonar system to dodge the small-mesh nets, but their sonar somehow did not identify the large-mesh nets as an obstacle. If students had suggested blindfolding dolphins as a way of proving they are not using their eyes, you might mention that in the first classic experiment, suction cups were used as a painless way to blindfold the animals. Much research has been done since, mostly with the toothed whales, and their sonar systems appear to be 10 times more efficient than any sonar equipment in use by humans.]

Some years ago a fisherman at Marine Studios in Florida, noticed that dolphins never charged into the small-meshed (small holes) net used to capture small fish. The dolphins would leap over the cork line to escape, even at night time and in murky waters. On the other hand, if a large-mesh net was being used, the dolphins almost always charged into it. The only time they would leap over a wide-mesh net was after others had struck it and pulled the cork line under water. (Alpers, p. 118\*)

3. You may need to convince yourself and the students that sound does travel through water. (Water is a better conductor of sound than air, and sound travels 3-5 times as fast in water.) Tap the side of an empty plastic or glass aquarium tank and note the sound. Have a student put his/her ear inside the tank and on the side of the tank to listen to the tapping. Now fill the tank with water. (You may omit the part about putting an ear inside the tank, if you don't want to get a student wet.) Can the students hear any difference? Also, try tapping 2 rocks together in air and underwater and comparing the sound that comes to the ear through air and through water.

\*Copyright. Alpers, Anthony, Dolphins: The Myth and the Mammal, Houghton Mifflin, Co. Boston 1960.

Students who snorkel can try talking underwater through their snorkels. It's amazing how well you can hear speech underwater.

4. Because the external ears of most whales and porpoises are small and inconspicuous, it was formerly thought that they were not functional. However, the middle and internal ears are highly developed, and many of the Odontocetes that have been studied appear to receive sound through the lower jaws. (For more information, see McIntyre, pp. 133-140.)

Receiving the same sound on both sides of the head allows one to get a directional fix on the source. The students can experience this with their own sense of hearing.

Have one student be the dolphin and another be the fish 'target'. The 'target' makes a sound (previously agreed upon - snapping fingers, clapping, etc.) and the 'dolphin', his/her eyes closed and head stationary, points to the direction the sound is coming from. Try several different positions of the 'target'. Can the 'dolphin' locate the direction of the target? [Probably very easily.]

Now have the 'dolphin' cover one ear. Repeat the attempt to locate the target. Is it as easy this time? [Probably not. Unless a sound source is located at an equal distance from the two ears, there is a time lag between the arrival of sound at the two ears (see diagram). There may also be a difference in intensity between the sound received by the two ears. Our brain automatically computes the difference in messages sent to it by the two ears and determines the direction the sound must be coming from (see diagram).

#### Using Two Ears to Orient to a Sound

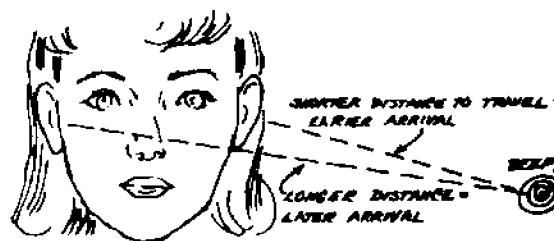

Using only one ear, the only clue that can be used is in which direction the sound is loudest.]

Allow the 'dolphins' to move their heads, repeating the one ear exercise. Does it help them to orient (find the direction)? Now instruct the 'dolphins' to use both ears and move their heads around slowly, (they may turn their entire body) attempting to be conscious of how the sound changes as they turn towards it or away from it. When they reach the point where the sound seems to come into the two ears equally, they may open their eyes. What are they looking at? [If they have listened carefully, they are facing the 'target.'] Have they ever seen animals do this? [Many animals, as well as people, will orient in this way by hearing, and then find the target by eyesight. Dolphins and porpoises probably don't use their sight until after they have zeroed in with their hearing.]

5. Experiment with echoes. Find a wall or other area outside that gives a good echo, and visit it at a quiet time of day. Designate one student the noise-maker, one the timer, one the pacer, and the rest of the class as recorders. Have the pacer measure 50 paces from the wall, and everyone stand at that distance. The noise-maker can hit 2 pieces of wood together to make a sharp sound. The timer, with a stop-watch, starts the stop-watch at the initial sound and stop it when s/he hears the echo. This will take some practice as the time interval is very short and it is difficult to be precise. The class recorders should fill in the chart showing distance from the wall and time for echo to return.

Pace off 50 more paces (how far away are you now?) and take another reading. Take about 10 readings or as many as needed to get a definite trend showing in the time of echo column.

Go back to the classroom and discuss the results. Did they feel like they got good data? Why or why not? [It is difficult to measure such short time intervals.] What happens to the time lag as you move farther away? [The time should increase as the distance from the wall increases, showing us that sounds in air take a measureable amount of time to travel a given distance, and that the time increases as the distance increases. The time for an echo to return will also increase with the distance, and if that time can be accurately measured, the distance to the object causing the echo can be gauged. Cetaceans have the sensory apparatus necessary to gauge these times and distances. Humans have built such devices as sonar to do the same thing, but far less precisely than dolphins.]

How far does the sound have to travel when you are 50 paces from the wall? [The sound travels 50 paces twice - going out to the wall and coming back as an echo - so it travels 100 paces. Now the person who did the pacing should measure their average stride. If that stride measured  $\frac{1}{2}$  meter, 100 paces would measure  $100 \times \frac{1}{2}$ , or 50 meters.]

6. A dolphin's sense of echolocation is so accurate they can tell the difference between a ball  $2\frac{1}{2}$  inches across and one  $2\frac{3}{4}$  inches across. To demonstrate this, have students cut out the two circles, one  $2\frac{1}{2}$  inches across, and one  $2\frac{3}{4}$  inches across, from the bottom of the "Experimenting with Echoes" worksheet. Working in pairs, one student should stand 35 paces away from a classmate holding the paper with the circles. How easily can they tell the circles apart? (idea from Project Jonah.)

One researcher reports that dolphins could hear a teaspoon of water dropped into a large oceanarium pool and would echolocate the spot.\* Suggest that the students compare their own underwater hearing the next time they go swimming.

7. Now that the students have experimented with some of the physics of location by sound, wrap up with a discussion of the biological structures possessed by Cetaceans to employ these methods. All of the toothed and some of the baleen whales can 'see' with sound. Cetaceans have no vocal chords; how do they produce sounds? [Largely unknown. Whales, dolphins and porpoises produce a variety of whistles, clicks, squeaks and rumbles by vibrating or forcing air past various structures in the nasal passages and around the opening of the blowhole.] What are the sounds used for echolocation like? [They emit high frequency clicks - the lowest sounds are used for information about the topography, the middle ones for communication with each other, and the highest pitched ones for finding food. Most of these clicks are too high for human ears to hear, but researchers have described those we can hear as sounding like squeaky or rusty hinges. Perhaps you have a door or window in your classroom that can demonstrate this. Or have students run their thumbnail across a comb to imitate the rapid fire clicks.] (For more detail, consult the references listed.)
8. Hand out student worksheet, "Echolocation" to be used for evaluation.

\*Dr. Winthrop Kellogg, cited in McIntyre, p.138. He also reports that the sound of rainwater on an outdoor tank was so painful that the dolphins kept leaping out of the water to escape the sound.

**EXTENDED  
ACTIVITIES:**

1. Study the topic of echolocation in Cetaceans more fully. See the bibliography at the end of the entire packet for an extensive list of references. One interesting area to investigate would be research the U.S. Navy has done in using the echolocating abilities of porpoises for military purposes. (If you can find the information - much of it is classified!)
2. Study other animals that use echolocation. (Bats, for example.) Compare their sound producing and sound receiving structures to those of Cetaceans. Why would echolocation be adaptive in an environment different from the sea?
3. The echo experiment described in this activity can be used as a basis for measuring the speed of sound in air. The noise-maker has a harder job now; s/he should practice hitting the wood blocks together in a regular rhythm of one hit per second. Classmates can help to time this by counting hits; 10 hits in 10 seconds on the stopwatch would mean 1 hit per second, on the average. Now go back to the wall with a stopwatch and long steel measuring tape (for accuracy's sake.) Start at a distance of about 500 feet from the wall and start hitting the blocks once per second. Listen to the echoes and move closer to or farther away from the wall until the echoes coincide with the hits. Measure the distance. At this distance a sound reflected back as an echo takes exactly one second to arrive back at the starting point - and coincide with the next hit. The distance it traveled to and from the wall divided by one second is the speed of sound in air. (Remember to multiply the distance to the wall by two!)

Challenge - how would you calculate the speed of sound in water?

4. Blind people learn to listen to echoes to locate edges and walls. They can sense many things that sighted people couldn't imagine sensing without their eyes. Read up on the subject, or invite an instructor to come to class to give the students a lesson as if they were blind.



## EXPERIMENTING WITH ECHOES

<u>Distance From Wall</u>	<u>Time of Echos Between</u>	<u>Distance From Wall</u>	<u>Time of Echos Between</u>
0 paces	0 seconds	400 paces	
50 paces		450 paces	
100 paces		500 paces	
150 paces		550 paces	
200 paces		600 paces	
250 paces		650 paces	
300 paces		700 paces	
350 paces		750 paces	
400 paces		800 paces	

Can you tell these apart with your eyes as well as a dolphin can with its ears?

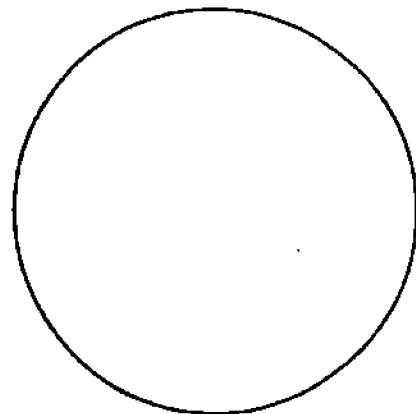
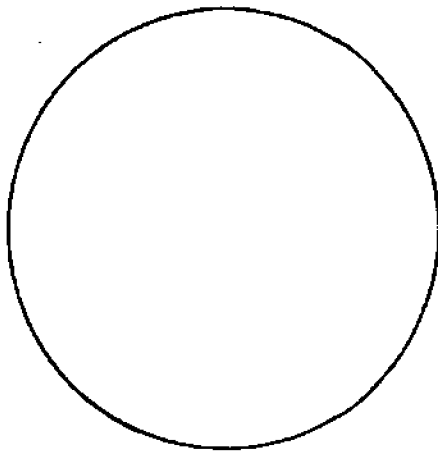

### ECHOLOCATION

1. What kind of difficulties might you have if you were deaf in one ear?

[You would have problems determining direction that sounds were coming from unless you moved your head around. You would also have trouble hearing sounds coming from a source that is pointed toward the deaf ear.]

2. Imagine you are in a large ballroom 30 meters long. You clap your hands while standing at one end and after a time delay, the echo returns to you. How far has the sound travelled?

[60 meters - to the far wall and back]

If the speed of sound in air is 300 meters per second, how long will it take for the echo to return?

[0.2 seconds]

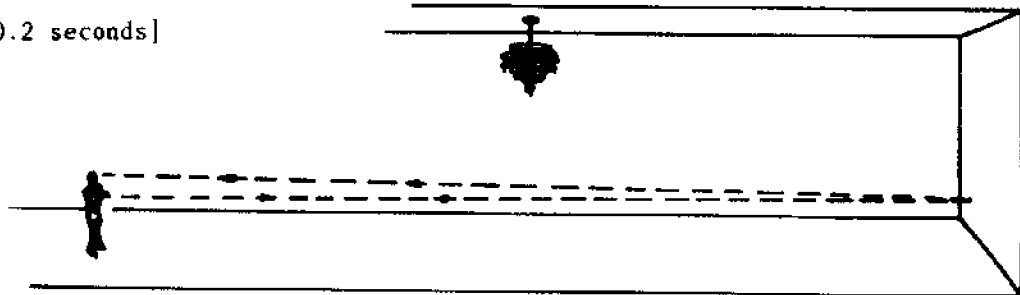

3. A bottle-nosed dolphin is swimming straight ahead, sending out high-frequency clicks in search of a meal. Echoes bouncing off a fish return to her, arriving earlier on her left side than on her right. As she continues to swim, the echoes arrive later and later. Which way should the dolphin turn to catch the fish?

[She should turn to her left and backwards. When she hears the echoes arriving at both sides at the same time, and coming sooner, she is heading right for the fish.]

## ECHOLOCATION

1. What kind of difficulties might you have if you were deaf in one ear?
2. Imagine you are in a large ballroom 30 meters long. You clap your hands while standing at one end and after a time delay, the echo returns to you. How far has the sound travelled?

If the speed of sound in air is 300 meters per second, how long will it take for the echo to return?

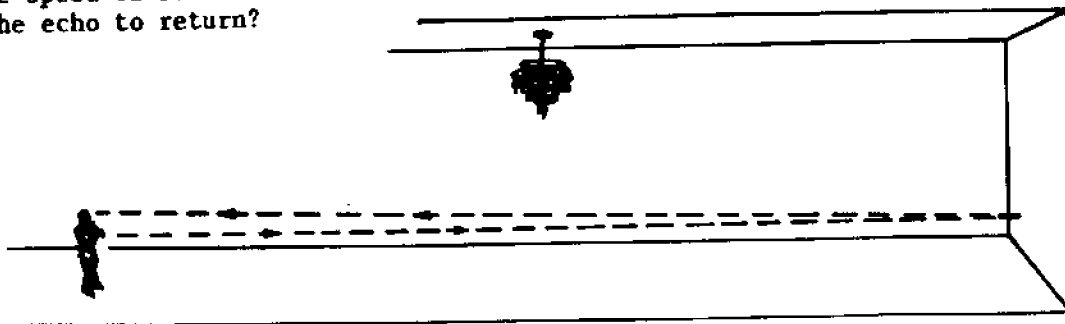

3. A bottle-nosed dolphin is swimming straight ahead, sending out high-frequency clicks in search of a meal. Echoes bouncing off a fish return to her, arriving earlier on her left side than on her right. As she continues to swim, the echoes arrive later and later. Which way should the dolphin turn to catch the fish?

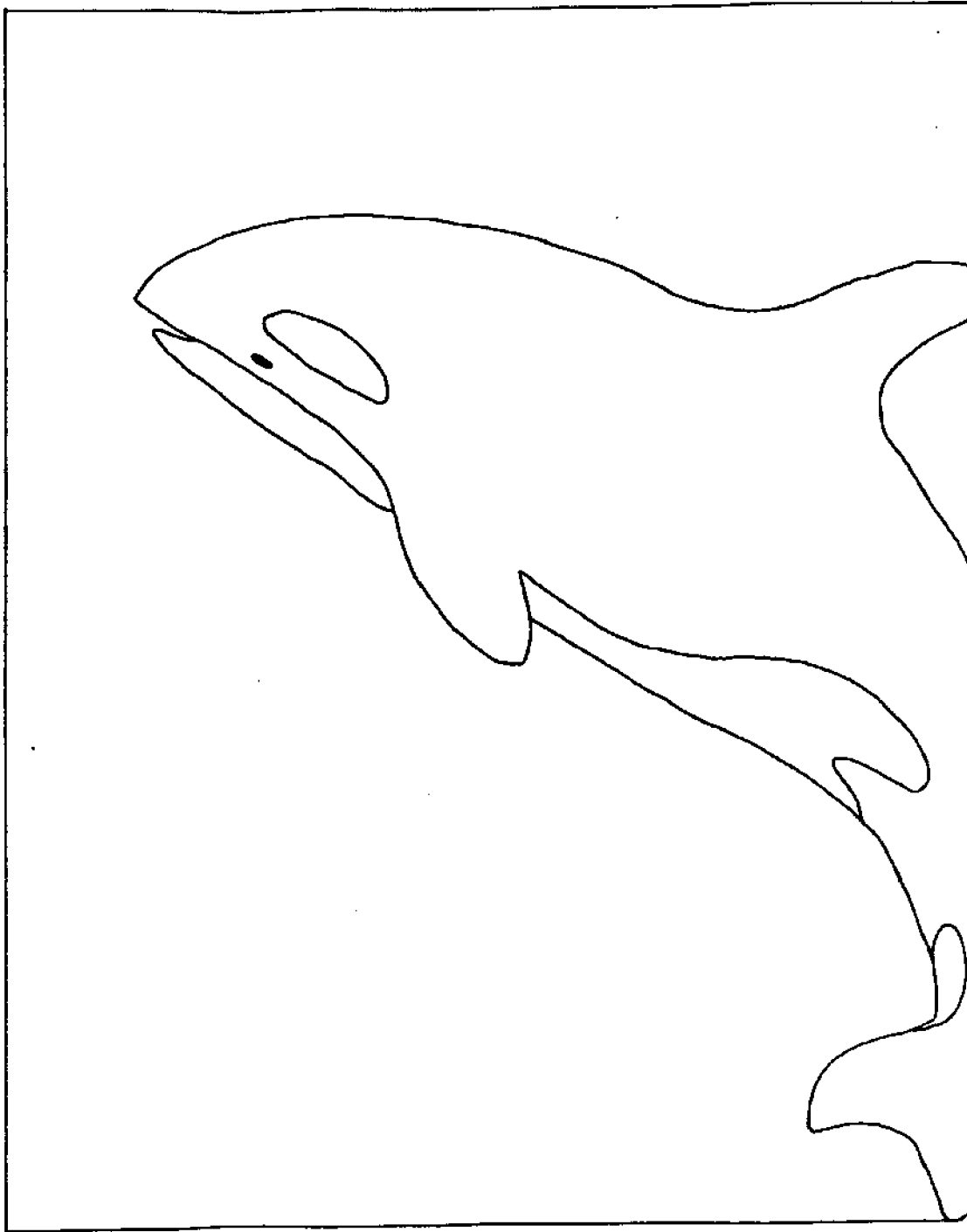

**ACTIVITY 4:**  
**COMMUNICATION**  
**(4 DAYS)**

## ACTIVITY 4: COMMUNICATION (4 DAYS)

- CONCEPTS:**
1. Communication takes place among living beings about many different types of things and using many different means.
  2. Cetaceans use their bodies as well as a variety of vocalizations to communicate.
  3. The sounds of the Humpback Whale are considered songs because they consist of patterns that repeat.

- OBJECTIVES:** The student will be able to:
1. identify several ways Cetaceans communicate.
  2. describe the various means of communication among Cetaceans and our lack of knowledge about it.

- TEACHER PREPARATION:**
1. Photocopy 2 or 3 copies of Teacher Information, "Communication Challenges" and cut into separate challenges.
  2. Read Teacher Information, "Sounds as Language"

- MATERIALS:** Class sets of:
1. "Say Rooo-beee!"
  2. "Communication Among Cetaceans"

"Humpback Whale Songs," record available in library, record shops, Pacific Science Center or from National Geographic, January, 1979.

- PROCEDURES:**
1. Play communication games. Split the class into teams of 4, each with their own corner or space to work in (5 or 6 would be all right, too). Explain that each student will be asked to communicate something to the other members of the team without using any words or sounds. If s/he wants, s/he may pick a partner to help. Pass out a slip of paper containing a communication challenge (from Teacher Information, "Communication Challenge") to each student, and let them begin. They may act things out, use sign language, dance, or do whatever they can think of that does not use any sort of vocalization. If they find a task that seems too hard and they can't think of a way to communicate it, they may trade it in for a different one. When it looks as if everyone has had a chance to communicate something, change the rule to allow noises or vocalizations as long as they are not speaking in English or another known language. Pass out more tasks and proceed as before.

Discuss. Which tasks were easy to communicate? Which were hard? Can the students put their communication tasks into categories? (e.g., bodily needs, emotions, facts, commands, abstractions) Can they think of any categories there were no examples of? What kinds of things might dolphins and whales need to communicate? Does the activity give them any insight into why languages were invented? What purpose does a language serve? What other means can be used to communicate?

2. Read Teacher Information, "Communication Among Cetaceans" and discuss various means of communication in Cetaceans with the class. Emphasize our lack of knowledge. Relate their ideas with those they came up with in previous discussions and use the student worksheets as a guide to bring out important points.
3. Pass out student worksheet, "Communication Among Cetaceans" to be done independently and discussed later.
4. Do the communication activities below as a class. Discuss how complex Cetacean's communications systems must be to use sounds on the ways activities demonstrate.

#### COMMUNICATION ACTIVITIES

##### Talk and Listen Like a Dolphin

Dolphins make fast, high pitched clicks that bounce off objects around them. They listen to the echoes in order to 'see' their surroundings. They can make clicks and listen to their echoes at the same time they hear clicks and sounds made by other dolphins without getting confused. Get a friend, and both of you think of a story to tell. Start talking at the same time, telling your stories to each other. Are you able to listen to your friend without stopping your own story?

##### Use Sound Like a Group of Whales

Get 6 or 8 classmates to form a pod of whales. Close your eyes and say "hello" softly, over and over. Try to listen to the other "hellos" and figure out whose voice is whose. Use the sounds as a way of telling where everyone is and try to move around together.

-Credit to Project Jonah for ideas.

5. Assignment - Have students read "Say Rooo-beee!." This reading is excerpted from Mind in the Water (ed., McIntyre), an anthology that celebrates Cetaceans as intelligent beings worthy of high respect. Keep in mind that not all scientists hold whales and dolphins in such high regard; many consider Cetaceans as animals no smarter than dogs but useful in research. What do the students think was happening in the reading between the man and the dolphin; was Ruby really trying to teach him something? Or did he just hear what he wanted to hear, as other researchers suggested?
6. Humpback Whale songs. Dr. Roger Payne has studied the habits of the Humpback Whales off Bermuda and has recorded their vocalizations which are available on two albums. No one knows why they sing so prodigiously; it may have to do with courtship or communication with other whales. Dr. Payne

calls the sounds 'songs', because they consist of a series of utterances and phrases which actually repeat themselves. They are definitely worth listening to. Try setting the following scene for your students. Play the record. As it ends fade the sounds out and have the children write a letter to a friend describing what was happening in the film. Later you may ask the class for their feelings from the sounds, and have them write a story or poem or draw a picture imagining they were a whale.

**EXTENDED  
ACTIVITIES:**

1. Read about attempts to teach chimpanzees a human language.
2. Study sign language or bring someone to class to teach some sign language. Signing is very symbolic, and it is often possible for an untrained person to pick up the meaning as the movements mimic the meaning. However, when dealing with abstractions, signers often resort to finger spelling.



COMMUNICATION CHALLENGES

Danger!

I'm hungry.

Here is food.

Fire!

Move.

Stop.

Here is shelter.

I'm angry.

I'm happy.

Help me!

Don't do that!

We'll meet a month from now.

Faroe Islanders have been hunting pilot whales for hundreds of years.

You chase them from behind, and I'll cut them off from the side.

In 1930, there were 250,000 Fin whales, in 1974 there were only 5,000.

It's a baby girl!

Would you like to dance?

Truth is beauty, and beauty is truth.

A rose by any other name would smell as sweet.



COMMUNICATION AMONG CETACEANS<sup>\*</sup>Sounds as Language

Cetaceans make other sounds besides sonar clicks. They make sounds with their bodies and with their voices. All of these sounds seem to communicate something to other Cetaceans, although different species vary greatly in loquacity. Gray Whales seem to be very silent, while the Beluga is known as the "sea canary." The Amazon River dolphin clicks a lot, but has not been heard to say much else. The male Humpback Whale will sing during the mating season for seven to thirty minutes and then repeat the whole song for several hours. Most dolphins speak in short phrases. Some speak simultaneously with two voices: the echolocation clicks and whatever "social" vocabulary is appropriate.

The body also speaks. Many Cetaceans make a sound by clapping their jaws. Dolphin trainers believe this is a threat or warning. In a quiet mood, dolphins will release one big bubble underwater. The gurgle-pop of the bubble is believed to be a question - "What's that? Can I share or partake in that?" The bubble is somewhere between curiosity and a request. When a dolphin gets excited, its breathing quickens and each exhalation forms a distinct "chuff!" - an exuberant high-energy sound.

A whale can use his or her tail to produce a variety of subtle sounds. Flukes are wiggled on the surface in anxiety or annoyance. When there is danger, the flukes are slapped against the surface, producing a very loud crack (lobtailing). This crack can be heard for miles in the ocean and will cause other Cetaceans in the area to dive directly down. A whale or a dolphin may also breach - jump part or all the way out of the water and then belly-whop or sidesmack the surface. Sometimes breaching is for danger or a warning; sometimes it may serve to knock lice off, other times it seems to be for fun.

The vocal sounds of whales have been categorized into two broad types: pulsed sounds and pure tones. Pulsed sounds include: 1) sonar or echolocation sounds; 2) faster clicks used for social communication; and 3) more repetitive, less well-modulated sounds which are thought to be "self-expressive." To humans, the faster clicks used for some types of social communication sound like creaking doors and rusty hinges. The loosely modulated sounds have been described as squeaks and squawks and barks and grunts. To describe these latter sounds as "self-expressive" means that we can't figure out what the toothed whales are saying to each other.

The pure tones sound to us like clear whistles. They are beautiful bird-like sounds with trills and arpeggios, glissandos and sitar-like bends in the notes. Each whistle is particular to the species that makes it. A bottlenose dolphin will always recognize another bottlenose dolphin. More important, each whistle

<sup>\*</sup> Excerpted from Warshall, Peter "The Ways of Whales" in Mind in the Water, ed. McIntyre. Reprinted by permission of Charles Scribner's sons, N.Y.

### Teacher Information

whistles to Dolly, the bottlenose dolphin, each knows exactly who is whistling. Even more surprising, it seems that the Cetacean community is so integrated that an individual of one species can recognize (and communicate to) an individual of another species. Thus, Moby Dick the Sperm Whale can cross-species communicate with Ems the Orca.

Dolphins are born with their own personal whistle. The whistle is a little raggedy at birth, but becomes clear and clean quickly. The female bottlenose dolphin seems to turn her whistle into a song as she matures, repeating the whistle over and over again.

Whenever the whistle is given, it is answered by a nearby Cetacean. The whistle seems to provide a great deal of information: the location of the whistler, the identity of friends, the whereabouts of companions, and the desire to hear a response. Choruses of whistles may be a way to confirm and reconfirm the mood, state of being, or purpose of the group. For instance, whistling occurs more often when dolphins are hungry and might be expected to start a coordinated hunt. Orcas often vocalize intensely just before setting out to hunt, and then keep in contact with clicks and whistles while herding fish or hunting cooperatively.

Cetaceans can vary their pulsed sounds and whistles. There are endless combinations of changing loudness, timing of bursts or groups of bursts, tone and groups of tones, as well as silences. Until we leave the confinement of oceanaria and enter the oceans where the Cetacean voice evolved, the meaning of Cetacean language will evade us.

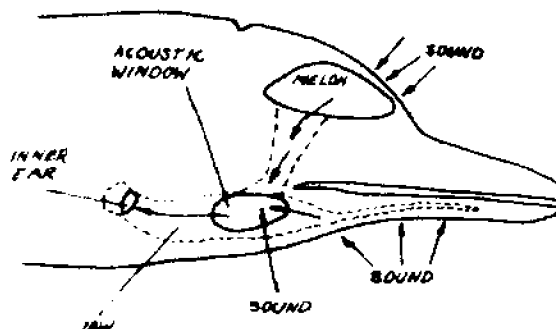

This illustration shows the two different sound receivers that have been discovered in the porpoise. The first is in the jaw; sound entering the jaw travels through a thin oil inside the jawbone to the ear drum. The second sound receiver is in the forehead region, or melon. This organ is filled with an oil through which sound can be conducted to the ear drums. The "ears" as we know them in other mammals, do not receive sound waves because of the problem of hearing underwater.

## Say "Roo-Beee!"

It occurred to me that I could use this game of catch as a reward in an attempt to get Ruby to vocalize. It seemed like an ideal reward; we were both enjoying the game, and her participation was voluntary. I decided to try to get her to mimic her own name.

"Ruby," I said. "Say, Rooo-beee!"

All I got back at first was a bunch of dolphinese, somewhere between a whistle and a squawk. I threw the ball, and she returned it.

"All right, now, say 'Ruby!' Rooo-beee!"

. . . I noticed that she was repeating the same sound every time; it wasn't just any old squawk, but one with recognizable characteristics. . .

Suddenly her vocalization changed. Her squawk came out in two distinct syllables, rather like the way I had been syllabifying "Rooo-bee!" I hurled the ball, and she returned it. Our progress became unbelievably rapid. In the space of five minutes, she began to copy the syllabification, rhythm, time, and inflections of my pronunciation of the word "Ruby" and she did so with an accuracy and a speed I found amazing. . . We became completely wrapped up in each other, the outside world ceased to exist. . . Never in my life have I known such an intimate feeling of being in contact with an incredible non-human creature. It felt like it was what I had been created to do. Our minds seemed to be running on the same wave-length. We were together.

She repeated the word with accuracy a couple of times, then started babbling at me in dolphinese, shaking her head up and down with her jaws open in that gesture, usually associated with pleasure, that I called "ya-ya-ing." I tried to get her to say "Rooo-beee!" again; more ya-ya-ing. Then she swam back a few feet and made a peculiar noise, a kind of "kee-orr-ooop," but about three times faster than you pronounce it. It occurred to me - I don't know why - to repeat that sound. Ruby seemed to be expecting it of me. I did the best I could with it. She repeated it, but now it sounded slightly different; I mimicked her changes. Gosh, she's doing to me what I was just doing to her! Where will this lead? By now the ball was forgotten; I was totally absorbed in listening to Ruby's vocalizations and attempting to mimic them as accurately as possible with my inadequate human lips and vocal chords. She repeated the sound again, changed still more, and I copied that, she repeated it again, and as I tried to mimic her I thought, this sounds vaguely familiar - "kee-orr-opp." The light in my head went on. The sound I had just successfully imitated was the one she had been giving to me in the beginning, in response to my first attempt to make her say "Ruby!"

This realization struck me as the sound was coming out of my lips. Several fuses in my mind blew simultaneously and I did an incredible double-take, nearly falling over, and staring at Ruby, who was watching me with great concentration. When she saw the double-take, and knew I knew, she flipped out, and went ya-ya-ing around the pool, throwing water into the air, and apparently happy that this two-legged cousin of hers was progressing so rapidly.

NAME \_\_\_\_\_

What do I think the meaning of that experience was? I don't really know. I have some ideas, however. In response to an English word, Ruby had given me a dolphinese word or phrase, which I had ignored. She succeeded in taking control of the situation - although I had been willing to relinquish control - and had then tricked me into producing the sound I had at first ignored! I had been the one slowing down the communication between us! But what was the meaning of that sound? I can only guess. Certainly Ruby was sophisticated enough to recognize her human name. It occurred to me that she was most likely either telling me her name for me or telling me her name for herself.

Years later, I told a couple of "straight" dolphin researchers about the experience. (By "straight" I mean they regard the possibility of a high dolphin intelligence as undemonstrated, and therefore not worth investigating).

"It's too bad you didn't have a tape recorder with you," they told me. "So often one hears what one wants to hear." Some outside impartial reference source is necessary to evaluate experiences like this in a truly scientific context. One's own subjective sensory impressions are, alas, so often subject to distortion.

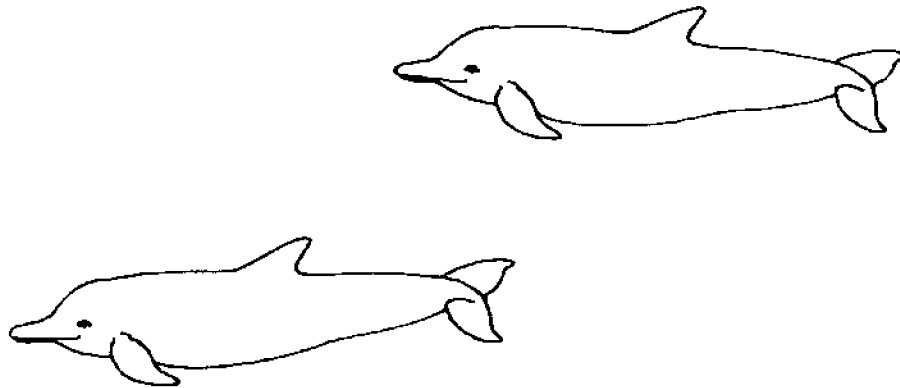

Copyright. Reprinted by permission of Charles Scribner's Sons, N.Y. Brenner, Malcolm, "Say RooBeee" in Mind in the Waters, ed. Joan McIntyre.

## COMMUNICATIONS AMONG CETACEANS

1. Here are five statements. Match them to the type of communication you think each is.

<u>STATEMENTS</u>	<u>TYPE OF COMMUNICATION</u>
<u>B</u> I'm thirsty.	A. Emotion
<u>C</u> Come here.	B. Bodily Need
<u>D</u> Life is just a bowl of cherries.	C. Command
<u>E</u> There are four sheep here.	D. Abstraction
<u>A</u> I'm sad.	E. Fact

2. What would your interpretation as a biologist be if you heard:

- A. Two bottlenosed dolphins whistle to each other, each with a distinct whistle?

(They are probably identifying themselves to each other, and signaling their locations.)

- B. A minke whale lobsailing slapping its flukes against the water with a loud smack?

(warning others of danger.)

- C. High frequency clicks (if you could hear high pitches like a dog can) in an area where there were porpoises?

(The animals are probably echolocating.)

- D. A group of Orcas vocalizing a great deal, and then occasional whistles and clicks?

(preparing to hunt cooperatively and then keeping in contact.)

- E. A 10 minute pattern of singing underwater -grunts, squeaks, moans, etc. - which was then repeated in sequence?

(a male Humpback, probably during mating season.)

## COMMUNICATIONS AMONG CETACEANS

1. Here are five statements. Match them to the type of communication you think each is.

STATEMENTSTYPE OF COMMUNICATION

- |                                      |                |
|--------------------------------------|----------------|
| ___ I'm thirsty.                     | A. Emotion     |
| ___ Come here.                       | B. Bodily Need |
| ___ Life is just a bowl of cherries. | C. Command     |
| ___ There are four sheep here.       | D. Abstraction |
| ___ I'm sad.                         | E. Fact        |

2. What would your interpretation as a biologist be if you heard:

- A. Two bottlenosed dolphins whistle to each other, each with a distinct whistle?
- B. A minke whale lobsailing, slapping its flukes against the water with a loud smack?
- C. High frequency clicks (if you could hear high pitches like a dog can) in an area where there were porpoises?
- D. A group of Orcas vocalizing a great deal, and then occasional whistles and clicks?
- E. A 10 minute pattern of singing underwater -grunts, squeaks, moans, etc. - which was then repeated in sequence?



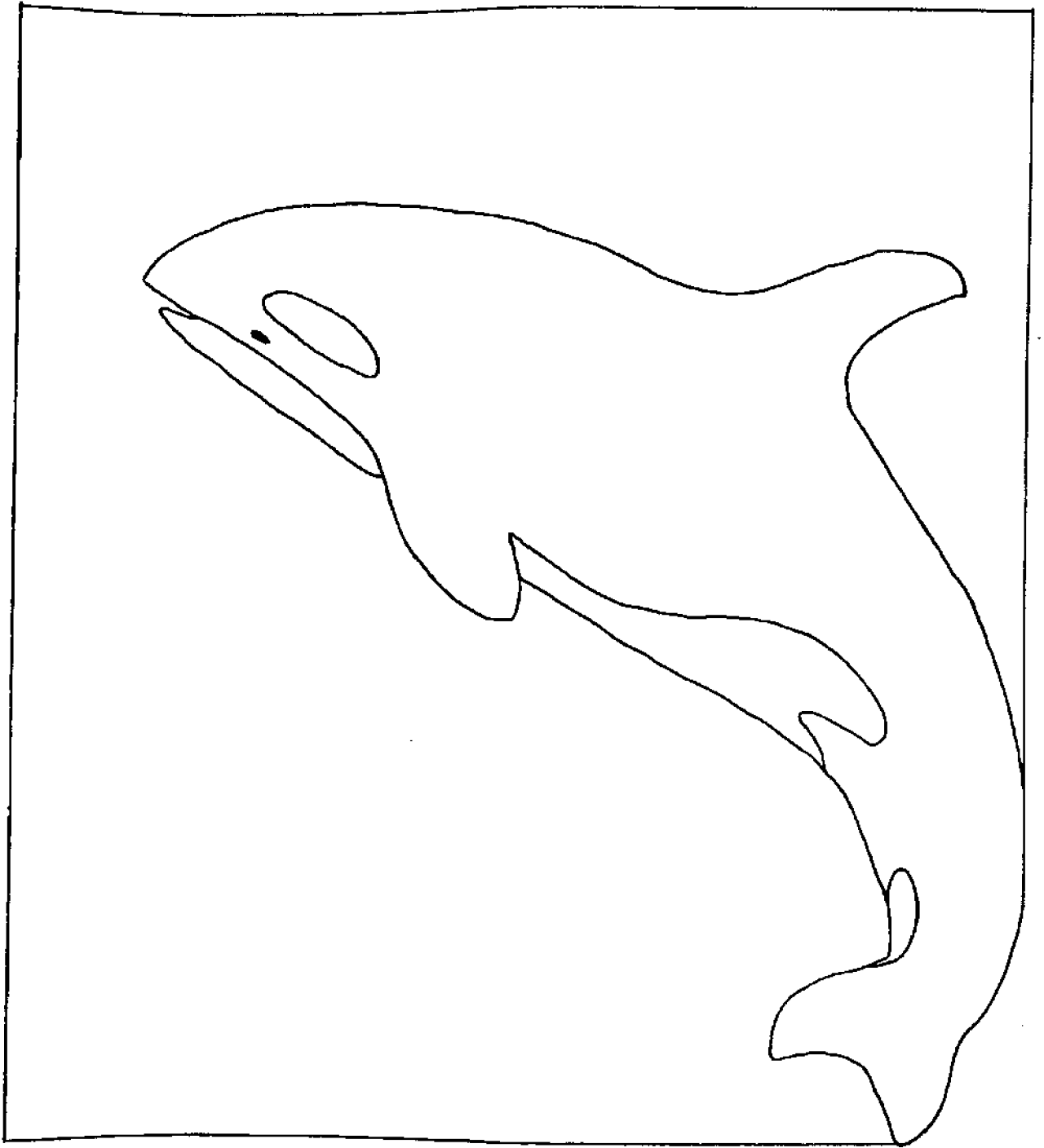

**ACTIVITY 5:**  
**BEANS AND BALEENS**  
**(5 DAYS)**

## ACTIVITY 5: BEANS AND BALEENS (5 DAYS)

- CONCEPTS:**
1. Whale populations are hard to count.
  2. The International Whaling Commission (IWC) is the only world-wide organization with any responsibility for controlling the whaling industry.
  3. Estimates of whale populations are based on sightings and on the number caught compared to the effort involved and can be inaccurate.
  4. Some whale research projects, such as ORCA survey, are based on identifying individual whales and pods and watching their behavior over long periods of time.
  5. The Humpback Whale has been protected since 1966, but threats to its existence still remain.

- OBJECTIVES:** The student will be able to:
1. state one of the problems in estimating whale populations.
  2. explain how the effort expended to capture an individual changes as a population grows or declines.
  3. explain how birth and death rates affect population sizes.
  4. tell what information can be gained from projects such as Orca Survey.
  5. explain a problem facing Humpback Whale populations and offer a possible solution.

### TEACHER

- PREPARATION:**
1. Assemble counting box from a box, acetate and tape.

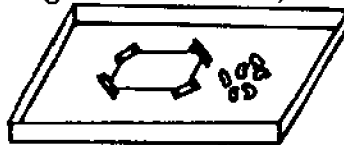

2. Read Teacher Information Sheet "Beans and Baleens" and student handout, "Humpback Whale Case Study."

- MATERIALS:**
1. 2 one-quart jars of beans (kidney or pinto bean size will do)
  2. counting box - cardboard box (or lid) about 12"x14"x2"
  3. acetate for window of counting box about 3"x5"
  4. tape
  5. overhead projector
  6. blindfold
  7. Orca Survey cards (obtainable from Pacific Science Center or Orca Survey)
  8. Class sets of student handout, "Humpback Whale Case Study" and student worksheet, "Beans and Baleens."

- PROCEDURES:**
1. How would you count a whale population? Ask students this question first. Then use beans to represent an unknown whale population. Put some number of beans in the 'counting' box (with acetate window) and place it on an overhead projector. Shake the box around vigorously so that the beans move before students have time to count those that appear in the window. On the basis of the beans they can see, can the students estimate the total number? Take their guesses and ask what



they are based on. Now try a different number of beans, either a great deal more or less, and repeat the estimations.

Ask the student to describe the difficulties in counting beans. Based on this exercise, what do your students think are some of the problems in trying to count whale populations? [The whales move around, you can't tell if you've counted them before or not, they live in areas that we can't always watch, etc.]

2. Read Teacher Information, "Beans and Baleens." Talk about the International Whaling Commission (IWC), its make-up and (lack of) power, and what statistics whaling quotas are based on. To demonstrate how a population estimate can be based on the energy expended to capture individuals, bring out the counting box again. This time have a blindfolded student 'hunting' for beans (i.e., picking beans out of the box one by one). They can be put into a jar once they are caught. What happens to the number of attempts to catch a bean as more beans have been caught? Now "improve" the hunting technique: remove the blindfold (whaler's hunting techniques were greatly improved by the invention of the explosive harpoon, and motorized catcher boats). Compare the energy needed to hunt now. (See extended activity #1 to get into the concept of Diminishing Returns more deeply.)
3. Use beans, once again, to get across the effect of birth and death rates on population growth. Place two one-quart jars at the front of the classroom and divide the students into two groups. Students in one group will each add two beans to their jar and students in the other group will add three beans at a time to their jar, to represent 2 different birth rates. Compare how fast the jars fill up.

Death rate. Students stay divided but now the three bean group represents the death rate. Start with a jar filled with beans; each time 2 beans are added by a student in one group, a student in the second group takes three beans away. What eventually happens? [none will be left] This is obviously a very simplistic model of the great whale situation, but it appears that whales are not increasing their birth rate to balance the death rate. Whalers are spending more time and energy to catch each whale than ever before. Point out that decreasing population density can have a serious effect on the birth rate.

4. Know your Whales. Many whales have distinctive characteristics that vary from one individual to another. For example, size and markings on the dorsal fins of Orcas, encrustations and markings on gray whales, make individuals identifiable. This is useful to biologists attempting to study them.

Groups of whales frequenting a given area can be identified and watched closely from year to year. Additions and absences of individuals can be noted to gain information about their life history and social behavior. Have your students play this game to demonstrate whale survey techniques:

Designate half the class whale-watchers and the other half a 'pod' (group) of Orcas. (The students should recognize one another and know each other's name. It might be fun, however, to use this activity in the first week of school to help get acquainted with one another.) The whales leave the classroom, and outside, decide among themselves how many and who (not all of them) will re-enter the classroom on the first visit of the pod. Those chosen then go in as a group, mill around for 30 seconds and leave again. The whale watchers now discuss what information they were able to gather: how many were in the pod, and who. If the whale-watchers do not agree, the need for recording the data should be brought out. At least one of the whale-watchers, or all of them, should write down who they see. Meanwhile, the Orcas outside the classroom should make a change or two in their pod; they may lose one or more members, or bring in a new one. Repeat the 30 second visit. After a few visits, it might be a good idea for the 2 groups to switch.

Discussion - What problems did the whale watchers have? [Unless you know the individual, it's hard to be sure whether you have counted him or her before; sometimes they move so fast you can't identify and count them all; you need to write down what you see in order to know how the population has changed since the previous visit.]

What kind of information could be gained from this type of study? [birth and death rates; maternal behavior, social behavior - who hangs out with whom; knowledge of feeding habitats and movements.]

5. Pass out Orca Survey cards and explain that researchers have been keeping close tabs on Orca populations in Puget Sound waters for several years. The pictures show several of the individuals that are more frequently seen. If your students live in the Puget Sound area, they can help whale researchers by reporting any sightings to the Whale Hotline number that is given. Discuss some of the things Orca Survey has learned about local whale populations.
6. Have students read "Humpback Whale Case Study." Discuss the present problem facing Humpback Whalers. What ideas do they have about resolving the fishing gear problem? [One suggestion might be to reimburse fishermen for whale damage, since

it is unfair to them to shoulder the financial burden. Another suggestion is to figure out how to keep the whales from getting caught in the gear. If humpbacks echolocate (we are not sure) there may be a way of warning the whales away acoustically, as long as food fish are not driven away.]

What about the whale-watcher problems? [Whale-watching has important educational value, but some suggest that boat-whale interactions be kept to a minimum by some sort of regulations such as hydrofoils routed through different areas. Possible disruption of mating and nursing activities would thus be avoided. It has been proposed that a national park or wildlife refuge be established to protect the Hawaiian Humpbacks.]

7. Pass out student worksheet, "Beans and Baleens." This is intended as a form of evaluation, but the questions are difficult thought questions, which will require class discussion after the students have completed the worksheets individually.

**EXTENDED  
ACTIVITIES:**

1. The Law of Diminishing Returns states that as a resource is used up, it takes more time and energy per unit to utilize what remains. There comes a point when, because of the scarcity of the resource, it is no longer profitable (in terms of capital or energy) to exploit it. This has happened with many of the great whales, those termed commercially extinct. ORCA's junior high school unit, Energy from the Sea, contains some excellent activities about the law of diminishing return which may be adapted for elementary students' study of whales.
2. Study dynamics of population growth in more detail. Teaching Population Concepts has many ideas for activities.
3. Research population statistics on other whales besides the Humpbacks.



## BEANS AND BALEENS

The International Whaling Commission (IWC) is the only worldwide organization with any responsibility for controlling the whaling industry. Membership is voluntary and numbers 17 countries, including Japan and Russia\*, both of whom still hunt the great whales. Partly because the presence of these two nations forces compromises, critics argue that the IWC represents more of a vested interest in the whaling industry rather than in conservation of the whales. There are also many countries that allow whaling who are not members of the IWC, as well as 'pirate' whalers who will indiscriminately take any type of whale in any region. Moreover, the IWC has no power of enforcement, and members can choose not to comply with decisions made at meetings.

The Scientific Committee of the IWC make estimates of whale populations and sets harvest quotas based on these estimates. The theory is that a population can replenish itself if not too many of its numbers are taken. The Maximum Sustainable Yield (MSY) is the highest number of animals which can be taken from a population and still allow the remaining population to make up the deficiency. Calculating the MSY however, requires a knowledge of the original population size. Present whale populations are difficult enough to estimate, and estimates of the original populations of the great whales are not much more than educated guesses. These guesses are made on the basis of sightings by whalers (a statistic suspect in itself) and by comparing the number of whales caught to the effort involved. Thus, MSY based quotas can be quite inaccurate.

Conservationists have many other criticisms of the statistical assessments of the IWC. (For more information, see Coffey, or The Whale Manual). One is that the MSY estimate is a technique used to regulate the fishing industry, but may not be useful to control whaling. Fish have a much higher reproductive rate and can more easily replace their numbers than whales. There is also evidence that social disruption (such as killing members of a group) may reduce the reproductive ability of whales, and that below a certain population density, whales may never be able to reproduce enough to recover their losses.

At the present time the IWC bans the hunting of Sperm Whales, Blue Whales, Southern Right Whales, Gray Whales, Bowheads and Humpbacks. Species that the IWC places quotas on are Minke Whales, Fin Whales, Sei and Bryde's Whale. A 10 year moratorium on all whaling has been suggested to allow populations to recover, but it remains to be seen if Russia and Japan will agree to such a ban, before the remaining great whales become so scarce as to be commercially unexploitable.

\* The U.S.S.R. (in 1981) has publicly stated it would comply with its 1976 plan to stop its commercial whaling endeavors.

## HUMPBAC WHALE CASE STUDY

The Humpback Whale (*Megaptera novaeangliae*) used to be an important part of the whaling industry. In the early part of this century many Humpbacks were taken by the shore stations in the North Atlantic. By 1916 there were only a few dozen animals left. Harvesting stopped until the 1940's when their numbers had recovered enough to make hunting profitable again. The population was drastically reduced again, and finally in 1966, the Humpback Whale was given complete protection by the International Whaling Commission. No one knows for sure how many Humpbacks there were originally, but scientists think the number in the North Pacific Ocean has remained at about 1,200 since 1966. There are probably about 2,000 in the North Atlantic, and populations may be increasing slightly. Humpbacks in the southern oceans number about 3,000; there may have been as many as 100,000 at one time.

Although the Humpback is no longer hunted, there are new threats to its existence. The number of Humpback Whale sightings has gone up the past few years in the Newfoundland area; during this same time, report of whale-caused damage to fishing gear has also gone up. The whales get accidentally entangled in the trap-lines. They are not attempting to get the fish or bait in the trap, they just don't seem to be able to sense the lines. Damage to the traps is costly and fishermen lose many fish while they are repairing whale-damaged traps. The result is that fishermen end up paying the cost of a conservation policy (the ban on the Humpbacks). Some have concluded that since more Humpbacks are seen close to shore, the population has risen and whaling should be allowed. It may be, however, that Humpbacks are feeding closer to shore than before because of overfishing of their favorite food-fish, capelin, by humans. This could also be because cod fishing has become more popular and there is more fishing gear (traps and nets) in the water than ever before.

Another threat to the Humpback may be coming from whale-lovers. A recent article about Humpbacks in their breeding ground near the island of Maui discusses the growing interest in whale watching.\* Charter boats are running whale-watching trips, and many pleasure boaters are cruising the whales' breeding grounds to get as close as possible to the animals. Not only are cows and calves being frightened away from their traditional places, but courting whales are often interrupted by boaters. This could affect Humpback birth rates. In California there have already been collisions between Grey Whales and hydrofoils. That is bound to happen off Maui too. A scientist reported that a Humpback stopped singing when a hydrofoil came near. We still do not even know why humpbacks sing; how can we know what might the effect of hydrofoil or other boat noise be on their lives?



\* Hudnall, James "In the Company of Great Whales," Audubon, 79:3, May, 1977.

## Teacher Information (Key)

## BEANS AND BALEENS

1. Imagine you are a scientist with the International Whaling Commission (IWC). This year the IWC is debating the quota for numbers of Minke whales to be captured, or whether to completely ban hunting them. You are to provide the information needed to make the decision. What information do you need, and how do you get it?

[You may need estimates of the original population size, from old whaling records and sightings. Then, comparing the number of whales caught to the effort involved (data obtainable from whalers) gives you a gauge of how the population has decreased. You can now estimate present population size and from this estimate the maximum sustainable yield (MSY), the numbers of Minke's that can be taken without further reducing the population. You will also need knowledge of their birth and death rates to determine how fast they reproduce and increase their population. This information may or may not be available from biologists.]

2. You are a biologist proposing a long term study of Gray Whales that migrate between Baja and the Arctic. The study is to resemble Orca Survey in that you will attempt to identify and keep track of individuals and pods from year to year. In order to get money for the study, you must convince the National Science Foundation that there is much useful information to be gained. What do you tell them?

[Birth and death rates, changes in the population from year to year and during migrations, information about life history, social behavior, maternal and breeding behavior, knowledge of communication in Gray Whales.]

3. What is one of the problems facing Humpback Whales and what is a possible solution?

[Whales getting entangled and causing damage to fishing gear: solutions might be to reimburse fisherpeople for damage, figure out some way to keep the whales from getting caught.

Pressure of whale watchers - regulating such activity where whales are congregating or breeding, perhaps by setting up wildlife refuge areas.]

NAME \_\_\_\_\_

## BEANS AND BALEENS

1. Imagine you are a scientist with the International Whaling Commission (IWC). This year the IWC is debating the quota for numbers of Minke whales to be captured, or whether to completely ban hunting them. You are to provide the information needed to make the decision. What information do you need, and how do you get it?
  
2. You are a biologist proposing a long term study of Gray Whales that migrate between Baja and the Arctic. The study is to resemble Orca Survey in that you will attempt to identify and keep track of individuals and pods from year to year. In order to get money for the study, you must convince the National Science Foundation that there is much useful information to be gained. What do you tell them?
  
3. What is one of the problems facing Humpback Whales and what is a possible solution?



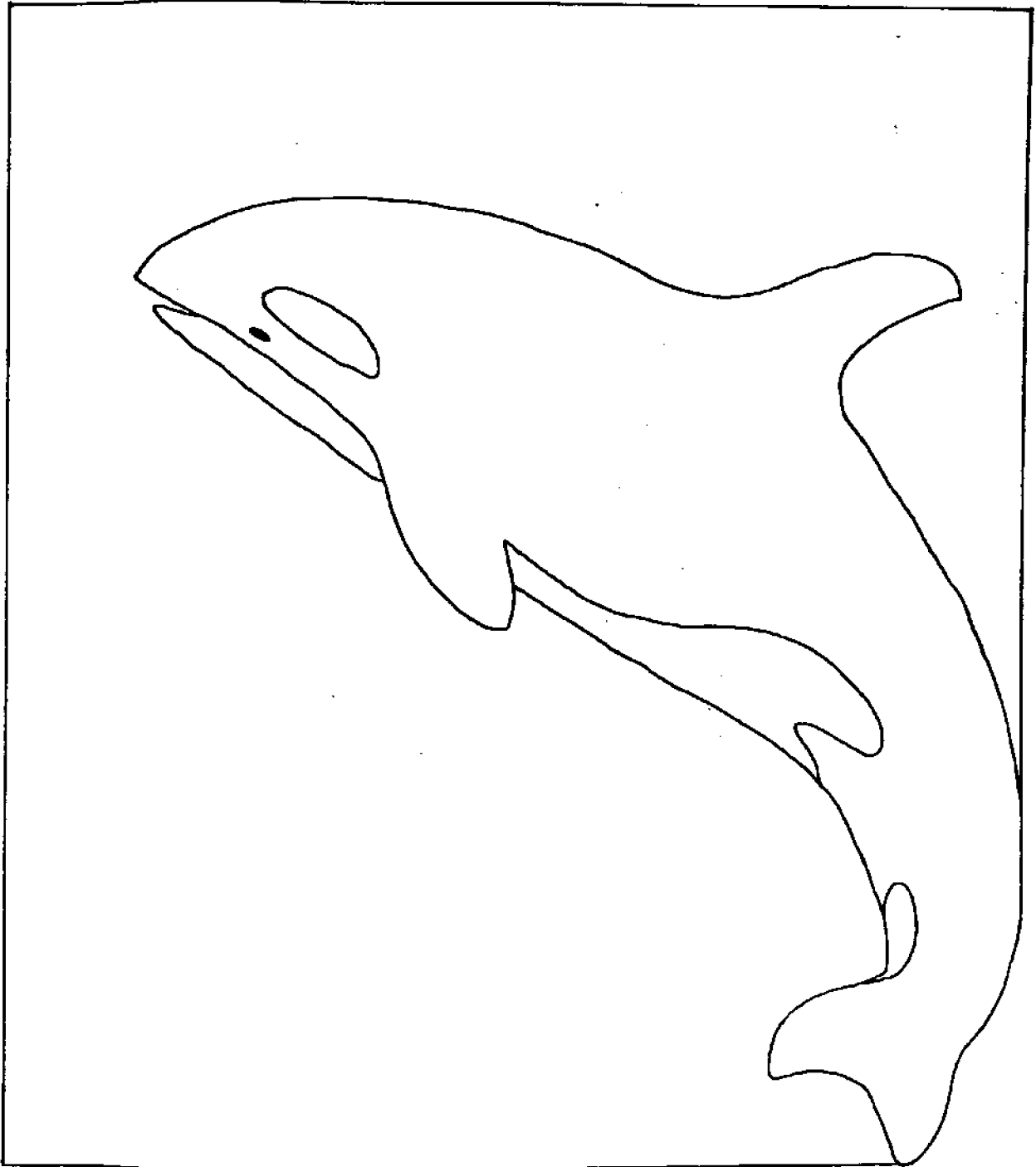

**ACTIVITY 6:**

**BATTLE OVER THE BOWHEAD  
(3-4 DAYS)**



## ACTIVITY 6: BATTLE OVER THE BOWHEAD (3-4 DAYS)

- CONCEPTS**
1. The Bowhead Whale is an endangered species and is now limited to a small population in the Bering Sea.
  2. The controversy over limiting Eskimo subsistence hunting of the Bowhead is a complex one, involving issues of conservation, impact of oil and gas development, international politics, the rights of a minority people, and the impact of technology on Eskimo hunting methods.

- OBJECTIVES:** The student will be able to:
1. discuss several of the issues involved in the Bowhead controversy.
  2. participate in a television news special about the Bowhead.

### TEACHER

**PREPARATION:** Read Teacher Information, "The Whales Return", and consult the bibliographic listings if you want more information.

**MATERIALS:** Class set of "The Battle Over the Bowhead."\*

- PROCEDURES:**
1. Hand out script to "The Battle Over the Bowhead." Explain that the students will be producing a television special. Select members of the class for each part, and let each one choose a team of "advisors." Each part represents a different point of view, but there are many other arguments besides those presented here. Perhaps they can add their own as they go along.

\* This activity is included courtesy of Alaska Tidelines.

### EXTENDED

- ACTIVITIES:**
1. If you can get the equipment, have the class videotape the television special. Some members of the class can act as the camera crew.



### THE WHALES RETURN<sup>\*</sup>

This spring, the great Bowhead Whales will begin to make their way up through the Bering Strait to their summer feeding and calving waters in the Arctic Ocean and the Beaufort (BOW-fert) Sea. And the Eskimos will be waiting, just as they have for thousands of years.

Those things have not changed. What has changed is that the outside world seems to be closing in around that icy coast, once shared only by the Eskimo people and the marine mammals upon which they lived.

Long ago other native people hunted many kinds of whales that sounded and blew in Alaska waters. With poisoned spearheads and magic charms, the Aleuts matched their fragile one-man skinboats against the awesome size of the Gray, Fin, Sperm and Bowhead Whales. There were also scattered coastal whaling cultures from Yakutat to Cook Inlets from Kodiak into the Bering Sea.

In the late 1800's and early 1900's, commercial whalers from New England and abroad nearly wiped the great whales from the oceans of the earth. As a result, an international treaty was drawn up to try to save the whales that remained.

Among the endangered species is the giant Bowhead. Ballena mysticetus (ba-LEEN-uh miss-ti-SEE-tus). Once thousands ranged through all the northern seas. But today, except for isolated groups in northern Canada and eastern Siberia, the only Bowheads left are believed to be those who follow the retreating Bering Sea pack ice on their spring migration into the Arctic Ocean. And only the northern Eskimos, the last of Alaska's whaling cultures, continue the traditional hunt.

Now it appears that their lifestyle also is endangered. In 1977, for the first time in history, the International Whaling Commission extended its control to cover subsistence hunting. And suddenly, through no fault of either of them, both the Bowhead Whales and the age-old culture of the Eskimos seemed to be caught in the crunch.

Can both survive? How? What other values are involved? See what you think after you take part in the following Tidelines TV News special, "Battle Over the Bowhead."

<sup>\*</sup> Reprinted by permission of Alaska Sea Grant Publication, ALASKA Tidelines

A Tidelines TV News Special<sup>1</sup>  
BATTLE OVER THE BOWHEAD

This is an imaginary TV news special. The people in it are imaginary, too. But the battle over the Bowhead is very real. The events described here actually happened. And these arguments have been heard in one form or another at such widely varied places as international meetings in London or Tokyo or over a steaming cup of tea in a tent pitched on the ice at a whaling camp.

Read the script through. Then select members of your class for each part, and let each one choose a team of "advisors." Each part represents a different point of view, but there are many other arguments besides those presented here. Perhaps you and your advisors can add some of your own as you go along.

Cast of Characters

MODERATOR

JOHN, Eskimo whaling captain

KEN, U.S. delegate to the International Whaling Commission (IWC)

ALICE, member of the "Save the Whales" organization, Alaska chapter.

EMILY, Alaska state legislator

STEVE, member of the IWC Scientific Committee.

MIKE, biologist with the National Marine Fisheries Service (NMFS)

MARGARET, spokesperson for the oil and gas industry

MODERATOR: Good evening, ladies and gentlemen. The so-called "Battle Over the Bowhead" is not about whether or not the whales should be saved. We all agree that they must survive. And the Eskimos, whose traditions are built around the Bowhead, know better than anyone else how empty our northern waters would be without them.

Nor is the battle a simple two-sided question of Eskimo subsistence against Bowhead protection. It is far more complicated than that. There are many issues involved, including conservation, international politics, the impact of oil and gas development in the Arctic, the energy needs of the world, environmental protection, civil rights of minority people and, last but not least, survival of the great whales, among the most beautiful, fascinating, mysterious creatures ever to live on earth.

Some of these interests are represented on our panel here tonight. Let's start with you, John. We know it took some pretty heavy bargaining to get the International Whaling Commission to lift its ban against Eskimo subsistence hunting and allow you a quota of 12 whales. You agreed to that quota - but under protest. That was last year. What's going to happen this spring?

<sup>1</sup> Used by permission of Alaska Tidelines, a University of Alaska Sea Grant Publication

JOHN: We will be hunting - but under our own rules this time. We do not think the International Whaling Commission has any right to limit the number of whales we can take for food. We went along with the quota last year because we were told that if we cooperated, the quota might be lifted. Well, we did cooperate. But the quotas for this year's hunt are almost as bad as last year's. So this spring we will do it our way.

MODERATOR: Does that mean uncontrolled hunting?

JOHN: No, no! The Bowhead whaling will be managed this year by our own Alaska Eskimo Whaling Commission. We will set and enforce limits that will not endanger the whales, but will meet the needs of our people. Let the IWC regulate the commercial whalers. We will regulate ourselves.

MODERATOR: Ken, perhaps you should tell us just what the IWC is and what it does.

KEN: The International Whaling Commission was formed in 1946 to conserve the whales by bringing commercial whaling under control. Since then, the worldwide whale kill has been cut almost in half and no more whales have been added to the endangered species list.

The IWC sets quotas on whale populations considered large enough to harvest,<sup>2</sup> and protects those species that are threatened. Most of its 16 member countries<sup>2</sup> were whaling nations when they joined, but now only a few continue to hunt commercially.

ALICE: Yes, but two of those IWC nations - Japan and the Soviet Union - are the largest commercial whalers left. They account for about 85 percent of the whales killed each year. As you know, our "Save the Whales" group is totally against commercial whaling. And it seems to us that the IWC is dealing more in politics than in protection.

KEN: It's a very touchy problem. You see, none of these nations had to join the IWC. We can't force any nation to sign the treaty. But once they are in, they listen to the advice of our IWC Scientific Committee and they are expected to abide by the IWC rulings. That means staying within the quotas for whales not endangered, and staying away from those species that are.

Another problem is that there are still five whaling nations<sup>3</sup> that have not signed the treaty. Those nations take about 10 percent of the total catch, including many whales from endangered populations. So we think it is extremely important to get these nations into the IWC.

MODERATOR: What is the United States' official position on whaling?

KEN: The United States wants to end all commercial whaling.

<sup>2</sup>Australia, Argentina, Brazil, Canada, Denmark, France, Iceland, Japan, Mexico, The Netherlands, New Zealand, Norway, South Africa, United Kingdom, U.S.S.R. and U.S.

<sup>3</sup>Chile, Peru, Portugal, South Korea, Spain.

MODERATOR: What about subsistence hunting?

KEN: The government feels subsistence hunting should be allowed to continue. That's the position it took under the Marine Mammal Protection Act of 1972 which provides for subsistence rights.

The IWC's move to limit Eskimo whaling put the U.S. in a very difficult position. On one hand, the government wants to protect the rights of minority people. On the other hand, we were afraid that if the quotas were not followed, other nations would ignore the IWC rulings.

EMILY: I remember how surprised we were in the Alaska State Legislature when the IWC extended the treaty to include subsistence hunting. Why the sudden decision?

STEVE: As a member of the IWC Scientific Committee, perhaps I should answer that. And I can assure you, it wasn't a sudden decision.

In the first place, scientists probably know less about the Bowhead than any other species. It's just a guess, but we think there were around 16,000 in the western arctic before the commercial hunters first came in 1848. A study of old logbooks shows that between 19,000 and 21,000 Bowheads were killed before commercial whaling ended 60 years ago. And since 1931, only subsistence hunting by Natives has been permitted.

The problem was that in recent years the Eskimo hunters have been taking more and more. We warned the United States about this, but little was done. Finally in 1976, when 48 bowhead whales were killed and more than 43 were struck and lost, we decided the time had come to call a halt. And in 1977, on our recommendation, the IWC ordered an end to all Bowhead hunting. At that time, we thought there were only 800 to 1,300 bowhead left.

JOHN: We couldn't believe it! No one told us the IWC was worried. If we had known, we could have taken some kind of action ourselves.

ALICE: But why did you kill so many whales? Bowheads range up to 60 feet long and weigh more than a ton a foot. Surely, your people didn't need that many.

JOHN: Our population has grown, and we have always depended on the Bowhead for our physical and cultural survival. We store the meat in ice cellars dug in the permafrost, and it makes up a major portion of our year-round diet. The whaling feast is the most important celebration in our villages. And the highest honor for a man is to have a whale kill to his credit.

But I admit there were more whaling boats out that year than ever before. Some of our people who had held pipeline or construction jobs could afford to outfit a whaling boat for the first time. Many of them had not been brought up in the old ways where you start as a whale hunter's apprentice at the age of 13. And some of them did stupid things - like shooting at the whale with a shoulder gun when there was no way to attach a float to the animal. Or killing a whale too far out, and having part of the meat spoil in the water before it could be towed back to shore. We didn't like those things either, I can assure you.

<sup>4</sup> see Tidelines, December-January, 1978 issue.

NAME \_\_\_\_\_

ALICE: Couldn't you do something about it?

JOHN: Well, after the IWC action, the whaling captains got together and formed the Alaska Eskimo Whaling Commission to develop our own management plan and spell out the responsibilities of the whaling captains. Then the U.S. delegation was able to talk the IWC into lifting the ban and giving us a quota of 12 instead. That wasn't nearly enough - and we were eating canned chicken by Thanksgiving - but it was better than nothing!

ALICE: But at what a cost! In exchange for the quota of 12 bowhead, the U.S. had to stand by while the IWC raised the North Pacific sperm whale quota to 6,500 for commercial hunters from Russia and Japan. That was nearly 10 times the quota of the year before.

JOHN: That wasn't our fault. That was the recommendation of the IWC Scientific Committee. And we Eskimos think some of those scientists don't know what they're doing - unless it's playing politics.

STEVE: Now wait a minute! The Bowhead is an endangered species - the sperm whale is not. You can't compare the two. A commercial harvest is acceptable if it doesn't endanger the population.

JOHN: Well, we think we know the Bowhead better than anyone else. And we always believed there were more than you figured. Last spring we helped set up ice camps on St. Lawrence Island and at Point Hope, Wainwright and Barrow to count the whales on their northern migration. Now scientists agree that there are probably between 1,800 and 2,800 bowhead.

KEN: Yes. That's just a small fraction of the original population, but the Bowhead does seem to be in better shape than we thought.

JOHN: Even so, we stayed within our quota. But a lot of good it did us. Last summer, we went to the IWC meeting in London to appeal their ruling on subsistence. But we weren't allowed to address the convention. We weren't even introduced. So when the IWC set a quota of only 18 whales for us this year, we walked out. And by that act, we symbolically removed ourselves from the regulations of the IWC. As I said, we will hunt by our own rules this spring. Scientists estimated the whale's reproduction rate at four percent, but to be on the safe side, we will take no more than two percent.

MIKE: But John, that reproduction rate is only a guess - and that would still be around 40 whales. You are aware of how little we know about the biology of the Bowhead. We don't know about their feeding habits or their natural cause of death. We don't even know for sure where they spend the winter, although we think it's in the southwestern Bering Sea. There is still so much to be learned.

KEN: And until we do know more, we feel there must be some outside regulation - even of subsistence hunting.

JOHN (angrily): You would think we are the only human menace to the Bowhead of the arctic. What about oil and gas industry in the Beaufort Sea? How will that affect the whales? Remember, the IWC also recommended that "all necessary measures" - and that's a quote - be taken to preserve the habitat of the Bowhead. It's hard to understand how a government that seems so anxious to protect the Bowhead can give the go-ahead for untested arctic oil exploration in the midst of the whale's natural habitat.

MARGARET: We in the oil and gas industry are aware of that worry, John. We're concerned with the environment too. And we certainly don't feel that our operations are untested. We believe we are capable of operating safely in the area.

JOHN: I'm not just talking about the danger of oil spills, which is bad enough. I'm also talking about the effect of such things as noise. Eskimos have always known that the Bowhead is very sensitive to sounds. We don't use outboard motors when we're stalking the whale. We approach it silently by paddling our skinboats. If you even hit the water with your paddle, the whale will disappear.

So just think what the noise from the drilling might do! It could change the whales' migration routes, disrupt their feeding and breeding activity, and further endanger the whale population.

MARGARET: The industry has spent millions of dollars on research to provide safe and economical exploration and production of oil in the state.

JOHN: Did you do any research into the effect of sound on whales?

MARGARET: Not in Alaska so far. But some work has been done on this in the Canadian Beaufort Sea . . .

JOHN: Then perhaps you'd better put giant mufflers on your drilling rigs.

MARGARET: Now just a minute, John. You also have to consider priorities here. The world needs new sources of gas and oil. The State of Alaska needs the income the industry pays in taxes, leases and royalties. That will amount to about \$790 million this year or more than 60 percent of the State's income. This money has helped build schools, hospitals, air strips, small boat harbors, and even this TV network which goes out to villages all over the state. And don't forget that industry and pipeline construction provided training and jobs for nearly 6,000 Native men and women in Alaska.

JOHN: The whale was here long before the money.

KEN: No one here is trying to put a dollar value on the Bowhead - or any of the great whales. If the largest creature ever to live on earth were allowed to perish, it would be one of the greatest wrongs we have ever done.

ALICE: Well, the commercial whalers from Japan and the Soviet Union are certainly putting a dollar value on the Sperm Whale - and for shoe polish, pet food, fertilizer . . .

STEVE: You will be happy to hear that the IWC's Sperm Whale quota for 1979 has been cut to 3,800 - about half last year's quota.

ALICE: A commercial kill of 3,800 whales is still outrageous. And we can't understand how the U.S. got itself into the position of having to bargain for Eskimo subsistence rights with the commercial whalers who were responsible for the decline of the Bowhead in the first place.

KEN: The government offered to supply the Eskimos with other red meat, free of charge, as a substitute for whale meat - or to give them more food stamps . . .

NAME \_\_\_\_\_

JOHN: Just to replace the meat from those 12 whales we killed last year would cost you about \$500,000. Do you want to put us on a permanent welfare? How would you like it if the Eskimos could order the rest of the nation to stop eating beef?

MODERATOR: I'm afraid we are running out of time. Perhaps we can summarize quickly where matters stand.

MIKE: We're sending a research vessel into the southwestern Bering Sea this spring to try to find out more about where the Bowheads begin their migration. We hope to have data available on a full year cycle of the whale before the next Beaufort Sea oil and gas lease sale is held in December.

MARGARET: And under the federal law, that data will be taken into consideration before the leases are approved or drilling is allowed. And if it appears noise will be a problem, we are prepared to limit drilling activity to the winter months when the whales are gone.

STEVE: The IWC Scientific Committee meets again this month to draw up recommendations for the full convention. We can only hope that the Eskimos stay within the quota that has been set.

ALICE: After observing the hunt last summer, we sympathize with the Eskimo's problem. We were impressed with the difficulty of the hunt and the importance of the whale to their culture. We would be willing to support a limited subsistence hunt, so long as survival of the whale is assured.

EMILY: We will work towards a decision that balances careful conservation of whales with sensitivity to human needs. We think it would be grossly unfair to ask the Native hunters and their families to bear the entire cost of that decision.

KEN: The U.S. delegation will continue to urge the IWC to set up a separate system for regulating subsistence whaling. After all, John, the Eskimos are enjoying some of the good things of the modern world. And you have to accept some of the regulations, too.

JOHN: And we will be hunting as we said we would. We reject the idea that political nations which make up the IWC have any authority over our ancient aboriginal rights. And we will carry our case all the way to the United States Supreme Court and the World Court, if necessary.

Meanwhile, I can assure you, the Eskimo will not kill the last whale.

\* \* \* \* \*

This article was circulated for critical review of content and fairness to the Arctic Environmental Information and Data Center and the Institute of Marine Science (both University of Alaska); the Office of the Mayor, North Slope Borough; Greenpeace Alaska; Sohio Petroleum, and the Alaska Department of Fish and Game. Some changes have been made in the original manuscript on the basis of that review, in an effort to present all sides as fully as possible.



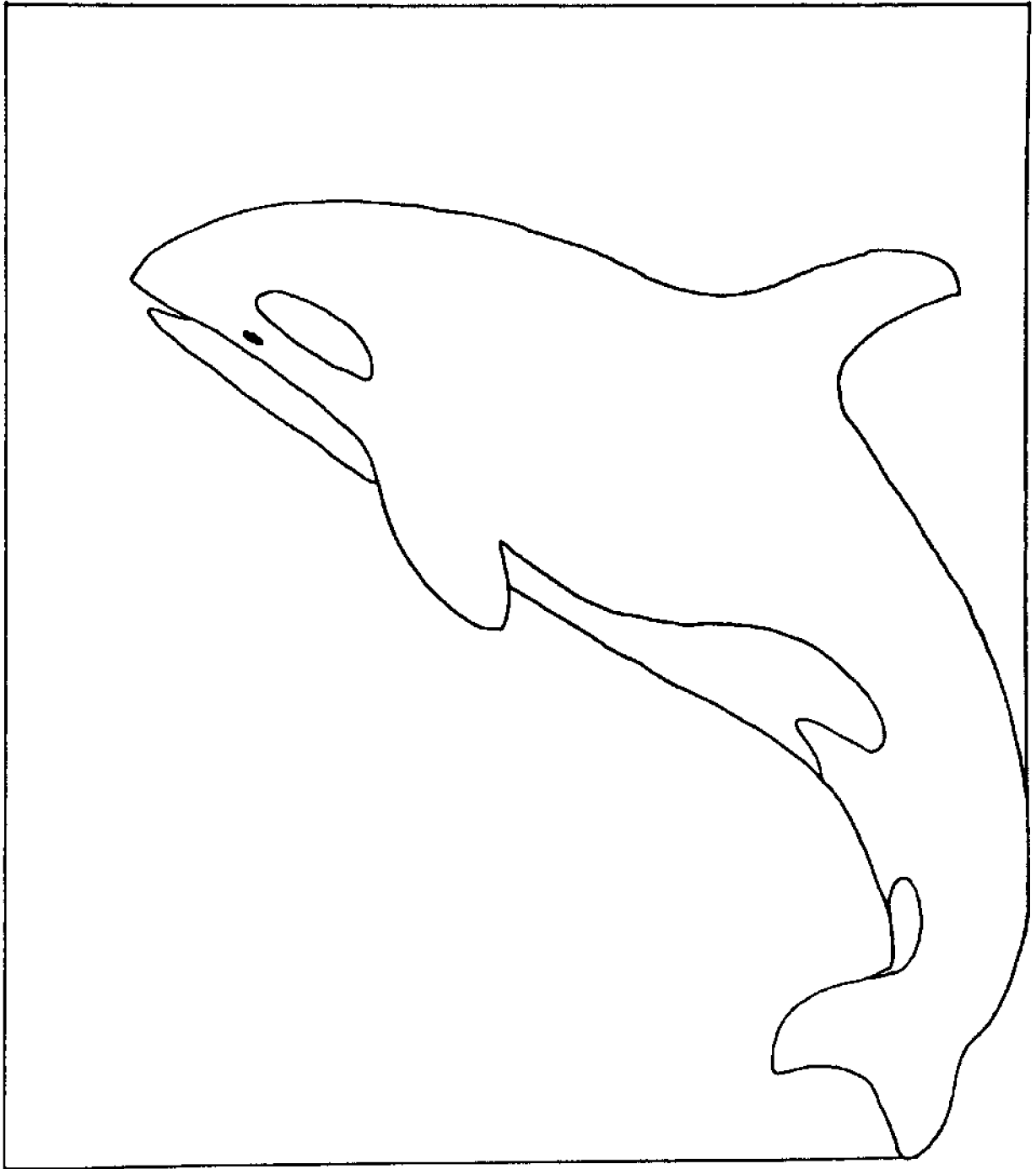

**VOCABULARY**  
**BIBLIOGRAPHY**

## Teacher Information

- ADAPTATION** - Structures or behaviors that allow an organism to be well-suited to the conditions of its environment.
- AMBERGRIS** - grayish waxy substance found in the intestine of Sperm Whales that was used as a fixative in perfumes.
- BALEEN** - also called whalebone - the elastic materials forming plates or strips in the upper jaw of whalebone whales that is used to filter food out of the water.
- BIRTH RATE** - ratio of births to total population: gives a measure of growth.
- BLUBBER** - thick layer of fat beneath a whale's skin that's useful protection against cold. Blubber is boiled down for whale oil by whalers.
- BREACH** - jumping all or part way out of the water. Whales and dolphins may breach for fun or to signal danger.
- CETACEA** - order of fishlike aquatic mammals including whales and dolphins.
- DEATH RATE** - ratio of deaths to total population.
- DORSAL FIN** - the main fin on the back of fishes or porpoises. In the Orca, the marking on and the shape of the dorsal can be used to identify individuals.
- ECHOLOCATION** - ability of an animal such as a porpoise, to orient itself by giving out high-pitched sounds and listening to the echoes.
- FACTORY SHIP** - Large modern ship containing all the necessary machinery, boilers, freezers, etc. to process whales at sea.
- INTERNATIONAL WHALING COMMISSION** - worldwide body, with voluntary membership which establishes quotas (non-enforceable) on whale kills.
- LOBTAILING** - whale's behavior of slapping the flukes on the surface of the water, making a loud crack. Usually means danger.
- MAMMALS** - class of animals (including whales, humans) having hair, milk secreting glands, bearing live young and regulating body temperature.
- MAXIMUM SUSTAINABLE YIELD** - the highest number of animals that can be taken from a population without harming the population's ability to replace its lost numbers.

- MYSTICETES - (MIS-tuh-ceets) - Baleen whales, larger in size than Odontocetes. Includes Blue, Gray, Fin and Humpback.
- ODONTOCETES - (o-DON-tuh-ceets) - toothed whales, generally smaller in size than Mysticetes. Includes Orca, Dolphins, Sperm Whales.
- ORCA SURVEY - Puget Sound research project, run by Moclips Cetalogical. Collects information on Orca populations in the area.
- POTLATCH - Give-away feast dance that is a common custom of many Northwest Indian tribes to celebrate an event such as a whale kill.
- QUILEUTE INDIANS - (QUILL-lee-yoot) an Olympic Peninsual Coast tribe centered in the village of Quileute, 36 miles southwest of Cape Flattery. They were formerly a whaling people, principally hunting the California Gray Whale.
- SINEW - a tendon or connective tissue. The sinews of whales were used by whaling Indians for fiber in ropes.
- SONAR - a system, biological or manmade, that uses echoes to locate objects.
- SPERMACETI - white, waxy substance from the head of Sperm Whales that was valued for use in candles, ointments and cosmetics.
- SUBSISTENCE HUNTING - also termed aboriginal hunting; taking of whales by people such as the Eskimos who need them in order to survive and for whom whale hunting is an integral part of the culture.
- TECHNOLOGY - the knowledge available to a people that is used to make things, collect and extract materials and practice skills and arts.
- WHALE BONE - also called baleen. Elastic material making up plates or strips that hang down from the upper jaw of a baleen whale. Used by the whale to filter food from the water and formerly used by people for many purposes including umbrella spokes and corset straps.
- WHALE CATCHER - a modern motorized boat equipped with explosive harpoon gun used in pursuit and killing of whales.

ADAPTATION

AMBERGRIS

BALEEN

BIRTH RATE

BLUBBER

BREACH

CETACEA

DEATH RATE

DORSAL FIN

ECHOLOCATION

FACTORY SHIP

INTERNATIONAL WHALING COMMISSION

LOBTAILING

MAMMALS

MAXIMUM SUSTAINABLE YIELD

MYSTICETES

ODONTOCETES

ORCA SURVEY

POTLATCH

QUILEUTE INDIANS

SINEW

SONAR

SPERMACETI

SUBSISTENCE HUNTING

TECHNOLOGY

WHALE BONE

WHALE CATCHER

## BIBLIOGRAPHY

Books and Articles

Alpers, Anthony. Dolphins: The Myth and the Mammal. Houghton Mifflin Company. Boston, MA. 1960.

Brenner, Malcolm. In Contact: An Interspecies Romance. Excerpted in McIntyre, Joan. Mind in the Waters. Charles Scribner's Sons. New York, NY. 1974.

Brooks, Barbara (ed.). The Whole Whale Catalog. Great Lakes Living Press, Ltd. Waukegan, WI. 1978.

Coffey, David J. Dolphins, Whales and Porpoises. MacMillan Publishing Co. New York, NY. 1977.

Cousteau, Jacques-Yves. The Whale: Mighty Monarch of the Sea. A and W Visual Library. New York, NY. 1972.

Educational Development Center. People and Technology. Newton, MA.

Friends of the Earth. The Whale Manual. Friends of the Earth books. San Francisco, CA. 1978.

Gatenby, Greg (ed.). Whale Sound. J.J. Douglas, Ltd. North Vancouver, Canada. 1977.

Griggs, Tamar. There's a Sound in the Sea. The Scrimshaw Press. San Francisco, CA. 1975.

Hunter, Robert and Weyler, Rex. To Save a Whale. Chronicle Books, San Francisco, CA. 1978.

Kellogg, W.N. Porpoises and Sonar. University of Chicago Press. Chicago, IL. 1961.

Kirk, Ruth and Richard Daugherty. Hunters of the Whale: An Adventure in Northwest Coast Archeology. William Morrow and Company. New York, NY. 1974.

Lilly, John E. Lilly on Dolphins. Anchor Press/Doubleday. New York, NY. 1975.

McIntyre, Joan. Mind in the Waters. Charles Scribner's Sons. New York, NY. 1974.

McReavy, John Morgan. Makah: Indian Whale Hunters. Naturegraph Publishers. Healdsburg. 1973.

Matthew, Dr. Leonard (ed.). The Whale. London Zoological Society, Crescent Books. New York, NY. 1975.

Melville, Herman. Moby Dick. Random House. New York, NY. 1930.

Mowat, Karley. A Whale for the Killing. Little, Brown and Company. Boston, MA. 1972.

Nayman, Jacqueline. Whales, Dolphins, and Man. Hamlyn Publishers. New York, NY. 1973.

Nickerson, Roy. Brother Whale. Chronicle Books. San Francisco, CA. 1977.

Norris, Kenneth. Whales, Dolphins and Porpoises. University of California Press. Berkeley, CA. 1966.

Oummaney, F.O. Lost Leviathan: Whales and Whaling. Dodd, Mead and Co. 1971.

Powell, Jay and Vickie Jensen. Quileute for Kids, Book 6.

Scammon, Charles M. The Marine Mammals of the Northwestern Coast of North America. Originally published in 1874. Reprint: Dover Publications. New York, NY. 1968.

Scheffer, Victor B. Year of the Whale. Charles Scribner's Sons. New York, NY. 1969.

Slipper, E.J. Whales. Hutchinson and Co., Ltd. London, England. 1962.

Swan, James G. The Indians of Cape Flattery. Smithsonian Contributions to Knowledge #220. Shorey Book Store; Seattle, WA. Printed 1972. Originally published in 1868.

Warshall Peter. "The Ways of Whales," in McIntyre, Joan. Mind in the Waters. Charles Scribner's Sons. New York, NY. 1974.

Watterman, T.T. "The Whaling Equipment of the Makah Indians." University of Washington Publications, Vol. 1, No. 1. June, 1920. pp. 1-67.

Wood, Forrest G. Marine Mammals and Man: The Navy's Porpoises and Sea Lions. Robert B. Tuce, Inc. Washington, D.C. 1973.

Periodicals and Other Publications

Alaska tidelines. "Battle Over the Bowhead." June, 1979.

Audubon, 77:1. June 1975. Entire issue devoted to whales.

Chandler, Goebel and Balcomb. "Who is the Killer Whale?" Pacific Search. May 1977.

Earle, Sylvia A. "Humpbacks: The Gentle Whales." National Geographic, 155:1. January, 1979. p. 2.

Ellis, Richard. "The Singing Whale." Ocean World. September-October, 1978. p. 19.

Graves, William. "The Imperiled Giants." National Geographic, 150:6. December, 1976. p. 722.

Henning, Robert (ed.). "Alaska Whales and Whaling." Alaska Geographic, Vol. 5, No. 4. 1978.

Hudnall, James. "In the Company of the Great Whales." Audubon, 79:3. May, 1977. p. 62.

Lien, John and Bora Medsory. "The Humpback is Not Over the Hump." Natural History, 88:6. June-July, 1979. p. 46.

Lilly, John. "The Rights of Cetaceans Under Human Laws." Oceans, 9.2. March-April 1976. p. 66.

Linchan, Edward J. "The Trouble with Dolphins." National Geographic, 155:4. April, 1979. p. 506.

ORCA Survey Material - Write to ORCA Survey, Friday Harbor, WA 98250.

Payne, Roger. "At Home with Right Whales." National Geographic, 149:3. March, 1976. p. 327.

Payne, Roger. "Humpbacks: Their Mysterious Songs." National Geographic, 155:1. January, 1979. p. 18. Also includes record.

Pequegnat, Willis E. "Whales, Plankton and Man." Scientific American, reprint. January, 1958.

Reagan, Albert B. "Whaling of the Olympic Peninsula Indians of Washington." Natural History 25:1. 1925. pp. 24-32.

Scheffer, Victor. "Exploring the Lives of Whales." National Geographic, 150:6. December, 1976. p. 752.



Tarpy, Cliff. "Killer Whale Attack." National Geographic, 155:4. April, 1979. p. 542.

Valencib, Joe and Robin. Whale Watching Guide. Write c/o Quest Marine Research, Box 832, Dana Point, CA 92629. \$1.50 plus \$.25 postage.

The Whale Report. A quarterly publication of the Whale Protection Fund, Center for Environmental Education, Inc.; 2100 M Street NW; Suite 307; Washington, D.C. 20037.

### Curricula

American Cetacean Society. ACS/LA Teaching Kit; P.O. Box 4416; San Pedro, California 90731. (213) 548-6279.

Bennett, Dugan and Scott. "Sea Mammals." Teaching unit prepared for Dr. Lawson. 1973.

COAST. "The Year of the Whale" #220. Population-Environment Curriculum Study; 310 Willard Hall; University of Delaware; Newark, Delaware 19711.

Griggs, Tamar. "Whale Workshops: A Guide for Elementary School Teachers." Smithsonian Traveling Exhibition Service. Washington, D.C. 1976.

King, Pat and John Landhal. Teaching Population Concepts. Office of Environmental Education, Washington State. Olympia, WA. 1973.

ORCA. "Energy from the Sea." Pacific Science Center. Seattle, WA. 1978.

ORCA. "Waterbirds." Pacific Science Center. Seattle, WA. 1979.

Project Jonah. "International Children's Campaign to Save the Whale." Box 476; Bolinas, CA 94924.

Schatz, Overman and Luttrell-Montes. "Marine Science Activities for the Visually Impaired." Pacific Science Center. Seattle, WA. 1978.

Symonds, Ruth E. "Teaching About Whales to Weave Sea Tales." 5400 Halbrent Avenue; Van Nuys, CA 91411.

The Whale Book: A Conservation Manual. Teaching Tool Source Book. Endangered Species Productions. 1974.

Records

Collins, Judy. Whales and Nightingales. Elektron Records. Song title: "Farewell a Tarwathie."

Halpern, Dr. Ida. Nootka: Indian Musics of the Pacific Northwest Coast. Ethie Foldways Library FE 4524. Song title: "Whale Song." Side 1, Song 5.

Horn, Paul. Inside II. Epic Records. Flute with Orcas. Side 2, Song 1.

Payne, Roger S. Songs of the Humpback Whale. Capitol Records, SW-620.

Payne, Roger. Deep Voices. Capitol Records, ST-11598.