

**Woods Hole
Oceanographic
Institution**

LIBRARY COPY ONLY



**The Environmental Impacts of Boating;
Proceedings of a Workshop held at
Woods Hole Oceanographic Institution, Woods Hole MA USA
December 7 to 9, 1994.**

Edited by: Richard E. Crawford, Nils E. Stolpe and Michael J. Moore

March 1998

Technical Report

Approved for public release; distribution unlimited.



Funding for this report was provided by the Rinehart Coastal Research Center of the Woods Hole Oceanographic Institution and the Mobil Foundation.

WHOI-98-03

**The Environmental Impacts of Boating;
Proceedings of a Workshop held at
Woods Hole Oceanographic Institution, Woods Hole MA USA
December 7 to 9, 1994.**

Edited by: Richard E. Crawford, Nils E. Stolpe and Michael J. Moore

Woods Hole Oceanographic Institution
Woods Hole, Massachusetts 02543

March 1998

Technical Report

Funding for this report was provided by the
Rinehart Coastal Research Center of the Woods Hole Oceanographic Institution and the
Mobil Foundation.

Reproduction in whole or in part is permitted for any purpose of the United States
Government. This report should be cited as Woods Hole Oceanog. Inst. Tech. Rept.,
WHOI-98-03.

Approved for public release; distribution unlimited.

Approved for Distribution:



Wayne R. Geyer

Director, Rinehart Coastal Research Center

Acknowledgments

Funding for this workshop was provided by:

Gratia Houghton Rinehart Coastal Research Center (Woods Hole Oceanographic Institution),
Rutgers University,
American Littoral Society, and
Island Foundation, Incorporated.

The editors thank the presenters and participants of the workshop as well as Bebe McCall and Bruce Tripp of the Gratia Houghton Rinehart Coastal Research Center and Dery Bennet of the American Littoral Society for their gracious help in achieving a successful meeting. Transcripts of the presentations were prepared by Maureen Pires, Verbatim Court Reporter (508-748-2857), and then edited for these proceedings by Richard Crawford, of the Waquoit Bay National Estuarine Research Reserve and who bears primary responsibility for any inaccuracies in assembling this document. Nils Stolpe, a private consulting expert in boating and marine issues and Michael Moore of the Woods Hole Oceanographic Institution also assisted in editing. Bebe McCall transformed a rough text version of this document into its final form. Unedited verbatim transcripts of the meeting's presentations are available on diskette from Michael Moore, MS 33, WHOI, Woods Hole, MA 02543.

The editors also thank Bruno Broughton of Ruddington, Nottingham (England) and Bradley Barr of the Massachusetts Office of Coastal Zone Management (presently with the Gerry Studs Stellwagen Bank National Marine Sanctuary) for sharing bibliographies and files relating to boating impacts literature. Although much of this literature is dated and unpublished, the references were compiled into bibliographies by R. Crawford as appendices in this report.

Table of Contents

	Page
Executive Summary	4
Introduction	4
J. Joseph	8
Biological profile of a "typical" estuary	
N. Stolpe	12
National recreational boating patterns	
N. Stolpe	22
Boating generated turbulence	
D. Bennett	25
Boating impacts from an environmentalist's perspective	
P. Weiss	27
Anthropogenic effects of boating activities	
C. Kruer	32
Boating impacts on seagrass habitats in Florida	
B. Harrington	40
Effects of chronic recreational disturbance on shore birds	
P. Hartge	44
Boating induced turbidity	
G. McCarthy	50
Statistical analysis of boating effects on turbidity in Otsego Lake (NY)	
R. Crawford	69
Measuring boating effects on turbidity in a shallow coastal lagoon	
L. Madin	79
Possible effects of prop shearing on zooplankton	
L. Balk et al.	84
Toxic effects of outboard motor emissions on fish	
M. Moore	87
Aromatic hydrocarbons: 2-cycle vs. 4-cycle engines	
A. Mele	92
Proposed federal boating emissions regulations	
L. McLaughlin	96
Marine engine emissions—alternative boating fuels	
J. Smith	121
Massachusetts regulatory perspective	
V. Douglas	128
Federal Sportfish Restoration Program	
Working Groups	134
Findings and Conclusions of Groups Considering the Following:	
1. Turbulence. 2. Toxic boating effects. 3. Legislation.	
4. Docks. 5. Living resources/physical damage/turbulence.	
Appendices	149
A, B, C, and D: Bibliographies of boating effects literature.	
E. Workshop attendees; affiliations, mail and e-mail addresses, and telephone and telefax numbers.	199

Executive Summary

Substantiated impacts of boating activity that were discussed at this workshop include: sediment and contaminant resuspension and resultant turbidity; laceration of aquatic vegetation with loss of faunal habitat and substrate stability; toxic effects of chemical emissions of boat engines; increased turbulence; shearing of plankton; shorebird disturbance; and the biological effects of chemically treated wood used in dock and bulkhead construction. These discussions revealed that many of the issues of concern remain inadequately defined and described. But sufficient hard data was referred to or presented to substantiate the inference that recreational and commercial motor boat operation is far from a benign influence on aquatic and marine environments. This is particularly so in temperate climes due to the unfortunate synchrony, with only a few exceptions, between the peak seasons for boating and the occurrence of planktonic embryonic and larval stages of vertebrates and invertebrates in estuaries and coastal waters. Therefore, the chance of plants and organisms being affected by power boat operation appears to be substantial in shallow, heavily used boating areas such as those along the entire U.S. eastern and Gulf coasts. As such, motor boat operation ought to be regarded as a privilege which requires due consideration of environmental impacts, and should be conducted and managed in such a manner as to minimize those impacts.

Introduction

This workshop was born from the interest of an informal network of concerned individuals. The meeting was conceived to be more than simply a data workshop, a character that is reflected in this document. Instead, the meeting was intended to be a time to share data and discuss hypotheses and speculations. The object of the discussions was to consider the jigsaw puzzle of potential impacts of boats in the aquatic environment. It was recognized that workshop results would not represent definitive descriptions of boating impacts. Instead it was hoped that the meeting would define some of the boundaries of the impacts jigsaw puzzle. At the same time, it was acknowledged that many of the puzzle pieces would be left in outline form.

The steering committee invited representatives from industry, government, science and the environmental lobby to the workshop. The attendees included administrators, consultants, writers, economists, research scientists and environmental advocates. The only invited group that chose not to attend the meeting was industry.

Our charge at the workshop was to examine boating activities in different habitats according to the spectrum of no impact to high impact, to consider what are the best indicators to measure those impacts, and to begin to focus on the critical agents of change. This approach is illustrated by a brief case study where there is little question of boating having a severe impact in the Norfolk Broads in England. There, about 250 miles of rivers run through a series of medieval

peat diggings that make broad lakes anything up to a mile or two in length. The banks of the rivers are peat, and the bottoms soft mud. Seasonal rental power boats cause massive traffic problems as well as bank erosion, turbidity, macrophyte shearing, chronic habitat disturbance, noise, and pollution from boat sewage. Solutions have been hard to find, as the local economy is heavily tourist dependent. Speed limits, pump-outs and bulkheads on the river banks are the primary management tools currently in evidence. In spite of the fact that boating activity has an evident impact in that region, there is insufficient definitive understanding of how boating affects shallow systems to help planners and managers design additional measures that would help to minimize environmental consequences while allowing boating activity to continue. It was the hope of workshop organizers that the discussions at this meeting would provide kernels for the efforts of the diverse group of attendees to help design such measures.

The agenda of the workshop was to hear perspectives from managers, economists, statisticians, and scientists on the issues at hand: the biological, physical and chemical effects of recreational boating activity as it relates to hulls of pleasure craft being propelled through the water. We intentionally avoided the separate issue of boat sewage discharge as it is a separate workshop unto itself. The deliberations were to be rational and based on science, rather than foregone conclusions.

At the conclusion of the formal presentations, participants were to gather into groups to discuss the issues that were raised as well as related issues that were not, and generate working statements relevant to these goals. The general theme of each working group was to be decided at the conclusion of the presentations. The themes would reflect the issues that had received the most emphasis in both the formal presentations as well as during the question-and-answer period that followed each presentation. The participants in the working groups were charged with the following questions:

- What do we know?
- What do we not know but need to?
- What research is currently in progress?
- What research collaborations should be established?
- Where should funds be sought to pursue these goals?
- Which issues are, can and should be managed by legislation?
- What is an appropriate legislative agenda at the national and state level?

The proximate goal of the workshop was to generate a working document to define issues relevant to the effects of boating activities. In spite of the fact that the study of boating impacts is in its early stages, there is a substantial body of literature, much of it from England, that is relevant to the issues discussed here. Workshop participants were to review what is known and to chart research and management needs and how these might be addressed. Our ultimate goal was to

focus academic, political and legislative consciousness toward boating-related issues that may be damaging to the health of our coastal and freshwater ecosystems and consequently damaging to the long term viability of regional economies.

This document is an edited proceedings of the workshop. Some of the presentations were reports of new information about well established, long known impacts such as turbidity and bird disturbance. Other topics, such as the toxic effect of engine exhaust and propeller shearing questions, have been little studied in the boating context. Because of the embryonic nature of many of the ideas discussed at the workshop, it developed a somewhat fluid format that is reflected in these proceedings.

Some talks referred to visual material not included in these proceedings; several were not supported by written text other than abstracts. To enhance the readability of this document, the editors have taken editorial liberties to help convey the message of the author of a presentation. Most of the presentations are reported as edited versions of text submitted by the author or as edited transcripts of a verbatim recording. Appropriate unedited tables and figures are included, if available. The presentation by George McCarthy was supported by text taken from a more formally structured manuscript under development for subsequent publication elsewhere. A synopsis of this text has been included in this proceedings. When data from completed studies was mentioned in a talk, appropriate references are given in this compilation. Several bibliographies of literature pertinent to the topics discussed at the workshop are included in the Appendices.

The contents of this proceedings are to be considered descriptions of works-in-progress. They cannot be cited without the permission of the authors of the various presentations. As noted in the Acknowledgments section, unedited transcripts of the presentations are available from Michael Moore, MS 31, WHOI, Woods Hole, MA 02543.

In editing these transcripts we have forgone efforts to maintain the character of the presenters' individual manners of speech in favor of producing a document with consistent style and format. The exception is the Question and Answer sessions. These have been included in a modestly edited form to retain the deportment of the discussions, a fundamental element of the future of the issues forming the crux of the workshop. The sequential order of the papers has been reorganized from that of the workshop to better maintain a logical format within this document. We hope that this report will be used as a source of discussion to stimulate new research ideas and generate new management concerns and/or plans in those instances when the material is relevant.

In this regard, the findings of the working groups provide useful overviews of what we know and what we need to know. Toward this end, one of the most remarkable aspects of this workshop was the revelation of the greater activity and knowledge base of many state-level environmental managers than that for members of the academic and research communities. This in

part reflects the applied nature of the issues but it also points to a real need for increased funding for research in all of the areas considered at the workshop, an appraisal which is described in greater detail in these proceedings.

Biological Profile Of A "Typical" Estuary

Jim Joseph

Division of Fish, Game and Wildlife, New Jersey Department of Environmental Protection, Trenton, NJ

Coastal wetlands adjacent to estuaries are very productive—an ecological soup containing phytoplankton, zooplankton and various life stages of fish, crustaceans, polychaetes and mollusks. There was a tremendous amount of development pressure in the coastal zone prior to the development of a multitude of state and federal regulations regarding coastal development and wetlands protection. Waterfront development is rampant with tremendous amounts of dredging and filling of coastal areas to create lagoon developments in order to get every square inch along the shore, with resultant habitat destruction and degradation.

In New Jersey for example, between 1970 and 1990, while the total state population increased only about eight percent, the population of the coastal counties increased by 30, 60, and over 100 percent. So, there is a mad dash to the coast. All of these people moving to the shore want to have their boats, and that has created more problems for water quality, congestion, environmental disturbance and fishing pressure.

In New Jersey, and I am sure in most coastal areas, in estuaries on any given weekend day and even during the week in the summertime it is sometimes "wall-to-wall" boats involved with recreational fishing—individual boats and party boats that have large numbers of people.

This [slide] is an aerial shot of Delaware Bay on a weekend day. Each of those little white dots is not a whitecap but a boat being used for fishing, putting tremendous pressure on the resource from an ecological as well as an over-exploitation aspect.

In coastal zone and near shore waters there is also a lot of commercial fishing and related activity that creates other pollution problems which, whether they are from surf clam boats or draggers or otter trawlers, we are concerned about.

Another problem that is common along the coast is determining the causes of declining stocks. Is it the recreational guy taking all the fish; is it commercial draggers just vacuuming everything up; is it a combination of the two? The resulting conflicts are being resolved in a number of ways, primarily through screaming matches. But as more and more fisheries stocks are declining, government managers are looking at all possible causes. One of those being looked at, at least in New Jersey, and I am sure in other areas—and the purpose of this workshop—is boating and its impact on various life stages of fishes.

Estuarine juvenile and young-of-the-year fish and invertebrates have been studied by state and federal agencies and academic institutions by using various otter trawls, and seine plankton

and bongo nets. Typically, the younger stages—eggs and larvae—are more vulnerable to environmental disturbances, whether it is physical disturbance or elevated levels of hydrocarbons or heavy metals. A lot of the resource information that has been collected over the years by government and academic institutions was compiled and published in March of this year by NOAA's Estuarine Living Marine Resources Program. It documents the eggs and larvae in the estuaries of the Atlantic Coast states and the times of the year that they are present. The following important species have their embryonic and larval life stages between April and October (the precise timing depends on species and latitude): blue mussel, American oyster, hard clams, blue crab, blue-back herring, alewife, American shad, Atlantic menhaden, minnows, killifish, silversides, white perch, striped bass, black sea bass, tautog and Atlantic mackerel. In contrast, cod and winter flounder tend to spawn in the winter months.

Many of these fishery resources are experiencing stock declines, intensifying the need for more and more regulations to limit harvest and protect habitat and maintain our improved water quality. The state and federal governments have implemented various regulations and guidelines to allow development but with care to reduce environmental impacts. New Jersey has developed guidelines to steer marina development away from sensitive areas such as shellfish beds and submerged vegetation and toward areas with good flushing and deep water where dredging will not be required. The state also has incorporated best management practices to further reduce the impacts.

There has also been an extensive public education campaign to make members of the boating community more aware of their activities and how they can impact the coastal zone water quality in particular, whether with marine heads, bottom paints, or just plain litter. Via the Clean Vessel Act, New Jersey has established more and more pump-out stations to meet planning requirements for more No Discharge Zones to improve water quality in the estuary.

Coastal zone regulations in New Jersey are constantly being revised, sometimes to the dismay of the development interests. But some recent work by Dr. Weis [and Dr. Judith Weis] regarding pressure treated lumber, for example, has been incorporated into recent amendments to these regulations. In July of this year we adopted regulations precluding the use of pressure treated lumber in certain estuaries in New Jersey because of their impacts from new marina construction. Our coastal regulations are constantly being revised to address problems based on current information that is available.

In summary, the sensitive life stages occur in our estuaries basically from April through September or October. Unfortunately, that coincides fairly well with the boating season, at least in the Mid-Atlantic. There has been tremendous development pressure and tremendous declines in fisheries stocks. And in an effort to try and curb that, people are "pointing the finger". Whether it

is you are overfishing, or I am overfishing, or whether it is a pollution problem—all of these things are being addressed. I wanted to give you a feel for what is going on out there.

Q (by Michael Moore) Regarding all those different species, do you have any feeling for which species or groups of species in particular are most likely to be sensitive to entrainment and damage? This is a question that will be addressed later on, but I want your perspective on it.

A (by Jim Joseph) I don't. I work for the Bureau of Shellfisheries, and unfortunately, I have a kind of tunnel vision looking at clams and oysters. And there is a tremendous amount of information in the literature about the effects of petroleum hydrocarbons and copper bottom paints and things like that on the eggs, larvae and juveniles of hard clams, for examples, and oysters. So, they are very susceptible to those kinds of pollution. As for as other species, I am not that familiar with them.

Mr. Moore: The issue is a big one, but it has not really been addressed academically yet.

Mr. Joseph: If anybody is interested, this is a terrific publication. "Distribution and Abundance of Fishes and Invertebrates in Mid-Atlantic Estuaries," ELMR, which is Estuarine Living Marine Resources, Report #12, March, 1994. It lists most of the important species and at what life stages they are in the estuaries at different months of the year. It is a good reference source.

Q (by Nils Stolpe) Jim, are there any species that you are aware of that move up and down in the water column daily over a 24 hour period that their movement might make them less vulnerable to certain boating impacts during the day than at night.

A Yes, there is vertical migration for a number of species, but I could not give you specific ones. Most of the species we are concerned about during their relevant life stages are just free-drifting organisms that are pretty much everywhere throughout an estuary at a given period of time.

Q You said that the bass had semi-buoyant eggs?

A Yes.

Q When you say "semi-buoyant," does that mean that they move up and down or do they just kind of hang out at some depth?

A As opposed to a demersal egg that may be adhesive and stick to the bottom between rocks or something like that, it is a slightly negatively buoyant egg as opposed to one that is floating around and would go everywhere. So they tend to hang out along the bottom but would not just anchor themselves to the bottom.

Q In your experience in New Jersey, some of the boating impacts to shellfish, then inspecting seed beds, moorings and—

A Most of the problems that we experience in New Jersey are due to water quality degradation as it affects shellfish harvestability. There are fairly extensive regulations that prevent

new dredging and protect sensitive shallow water habitats, submerged vegetation beds and similar areas. Despite the regulations, we are constantly in court to fight those kinds of developments in sensitive areas.

I recently went through a regulatory challenge in New Jersey where people who were denied permits for docks had been suing the state and the Commissioner of the Department of Environmental Protection was getting intense pressure from the disgruntled applicants. I looked at the data, which showed that only nine percent of permit applications were being denied. We were only hearing from the nine percent who are dissatisfied, not the 91 percent who got their dock. Most of the dock applications are approved, but we are trying to steer them away from sensitive areas.

Q So, the pollutants you are dealing with are toxics rather than—

A Well, coliform contamination, petroleum hydrocarbons from boat operation, copper bottom paints, detergents, pressure treated lumber are a big concern. All those things are reviewed, but unfortunately, most of the regulations deal almost exclusively with coliform contamination and the potential for coliform contamination from boats.

Q And the major source for you is the marina? I mean, it seems that in Massachusetts coliform contamination is mostly a nonpoint source pollution problem.

A Yes, but we have got to start somewhere. And New Jersey is in the process of implementing a study looking at the environmental impact of individual docks. There has been a lot of data collected on marina situations. Dr. Weis, over the last two years, for example, has done some work with pressure treated lumber from individual structures. Because of the court cases that we have had to deal with, arguing that we can not use marina data to extrapolate from to prevent single dock construction, we are going to be looking at what those water quality impacts are for individual docks in mooring areas so that we can address that issue more precisely in the future.

National Recreational Boating Patterns

Nils E. Stolpe

3840 Terwood Drive, Doylestown, PA 18901

(Editors's note: The preponderance of this talk was based on visual aids in the form of several charts. Due to the high probability that much of the complex information contained within the charts would be lost in a copy of only the text of the talk, the figures used in the presentation have been included in this report.)

In an attempt to put this workshop in the proper context, I am going to give you a brief overview of recreational boating in the United States, of the size and importance of the recreational boating industry, and of what seem to be some developing trends in boating. First, some general industry information from the U.S.E.P.A. Draft Regulatory Impact Statement:

- In 1994, outboard motor manufacturing in the United States could reach \$1 billion. This would represent a 12 percent annual increase in each of the previous two years. The production of inboard/outboard motors (also known as stern drives) is projected to reach \$975 million, 34 percent below the level reached in 1984. Sailboat sales are expected to be \$125 million. In 1993, the sale of personal water craft (jet skis, wave runners, etc.) was \$618 million.
- From 1991 to 1994 total retail boat sales in the United States increased 20 percent. During the same period, the sales of personal watercraft increased 41 percent, making them — along with unpowered craft like kayaks and canoes — one of the fastest growing segments of the recreational boating market. Personal watercraft are driven by waterjets and are capable of operating in much shallower water than conventional powered craft. Because of this shallow water capability they have opened up many areas that had previously been off limits to powered craft.
- The boating industry is fairly well concentrated. Fifty-six percent of all the marinas in the U.S. are located in four states; eight states support almost $\frac{1}{2}$ of all the recreational boat dealers; almost $\frac{2}{3}$ of all recreational boat manufacturing is done in ten states.

I do not want to get bogged down with an excess of numbers so I will go over the following graphs fairly rapidly. They are indicative of the general boating patterns that we see in the U.S., some of which might prove useful in any consideration of public policies focused on

boating regulations. Most of the data described in the graphs came from either the U.S. Fish and Wildlife Service's National Boating Survey or was compiled by the U.S. Environmental Protection Agency as it focused on emissions from boat engines and other previously unregulated sources, such as non-road surfaces. I do not know how rigorous these agencies were in accumulating the data; I would imagine not very.

Tracking boating activities is a difficult task, in large part because of the "mobile" nature of many recreational boats and virtually all personal water craft; they are trailerable and can be used in waters far from where they are registered. Another factor could be the extremely long lives of fiberglass boats and modern outboard motors. A seemingly ancient boat in a backyard can still be serviceable [e.g., ready-to-go] with an up-to-date registration, even if the boat is rarely used. Finally, many members of the boating community evidently feel that our waterways are one of the last "frontiers" and that their use should remain free of the regulations and reporting that affect so many other activities. In spite of this, from a national perspective the information that is available gives us a reasonable idea of the large-scale characteristics of small boat use in the U.S. and of the potential scope of the impacts that we will be addressing over the next several days.

Vessels registered by propulsion type

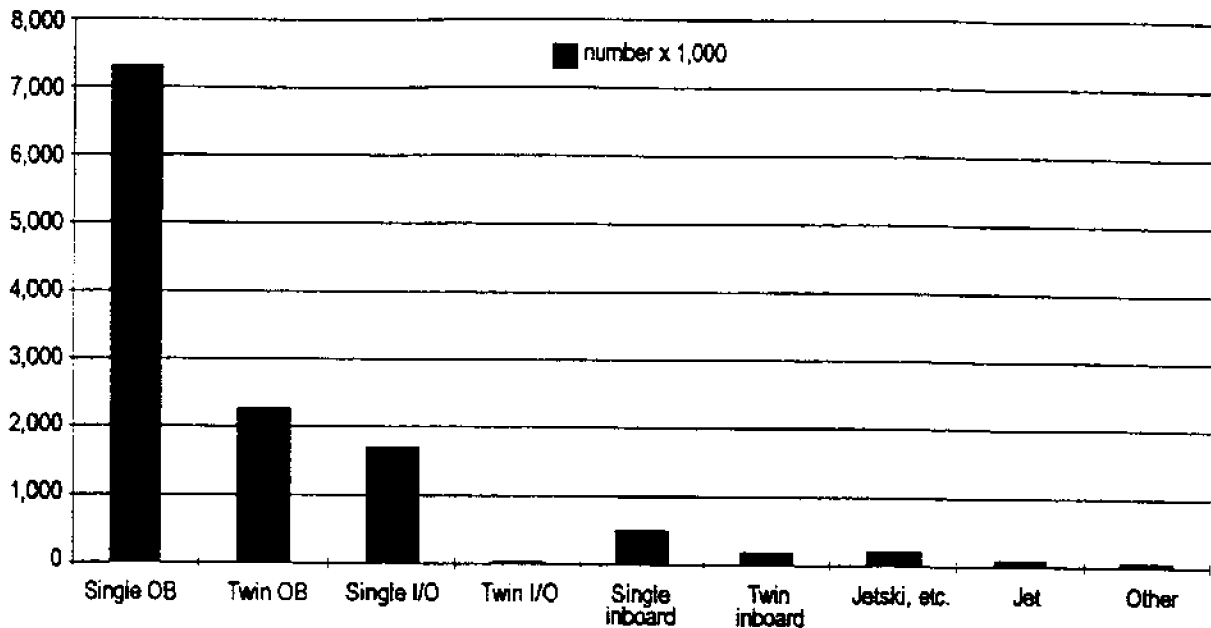

By an overwhelming majority, most powered vessels in the U.S. are driven by outboard motors. Presently about 99% of these motors are two cycle. While outboard motors are generally thought of as being smaller and used either as auxiliary motors on larger boats or as primary propulsion for smaller vessels, they can exceed 200 horsepower and are used - alone or in tandem - to power boats more than 30 feet in length. As the following graph shows, the "average" outboard motor sold in the U.S. in 1989 was 65 horsepower. This is all in marked contrast to the recreational boating picture in Europe, where large engines and 30+ mile an hour speeds are the exception rather than the rule.

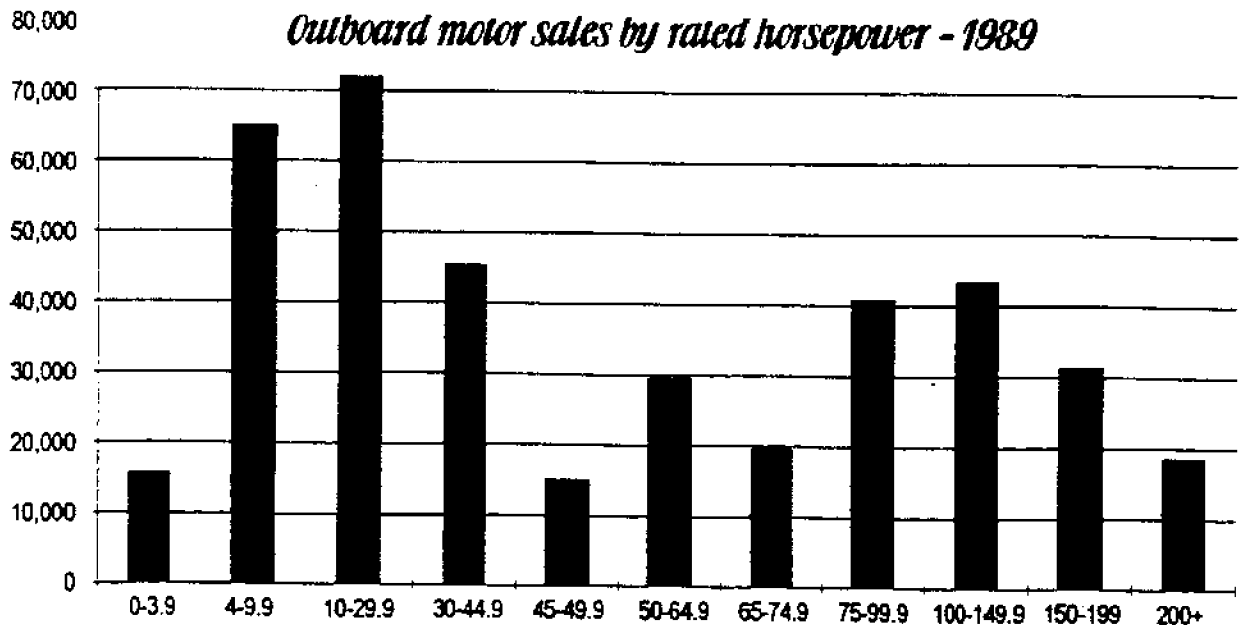

Outboard motor sales for 1989 grouped by horsepower. The "average" size was arrived at by dividing the total horsepower sold by the total number of motors sold.

15
Fleet composition by type - New Jersey/total U.S.

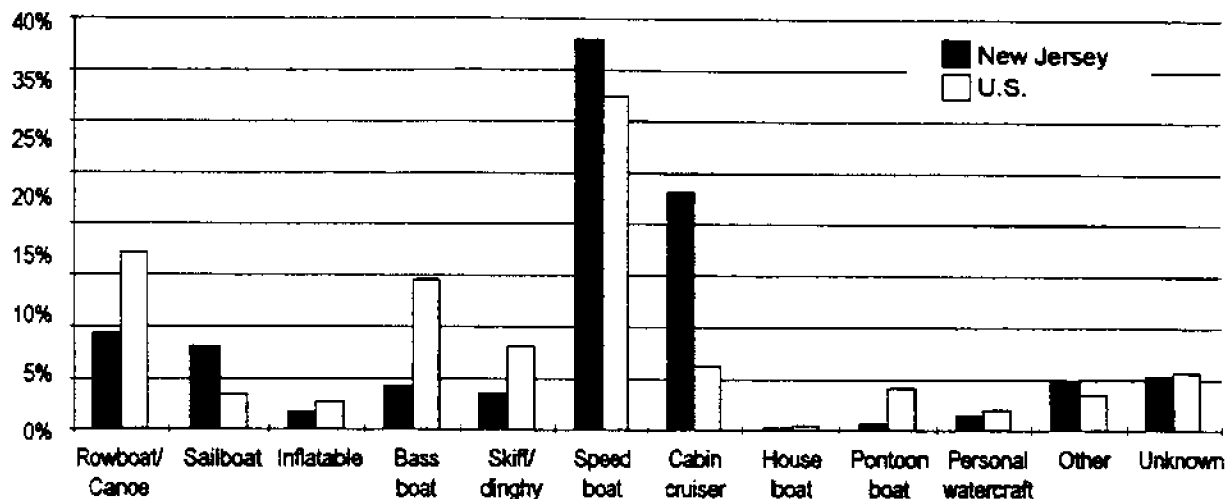

The major variable in the overall character of boating activity in an area seems to relate to coastal (including the Great Lakes)/inland differences. Contrasting the composition of the New Jersey fleet with the national fleet, New Jersey - and I think we can safely assume other states with access to "big" water - has a greater proportion of larger, cabin cruiser types of boats and inland states have a higher proportion of bass boats and rowboats/canoes, vessels that are generally associated with quieter, more sheltered waters.

Vessel distribution by length - New Jersey/total U.S.

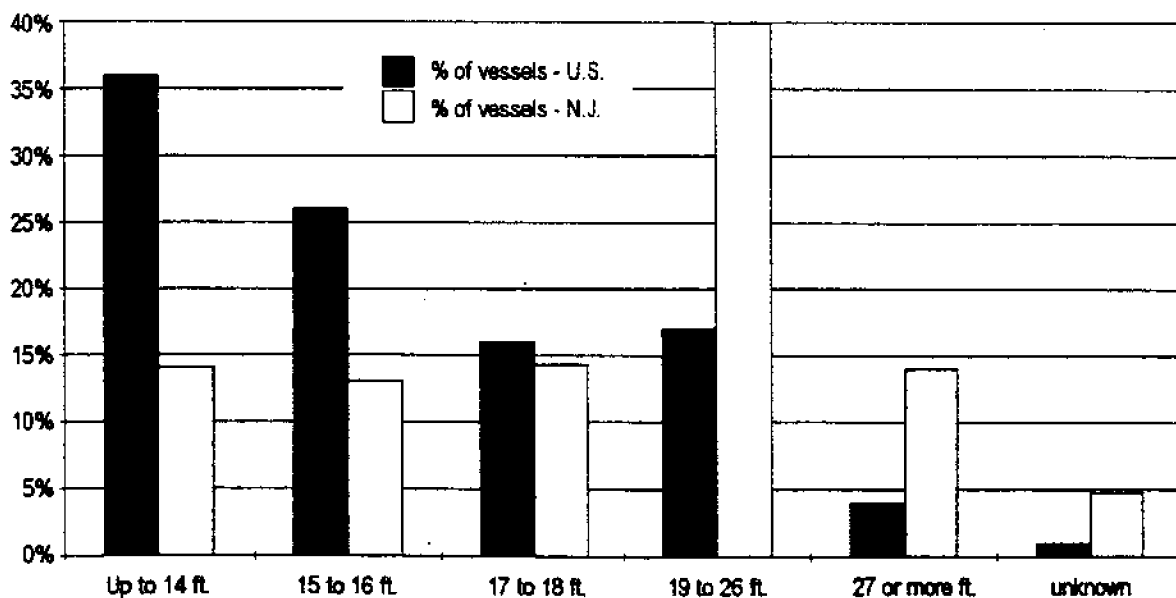

This shows the distribution of vessels grouped by length nationally and, again used as a "typical" coastal state, New Jersey. As would be expected, the distribution is skewed towards larger vessels in the latter and indicates what appears to be the primary difference between inland and coastal - "big" water - boating. It's reasonable to expect that the proportion of larger, more powerful motors is greater in the coastal states as well.

Total vessels Registered - Coastal States

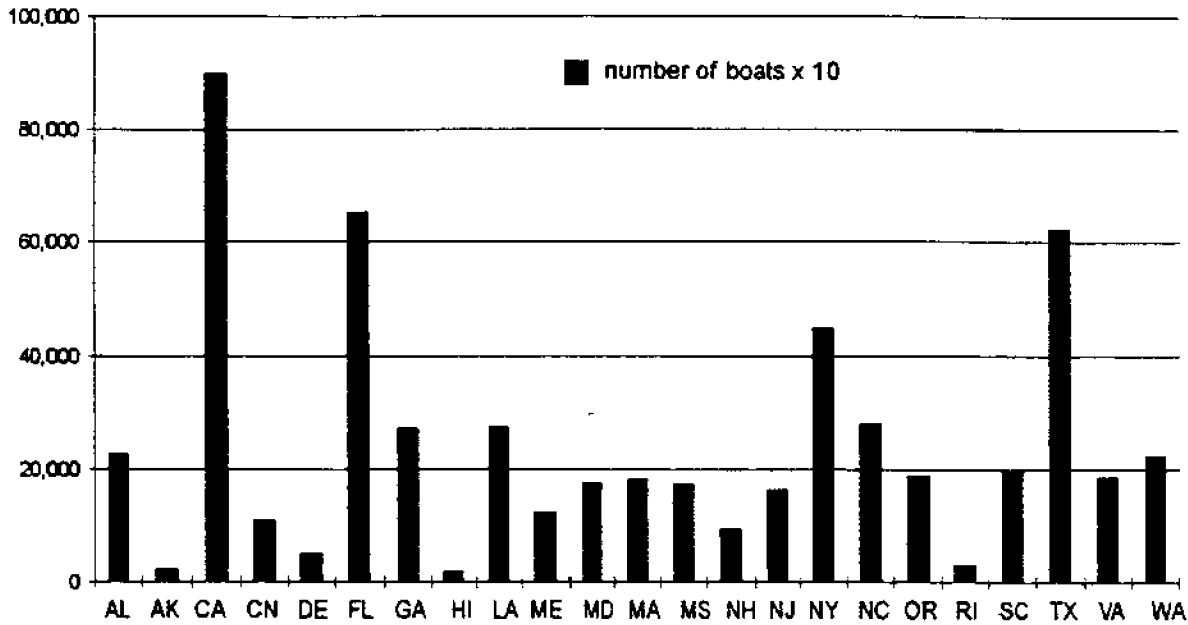

On the coasts recreational vessels seem to be concentrated - not surprisingly - in the states with the longest coastlines or with the easiest access to the coast.

Total vessels registered - Inland States

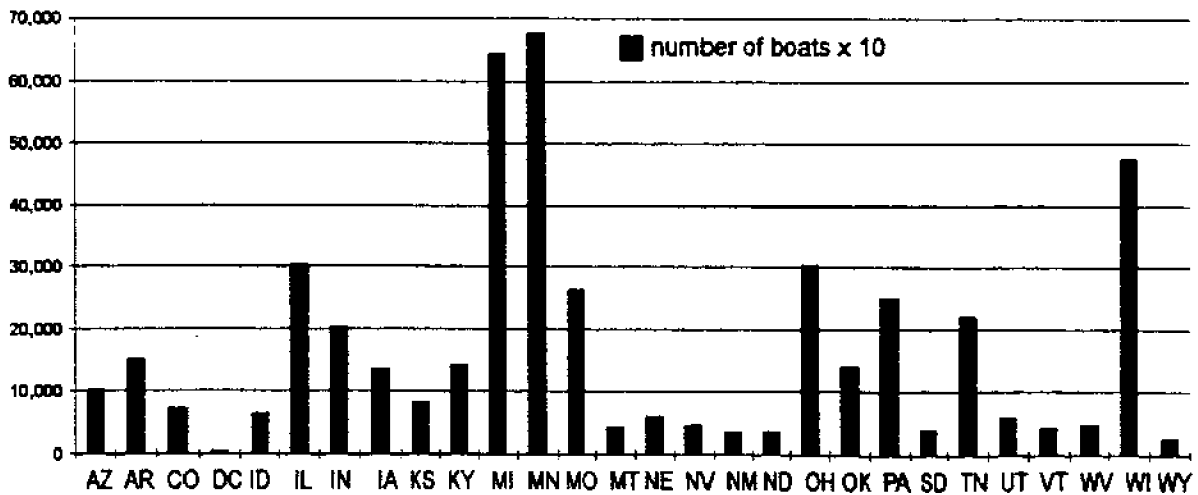

This is the vessel registration for the inland states. There is an obvious concentration in the "lake" states.

Per vessel annual fuel use - Coastal States

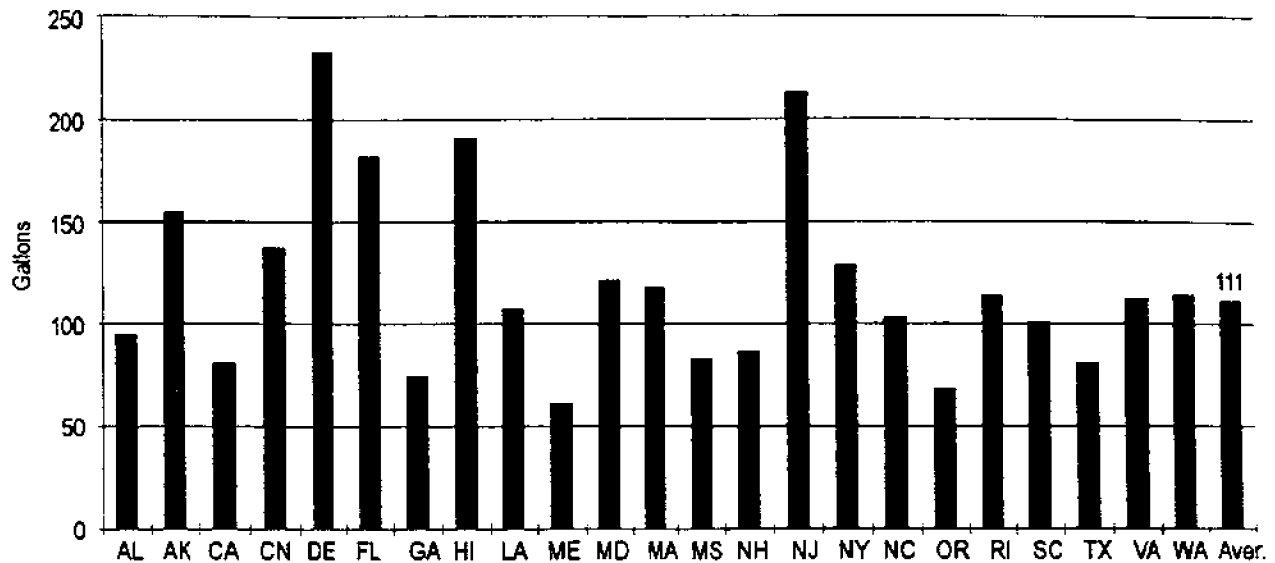

In the coastal states there is quite a bit of variation in average annual fuel use. More significantly, however, compare the 111 gallons per year used in the coastal states to the 72 gallons per year in the inland states. This indicates that either the average engine size, the hours of use or the type of use (or some combination of the three) is different in coastal and inland areas. Considering that the U.S.E.P.A. proposed emissions regulations are based to a certain extent on engine size, this difference might lead to an uneven distribution between the coastal and inland states of the total allowable pollutant loading when the regulations go into effect.

Per vessel annual fuel use - Inland States

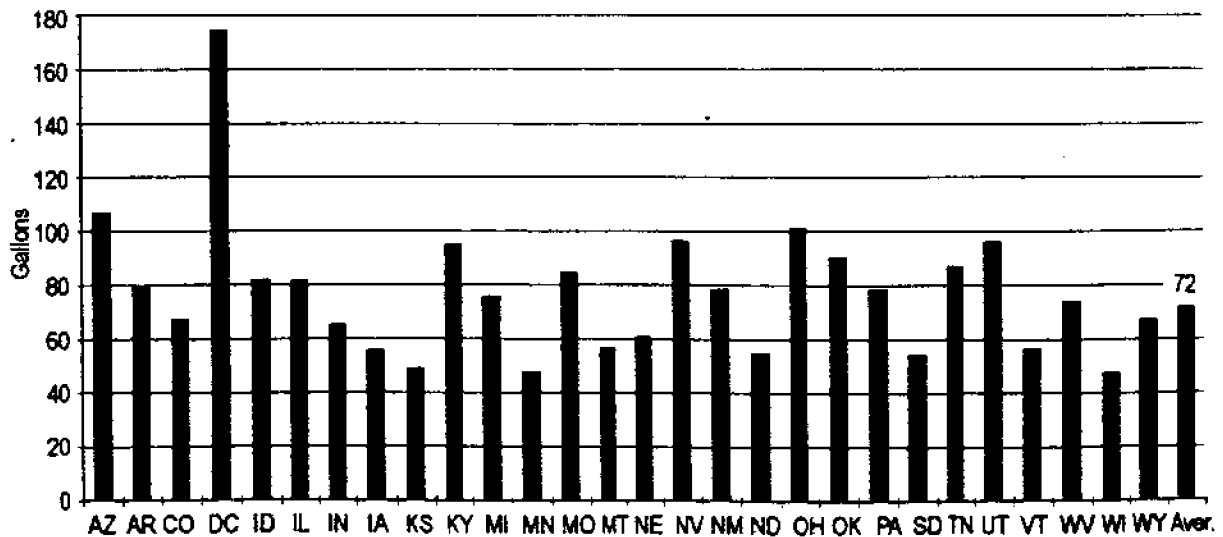

In the inland states, however, the average annual fuel use is fairly uniform (with the very obvious exception of the District of Columbia. This might be a reflection of either larger boats or the necessity to travel farther to reach suitable boating areas). There doesn't seem to be much differentiation between northern and southern states or between those with a lot of boating sites and those with not so many.

18
Annual fuel use¹⁸ by vessel type

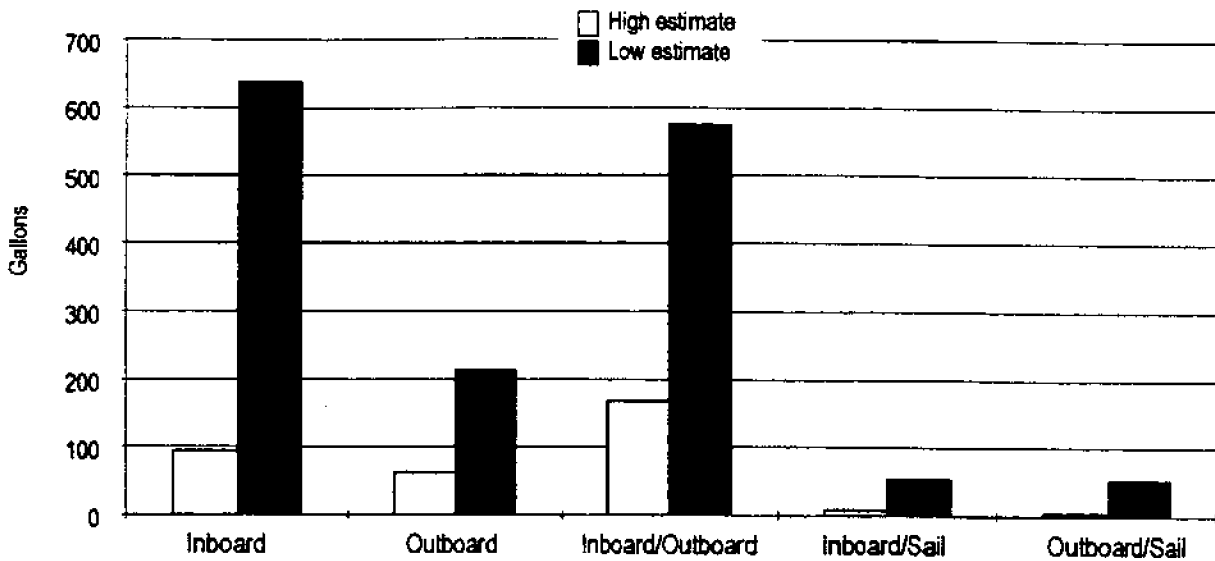

From the U.S.E.P.A. Nonroad Engine Vehicle Emission Study, annual fuel use by vessel type. The difference between the high and low estimates reflects the lack of available hard data that is apparent in virtually every aspect of recreational boating. The largest recreational boats are powered by inboard engines. Because of their larger size, inboard/outboard engines can't be used in the smaller boats, which end up with outboards by default. This difference in vessel size would account for a large part of the fuel use differential.

Average hours of annual use by vessel type - U.S.

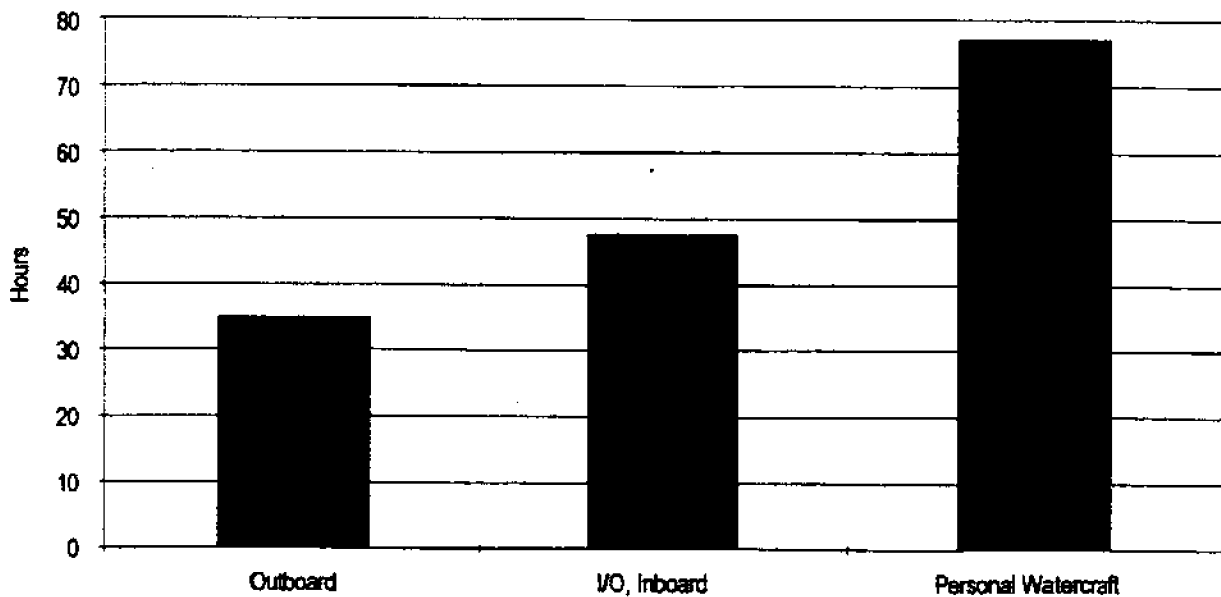

This graph, from U.S.E.P.A. data used to calculate the costs of the proposed marine engine emissions regulations, shows the average annual use of recreational vessels based on the type of propulsion. Of particular interest is the high usage of personal watercraft - particularly when their sales are growing much more rapidly than those of any other type of powered vessel.

Average Vessel Age - total U.S.

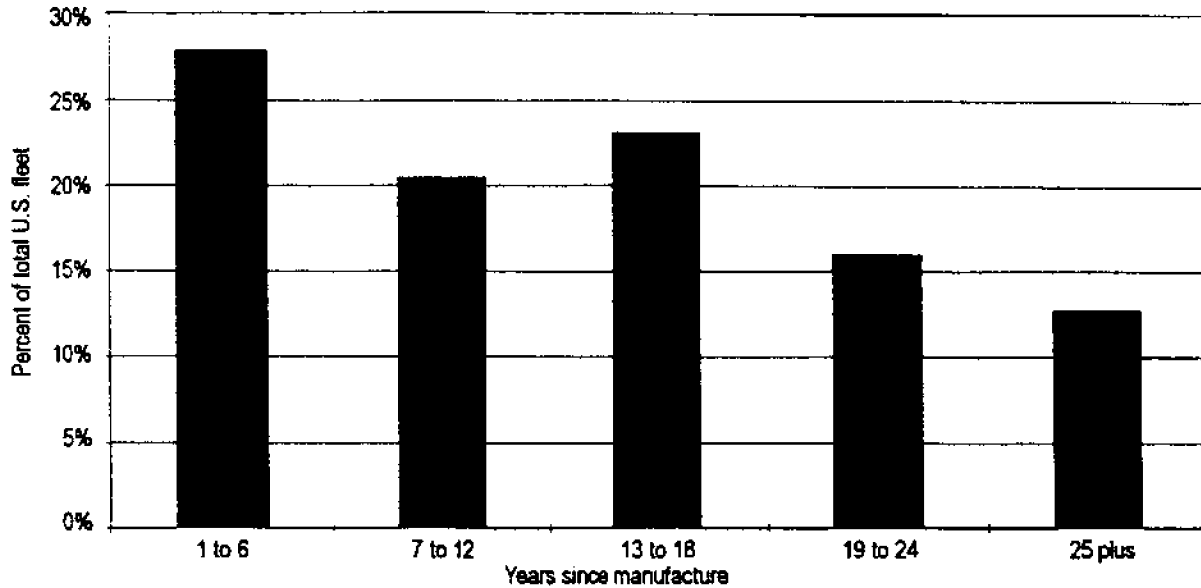

Since fiberglass, which under normal conditions of use is for all intents and purposes indestructible, became the construction material of choice for almost all small boats, the recreational fleet has both aged and expanded. In the proposed Marine Engine Emissions Regulation's Regulatory Impact Analysis, the U.S.E.P.A. assumed a 28 to 54 year life for outboard motors, 40 years for sterndrive and inboard engines and 20 years for personal watercraft engines.

Average vessel age by type - U.S.

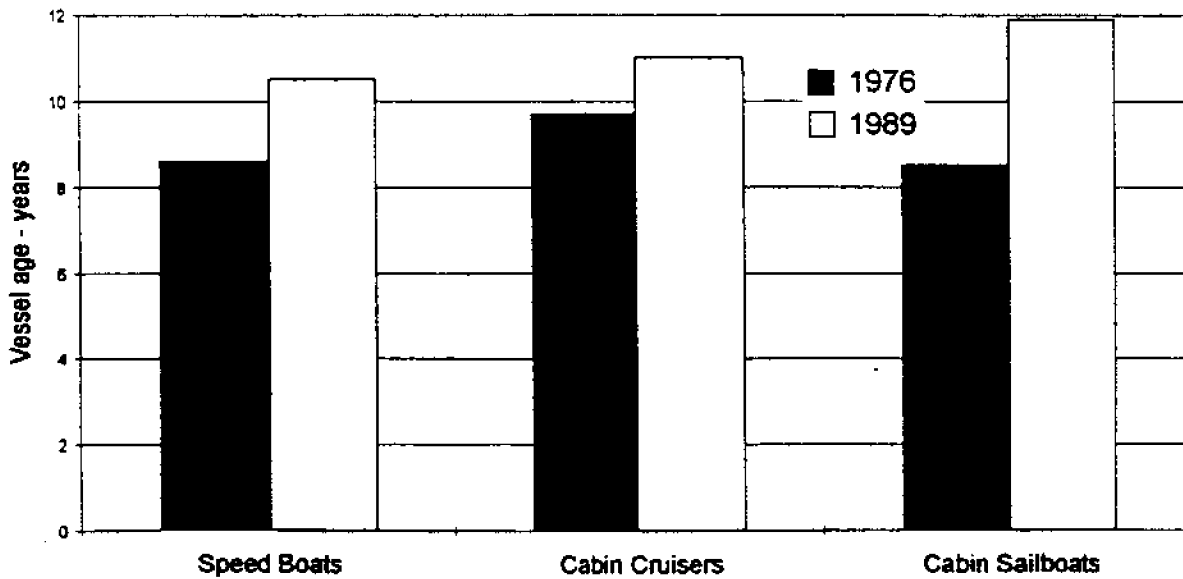

Again from the U.S.E.P.A.'s Regulatory Impact Analysis, this shows a marked increase in the age of the fleet that is probably a reflection of the move to fiberglass (with some possible influence by the prevailing economic conditions). With the resurgence in recreational boat manufacturing over the last several years the average age has probably declined somewhat.

Average number of boating trips per season

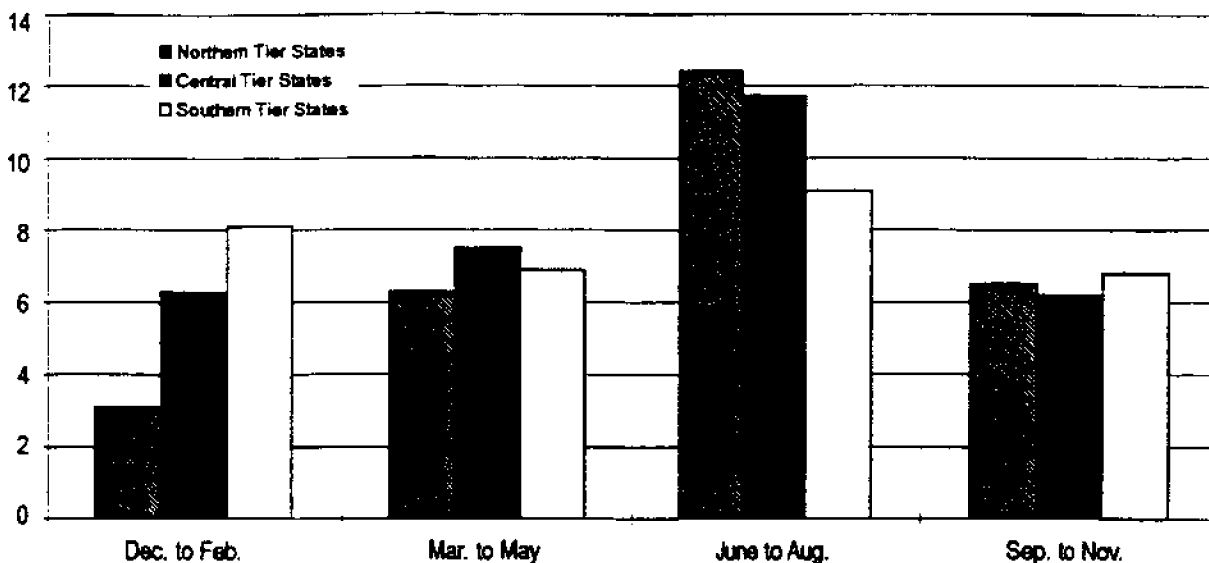

With the exception of an expected minimum in the northern states in the winter, the amount of recreational boating activity reported by the U.S.F.W.S. doesn't vary much from North to South. In the U.S.E.P.A.'s Nonroad Engine and Vehicle Emission Study it was reported that, depending on the region, the summer months accounted for from 48% (West Coast, Southeast, Southwest) to 68 (Northeast) or 70% (Great Lakes) of annual marine equipment use.

Method of vessel launching

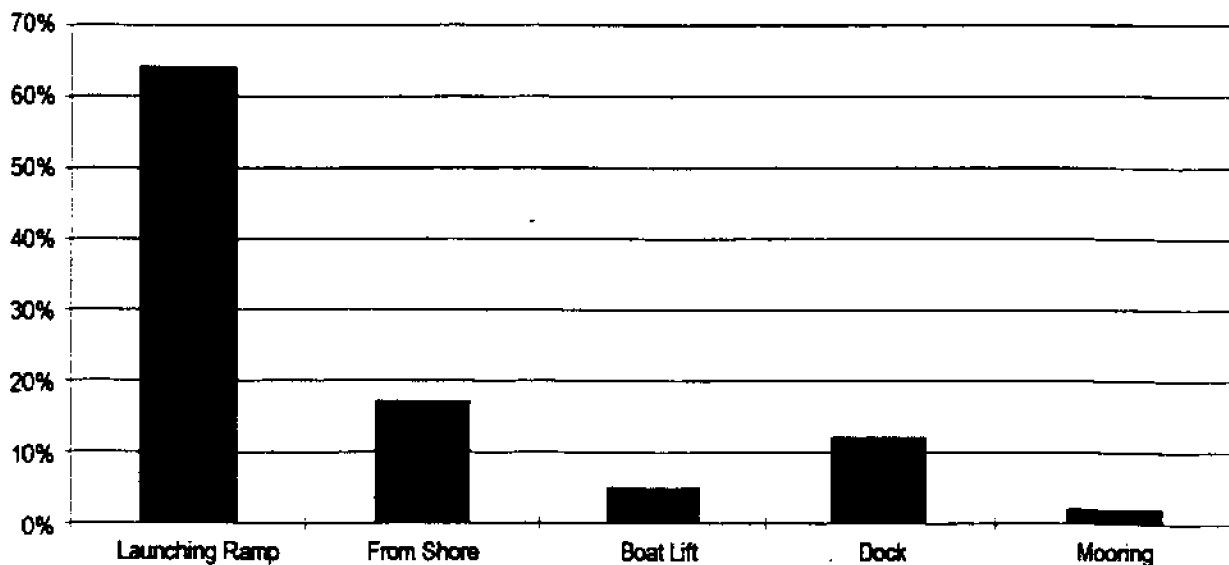

In spite of what we observe in our coastal areas, the greatest number of recreational boats do not stay in the water between use but are launched for every trip. This mobility makes tracking recreational vessel use difficult.

21
Boating quality criteria

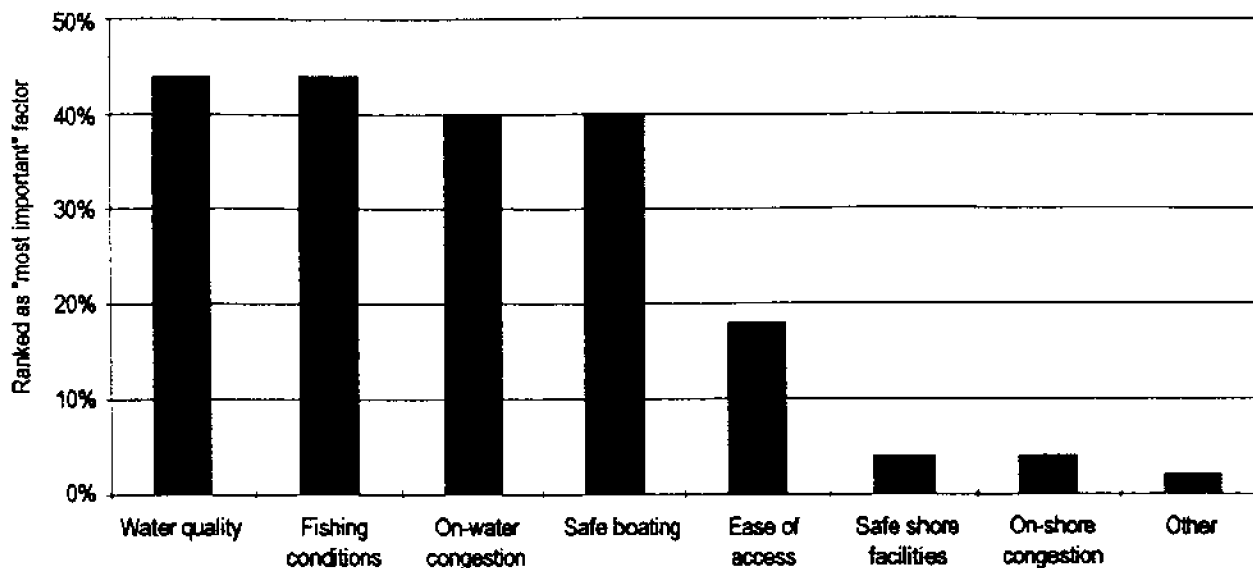

Finally, and again this is from the U.S.F.W.S., these are the factors that the recreational boating public consider the most important in determining the quality of a recreational boating experience.

References:

Morgan, E.J. and R.H. Lincoln, **Duty Cycle for Recreational Marine Engines (901596)**, SAE Technical Paper Series, International Off-Highway & Power plant Congress and Exposition, September, 1990).

Price Waterhouse , **National Recreational Boating Survey: Final Report (for USFWS/USCG, Contract # 14-16-0009-90-006)**, 1992.

USEPA, **Draft Regulatory Impact Analysis - Control of Air Pollution Emission Standards for Nonroad Spark-Ignition Marine Engines**, 1994, Office of Air and Radiation #ANR-443.

USEPA, **Nonroad Engine and Vehicle Emission Study — Report (EPA - 21A - 2001)**, Certification Division, Office of Mobile Sources, November, 1991.

Boating Generated Turbulence

Nils E. Stolpe

3840 Terwood Drive, Doylestown, PA 18901

Turbulence is one of those subjects that everyone seems willing to discuss but few are able to get specific about. What I am going to try to do, rather than directly consider the turbulence generated by the hulls and propellers of operating vessels, is draw some comparisons between vessel operations and turbine/condenser cooling system impacts on the water passed through electrical generating stations.

I am taking this approach because 1) power plant effects on entrained organisms have been well studied and an extensive literature exists, 2) many of us are familiar with power plants and their biological impacts so they provide a familiar reference point, 3) power plant operations are accepted as one of the major negative factors in aquatic, estuarine and marine habitats, and 4) with a few notable exceptions, little work has been done on the biological impacts of hull or propeller passage.

A typical "base load" generating station using once-through cooling — this is pumping ambient water through a heat exchanger to recondense the steam that is produced to drive the turbines — pumps in the neighborhood of one million gallons of water (or three acre-feet) each minute. Damage to organisms entrained in this condenser cooling water is from one of four factors: 1) rapid temperature and pressure changes, 2) physical damage due to contact with the heat exchanger walls, turbine/pump chamber or blades, 3) cavitation of the pump/turbine blades, or 4) biocides used to remove fouling organisms from the water passages.

Physical damage, principally occurring during passage through the pump/turbine, has been reported as the major cause of entrainment mortality during normal power plant operations. Cavitation is avoided to as large an extent as is possible in generating stations because of its effect on operating efficiency and accelerated materials deterioration. However, when cavitation does occur, it has been shown to be a major source of injury for the entrained organisms. Turbulent flow velocities in power plants have been reported at from 3 to 12 meters per second nearest the turbine blades (Cada, 1990). Exposure to lesser velocities has been shown to be lethal to entrained fish larvae (Payne et al., 1990).

Outboard motors have propellers that are typically 13 or 14 inches in diameter. The 14 inch diameter propellers in the larger engines sweep an area of about one square foot. At 30 miles per hour vessel speed, a 14 inch propeller directly passes through about 150,000 cubic feet (for convenience, rounded off to 1 million gallons) during every hour of operation. At 30 miles per hour, the hull of a boat with an eight foot beam contacts almost 30 acres of water surface per hour.

It is clear that during normal operations a single outboard powered vessel impacts a fairly significant amount of water.

At an engine speed of 5000 rpm and a propeller speed of 2500 rpm (non-racing outboard motors are geared at 2:1), a point on the periphery of a 14 inch propeller blade is moving through the water at a velocity in excess of 100 miles per hour. Propellers on outboard and inboard/outboard marine engines are described as "cavitating propellers" and are designed to operate while cavitating. It appears as if the magnitude of mechanical and hydraulic forces resulting from electrical generation—forces which have been shown to be injurious or lethal to entrained organisms—might be approximated during normal boating operations.

A consideration here is that laboratory data dealing with hydraulic effects on living organisms are notoriously difficult to relate to the real world (Cada, 1990). While some work has been done on the effects of commercial river traffic on ichthyoplankton, operating characteristics of commercial vessels are not similar to recreational vessels.

From a real world perspective, I decided to look at how much water could be impacted by normal recreational boating activity. Being a fairly well studied body of water, and being conveniently located for me, I choose Barnegat Bay, New Jersey. Barnegat Bay is a large, shallow estuary lying behind New Jersey's barrier islands. Being approximately 40 miles long and approaching 5 miles at the widest, it has an area of 47,615 acres. With an average depth of 4.6 feet, it has a total volume of about 220,000 acre feet. Because of the shallow depths, much of the bay used to be unavailable to boaters. With the advent of personal watercraft, this is no longer the case.

The surrounding area is heavily developed. In 1986, 38 percent of the land within 150 feet of the estuary was covered by impervious surfaces, primarily residential. The bay has more than 200 commercial marinas with the capacity for storing 12,000 boats on racks or in the water and there are an unknown number of boat slips associated with private homes on the estuary. There are 45 launching ramps on the bay. It has been estimated that 53,000 vessels, 90 percent of which are power boats, use Barnegat Bay each year.

There is also a nuclear power plant—General Public Utility's Oyster Creek Plant—located on one of the bay's tributaries. The plant uses once-through cooling. Like other (generally nuclear) power plants, Oyster Creek has been the occasional target of environmentalists and it has been suggested, sometimes strenuously, that a cooling tower should be installed there to prevent the entrainment/impingement (and thermal) effects the plant is having on the Barnegat Bay.

The Oyster Creek plant pumps about 1 million gallons of bay water a minute—three acre feet—for condenser cooling. All of Barnegat Bay's water could pass through the Oyster Creek plant in about 50 days. The New Jersey Department of Environmental Protection and Energy has calculated that 6,000 boats can "comfortably use Barnegat Bay at any one time." Assuming that

5,000 of them are powered vessels capable of cruising at 30 miles an hour, during every hour of combined operation the propellers of those boats would pass through 17,000 acre feet of water. They would impact a volume of water equivalent to the bay's total volume in 14 hours of combined operation. Again at 30 miles an hour, their hulls would contact 150,000 acres of surface water in an hour of combined operation, passing over an area equal to the bay's in about 20 minutes.

Does this mean that boating activity is having a greater negative impact on Barnegat Bay than the Oyster Creek generating station? Definitely not. We do not know what effects, if any, the physical disturbances by what appear to be very intensive boating activities are having on the water column or the surface layer of the bay. But the possible magnitude of those disturbances seems great enough to warrant a closer look.

No questions were asked of the speaker.

Boating Impacts From An Environmentalist's Perspective

Dery Bennett

American Littoral Society, Sandy Hook, Highlands, NJ

I am delighted that we are together, and I am just going to take a minute or so to say that the environmental community, which I can not speak for but which I am part of, is interested in this workshop. Coastal environmental groups are particularly interested in nonpoint sources—of which I think this is a major one—in part because other point sources are better known and some of them are under control. Certainly the coast is getting an increase in population, given the numbers of people that are moving to the shore. There is a great freedom on the water. You do not need a license; all you need is enough money to buy a boat. They tell you how to push the button to start it—this is forward and this is reverse—and you can go 70 miles an hour and they do not yell at you.

There are obvious impacts. Our offices are at Sandy Hook so we are in the New Jersey boating traffic area. Many of the calls that we get in the office are about boats. Primarily they have to do with jet skis and noise; it is a conflict of too many people trying to use the waterways. The oil pollution, gasoline, air problems, are less well known. Thanks, in part, to Mr. Mele's book, I think they are becoming more known, and certainly the manufacturers know that they are an issue.

I wanted to confirm Michael Moore's statements earlier. A number of us spent time on the telephone with motor makers to try [to no avail] to get them here. We explained to them that we were not going to rip their lips off, that we were going to be talking about some basic questions, and it would be much better if they were there at the very beginning rather than playing catch-up with the information that comes from this group.

The American Littoral Society and other environmental groups are primarily interested in protecting coastal habitat, and you will hear talk today about how productive near-shore water is and how it is vital for various stages of marine life. Seventy percent of the fish we catch for food or fun depend on the estuary and the coastal waters for their survival at one time or another. Either they are spawned there or they use it as a nursery. Water fowl, shore and wading birds, shellfish, and crustaceans use estuarine habitat. We visit it with boats—and I think we are beginning to visit it in huge numbers with great impacts that are insidious, subtle, sublethal, and of great concern.

Groups like ours can listen to the discussion and get as knowledgeable as we can. And then we can use the information to educate the public to get them concerned and help them understand the issue and then help them work this through the process, whether it is regulatory or legislative.

But in arguments and discussions like this, as we go through the process to try to regulate, it is very important that we be able to deal with the facts. One of the frustrations that environmental

groups have is “why don’t you scientists give us the facts fast and straightforward so that we can use them tomorrow to beat people over the head with.” In fact, some of us would say, “why don’t you beat people over the head with it yourselves.” But we understand that the job of science is to produce the information, and then the rest of us will help to try to figure out a way to make an impact on the decision makers. So I am looking forward to the session from the environmental and coastal-waters points of view. We think the topic of this workshop is very important and we want to help you where we can.

No questions were asked of the speaker.

Anthropogenic Effects of Boating Activities

Peddrick Weis

University of Medicine & Dentistry of New Jersey, Newark, NJ

We saw a slide yesterday morning shown by Jim Joseph. It was an aerial view of part of the New Jersey shoreline showing development of lagoons, canals, and former wetlands, so that a lot of people can have second homes and step directly from their living rooms into a boat without getting sand on their feet. They tend to build structures to make the boat more accessible. This slide shown here was taken on the Florida Gulf Coast, where they tend to hoist their smaller boats up out of the water when they are not in use. This avoids one particular problem associated with boats, and which has been barely touched upon in this workshop, anti-fouling paint on the bottom. If a comparable picture were taken here in New England, the boat would be in the water in the summertime and would have that additional impact.

What we usually see is wood structures, like this bulkhead here, and pilings supporting a dock. This has physical effects on the environment such as a shadowing. There is no sunlight penetrating to part of the aquatic habitat underneath it. Where there used to be an intertidal zone of a more gradual nature, either a salt marsh or a sandy area, now we have a vertical hard substrate replacing the original sloping soft substrate. So obviously the intertidal ecology has been altered by necessity. On the other hand some people will say now we have a reef effect. Well, that is quite true; the pilings have been doing that.

One problem associated with this most popular of construction materials, wood, is that it is attacked by fungus and borers, especially fungus, so that within a couple of years, a piling is substantially weakened and has to be replaced. So we protect wood for use out of doors. Traditionally this was done with creosote. Creosote is coal tar derivatives full of polycyclic aromatic hydrocarbons: very carcinogenic material. Pentachlorophenol has some terrestrial uses as a wood preservative but does not work out terribly well in water. Chromated copper arsenate (CCA), which makes wood green, is the preferable wood treatment nowadays. About 95 percent of wood preservation treatment today is CCA.

This treated wood is called pressurized or pressure-treated wood because the treatment system involves a huge pressure cooker where large batches of lumber are introduced into a large vat and under controlled pressure and temperature the CCA is impregnated into the wood over a 24 hour period.

Two and one half pounds of CCA per cubic foot of wood is the impregnation in the outer inch of the wood, that which is in direct contact with the aquatic environment. This translates metrically to 40 grams per 1000 ml. Less CCA gets into the innermost regions of the wood.

The wood preserving industry had always maintained that the material does not leach when it is properly processed. So we put some pieces of treated wood into closed aquaria or beakers with various types of organisms in them and found tremendously toxic effects in these closed artificial system, in vitro. Obviously there is a problem there so we decided to go out into the field. For the past five years my wife and I have been studying construction materials in the marine environment. What I will present to you today is a summary of field studies done in the vicinity of treated wood structures, docks and bulkheads.

Let us look at some barnacles that are on treated bulkheads on either side of a residential canal. On one side of this canal is a CCA bulkhead approximately seven years old. On the other side of this 25 year old canal is an original creosote treated bulkhead. In each case there is a large vessel tied up about one meter away from where I plucked off the barnacles. Their soft tissues had about three times as much arsenic on the CCA side as on the creosote side. There was less than the minimum detection level of chromium in the creosote side compared to what was on the CCA side. There was not such a substantial difference between copper on the two sides. This probably was related to leachates from the copper-based anti-fouling paints on the nearby boat vessels, but copper was still elevated on the CCA side. The shells receive about eleven times more arsenic on the CCA side and five times more chromium. As in the soft tissues, there was significantly more arsenic but not so many times more than the chromium, possibly because of the nearby boats.

If we have a wooden structure in the water, we have leachates coming out that either be taken up by barnacles, algae or snails living directly on the wood, or go directly out into the water. The tidal regimen determines the dilution effect. What we usually find with pollutants in water, in general, is that they go down into the sediments and the fine particles of the sediments act as a reservoir for almost anything because of the adsorptive capacity of the silt and clay. Whatever is taken up by organisms can be trophically transferred to a higher level. What is in the sediments will impact our deposit feeders. Biological as well as physical turbation will remove some material from the sediment back into the waterway.

In Pensacola Bay there is only one tidal cycle per day, and it is not a very strong one. Once a month, for two or three days, with the full moon, there are two tidal cycles per day. However, the tidal fluctuation is only about one inch at that time. If we look at the metals that end up in the sediments related to distance from the bulkhead in the end of the canal, the copper tends to remain high. Of course, there are boats parked in the canal, so we do not see the same distribution for copper in relation to the side of the bulkhead as we do for chromium and arsenic. But in our tests, these other metals do slope off as we get more distance from the bulkhead, going towards the other end of this canal where there was no structure.

Notice the starting points, between 300–400 $\mu\text{g/g}$ for chromium and copper and less than 200 $\mu\text{g/g}$ for arsenic. If we look at the bulkhead facing the open water where there is tidal

exchange, concentrations drop off not linearly for chromium and arsenic as you saw before but in a more hyperbolic fashion. Although the starting points are about the same, the copper is also dropping off. So by the time we got out to ten meters, it is not significantly different from what we found in the reference area two kilometers away.

In the sea cucumber, a deposit feeder, the one element that we could find in substantial amounts is copper, and it parallels the amount of copper that is in the sediments. If we look at the levels of copper and arsenic in the deposit feeding worm, *Neanthes*, we see that they drop off more rapidly. By three meters they are not significantly different from the reference point. But the worms that are living right next to this open-water bulkhead, nevertheless have substantially elevated levels.

At any rate, it does not matter whether you are in a dead-end canal that is fairly stagnant or out in open water. If you are a deposit-feeding organism living next to a bulkhead, the levels you are exposed to are still very high.

Juvenile fish came into the canal when they were about two or three weeks old. This is the amount of material we found, even though they had only been there temporarily because they are juveniles. The difference was substantial between those collected at the reference site and those living in the canal. In the canal we saw elevated levels of chromium and arsenic.

Out in the "healthy" reference area there is a whole mixture of different kinds of worms that we find in the sediment, as well as the occasional bivalve. The number of species by the bulkhead inside the canal is only two, compared to about five or six near the open bulkhead and about 12 kinds of worms and other benthic organisms typically found at the reference site. The number of individuals is also much higher at the reference site, yielding a Shannon-Wiener diversity index of about 2.6. When you get up above two on the diversity index, then we feel we have an unimpacted area. The open-water bulkhead is somewhat impacted and the end of the dead-end canal—the cul-de-sac—is definitely impacted by all three parameters. The total amount of biomass is way down.

The common oyster is copper resistant. It sequesters copper and zinc. If we look at the oysters on the single pilings of the open-water dock, the copper level is somewhat elevated. When we get down into the canal, however, it is tremendously elevated, running up towards 200 parts per million—somewhat less than that in January and somewhat more in warmer weather, in May. Some new pilings had been put in the year before so we tested one-year old oysters from the new pilings in May and found that they were even higher yet. New wood presumably has not leached so much yet; it is in the process of losing its greatest amount when first deployed.

If we look at these oysters [slide], you see that they are a bit green about the gills. This is copper-rich as opposed to the normal creamy beige color that you have with a reference oyster. This [slide] is a cross-section of the digestive gland in a normal oyster. The cells are very tall; if

they are slightly impacted, as with nonspecific response, they are not as tall as they are when they are completely healthy. Less healthy cells are shorter and some are sloughed off into the lumen of the digestive gland. Most of the reference oysters were in this condition [slide showing tall cells], most of them were A's, with a few B's [a descriptive scale of pathology]. The oysters living on the bulkhead in the canal tended to average closer to C's—some B's and a lot of C's type of digestive gland pathology—suggesting that they are impacted. However, their condition index was quite good and they moved into the reproductive state quite well. So I am really not sure what all this means as far as that pathology is concerned.

We also ran an experiment on trophic transfer through the food web. We used two aquariums with a divider in the middle to provide replicates. We did this twice. Oysters were collected from the bulkhead and placed into each aquarium in the front half and reference oysters in the back half on the other side of the divider. Oyster drills were then introduced. Within three weeks we started to see differences in the feeding rates of the drills. They did not like the copper rich oysters as much and were not feeding as much. They were not gaining as much weight and they picked up a lot more copper, needless to say.

So there is apparently a lot of movement of copper and arsenic and little to none of the chromium out of the bulkhead into the food web. But when we looked at individual pilings in moving water, we did not see such an effect. We have shown you how animals living on the bulkhead pick up a lot of stuff. It is moved trophically up through the food web. The benthic organisms are heavily impacted.

In the interest of time, I will change my plans and will end my talk here rather than present results of another experiment that we ran where we put experimental panels in the water to see what kind of community develops on different materials, including lumber made from recycled plastic as an alternative construction material.

Q (by Dery Bennett) This is a comment more than a question and it applies to what Andy was covering too. As an environmental group, we hear information like this and we want to use this to work on regulators and legislators to get them to change their way of doing things. And their general reaction is, "So what." You are talking about oyster drills turning green, and we are talking about jobs and pleasure. People have got to get out and enjoy themselves and what you are talking about is minor.

A (by Peddrick Weis) Well, perhaps it is minor. On the other hand, there is a significant ecosystem out in these estuaries that have been turned into second home areas. Jim Joseph showed yesterday how many different organisms are using estuaries for their juvenile or embryonic stages. We are altering their environment substantially. Maybe it is not necessary to have bulkheads. Maybe small docks would be sufficient. And that is pretty much what is going

on in South Carolina. It is not necessary to alter the environment that much. And if we do alter it, maybe there are alternative construction materials. I showed you an aluminum bulkhead. I mentioned that we have looked at recycled plastic material as well which has relatively nontoxic effects — still with the physical effects, but not the toxic effects at least.

Q (by Bruce Carlisle) I had a quick question in regards to your benthic diversity index. Is that something that you developed yourself?

A No. The Shannon-Wiener Index is commonly used. That is a traditional method.

Q For marine benthic communities?

A I do not know how specific that is, frankly, or if it is a general thing. My wife is the ecologist. I am the chemist. I do not even know how she derives the formula. She sits down with a calculator and she works it all out.

Q (Ellie Dorsey) I would like to make another response to Dery's earlier question about "So what." It looks to me like there is a real potential for a public health hazard here. If you have oysters that people like to eat on pilings, which are very easy to reach, that are green with elevated levels of copper, I think that is a problem, not to mention whatever materials are transported farther away from the bulkheads.

A Well, for mammals, copper is not that much of a problem. For marine organisms, copper is highly toxic. The arsenic is a problem too, but the arsenic that ends up in marine organisms is organic arsenic: arsenol, betaine, trimethyl arsine, and so forth, which are hardly assimilated by us at all. They just pass right through our guts. So that is not necessarily a human health problem in general, okay?

Boating Impacts On Seagrass Habitats In Florida

Curtis Kruer

P.O. Box 420334, Summerland Key, Florida

(Editors' note: This talk relied heavily on slides depicting boating impacts. The references to specific slides (indicated by '[slide]') have been retained since the narrative gives a good feeling for the impacts that were illustrated, although references to each of the many dramatic slides of turtle grass damage that were shown have been partially aggregated.)

My talk will focus on a subject that we have not heard too much about, but one that has become a serious issue in coastal Florida in recent years. The boating impacts from propeller scarring and propeller dredging of seagrasses (Figure 1.) are now considered by the state agency that manages resources in Florida to be among the most significant threats to that state's remaining seagrass areas.

The Florida Marine Research Institute has addressed this problem, and they have provided some of the information I will present today. Robin Lewis of Lewis Environmental Services of Tampa and Summerland Key, an associate of mine who has been actively involved in this problem, has also contributed to today's presentation.

I have worked for 17 years in the Florida Keys, much of that as an employee of state and federal agencies and as a consultant for the part six years. I am going to use my work in the Florida Keys as an example of the problem in coastal Florida and then touch on some recent assessments I have been involved in with state agencies. I will concentrate on physical impacts and touch on disturbance of the fish and birds which make extensive use of shallow water. You cannot single out any one user group or any one type of vessel. The problem is caused by boats as small as jet skis and personal watercraft, that can literally run in a few inches of water on seagrass flats, as well as by large commercial and pleasure craft. I will discuss some management strategies that we are trying to put in place by working with both state and federal agencies and, if time permits, review some research needs.

As it is in much of coastal America, the Florida coastal population is booming. The state's population doubled to 13 million people from 1970 to 1990. During that same period, the number of boats tripled to 715,000; currently there are over 800,000 registered boats in Florida.

This [slide] is an aerial photograph of a typical shallow water area in the Florida Keys. The light brown and light green colors indicate shallow water. These are intertidal seagrass flats, mostly *Thalassia* or turtle grass, surrounding mangrove islands in the lower keys. You can

imagine how difficult it is to navigate through areas like these, particularly during low or poor light conditions, and especially if you do not know anything about boats or navigation.

There are three species of seagrass pertinent to my talk. Turtle grass, *Thalassia*, is the dominant seagrass in southern Florida. There are two other seagrasses in Florida: *Syringodium* or manatee grass; and *Halodule* or Cuban shoalgrass. It can take decades for mature *Thalassia* beds to form. Areas where the seagrasses are found are classified as wetland habitat, and are supposed to be regulated as such by state and federal agencies. Their deep-rooted rhizome system make seagrasses very important in stabilizing bottom sediments, particularly the fine materials that would otherwise be resuspended by wave and current action. They form the basis for the food web in the clear water systems. They also provide important nursery habitats for many species. Larval and juvenile forms of fishes and invertebrates find protection in seagrass beds and many species of fish and birds use these areas as feeding sites. Disturbance of the seagrass beds at the level we are seeing in southern Florida diminishes their ecological value and their productivity, affecting the entire ecosystem.

Seagrasses occur to a depth of about 30 feet in south Florida, but those in deeper water are only slightly impacted, if at all, by boats. I will be talking mostly about shallow water seagrasses. We focused on areas generally shallower than six feet, although I have documented turbulence and turbidity in depths up to eight to nine feet from large commercial vessels hauling a lot of heavy traps or other heavy loads.

Wading and other birds make extensive use of shallow water seagrasses in Florida; snowy egrets, little blue herons, ibis and tri-colored herons all feed in seagrass beds. A number of migratory birds, some of them threatened, use these areas as they migrate north and south. In south Florida and in the keys, bonefish, tarpon, a number of small sharks, barracuda, redfish, snappers and groupers are all associated with shallow water seagrasses. Given all of these examples, the shallow seagrass areas in South Florida are the basis of a unique habitat, one that should be protected from the impacts of unregulated boating.

Seagrass beds are very fragile. We also know that they are very slow to recover from propeller scarring. [Hereafter, the word 'propeller' will be written as 'prop', the abbreviation often used in discussions of boating impacts.] *Thalassia* can take four to six years to recolonize a prop scar resulting from a boat that was run through water that was too shallow. In shallow water, the lower unit and prop of an outboard or inboard- outboard will carve a trench through the bottom. One part of the problem is that as coastal Florida and the keys become more heavily developed and the inhabitants more affluent, boats of the recreational fleet get larger and, as we have heard in previous presentations, more powerful. There are much larger outboards on the market now than there were just five or ten years ago, and the water is not really getting much deeper.

This is an area in the lower keys [slide], about four feet deep, over healthy turtle grass. These are two commercial boats that on a daily basis plow their way through the area leaving these sediment plumes. This occurs during the times of the year when they haul lobster and stone crab traps. You can follow the plumes for miles. Sometimes they are just caused by light sediments kicked up off the bottom. Other times the bottoms are perturbed to the point that the seagrasses are displaced and you can see blades, short shoots and rhizomes floating to the surface in the wake.

This [slide] is what it looks like from the water. The large vessel in the background is very much out of place in this very shallow area. You can see the turbid plume and the seagrass floating on the surface (most seagrass species float when they are displaced naturally or by boats). If you can see seagrass floating to the surface behind a boat, you know the boat's prop is dredging or scarring.

This [slide] is an illegal channel that was begun sometime around 1989. It was marked with illegal channel markers. (This is another problem in coastal Florida. Only the people placing the aids know what is intended by them and know what type of boats should run through the area, but they are invariably used by more and more boats.) In a period of five years the channel has grown to be about 2,000 feet long and 10 to 15 feet wide. There has been no attempt to enforce the regulations preventing this kind of activity. Government tends to be very slow to deal with these problems.

Unfortunately this [slide] is a typical aerial view in the Florida Keys today. This is one of the worst but I could show you hundreds of other examples. This slide was taken in 1987 near a heavily traveled area in the upper keys around Islamorada, the self-proclaimed "sportfishing capital" of the world. This next slide was taken last year, six years after the first. If you note the bank at the edge of this channel you can see how much it has expanded. This was caused by jet skis from several nearby rental businesses. Jet skis are capable of running through extremely shallow water. These are intertidal flats, out of the water during low tide, covered by a foot of water during high tides. This corner of the channel is disappearing; the edge is disappearing. Seagrass along this edge of the bank is disappearing too. The bank will become increasingly prone to storm damage as this type of impact continues.

This [slide] is a view of the Intercoastal Waterway where it passes through the keys. The waterway forms the boundary between Everglades Park and Florida Bay and is heavily traveled by large vessels. The channel is marked by a series of day markers that are maintained by the Coast Guard. The problem is, as you can see, even when you have well marked channels, the areas adjacent to the channel on the order of three, four, five feet deep have many twin-prop scars. Large vessels do not stay in the channel either.

This [slide] is a channel that was the subject of a federal court case in 1981. A marine contractor was replacing one of the overseas highway bridges in the lower Keys. The marine

construction tugs that were used on the project were much too deep for the depth of water at the site so they ended up digging a 'channel' about 2,000 feet long that averaged 50 to 75 feet wide. The court ruled that prop dredging associated with boating impacts of this type are subject to regulation by both state and federal agencies and that boats and vessels are a point source of pollution when it comes to turbidity, which is regulated under state and federal law as a water quality violation.

Experts for the contractor testified that the impacted area would revert to its natural state in a matter of years. It does not look much different today, 13 years later. The currents have been altered and much of the area has been eroded to the natural rock. The natural communities with soft corals, sponges and macroalgae and the banks of seagrass are gone.

Both commercial and residential establishments on the shoreline contribute to bottom destruction caused by boating. This [slide] residence on one of the lower keys with a shallow water dock that was probably constructed without a permit. The channel leading to it from deeper water was made by prop dredging. The spoils from the dredging have been displaced on either side of the channel, impacting more of the bottom. The area that the channel goes through is a healthy *Thalassia* and mangrove shoreline. While there are now standards to limit dock placement to deep water, there are many old docks in the Florida Keys and this type of activity is fairly typical.

This [slide] is an old marina in Islamorada. Guides—'flats guides'—who are hired by recreational fishermen in pursuit of species that frequent the flats, particularly bonefish and tarpon, dock their boats at this and other similar marinas. The fishing guides leaving the marina area blast their way at high speed out to deeper water, crossing these flats. This results in scarring on a bank adjacent to the docks. There has also been seagrass loss along the shallow side of the dock from mooring larger vessels there.

There are very many 'live-aboards' in Florida now. Florida has a very lax attitude about living on boats and there are thousands of people taking advantage of it in the keys. You anchor in shallow water, the boat swings on its mooring, and the keel and the lower unit or prop drags the bottom. You get this kind of impact [slide]—large circular scars worn into the bottom vegetation by the mooring chain and the other gear.

Another problem in the keys and coastal Florida in general are grounding events. In the keys, many shallow banks are out in the open surrounded by deeper water. On the edge of Florida Bay in Everglades Park there are hundreds of them, making the area very difficult to navigate. A small boat may run aground on one of these banks and leave a scar, a small hole. Here [slide], where a 40 foot vessel got stuck, probably one quarter of an acre of seagrass was impacted. The prop wash blew out a deep hole and displaced a large area of sediment.

Seagrasses are very efficient in stabilizing the bottom. Even in the strongest winds you will not see much sediment displaced from healthy seagrass beds. But if you remove the cover, such as this vessel did here, and you get a strong wind from the right direction, it will blow the fine sediment out of the scar, deposit it on the bank, further burying seagrasses, resulting in additional downstream impacts.

Threats of boats to wildlife are pretty obvious. Most of you know the problems with manatees being run over and killed by boats. This [slide] is a sea turtle that was hit by a boat. This [slide] is one of my favorite slides, a stingray with scars on its back.

This [slide] is a jet ski running tidal creeks in the Great White Heron National Wildlife Refuge with shallow water seagrass all around. In management plans developed by the Fish and Wildlife Service for the keys years ago, they took the step of prohibiting jet skis in two of their refuges. The prohibition has been upheld in court. As I have observed from airplanes, jet skiers run in shallow water looking for animals. They stop near turtles or large sharks in shallow water. They just run around on the shallow banks looking for things.

There is also a serious problem with boat-generated turbidity in the Florida Keys, possibly even more serious there than in other places because the ecosystem depends on clear water. This [slide] shows an active Sunday afternoon in a heavily-traveled area of the keys. All of the light color is mud generated by the wakes of the boats. In this particular area it is beginning to be chronic, resulting in the death of vegetation on the edges of the banks. As it continues, there is increasingly more sediment resuspended so it becomes a cumulative problem. Once this begins, it is very difficult to stop.

Citing from the draft state assessment that I have co-authored, I will go through a list of situations where prop dredging and prop scarring can occur:

- When boaters misjudge water depth and accidentally scar seagrass beds.
- When boaters stray from poorly marked channels and scar seagrass beds.
- When boaters intentionally leave marked channels to take shortcuts through shallow seagrass beds, knowing that the beds may be scarred.
- When boaters carelessly navigate in seagrass because they believe seagrasses can quickly recover from scarring.
- When inexperienced boaters engage in recreational or commercial fishing activities in shallow flats, thinking the draft of their boat is not deep enough to scar seagrasses or to damage to their boat.
- When boaters overload their vessels, causing deeper drafts than the boaters realize or when live-aboards anchor over seagrass areas.
- When boaters intentionally prop dredge to create a channel.

- When inexperienced boaters, ignorant of what seagrasses are and the benefits they provide, accept as the behavioral norm boating customs that disregard the environment.

So what types of work have been or are being done to address this problem? In the late '80s I organized the Boating Impact Workgroup in the keys. I convened agency resource people, conservation groups, concerned citizens, commercial fishermen and flats fishermen to begin to deal with this serious and growing problem. We put together a report titled "Uncontrolled Boating Damaging Thousands of Acres of Florida Seagrass Meadows". This led to the state undertaking several assessments, resulting in another document called "Scarring of Florida Seagrasses, Assessment and Management", which I co-authored. We used aerial surveys around the entire coast of Florida to identify areas of impacted seagrasses. We classified seagrass areas based on the degree that they had been impacted: light, moderate and severe. If there was less than five percent impact or burial, we characterized it as light impact. If there was five to twenty percent impact to the bank or shallow water area, that was moderate. If there was greater than twenty percent impact to the area delineated, it was referred to as severe. My work in the keys documented 30 thousand acres of impacted shallow water seagrass habitats, 15 thousand of which were in the moderate or severe category. State-wide, 194 thousand acres of Florida seagrass are impacted by prop scarring and dredging. I believe 65 thousand of these are in the moderate or severe category.

In addition, there have been several other studies in coastal Florida, most of them either undertaken by local or state government agencies, particularly in the Tampa Bay area where Robin Lewis has worked extensively. In Sarasota Bay there have been a few efforts to look at different approaches to managing the problem. Some of them work, some of them do not, and in some of them the data are still being developed and analyzed.

What can be done? The Boating Impact Workgroup that I organized established a four-point program which is now being incorporated into various management plans. First of all, obviously, is education. Second is improved and expanded channel marking and enforcement. Third is the creation of boating restricted zones. Finally, we must develop strategies.

For example, we now have a Florida Keys National Marine Sanctuary, that was designated by Congress in late 1990, but we do not yet have a management plan in place. We do have one in Pennicamp State Park, providing for idle speed or no motor zones in shallow water. Lignum Vitae Key State Botanical Site in the middle keys, which has been heavily impacted by boats for many years, has recently put a management plan in place to control boating in shallow water.

We need to look at laws that are on the books but not being enforced, and whenever possible, use existing laws because of the resistance to implementing new rules and regulations. I would also like to make a suggestion that this group in Woods Hole consider reconvening in a year to continue this forum to see what has been accomplished in the past. We should meet again to keep the discussion going.

Q I am going to ask this for Michael because he is too shy. What about the impact of air boats?

A (by Curtis Krue) There are very few air boats in the keys. We did have one that ran commercial tours in the Great White Heron National Wildlife Refuge. It was one of the reasons why we forced the Fish and Wildlife Service to develop a management plan. Another was getting rid of the jet skis. Just because of the noise and their ability to travel through very shallow areas, air boats are known to be a problem. They are traditional, they have been around for a long time, and they are being managed more and more all the time.

Q (by Preston Hartge) You made mention earlier of illegal channel markers. Do you have a regulation that prohibits the placement of those?

A The regulations, both state and federal, require that you get a permit through the Coast Guard to put in a channel marker of any type. You are also required to obtain a permit—and there are different types of permits available—from the Corps of Engineers to place any structure in navigable water. A channel marker is a structure. If you place it without a permit, it is illegal.

Q Do you have a Nationwide Permit Number Ten where you submit a written request? If there is no response in thirty days, it is assumed that you can place certain activity-type markers in a tributary or whatever.

A Nationwide Permit Ten is a form of a permit. There are no exemptions in federal law for structures in navigable waters.

Q I guess that brings me back to the original question. Does Florida have a written regulation about ...

A The Florida Department of Environmental Protection does have a requirement that you obtain permits for channel markers.

Q (by Bill Taylor) Are you meeting any organized resistance to limiting jet skis?

A It is a booming industry. The rental business in particular in the keys and south Florida is very large and growing all the time. We tried to get some strategies in place in the National Marine Sanctuary Management Plan for the keys, but it has been very difficult. There are a lot of people that want to get rid of them or put them in restricted areas out in deep water where they can run around in circles. But it is a big business, there is a lot of money involved, and even on a national level there is a lot of resistance to limiting them.

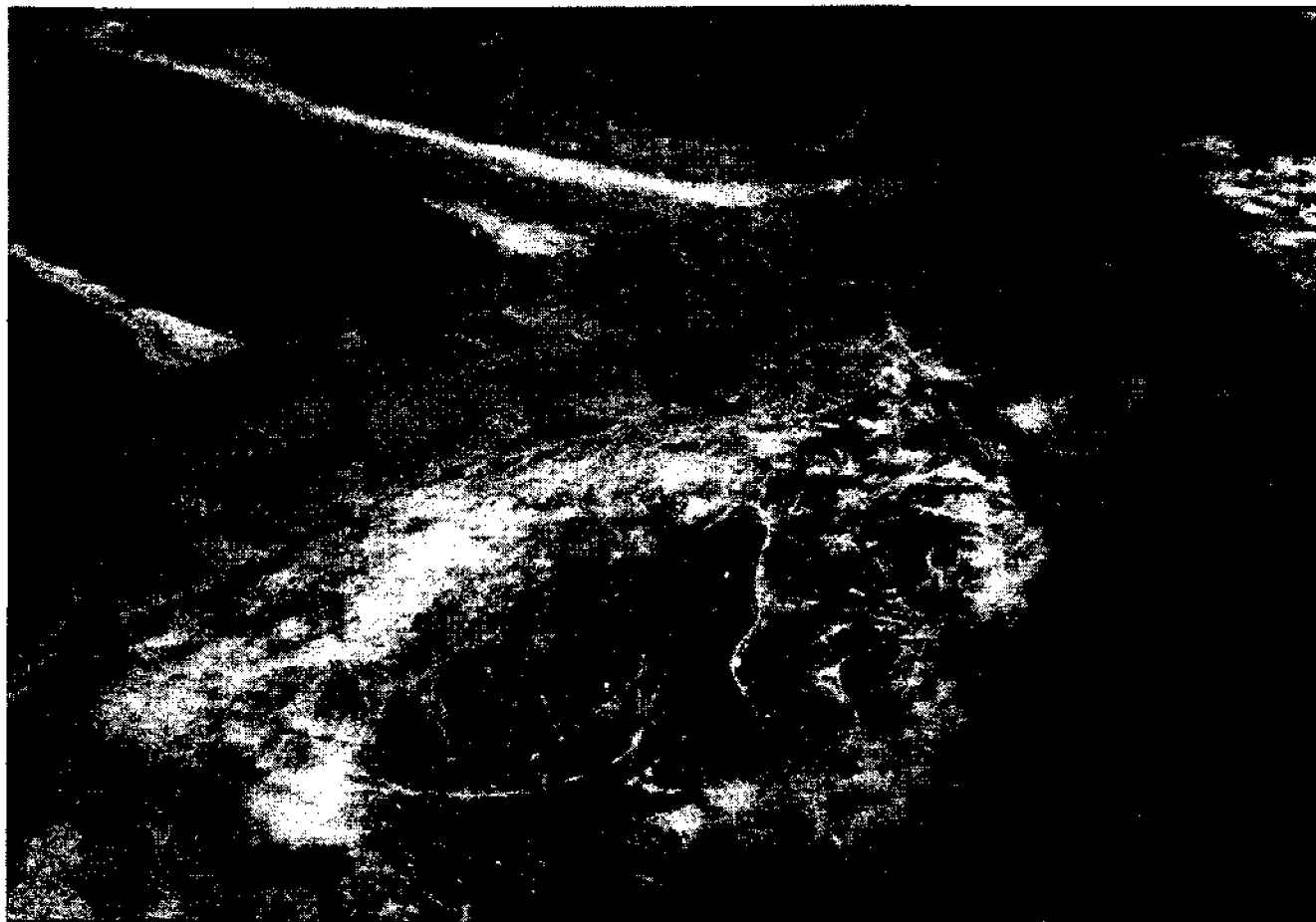

Figure 1.

Effects Of Chronic Recreational Disturbance On Shorebirds

Brian Harrington

Manomet Observatory, Manomet, Massachusetts

Before I begin my presentation, I want to note three things. First, a lot of the information we have is in early or mid-stages of development, and so I do not consider that we have the last word on some of the issues that I am going to talk about. Second, I want to point out that I am working mostly on the effects of disturbance in general. That is, I study topics not specifically relating to but including boats. Finally, I want to note that when Manomet Observatory bird people speak of shorebirds, we are talking about small sandpipers and their allies, the plovers. We are not talking about all birds along the shore as the name logically implies: no terns or loons or gulls, just sandpipers and plovers.

There are about 40 species of sandpipers and plovers common to the Western Hemisphere. Some species breed along our coast and some of these, like the piping plover, cause a lot of problems because they are listed as an endangered species and nest on nice sandy beaches. But the majority migrate extraordinary distances between their northern breeding grounds in the Arctic regions of Canada and their wintering grounds, for the most part in central and southern South America. They do this in a series of very long flights. In order to prepare for those long flights, they visit some productive estuaries or wetlands where they fatten up before they fly out over the ocean, using the fat as fuel for the flight.

In the case of coastal staging areas for their migrations, shorebirds are essentially a marine animal. They adjust to the tidal cycle. They rest at higher tides, they go out onto the intertidal area to feed at lower tides, and then they return to the higher resting areas during the high tide portion of the day or night. So day or night, they tend to follow the tidal cycle, at least at these migration staging areas. A bird might visit a migration staging area for two weeks or so, during which time it would approximately double its weight, then take off on its flight and lose that weight in a matter of fifty or sixty hours.

Shorebirds differ from many other species in having an extraordinarily early south migration time. You would think that a bird that travels to the Arctic would be coming down later than most other birds on its southern trip, but that is not the case. Eighty percent of shorebird migration— this is from studies we've done here in Massachusetts— begin between the first third of July and the middle of August. Needless to say, that is also the period in the northern hemisphere when we have our most intense demands on coastal areas for recreational uses, be it jogging or driving beach buggies on the beach or operating small boats in nearshore areas.

From studies of about a dozen species that we had good data on, we found that between 1984 and 1989 there were declines of populations in some instances approaching 70 percent during a five-year period. One of these that you might be familiar with is the sanderling, a very common shorebird. Its populations went down between 70 and 80 percent during this 5-year period. Other shorebird species went down by 20 or 30 percent while a number of species did not change at all. We started wondering why.

One of the things we looked at was what was happening to the numbers of birds using particular staging areas relative to their recreational use. The site we selected was close to home, Plymouth Beach in Massachusetts. The vehicle of disturbance that we selected was the beach buggy; however, we also counted boats, dogs and joggers at the same time. To make our point in this particular study, we just used the beach buggies. The study showed essentially that through a 10-year span of time some populations of species were declining on our study beach relative to how intensely that beach was being used for recreation.

I should back up and note that in this study we factored out changing sizes of bird populations on a continental scale. In other words, if the sanderling population was declining on a national scale, we factored that out in this study of disturbance. We did that for a variety of species and were able to show in half a dozen or so that there was a very clear long-term decline in numbers using our study area that related to the intensity of recreational use of that area.

We arrived at this conclusion by using a series of observations we have used in some of our other bird studies. Bird investigations are complicated by the fact that the birds can fly away. When they disappear we just assume they go somewhere else, be it to another beach or perhaps to somewhere else much farther away because that is easy for them to do. The challenge is to monitor a staging area (for example) and make some sense out of what can look like chaos. For the work I describe here, we have been weighing birds in the study area and marking them with colored plastic tags which allows us to tell individuals apart. We can go out with telescopes on a given day, search for tags, and tell who is there and who isn't. In this way we get a good idea of who departed on migration and when. From previous work we also know on average how much weight these birds will gain each day during their visit at a staging area. We can then piece together what a bird weighed when we tagged it, how long it stayed in the area, and how much weight it was likely to have gained while it was there.

We have used this data to examine the influence of disturbance in the staging area by looking at the resighting rate of these birds in later years. As these birds are very faithful, as far as we know, about using the same staging area year after year, they come back to the same spot. We have had up to 80 percent of marked groups come back in the next year, which is as many as we could have expected to be surviving.

When we took a look at who was coming back, relative to the estimated departure weights in the previous year, we found that we had something on the order of 80 or 85 percent of the heavy birds from the previous year coming back in the successive year. But in the lower weight group we had a very small percentage coming back. I do not remember the precise number but I think it was around 30 percent of the lower weight group was coming back in successive years. These were statistically sound differences.

The question then becomes one of what was happening to these lighter weight birds. While we do not know for certain, our best guess is that they flew out over the ocean and did not make it to South America [because they had insufficient energy reserves], but we can not really prove that.

Now, and this is where we have to start getting very speculative, the next question in my mind is why were not a lot of those birds getting up to a higher weight. This is not something we have been able to explore directly because, among other things, studying this would in and of itself be a disturbance which may cause the birds we were studying to lose weight. So instead, what we are now trying to collect better information about is whether disturbance associated with recreational activities is what is at least partly responsible for some of these birds not getting up to weight.

I decided to play some numbers games with this idea and worked with red knot data. The red knot is a kind of sandpiper for which we have some pretty good information on their metabolic rate and what they typically weigh. I used 150 g for this example. We also have good information on how much weight they gain at a highly disturbed migration staging area each day—three grams. Finally, I estimated how far a knot flies when it is disturbed. I do not have any scientifically-collected numbers but I have watched these birds for 8 to 10 years, and my best guess was 1 to 1.5 km.

Taking these numbers, and plugging in a typical wing length and information on their flight speed, we can estimate how many kilojoules or calories of energy a knot would use in a single 1.5 km flight. If we estimate how often they are disturbed each day, we can then derive how far they fly during this period. In this example, which is a very plausible estimation, if we hypothesize that the shorebird was disturbed 20 times a day—which is not an unreasonable figure in a high recreational use area—then its disturbance flight would consume roughly 25 percent of the fat that it otherwise would have gained as an investment for its migration south over the Atlantic Ocean.

The implication of this is that chronic disturbances of shorebirds in their migration staging areas may, indeed, substantially affect survivability. Our job now is to determine if disturbances really do, and that is the point I want to leave you with. These birds are feeding in intertidal areas at low tide. They are feeding on heavily used recreational beaches at high tide while jet skis and other boats are roaring up and down and while researchers, bird-watchers, joggers, dog-walkers

and "everyone else" are out there harassing them. So what are the effects of all of these disturbances?

Q (by Kate Hinch) Our group works a lot on plastic debris in the ocean and the ingestion of this plastic by sea animals, including shorebirds. And obviously, when plastic is ingested, it's not digested. It builds up. Can this be a factor in the lack of shorebird survival as well?

A (by Brian Harrington) I have no idea.

Q I mean, based on if it's a recreational area, cigarette butts and plastic pieces that they could be ingesting as it's trying to discern between --

A It is a possibility. It's not anything we have looked at. It certainly would be worth somebody's while to look at it, I think.

Q (by Ellie Dorsey) You are saying 25 percent is the amount of fat lost in one day?

A If the bird is gaining three grams a day, it is losing 25 percent of that three grams in a day, with 20 instances of a 1.5 kilometer disturbance flight.

Q Does the ingestion actually go down as well when they're disturbed?

A In this model, I was really just playing with resting areas, high tide resting areas. I have not even looked at or thought about seriously at this point the low tide areas. I think that is a very real issue, and I think that is where the marine activities will become especially important. But my mission so far has to been to make the case that here is something that might be a real problem we need to look at. I am not trying to show that it is, in fact, a scientifically proven problem. I think it probably will happen some day, but we have got to get to that.

Q (by George McCarthy) When you segregated your heavy birds and your light birds, what was the percentage difference in their weight? I mean, is 25 percent significant in that regard when you compared the mortality of the two groups? In your high mortality group that you call the light birds what is the difference in the amount of weight they put on relative to the low mortality group, the one that had --

A See, we never actually measured the weights that these birds left at. We were assuming they both gained the average amount of weight each day, the light birds as well as the heavy birds. And again, this is just an exercise. It is not real data. We have estimated their departure weights.

Q Oh, you did not know what they weighed when they departed?

A That is correct.

Q Oh, I see.

A We knew what they weighed when we caught them and we put the bands on. We knew they stayed ten days or fifteen days or whatever each individual stayed, and based on how long they had been there and how much weight an average bird would gain each day, we estimated its departure weight.

Boating Induced Turbidity

Preston Hartge

**Maryland Boating Administration, Maryland Department of Natural Resources,
Annapolis, Maryland**

In Maryland there are about 191 thousand registered or documented boats. These boats range in size from megayachts to personal watercraft. The Boating Administration for which I work has the authority to regulate the operation of recreational vessels on Maryland waters. Most of the existing regulations (Table 1) have been established to enhance public safety but some are there to protect the environment or living natural resources. Some of them are applied on all state waters and some are focused on a particular tributary to address a specific concern.

While some of our regulations are applied year-round, many are not. Our boating season in our inshore waters is from about April 15th to October 15th. We have established this season because that is when we see the most activity, which is greatly reduced for the rest of the year.

In designated congested areas we have a six knot speed limit at all times. This is a safety regulation to promote safe operations. We have had it in place for quite some time: it is not there to address any environmental concerns. We have a 35 knot maximum speed limit on all waters away from congested areas. This is relatively new and I suspect was put in place as a response to the proliferation of the high-powered muscle boats. We also use minimum wake zones, and allow boats in them to proceed only at the speed necessary to maintain steerage, as slow as you can go in a particular boat and keep control. Minimum wake zones are in place mainly in areas with highly erodible shore lines and shallow bottoms, natural heritage sites, or waterways where we want to promote passive recreational use.

We were recently asked by our department's fisheries agency to establish two minimum wake zones in fish hatchery areas on the Potomac River: the Pomonkey and the Chicamuxen Creeks. These creeks are no-wake areas during the black bass spawning season and the regulations were directed towards the tournament and recreational bass fisheries. The participants in these fisheries were really cooperative and we were quite surprised to encounter virtually no opposition to regulations that were put in place for the benefit of a particular species of fish.

We also have the ability to establish areas in which boating is totally prohibited to protect those species listed as threatened, endangered, or in need of conservation. One area in the back bays behind Ocean City near Assateague Island protects the piping plovers, wild terns, black skimmers, gull bill terns, and least terns. In this area the closure is seasonal, running from April 1st to September 15th.

We use another type of boating regulation in areas used by professional or more accomplished skiers as well as people who are skiing recreationally. Having both types of users in the same area at the same time can lead to conflicts that we have tried to avoid through regulation. To eliminate - or at least minimize - the conflicts, we have set up a system where we inspect the boats according to performance standards and noise emissions. On meeting our standards, a decal is issued that allows their operation on established courses for either competition events or just general use. Some of these courses are open only during specified times; possibly from 8:00 a.m. to noon one or two days a week and for several hours on the weekend.

In one creek we have a speed limit of six knots for boats greater than 17 feet in length and no speed limit for boats under 17 feet. We have done this because we feel that boats shorter than seventeen feet create larger wakes at six knots than they do if they are on top of the water and planing at fifteen knots. We would like to use this type of control in other areas where the congestion is not great and there is enough room for boats to go fast.

Another regulation that has been established since the "muscle boats" have come into common use is a 75 decibels (dB) noise limit. This is a regulation that anybody who has come within five miles of where one of these boats is in operation will understand. This level is measured by meter at a certain distance from the water. If a boat exceeds 75 dB, the operator is cited by the Natural Resources Police. This is generally a "turn-in" type of thing; somebody hears a noisy boat, makes a phone call and the police respond to it.

Everybody who has been around the water has heard a lot about personal watercraft. We have special regulations for them that apply to all Maryland waters. Most are for operator safety. Speed is limited to six knots within 100 feet of the shoreline, other vessels, piers or other structures. You have to be at least 14 years old and have taken a boating safety course to operate one and if you are from out of state you have to complete a preparatory course before you can rent one.

As to boating induced turbidity, in 1990 we were required by law to come up with a comprehensive vessel management plan for the Severn River, which includes Annapolis and is used extensively by boaters. In our preliminary surveys we monitored vessel traffic and in many instances found well over 100 passing a particular point on the river in a half an hour. We commonly counted 80 or 90 boats in operation in a quarter mile stretch. This level of boating activity extended throughout most of the daylight hours.

We became interested in turbidity when a water ski course was established in the Maynardier Creek area of the Severn and the residents, being unhappy with this, accused the skiers of destroying the habitat, stirring up the bottom and killing the submerged vegetation (SAV) in the area.

Having no studies to either substantiate or refute their claims, our agency commissioned a study beginning in 1993 by the Horn Point Environmental Laboratories of the University of Maryland. Dr. Court Stevenson was the principal investigator. We were interested in the resuspension of bottom sediments and how this might affect SAV in particular.

We choose two monitoring sites with similar bottom sediments: one exposed to high levels of boating activity and one not. While we didn't come up with any definite conclusions or enough data to allow us to begin to consider specific regulations, we did see indications of trends that told us we should look farther.

So in 1994 we began another study. Rather than just setting the equipment out and leaving it untended as we had in the previous year, we monitored it daily. Using our own operators and "standardized" operating conditions, we performed test runs, purposefully resuspending sediments in order to develop techniques to more accurately measure the level of disturbance.

SAV has been on the decline in the Chesapeake Bay for some time. In some areas it appears to be returning, but the return is very erratic. For reasons that have not yet been determined, during 1994 there was more SAV on the western, more heavily populated side of the bay and less on the eastern shore, which is characterized by agriculture and other non-residential uses. Of course, the first thing that we heard was that farming was the problem. As boating recreation managers, we have to evaluate the impact of all factors: agriculture, boating and others.

Our 1994 study indicated some problems with boats causing the resuspension of sediments, particularly in waters a meter or less in depth. We looked at Dickinson Bay and the Rhode River, areas with recreational use. We used four types of small boats: two were jet-propelled and two were propeller-driven. We did not see much difference in the amount of sediment resuspension between the propulsion types but we did notice that the boats that went slower and were more heavily loaded stirred up more sediment than those more lightly loaded and traveling faster.

This seemed to contradict our minimum wake regulations in use to slow boats down but we still use it and it does work in that it cuts down on boating use. By virtue of a regulation that seems to be inappropriate for what our data is now showing us, we have cut down on the sediment resuspension in our smaller tributaries. We are getting the desired result, so the regulation remains in place.

Our limited testing has also revealed that boating can temporarily increase light attenuation and that the duration and the intensity of the increase depends on the type and condition of bottom sediments. The effect is greater in shallow water, attenuation being two to three times greater than in the deeper water. The effect is greater at slower speeds and the effect of larger jet-propelled craft is greater than that of personal watercraft, possibly because of the greater loading.

We still feel we need to continue and refine this work before we can draft meaningful regulations. For example, our method of collecting the suspended sediments needs to be improved; we simply dipped a container down and pulled it up, and I think we got very erratic tests from that. We are reviewing our work to date but are in a bit of a quandary about how to proceed. While I think this is a very good study and I want to continue it, if the conclusions start to show that we need to restrict boating more than we have been, we might possibly lose our funding. My funds come from a five percent tax on boats purchased in Maryland.

**MARYLAND DEPARTMENT OF NATURAL RESOURCES
BOATING ADMINISTRATION**

There are 191,000 registered and documented boats in Maryland. The Boating Administration has the authority to regulate the operation of recreational vessels on Maryland waters. Below are boating speed limit regulations and other regulations we have used to regulate boating activity. While most boating regulations are established to enhance public safety, some are established to protect natural resources.

The following boating regulations may be established year round or only during the boating season (April 15 - Oct. 15). In some cases special time restrictions or closures apply:

6 knots at all times

6 knots Saturdays, Sundays & State Holidays

35 knots maximum

Minimum Wake

Defined as the minimum speed necessary to maintain steerage. Established in areas with highly erodible shorelines, shallow bottoms, Natural Heritage sites and in waterways where we want to promote passive recreational activities.

Boating Prohibited Area

Established in Maryland's Coastal Bays to protect species listed as threatened, endangered or in need of conservation. Protects Piping Plovers, Royal Terns, Black Skimmers, Gull-billed Terns and Least Terns. Effective April 1 - September 15.

Controlled Ski Area (for slalom water skiing, 3 sites)

Special restrictions apply including vessel performance test, minimum wake requirement and noise level compliance and vessel must display current decal as proof of inspection. Maynardier Creek Slalom Ski Course closed March 15 - June 15, the "environmental window" for SAV horned pondweed to grow and set seeds. Water skiing is permitted only during daylight hours (sunrise to sunset).

6 knots for boats greater than 17 feet (no speed limit for boats 17 feet or less) - only one creek in state

75 db(a) noise level limit.

Personal Watercraft

Special regulations apply to the operation of PWCs. All were established to enhance safety. All PWCs must operate at 6 knots or less when within 100 feet of the shoreline. A secondary benefit to the distance requirement is that PWCs would be deterred from entering narrow shallow headwaters.

Q (by Tom Klin) In your boating illustration handout here, when you established the boating prohibited areas, did you close that area to all vessels or just motorized vessels?

A (by Preston Hartge) All vessels are prohibited in those areas because the presence of people disturbs the birds or the wildlife there on the Skimmer Islands.

Q (by Tom Klin) What was the public response?

A Local response was rather mixed. Overall, I think it was positive and the people have adapted to it very well. We haven't had any offenders.

Q (by Tom Klin) Are these homogenous bodies of water, like a cove or some area of river? How did you define the areas?

A We worked in conjunction with our Wildlife Division to set up the areas based on historical nesting sites.

Q (by Curtis Kruer) Implementing the regulations to protect bird nesting areas of the shoreline, what kind of data or research did you have to justify those closures?

A Jody, do you want to --

A (by Jody Roesler) Thank you. We've worked very closely with the National Park Service and our Fish Heritage and Wildlife Service. Our Wildlife Division and Heritage staff have both been monitoring the bird population on the northern tip of Assateague Island and also Skimmer Island, which is right behind Ocean City. It's a dredge spoil island and I believe they had a number of years' data. We had to set up a buffer on land, protect the mud flats and also establish a buffer in the mooring area. What has happened in the past several years is that they have shown some increase in the populations of the various birds they were trying to protect.

Q But to your knowledge, it was directed research that showed the benefits of closing these areas?

A (by Jody Roesler) Yes, definitely. We might even have some papers that I can send you if you'd like to give me your name. We also have some brochures. I have about twenty-five brochures specifically on the prohibited area closure that have a map showing the closure area. And the closure area may vary from year to year. Every spring our biologists monitor the nesting sites, and our closure is based on where the nesting sites are on land.

A Statistical Analysis of Motorboat Effects on the Turbidity of Otsego Lake

George W. McCarthy

Jerome Levy Economics Institute, Bard College, Annandale-on-Hudson, NY 12504

and

Andre P. Mele

43 Yale Court, Ulster Landing, Kingston, NY 12401

Abstract

Motorboats have long been suspected of causing the resuspension of phosphorus-bearing sediment from bottom surfaces and from lower regions in the water column, thereby making phosphorus available to nourish algae as part of a general decline toward eutrophication of freshwater lakes and ponds. If this is so, then on heavily-used bodies of water the effects of motorboats should be identifiable. Critics of this view claim that the effect of motorboats is minuscule relative to large, global, weather-related events.

This study explores statistically the relationship between motorboating and turbidity, controlling for weather. The study uses data collected from Otsego Lake, a generally healthy, mesotrophic/oligotrophic body of fresh water in upstate New York. Despite the lake's good condition, data indicate a gradual trend of deterioration toward eutrophy.

The dynamics of turbidity will be discussed in some detail below, based primarily on statistical modeling of turbidity and climatological data. Our work indicates that there is room, amid a great deal of uncertainty, to suggest that motorboats do have an identifiable role in the creation of turbidity, thus warranting further study. The authors propose a specific integrated discipline of sampling and data collection, to make subsequent analysis more meaningful.

Introduction and Background

Suspended sediment is known to transport phosphorus and nitrates, which, when bioavailable for algal growth, contribute to productivity and eutrophication. It also blocks sunlight from reaching rooted macrophytes, thus impeding their growth and survival, and can interfere with the reproductive and feeding activities of fish and other aquatic species.

There are many sources of turbidity, among them the effects of motorboats. Motorboats cause turbidity by resuspending bottom sediments, by resuspending settling sediments, and by the action of high-energy wakes impacting along shorelines. Motorboats also contribute to turbidity through particulates and phosphorus (Hallock and Falter 1987) in their engine exhaust.

Otsego Lake is located in upstate New York 50 kilometers (30 miles) due west of the state capital, Albany. The lake is fed by some 27 streams, three of which constitute 75% of stream

inflows (Harman and Sohacki 1980). Overall, the volume of inflow known to enter the lake is small and the average residence time of water in the lake is from 7 years (Iannuzzi 1988) to 4.15 years (Harman, pers. comm.). There is no measurable current in the lake, other than localized effects, except for a brief period during spring runoff, when a cold sheet current slides rapidly over the warmer bulk water, thereby helping to carry some incoming nutrients to the Susquehanna without dropping them in the lake (Harman, pers. comm.).

Approximately 15 percent of the lake's bottom is shallower than 5 meters (the greatest depth at which sediment resuspension from motorboats was observed by Yousef et al. 1974). The majority of shallower waters (2 sq. km.) are found at the northern end of the lake. The deepest part of the lake is found 4.5-5 km from the northern end, and the bottom shoals gradually for the remaining 8-8.5 km to the south end's Susquehanna outlet. Maximum depth is 50 meters, and annual sediment deposition in the deeper regions is approximately 0.5 cm/yr (Harman, pers. comm.). The outlet at the southern end of the lake is the sole outflow and it forms the beginning of the Susquehanna River. The village of Cooperstown is located at this point; the majority on the west bank of the Susquehanna, and a small portion on the east. There has been a Biological Field Station (BFS) maintained 2-3 km north of Cooperstown on the west shore as a facility of the State University of New York, College at Oneonta since 1968.

The lake has been suffering a decline in diversity and other aspects of quality. In 1935 there were 26 species of submergent plants; today there are 16. In 1969 there were 24 species of mollusks; today there are 10. In 1975 an average of 300 planktonic crustaceans could be counted per quart of water; today the average count is 10. Water clarity is decreasing. From 1972 to 1977 the average Secchi disk readings were 4.7 m; in 1992 the average reading was 3.7 m. In fall of 1993, just prior to the fall "turnover," the hypolimnion, a stratum of oxygenated cold water habitat available for important salmonid fish species, dwindled to 5 meters in depth, from the previous year's thickness of over 25 meters. During Fall, Otsego Lake exhibits the characteristics of a mesotrophic system, recovering oligotrophy after turnover during the winter, and in spring and early summer. (Various BFS sources.)

Variables affecting turbidity

The variables affecting turbidity are rainfall, wind and wind direction, nutrient inflows (phosphorus, nitrates) from agriculture, nutrient inflows from septic systems, nutrient inflows from urban areas, atmospheric deposition, algae populations, watershed geology, lake water levels, drainage and streamborne sediment characteristics, and motorboats.

Ephemeral increases in turbidity would be expected to result from: intense or long-term rainfall (sediment inflows); spring runoff character (sediment inflows); algal blooms; unique atmospheric deposition characteristics (such as nearby cities, factories, or global effects such as volcanic eruptions); seasonal population influxes (septic, road runoff, localized atmospheric

deposition); intensive motorboat usage (resuspended bottom sediment and shore erosion); windstorms (shore erosion); variations of five inches or greater above or below optimum lake water level—1,194'6" above sea level (shore and bottom erosion); and seasonal agricultural practices, such as plowing and fertilizing (dust, sediment, nutrient inflows). Long-term trends toward increasing turbidity would be expected to result from: deforestation (erosion); intensive development (erosion, urban runoff, septic); increasing use of waterfront homes (septic); aging septic systems along the lake shore; positive-feedback conditions associated with eutrophy (algal blooms); altered agricultural patterns and practices (erosion, nutrient inflows); increasing usage of motorboats (shoreline erosion, sediment resuspension); climate changes; and shifts in the balance among lake biota, such as the recent introduction of the alewife, which feeds upon zooplankton, leaving phytoplankton populations to burgeon. (From Cole, pers. comm.; Garrad and Hey 1987; Hallock and Falter 1987; Harman, various; Hilton and Phillips 1982; Kortmann and Henry 1989; NYS DEC 1990; Sharpley et al. 1991; Vighi et al. 1989; Wagner 1990; Wetzel 1975; Yousef 1974; Yousef et al. 1980.)

The detection of turbidity occurs primarily at the Cooperstown Municipal Water Works (MWW) which monitors turbidity constantly as a function of its water treatment activities. Other data are taken occasionally with a Secchi disk at various locations around the lake (see Harman 1980; Iannuzzi 1988). MWW readings are in NTU and Secchi readings are in meters of visibility of a sinking white disk; therefore high NTU numbers indicate cloudiness, while high Secchi numbers indicate clarity.

Data

We used the following types of data for our analyses: turbidity—daily measures, at least once a day; Secchi disk readings—available for 1988 (from Iannuzzi) on a weekly basis from a number of locations on the lake; chlorophyll-a and phosphorus (total phosphorus and soluble reactive phosphorus)—spotty readings for a variety of locations around the lake by Iannuzzi for 1988, 15 center-lake chlorophyll-a readings for 1993 by BFS; and water temperature and pH for various locations and multiple depths, as well as wave action grouped in six classes according to severity, by Iannuzzi for 1988 dates. Weather—daily high temperature, low temperature, and amount of precipitation—were available for the Cooperstown site.

A number of assumptions were made about the character of motorboating. From innumerable personal observations, personal experience, and industry sources, we accept that the heaviest boating activity is on summer weekends, and that sunny, warm weekends attract more boaters to the lake than windy, cool, or wet weekends. We further assume that holiday weekends are going to attract more boaters to the lake than ordinary weekends, subject to the above climatological constraints.

Methods

The analysis of data included calculation of descriptive statistics, estimation of simple correlation, analysis of variance and time-series regression. This is, by and large, exploratory work. The work is theory-driven to the extent that we hypothesize relationships between turbidity and other factors. Since most of the data is spotty at best, most of the results can only be considered impressionistic. Much of the data was not collected at regular intervals. It is very difficult to do much with data collected at various locations of the lake because series aren't complete; many of the observations don't match up.

Given that turbidity appears to be a complex phenomenon, the limitations imposed by data availability makes drawing firm conclusions quite problematic. Although, some of the measures have 30-40 usable observations, which limits us to about three explanatory variables in a model, there are very good series on turbidity at the water station, and complete local weather data. This allowed us to explore dynamic properties of turbidity at one location related to duration, variability, trends over time, seasons, and local weather disturbances.

The six-year period 1988-1993 was analyzed to find the dynamic structure of the relationship between turbidity and daily weather. The daily data was detrended in order to look at short term variations independent of the secular increase. This was done by including a time variable in the regression models. The estimated coefficient accounts for the average daily rise in turbidity independent of the other explanatory variables.

We also tested for autocorrelation in the turbidity data. Autocorrelation is defined as a structural relationship between intertemporal observations. What this means, in our case, is that any random change in turbidity on one day is likely to affect the level in the following day or days. This has intuitive appeal when applied to the study of turbidity. One would expect that any event which increases turbidity would have some duration. Empirical questions that might be settled in a study such as this involve the duration of turbidity-increasing events and the possibility of linearity between duration, frequency, and the extent of the event.

Autocorrelation presents a problem with statistical modeling. Essentially, one cannot trust coefficients estimated in the presence of autocorrelation using standard least squares techniques. Autocorrelation leads to inefficient and inconsistent least squares estimates and biased estimates of standard errors. This means that all tests for statistical significance of estimated parameters will be biased. Many methods have been devised to provide asymptotically unbiased estimators in the presence of autocorrelation. The best known of these is the Cochrane-Orcutt method. This method was used in regressions reported in the appendix (Cochrane and Orcutt 1949).

The analysis of daily readings used four separate specifications. First, the 8:00 am reading was chosen as the dependent variable (AMTURB). It is assumed that the 8:00 am reading follows a period of low human activity on the lake. This means that any turbidity-increasing event

observed at that time can be assumed to be a "natural" occurrence. Only events with duration longer than a day are expected to be captured in this data. Second, the daily high was chosen as the dependent variable (HIGH). The daily high is expected to capture both long and short duration events. Since AMTURB is "nested" within HIGH, HIGH will capture any event that has a duration longer than a day and will also reflect any spikes that occur within a day. This would account for its higher variability than AMTURB. Third, the difference between the daily high and the lowest reading was chosen as the dependent variable (DAYDIF). The variable DAYDIF is the difference, in NTU's, between the lowest daily reading and the daily high. It will only capture short term events. Large movements in this variable will indicate activities that changed turbidity within a single day. Since high readings typically occur during daylight hours, this variable will likely capture events related to most human activities. If a turbidity spike lasts longer than a day, we should see lagged values of DAYDIF showing up with statistical significance. Finally, the difference between the daily high and the previous day's high reading was chosen as the dependent variable (HIDIF). This variable tracks the difference between daily highs; specifically comparing one day's high with the previous day's high. It will capture short-term random fluctuations that have durations longer than a day. This variable should aid in recognizing the duration of these events and whether there is a linear relationship between the dimension of an event and its duration.

Results and Comment

In all models estimated, there was a statistically significant secular increase in daily turbidity over the 1988-1993 period. There was strong evidence of non-linear yearly cycles on top of the secular trend. This cycle was characterized by low turbidity early in the year (especially during periods of ice cover). Turbidity rose slowly through the Spring and more rapidly in early Summer. It peaked in early August and declined slowly through the Fall. There is some indication of increased turbidity during the fall turnover (the reversal of the thermocline). There was also evidence of significant autocorrelation in the turbidity data.

Turbidity was related to a set of processes with different durations. The first, long term process was characterized by a general increase over the six years studied. This yearly increase was about 0.05-0.10 NTU per year (statistically significant) and appeared to be fairly stable across a variety of specifications.

A rather disturbing trend was the countervailing influence of pH. Ph appeared to be falling, despite the natural buffering effect of the local limestone, and was having a statistically

significant negative impact on turbidity; as acidity increased in the lake, turbidity fell. This means that the secular rise in turbidity would be higher were it not for increased acidity. ¹

There is a medium-term pattern that sits atop the long term trend. It is a yearly cycle which is characterized by low turbidity in the winter, rising turbidity through the spring and summer which peaked in August, and declining turbidity through the fall. This yearly cycle is theorized to be related to ice cover, water temperature, dissolved oxygen content, air temperature, and spring and fall turnover. ²

The other patterns of variation in turbidity are short (1-3 days) and very short term (<1 day) events. The short term variability is related to the previous day's turbidity, air temperature, precipitation, and time of year. AMTURB rises significantly if it rained/snowed the previous day (the effect is about 0.11 increase in NTU per inch of precipitation). Precipitation two days before also has a positive and statistically significant effect on morning turbidity ($0.065 \text{ NTU} \cdot \text{inch}^{-1}$). There is no other statistically significant effect of previous days' precipitation on this turbidity measure.

For HIGH, there is a statistically significant effect of precipitation on turbidity for the day in question, the previous day and the day before that ($0.18, 0.37, 0.22 \text{ NTU} \cdot \text{inch}^{-1}$, respectively). Daily high and morning turbidity readings are related to the daily high temperature two days before. The estimated effect is a 0.003 increase in NTU for each degree of temperature. The months from August through December show statistically significant higher measures of daily difference (DAYDIF) relative to April.

The very short term variation is related to precipitation, and possibly boating activity. DAYDIF (the comparison of the difference between the relatively pristine 08:00 readings and the daily highs) starts to show a definite boating season effect and a relationship to issues that might involve boating. This is shown in Table 4 where, for instance, Sunday DAYDIFs are as powerful as rainy days, and Fridays and Saturdays show statistically significant accumulation of turbidity toward the Sunday climax, which by Monday is no longer statistically significant.

An event that seems to have a significant impact on very short term turbidity is the lakewide thermal turnover that occurs in the fall (i.e., when the thermocline switches from a negative correlation between water temperature and depth to a positive correlation).

¹ It is not clear that the factors which account for the long term turbidity increase are independent of the shorter term factors. Increased frequency of events which raise short term turbidity might leave residual effects that show up cumulatively in the long run. For example, if sediment is repeatedly stirred up from the bottom, and phosphorous contained in the sediment goes into solution, the result might be algae blooms which, as a positive-feedback cycle, would increase long term turbidity.

² For the purposes of regression analysis, one month must be left out in order to estimate equations with an intercept. For these models, April was omitted as the reference month.

The R-square for all the variables in the model (Table 4) indicates that about 30 percent of the total variation in turbidity is explained by those variables. Whether a portion of that 30 percent, which occurs on weekends and stops abruptly on Mondays, can be described as deterministic of eutrophication, remains to be seen, but we must not rule it out. As shown in the Secchi/phosphorus relationship graph (Fig. 2), Otsego Lake is at a point on the curve where small increases in nutrient levels can have great effects on overall water clarity and quality.

The data we examined showed no statistically significant positive relationship between chlorophyll-a and turbidity. There was no seasonal hump pattern in algal growth as measured by chlorophyll-a, or in phosphorus, to match that of turbidity levels. In fact, there was one instance of negative and statistically significant impact.

The trend in housing development seems to resemble the non-seasonal overall trend toward increasing turbidity during the period of our study, but a meaningful comparative analysis would require more precise data about changes in housing and alterations to local septic facilities, and several decades of data from the MWW. Over the region of our study, there was increased snowfall and increased atmospheric particulate deposition, apparently from volcanism. The colder winters have resulted in increased consumption of fossil fuels for home heating, the fallout from which accumulates on the surface of the lake's winter icepack and enters the lake at spring melt. Fossil fuel and woodstove residues are known to contain particulates and small amounts of phosphorus, but any potential effects on overall lake nutrient concentrations are likely to be brief, and mitigated by the sheet current described earlier.

The effects of tourism on the lake ecosystem are not widely understood. It is generally supposed that there are dramatic loads on municipal septic systems and solid waste systems, but both streams are fated downstream of the Otsego Lake watershed, which terminates at the Village of Cooperstown, where the vast majority of the tourism burden (benefit) occurs, and thus stress the Susquehanna River, not the lake. There may be an effect from road runoff and vehicle exhaust emissions deposition that result from motorized excursions around the lake along the scenic roads that follow the shore on both east and west sides.

Wind action is, at first glance, a strong candidate for overall lake-wide turbidity, but the prevailing winds are westerly—northwesterly in winter, and southwesterly in summer—which tend to blow across this north-south oriented lake, with only a short fetch of 1-3 kilometers for waves to build up energy. No large waves or chop are observed on Otsego Lake. Anecdotal observers indicate that wakes from powerboats possess far more energy, more height, and greater velocity than wind waves, as confirmed by Karaki and vanHofen (1975). We feel that the

available evidence indicates that wind action has a minimal effect on MWW turbidity readings, although it may be one of the few lakewide effects.³

Garrad and Hey (1987), Harman (pers. comm. 1994), Hilton and Phillips (1982), Karaki and vanHofen (1975), and Yousef (1974 and 1980) comment on the rapidity with which sediment is resuspended by the passage of motorboats (< 5 min.), and the relative rapidity of resettlement (24-72 hrs.).⁴ In a lake with no measurable current, and residence times of from 4-7 years, and in which areas less than 2 km away from heavily silted areas are experiencing sedimentation rates of only 0.5 cm/yr, it is reasonable to suggest that resuspended sediment falls in the lake within a few meters of where it originally lay, in a random or chaotic manner; that streamborne agricultural erosion settles within the proximity of the stream mouth; and that Otsego Lake can probably, therefore, be regarded as a mosaic of regions, or zones, of local effects which have little influence upon lakewide conditions.

Thus, when considering turbidity data from water taken up at the extreme southern end of the lake, it may make sense to pay particular attention to the immediate zone of concern, within the ambit of local effects such as streams, currents, water depths, and human activities.

Harman and Lindberg (1991) observe that the waters adjacent to Cooperstown have the most intense boating activity on the lake. Therefore any overall boating effects will be weighted more heavily in the Cooperstown zone, an area of sufficiently shallow waters (less than 5m in depth, per Yousef 1974) to experience rapid sediment resuspension episodes. Allowing for slower resettlement and even longer phosphorus suspension times (Yousef 1980), these episodes could have cumulative effects as boating one day adds to the turbidity and nutrient residual from the previous day. These shallows may be as much as 50% of the total surface area of this zone, and therefore shallow lake studies, such as those of Yousef or Hilton and Phillips, cannot be rejected outright as inapplicable.

According to Iannuzzi (1988), phosphorus and algae counts exhibit significant spatial heterogeneity, and are thus unlikely to be reliable as homogeneous lakewide indicators. We assume that the failure of our study to detect a linkage between phosphorus and algae data is due to the virtual isolation of lake zones from each other. We did not have enough observations to compare data within the region of concern.

³ This can be tested using more complete weather data. The wind direction and speed might be assumed to be similar to measures collected in Syracuse or Albany, but the implicit inaccuracy might be problematic.

⁴ The duration of suspension is supported by the results presented here. Lagged values of daily turbidity show statistical significance through the third lag.

Recommendations

Despite our concerns and caveats regarding less-than-optimum data for the purposes of our inquiry, we should point out that Otsego Lake is unique for the amount of study that has gone into it and for the comparative richness of data that has emerged from that study. Furthermore, our comments should not be construed as critical of any institution or individual. We recognize that testing is expensive, and that funding is sometimes intermittent. Nevertheless, because of its potential contribution to elucidating the trends and causes of hydrological changes in the lake (e.g., pH and chlorophyll-a) we would like to see the full potential of a statistical analysis of this type be realized. To that end we suggest that for a few years at least the following particular course of sampling be conducted.

At one site in each of the three principal zones of the lake (the northern or agricultural zone, the middle zone, and the Cooperstown zone), the following regimen of samples should be taken on the same day and at the same time: turbidity (in NTU's); phosphorus; chlorophyll-a; pH; air and water temperature; dissolved oxygen; conductivity; motorboat counts; wind strength and direction; and wave action. In the interest of keeping costs minimal while still building good data sets, only two depths should be sampled at all sites and on all days. Which depths to sample should be found in Iannuzzi 1988. Sampling should occur at about 08:00 in the morning and again between 16:00 and 20:00. Daily sampling is not necessarily required. It is not so much a perfect representation of the lake that is being sought, as a consistent record of the changes that are occurring. The point is to have a record that is consistent and contemporaneous. Subjecting these data to the type of analyses presented here would allow better interpretation of the interactions between turbidity and the other variables. To complete the analysis, we should add counts of tourist, long-term seasonal, and resident populations. We would also need a better grasp of the numbers of failing or marginal septic systems, and the rate at which they are being upgraded. It might also be worthwhile, if it hasn't been done already, to perform a one-time series of tests for septic indicators from the shoreline out into deep water from areas with dense populations, both in winter and summer, to gain a sense of the relationship between the two seasons.

Acknowledgments

The authors wish to express their gratitude for the invaluable assistance they received from Dr. Willard Harman and his staff at the Biological Field Station in Cooperstown; Dr. Ted Peters and the staff at the Cooperstown Municipal Water Works; Drs. John Cole and Nina Caraco at the Institute for Ecosystem Studies; and the work-study students at the Jerome Levy Economics Institute.

References

- Arruda, Joseph A., et al; 1983: The Role of Suspended Sediments in the Nutrition of Zooplankton in Turbid Reservoirs, *Ecology* 64, 1225-1235.
- BFS; 1992: Biological Field Station 25th Annual Report, Oneonta, SUNY State University College at Oneonta.
- BFS; 1993: Reporter, newsletter of the SUNY Oneonta Biological Field Station, Fall 1993.
- Cochrane, D. and G.H. Orcutt, 1949, Application of Least Squares Regression to Relationships Containing Autocorrelated Error Terms. *Journal Of the American Statistical Association* 44, 32-61
- Cullen, Peter, et al; 1988: Estimating nonpoint sources of phosphorus to lakes, Stuttgart, *Verh. Internat. Verein. Limnol.* 23, 588-593.
- Garrad, P. N. & R. D. Hey; 1987: Boat Traffic, Sediment Resuspension and Turbidity in a Broadland River, Amsterdam, *Journal of Hydrology* 95, 289-297.
- Hallock, David D. & C. Michael Falter; 1987: Powerboat Engines as a Nutrient Source in High-Use Lakes, *Lake and Reservoir Management*, Volume III, 172-181.
- Harman, Willard N. & Tracey C. Lindberg; 1991: The public utilization and perception of the recreational use of Otsego Lake, Otsego County, New York; Oneonta, SUNY Oneonta Biological Field Station Annual Report, 1990.
- Harman, Willard N. et al; 1980: *The Limnology of Otsego Lake (Glimmerglass)*, New York?, Academic Press.
- Hilton J. & G. L. Phillips; 1982: The Effect of Boat Activity in a Shallow Broadland River, *Journal of Applied Ecology* 19, 143-150.
- Horsfall, Louise et al; 1988: The influence of recreation, mainly power boating, on the ecology of the Thirlmere Lakes, NSW, Australia, Stuttgart, *Verh. Internat. Verein. Limnol.* 23, 580-587.
- Iannuzzi, Timothy J.; 1991: *A Model Land Use Plan for the Otsego Lake Watershed, Phase II*, Oneonta, SUNY Biological Field Station Occasional Paper No. 23.
- Johnston, D. D. & D. J. Wildish; 1982: Effect of Suspended Sediment on Feeding by Larval Herring (*Clupea harengus harengus* L.), *Bulletin of Environmental Contaminants and Toxicology* 29, 261-267.
- Johnstone, I. M. et al; 1985: The Role of Recreational Boat Traffic in Interlake Dispersal of Macrophytes: A New Zealand Case Study, London, *Journal of Environmental Management* 20, 263-279.

- Karaki, S. & J. vanHofen; 1975: Resuspension of Bed Material and Wave Effects on the Illinois and Upper Mississippi Rivers Caused by Boat Traffic, St. Louis, US Army Corps of Engineers contract # LMSSD 75-881.
- Kortmann R. W. & D. D. Henry; 1989: *Mirrors of the Landscape: An Introduction to Lake Management*, Storrs, CT, U. of Connecticut Press.
- Motorless Otsego; 1993: Otsego Lake Ecological Fact Sheet, Cooperstown, unpublished report from BFS data.
- Morgan, Edward J. & Richard H. Lincoln; 1989: Duty Cycle for Recreational Marine Engines, SAE paper #901596.
- Morgan, Raymond P. II, et al; 1983: Sediment Effects on Eggs and Larvae of Striped Bass and White Perch, *Transactions of the American Fisheries Society* 112, 220-224.
- Newcombe, C. P. & D. D. MacDonald; 1991: Effects of Suspended Sediments on Aquatic Ecosystems, *American Journal of Fisheries Management* 11, 72-82.
- NYS DEC; 1990: *Diet for a Small Lake*, Albany, NY State Department of Environmental Conservation and Federation of Lake Associations.
- NYS DEC; 1992: *Reducing the Impacts of Stormwater Runoff from New Development*, Albany, New York State Department of Environmental Conservation.
- Sharpley, Andrew N. et al; 1991: The Transport of Bioavailable Phosphorus in Agricultural Runoff, *Journal of Environmental Quality* 21, 30-35.
- Stolpe, Nils E.; 1992: *A Survey of Potential Impacts of Boating Activity on Estuarine Productivity*, Doylestown, PA, unpublished report delivered to Marine Engines and Vessels Public Workshop, EPA, Ann Arbor, MI, July 29, 1992.
- Vinghi, M. et al; 1991: Phosphorus Loads from Selected Watersheds in the Drainage Area of the Northern Adriatic Sea, *Journal of Environmental Quality* 20, 439-444.
- Wagner, Kenneth J.; 1990: *Assessing Impacts of Motorized Watercraft on Lakes: Issues and Perceptions*, Alachua, FL, *Lakelines Magazine*, 77-93.
- Wetzel, Robert G.; 1975: *Limnology*, Philadelphia, W. B. Saunders Co.
- Wright, David O. & Kenneth J. Wagner; 1991: Power boats on shallow lakes: A brief summary of literature and experience on Lake Mohegan (NY), *Lake Line* (11)4, 8-12.
- Yousef, Yousef A.; 1974: *Assessing Effects on Water Quality by Boating Activity*, Cincinnati, EPA contract # 68-03-0290.
- Yousef, Yousef A. et al; 1980: Changes in Phosphorus Concentrations Due to Mixing by Motorboats in Shallow Lakes, *Journal of Marine Research* 14, 841-852.

Table 1. Summary Statistics

Var	# obs	Mean	St. Dev
Turb	366	1.078	.4406
Secchi1	35	2.648	.9388
Secchi2	36	4.311	.1481
Secchi3	35	4.403	1.538
WTemp1	45	11.225	8.329
WTemp2	44	11.847	8.199
WTemp3	46	11.155	8.200
ph1	45	7.763	1.196
ph2	44	7.740	1.212
ph3	46	7.769	1.188
chl-a1	43	1.0163	1.066
chl-a2	42	0.8976	0.7273
chl-a3	42	0.6928	0.7922
tp1	10	5.290	2.986
tp2	10	6.280	8.181
tp3	10	3.990	2.2373
maxtemp	366	56.858	20.207
mintemp	366	34.240	19.122
precip	366	0.0905	0.2101

Table 2. Turbidity regressed on Chlorophyll-a.

Variable	Coefficient	T-ratio	Prob-val
Chl-a XX	-.0670	1.02	.314
Chl-a 4c	-.2440	2.634	.012 **
Chl-a XX	-.1389	1.572	.124

** indicates statistical significance to .05 confidence level.

* indicates statistical significance to .1 confidence level.

Table 3. Turbidity regressed on Wave Action.⁵

Variable	Coefficient	T-ratio	Prob-val
None	-.6089	3.484	.001 **
Light	.2285	1.479	.147
Medium	-.1114	.564	.576
High	-.0589	.337	.738

⁵ Wave action only shows a significant difference between no wave action and extreme wave action in terms of its effect on turbidity.

Table 4. Cochrane-Orcutt Regression (pages 69-70). Dependent variable: DAYDIF.

Number of observations: 973

R-squared: 0.3102

F (27, 945): 15.74

Adj. R-square: 0.2905

Prob > F: 0.0000

Root MSE: 0.53185

DAYDIF	Coeff. ⁶	Std. Error	T-ratio	P>t
Date (turbidity) ⁷	-.0000557	.0000831	-0.670	0.503
January	.2364	.1476	1.602	0.110
February	.1168	.1514	0.771	0.441
March	.0935	.1370	0.682	0.495
May	.1728	.1259	1.373	0.170
June	.1501	.1454	1.032	0.302
July	.1735	.1471	1.180	0.238
August	.6049	.1479	4.090	0.000 **
September	1.1753	.1254	9.374	0.000 **
October	.7312	.1166	6.270	0.000 **
November	.6552	.1197	5.471	0.000 **
December	.4445	.1325	3.353	0.000 **
Maxtemp	.0007	.0024	-0.322	0.748
Maxtemp-1 ⁸	.0051	.0025	2.004	0.045 **
DAYDIF	Coeff. ⁹	Std. Error	T-ratio	P>t
Maxtemp-2	.0003	.0025	0.129	0.898
Maxtemp-3	.0065	.0024	2.727	0.007 **
Precip	.1765	.0735	2.401	0.017 **
Precip-1	.2158	.0764	2.825	0.005 **
Precip-2	.1800	.0763	2.361	0.018 **

⁶ In NTUs. The coefficient measures difference in DAYDIF between any day in this month and any day in the reference month -- in this case April.

⁷ Date denotes the daily rise in turbidity not accounted for by the other variables in this model.

⁸ The suffix -1 indicates days of lag. Maxtemp-1 refers to the effects of the high temperature one day ago.

⁹ In NTUs. The coefficient measures difference in DAYDIF between any day in this month and any day in the reference month -- in this case April.

Precip-3	.0202	.0754	0.268	0.788
Precip-4	.0904	.0728	1.241	0.215
Friday	.1656	.0973	1.702	0.089 *
Saturday	.2071	.1062	1.951	0.051 **
Sunday	.2563	.1075	2.382	0.017 **
Monday	.0765	.1059	0.722	0.471
Tuesday	.0418	.1073	0.389	0.697
Wednesday	.1362	.0992	1.373	0.170
intercept	.3758	1.035	0.363	0.717
rho	0.2475	0.0311	7.966	0.000

Figure 1. Annual Turbidity Profile (monthly averages in NTU)

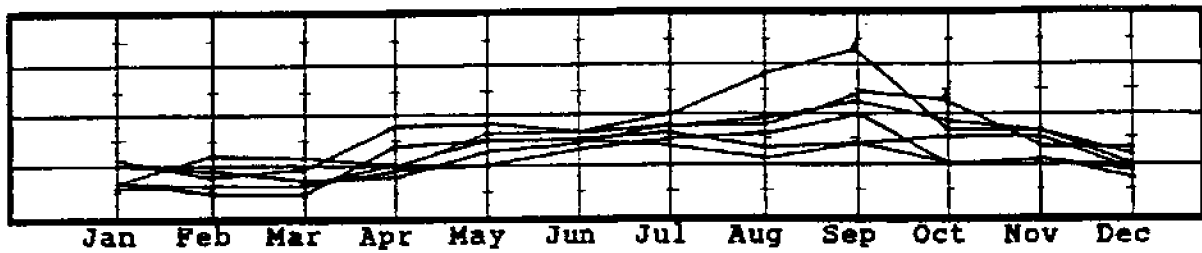

	88	89	90	91	92	93
Jan	0.7	0.7	0.7	0.6	1.0	1.1
Feb	0.6	0.5	1.2	0.7	0.9	0.8
Mar	0.6	0.5	1.1	0.7	0.7	0.9
Apr	0.9	1.4	1.0	1.0	0.8	1.8
May	1.0	1.5	1.5	1.6	1.3	1.8
Jun	1.3	1.5	1.5	1.6	1.4	1.6
Jul	1.5	1.6	1.4	2.0	1.7	1.8
Aug	1.6	1.3	1.1	2.8	1.7	1.9
Sep	2.0	1.4	1.4	3.3	2.3	2.2
Oct	1.0	1.0	1.5	1.7	2.2	1.8
Nov	1.1	1.1	1.5	1.6	1.4	1.7
Dec	0.9	0.8	0.9	1.2	1.3	1.0

Figure 2. September 5, 1993 overlay plot of boats:turbidity:total phosphate.

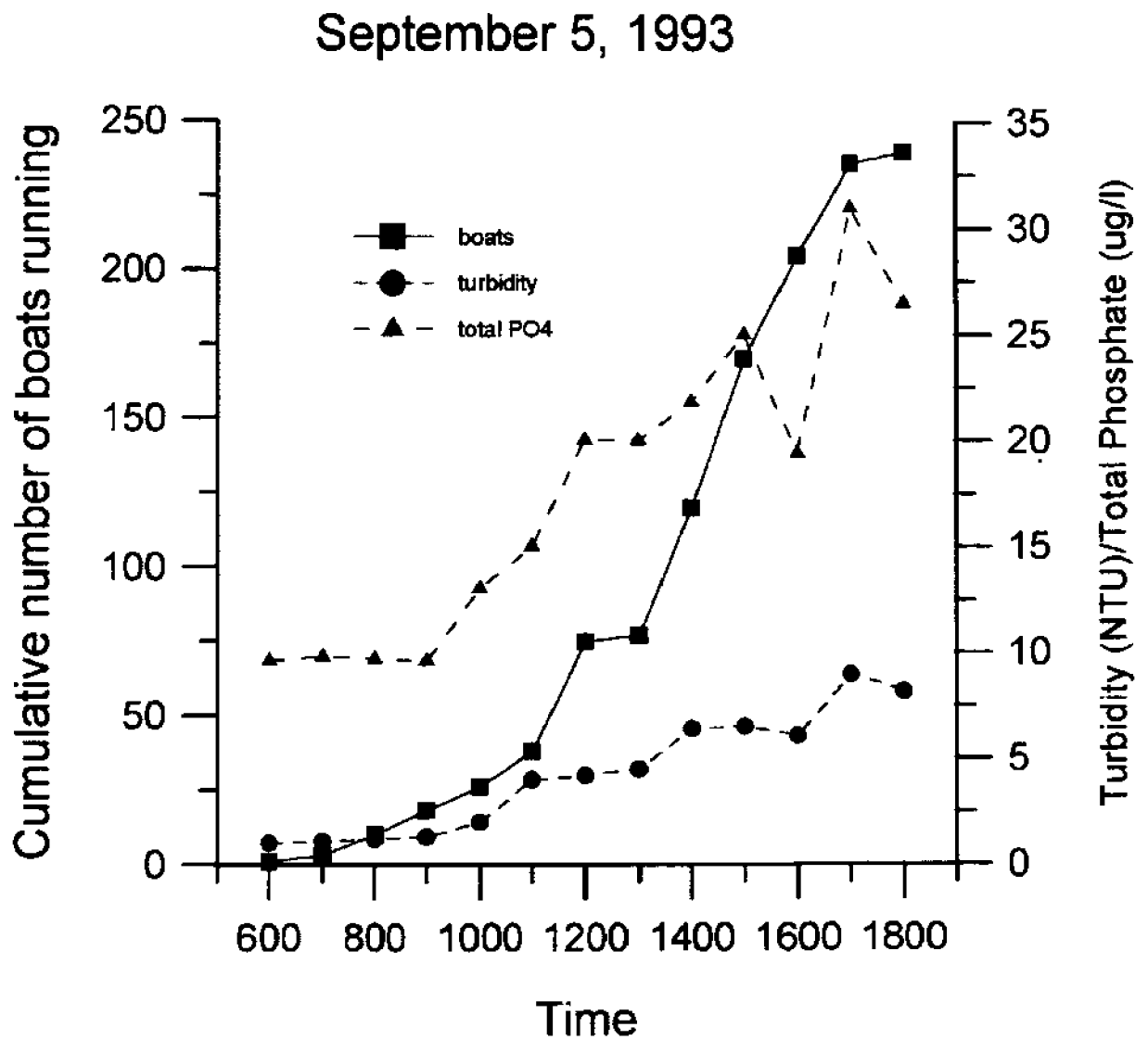

Figure 3. Empirical relationship between Secchi disk transparency and specific phosphorus loading for upstate New York lakes. (From *The Limnology of Otsego Lake*, Harman and Sohacki 1980, by permission.)

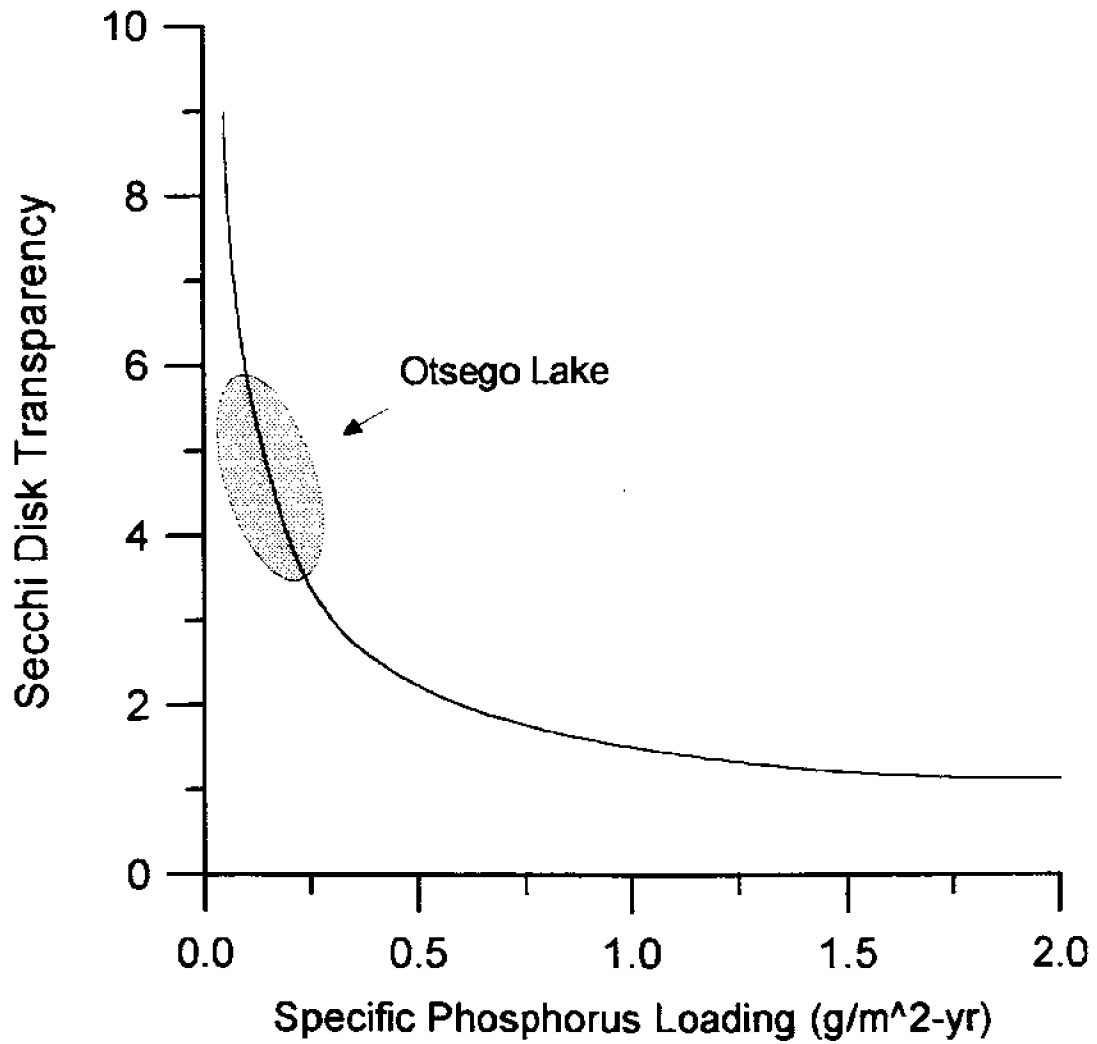
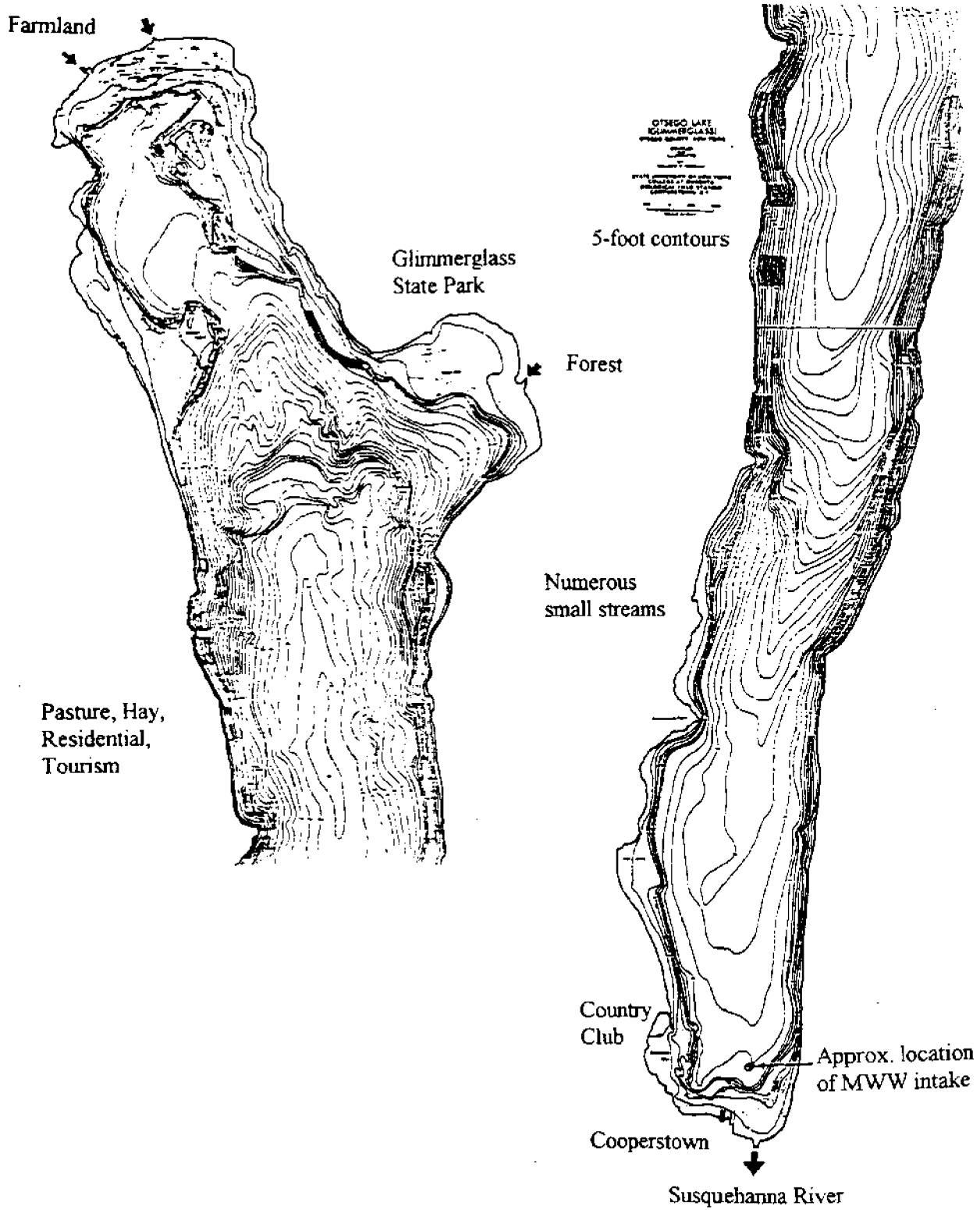

Figure 4. Bathymetric map of Otsego Lake, N.Y., also known as Glimmerglass.



Measuring Boating Effects on Turbidity in a Shallow Coastal Lagoon

Richard E. Crawford

Waquoit Bay National Estuarine Research Reserve, P.O. Box 3092, Waquoit,
Massachusetts 02536

(Editors' note: This talk relied on slides to convey much of the content of the presentation. In this edited text, the notation [slide] indicates where the presenter was referring directly to a visual aid.)

The study I will be discussing was done in a shallow lagoon with lots of current. As such, it is the opposite situation from what you have heard from Dr. McCarthy about his studies of turbidity in a quiet lake. A significant similarity between the two studies is that we too were looking for a tool for resource managers. In our case we were seeking a predictive formula to help evaluate the potential impacts of boats, docks and bulkheads to shallow marine ecosystems, in the context of providing information of use in the review of permit applications. The work was funded by NOAA, originally to the Massachusetts Coastal Zone Management Program which later sought the assistance of the Waquoit Bay National Estuarine Research Reserve (WBNERR).

From studies done in Southern California and Southern Florida, and which is intuitively obvious to boaters in general, we know that motorboat operations in shallow areas will resuspend sediments and increase turbidity. We see this frequently in Waquoit Bay so we had a good idea of what to expect and where to study this phenomenon. But designing an experiment to explore the relation between the amount of turbidity or resuspended sediments caused by boating activities was a challenge because of all the variables that we had to consider. The sparseness of related literature also offered little help in this area.

There are two types of wake effects associated with running a boat. One is associated with the surface wave or boat wake that erodes the shoreline. The other is from a pressure wave beneath a traveling boat hull. The pressure wave has two components. One is caused by the hull itself and is a low frequency wave. The other is from the higher frequency disturbances from the turning propeller and the sounds in the engine exhaust. Much of the literature on the subject of the impacts of boat operation considers the effects of shoreline erosion caused by a wake. We were specifically interested in looking at the effects of pressure waves on the bottom.

I was flying over Waquoit Bay—I think this [slide] was in May—and noticed a dark band of sediment in the wake of a moving boat. It was a good example of what we were concerned about. This concern was stimulated by our curiosity about motor boating turbidity as a potential agent responsible for the loss of eelgrass in the bay?

Waquoit Bay, as recently as 20 years ago, had large, expansive eelgrass meadows. But in 1993 I could not find any eelgrass in these meadow areas. Although the phenomenon of loss of eelgrass beds has been seen in many other areas too, a definitive explanation for its cause remains elusive. While disease and eutrophication are two likely causes, we studied whether light reduction caused by turbidity from boating activity could also be a factor contributing to this loss.

I set up a study area that enclosed the location where I had photographed the very visible turbidity plume. The area was a rectangle north of the main breachway in the barrier beach and encompassed a segment of the navigation channel. Waquoit Bay is well flushed by tides; water in the bay has an unusually brief residence time of about two or three days. The bay is shallow and fairly uniform in depth (average about 1.6 m) but the main navigation channel is slightly deeper. A smaller channel branches east from the study area so boat traffic converges (or diverges) there.

Three methods were used to collect data. To measure turbidity and several other parameters in a boating area, I moored a SeaCat SB-16 a data logger near the study area. The logger had sensors to measure dissolved oxygen, salinity, temperature, and water level above the unit. It also had an optical backscatter sensor (OBS), a device that indirectly measures turbidity. A separate method of collecting data, used when the boat was anchored or drifting, involved an instrumented staff for collecting depth profiles of data. It had sensors [slide] to measure dissolved oxygen, salinity and temperature. The OBS was also rigged to the staff, as was a spherical light sensor to measure photosynthetically active radiation (PAR) penetrating the water column to the test depth. There was also a pump to collect samples for turbidity measurements with a turbidity meter aboard the boat. All sensors were situated on the staff so that each staff sample at a particular depth level involved a range of only several centimeters. The PAR sensor was off to the side of the rest of array to avoid shading. There was an additional PAR sensor in the boat [slide] which measured surface quantum irradiance (PAR). The difference between the readings of the surface and submerged PAR sensors gave a measure of light extinction.

The third method of collecting data involved mounting only the OBS on another staff [slide]. It was rigged to be used when the boat was moving. When it was lowered beneath the hull, we could follow moving boats and get direct measurements at various depths of the optical backscatter in their propeller wash.

The speed limit in the bay is about six miles an hour. The whole bay is designated as a "no wake zone". The harbormaster told me he had no problems with boaters complying with the speed or wake restrictions [slide of a speeding boat]. As you can see here, what I encountered was quite different. Acting as if they were in a water skiing area where speeding is allowed, many boaters would disregard the restrictions and travel at high speeds generally throughout the bay. This presented several challenges.

Of the three methods we used, using the OBS to track turbidity in boat wakes collected the most amount of data but we had difficulties with it. The biggest problems were our inability to go fast enough to keep up with the speeding boats and the amount of algae that got kicked up in a boat wake. The staff and the sensor mounted on it would collect seaweed, obscuring the sensor and disrupting our readings.

Much of the time I relied on an echo sounder to tell me when I was in the wake when we were moving; it was difficult to locate the center of the wake visually in boat traffic. But the propeller wash that is discernable with an echo sounder (sediments and exhaust bubbles) is extremely narrow. It remains so for a surprising distance behind the boat, not fanning out at all. At about 100 yards behind a boat this [slide] is the echogram you would see. Mariners call this disturbance a knuckle. For example, sonar operators can track the wake of a ship for hours looking at the knuckle and it is the same kind of thing here. Because the propeller wash does not fan out as the boat wake does, it remains a very localized phenomenon, as you can see in this echo sounder trace. The depth here is five feet—fairly shallow. The stray echoes in the echogram are from the seaweed that gets kicked up by the turbulence.

The sediments contained a lot more clay [slide, showing 47%] than in those shown by Preston Hartge from the Maryland sites, a fact that contributed to our difficulty in tracking “knuckles”. The amount of sand in samples from the study area was a much smaller fraction (8%). To determine sediment size fractions, we took four samples in the study area, ran them through a set of sieves, and calculated the dried fraction retained by each of them. Fines that were not retained by a 0.067 mm mesh were classified as clay. In addition, we took sediments from the study area and prepared different sediment concentrations in a test tank fitted with a stirrer. We used measurements from this tank to relate sediment concentration to the output of our OBS instrument and our measurements of turbidity. In the field, quite often we obtained measurements of roughly 100 - 150 millivolts with the OBS sensor (Fig. 1). The laboratory tests revealed that anything greater than that usually indicated that seaweed was fouling the unit, which was quite often the case in the wakes of bigger boats. Generally, at readings less than 150 millivolts, we were in the realm of 0.25 gram per liter of sediment or less, depending on sediment particle sizes.

I should mention that all of these data are from slow-moving boats. I ignored fast moving boats because I could not use the tracking OBS sensor at speeds greater than about six miles per hour. Also, the literature indicated, and as we have heard today, that at high speed there is less influence from the pressure waves of planing hulls. Since we were working in a no-wake zone with a six mph speed limit, I followed the boats that were going more or less according to the rules.

Our observations repeated a theme that is common in the literature—highly variable readings. It seems intuitive that this would be the case. These measurements are being made in a

turbulent system. And if you place a non-hydrodynamic probe like ours into turbulence, you create even more turbulence. So it is not surprising that we had a hard time getting a handle on some of these values. Nevertheless, we did make some definitive observations.

We saw the time decay in changing turbidity after a boat passage that we would expect. When a test vessel passed, the turbidity increased (Fig. 2). And with the second and third passes (spaced by roughly 3-5 minutes), the cumulative result was an additional increase in turbidity. But when the boat left the area, the suspended sediment quickly began to settle out. After 10 minutes the amount of light reaching the bottom had markedly increased. Eelgrass would have been negatively affected by the reduced light levels measured immediately after vessel passage but it is a short-term phenomenon. By 10 minutes later, light sufficient for the needs of eelgrass was reaching the bottom.

During our efforts to obtain this type of depth-profile observation, we found that anchoring in the channel to do our sampling was not the best idea. We tried waiting until a boat would go by and then would pull into the wake area, jam some pipes into the bottom to fix our position, and do a profile in the plume [slide]. Boaters understandably objected to our presence in the navigation channel but it was difficult to keep the sensors in the narrow sediment plume without anchoring the boat in some fashion. When we were successful, we found that our test results (Fig. 2) mimicked field observations; about 10-15 minutes after boat passage, the light levels in the water column were again favorable for eelgrass growth.

The OBS records obtained with the data logger had several common traits. Short-term event spikes in the data were common, as in the record for Sept 3-11, 1994 (Fig. 3). Although during much of Labor Day weekend in 1994 (September 3-5) the weather was poor and not conducive to recreational boating activity, this was not case for September 3. There was a large "data spike" in the record for that date (Fig. 3). With a closer examination we can see the "spike" is composed of several separate events (Fig. 4). Given that the unit made a recording every 15 minutes, and this is similar to the amount of time for re-suspended sediment to settle out before the next sample, one event could represent the passage of a boat(s). This pattern is repeated in the example so that the "data spikes" of Figure 3 can be resolved into a series of brief events that constitute individual spikes in and of themselves. Interestingly, in this example the spikes occurred on each day between roughly 10-12 p.m. That is curious.

Besides turbidity and its associated effect on light extinction, the only other parameter of those we studied that varied measurably was the oxygen level (Fig. 5). In the channel, readings were about 1 mg/l or so less than they were about 300 m away. In such instances, the odor of hydrogen sulfide was quite prominent in the channel. It was not surprising that the concentration of dissolved oxygen was reduced.

A bathymetric map of the study area made with echosounder data appeared to reveal a dredged channel passing through a small hummock-like feature. But observations with scuba revealed that what was being indicated as the bottom was actually a lush carpet of algae that was about 0.50 to 0.75 m thick. When echogram data were corrected for the thickness of the algal mat the actual bottom contour was roughly a straight line, not at all what the echosounder measurements would indicate.

Algae thrives in the bay because of high levels of nitrogenous inputs from watershed and atmospheric sources (Valiela et al. 1992). I believe boating contributes to algal growth in the summer because the boating activity in the area keeps turning the algae over. Light extinction measurements made in the algal mat and in an eelgrass bed in a separate pond indicate that only about ten centimeters or so of algae would reduce light to about the level measured at the bottom of the eel grass bed. When we have an algal mat 0.5 meter thick, we are dealing with almost no light at all at the bottom (Fig. 6). The algae in the shade at the bottom could not thrive in that situation as they do if they were left that way. When boats come through, they stir up the water column and the algae that were on the bottom are lifted and exposed to light. (This is the same mechanism that increases phytoplankton productivity in the open sea, whereby sinking algal cells in the lower portion of the euphotic zone are returned to shallower waters by swirling currents, such as those from Langmuir circulation). Disturbance from the pressure waves beneath moving boats may also stir up nutrients that are within the surface layer of organic matter on the bottom of the bay. In these ways boating would tend to increase the exposure of algae to light and nutrients and the growth of the algae would be stimulated.

Although the occurrence of the "hummock" of algae in the study area was unfortunate, it taught us a lesson in choosing future study areas. Algae accumulates in the study area apparently due to the action of currents. We noticed that as the flood tide passes northward up the channel, a countercurrent comes southward down the eastern side of Washburn Island. When this countercurrent hits a sandy point bar to the west of the study area, the flow is directed eastward toward the location of the hummock. The confluence of this countercurrent with the flood tide current in the channel apparently helps to accumulate algae thickly in this part of the study area. Future site selections should include consideration of bottom cover and local current flows.

While we did get measurable changes in the turbidity stirred up by boats, the transferability of these results to other situations is complicated by the existence of the thick mat of algae. We felt that the algal mat might be interfering with the amount of pressure wave energy reaching the bottom. The algae could provide a "cushion" so that the turbulence may not access the fine bottom sediments as readily as it would without the algal mat there. If so, the mat interferes with the disturbance of the sediments and could actually reduce the level of resuspended sediments.

In my efforts to develop a predictive equation describing the general impacts of boating I have come to the same conclusion others have expressed today—this is not going to be an easy task. However, managers and policy makers are growing increasingly impatient in being told that there are no short-term solutions to these difficult problems. This is not surprising since we are studying in a milieu of turbulence with a very complex series of interactions and lots of variability. What we need to do is redefine our tactics as to how we go about trying to come up with information useful for formulating new approaches to management. We need a lot more research and we need to educate the managers and policy makers of the difficulty posed by their requests for models describing the impacts of boating. We need more of the types of studies that we heard previous to mine and I believe we need to continue the kind of work I am talking about here. And at least for the shallow eutrophic lagoons that we have in southern New England, we need to create models that account for algal mats and their interaction with the effects of boating.

Valiela, I., K. Foreman, M. LaMontagne, D. Hersh, J. Costa, P. Peckol, B. DeMeo-Anderson, C. D'Avanzo, M. Babione, C. Sham, J. Brawley, and K. Lajtha. 1992. Couplings of watersheds and coastal waters: Sources and consequences of nutrient enrichment in Waquoit Bay, Massachusetts. *Estuaries* 15: 443-457.

Q (by Sandy MacFarlane) Both you and Mr. Hartge mentioned that the turbidity is less—or is greater, I should say, with slower speeds. Are you both attributing that to the fact that the engine is higher off the bottom if the boat is on a plane—

A (by Rick Crawford) No, that is—

Q —even though it is turning faster?

A I am glad you asked that. I happen to have an overhead for that one.

Q I played right into it.

A Yes. This is from Yousef's work in Florida. It is the output of a model that predicts the forces around a propeller. I was surprised myself when I started thinking about this because the slower a boat goes, you would think there would be less of a problem. At least it is assumed that slow no-wake zones result in the least amount of damage to the bottom. But when you look at the physics, the faster a boat goes for a given thrust in the water (e.g., a planing hull), the shallower are the depths affected. This is derived from physics and computer programs, not field data. If we know these things from physics, we could put these kinds of things into our knowledge base and into our management plans. We do not have to go out in the field and re-invent the wheel.

There are also relationships—these are predicted from physics as well—as to the relation between the size of a bottom sediment particle and its response due to the horsepower and water depth. These require several assumptions. You have to know something about the surface

contour, the adhesion of the particles, and the particle characteristics. If you can measure these characteristics and put them into these kinds of models, we might be coming up with easier things to work with than trying to go out and chase boats.

I should mention that while I was doing that, the boat drivers that I was chasing were pretty suspicious of what I was up to. I was actually threatened by more than one. That was another reason I went to the depth profile measurements.

Q (by George McCarthy) Did you come up with any kind of policy guidelines from this? I mean, did anything occur to you as to what you could implement from the study?

A I am not in that business. I recommend. But one of the things that I would suggest, at least in the lagoon I was working in and because of large primary and secondary waves, and because of the extensive boat use, is the need to move the channels as far from shore as possible to minimize the effects of the surface waves. The way it is now, channel placement is sort of a convenience. You enter the mouth of the channel and just head to the end of the bay, passing quite near this island. I am sure we are exacerbating the turbidity and the shoreline erosion there because we are going so close. The bottom of the bay is pretty similar everywhere and we have plenty of room to move the channels away from the island. That would be one recommendation.

Q (by George McCarthy) And what is the relationship between eelgrass and algae in this case? Do they compete?

A Yes, that is a complicated issue we have been studying a lot. The eelgrass light-use is about an order of magnitude less efficient. That is, they are less capable than the algae are, so they need at least somewhere around ten percent of the surface light while algae can deal with one percent. Under the existing eutrophic circumstances due to excess nitrogen in our bays, light reduction from phytoplankton blooms can have more impact on eelgrass than on algae. So the algae will thrive where the eelgrass do not and the algae may overrun the eelgrass. There is also a disease that is affecting the eelgrass. The algae are exotic species that have been introduced. As the eelgrass is becoming stressed and diseased, the algae have been moving in. We have lots of algae and very little eelgrass.

This work was supported by the Waquoit Bay National Estuarine Research Reserve, Massachusetts Department of Environmental Management, Division of Forests and Parks - Region 1, P.O. Box 3092, Waquoit MA 02536 with funding provided by several grants from the National Oceanic and Atmospheric Administration, Office of Coastal Resource Management, Sanctuaries and Reserves Division.

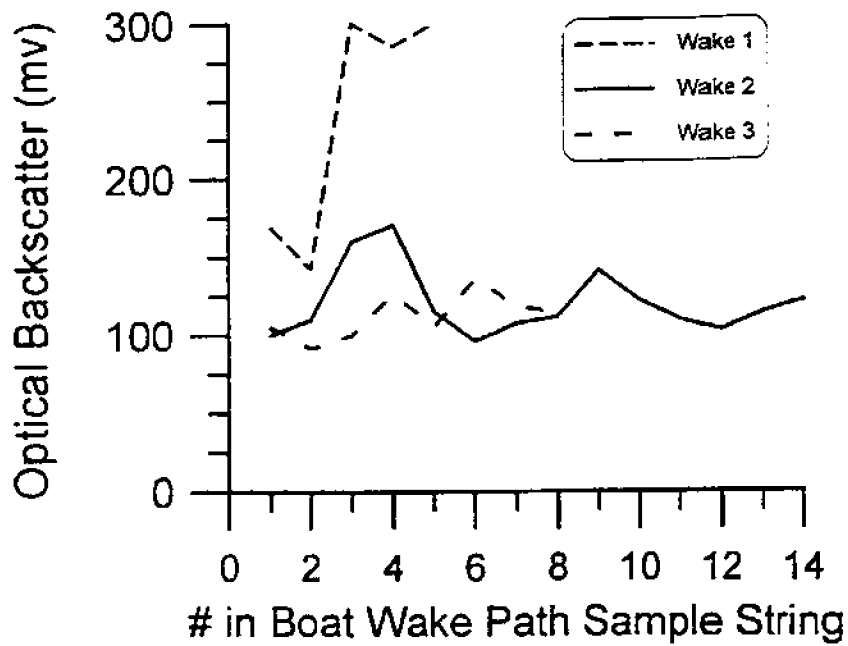

Figure 1. Optical backscatter (OBS) from resuspended sediments in boat wakes as determined while travelling behind moving boats.

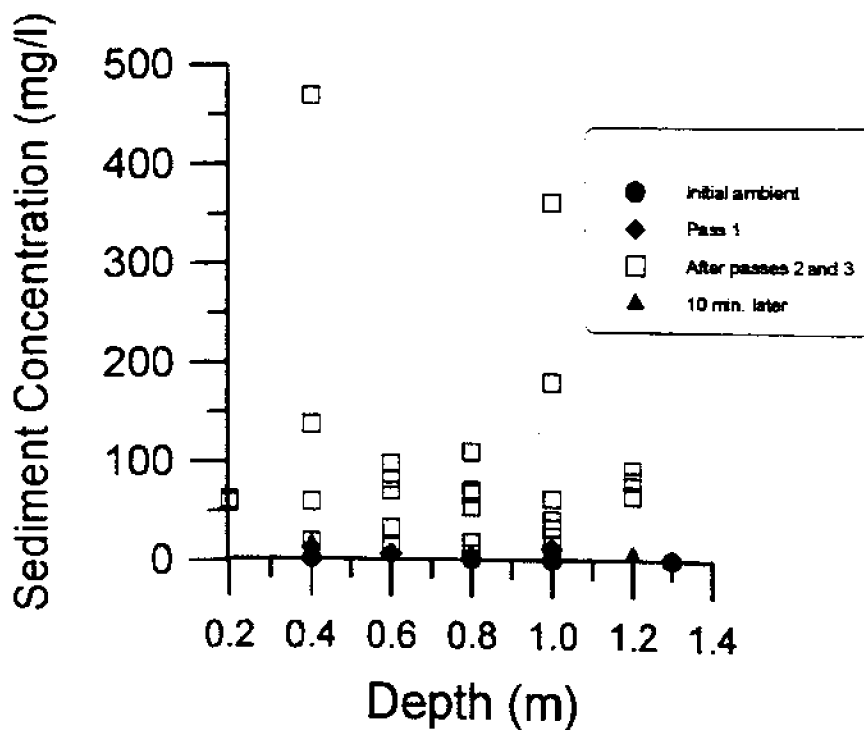

Figure 2. Change in suspended sediment concentration in the water column after up to three passes of a 200 hp dee-vee hull vessel. Water depth 1.5 m. 10 min after pass 3, sediment concentration approached pre-test levels.

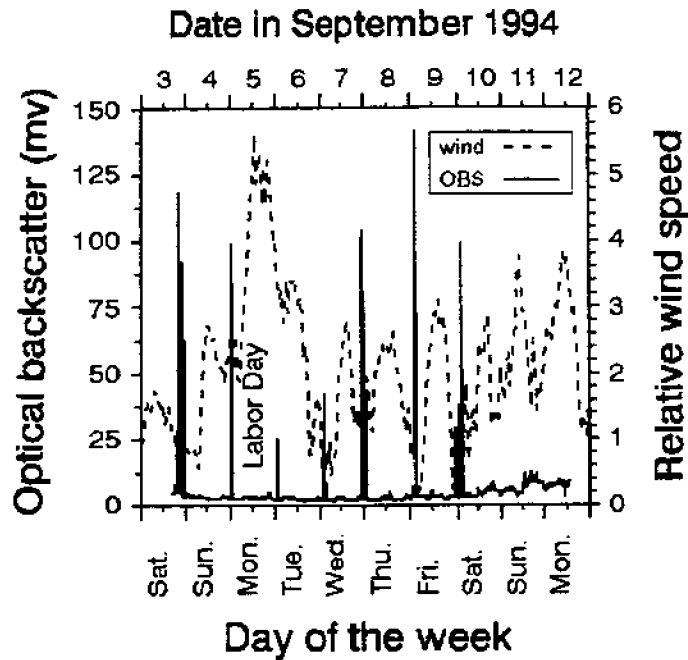

Figure 3. Optical backscatter levels were unrelated to wind speed (uncalibrated anemometer) on several days in September 1994 at an instrument mooring site 100 yards from the navigation channel. Spikes in backscatter suggest nocturnal biological activity (plankton) on most days. Only data from Saturday, September 3 appears related to a period when boat use was high (see Fig. 4). Inclement weather on September 4-5 diminished boating activity on those days.

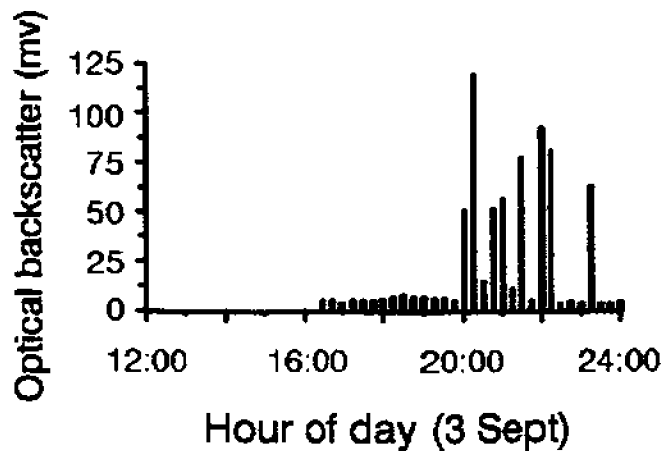

Figure 4. Optical backscatter measured during Saturday of Labor Day Weekend, 1994, a period of intense boating activity. Increased levels, suggesting elevated turbidity from resuspended sediments, beginning at 20:00 hours may be related to boat traffic returning to a nearby marina.

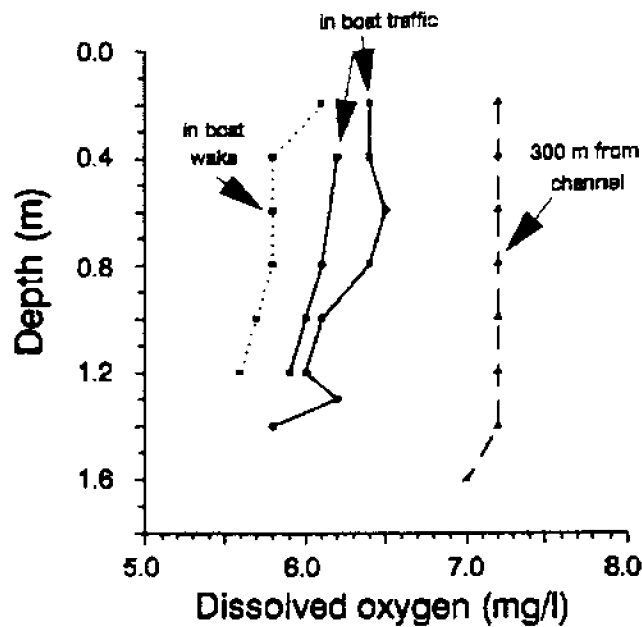

Figure 5. Depth profiles of dissolved oxygen concentration at several locations when numerous boats were being operated in Waquoit Bay. Concentrations were lowest in the navigation channel, particularly immediately after the passage of a boat (boat wake).

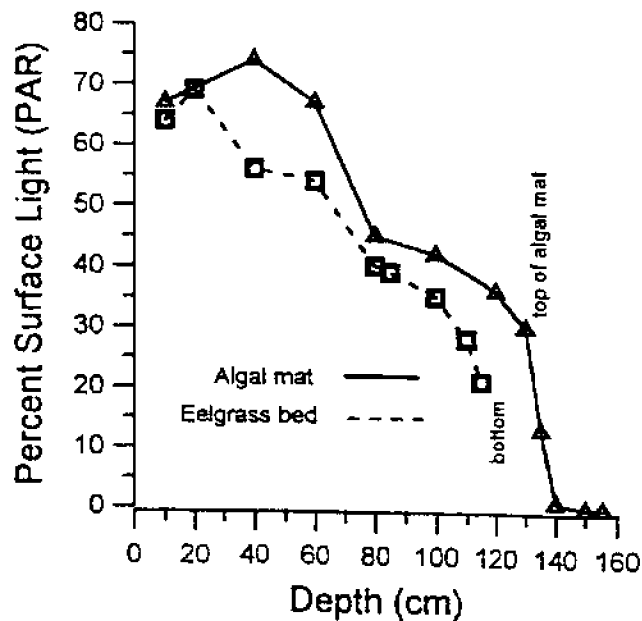

Figure 6. Depth profiles of light levels determined in an eelgrass bed area and in a different location where eelgrass was absent but the bottom was covered by a 30 cm layer of macroalgae. The bottom of the eelgrass bed received about 20 % of surface light but >2 % reached the bottom beneath the algal mat.

Possible Effects Of Propeller Shearing On Zooplankton

Larry Madin

**Biology Department, Woods Hole Oceanographic Institution, Woods Hole,
Massachusetts**

I want to preface my talk with the disclaimer that it is about a subject for which I have absolutely no data and very little experience. But in these aspects it fits with in other speculative presentations I have heard at this workshop. That is, in my perusal of the literature I have learned that no one else has experience with this subject either. There are, indeed, probably fairly easy ways to experiment with this question of the effect of turbulence produced by boat propellers on these animals, and perhaps some work of that nature will eventually be done. But what I would like to do is say a little bit about the nature of the zooplankton communities in these estuarine environments.

What literature there is on the effects of such things as boating, power plants and so forth seems to be rather heavily directed towards fish, understandably. But we have to remember that underneath the fish there are several trophic layers of phytoplankton and zooplankton which support these populations of fish. This is particularly important in estuarine environments which are highly productive, highly seasonal, and impacted by all kinds of anthropogenic effects. Estuaries are also the nurseries for many, if not most, of the commercially important fisheries in the area: fin fish as well as many of the shellfish species often have planktonic larvae that spend some amount of time in the water column, very often in the spring and summer when boats are also active.

The existing information is very sparse in considering what might happen to zooplankton when boats go by. Certainly a comparison with power plants is probably the most appropriate one that we can make at the moment. There have also been some experiments having to do with the effects of turbidity and so forth on some zooplankton.

In continental shelf waters and estuaries there are usually fairly simple food chains with fairly low diversity, very often a high biomass, high productivity, and a relatively large number of species of phytoplankton—such as diatoms—eaten by a group of primary consumers, mainly copepods. *Acartia* sp. for instance, is usually the dominant estuarine copepod in this part of the world. Benthic herbivores are represented in the plankton by their larval stages, some of which are feeding stages, and some of which are not. We also have gelatinous predators—jellyfishes and ctenophores—which are very abundant in many of the eastern estuaries such as Narragansett Bay and Chesapeake Bay. These have a very significant structuring effect on the entire ecosystem because they are the main consumers of the copepods, which are the main consumers of the

phytoplankton. A system can be upset when a lot of jellies enter an estuary and eat an abundance of copepods. This can have effects which ripple back down, and sometimes results in phytoplankton blooms.

Given the above, what are some things about the biology of these animals which we might imagine would make them susceptible to various consequences of boating activity? The obvious one is that they are going to get chopped to bits. In the case of the gelatinous animals, and particularly if you have ever had to deal with the sea wasps which fill Chesapeake Bay in the summer, chopping them to bits with boat propellers might seem like an excellent idea. It has not been applied in a systematic way yet as a means of getting rid of them, but...

What we know about the feeding biology of copepods is that they are dependent on a fairly complicated behavior that is mediated by sensory inputs. They are not just "mindless" little filtering machines. On their antennae are sensory hairs which are responsive to mechanical vibrations, essentially disturbances in the water pressure, and there are also chemosensors, which are sensitive to essentially the smell of things that are nearby. We now know from microcinematographic studies of the feeding biology of these animals that, in fact, copepods sense individual passing phytoplankton cells, chemically and mechanically determine whether or not they are suitable as food, and then make a "choice" about whether to eat them or not. This requires that a certain very small scale flow field be maintained around the copepods, such that these sensory signals can be directed in the right way and the copepod can orient toward them and make its choices about feeding. It is apparent that there may be some unknown level of turbulence, when introduced into the environment of this animal, which is going to upset this process. Experimental work on the feeding behavior of these animals in turbulent environments is just beginning now.

Before we leave the copepod, I should mention that copepods and all these other animals have to reproduce and they produce pheromones, chemical signals involved in locating mates for that purpose. Since these are signals that are born through the water, you can imagine that turbulence of some scale may also have an effect on that process. That would apply to a great many marine organisms. We do not know the details of very many of them, but as a general rule, where there are chemical signals involved in coordinating the behavior of things, you can expect that turbulence may have some impact.

The comb jelly, *Mnemiopsis leidyi* get to be quite large. They are easily physically disrupted by outboard motor propellers, I am sure. They are also able to regenerate if enough of them is left, and so this does not necessarily eliminate them from an estuary. It may just temporarily reduce their numbers. These are, as I said, voracious predators on the copepods. They are also capable of very rapid population growth and so they develop very large populations seasonally in most estuarine environments. Propeller shearing from many boats would have an effect on the growth of their populations.

Other things, such as certain species of jellyfish, are predators on the jellies as well as on larval fish and on copepods to some extent. They are sort of indiscriminate top level predators. There is a certain amount of hydrodynamics involved in the feeding of these animals also, although not very much is known about that. But, in general, since they are often near the surface, they would probably be very susceptible to simple direct destruction.

Planktonic larval stages of many invertebrates can be on the order of a millimeter or so in length, some with bristly spines which presumably affect (i.e., reduce) sinking rate. It may be that the disruption of those, if they are damaged by turbulence, would have an affect on their ability to sink and maintain their position in the water. Likewise, veliger larvae of gastropods are little things in shells which you would think of as being fairly hard and resistant to disturbance. However, they have very long gelatinous feeding appendages which are stuck out in the water and which are probably much more delicate. The reason I mention these examples is that a lot of animals which appear to be fairly sturdy do, in fact, have appendages of some kind which are very crucial to their feeding biology, to their orientation in the water, or to their sensory reception. These appendages may be relatively more subject to damage from turbulence than other parts of an animal. This also applies to the relative response to turbulence by different life stages of an organism. Many species of sea stars are pretty sturdy animals that can tolerate a large amount of turbulence, but in their larval stages they are big gelatinous creatures which might react very differently.

Unlike many other planktonic organisms, larval fishes are prevalently visually oriented predators, but they also have lateral line systems which are very sensitive to near- and far-field vibration sources. You might expect that fish larvae would be affected behaviorally by turbulence induced by boats and propellers. As far as I know, there is not very much known about any of this, so we are free to say what we would like at this point.

The amount of direct destruction of an organism is certainly proportional to its size and depends on the scale of the turbulent eddies generated by propellers. Certain organisms may be small enough that they are not really affected. They may get tumbled around safely in a little "cell" and everything is fine right around them. At some point, when they or other organisms are a little bit larger, they would be big enough to essentially intersect the shear lines that are created by these turbulent forces and then they would get ripped apart.

So, the other variable, of course, is how sturdy they are. Gelatinous animals are clearly not very sturdy and may be much more susceptible to these forces than crustaceans. Most estuarine organisms, because they live in a fairly high energy environment even without motorboats, because of tidal cycles, storm events, ice, and because of a number of other features, tend to be tougher than anything you would find out in the open ocean. But, of course, there is not a boating problem out there, so...

We mentioned ways in which shear and turbulence may interfere with feeding, that nearfield turbulence can disrupt swimming behavior and the sensory flow fields that are involved in the detection and location of food particles. Conversely, there is another characteristic of feeding behavior that is referred to in some models of feeding interactions by zooplankton as "encounter rates between the organism and the prey". To some extent these encounter rates depend on turbulent mixing, where an increasing mixing rate will increase the likelihood that a predator is going to encounter something that it can eat—in other words, that a prey item comes within range of the predator so it can be detected. It is unclear whether or not the effect we are talking about might be of a level which has the beneficial effect of increasing the encounter rate, so making the predation easier, or whether it is of a level which interferes with feeding by essentially disrupting the sensory field that the organism is depending on.

I want to give you a back of the envelope calculation about how many animals might be affected. We had an estimate in a previous talk for the amount of water that propellers would wash through at thirty miles an hour. I applied this number to the sort of average densities of zooplankton species that I showed you a moment ago in Narragansett Bay and also some data in Chesapeake Bay and it produced a rough estimate of something like one and a half billion zooplankters—copepods, etc.—passing through the backwash of one boat in one hour. For the jelly animals, it is five hundred liters of this one and a couple hundred liters of that one. So, potentially, there is a significantly large number of animals being affected by this "average" boat in one hour. I can not tell you what the total number of animals in a bay is and what percentage this is, but if we assume that there was total destruction of these things, then over time it would seem to me that this mortality would affect the size of the total population.

Some of the other effects which we really do not know much about and which I am only going to mention include turbidity. Turbidity would be expected to interfere with feeding of many types of zooplankton, first of all because they would end up eating a lot of silt or other non-nutritive particles that get stirred up off the bottom. These particles, in addition to their general inedibility, may also have adsorbed hydrocarbon pollutants or other contaminants on them that we can perhaps attribute to boats. There is also a potential effect of impaired visibility, simply because the water clarity is not very good and organisms which are visually oriented predators find that the distance at which they can see something is much reduced, whether what they are seeing is prey or a predator which they would like to see soon enough to get away from.

Another related effect is generally reduced light penetration that decreases the depth of the photic zone, which is often not very deep in these estuarine waters anyway. This would have an effect on primary production photosynthesis rates. There may also be effects on light-cued behavior. Even in fairly shallow estuarine and coastal waters there is a certain amount of vertical

migration where organisms go up near the surface at night and down deeper in the water during the day. This is cued by light level; reduced light penetration may affect that behavior.

Lastly, there is potential for simple chemical pollution effects from engines, bottom paint, or sewage. As we know from studies on other organisms, very often sublethal effects are more insidious and serious in the long run, such as effects having to do with reduced reproductive output and behavioral aberrations. There is some literature on this for zooplankton—a few hardy copepods—but there is much more on commercial species like fin fish or lobsters.

As I said, I did not have any real data to give you and so I have attempted to summarize briefly the kinds of interactions that might be expected if we knew the level and scales of physical, chemical, visual and turbid impacts resulting from boats and propellers. It is very important to know the scale of magnitude of these effects relative to the size of affected organisms, and to the size of the immediate undisturbed environment that a particular organism has to maintain. The kinds of experiments and research we have been discussing at this workshop would certainly be a beginning in that direction but as far as I know, none of that has been done yet. It is an open field and feel free to do it.

Q (by Ellie Dorsey) What about vertical distribution of the zooplankton? Are there some that might be more susceptible to turbulent effects because they can stay right near the surface, and are there others on the other hand that might be less susceptible because they tend to stay lower down in the water column?

A Yes, there are certainly vertical differences. These coastal waters tend to be fairly well mixed relative to those waters further offshore, but there certainly are vertical differences that are maintained behaviorally. You would have some species — And typically also young larval stages, juvenile stages might be found sometimes near the surface. You might expect them to be a little more susceptible, too, just because of their size. I'm sure that there are different vulnerabilities depending on where in the water column things are. But of course in something as shallow as Barnegat Bay it is going to be so well mixed and stirred up by boats, if nothing else, that it wouldn't make too much difference.

One other point that I didn't mention before is that the larvae of benthic species spend some time in the water column and eventually they settle. The process of settling depends to some extent on hydrodynamic forces: the rate at which they sink, the rate at which currents carry them one way or another, the nature of the bottom that they're passing over, whether it's got a deep boundary layer or shallow boundary layer. So there's a lot of hydrodynamic effects having to do with where those things settle out. So another possible thing to think about is that if those naturally occurring variations and the current pattern and so forth get churned up a lot, that settlement of larvae onto the bottom may be effectively disrupted.

Toxic Effects of Outboard Motor Emissions on Fish

Presented by Malin Celander, Biology Department, Woods Hole Oceanographic Institution,
Woods Hole, MA - at the request of Lennart Balk

Balk, L., Ericson, G., Lindesjö, E., Petterson, I., Tjärnlund, U., and Åkerman, G.
Institute of Applied Environmental Research, Stockholm University, S-61182
Nyköping, Sweden.

Effects of exhaust from two-stroke outboard engines on fish - Studies of genotoxic, enzymatic, physiological and histological disorders at the individual level.

TemaNord 1994: 528 (66 pages).

Nordic Council of Ministers, Copenhagen 1994

ISBN 92 9120 439 0

ISSN 0908-6692

The report will be sent free of charges on written request to Nordic Council of Ministers, Store Strandstraede 18, DK-1255 Copenhagen K, Denmark. Fax (+45) 33 96 02 02.

This presentation describes work conducted by a research group that was formerly associated with the Swedish Environmental Protection Agency (EPA), but are now part of Stockholm University. This study was supported by grants from the Swedish EPA and the Nordic Council. The aim of the study was to investigate the possible impact of two-stroke outboard engine exhaust on fish. A major part of the work was to mimic the route of exposure to conditions that these fish would encounter in their natural habitat. Control experiments were conducted to ensure that the experiments themselves did not interfere with the responses observed and to establish high sensitivity of the system.

The results of the study clearly indicate that emissions produced by two stroke outboard engines caused negative impacts on various fish species at various developmental stages. The effects were measured at sub-cellular levels using a suite of enzyme activities, at cellular levels using a DNA adduct method and at organ level using histopathology. Furthermore, physiological functions (carbohydrate metabolism and immune system) were investigated in these animals.

Certain polycyclic aromatic hydrocarbons (PAHs) are foreign substances for humans as well as fish, but they can have different biological effects. PAHs are predominantly metabolized in the liver, but also in the kidneys and other organs. The PAHs are metabolized in several steps, starting with phase I, by cytochrome P4501A, to an hydroxy or an epoxide derivative followed by phase II reactions which involves conjugation with a polar endogenous molecule (*e.g.*

glutathione). Epoxides are very reactive intermediates which can bind to macromolecules in the cells (e.g., DNA, RNA and proteins), whereas the conjugated products formed by phase II enzymes are usually less toxic and are more easily excreted from the body.

Cytochrome P4501A-mediated phase I activities were analyzed using ethoxyresorufin-O-deethylase activity as a model reaction. Phase II activities were measured as glutathione transferase activity to measure conjugation and as epoxide hydrolase activity to measure inactivation of epoxide derivatives in these fish.

A water mass with a square meter cross section and parameters as boat speed, fuel consumption and speed relative to engine power would simulate a boat wake and was used as a model in estimating condensate exposure level. Considering engine type a theoretically estimated value of unburned fuel and exhaust emission was obtained. This model, which may however be an underestimation, was then used to mimic exposure conditions. The most efficient extraction procedure, and probably the most relevant in terms of extracting the bioavailable fraction of exhaust condensate, was obtained by hexane extraction of the wake water, when compared to using polyurethane foam or acetone/hexane extraction. To mimic exposure through the food, fish were fed a diet of self-made cod chips containing extracted engine exhaust condensate. Results from these studies showed that substances from the exhaust condensate were biologically available, both when fish were exposed directly via the water or through the food.

Four different exposure experiments were subsequently conducted:

1. Rainbow trout (*Oncorhynchus mykiss*) were injected with an extract from exhaust condensate dissolved in corn oil. Liver somatic indices and several enzymatic variables including ethoxyresorufin-O-deethylase, glutathione reductase, glutathione transferase and catalase showed significant changes after injection with the extract. However, changes in responses between the sexes were observed.
2. Rainbow trout were fed with cod chips containing extracted engine exhaust condensate. An initial accumulation of DNA adducts was observed in the blood, spleen, intestine and trunk kidney in fish of both sexes. The observed decrease of DNA adduct in the blood, spleen and intestine cells following 21 days recovery period could have resulted from either DNA-repair or from cell turnover with the new cells lacking exposure to adduct forming metabolites.
3. Perch (*Perca fluviatilis*) were directly exposed to exhaust emissions. The outboard engine was run in one tank, and then the water from this tank was introduced after dilution into the tank holding the fish. A dramatic increase in DNA adducts was observed in the fish exposed to this water.
4. Cultured fathead minnow (*Pimephales promelas*) embryos were injected with extracts from exhaust condensate dissolved in corn oil. Fathead minnow embryos injected with condensate

extract yielded a dose response of deformed vertebrae, reduced swim bladder size and edema surrounding the heart.

In conclusion: The investigations thus far clearly show that the emissions produced by two-stroke engines contain substances that have a negative impact on living fish, including early life stages. Disruption of normal biological functions were observed at different levels of biological organization including sub-cellular, cellular, physiological functions and histopathology.

Q All the experiments that they did, they assumed there would be a constant concentration of the contaminants?

A (by Malin Celander) They used a medium boat speed that's very common in those kind of motors.

Q Any observations of differences in activity of the fish that showed different lactate or glucose levels? Were there behavioral differences?

A Yes: those fish that were exposed were not as alert as the controls, they were very easy to catch. They were very easy to take up with the net, whereas the control fish tried to avoid it. They acted like they had been anesthetized. They weren't really that scared. So that's the behavior that they observed.

Q (by Diane Stephan) Do you expect that the female rainbow trout in the first experiments were retaining PAHs in the tissues in their bodies since they weren't producing as much of the enzyme?

A I don't think they do that because these are juveniles. It is not that they send it to the eggs. But I think it's an effect of hormonal down regulation. Estradiol, the female sex hormone, down regulates the expression of P450.

Q (by Michael Moore) It's a common finding that in polluted sites females have lower levels of enzyme induction than males.

Q (by Bob Tucker) How early in development of the embryo were those last fish injected?

A Before epiboly.

Q (by Bob Tucker) With medaka, the EROD activity doesn't kick in until after the liver actually forms. I assume the next step is to look at the four cycle engine.

Aromatic Hydrocarbons: Two-Cycle Vs. Four-Cycle

Michael Moore

Biology Department, Woods Hole Oceanographic Institution, Woods Hole MA

My collaborators for this presentation are John Stegeman and Bruce Woodin, from Woods Hole Oceanographic Institution, and Damian Shea from North Carolina State University. The chemical analysis that I will describe is based on Damian's data.

I want to put the polycyclic aromatic hydrocarbons (PAH) question in context—where they are coming from, their fate and their effects. I will also describe, from a study in progress, the experimental effects of two- and four-cycle emissions on a small killifish species and the context of those data in terms of other inputs into the system.

PAHs range from the two ring naphthalenes to five and six ring compounds such as benzo(a)pyrene. The sources of these compounds are primarily terrestrial, but there are also marine sources. Use and combustion of hydrocarbon fuels and lubricants will always lead to the contamination of aquatic systems which are “downhill” from every other system. Coastal sediments tend to be the “sink” within which these compounds, especially the larger less volatile forms, accumulate.

Petrogenic sources include sump oil; hardtop leachate; carbon black from tire rubber; oiled unpaved roads; fuel transportation/transfer; and ground water plumes from leaking storage tanks, pipelines, and other structures. Pyrogenic sources generate the larger PAHs in solids and liquids which, through fallout, rainout, and runoff, enter aquatic phases. Sources of these include land-based internal combustion engines; industrial processes; home heating-wood and oil; waste incineration; inboard and outboard boat exhausts; and other forms of mechanical transportation. The compounds of concern from outboard motors are uncombusted fuel/oil mix and pyrogenic PAHs, as well as other non-aromatic structures not considered here.

A model has to be built to illustrate how these sources partition and how they rank in comparison to road runoff and other sources. This will be necessary to assess the importance of PAHs from outboard motors compared to those from other sources at particular sites. One of the parameters that we have to build into the model is an ability to recognize the importance of relative distance from source to site of effect. Compare an outboard motor with 20 percent of its fuel coming out of its exhaust and idling at high tide above a clam flat where the clams are spawning to: (1) a road drain 300 hundred yards away, (2) to a drain three miles away, or (3) to an oil spill in the next estuary. The model must include the distance from source to target and the volume of the functional hydrographic system in question, whether it be a cove with a clam bed, a pond, a lake or an estuary.

Is there an acute toxicity problem? Is there a chronic toxicity problem? These questions have to be understood and modeled before we can say whether outboards contribute significantly to PAH problems or not. Of course, they are going to be part of the problem; the managers need to know how big a part of the problem results from outboards and what can be done to improve it.

Naphthalenes and the other two- and three-ring compounds found in fuel/oil mixtures can be acutely toxic at 0.3 to 4 parts per million. In plants, in concentrations of 0.2 to 10 parts per million they decreased carbon fixation by 50 percent. Chronic toxicity tends to be associated more with the larger ring compounds. Hawkins et al. (1) took two small fish, the guppy and the medaka, and exposed them for six hours a week for a month to 200 parts per billion benzo(a)pyrene. Tumors were seen in guppies six to twelve months later. In the case of outboard motor exposure, more subtle changes that are not so dramatic might be expected, such as reproductive incapacity and behavioral change.

We ran a simple experiment to assess which compounds are found in outboard emissions and what are their biological effects. We used two outboards: a six horsepower two cycle-motor, and an eight horsepower four-cycle motor, both five years old and maintained professionally. We ran them in fresh water for 40 minutes, took samples of the water for PAH analysis and then took serial dilutions from 1:1 to 1:1000. In each treatment we introduced 20 *Fundulus diaphanus*, the banded killifish, which is common in ponds on Cape Cod. Both the raw water and the 1:1 dilution were acutely toxic (all the fish died). Chemical analysis revealed the source water to be clean except for traces of naphthalenes. The water from the two-cycle motor contained 5 times as much total PAH as the water from the four-cycle outboard. This difference primarily resulted from a much greater content of the 2- and 3-ring compounds such as the naphthalenes, presumably originating from the lubricating oil in the two cycle mix. In terms of the 4- and 5-ring PAHs, the water from the four-cycle outboard was somewhat higher than the two-cycle. Thus, although the overall PAH loading is substantially reduced in four-cycle vs. two-cycle engines, the chronically toxic 4- and 5-ring compounds are by no means reduced. While avoidance of lubricating oil in the gasoline is certainly desirable in moving from two- to four-cycle technology, there is a residual risk of chronic toxicity.

With respect to biochemical effects in these fish, we focused on the amount and activity of an enzyme called cytochrome P4501A (CYP1A). This enzyme adds water solubility through hydroxylation facilitating excretion. Potentially toxic epoxide intermediates are also generated. Levels of this enzyme parallel levels of exposure to a related group of compounds including 4- and 5-ring PAHs and a number of halogenated compounds such as dioxins, dibenzofurans and some planar PCB congeners.

In the two-cycle exposure we saw an increase in P4501A protein expression with decreasing dilution. In contrast, the four-cycle differences were less clear cut, and complicated by an unexplained non dose-related mortality.

One can also examine the enzymatic activity of CYP1A, measured by deethylation of the substrate ethoxyresorufin. The activity is called ethoxyresorufin-O-deethylase, or EROD. The four-cycle treatment had a dose-related reduction in EROD activity, suggesting that there is some degree of toxicity in the four-cycle case.

Can we put cytochrome P450 induction in these fish into a broader context to tease out the effect of outboard motors versus other inputs to aquatic systems? We compared the above experiment with maximally induced fish, using a known strong experimental inducer, and fish from local ponds. The fish exposed to two-cycle emissions showed half of the potential response of the maximally induced animals. In contrast, fish from the ponds where boating is allowed showed half of the levels in our experimental outboard treatments, whereas the fish from the local water supply where boating is not allowed had very low levels. To attribute these changes in the ponds where boating is allowed to boating activity is not possible until we know more about terrestrial and atmospheric inputs in each case.

So what do we know? We know that two-cycle outboard emissions contain five times as much total PAH as the four-cycle emissions. The aggregate difference was all in the lower molecular weight 2- and 3-ring compounds; thus the two-cycle has much greater potential for acute toxicity. Given that the primary source of chronic toxicity is 4- or 5-ring compounds, the four-cycle was just as chronically toxic as the two-cycle.

So my questions are: How can PAH sources of all kinds be modeled? How do the different sources of PAH rank in importance globally, nationally, and regionally, and at the point of effect? Most of the available data are on a national scale whereas the point-of-effect is the real issue. I speculate that local sources such as outboard motor emissions may well have a disproportionate effect if they are released close to sensitive targets.

Q (by Nils Stolpe) Michael, these substances, if they do get into the sediments, can they be fairly long-lived?

A (by Michael Moore) Yes, depending upon levels of microbial degradation and levels of oxygenation, greater or lesser longevity results. But PAH levels can accumulate through time in soft bottom sediments. Those hydrophobic compounds partition out of the water into the organic-rich sediments, then accumulate through the benthic food chain into the flesh of animals and plants that are incapable of metabolizing them. Therefore, blue mussels have been used as an *in situ* marker for hydrocarbon contamination exposure because, unlike fish, they are incapable of metabolizing these compounds very well. In contrast to the blue mussel, if we took these killifish

and analyzed the fish for the aromatic hydrocarbons, we would not see much because they are successful in metabolizing and excreting them. This, in turn, is in distinct contrast to the halogenated hydrocarbons, such as PCBs, which accumulate well in fish flesh and liver because they are not well metabolized due to the chlorine atoms inhibiting metabolism. Therefore analysis of fillets of fish for non-halogenated aromatic hydrocarbon residues is not a particularly meaningful thing to do.

Q (by Nils Stolpe) So they might have a fairly direct path from boating induced, turbulence induced sediments into the bottom --

A Assuming those PAHs are going down. If they are still in gaseous phase in part, then they will go up. I do not know of any relevant data. Maybe the industry has it. I have not seen it but I have not looked very hard, either. I do not know how much comes out as particulates, which may well sink, versus the bubble. These are all important questions.

Q (by Jay Tanski) This is related to a study looking at the relative impacts of a marina on a saltmarsh in Rhode Island. It was done back in the '70s. They were measuring hydrocarbons—I am not exactly sure what they were measuring—but they actually found the concentrations dropping during the summer when there was boating activity there. They attributed that to degradation by the sunlight.

Q (by Rick Crawford) I was wondering, would you expect any difference in your 4- and 5-ring data when using one of these fancier gasolines with the additives and whatnot compared to the low octane, cheap gas?

A That was a ninety-three grade octane we used; it was not the cheapest. I would not think so. I think the primary thing we would have seen, the temperature in the tanks would have increased faster because we would have got a more efficient burn, I think. But you are still cracking those compounds, and generating the aromatics through pyrolysis.

Q (by Andy Mele) I think that the four-stroke crucible is hotter than the two-stroke crucible, and I suppose that is the most obvious thing to look at in terms of this interesting difference. The next question is to go back to the studies of catalyst performance—I am just thinking ahead a little bit—and see if catalysts can solve that 4- and 5-ring problem.

Q (by George McCarthy) And this is a concentration in what? How many, 40 gallons of water in 40 minutes?

A Thirty gallons of water in forty minutes. When you take a small outboard and put it in a barrel of fresh water to flush it at the end of the season after using it in salt water you will see surface scum and general particulates there.

Q Jack Hardy in Washington state, the microlayer fellow I talked with a lot has told me on any number of occasions that he thinks that a lot more of this stuff than we know comes out bound to particles or associated with particles. He does not hold a tremendous amount with at least the

immediate evaporation theory everybody seems to like, especially the boating industry. He seems to think that there may be an almost immediate fallout.

A Well, on the basis of what that photograph shows [showed photograph of two- and four-cycle exposed water with major particulates in the two-cycle sample] that is a very reasonable statement.

Q (by Dery Bennett) This is somebody from the industry saying yes, we do get a higher stream of unburned hydrocarbons in the exhaust of a two-cycle. Conversely, we get a very low incidence of nitrogen oxides which are often overlooked.

A Yes. Andy was mentioning this at lunch time. He can address this better than I can, but I believe that the NO_x production from two-cycle is less than from four-cycles. So, it is a question of whether you care about the ozone hole or soft shell clams.

Q (by Larry McLaughlin) I just wanted to point out on your slide here what might not be so visible but which potentially may still have toxic effects are the dissolvable compounds—water soluble compounds. And you get considerable alcohol production and ketones and aldehydes.

A What you are saying is that if we ran a more complete chemical analysis of both those samples, there would be some bad news in both of them.

Q (by Larry McLaughlin) That's right.

A Certainly, I think the biochemical data points to that as does the limited chemical data as well.

Hawkins, W. E., W. W. Walker, R. M. Overstreet, J. S. Lytle, and T. F. Lytle. 1990.

Carcinogenic effects of some polycyclic aromatic hydrocarbons on the Japanese medaka and guppy in water borne exposures. *Sci. Tot. Env.* 94: 155-167.

Proposed Federal Boating Emission Regulations

Andre Mele

43 Yale Court, Kingston, New York

I am going to give a quick synopsis of the new EPA proposed rule for regulating boat engine emissions. It calls for basically a 75 percent reduction in existing hydrocarbon emissions. I am going to give this talk in two stages: one, the synopsis; and two, my response.

The 75 percent reduction in existing hydrocarbon emissions is going to be accompanied by an allowed increase of oxides of nitrogen (NOx) and carbon monoxide. In particular, NOx and hydrocarbons have a sort of paradoxical relationship. You can not cut one without getting an increase in the other. It is just a sort of a balance thing that you can not seem to avoid. The situation is improved with the use of alternative fuels and with three-way catalysts, but there is no plan for catalysts in the rule, though EPA has requested comment on the use of catalysts.

For two-stroke engines, the point of origin for this 75 percent reduction is roughly 300 grams of hydrocarbons per kilowatt hour, the point of origin being the typical emissions for present technology. Seventy-five percent reduction of that is 75 grams per kilowatt hour. So that is the standard that they are looking for, 75 grams per KWH. Now, the conversion is that one horsepower is about three-quarters of a kilowatt, so you can do the math.

Four-stroke boat engines, which are characteristically referred to as inboard or stern-drive engines, have to meet a standard of eight grams per kilowatt hour. (A typical car engine, usually rated in grams per mile, can be estimated at one to three grams per kilowatt hour.) For compression ignition engines such as diesels, the rule is going to be the same as the existing new non-road engine regulations, so there is no separate regulation for marine diesels. The rule is in regulation 4ACFR, 589. It specifies 1.3 grams per kilowatt hour of hydrocarbons.

The reduction rule is going to be phased in over an eight- or nine-year period, starting with model year 1998 and concluding in model year 2006. Roughly 15 percent of the targeted reduction is going to be tacked on each year. The manufacturers are going to group their lines of engines into families: the higher horsepower small block, the lower horsepower small block, etc. Once they have divided their product line into families, the manufacturers get to essentially do their own strategy as to which family they are going to cut back on first and which family they are going to coast on.

The reason they can do this is because EPA is allowing them to average their emissions over their respective fleets. The manufacturers pick a family emission limit for each engine family and then they strive to meet that limit. If they meet it, fine. If they do not meet it, they get what are

essentially negative credits. And if the emissions are less than the requirements for the limit, they get positive credits.

When you add this up, you have a manufacturer who for a given year either has some credits to spare or needs some credits. But one way or another, each has to meet this incremental reduction. So they can either buy credits if they need them from another manufacturer who has done it a different way, or they can sell surplus credits. In this way, pollution is condoned and everybody is happy. That is the structure. The credits expire after three years.

The rule is based on the motor manufacturers' two-stroke technology. The engine manufacturers are highly technocentric and they do not want to let go of this two-stroke technology. They cite things like the power-to-weight ratio of a two-stroke engine, which is valid. Indeed, a typical two-stroke engine achieves a given horsepower at maybe 25 or 30 percent less weight than a comparable four-stroke. What they overlook is the simple fact that engines by themselves do not go dashing around on the water; they are attached to boats. By the time you add the total weight of boat, occupants, fuel, beer, dead fish, and bait buckets, the net difference in real-world terms is between two and four percent, which is much less significant and is really only meaningful in terms of competition (i.e., boat racing).

The other thing about the two-stroke rule is that it is based upon technology that is not even out of the lab yet—direct injection. Another problem with the rule is the point of origin. The point of origin for the 75 percent reduction is determined at a point in an engine that my research indicates is 100 to 140 percent dirtier than that of a typical car. So, 75 percent of something that is already 140 times worse brings us to a point where it is only 25 to 30 times worse than the average car, which creates a double standard. It creates a standard for boats that is 25 to 35 times more lenient than the standard for cars. In fact, this new standard is close to being more lenient than it used to be for cars without any form of regulation at all in the '60s. I believe that at least 95 percent reduction is easily attainable through existing four-stroke technology, especially with exhaust after-treatment.

With the hikes in unit cost to be expected through the gradual phase-in of clean power technology into the marine field, there is going to be a disincentive to buy new materials, new boats, new engines. This rule, like most other EPA rules, contains no provision for scrappage. This means that as a result of this environmental regulation, things are going to get worse before they get better. The only way this rule is going to have any sort of effect is if there is a scrappage program. They have left the door open for a federal one by requesting comment on such a program. It would include some form of incentive program with money raised from "somewhere" to either induce manufacturers to recapture old dirty engines or to induce those who own them to turn them in for a variety of kickbacks.

When the motorboat manufacturers are building these new engines and marketing them, they are going to be responsible for monitoring their compliance. They are going to have to see whether a given engine family is in compliance—use ten years after the fact. They are struggling with ways to do this. They are going to have to sell a lot of them, then bring some of them back and test them from time to time. And the manufacturers are going to have to keep all the records on this.

They are arguing over whether or not to use fleet users as a means of accelerating wear and tear to see after a couple of years what emissions from a typical ten year old engine might be. The question with this approach is that, although a fleet engine typically gets much higher use than an individual owner's recreational engine, does it get better maintenance than a typical recreational engine?

Q (by Nils Stolpe) A comment rather than a question. In the regulatory impact analysis, which I imagine has to do with the estimate of 6,000 dollars per motor, they assume an outboard engine might be in service 28 to 54 years, depending on size. Inboard engines are 40 years, and personal watercraft engines are 20 years.

A (by Andre Mele) Yes. With simple math you can refute that by measuring the residence time of an outboard motor in the marketplace. The maximum time that I have measured is 27 years. But choosing the year 2050 for full compliance is also based upon those extraordinarily long residence times which I do not really believe.

Q I can not see an outboard motor as a part of the family legacy.

A Yes, I know. How many people have inherited an outboard motor from their grandfather? The industry figure is 35 hours per year for the average recreational marine engine and that means that a typical engine should be able to last for a really long time. They do not. They die of other reasons.

Q (by George McCarthy) I have two questions. One is, is the two-stroke technology compatible with alternative fuels—I guess alternative liquid fuels. What about natural gas and that kind of stuff?

A Apparently it is not compatible with any alternative fuels. At least that is what I have indicates.

Q What about catalytic converters or some other form of after-treatment of exhaust with two-stroke technology? Is that another problem?

A With present technology, catalyzing two-strokes is not feasible because the converters would rapidly get overloaded and they would have to be burned out from time to time—kind of like diesel particulate filters. But if the manufacturers are able to pull off this direct injection

technology, they can indeed be catalyzed because then the hydrocarbon emissions come down to a level more or less comparable with an unregulated car engine.

Q It seems to me there are real natural limitations to the two-stroke technology. At best, if the two-stroke technology could only get as good as the unregulated four-stroke technology, then it really seems like something we should be moving away from? Forget about the dual standard, why not just do away with the two-stroke technology?

A Yes, precisely.

Q (by Nils Stolpe) You had mentioned a scrappage program and some possible funding, which I assume means some possible public funding source?

A They are not talking about any source. They do not even begin to sketch out a program. They just mention that the subject has come up and that they will consider it on a federal level if a good enough program is suggested. From discussions I have had with them, I am concluding that they want some type of scrappage. Groups like the NRDC, who are familiar with how these programs work, want to avoid rewarding heavy polluters like so-called “energy companies”—oil companies and engine manufacturers—with the opportunity to obtain credits for future emissions by buying back vehicles and that sort of thing. I am looking at something more along the lines of a surtax, if you will, or surcharge on boat registrations that will be used to create a funding pool or trust fund, the interest from which would be used to buy back clunkers. However, there is a problem with that because while cars are eminently recycled, nobody has yet really figured out how to recycle fiberglass. So, you know, you are taking only the motor back, not the boat—although that is, I guess, a different problem. We should not have to worry about that here. I think the next great fortune is going to be made by somebody who figures out how to recycle fiberglass.

Marine Engine Hydrocarbon Emissions and Emission Reductions from Alternative Fuels for Inboard and Sterndrive Engines

Larry McLaughlin

National Research Center for Coal and Energy, Morgantown, WV

Due to the complexity of this presentation and the many informative figures supporting it, the following text is a version prepared by the author of this talk. The figures are included as well to ensure that no information is lost in the process of including this paper into these proceedings.

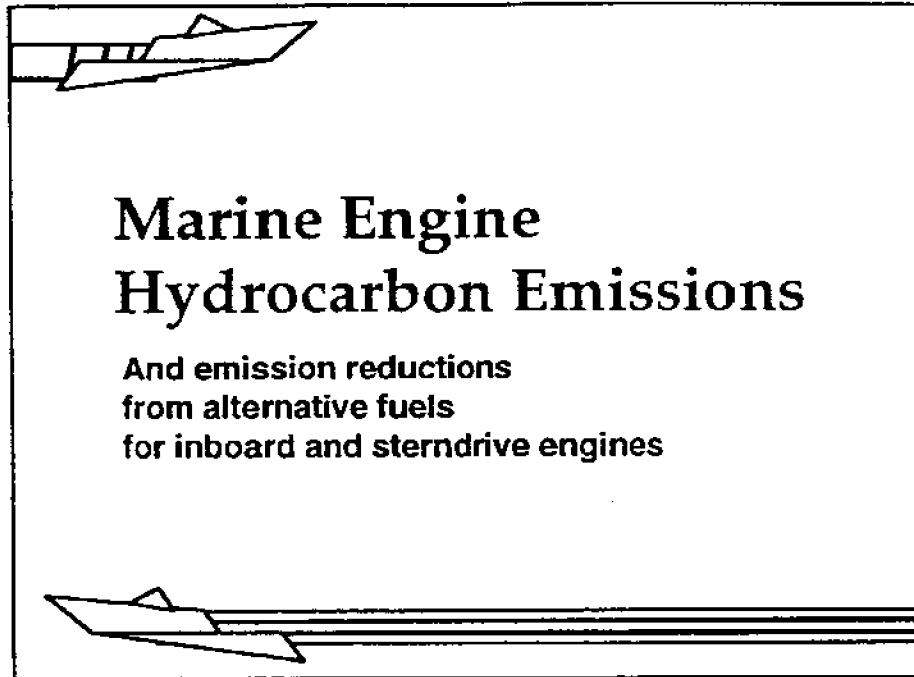

To further introduce myself, I am with the National Research Center for Coal and Energy at West Virginia University and serve as a Program Director in the Alternative Fuels Division. We manage multi-disciplinary research programs related to energy and the environment, with about half of our programs funded by the Department of Energy and the other half funded by the Environmental Protection Agency. I am also representing the the University of Maryland Sea Grant Extension Program. We are working together on a proposal to investigate alternative fuel applications for marine engines.

Nils spoke about cigarette boats in shallow Barnagate Bay. Rick Crawford mentioned the effects of "cigar boats." In West Virginia, we have chewing tobacco boats, and you wouldn't want to cross the wake of one.

To understand the advantages that certain alternative fuels have over petroleum based fuels with respect to emissions, it is important to understand internal combustion engines and how the exhaust gases are formed. I will be limiting my discussion to gasoline powered, spark ignited marine engines, and attempt to provide a brief overview of their emission characteristics and what could be expected in utilizing various alternative fuels.

Data on emissions from marine engines is scant, and what is available is not necessarily produced with the same test procedures. But I will put up a few examples and where it seems I am comparing apples and oranges, I will try to point out what is meaningful and at least put these apples and oranges in their proper context. You see apples and oranges do have a few things in common ... for example, size, vitamin C, a good source of fiber. Comparing apples and oranges is necessary at times to gain a new perspective.

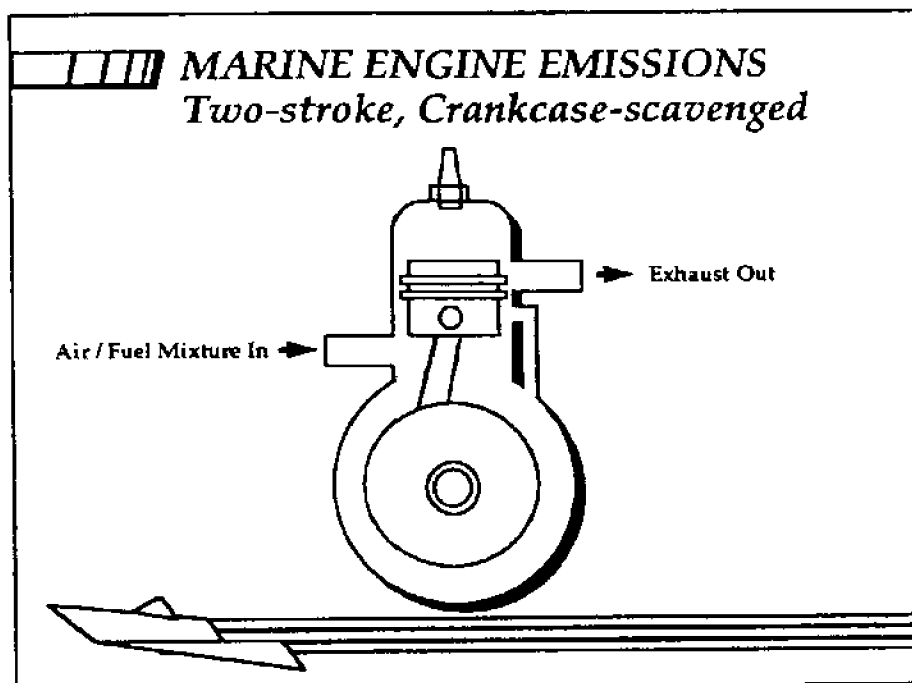

There are basically two types of gasoline fueled engines for marine vessels: the two-stroke, crankcase-scavenged spark ignited engine used for outboards and the four-stroke, otto cycle, spark ignited engine used for inboards and I/O or sterndrives.

With two-stroke engines, each stroke performs multiple functions. Here's how it works: the power stroke delivers force to the crankshaft. The air/fuel mixture is then forced into the combustion chamber, while, at the same time, causing a portion of the exhaust to be expelled through the exhaust port. The compression stroke compresses the air/fuel mixture at the head of the cylinder and draws in additional air/fuel mixture into the crankcase. Combustion occurs and the process cycles on, delivering torque to the propeller.

As you can see, this design has some inefficiencies. Exhaust gases are continuously present in the head of the cylinder and compressed together with the air/fuel mixture for combustion. As a result, fuel ignition does not occur efficiently. A portion of the fuel remains "unburned" and is expelled through the exhaust port.

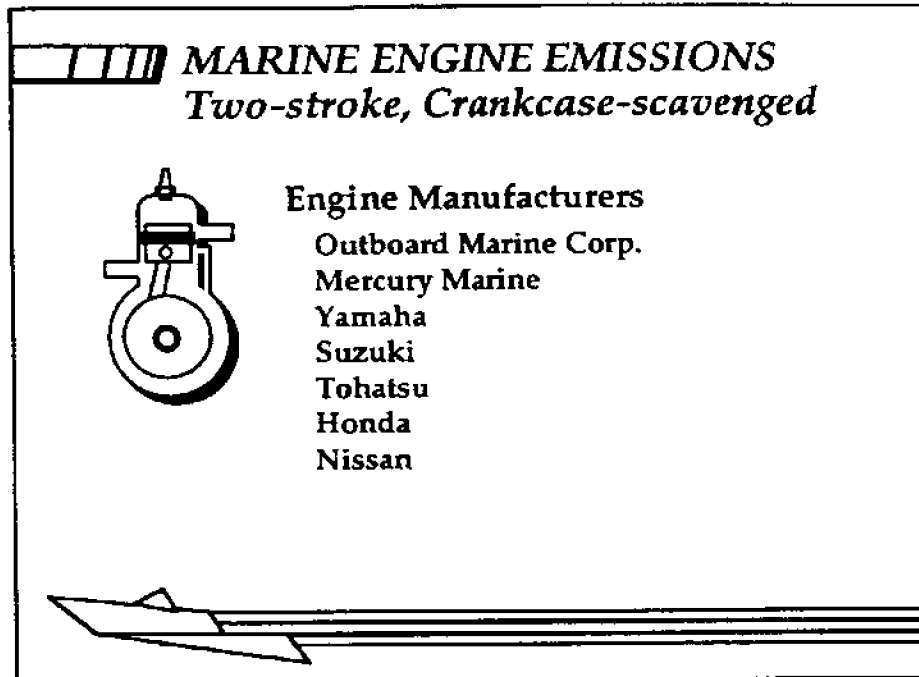

These are the prominent players in the outboard marine engine market. The outboard market is dominated by the first two companies on our list, Outboard Marine Corporation and Mercury Marine.

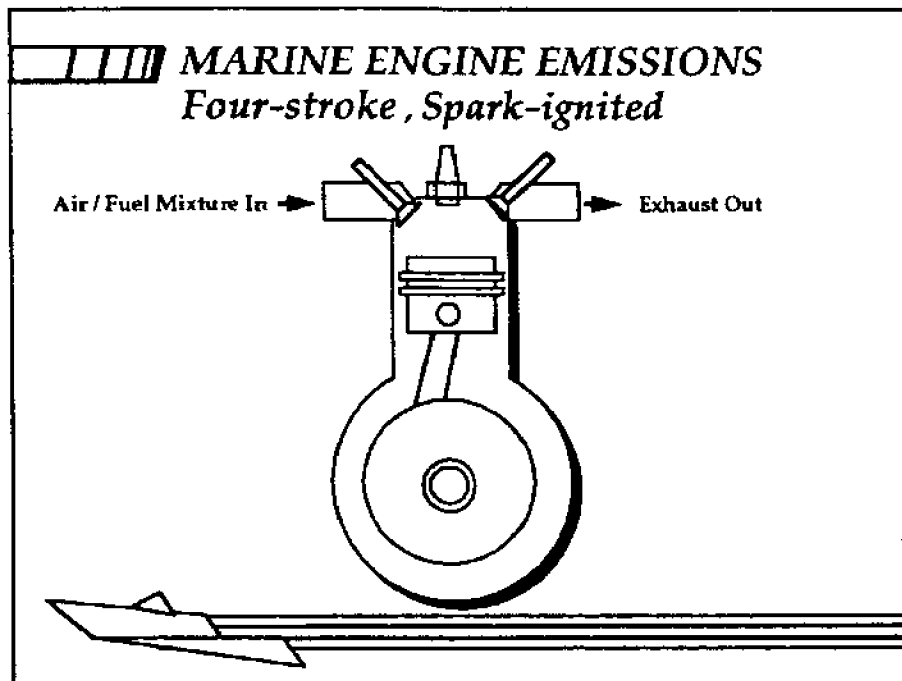

This is a diagram of the four-stroke engine. With a four-stroke engine each stroke performs a separate function. An intake stroke draws the air/fuel mixture through the intake port into the combustion chamber. A valve at the intake port closes, the compression stroke begins and compresses the fuel mixture to a differential volume of 8:1. Ignition of the fuel occurs and the piston is driven downward in the power stroke, delivering force to the crankshaft. A valve opens at the exhaust port on the fourth stroke and exhaust gases are forced through the exhaust port and into the exhaust manifold. The process cycles on.

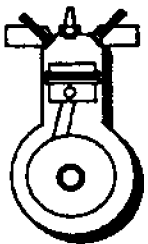

MARINE ENGINE EMISSIONS

Four-stroke, Spark-ignited

Engine Manufacturers

- Mer cruiser, Corp →
- Indmar
- Volvo Penta/OMC
- Crusader
- Various
- Marinizers

GM Small Block Engines
 3.0 L In Line (181 ci)
 4.3 L V6 (262 ci)
 5.0 L V8 (305 ci)
 5.7 L V8 (350 ci)
 7.4 L V8 (454 ci)
 8.2 L V8 (502 ci)

Marinization

- Water Jacketing On Exhaust System
- Back Fire Arrest
- Fuel Leak Protection



This is a list of the prominent inboard and sterndrive engine manufacturers. Mercruiser is the clear leader in sales among those on our list. Both Mercruiser and Mercury Marine are owned by Brunswick Corporation.

Inboard and sterndrive engines are simply automotive engines that have been modified or "marinized" for marine use. Mercruiser is currently using these GM small block engines.

What do they do to marinize an engine? Basically, marinization includes water jacketing on the exhaust system to keep a boat's engine compartment cool, backfire arrest and fuel leak protection on the fuel system. With regard to their impact on water quality and the recently proposed EPA regulations for hydrocarbon emissions, the exhaust systems are of particular concern, and I will come back to that later.



Major Air Pollutants From Marine Engines

Nitrogen Oxides (NO_x)
React in sunlight with ozone and hydrocarbons to form NO₂. This is the first step in the production of smog, which can irritate the nose and eyes, reduce visibility lung function, and aggravate respiratory diseases.

Hydrocarbons (HC)
React in sunlight with other pollutants to form smog. HC species of particular concern include benzene, butadiene, formaldehyde, and acetaldehyde.

Carbon Monoxide (CO)
High concentrations in the air cause nausea, headache, and dizziness. Associated with cardiovascular, central nervous system, and toxicity effects.

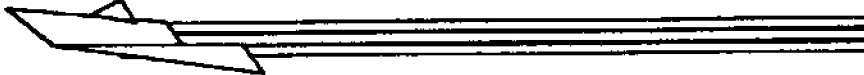

Let's talk about emissions.

Under the Clean Air Act, the EPA is responsible for establishing regulations to reduce emissions from mobile and non-road sources. The EPA is primarily concerned about these exhaust constituents from internal combustion engines and how they effect air quality.

 MARINE ENGINE EMISSIONS 55 kW (73.7 HP) Outboard Mass Emissions (g/h) Date: 1990 Rated Speed: 5000 RPM Displacement: 73.2 ci					
Mode	Speed % Of Rated	Torque % Of Full Throttle	HC	CO	NO _x
1	100	100	5360.0	7429.9	325.9
2	80	71.6	2751.0	4385.4	76.1
3	60	46.5	1811.5	3416.7	5.8
4	40	25.3	1260.2	1449.3	0.8
5	idle	0	589.2	415.9	0.0

SAE 901597



This table provides an example of the mass emissions for the three exhaust constituents, hydrocarbons, carbon monoxide, and nitrogen oxides from an outboard engine. This is a 55kW, or 73.7HP, two-stroke outboard with a displacement of 73.2 cubic inches. The first three columns, mode, % of engine speed, and torque % of full throttle, represent an industry standard for testing emissions under varying load conditions. These speed and load conditions were established by the International Council of Marine Industry Associations (ICOMIA) and accepted as the ISO "E4" duty cycle. This duty cycle is currently proposed by the EPA for emissions testing in certifying engines under the marine engine regulations.

You can see in the remaining three columns the emission measurements for HCs, CO, and NO_x under each test mode. These are grams per hour measurements.

 MARINE ENGINE EMISSIONS 220 HP Inboard Mass Emissions (g/h) GM Small Block Date: 1992 Rated Speed: 4400 RPM Displacement: 350 ci					
Mode	Speed % Of Rated	Torque % Of Full Throttle	HC	CO	NOx
1	100	100	449.8	38,958	684.3
2	80	71.6	259.1	10,748	722.4
3	60	46.5	136.1	2,615	442.0
4	40	25.3	95.6	3,447	33.1
5	Idle	0	446.4	2,040	3.9

EPA, Samulski, 1992



Here is another example. This data is for a 220HP inboard with 350 cubic inches of displacement. Compare these emission levels with those of the outboard. Obviously, we are talking about different engines with different size and performance characteristics. But, as you can see there are also dramatic differences in emissions that are chiefly a result of the difference in the basic design explained earlier. For example, hydrocarbons on the two-stroke engine are 10 to 12 times higher than the four-stroke under test modes 1 through 4. This higher level of hydrocarbons is the result of the less efficient combustion characteristics of two-stroke engines and the discharge of partially burnt and unburnt fuel. The EPA estimates that 25% of the fuel consumed by a two-stroke engine is expelled from the exhaust unburned. On the other hand, the four-stroke engine carbon monoxide levels are five times higher than the two-stroke under test mode 1 and twice as high under test mode 2. NOx is twice as high for the four-stroke under test mode 1, and nearly 10 times higher under test mode 2. I presume that the higher CO and NOx levels are due to the greater efficiency and higher temperatures of the four-stroke engine, but the CO is difficult to explain without more information.

These emission numbers should only be viewed as examples. There are many factors that effect these numbers, both in the laboratory and in actual use. However, it is important to note that consistency in the unit of measurement, in the duty cycle by which the numbers were generated, and the dramatic difference in emissions between the two engines allows us some latitude in making the generalizations we have made. Comparing apples and oranges is also OK when you are speaking of their differences.

 Federal Emissions Standards For Light Duty Vehicles (grams/mile)			
Phase In	THC	CO	NOx
1990	0.41	3.4	1.0
Tier 1 1994	0.25	3.4*	0.4
Tier 2 (2004)	0.125	1.7*	0.2

* CO Cold Standard = 10 g/m



Just to put these emission quantities into perspective, this table shows the federal emission standards for light duty on-road vehicles. Now . . . grams per mile, the mass measurement for emissions of on-road vehicles, cannot be accurately converted to grams per hour or grams per kilowatt hour. However, when there is again such a dramatic difference -no matter how you measure it- marine engines are producing significantly higher quantities of harmful emissions.

At this point I would like to focus our attention on hydrocarbon emissions and the four-stroke engine. Why? For the following reasons: 1) among the exhaust gases, hydrocarbons are likely to have the greatest affect on water quality. Although the proposed EPA regulations are designed to reduce hydrocarbons from marine engines, they are driven by air quality concerns. 2) Engine for engine, four-stroke engines do not produce the quantity of hydrocarbon emissions produced by two-stroke engines. However, as the data presented by Nils suggested, they may be comparable in total tonnage due to the significantly higher quantity of fuel they consume nationally. 3) Due to their efficiency in the combustion process, gasoline fueled four-stroke engines may produce more of what is harmful to the aquatic environment. 4) Although they are modified automotive engines, they lack the emission control devices of a modern automobile, but are good candidates for reducing emissions through alternative fuels.

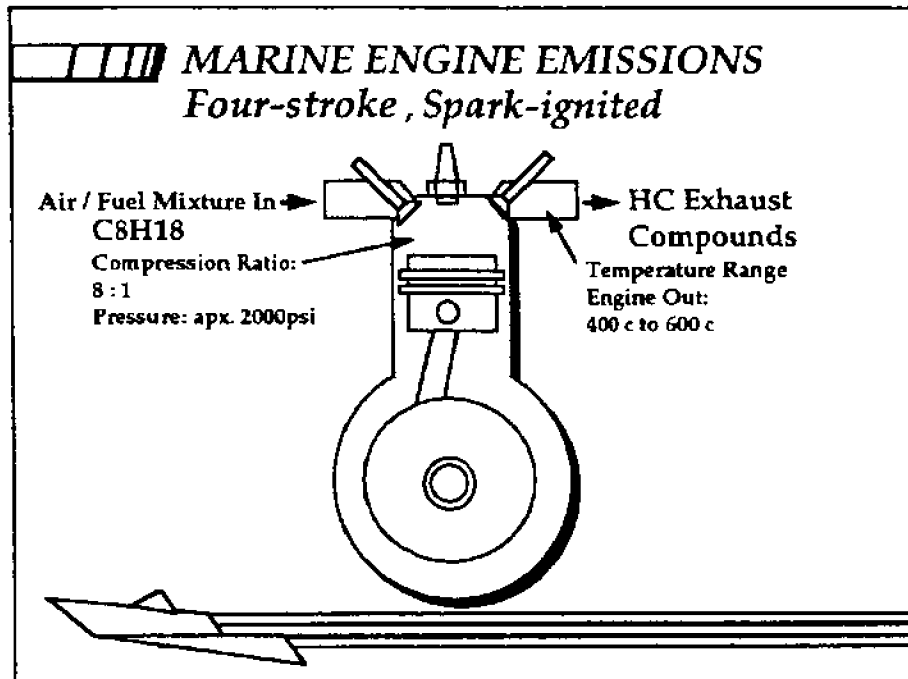

Let's look a little closer at how HC emissions are formed in the four-stroke engine. Gasoline is a complex hydrocarbon fuel. Its chief hydrocarbon molecule is C_8H_{18} . An air/fuel mixture of 12 to 15 parts air and 1 part fuel is drawn into the engine cylinders. The mixture is then compressed. A spark ignites the fuel mixture and a controlled burn occurs, creating pressures approaching 2000 psi. This should not be described as an explosion, but a controlled burn with a flame front that propagates rapidly through the combustion chamber. After the power stroke is complete, the exhaust by-products are forced from the cylinder into the exhaust manifold. Temperatures generated by this process in a four-stroke range from 400 to 600 degrees Celsius at engine out.

The high temperatures of combustion in a four-stroke engine cause the hydrocarbon molecules of gasoline to break down into a wide range of hydrocarbon exhaust compounds. For example, if the C_8H_{18} molecule breaks in half and each half picks up an atom of hydrogen it becomes two molecules of C_4H_{10} or butane. If C_8H_{18} breaks into four components and gives up two hydrogen atoms in the process, the result is four molecules of C_2H_4 or ethylene. These are examples of simpler reactions. There is a wide range of HC compounds formed, many of greater complexity. Many are toxic substances.

MARINE ENGINE EMISSIONS Hydrocarbon Compounds In Exhaust Gases					
Chemical Species	* Aromatic	Boiling Point ° C	Gaseous at 0 - 25° C	Condenses at 0 - 25° C	Water Soluble
Acetylene	C ₂ H ₂	-84	yes	no	no
Methyl acetylene	C ₃ H ₄	-23	yes	no	no
iso-Butylene	(CH ₃) ₂ C:CH ₂	-7	yes	no	no
cis-2-Butene	C ₄ H ₈	3.7	>3.7	<3.7	no
n-Butane	C ₄ H ₁₀	-5	yes	no	no
iso-Pentane	C ₅ H ₁₂	30	no	yes	no
n-Pentane	C ₅ H ₁₂	36	no	yes	no
Ethylbenzene	C ₂ H ₅ C ₆ H ₅ *	136	no	yes	slightly
Formaldehyde	CH ₂ O	-21	yes	no	yes

This, and the following three transparencies, is a partial list of hydrocarbon substances tested for in automotive test procedures when hydrocarbon speciation is performed. It will give you an idea of what is represented in the "total hydrocarbon" numbers presented earlier - remember, we are talking about four-stroke, modified automotive engines.

Most of the substances on this list are not water soluble. That is not to say that they do not remain in the water. It has been the belief of many that these compounds float to the surface and evaporate. Many do have a weight and density lower than water and will tend to rise to the surface, but how long they remain on the surface of the water is uncertain. Some are absorbed by particulates in the exhaust and suspend or settle to the bottom. Some are miscible - mix completely with water. Michael Moore discussed effects from polycyclic aromatic hydrocarbons - hydrocarbon substances that are resistant to breaking down organically because of their double bonds and ring-like structure. Aromatics remain in the water for longer periods of time. The aromatics on this list are marked with an asterisk.

 MARINE ENGINE EMISSIONS <i>Hydrocarbon Compounds In Exhaust Gases</i>					
Chemical Species	Aromatic	Boiling Point °C	Gaseous at 0 - 25° C	Condenses at 0 - 25° C	Water Soluble
Ethylene	C ₂ H ₄	-104	yes	no	no
Propylene	C ₃ H ₆	-48	yes	no	no
Propadiene	C ₃ H ₄	-34	yes	no	no
1-Butene	C ₄ H ₈	-6.3	yes	no	no
Trans-2-Butene	C ₄ H ₈	1	>1	<1	no
3-Methyl-1-Butene	C ₅ H ₁₀	20	>20	<20	no
1-Pentene	C ₅ H ₁₀	30	no	yes	no
Benzene	C ₆ H ₆	80	no	yes	slightly
Metaxylene/MTBG	C ₆ H ₄ (CH ₃) ₂	140	no	yes	no
Paraxylene	C ₆ H ₄ (CH ₃) ₂	135	no	yes	no



I mentioned earlier that the system for exhausting emissions from four-stroke marine engines may be problematic with respect to their impact on the aquatic environment. Most inboard and I/O engines exhaust into the water. The exhaust system is water jacketed from the exhaust manifold down, with exhaust gases mixing with "sea water" before being expelled from the boat. Controlling heat in the engine compartment and sound dampening are the reasons for this. Additionally, the exhaust is churned into the vessel's prop wash, on most recreational boats.

There are two potential problems in this method of exhausting hydrocarbon emissions from four-stroke marine engines. First, the exhaust gases are forced from the engine's cylinders at temperatures of between 400 and 600 degrees Celsius. These gases cool to some degree but still remain at very high temperatures, sufficient to maintain the gaseous state of the exhaust compounds, until they hit relatively cool water. On my speciation list, I have included boiling points of the listed hydrocarbon species. These temperatures, at atmospheric pressure, are the points at which the substances change from a liquid state to a gaseous state and vice versa. As you can see, many of the substances expelled in a gaseous state, will condense when cooled by water at temperatures between 0 and 25 degrees Celsius - a reasonable range for most boating waters. Of course, one is not likely to go boating in water below 0. This condensation of exhaust gases resulting from the cooling effects of water has been referred to as "water scrubbing," an appropriate way of describing how a significant portion of the total hydrocarbon output of marine engines remains in the water.

The second problem is somewhat speculative but serious enough in its potential impact on water quality to warrant further investigation. Based on what has been observed in pyrometric chemistry, it is reasonable to assume that hydrocarbon gases react with water when subject to the dramatic change in temperature in a marine engine exhaust system. Such reactions add hydrogen and oxygen to the molecular structure of many substances, further altering their characteristics in water. To demonstrate, I will use the substance propadiene (C₃H₄) as an example.

 MARINE ENGINE EMISSIONS <i>Hydrocarbon Compounds In Exhaust Gases</i>					
Chemical Species	- Aromatic	Boiling Point °C	Gaseous at 0 - 25° C	Condenses at 0 - 25° C	Water Solubility
Orthoxylene	C ₆ H ₄ (CH ₃) ₂	145	no	yes	no
Acetaldehyde	C ₂ H ₄ O	21	>21	<21	yes
Ethane	C ₂ H ₆	-90	yes	no	no
Propane	C ₃ H ₈	-43	yes	no	no
Isobutene	C ₄ H ₈	-12	yes	no	no
1,3-Butadiene	C ₄ H ₆	-4.5	yes	no	no
2,2-Dimethylpropane	C ₅ H ₁₂	9.5	>9.5	<9.5	no
Methanol	CH ₃ OH	65	no	yes	miscible
2-Methyl-1-Butene	C ₅ H ₁₀	31	no	yes	no
Toluene	C ₇ H ₈	111	no	yes	slightly



Propadiene has three carbon atoms with double bonds between them (diagrams propadiene molecule), and four hydrogen atoms, like so $[H_2C=C=CH_2]$. In this state, propadiene is not water soluble. But, as a constituent of the exhaust gases entering a boat's exhaust system at high temperatures, it is likely that the "shock" of mixing with cool water will cause the double bonds in this molecule to break and pick up two additional atoms of hydrogen and one of oxygen (H₂O) from the water, like so $[H_2C-C(=O)-CH_3]$. With such a reaction propadiene becomes acetone - which is now water soluble. Adding oxygen to certain hydrocarbon molecules results in the formation of ketones, alcohols, and aldehydes - all of which are water soluble.

If these chemical reactions are taking place as we suspect, the make up and quantities of hydrocarbon species will look considerably different from automobile emissions. Higher quantities of ketones, alcohols, and aldehydes by volume will be the result; changing the picture entirely in terms of the impact marine engine hydrocarbon emissions have on the water.

 MARINE ENGINE EMISSIONS <i>Hydrocarbon Compounds In Exhaust Gases</i>					
Chemical Species	* Aromatic	Boiling Point ° C	Gaseous at 0 - 25° C	Condenses at 0 - 25° C	Water Soluable
Ethanol	C ₂ H ₆ O	78	no	yes	miscible
Acetone	C ₃ H ₆ O	56	no	yes	miscible
Methane	CH ₄	-161	yes	no	no

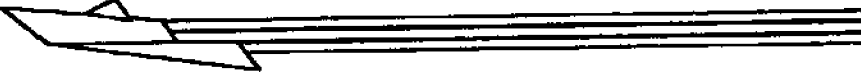

There are nearly 150 species currently tested for in HC speciations performed on gasoline fueled automotive engines. This list includes only a few of them. While four-stroke marine engines produce a very similar set of hydrocarbon species when tested with automotive emission test procedures, the quantities of each may look considerably different when "water scrubbing" and chemical/temperature reactions with water are accounted for.

If there is a research agenda to result from this meeting, I would recommend that it begin with an inventory of hydrocarbon species from a variety of marine engines including the chemical compounds produced, the quantity of each, and how they react with water. With exception of the duty cycle, the test procedures prescribed by the proposed EPA marine engine regulations are very similar to automobile engine test procedures designed to assess air quality impact only. A detailed hydrocarbon data set for a variety of inboard and outboard engines should be developed to provide a base-line on water quality impact and to determine priorities for research on toxic effects on aquatic life.



Energy Policy Act of 1992
Alternative Transportation Fuels

● "Alternative" fuels include the following:

- Methanol*
- Ethanol*
- Natural Gas (Methane)*
- Propane*
- Hydrogen*
- Coal-derived Liquids*
- Biological Materials*
- Electricity*

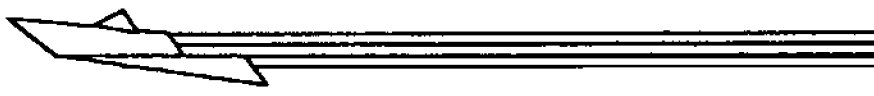

We have only begun to consider the impact of marine engine emissions on the aquatic environment. But even as we begin to understand the problem, we are presented with a technical solution. Alternative clean fuel technologies are proven in their ability to reduce harmful emissions from on-road transportation. The fuel equipment is here, available, and reliable for automobile engines. The same equipment can be used on marine engines and result in significant improvements in hydrocarbon emissions, even more so than late model automobile engines. The Department of Energy defines alternative fuels under the Energy Policy Act with this list. Note that the top half of the list consists of simple hydrocarbon fuels.



Analysis Of Hydrocarbon Emission Reductions With Alternative Fuels

Engine / Fuel	Speed % Of Rated	Torque % Of Full Throttle	HC (g/hr)	HC (g/hp-hr)
55 kW Outboard Gasoline	100	100	5360.0	
220HP Inboard CAAB Fuel	100	100	449.8	2.04
220HP Inboard 10% Ethanol	100	100	436.0	1.96
220HP Inboard 30% Ethanol	100	100	235.4	1.06
Control Engine Gasoline	100	100		2.45
Control Engine Propane	100	100		1.90
Control Engine Methane	100	100		1.55



I have gathered together hydrocarbon emissions data from three sources to provide you with an idea of the reductions possible using alternative fuels. The outboard data is from the SAE technical paper referred to earlier. The following three rows show data for three fuels from an EPA study comparing gasoline test fuels with ethanol blends. And the final three rows show data from a study performed at Phillips Petroleum comparing gasoline with propane and methane. I refer to the final three as data from a control engine - because of the measures taken in this study to reduce the engine system to its simplest form while controlling several variables to optimize the engine for the fuel it was burning. The data set shown here was produced in test situations that varied considerably. It is hard to make a meaningful comparison of grams per hour given the difference in displacement - unless, again we are seeing such a significant difference and the higher HC level is from the engine with the lower displacement. However, what is meaningful in comparing the data from these engines is HCs per horsepower. The hydrocarbon data in the far right column compares HCs on a per horsepower basis. HCs per horsepower comparisons can be made because the levels were derived from engines operating at their full rated speed, at full power. Grams per horsepower/hour information was not available for the outboard but you can do the math to put you in the neighborhood.

As you can see, significant hydrocarbon reductions can be achieved using cleaner fuel alternatives such as ethanol, propane, or methane. This has been confirmed time and time again for automobile engines.

Each of these fuel alternatives has its own advantages and disadvantages with respect to retrofitting requirements, safety, and emissions. I would like to discuss Compressed Natural Gas (or methane) because of its proven ability to produce the desired emissions results while holding considerable promise as an economical and safe alternative, with a well developed delivery infrastructure.

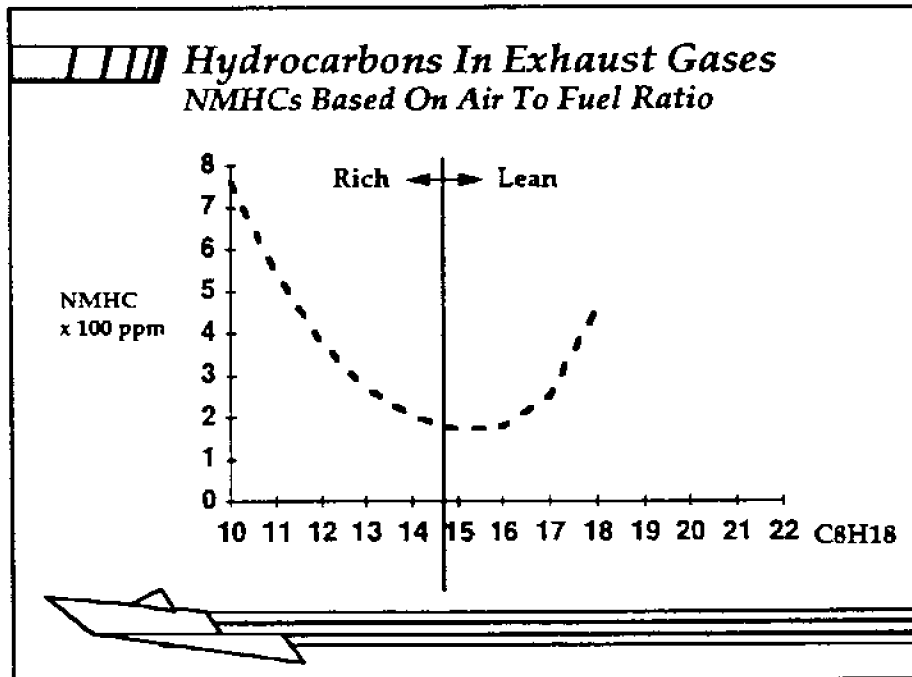

This graph shows the level of "non-methane hydrocarbon (NMHC)" emissions from gasoline as a function of air to fuel ratio in gasoline fueled four-stroke, spark ignited automotive engines. The x-axis scale at the bottom of the graph indicates air to fuel ratios for gasoline. The y-axis scale indicates hydrocarbon levels in parts per million. Stoichiometric (ideal air to fuel ratio) for gasoline is approximately 15 to 1. Hydrocarbon levels increase as the air to fuel ratio moves off stoichiometric and the mixture becomes rich or lean as indicated.

The distinction of "non-methane hydrocarbons" is made because the methane content of exhaust gases is ignored in current regulations for hydrocarbon emissions. While methane is a hydrocarbon, the Environmental Protection Agency has ruled that it is harmless and has no ozone producing effect. Only traces of methane can be found in exhaust gases from gasoline fueled engines.

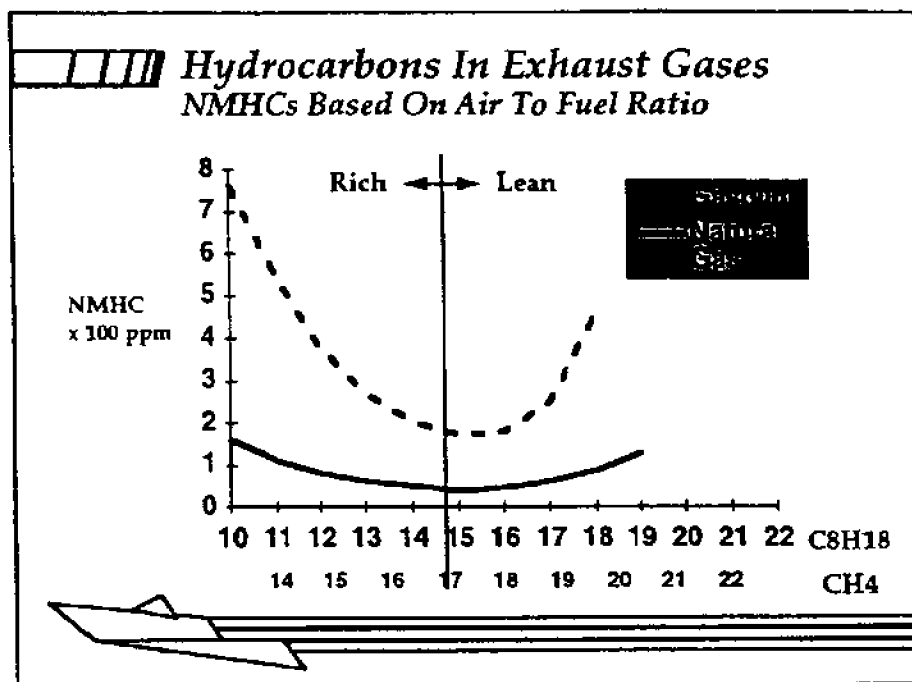

This graph compares NMHC levels from gasoline with NMHC levels from natural gas in automotive engines. The x-axis scales now include the air to fuel ratios for both gasoline and natural gas (methane). Stoichiometric for natural gas is approximately 17 to 1. The hydrocarbon emissions from natural gas are 80% to 90% methane.

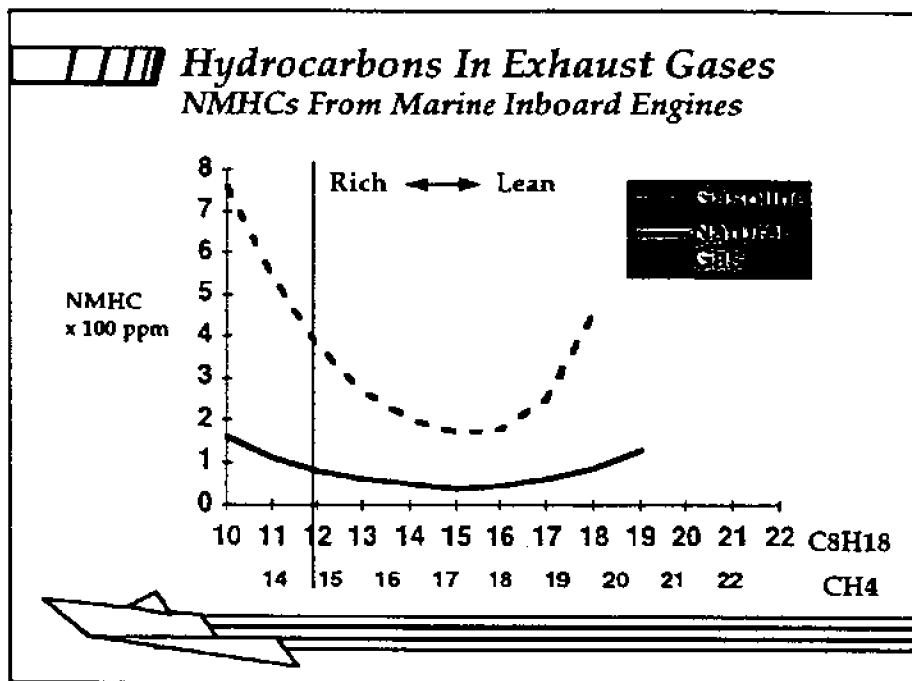

Marine inboard engines often generate rich air to fuel ratios under operation, as much as 12 to 1, to increase engine power. As indicated, this rich fuel mixture produces dramatically higher NMHC levels with gasoline. The increase in NMHC levels produced with natural gas are far less significant at comparable air to fuel ratios.

The 80 to 90 percent methane content of hydrocarbon emissions from a methane fueled marine engine would provide significant reductions in hydrocarbon compounds remaining in the water, both in total quantity and in substances believed to be harmful to the aquatic environment. Methane is the simplest hydrocarbon molecule - CH₄. It is limited in how it breaks down under high temperatures. It combines with hydrogen and oxygen in less harmful ways. Most of the harmful hydrocarbon substances produced by combustion in a gasoline fueled engine are not produced with methane. The percentage of methane in the exhaust of a methane fueled engine is a reflection of the simple composition of this fuel and the small number of intermediate compounds formed during combustion. In addition, the methane exhaust remains in a gaseous state after it is churned into the water and simply escapes into the air.

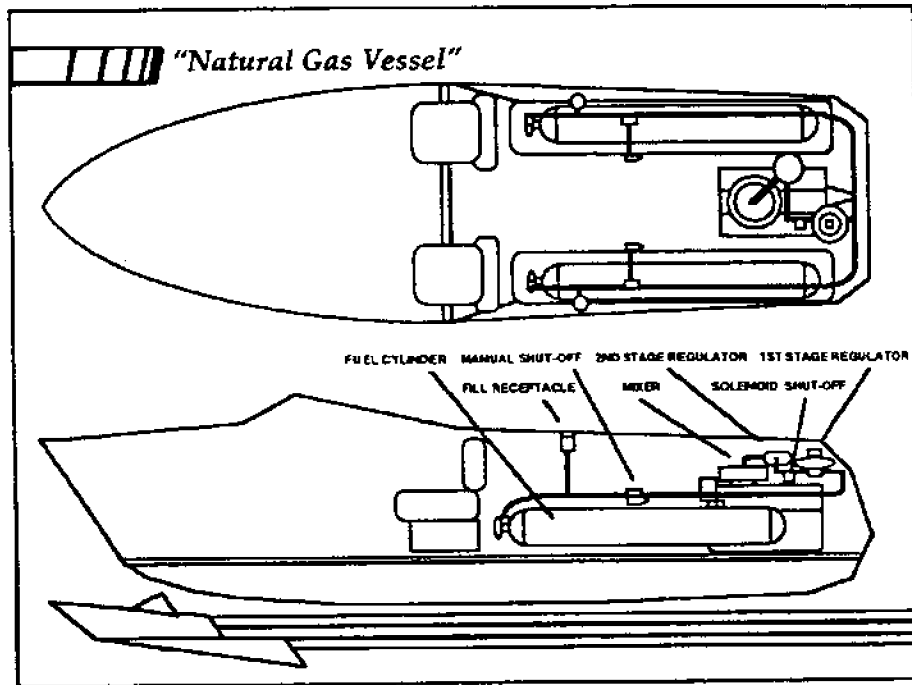

If you will indulge me for a moment, this diagram shows how a recreational vessel can be retrofitted with a Compressed Natural Gas system. Two fuel cylinders are indicated, perhaps placed underneath bench seats, to show how the fuel storage would be configured to achieve a range comparable to what is obtained from a gasoline tank on such a vessel. By the way, I mentioned that Brunswick owns both Mercuriser and Mercury Marine. Brunswick also manufactures an ideal CNG fuel cylinder for this application.

Other components used for converting a vessel from gasoline to a fully "mechanical" natural gas fuel system include a fill receptacle, manual and automatic shut-off valves, a first stage regulator to reduce the pressure of the fuel from 3000 to about 200 psi, a second stage regulator to reduce the pressure to just above atmospheric, and a fuel mixer at the intake of the carburetor or throttle body. That's it. Newer "electronic" natural gas fuel systems are also becoming available and provide sensor feedback, more accurate fuel delivery, and even better emissions over the entire operating range. The equipment is proven and available. The cost of this equipment may be off-set by the lower cost of natural gas, depending on the amount of fuel used over the life of the system. Natural gas is 25 to 30 percent cheaper, depending on your location.



Advantages Of Bi-fuel Natural Gas Vessels

- **Power Comparable To Gasoline Vessels**
- **Ability To Select Fuel For Protected Waters**
- **Emissions Lower Than Gasoline Vessels**
- **Lower Cost Fuel (Domestic)**



So, what are the advantages of natural gas as a marine fuel?

On a "bi-fuel" vessel - set up to operate on both gasoline and CNG - engine power is expected to be comparable to gasoline fueled vessels. The vessel would have the ability to select the cleaner burning natural gas for operating in designated areas - perhaps protected waters. Hydrocarbon emissions would be significantly lower than with gasoline, and the operator would have the benefit of lower fuel cost.



Advantages Of Dedicated Natural Gas Vessels

- Power Comparable To Gasoline Vessels
- Better Efficiency Than Gasoline Or Bi-Fuel Vessels
- Emissions Even Lower Than Bi-Fuel Natural Gas Vessels
- Lower Cost Fuel



If the vessel is set-up to operate solely on natural gas, there are things that can be done to optimize the engine for this fuel. The advantages with a dedicated natural gas vessel are . . .

The power is expected to be comparable to a gasoline fueled vessel. Greater fuel efficiency can be achieved over bi-fueled vessels. Emissions will be even lower than a bi-fueled vessel when operating on natural gas. And, the operator will have the benefit of lower fuel cost.

Finally, I would like to comment on the EPA's proposed marine engine regulations.

The EPA estimates a reduction in total hydrocarbon emissions from outboard marine engines of approximately 75% as a result of its regulations. This level will be reached only after the phase-in period that will begin with model year 1998 and conclude in 2006. The technologies used to meet the required reductions will be the more efficient four-stroke and fuel injected engines. In terms of their impact on air quality, there is no question that gains will be made. But a reduced impact on water quality is less certain. The greater efficiency derived from a four-stroke cycle or through direct fuel injection will come with higher temperatures. Greater efficiency and higher temperatures in the combustion process is likely to produce a wider array of hydrocarbon compounds and greater quantities of what is believed to be harmful to aquatic life, e.g., aromatic and polycyclic aromatic hydrocarbons. Reactions with water resulting from higher exhaust temperatures complicate the impact issue further with the production of ketones, alcohols, and aldehydes.

With respect to marine engine emissions, the proposed regulations are primarily designed to address the impact on air quality, even though this source of pollution has an impact, perhaps a more significant impact, on the aquatic environment as well. This focus on air quality is reflected in the proposed system of measurement for emissions compliance.

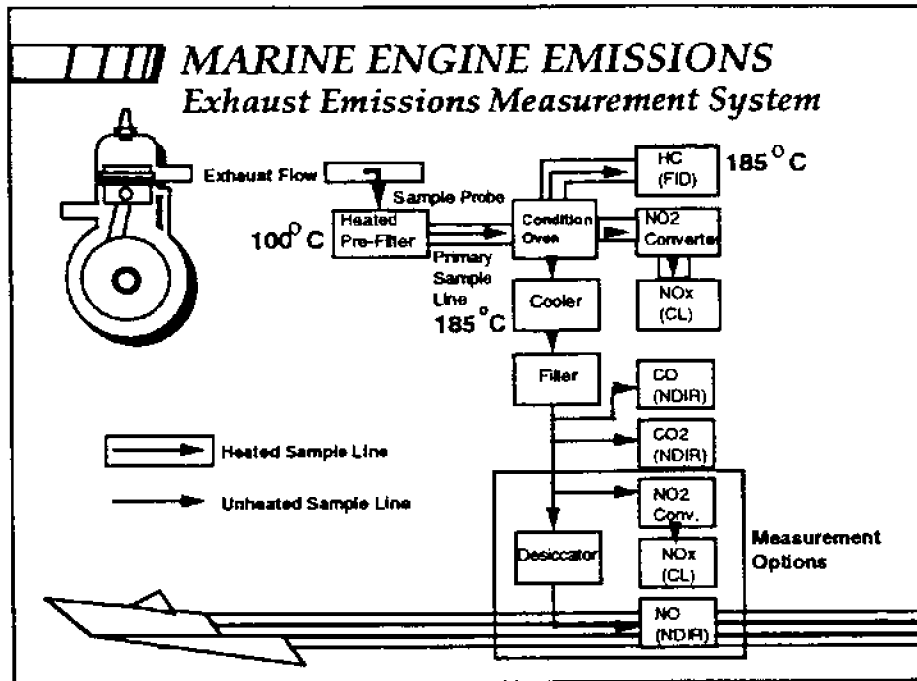

This is a diagram of the emissions measurement system likely to be used in testing engines by industry and reporting results to the EPA for compliance. It is a raw gas measurement system recommended to and accepted by the EPA. A constant volume sampling method that dilutes the exhaust gases to simulate mixing under actual conditions for engines exhausting into the air is also acceptable to the EPA. They both are problematic with respect to hydrocarbon emission measurements from marine engines.

As you can see in this diagram, a sample probe draws off an exhaust sample into a pre-filter heated to 100 degrees Celsius. The sample probe is inserted into the exhaust system above the water jacketing. The sample is then channeled through the primary sample line, into a conditioning oven, and a portion routed into the hydrocarbon "FID" for measurement, all maintained at 185 degrees Celsius. The hydrocarbon sample is maintained at this high temperature, higher than most hydrocarbon boiling points, to prevent condensation. The remaining exhaust sample is routed on, with cooling and drying stages involved, for measurement of CO, CO₂, and NO_x.

This system, and the constant volume sampling system mentioned above, is appropriate for exhaust emitted directly into the air as with automobile engines. However, it will not produce emissions data reflective of the actual operating conditions of gasoline fueled marine engines that exhaust into water. The problem lies with the absence of the cooling and scrubbing effects present when hydrocarbon emissions from marine engines exhaust into water. The exhaust from marine engines are far richer in hydrocarbon content than automobile engines, as you saw earlier. If allowed to cool to the temperatures of boating waters, condensation of hydrocarbons in these rich gases would be significant. Once the exhaust is churned into the water and condensation occurs, a portion of the hydrocarbon content remains in the water. The exhaust sampling and measurement system proposed does not account for the condensation and water scrubbing that occurs in the environment in which these engines operate.



MARINE ENGINE EMISSIONS *Concerns For Draft Regulations*

The proposed exhaust measurement procedures produce an inaccurate picture of marine engine impact on air quality due to the absence of water "scrubbing" that occurs during boat operation.

The proposed exhaust measurement procedures provide no data on hydrocarbon compounds released into the water, and therefore, establishes no comparable means of accountability for impact on water quality.

The proposed regulations contain no provisions for the application of alternative clean fuels.



Therefore, my concerns for the marine engine regulations are:

The proposed exhaust measurement procedures to certify emissions compliance produce an inaccurate picture of the recreational marine engine's impact on air quality due to the absence of water scrubbing and cooling effects present during actual boat operation. While useful in monitoring hydrocarbon reductions and emissions averaging, the data generated with these test procedures will be of limited value to regional authorities currently attempting to evaluate boating's contributions to smog. Without factoring in the effects of water scrubbing, the data generated with the proposed test procedures (if made public) will be artificially high as they relate to air quality impact. If these figures are made available to regional policy makers, fair treatment of the boating public in decisions to restrict recreational boating as a part of VOC reduction plans may be difficult.

The proposed exhaust measurement procedures provide no data on hydrocarbon compounds released into the water, and therefore, makes no assessment of water quality impact. The proposed test procedures are designed to support a system of accountability for marine engine impact on air quality only. There is no comparable means of accountability for their impact on water quality, even though these engines operate and exhaust into an aquatic environment.

The proposed regulations contain no provisions for the application of alternative clean fuels as with on-road sources. Significant emissions reductions can be achieved with proven alternative fuel technologies and should be encouraged to stimulate growth in a small, but growing transportation industry.

Massachusetts' Regulatory Perspective

Jan Smith

Office of Coastal Zone Management, Boston, MA

I work for the State Coastal Zone Management Office. Today I will talk about what the office is contemplating in regard to regulating marinas and boating activities. For those of you who do not know, the Coastal Zone Program is a federally created program funded by NOAA. Each coastal state has a program and it is usually in that state's environmental agency.

I work in the nonpoint source control program. It is an effort to control pollutants from a variety of sources that range from agricultural and urban runoff, to marinas and boats. This program was part of a Congressional mandate and EPA and NOAA developed the guidelines for implementation by the states. EPA has also produced some specific requirements with the intent that states would develop enforceable controls for items of specific concern. Fifteen of the items are related to marinas and boating activity. Seven consider the design and siting of marinas but we are not building many marinas here in Massachusetts these days. Over the last 15 years only three or four new marinas have been built; we are pretty much at saturation. However, the last eight EPA requirements relate to marina and boat yard operation and boat activities. The one requirement that may be of most relevance and interest to us today is the one that addresses boat operation and management.

At the state level, we and the other coastal states have been charged to come up with programs that insure compliance with all of the federal measures. EPA has not told us exactly how to accomplish this. They have given us some suggestions for how to control boating activities — for example, how to get at boat cleaning activities and how to manage petroleum products. But it is up to us to develop precise components for enforceability. Again, every state along the coast is looking at these same requirements and trying to figure out how they are going to implement them. I am going to talk about where we stand in Massachusetts and the approach we are contemplating for meeting the federal requirements.

Essentially, Massachusetts has both state and federal regulations. Federal regulations, while they address marine structures to some extent, do not get very involved in the enforcement of some of the smaller impacts from marinas and boats. At the state level we do have programs that will address some of these problems. We have, for example, the Wetlands Protection Act, which considers impacts from activities that are being proposed [e.g., in applications for permits for coastal development]. It does not really address ongoing activities, and it certainly does not get at problems associated with boat use.

In addition, we have a Tidelands Licensing Program. Along with the Wetlands Program it is administered by our Department of Environmental Protection. A Chapter 91 Tidelands License is a permit that is needed for any permanent structure that is placed in an intertidal area.

Although these regulations do not specifically address temporary structures like boat mooring fields, one of the original intents was to establish guidelines for establishing mooring territory. But not very much has been done with setting standards or requirements for these areas.

The State also has programs that look at land use in the coastal area. We have a critical areas program that establishes Areas of Critical Environmental Concern. These are designated by the state in response to local requests for special protection of areas that are considered to be deserving of such treatment. A set of environmental criteria is used to evaluate each proposed area and the formal designation confers an additional level of protection. In these areas a higher level of environmental review is needed for any proposed project. Although docks and piers are not prohibited within these special areas, they must comply with very strict requirements. For example, if a dock is permitted in a critical area, boats can only tie up at its seaward side; they are not permitted to pull up along the other side. Limitations are also placed on the size and the draft of boats permitted to use the dock.

Managers whose responsibilities include these Areas of Critical Environmental Concern have been authorized to develop specific management plans to control some of the activities that would occur in them. In Massachusetts none of the 15 or so coastal areas that have been designated as critical yet have such plans. If a manager were to come up with a management plan that regulated boating, it would then become an enforceable area for state regulatory authorities.

Harbor planning is also administered through the Coastal Zone Office. The Harbor Planning Office works with local communities to develop comprehensive plans for managing local coastal waters, the intent being to encourage towns to do an assessment of their resources and to manage the various uses within a harbor. Many harbormasters perform a variety of tasks, servicing the boating public as well as managing natural resources. In many cases they are under a great deal of pressure to find mooring locations for an increasing number of boats and this involves juggling some of the needs to protect critical coastal areas, such as shellfish resources and others.

Local comprehensive plans help the towns designate which areas should be set aside for protection, because of their natural resource value, and which would be acceptable for boating activities and mooring fields. Our office provides funding to towns to develop local comprehensive plans and once they are developed they become enforceable by the State Department of Environmental Protection.

In the northeast, attempts to put in place any regulatory program for boats and marinas have to address the local home rule issue. Here in New England, home rule is a tradition which delegates a lot of authority to local governments on certain issues about which the State does not

really dictate to the town. So if the Coastal Zone Management Office wants activities to be controlled, we have to work with local authorities because they have the prime responsibilities. In many cases, these are the local conservation commissions who implement the State Wetlands Protection Act, or the harbor masters who are developing the mooring plans and working to locate other boating activities.

Our approach to developing controls is to focus on education as a key component for reaching the boating public. We have to start working with local officials, harbor masters in particular, to help them to develop some guidelines for how they are going to manage their boating activities. However, under our existing Chapter 91 Tidelands Licensing, there are supposed to be some guidelines for mooring fields. But state regulators have not yet provided those to harbor masters. In many cases, with the increasing demand for moorings, they are being placed in areas that are completely exposed at low tides, which means that they may be located on shellfish beds and shorebird feeding areas. And certainly one of the key issues that we are coming up against is how to determine carrying capacity for recreational boating that will allow us to maintain the environmental quality of our waters.

Most of the restrictions on boating operations have been concerned with safety. In our education efforts we need to start getting harbor masters — some of them are already very concerned about it — and the boating public to look at protecting habitat and, in particular, critical resources such as shellfish. Through our harbor planning efforts we can begin getting the public to consider zoning for the water area. We are already accustomed to zoning on the land for specific goals and purposes, and we have to reach that point on the water as well.

As mandated by Congress, we have to develop a state strategy addressing the enforceability of all these requirements. They are pretty broad-ranging and this will be a challenge. We have to submit our formal plan to EPA and NOAA by July 1995, and we are going to be going through an extensive public review process before then.

Mass Coastal Zone Management Program Issues: Non-Point Source Measures

A. Marina Flushing Management Measure

Site and design marinas such that tides and/or currents will aid in flushing of the site or renew its water regularly.

B. Water Quality Assessment Management Measure

Assess water quality as part of marina siting and design.

C. Habitat Assessment Management Measure

Site and design marinas to protect against adverse effects on shellfish resources, wetlands, submerged aquatic vegetation, or other important riparian and aquatic habitat areas as designated by local, State, or Federal governments.

D. Shoreline Stabilization Management Measure

Where shoreline erosion is a nonpoint source pollution problem, shorelines should be stabilized. Vegetative methods are strongly preferred unless structural methods are more cost effective, considering the severity of wave and wind erosion, offshore bathymetry, and the potential adverse impact on other shorelines and offshore areas.

E. Storm Water Runoff Management Measure

Implement effective runoff control strategies which include the use of pollution prevention activities and the proper design of hull maintenance areas.

Reduce the average annual loadings of total suspended solids (TSS) in runoff from hull maintenance areas by 80 percent. For the purposes of this measure, an 80 percent reduction of TSS is to be determined on an average annual basis.

F. Fueling Station Design Management Measure

Design fueling stations to allow for ease in cleanup of spills.

G. Sewage Facility Management Measure

Install pumpout, dump station, and restroom facilities where needed at new and expanding marinas to reduce the release of sewage to surface waters. Design these facilities to allow ease of access and post signage to promote use by the boating public.

A. Solid Waste Management Measure

Properly dispose of solid wastes produced by the operation, cleaning, maintenance, and repair of boats to limit entry of solid wastes to surface waters.

B. Fish Waste Management Measure

Promote sound fish waste management through a combination of fish-cleaning restrictions, public education, and proper disposal of fish waste.

C. Liquid Material Management Measure

Provide and maintain appropriate storage, transfer, containment, and disposal facilities for liquid material, such as oil, harmful solvents, antifreeze, and paints, and encourage recycling of these materials.

Q (by George McCarthy) You mentioned that you wanted to estimate the carrying capacity of the local environment for boats. How would you actually go about estimating that?

A (by Jan Smith) That is a question that we are currently trying to answer. Because we are trying to look at the cumulative impacts of some of these activities, we do not want to be in the position of completely prohibiting those that we do not need to. But it is clear that the accumulation of a number of activities certainly starts to have an environmental impact and where you draw the line to start limiting the number of boats in an area or the number of people you allow to have access to a wetland resource, I do not know how to define. For regulatory purposes we have to have some scientific base for what we do. So we look to the scientific community and others for what evidence there is for what level of activity causes the impacts.

Q But you will end up with a number that you will use to form a policy, I guess, right?

A Well, ideally, yes. Clearly in the regulatory climate that we have now, we need to be able to have firm backing for whatever regulations we come up with. As you heard earlier, boaters perceive that they have the right to free navigation wherever they want to go. We have to come up with some clear evidence that there are impacts and that we have a clear basis for establishing a regulatory policy.

Q (by Rick Crawford) In that regard, what do you expect to have next July? If you do not know how to do it, what are you going to produce for a product?

A Many of the requirements in here relate directly to marina design. I think we already have requirements for those in existing regulatory programs. It is a matter of having the state enforcement officials understand what this means and also having local boards understand how they would implement some of these controls. At this point, in many cases it is not really clear how these requirements can be implemented. Right now the state is pretty overwhelmed with some permitting requirements and they have done little or no enforcement of some of them. They are anticipating over the next couple of years that they are going to be able to step up their enforcement activities and ensure that the environmental requirements under the Tidelands Licensing and Wetlands Protection Act are being met. In terms of our strategy, I think we are going to rely on existing authorities.

Q (Ellie Dorsey) Do you have any information as to whether or not eelgrass here in Massachusetts is impacted in much the same way that the turtle grass in Florida is being impacted by boaters?

A I do not think we have that information, and we do not have a good mapping system yet. For eelgrass we will in the near future. We have some information that eelgrass has been drastically reduced in some areas, but we do not know why. The information that we will have pulled together in the next year for eelgrass in our coastal waters will provide some basis for future actions.

Q A related question. When making decisions about locating mooring fields, for example, is the presence or absence of eelgrass taken into account?

A Right now it is not. The decisions in most cases are made by local harbor masters. Some are conscious of the importance of protecting eelgrass beds and others are not. DEP has not provided any regulatory guidance on how to site mooring fields. It is their intent to do so, but they have not yet. My goal is to get information out there so harbor masters can find out where the eelgrass is in their areas and take this into account when siting mooring fields. In one town on the North Shore the harbor master had to reduce the number of boats in his harbor by two hundred. It was very traumatic and very controversial, but it is the sort of situation where we need to start thinking about providing the right kind of backup to local officials to support their decisions.

Q (by Michael Moore) I believe in Scandinavia there are studies that have suggested that the carefully controlled impact of marinas is less actually than mooring fields for the equivalent number of boats because of the chronic bottom disturbances that Curtis spoke of today. There is some literature which would be interesting to plug into the decisions that are being made currently. You know, that is a hard thing to conceive of, a picturesque New England mooring field versus yet another marina and how that relates in costs and benefits to the local economy. It is a very complex story.

A We are trying to look at the other impacts, and I think certain marinas are using a lot of petrochemicals, so marinas are also a source of ...

Q But all the boats on the mooring fields are being maintained by the marinas.

Federal Sportfish Restoration Program

Vaughn Douglas

Division of Federal Aid, US Fish and Wildlife Service, Hadley, Massachusetts

The Federal Aid and Sportfish Restoration Program is one of the oldest and one of the most successful partnerships between state fish and wildlife agencies in the Fish and Wildlife Service. The program is designed to increase sportfishing and boating opportunities through wise investment of anglers' and boaters' tax dollars. The Sportfish Restoration Program was created in 1950 under the co-sponsorship of Senator John Dingle of Michigan and Senator Edwin Johnson of Colorado. It was funded by a 10 percent excise tax on the sale of rods, reels, creels, and artificial fishing lures and was called the Dingle-Johnson or D-J Program for about 33 years. During this period, nearly 430 million dollars were invested in sportfish restoration and management activities.

In 1984, the program was significantly expanded through an amendment to the original legislation—the Wallop-Breaux Amendment. The amendment established a new trust fund and provided new sources of tax dollars to generate additional revenue for sportfish restoration and boating activities. In addition to expanded funding for fish restoration projects, the amendment mandated funding for marine recreational fisheries and boating access projects, and provided for aquatic education.

The Wallop-Breaux amendment added several new sources of income. One was a tax on motor boat fuels, amounting to about 1.08 percent of the gasoline sales tax. The other was revenues from some new items of fishing and boating equipment that were added to the original items as well as import duties on pleasure craft, excise taxes on fish finders and electric trolling motors, and the interest generated by the trust fund.

In 1952, the first year that funds were distributed to the states through the Dingell-Johnson Program, less than 1.5 million dollars were made available. That figure grew to around 30 million dollars in the early 1980s. With the enactment of the Wallop-Breaux Amendment in 1984, funding increased to nearly 200 million dollars nationwide in 1990, and all of this was made available to the states. This represented a five-fold increase in funding over five years. These additional funds have enabled the participating states to provide many benefits to the angling and boating public that would have otherwise been impossible through traditional means.

Taxes are collected by the Treasury Department and put into the Aquatic Resources Trust Fund, which along with others contains the Sportfish Restoration account. Previously, after a six percent deduction for administration of the Act, the remainder was apportioned to state fish and wildlife agencies. Today, due to recent legislation, 18 percent comes off the top and goes to the Coastal Wetlands Grant Program. Presently, 20 million dollars is going to states for the Clean

Vessel Act. Funds are apportioned to the states under the Dingell-Johnson program according to the states' relative land and water area and the number of licensed anglers.

Our office, the Division of Federal Aid in Hadley, Massachusetts is in one of seven administrative regions of the Fish and Wildlife Service. We manage grant programs to state fish and wildlife agencies from Maine to West Virginia. In 1994, nearly 30 million dollars was apportioned to states in our region. Currently, we are obligating about 70 million dollars a year of new grant money to the states in our region. One of the original provisions of the Dingell-Johnson Act was that no state should receive less than one percent nor more than five percent of the total. Most of the states in our region are what are termed "minimum" states. By strict application of the formula they would have received less than one percent but because of this particular provision of the Act they receive the minimum one percent. We have only a few states above the minimum: New York, Pennsylvania, Virginia, and Maryland. The District of Columbia was brought into the program under the Wallop-Breaux Amendment, and it receives 1/3 of one percent.

States are required to match the federal money with 25 percent of their own revenues, which usually come from fishing license sales. However, this requirement can also be met by in-kind match money donated by a third party. Funds are spent by the states on a variety of activities: development (construction of facilities), fish stocking, habitat manipulation, surveys and inventories to establish licensing amounts and regulations, technical guidance to public and private landowners, aquatic education, administration, operations and maintenance, and land acquisition. Coastal states are now required to spend a fair share of their appropriation in the marine environment, and the fair share is determined by the ratio of freshwater to saltwater anglers. Up to ten percent of a state's given apportionment may be spent on aquatic education. This activity was not eligible before the Wallop-Breaux amendment. Likewise, states were formerly required to spend ten percent of their money to provide boating access. However, legislation in the Clean Vessel Act now requires them to spend at least 12.5 percent regionally over a five-year period. Most of the states in Region Five have chosen to spend only the minimum required. There is not a lot of money going into boat access compared to the total amount available.

Considering the expenditure of boating, access monies in our region over a four-year period, most of the money, about \$5.4 million, has been spent on operations and maintenance. There were a lot of access facilities constructed under the old D-J Program. Since many of these are now coming to the end of their useful life cycle, there are considerable operations and maintenance activities going on, along with renovations of existing facilities. Over the past four years, 98 facilities have been renovated in our region at a cost of about \$3.7 million. In contrast, there are only a few new projects being undertaken to increase access; about \$2.4 million in new construction comprises about 20 percent of the total. The remainder of the \$70 million is spent on land acquisition for new facilities or acquiring existing facilities.

Funds are also used for shoreline protection, gates to control traffic flow at access points and courtesy stations. And with increasing frequency, we begin to find courtesy stations being put in more developed areas, floating ramps to ease access to a boat once it is launched and to provide a place to tie it up while you park your trailer, and informational displays.

We also administer the Clean Vessel Act—legislation that authorized the deduction of moneys from the Sportfish Restoration account to construct, operate and maintain pump-out and dumping stations for removing boat sewage from either Class-3 marine sanitation devices or portable toilets, and to educate boaters in their benefits and use. This is a competitive grant program with up to 75 percent reimbursement to the state.

In summary, three factors are responsible for keeping the program as productive as it has been: a relatively stable funding base, protection of the state's license fee dollars through a diversion clause in the original legislation that says the state's license revenue shall be only used to administer the state fish and wildlife agency, and the requirement that the state fish and wildlife agencies and the Fish and Wildlife Service are working together.

The accomplishments of this program are possible because of the combined support of the stakeholders: anglers and boaters, equipment manufacturers, independent conservation organizations, state fish and wildlife agencies and the Fish and Wildlife Service

At this point, I will be happy to respond to any questions.

Q (by Bruce Carlisle) I am with the Massachusetts Coastal Zone Management program. My question is in reference to some of the renovation projects that U.S. Fish and Wildlife Service does. I was curious if there is any consideration given to nonpoint source pollution control when you are renovating boat ramps or putting in parking lots and retrofitting any of these ramps? Any sort of catch basins or any filtration systems—

A (by Vaughn Douglas) In many states that is now a requirement. They are putting in catch basins and they are also constructing holding areas where they will grade out an area and direct the surface water flow to these areas and they will filter it through stone. Buffer zones are used to keep the parking area away from the edge of the lake. In Maine, they are very concerned about phosphorus runoff, so they do a lot of sedimentation control.

Q (by Nils Stolpe) Is there any type of oversight in the development projects or any federal control, or is it turned over completely to the states?

A (by Vaughn Douglas) When the states develop a proposal for construction or renovation it obviously has to be for eligible activities. And the projects themselves have to be substantial in character and design, meaning they have to meet the needs of the state fisheries management plan for providing fisheries opportunities. They have to have good objectives, they have to have a feasible approach and the costs have to be equivalent with the benefits.

There is a lot of federal oversight in terms of compliance. They have to address the National Environmental Policy Act. Most of the projects will have to have an environmental assessment developed with public review. And if we decide there is no significant impact, we have to write a finding of no significant impact, and that is advertised for another 15 days. There is lots of opportunity for public input.

All of the states have their own state environmental legislation that they have to deal with. Historic compliance can become a big issue in certain situations. In fact, that probably comprises most of our work, helping the state deal correctly and appropriately with these issues.

Q (by George McCarthy) You showed the distribution of the funds from state to state. And how does the state go about acquiring a larger portion of the funds?

A By increasing license sales.

Q (by George McCarthy) So if they match more, they get more, is that—

A No.

Q (by George McCarthy) I mean, from the federal funds. You showed that New York got a much larger chunk than the minimum one percent.

A The apportionment is accomplished by formula and it is based on the relative land and water area of the state. Fifty percent of the funds are based on the land and water area of the state, and the other fifty percent are based on license sales, the number of licenses sold in the state. So really the only way they can increase their overall apportionment is to increase their license sales.

Q (by George McCarthy) So there is an incentive on the part of the state to increase the number of people who are fishing and the number of— the amount of use of these access points. So that incentive is there?

A Yes.

Q There has been a resistance to salt water licensing, at least in some states.

A Yes.

Q Is that pretty universal or would that be an opportunity to increase—

A States are looking at it as a very real opportunity to increase their license sales. And for those that have, it has affected their apportionment considerably.

Q (by Curtis Kruer) I am curious about what is being done by the program to restore sport fish populations.

A That is the other part of the program. Most of our funds, the other 87.5 percent, are focused on research and management activities for sport fish. And that includes constructing fish ladders, providing in-stream habitat devices, and stocking where it is necessary to maintain fish populations. Most of the money is actually directed toward sport fish management activities.

Q (by Dery Bennett) If this workshop came up with some research ideas, are any of the seven programs that you mentioned a possibility for funding?

A The funds are apportioned directly to the state.

Q (by Dery Bennett) In all seven?

A Yes. Either by apportionment by formula, by appropriation, or through competitive grants. The state decides within the eligibility requirements of the Act what kind of work they are going to do. There is an administrative grant process that is operated annually whereby we set aside approximately two and a half million dollars of the funds that are used for the administration of programs to fund research on a competitive basis. The research proposals have to respond to focus areas which are developed annually by state fish and wildlife agencies and the Service. The research has to benefit more than 50 percent of the states and the project can not run for more than three years.

But the apportioned dollars are largely used by the states to fund their own research. If you approached the state fish and wildlife agency you might be able to get a research project funded through it.

In the region, we do fund small scale projects. In fact, Boat US/Cleanwater Trust has got a small project in our region to develop a brochure for the Clean Vessel Act to educate the boaters on the impacts of boat sewage and how to take care of it.

Q (by Jim Joseph) New Jersey Division of Fish, Game, and Wildlife is trying to improve public access by building ramps. It seems in New Jersey we have either got broad expanses of wetlands that are not going to be developed or just wall to wall houses and we have had surprisingly a lot of opposition to ramp construction because the people who are already living there do not want more boating or more of the activities that accompany pleasure boating. We have had some very animated public hearings and a lot of opposition. Is this a problem unique to New Jersey?

A You do not have a unique problem at all. It is probably worse up in the northern part of our region, up in Maine, New Hampshire, and Vermont, where there are small ponds ringed by camps that have been there for years. The people begin to view the lake as their lake even though it is public. And you are right; the public meetings can be pretty vicious, and there is a great amount of opposition to some proposals, particularly those creating new access.

Q Given the boating pressures that Nils described earlier, is it necessarily appropriate that there is a federally supported program encouraging increased boating pressures on coastal and inland waters?

A I would not necessarily call it federal government encouragement. The mandate is a legislative mandate that the states spend 12.5 percent of their apportionment regionally over a five and one half year period. They have to do that or they lose the money.

Q (by George McCarthy) Could I respond to that too? There is an equity issue here as well. I mean, you can not just give preferred access to people who happen to own property on a body of water. So you can see that there is justification to provide equitable access.

Q (by Andre Mele) I have been involved in an activity on Seagull Lake in upstate New York that has caused a lot of confusion in the community. There were a number of existing access points and New York State DEC wished to add another one. The people in the community got up in arms and said, we have enough. And the DEC continued to try to get another ramp in there. And it was used by the people of that area as a simple means of boosting their revenue base.

And now I see the mechanism. I understand the pressure on the DEC to have done this. In fact, it finally boiled down to a battle between the Parks and Historic Restoration Department of New York State and the DEC, as the preferred site was in a New York State Park. And they finally agreed to disagree and the ramp went away. But there was clearly a great deal of pressure to put this ramp in, and it was viewed by the community as an act of pressuring them into accepting more boats on their lake, which was already open to a significant number of boats. So this is not altogether viewed as a positive phenomenon.

A (by Vaughn Douglas) That is very true. And it is not altogether uncommon to run into that throughout our region. But generally we find the opposition in the northern part of our region. In Virginia, West Virginia, when we put out a public notice for comments on an environmental impact statement, we will get no response at all.

Q (by George McCarthy) How is the information distributed? Is it in the public section of the classified ads in newspapers?

A Yes. In many instances the states will become more pro-active in that, and they will have their own public meeting before they go in and try to do anything.

Q I am from New York. I think we have three state-run boat ramps for the whole Long Island area, which has well over half of the number of registered boats. The upstate area has, I think, something over 90 or 100. There is great pressure to get more state-run facilities in the Long Island area because public boat access to the water is almost nonexistent. So it does come down to a matter of equity. Are the only people that have access going to be those that live on the water, or is there going to be some way that you can get the access for the inland boaters?

A It is a very contentious issue. And by the way, we are putting in two ramps on Long Island.

Findings and Conclusions (in outline form) of the Work Groups:

1. Turbulence Work Group

Participants: Crawford, Stolpe, Hartge, McCarthy, Wilbur

I. What do we know?

A. Turbulence causes mixing.

1. Resuspends sediments.
2. Changes the structure of nutrient loading -- phosphates, nitrates released as sediment move up in water column. Oxygen depletes with nutrient loading. Other noxious materials in the sediment are kicked up: PCBs, metals. Possible link to eutrophication.
3. Mixes stratification of environment -- salinity, temperature, dissolved oxygen.
4. Extent of mixing estimated at 300% of hull depth.
5. Turbulence-related turbidity changes with boat speed (depends on boat-type, propulsion type, characteristic of sediment, depth of water).
 - a. Decreases with decrease in speed of displacement hulls.
 - b. Decreases with increase in speed of planing hulls.

B. Turbidity increases light attenuation.

1. Has negative impact on SAV: inhibits growth, decreases compensation depth.
2. Generates behavioral effects for fauna: behavioral cues related to light, feeding, may cause loss of natural cover or habitat, may provide refugia where prey can avoid predators.

C. Addition of particulate matter to water.

1. Adhesion of resuspended sediment to eggs reduces gaseous exchange and increases their weight (e.g., eggs sink).
2. Direct addition of hydrocarbons and other effluents from motors (e.g., unburned fuel from two-cycle engines). Point: Not just inorganic compounds are stirred into water.
3. Clogs filtering apparatus of bottom filter feeders and in severe cases may clog fish gills.
4. Increase sedimentation rates affects SAV (e.g., covers plants and reduces photosynthesis).
5. Indirect or direct cause of habitat loss.
6. Increases surface area for particulate adhesions and chemical or physical interactions. Point: Some species (e.g., salmonid fishes) are very sensitive to turbidity. As such they may be affected by many components of section I.C.

D. Benthic demersal eggs or larvae are smothered by sediments.

- II. Research in progress.
 - A. Ongoing studies by the Maryland Department of Natural Resources.
 - B. Otsego Lake study.
 - C. Boating impacts research at the Waquoit Bay National Estuarine Research Reserve.
 - D. National Estuarine Research Reserve System Monitoring Program (22 sites nationwide) is collecting baseline data (e.g., ambient turbidity).
 - E. Others, such as ongoing studies by the US Army Corps of Engineers?
- III. What do we need to know?
 - A. How do the things listed in item number 1 vary with:
 1. Boat characteristics -- hull shape, engine horsepower, ...
 2. Operating characteristics -- boat speed, weight of load, ...
 3. Site specific characteristics -- depth, channel width, current patterns,
 4. Environmental characteristics -- bottom cover, sediment type, ...
 - B. How do the different effects interact with each other? How is this interaction mediated by environmental characteristics?
 - C. What is the dimension of the affect on turbidity of boating activity compared to other sources, natural and anthropogenic?
 1. Weather
 2. Runoff.
 3. Shore-side activities (marinas, campgrounds, launch ramps).
 4. Land use patterns (industrial, agricultural, housing, natural vegetation).
 5. Commercial fishing (clam raking, shellfish dredging, shrimp trawling).
 6. Construction (docks, bulkheads, channel dredging).
 7. Natural variation and seasonal patterns (ambient levels, storms).
 - D. What is the relation between boat disturbance and the size/depth of water body?
 - E. What is the link between chronic and acute turbidity? Do short-term high turbidity events relate to long term changes in turbidity?
- IV. Research Issues.
 - A. Quantification of relative contributions of various sources of turbidity (see item 3).
 - B. Identification of variables that are vulnerable to change.
 - C. Quantification of biotic responses to varying turbidity.
 - D. Identification of variables that are alterable by human intervention.
 - E. Identification of alterations that can have undesirable ecological implications (e.g., increased current flow to increase flushing to decrease ambient turbidity may affect habitat function as a nursery or feeding area).
 - F. Development of a predictive model.

V. Research Plans/Collaboration

A. Long term research and data logging that:

1. Establishes site-specific / habitat characteristic levels of ambient turbidity, in relation to:
 - a. Weather: wind direction and speed, precipitation, season.
 - b. Sediment size and characteristics.
 - c. Boating Activity.
 - d. Shore-side activities.
 - e. Other water characteristics.

B. Standardization of measurements (for short-term and for long-term projects).

1. Develop a measure to describe boating activity.
2. Data collection strategies.
3. Sampling protocol.
 - a. frequency of collection
 - b. sampling depth
 - c. sampling design
4. Methods of evaluating biotic response to turbidity.

C. Site selection based on:

1. Boating use.
2. Adjacent land use.
3. Bottom type and vegetation.

D. Coordination of research efforts and centralized collection and distribution of data.

VI. Funding Sources

A. Federal.

1. EPA
2. US Fish and Wildlife.
3. NOAA
4. NSF
5. CZM
6. Other?

B. State Environmental Agencies

C. Special Interest Groups

1. Foundations
2. Industry (e.g., Brunswick Corporation — a boat and engine manufacturer)
3. Boats US
4. Others?

VII. Legislative Agenda

- A. The Turbulence Work Group felt that more research is needed before full agenda can be developed. At present, legislative assistance in securing funding opportunities for research would be most beneficial.

2. Toxic Boating Effects Work Group

Participants: Tucker, McLaughlin, Celander, Moore

I. What do we know?

- A. Studies have been done on issues of tainting, the sea surface microlayer, acute and chronic effects of hydrocarbons, and others (see Neff, 1985).
- B. Summer weekend peak in volatile compounds attributed to boat operation (see Mantoura, 1982).
- C. Toxicological effects of hydrocarbons (HC) on aquatic life - an extensive literature. One paper specifically mentions 2-cycle effluent effects on mussels and oysters (Clark, 1974). Those effects included gill degeneration, physiological stress, and hydrocarbon uptake.
- D. Studies by Balk et al. on adducts and their effects, e.g., cytochrome P4501A induction and lethargy (Balk, 1994).
- E. Also other studies such as the effects of naphthalene and benzene on molting of blue crabs.

II. What research is currently in progress?

- A. Balk - Sweden (see report in this document)
- B. Moore - W.H.O.I. (see report in this document)
- C. Other?

III. What do we not know?

- A. Emissions —
 1. To understand exhaust gas partitioning we need to accurately sample exhaust gases in a way that is relevant to the aquatic environment; it should reflect the interaction of the exhaust gases with the water.
 2. No published inventory on 2 cycle emissions
 3. No comparison 2 vs. 4 cycle outboards
 4. Industry emissions data appears to be available to EPA but not to the public.
 5. Toxic effects can be mitigated by the marine engine industry, whereas the physical effects are more approachable by management of the use of boats.
 6. An inventory of HC emissions in the water, not just in the hot exhaust gas.

7. What compounds in what quantities are being generated by outboards and inboards and what are the effects of mixing and cooling in water?

B. Emission chemical fate —

1. Reactions of exhaust as it passes through water are not accounted for in current proposed EPA regulations. Hydrocarbons are produced by heat and pressure in cylinder. These then contact relatively cool water - there is a need to consider the aquatic chemistry.
2. Current regulations ignore the potential for scrubbing by water before it becomes an airborne contaminant.
3. The dramatic change in temperature may break carbon links -- change water chemistry (e.g., bonds forming with oxygen in water to produce water soluble compounds such as aldehydes, ketones and alcohols.)
4. Need to do GC and LC. Potential toxicity of those compounds should be reviewed.
5. Condensation -- marine engines being certified on the basis of analysis of hot gaseous exhaust upstream of water injection.

C. Toxicity —

1. Establishing which compounds are prevalent in OBM emissions would prioritize which compounds are of interest for toxicological research.
2. **Several species acute and chronic - effects on developmental stages.**
3. Experimental toxicology studies should be done.
4. Combined chronic laboratory study and field study of high impact boating area(s) such as Barnegat Bay compared with a reference site -- if one exists.
5. Chemical analysis of bottom sediment, bottom water, photic zone and surface microlayer.
6. Effects on aquatic vegetation (submerged and emergent).
7. Need to establish an experimental treatment level based on levels found in a high impact boating area.

D. Multi-source model —

- What percentage of chemical effects are due to boating activity? Even if it is not the major effect, it is all additive? Are there places not affected by runoff with high boating activity -- such as destination islands? Is the difference in auto road runoff compounds versus marine emission compounds qualitative or simply quantitative? May be relative ratios of various compounds that reflect source. What is the relative importance of marine emissions versus road run off? Could adduct fingerprints be used to differentiate between source type?

E. Mesocosms -

1. Model systems/facilities for the studies proposed here (e.g., MERL at U.R.I.)

- a. Use of candidate compounds -- especially those unique in boat engines (if there are any?).
 - b. Running boat engines in a mesocosm.
 - c. Introduction of toxicants.
 - d. Silt adsorption.
 - e. Sediment scour and resuspension (of sediment and chemicals).
- IV. What research collaborations should be established?
- A. West Virginia University has a light duty vehicle test center soon to be completed.
 - B. Joel Baker - University of Maryland - atmospheric deposition of hydrocarbons.
 - C. MERL (mesocosm facility) at The University of Rhode Island Graduate School of Oceanography.
 - D. Volunteer coastal groups to report on boating impacts - via census, and simple measures of boating impact such as turbidity.
 - E. A project to consider: Lake or estuary comparison study
 - Automotive engineer (Natural Gas Vehicle Technology Center?) to run test analyses to inventory HC generated and information on how they behave.
 - 2 and 4-cycle engines operating on industry accepted duty cycles and loading (ISOE4 duty cycle: Int. Council of Marine Industry Associations 5 levels of rated speed and torque).
 - Organic chemist with experience in high temperature chemistry
 - Toxicologist
 - Benthic biologist
 - Phytoplankton/ zooplankton biologist
 - Statistician
- V. Recommendations:
- A. Need to create a clean boat technology for the future. Possibly the best way in these conservative times to generate support.
 - B. Need to change the public awareness of the environmental costs of boating.
 - C. Inventory as complete as is practical HC emission by 2 and 4-cycle of outboards. The quantities that are produced and the reactions that occur once they enter the water (i.e., solubility, adsorption, reactions).
 - D. Compare with chemistry of automobile-derived emissions.
 - E. We should pursue potential solutions to these problems such as alternative fuels.
 - F. The toxics can be affected by the industry, whereas the physical effects are more changeable by management of the use of boats.

References for topics discussed by Toxics Working Group:

- Balk, L., Ericson, G., Lindesjö, E., Petterson, I., Tjärnlund, U., and Åkerman, G. 1994. Effects of exhaust from two-stroke outboard engines on fish - Studies of genotoxic, enzymatic, physiological and histological disorders at the individual level. Institute of Applied Environmental Research, Stockholm University, S-61182 Nyköping, Sweden TemaNord 1994:528 (66 pages). Nordic Council of Ministers, Store Strandstraede 18, DK-1255 Copenhagen K, Denmark.
- Clark, R.C., and J.S. Finley. 1974. Acute effects of outboard motor effluent on two marine shellfish. *Environ. Sci. Technol.* 8: 1009-1014.
- Mantoura, R.F.C., P.M. Gschwend, O.C. Zafirious, and K.R. Clarke. 1982. Volatile organic compounds at a coastal site. 2. Short-term variations. *Environ. Sci. Technol.* 16: 38-45.
- Neff, J.F. 1985. Polyaromatic hydrocarbons. Pages 416-454. In G.M. Rand and S.R. Petrocelli, eds. Fundamentals of Aquatic Toxicology. Washington, D.C. Hemisphere.

3. Legislation Work Group

Participants: Mele, Bennet, Smith, Carlisle, Kendall, Podlich, Roesler and Hinch

- I. What legislation/regulation exists?
 - A. Clean Water Act
 - B. National Estuarine Program
 - C. National Estuarine Research Reserves
 - D. Coastal Zone Management Act
 - E. Clean Air Act
 - F. Clean Vessel Act
 - G. Oil Pollution Prevention and Response
 - H. Wilderness Act
 - I. Endangered Species Act
 - J. Rivers and Harbors Act
 - K. National Wild and Scenic Rivers
 - L. Coast Guard Safety programs
 - M. Magnuson Act - habitat protection section
 - N. National Biological Survey
- II. What research collaborations should be established?

- A. Support the goals of management measures and the inclusion of local initiatives to boost state programs.
- B. Provide money to states for technical guidance regarding wide sweeping legislation that tackles nonpoint source issues.
- C. Traditionally, an environmental agency at the state level is an enforcement agent. It is difficult to entice people to accept technical assistance when you are wearing an enforcement hat.

III. Which issues are, can and should be managed by legislation?

A. Boating practices:

These can be regulated as in the following example from the State of Maryland: Designated areas which are commonly congested have a six knot speed limit at all times. This is a safety regulation to promote safe operations. There is a 35 knot maximum speed limit on all waters away from congested areas. There is also an area with a speed limit of six knots for boats greater than 17 feet in length (i.e., boats with larger wakes) and no speed limit for boats under 17 feet (i.e., boats with smaller wakes). Other areas are minimum wake zones (boats proceed only at the speed necessary to maintain steerage) to protect highly erodible shore lines, shallow bottoms, and natural heritage sites, or to promote passive recreational use. Boating is totally prohibited (sometimes seasonally) in some areas to protect species listed as threatened, endangered, or in need of conservation. Some areas are designated for water-skiing and regulations accommodate professional or more accomplished skiers as well as recreational skiers. To minimize conflicts that might arise if both groups used an area simultaneously, boats are classified according to performance standards and noise emissions and areas are open to the different categories according to a schedule. There are special regulations for personal watercraft, mostly for operator safety but also for shallow habitat protection. Speed is limited to six knots within 100 feet of the shoreline, other vessels, piers, or other structures.

Operators must be at least 14 years old and have taken a boating safety course; if you are from out of state, you have to complete a preparatory course before you can rent one. An additional regulation limits the engine noise level of offshore-racer type boats to 75 decibels.

B. Engine emissions:

This is another issue that can be limited/affected by regulations (see Toxic Boating Effects Work Group report).

IV. What is an appropriate legislative agenda at the national and state level?

- A. The Legislative Work Group did not feel that new federal legislation is needed at the present because existing legislation and regulations are not being fully utilized. Utilization can be improved with education of the public, those responsible for enforcement, planners, and managers.

- B. Education is something environmental groups, commissions, power squadrons and Coast Guard Auxiliaries, local groups, harbor masters, and others can help with.
- C. We need to convince everyone that all of us boaters are part of the problem and we are also part of the solution.

4. Docks Work Group

Participants: Weis, Joseph, Klin, Taylor and Taylor

Synopsis of Work Group's Perspective:

1. There is a historical, i.e. common law, right for property owners to have reasonable access to navigable water adjacent to their own property. The "reasonable" aspect means this access should not interfere unduly with what are commonly held to be public trust resources. In recent years, we have been redefining that which is reasonable.
2. A dock and/or bulkhead enhances the value of a property.
3. With increased population in coastal areas, we may have reached or even surpassed the critical point for some areas to withstand the environmental impacts resulting from increased access.

Work Group's Findings

I. State of knowledge:

- A. The two typical structures are docks and bulkheads. Only those erected and used for non-commercial applications will be considered here. The effects of these structures placed in estuaries can be divided as follows:
 1. Navigational effects:
 - a. Positive -- provides access for the property owner.
 - b. Negative -- intrudes physically into a waterway.
 2. Environmental effects:
 - a. Effects from physical presence:
 - shadows intertidal and subtidal vegetation.
 - changes natural shoreline (e.g., a bulkhead, converts soft, gradually sloping, intertidal zone to a hard vertical surface).
 - impedes circulation.
 - b. Possible toxic effects:
 - greater potential for fuel spills than at a professionally-run marina.
 - exposure to leachates from pressure-treated wood.
 - disturbances (bottom; near-shore water column) from boats that otherwise might not be operated in shallow near-shore areas.

3. Impinging on the public trust
 - a. Covering shellfish beds and interfering with shellfishing.
 - b. Disrupting aesthetics or impeding a view.
 4. Sociological effect
 - a. Neighbors "want one too" or "not in my backyard!"
 - b. Empowering abutting land owners by requiring their approval of the structure can lead to user conflicts when consensus is not reached.
- II. Research in progress.
- A. Several state agencies, including those in Massachusetts and New Jersey, are currently working on generic Environmental Impact Statements that will specifically cover docks and their effects.
 - B. On-going studies by Fred Short, David Burdick, and others at the University of New Hampshire Jackson Environmental Laboratory are researching environmental effects of docks (e.g., shading of submerged aquatic vegetation).
 - C. Several years ago Michael Leflor and others published a report on shading of tidal wetlands. The U.S. Army Corps of Engineers critically reviewed the document and identified areas needing additional research. (The Work Group did not include a bibliographic reference to this report.)
 - D. Toxic wood preservatives have been studied by Judith and Peddrick Weis [see report in this document]. Their work has resulted in nine reports since 1991.
 - E. There are several studies underway to examine alternative construction materials:
 1. EPA funded Materials in the Environment (MITE) project.
 2. Ongoing ecological investigations by Weis and Weis, supported by USDA.
- III. Research needs.
- A. States must complete generic environmental impact statements regarding dock and bulkhead issues, such as their cumulative environmental effects and the "carrying capacity" of a water body. To develop such EIS documents, there must be studies of the effects of multiple installations in a standardized area, as well as studies of other effects such as habitat fragmentation or the creation of sub-ecosystems (in other words, what is the carrying capacity of a standardized area?)
 - B. New Jersey is funding studies of dock impacts.
- IV. Research collaborations.
- A. Improve interagency communication within and between states re: research and policy.
 - B. Strengthen existing professional organizations (e.g., Coastal States Organization).

- C. Draw industry into funding government and academic research endeavors to enhance the credibility of studies examining contentious issues (e.g., toxic leachates from construction materials.)
- V. Funding sources.
 - A. Users' fees assessed to the boating industry and users (e.g., a dedicated portion of permit charges and/or a fuel tax).
 - B. Sea Grant sponsorship of this type of research because their interests include habitat protection for economically significant species.
 - C. Reprioritize or redefine the Wallop-Breaux program.
 - D. Private foundations, including grass-roots as well as established organizations.
- VI. Legislative goals.
 - A. Public education for environmental awareness.
 - B. Based on the outcomes of research efforts, amend statutes and rules of practice to help manage community needs and expectations, allowing for flexibility with local situations.
- VII. Legislative agenda.
 - A. Enhance education for environmental awareness and the stewardship concept regarding the placement and construction of docks and bulkheads and the operation of boats near them.

5. Living Resources/Physical Damage/Turbulence Work Group

Participants: Kruer, Harrington, Able, Leavitt and Dunlap

- I. Relevant topics the Work Group identified as areas for which we have at least some elementary information regarding the effects of turbulence and physical damage caused by boating.
 - A. Siltation
 - 1. Macrophytes and other submerged aquatic vegetation (SAV)
 - 2. Fish eggs and larvae
 - 3. Copepods
 - E. Chronic/temporary disturbance to invertebrates, birds, fish and mammals
 - 1. Birds (noise/activity)
 - a. Feeding
 - b. Loafing
 - c. Nesting
 - d. Noise/vibrations and communications/behavior
 - 2. Fish, especially in shallow water (noise/activity)

- a. Feeding
- b. Loafing
- c. Nesting
- 3. Mammals and turtles (noise/activity)
 - a. Physical (manatees, seals, cetaceans)
 - b. Stress (feeding, loafing, reproduction)
- 4. Invertebrates
 - a. Feeding
 - b. Reproduction
- C. Physical damage (dredging, collision, turbulence)
 - 1. SAV
 - 2. Mammals and turtles
 - 3. Fish (eggs/larvae, behavior)
 - 4. Invertebrates
 - 5. Siltation (resuspension)
- D. Disturbance
 - 1. Visual
 - a. Flight responses
 - i. Birds (not many specific to boats - see bibliography)
 - ii. Marine mammals
 - Whale-watching
 - Dolphin feeding
 - Manatees (Florida DEP, USFWS, NMFS)
 - 2. Noise
 - a. Acoustic Thermography Ocean Circulation project (ATOC)
 - b. Natural Resources Defense Council (marine mammal communication)
 - c. Whale watching
 - d. Fish
 - i. Vocalizations/communications/flight
 - e. Bird nesting and fright flight
 - f. Human quality of life?
 - 3. Shoreline erosion
 - a. Marine
 - i. Massachusetts Coastal Zone Management program
 - ii. Army Corps of Engineers
 - iii. Anne Arundal County, Md.

iv. Louisiana Delta studies

b. River bank erosion

II. What research is currently in progress?

A. Propeller scarring, anchoring

1. Vegetated bottoms

- a. University of New Hampshire -- Burdick
- b. Florida keys -- Kruer
- c. Tampa Bay -- Robin Lewis

2. Groundings (Florida keys)

B. Unvegetated bottoms -- Crawford

C. Collisions

- 1. Manatees (USFWS, Florida DEP)
- 2. Turtles
- 3. Other marine mammals

D. Turbulence (water column & microlayer at air/sea-surface interface)

E. Zooplankton (poorly documented -- analogy to power plants))

F. Fish eggs -- Hempel

G. Groundings

- 1. Coral reefs
- 2. National Marine Sanctuaries Program

H. Siltation/resuspension

- 1. Reduced growth rate in scallops
- 2. Hard corals/soft corals and turbidity
- 3. Macrophytes & light attenuation (NMFS)
- 4. Algal bloom effects
- 5. Primary production
- 6. Demersal fish eggs
- 7. Kills
- 8. Smothering effects

I. Shoreline erosion (boat wakes/wash)

III. What research collaborations should be established?

A. Managers/scientists

B. Estuarine reserves

C. National Marine Sanctuaries

D. National parks

E. State parks

- F. Federal reserves (e.g. national wildlife refuges)
 - G. Private reserves (e.g. Nature Conservancy)
 - H. Educational institutions and governments agencies
 - I. Multidisciplinary collaborations
- IV. Where should funds be sought to pursue these goals?
- A. US Army Corps of Engineers
 - B. Erosion, resuspension, SAV, bird disturbance -- dredge material islands, seagrass wetlands
 - C. Environmental Protection Agency
 - 1. Seagrass wetlands, water quality, related impacts of boats (e.g. marina siting)
 - D. National Oceanic and Atmospheric Administration
 - 1. Marine mammals
 - 2. Siltation resuspension as relates to habitat quality
 - 3. Seagrass and coral reef restoration
 - 4. Sea turtles
 - 5. Boating effects and recreational/commercial fisheries
 - E. National and state Sea Grant programs and colleges
 - F. Coastal Ocean Program
 - G. Coastal Center for Ecosystem Health
 - H. Estuarine reserves
 - I. Industry
 - J. Department of the Interior
 - K. Fish and Wildlife Service Coastal Ecosystems Program
 - L. Refuge System
 - M. Sportfish Restoration Fund
 - N. Park Service & National Seashores
 - O. State Agencies
- V. Which issues are, can and should be managed by legislation?
- A. Revisit existing environmental policies and relate them to boating issues (recreational and commercial)
 - B. Enforcement of existing laws
 - C. Zoning
 - D. Prop dredging/hull scarring
 - E. Harassment/disturbance
 - F. Noise
 - G. Activity

VI. What is an appropriate legislative agenda at the national and state level.

- A. Aquatic/marine zoning
- B. Ecosystem management
- C. Decoupling funding from resource management agencies
- D. Protection of fishery resources
- E. Operators' licenses
- F. Biodiversity protection

Appendices A-D: Bibliographies pertinent to boating impacts.

The following bibliographies pertain to published literature and unpublished reports about various aspects of the physical, chemical and ecological impacts of boating. The primary source of the material is noted in the title text of each one. Bibliographic formats have been edited from the original for consistency and references have been added to each by R. Crawford. The format of items in Appendix D have been only slightly modified from the original and differs from that in the other bibliographies.

A. Bibliography of various biological, physical, and chemical topics related to the impacts of boating.

Most of these references were contributed by Bruno Broughton, Nils Stolpe, and Michael Moore.

-
1. _____ 1988 Puget Sound Watershed Management Handbook. Addresses TBT's as well as bacterial contamination. Doesn't mention any other impacts
 2. _____ 1990 60% Drop in Oil Pollution Since 1981. *Marine Pollution Bulletin (News)*, 21, #12, 536.
 3. Adams, E.S. 1975. Effects of lead and hydrocarbons from snowmobile exhaust on brook trout (*Salvelinus fontinalis*). *Trans. Am. Fish. Soc.* 2.
 4. Anon. 1983. Waterway ecology. Inland Waterways Amenity Advisory Council. [Contains an annotated bibliography]
 5. Anon. 1993. South River comprehensive vessel management plan. MD Dept. Nat. Res. Boating Administration, 580 Taylor Ave, Tawes Office Bldg., E4, Annapolis, MD 21401
 6. Arruba, J.A., G.R. Marzolf, and R.T. Faulk. 1983. The role of suspended sediments in the nutrition of zooplankton in turbid reservoirs. *Ecology* 64.
 7. Balk, L., G. Ericson, E. Lindesjoo, I. Petterson, U. Tjarnlund, and G. Akerman. 1994. Effects of exhaust from two-stroke outboard engines on fish - Studies of genotoxic, enzymatic, physiological and histological disorders at the individual level. Institute of Applied Environmental Research, Stockholm University - TemaNord: 528.

8. Barker, V., and G. Garrett. 1992. Boating impacts management plan. Draft Final Report. Monroe Co. Dept. Mar. Res., Key West FL. FI Dept. Nat. Res. Contract #C-7442.
9. Batten, L.A. 1977. Sailing on reservoirs and its effects on water birds. *Biol. Conserv.* 11: 49-58.
10. Bell, M.C. 1974. Fish Passage Through Turbines, Conduits and Spillway Gates in proceedings of the Second Workshop on Entrainment and Intake Screen (EPRI Project rp-49, Report#15).
11. Berg, è., T. Lindberg, and K.G. Kullebrink. 1992. Hatching success of Lapwings on farmland: differences between habitats and colonies of different size. *J. Anim. Ecol.* 62: 469-476.
12. Boyle, S.A., and F. Samson. 1985. Effects of nonconsumptive recreation on wildlife: a review. *Wildlife Soc. Bull.* 13: 110-116.
13. Bratton, S.P. 1990. Boat disturbance of Ciconiiformes in Georgia estuaries. *Colon. Waterbird.* 13: 124-128.
14. Breidenback, A. 1974. Analysis of pollution from marine engines and effects on environment (Summary report). USEPA Grant No. R-801799, Program Element No. 1BB038.
15. Breitburg, D.L. 1988. Effects of turbidity on prey consumption by striped bass larvae. *Trans. Am. Fish. Soc.* 117.
16. Brooks, A.S. 1974. Phytoplankton Entrainment Studies at the Indian River Estuary, Delaware in proceeding of the Second Workshop on Entrainment and Intake Screening (EPRI Project rp-49, Report#15).
17. Burger, J. 1986. The effect of human activity on shorebirds in 2 coastal bays in northeastern United States. *Biol. Conserv.* 13: 123-130.
18. Burns, K., and A. Saliot. 1986. Petroleum hydrocarbons in the Mediterranean Sea: A mass balance. *Mar. Chem.* 20.
19. Cada, G.F. 1977. The Entrainment of Larval Fishes at Tow Nuclear Power Plants on the Missouri River in Nebraska (Doctoral thesis, University of Nebraska, Lincoln).
20. Cada, G.F. 1990. A review of studies relating to the effects of propeller-type turbine passage on fish early life stages. *N. Am. J. Fish. Manage.* 10: p. 418-426.
21. Carpenter, E.J., B. Peck, and S. Anderson. 1974. Survival of copepods passing through a nuclear power station on northeastern Long Island Sound, U.S.A. *Mar. Biol.* 24: p. 49-55.
22. Coutant, C.C., and D. Benson. 1990. Summer habitat suitability for striped bass in Chesapeake Bay: reflections on a population decline. *Trans. Am. Fish. Soc.* 119.

23. Cramer, F.C., and R. Oligher. 1964. Passing fish through hydraulic turbines. *Trans. Am. Fish. Soc.* 93.
24. Dahlgren, R.B., and C.E. Korschgen. 1992. Human disturbance of waterfowl: an annotated bibliography. U.S. Dept. Interior, FWS Resource Public 188: p. 1-62.
25. Development, U.C.f.E.a.E. 1993. Water skiing and the environment: a literature review. Cambridge, UK CEED.
26. English, J., G.N. McDermott, and C. Henderson. 1963. Pollutional effects of outboard motor exhausts — laboratory studies. *J. Water Poll. Cont. Fed.* 35: 923-931.
27. English, J., E. Surber, and G.N. McDermott. 1963. Pollutional effects of outboard motor exhausts-field studies. *J. Water Poll. Cont. Fed.* 35: 1121-1132.
28. EPA. 1994. Draft regulatory impact analysis — Control of air pollution emission standards for new nonroad spark-ignition marine engines. US EPA, Office of Mobile Sources, 2565 Plymouth Rd, Ann Arbor, MI 48105.
29. Fraser, M.W. 1987. Reactions of sea-ducks to windsurfers. *British Birds* 80: 424.
30. Garrad, P.N., and R.D. Hey. 1987. Boat traffic, sediment resuspension and turbidity in a Broadland river. *J. Hydrol.* 95.
31. Garrad, P.N., and R.D. Hey. 1988. River management to reduce turbidity in navigable Broadland rivers. *J. Environ. Manage.* 27: 273-288.
32. Ginn T.C., G.V. Poje, and J.M. O'Connor. 1977. Survival of Planktonic Organisms Following Passage Through a simulated Power Plant Condenser Tube. In proceedings of the Fourth National Workshop on Entrainment and Impingement - Loren D. Jensen, editor.
33. Gregg, R.E., and E.P. Bergersen. 1980. *Mysis relicta*: effects of turbidity and turbulence on short-term survival. *Trans. Am. Fish. Soc.* 119.
34. Gucinski, H. 1982. Sediment suspension and resuspension from small craft induced turbulence. USEPA Contract EPA-78-D-X0426.
35. Hansen, W.G., G. Bitton, J.L. Fox, and P.L. Brezonik. 1977. Hydrocarbon status in Florida real estate canals. *Mar. Pollut. Bull.* 8.
36. Hardy, J., S. Kiesser, L. Antrim, A. Stubin, R. Kocan, and J. Strand. 1987. The sea-surface microlayer of Puget Sound: Part I. Toxic effects on fish eggs and larvae. *Mar. Environ. Res.* 23: 227-250.
37. Hardy, J.T., E.A. Crecelius, L.D. Antrim, U.L. Broadhurst, C.W. Apts, J.M. Gurtesen, and T.J. Foreman. 1987. The sea-surface microlayer of Puget Sound: Part II. Concentrations of contaminants in relation to toxicity. *Mar. Environ. Res.* 23: 251-270.

38. Hardy, J.T. 1987. Anthropogenic Alteration of the Sea Surface. *Marine Environmental Research*, 0141-1136
39. Hare, C.T., and K.J. Springer. 1973. Exhaust emissions from uncontrolled vehicles, part 2: outboard motors. Contract EPA - 7-108, SwRI-AR-850, APTD - 1491.
40. Harper, D.M., and A.J.D. Ferguson, eds. 1994. The ecological basis for river management. John Wiley ISBN 0-471-95151-X: NY.
41. Heinle, D.R. 1976. Effects of Passage Through Power Plant Cooling Systems on Estuarine Copepods. *Environmental Pollution*, 11-39
42. Hershner, C. 1986. Marina Sitings From The Scientific Advisor's Viewpoint Chesapeake Bay Research Conference, Williamsburg, VA (March 20, 21).
43. Holland, I.E., and J.R. Sylevester. 1983. Distribution of larval fishes related to potential navigation impacts on the upper Mississippi River, pool 7. *Trans. Am. Fish. Soc.* 112.
44. Holland, L. 1986. Effects of barge traffic on distribution and survival of ichthyoplankton and small fishes on the upper Mississippi River. *Trans. Am. Fish. Soc.* 115.
45. Jackivicz, T., and L. Kuzminski. 1973. A review of outboard motor effects on the aquatic environment. *J. Water Pollut. Cont. Fed.* 45: 1759 - 1770.
46. Jackivicz, T., and L.N. Kuzminski. 1973. The effects of the Interaction of Outboard Motors with the Aquatic Environment: A Review. *Environmental Research*, 6.
47. Jahn, L.R., and R.A. Hunt. 1964. Duck and coot ecology and management in Wisconsin. Michigan Department of Natural Resources Technical Bulletin 73. 119 pp.
48. Johnson, D.D., and D.J. Wildish. 1982. Effect of suspended sediment on feeding by larval herring (*Clupea harengus harengus* L.). *Bull. Environ. Contam. Toxicol.* 29: 261-267.
49. Johnstone, I.M., B.T. Coffey, and C. Howard-Williams. 1985. The role of recreational boat traffic in interlake dispersal of macrophytes: a New Zealand case study. *J. Environ. Manage.* 20: 263-279.
50. Jury, S.D., J.D. Field, S.L. Stone, D.M. Nelson, and M.E. Monaco. 1994. Distribution and abundance of fishes and invertebrates in North Atlantic estuaries. ELMER Rep. No. 13. NOAA/NOS Strategic Environmental Assessments Div., Silver Spring, MD. 221 pp.
51. Kadel, J.J., and J.F. Gorzelany. 1993. Manatee surveillance during high speed powerboat races. *Florida Scientist* 56: 23.
52. Kahl, R. 1991. Boating disturbance of canvasbacks during migration at Lake Poygan, Wisconsin. *Wildlife Soc. Bull.* 19: 243-248.

53. Killgore, K.A., and K. Conley. 1987. Effects of turbulence on yolk sac larvae of paddlefish. *Trans. Am. Fish. Soc.* 116.
54. King, R.G. 1977. Entrainment of Missouri River Fish Larvae through Fort Calhoun Station, in proceedings of the Fourth National Workshop on Entrainment and Impingement - Loren D. Jensen, editor.
55. Kiorboe, T., F. Mohelenberg, and O. Nohr. 1981. Effect of suspended bottom material on growth and energetics in *Mytilus edulis*. *Mar. Biol.* 61.
56. Knight, R.L. 1984. Responses of wintering bald eagles to boating activity. *J. Wildlife Manage.* 48: 999-1004.
57. Koepff, C., and F. Dietrich. 1986. Disturbance of coastal birds by boats. *Vogelwarte* 33: 232- 248.
58. Kruer, C.R. 1994. Mapping assessment of vessel damage to shallow seagrasses in the Florida Keys. Final Report to Florida Dept. Nat. Res. and U. South Florida Inst. Oceanog. Box 420334, Summerland Key, FL 33042. F.I.O. Contract 47-10-123-L3.
59. Lifton, W.S., and J.F. Storr. 1977. The Effect of Environmental Variables on Fish Impingement in proceedings of the Fourth National Workshop on Entrainment and Impingement - Loren D. Jensen, editor.
60. Liddle, M.J., and H.R.A. Scorgie. 1980. The effects of recreation on freshwater plants and animals: a review. *Biol. Conserv.* 17.
61. Marcy, B.C. 1974. Vulnerability and Survival of Young Connecticut River Fish Entrained at a Nuclear Power Plant, in proceedings of the Second Workshop on Entrainment and Intake Screening (EPRI Project rp-49, Report #15).
62. Marcy, B.C. 1971. Survival of Young Fish In the Discharge Canal of a Nuclear Power Plant. *Journal Fisheries Research Board of Canada*, 28#7: 1057-1060.
63. Mason, C.F., and R. Bryant. 1975. Changes in the Ecology of the Norfolk Broads. *Freshwater Biol.* 5: 257-270.
64. McMahon, P.J.T. 1989. The impact of marinas on water quality. *Water Sci.Tech.* 21.
65. Mikola, J., M. Miettinen, E. Lehikoinen, and K. Lehtila. 1994. The effects of disturbance caused by boating on survival and behaviour of velvet scoter *Melanitta fusca* ducklings. *Biol. Conserv.* 67: p. 119-124.
66. Miller, A.C., K.K. Killgore, and B.S. Payne. 1987. Bibliography of effects of commercial navigation traffic in large waterways. Department of the Army Waterways Experiment Station Misc. Paper E-87-1.
67. Miller, B., and B. Payne. 1991. The Use of Quantitative Data on Freshwater Mussels to Assess the Environmental Impacts of Commercial Navigation Traffic on Waterways

- of the United States. Association Internationale Permanente Des Congress De Navigation, Vol. 73, Bulletin.
68. Milliken, A.S., and V. Lee. 1990. Pollution impacts from recreational boating: a bibliography and summary review. U.S. Dept. Commerce, NOAA Office of Sea Grant, University of R.I., Narragansett, RI. 26 pp.
 69. Morgan, R., R., Ulanowicz, V. Raisin, L. Noe, and G. Gray. 1973. Effects of Water Movement on Eggs and Larvae of Striped Bass and White Perch. Natural Resources Institute, Chesapeake Biological Laboratory, University of Maryland. NRI Ref. #73-111.
 70. Morgan, R., R., Ulanowicz, V. Raisin, L. Noe, and G. Gray. 1976. Effects of shear on eggs and larvae of striped bass and white perch. *Trans. Am. Fish. Soc.* 106.
 71. Morgan, R.P., V.J. Raisin, and L. Noe. 1983. Sediment effects on eggs and larvae of striped bass and white perch. *Trans. Am. Fish. Soc.* 112.
 72. Morgan, E.J., and R.H. Lincoln. 1990. Duty cycle for recreational marine engines. Eng. Soc. Adv. Mobility Land Sea Air and Space, 400 Commonwealth Drive, Warrendale, PA. 15096-0001. Technical Series # 901596.
 73. Moser, F., B. Ruppel, R. Scro, and H. Boettcher. (no date) An Investigation to Two Marinas as Sources of Pollution in Barnegat Bay, N.J. Unpublished report prepared for NJDEP, Division of Science and Research.
 74. Moss, B. 1977. Conservation problems in the Norfolk broads and rivers of East Anglia, England - phytoplankton, boats and the causes of turbidity. *Biol. Conserv.* 12: 95-114.
 75. Muir, J.F. 1959. Passage of Young Fish Through Turbines, *Proceeding of the American Society of Civil Engineers*, 85: 23-46.
 76. Munawar, M., W.P. Norwood, and L.H. Mccarthy. 1991. A method for evaluating the impacts of navigationally induced suspended sediments from the Upper Great Lakes connecting channels on the primary productivity. *Hydrobiologia* 219: 325-332.
 77. Murphy, K., and J.W. Eaton. 1981. Waterplants, boat traffic and angling in canals. *Proceedings of British Freshwater Fisheries* 1981: 173-187.
 78. Murphy, K.J., and J.W. Eaton. 1983. Effects of pleasure-boat traffic on macrophyte growth in canals. *J. Appl. Ecol.* 20: 713-729.
 79. Murphy, K.J., N.J. Willby, and J.W. Eaton. 1994. Ecological impacts and management of boat traffic on navigable inland waterways. Pages 427-442 in D.M. Harper and A.J.D. Ferguson, eds. The ecological basis for river management. John Wiley ISBN 0-471-95151-X, New York, NY.

80. Nelson, D.M., E.A. Irlandi, L.R. Settle, M.E. Monaco, and L.C. Coston-Clements. 1991. Distribution and abundance of fishes and invertebrates in southeast estuaries. ELMER Rep. No. 9. NOAA/NOS Strategic Environmental Assessments Division, Rockville, MD. 177 pp.
81. Newcombe, C.P., and D.D. MacDonald. 1991. Effects of suspended sediments on aquatic ecosystems. *Am. J. Fish. Manage.* 11: 72-81.
82. Nielsen, L.A., R.J. Sheehan and D.J. Orth. 1986. Impacts of Navigation on Riverine Fish Production in United States. *Poldkie Archives Hydrobiologie*, 33: 277-294.
83. O'Connor, J.M., and S.A. Schaffer. 1977. The Effects of Sampling Gear on the Survival of Striped Bass Ichthyoplankton. *Chesapeake Scientist*, 18,3: 312-315.
84. Payne, B.S., K.J. Killgore, and A.C. Miller. 1990. Mortality of Yolk-Sac Larvae of Paddlefish Entrained in High-Velocity Water Currents. *Journal of Mississippi Academy of Science*, vol. 35.
85. Pearce, H.G., and J.W. Eaton. 1983. Effects of recreational boating on freshwater ecosystems — an annotated bibliography. *Inland Waterways Amenity Advisory Council*, London.
86. Pearson, D.K., K. Killgore, B. Payne, and A. Miller. 1989. Environmental Effects of Navigation Traffic: Studies on Fish Eggs and Larvae. Department of the Army Environmental Impact Research Program Technical Report EL- 89 - 15.
87. Pfister, C., M.J. Kasprzyk, and B.A. Harrington. 1994. A relationship between body fat level and survival in migrating Semipalmated Sandpipers (*Calidris pusilla*). *Auk*.
88. Poje, G.V., S.A. Riordan, and J.M. O'Connor. 1981. Power Plant Entrainment Simulation Using a Condenser Tube Simulator. (Final Report), U.S.N.R.C. (Division of Health, Siting and Waste Management). NUREG/CP-2091.
89. Pomerantz, G.A., et al.. 1988. Assessing impact of recreation on wildlife: a classification scheme. *Wildl. Soc. Bull.* 16: 58-62.
90. Rees, J., and J. Tivy. 1977. Recreational impact on lochshore vegetation. *J. Scott. Assoc. Geog. Teach.* 6: 8-24.
91. Sammut, M. and G. Nickless. 1978. Petroleum Hydrocarbons from Marine Sediments and Animals from the island of Malta. *Environmental Pollution*, 16.
92. Schubel, J.R., and B.C. Marcy, Jr. 1978. Power Plant Entrainment: A Biological Assessment. Academic Press.
93. Schuster et al. 1974. Effects of exhausts from Two Cycle Outboard Engines. EPA-670/2-74-063. (Environmental Engineering Dept. at Renssalaer Poly.)
94. Short, F.T., J. Wolf, and G.E. Jones. 1989. Sustaining eelgrass to manage a healthy estuary. *Coastal Zone* 89: 3689-3706.

95. Stewart, R., and H. Howard. 1968. Water pollution by outboard motors. *Conservationist* 6: 6.
96. Stokesbury, K.D.E., and M.J. Dadwell. 1991. Mortality of juvenile clupeids during passage through a tidal, low-head hydroelectric turbine at Annapolis Royal, Nova Scotia. *N. Am. J. Fish. Manage.* 11: 49-154.
97. Stone & Webster Engineering Corporation. 1990. (synopsis). Fish Protection systems for Hydro Plants. EPRI (project RP2694-1).
98. Stone, S.L., T.A. Lowery, J.D. Field, C.D. Williams, D.M. Nelson, S.H. Jury, M.E. Monaco, and L. Andreasen. 1994. Distribution and abundance of fishes and invertebrates in Mid-atlantic estuaries. ELMER Rep. No. 12. NOAA/NOS Strategic Environmental Assessments Division, Silver Spring, MD. 280 pp.
99. Sullivan, C.W. 1990. (synopsis). Turbine Related Fish Mortality: Review and Evaluation of Studies. EPRI (project RP2694-4).
100. Surber, E.W. 1971. The effect of outboard motor exhaust on fish and their environment. *J. Wash. Acad. Sci.*, 61: 120-123.
101. Sutherland, A., and D.G. Ogle. 1975. Effects of jet boats on Salmon eggs. *N. Z. J. Mar. Freshwater Res.* 9: 273-282.
102. Swenson, J.E. 1979. Factors affecting status and reproduction of ospreys in Yellowstone National Park. *J. Wildlife Manage.* 43: 595-601.
103. Taylor, R.E. and B. Kynard. 1985. Mortality of Juvenile American Shad and Blueback Herring Passed through a Low-Head Kaplan Hydroelectric Turbine. *Transactions of the American Fisheries Society*, 114.
104. Tjarnlund, U., G. Ericson, E. Lindesjoo, I. Petterson, and L. Balk. 1995. Investigation of the biological effects of 2-cycle outboard engines' exhaust on fish. *Mar. Environ. Res.* 39: 313-316.
105. USEPA. 1991. Nonroad engine and vehicle emission study - Report (EPA - 21A - 2001). Certification Division, Office of Mobile Sources.
106. Vines, G. 1992. Florida shore bird forced to flee troublesome tourists. *New Sci.* 135: 14.
107. Von Gunten, G. 1961. Fish Passage Through Hydralulic Turbines. *Journal Hydralulics Division, Proceedings American Society of Civil Engineers*, 87 (HY3), 59-72.
108. Von Westernhagen, H., M. Landolt, R. Kocan, G. Furstenberg, D. Janssen, and K. Kremling. 1987. Toxicity of sea surface microlayer: effects on herring and turbot embryos. *Mar. Environ. Res.* 23: 273-290.

109. Wade, T.L., and J.G. Quinn. 1980. Incorporation, distribution and fate of saturated petroleum hydrocarbons in sediments from a controlled marine ecosystem. *Mar. Environ. Res.* 3: 15-33.
110. Yalden, D.W., and P.E. Yalden. 1989. The sensitivity of breeding Golden Plovers *Pluvialis apricaria* to human intruders. *Bird Study* 36: 49-55.
111. Yousef, Y.A. 1974. Assessing effects on water quality by boating activity. U.S.E.P.A., EPA Tech. Serv., EPA-670/2-74-072.
112. Yousef, Y.A., W.M. McClellon, and H. Zebuth. 1980. Changes in phosphorous concentrations due to mixing by motorboats in shallow lakes. *Water Res.* 14: 841-852.

B. Bibliography of various biological, physical, and chemical topics related to the impacts of boating.

Most of these references were contributed by Bradley Barr and Richard Crawford. Copies of many of the papers referred to in this bibliography are on file at the Waquoit Bay National Estuarine Research Reserve, P.O. Box 3092, Waquoit, MA 02536.

-
1. Adair, J. 1987. Assessment of heavy metal contamination in *Crassostrea virginica* from marine facilities. *Northeast Gulf Science* 9: 135-142.
 2. Ahlund, M. and F. Gotmark. 1989. Gull predation on eider ducklings *Somateria mollissima*: effects of human disturbance. *Biol. Cons.* 48: 115-127.
 3. Anon. 1974. A study of the effect of marine sediments on the survival of selected commercially important fish and shellfish of Massachusetts. Raytheon Company Oceanographic and Environmental Services, Portsmouth RI, under contract DMR-73-3 to Division of Mineral Resources Dept. of Natural Resources, Commonwealth of Massachusetts. 44 pp.
 4. Anon. no date. Criteria for the siting of marinas or community facilities for boat mooring. Pages 1-8 in T.A. Barnard, Jr., ed. *The Virginia wetlands management handbook*. Virginia Institute of Marine Science, Virginia Coastal Resources Management Plan, Virginia Marine Resources Commission. VR 450-01-0047.
 5. Anon. 1988. CCA treatment weakens marina piles? *International Marina Institute News*. Vol. 1, No. 1. p. 1-2.
 6. Anon. 1990. Boating impacts in the Florida Keys. An information package by The Wilderness Society, Florida Keys Audubon Society, and Lewis Environmental Services, Inc. 21 pp. (plus appendices).
 7. Arfi, R., D. Guiral and M. Bouvy. 1993. Wind induced resuspension in a shallow tropical lagoon. *Estuarine, Coastal and Shelf Science*. 36: 587-604.
 8. Baldwin, W.J. 1993. Arsenically treated wood and its performance in the aquatic environment. Presented at the Treated Wood in the Aquatic Environment Workshop, July 8, 1993, by Technical and Environmental Services, Hickson, Corp., Conley, GA. 7 pp.
 9. Baldwin, W.J., E.A. Pasek, and P.O. Osborne. 1994. Sediment toxicity study of CCA-C treated marine piles. Presented at the American Wood-Preservers' Assoc. 90th Annual Meeting, May 14-18, 1994, San Antonio, TX. 24 pp.

10. Barker, V., and G. Garrett. 1992. Excerpts from final report: Boating impacts management plan. December 1, 1992 DNR Contract #C-7442. p. 38-41.
11. Barr, B.W. 1993. Environmental impacts of small boat navigation: Vessel/sediment interactions and management implications. Proceedings of the Coastal Zone '93 Conference, New Orleans, Louisiana, 19-23 July, 1993. 15 pp.
12. Bellinger, E. G., and B. R. Benham. 1978. The levels of metals in dock-yard sediments with particular reference to the contributions from ship-bottom paints. Environ. Pollut. 15: 71-81.
13. Berg, L., and T. C. Northcote. 1985. Changes in territorial, gill-flaring, and feeding behavior in juvenile Coho salmon (*Oncorhynchus kisutch*) following short-term pulses of suspended sediment. Can. J. Fish. Aquat. Sci. 42: 1410-1417.
14. Bhowmik, N. G., A. C. Miller, and B. S. Payne. 1990. Techniques for studying the physical effects of commercial navigation on aquatic habitats. Technical report EL-90-10, US Army Engineer Waterways Experiment Station, Vicksburg, MS. 129 pp.
15. Boating Industry Associations. 1975. Analysis of pollution from marine engines and effects on the environment. 1975. Boating Industry Assoc., 401 N. Michigan Ave., Chicago, IL. Contract No. EPA-670/2-75-064.
16. Boehmer, R., A. Westneat, H. Sleight III, and D. Cook. 1975. Effects of suspended marine sediments on selected commercially-valuable fish and shellfish of Massachusetts. Offshore Technology Conference, Dallas, TX. Paper No. OTC 2161. pp. 133-141.
17. Bowerman, F. R., and K. Y. Chen. 1971. Marina Del Ray: a study of environmental variables in a semi-enclosed coastal water. Univ. of Southern California, Sea Grant Program. Sea Grant publication No. USC-SG-4-71. p. 1-59.
18. Bowman, M., and R. Dolan. 1982. The influence of a research pier on beach morphology and the distribution of *Emerita talpoida*. Coast. Eng. 6: 179-194.
19. Breitburg, D. L. 1988. Effects of turbidity on prey consumption by striped bass larvae. Trans. Amer. Fish. Soc. 117: 72-77.
20. Brooks, K.M. 1993. Literature review and assessment of the environmental risks associated with the use of CCA and ACZA treated wood products in aquatic environments. Presented at the Treated Wood in the Aquatic Environment Workshop, July 8, 1993 by Aquatic Environmental Science, 644 Old Eaglemount Rd., Port Townsend, WA. 32 pp.
21. Brooks, K.M. 1994. Assessing and reducing the risks associated with treated wood in aquatic environments. Presented as the Marine and Shallow Water Science and Management in the Mid-Atlantic Region, March 8-11, 1994, Atlantic City. Abstract.

22. Butala, J.H., A.E. Putt, D. Surprenant, E.A. Pasek, and W.J. Balwin. 1994. Sediment bound CCA-C leachate 10-day repeated exposure toxicity study to *Ampelisca abdita* under static conditions. Presented as the Marine and Shallow Water Science and Management in the Mid-Atlantic Region, March 8-11, 1994, Atlantic City. Abstract.
23. Burdick, D.M., F.T. Short, and J. Wolf. 1993. An index to assess and monitor the progression of wasting disease in eelgrass *Zostera marina*. Mar. Ecol. Prog. Ser. 94: 83-90.
24. Carriker, M. R. 1961. Interrelation of functional morphology, behavior, and autecology in early stages of the bivalve *Mercenaria mercenaria*. Journal of the Elisha Mitchell Scientific Society. Vol. 77, Number 2. pp. 224-227. [Dept. of Zoology and Institute of Fisheries Research, Univ. of North Carolina, Morehead City, N. C.]
25. Chamberlain, C. 1979. Guidelines for marina site selection and facility layout. Proceedings of a workshop, "The design of facilities for small craft harbors and marinas.", Boston, MA. 25 pp.
26. Chmura, G. L., and N. W. Ross. 1978. The environmental impacts of marinas and their boats: A literature review with management considerations. URI Sea Grant Marine Advisory Service P-675.
27. Clark, R.C., and J.S. Finley. 1974. Acute effects of outboard motor effluent on two marine shellfish. Environ. Sci. Technol. 8: 1009-1014.
28. Crawford, R., K. Blake, and C. Lamond. 1994. 1992 recreational boating survey: practices and utilization of Waquoit Bay waters. Waquoit Bay National Estuarine Research Reserve Technical Report WBNERR-102. 36 pp.
29. Cutter, S. L., K. F. Nordstrom, and G. A. Kucma. 1979. Social and environmental factors influencing beach site selection. Resource Allocation Issues in the Coastal Environment. Proceedings of Fifth Annual Conference. p. 183.
30. Davis, J. L., and K. D. Wilson. 1975. Analysis of pollution from marine engines and effects on the environment - Southern Lakes. Environmental Science & Engineering, Inc., University Station, Gainesville, FL. Contract No. EPA-670/2-75-063.
31. Delgado, M., V. N. DeJonge, and H. Peletier. 1991. Effect of sand movement on the growth of benthic diatoms. J. Exp. Mar. Biol. Ecol. 145: 221-231.
32. Durako, M. J., M. O. Hall, F. Sargent, and S. Peck. 1993. Propeller scars in seagrass beds: an assessment and experimental study of recolonization in Weedon Island State Preserve, Florida. Florida Marine Research Institute, St. Petersburg, FL. 16 pp.

33. Eldredge, M. E. 1989. The contribution of recreational boats to bacterial water pollution: a model for determining sewage loading rates. National Marina Institute. P-1168. RIU-R-89-016. p. 143-157.
34. Environmental Control Technology Corporation. 1975. Analysis of pollution from marine engines and effects on the environment. Environmental Control Technology Corporation, 3983 Research Park Dr., Ann Arbor, MI. Contract No. EPA-670/2-75-062.
35. Faust, M.A. 1982. Contribution of pleasure boats to fecal bacteria concentrations in the Rhode River estuary, Maryland, U.S.A. *Sci. Total Envir.* 25: 255-262.
36. Ferland, J. G., and R. G. Esterberg. 1989. Mooring plan handbook. Office of Comprehensive Planning, State of Maine Dept. of Economic & Community Development. 40pp.
37. Graham, J. S. 1991. Pressure-treated wood effect on marina environment. p. 302-311. World Marina '91 Proceedings. First International Conference/ASCE, Long Beach, CA. Sept. 4-8, 1991.
38. Gucinski, H. 1978. Sediment suspension and resuspension from small-craft induced turbulence. U.S.E.P.A. Chesapeake Bay Program Report EPA-78-D-X0426. 61 pp.
39. Garrad, P. N., and R. D. Hey. 1987. Boat traffic, sediment resuspension and turbidity in a broadland river. *J. Hydrol.* 95: 289-297.
40. Garrad, P. N., and R. D. Hey. 1988. River management to reduce turbidity in navigable broadland rivers. *J. Environ. Manage.* 27: 273-288.
41. Garrad, P. N., and R. D. Hey. 1988. The effect of boat traffic on river regime. Pages 395-409 in W.R. White, ed. *Proceedings of the International Conference on River Regime*, May 18-20, 1988. John Wiley & Sons, Ltd.
42. Garrad, P. N., and R. D. Hey. 1989. Sources of suspended and deposited sediment in a broadland river. *Earth Surf. Process. Landf.* 14: 41-62.
43. Hart, V. S., C. E. Johnson, and R. D. Letterman. 1992. An analysis of low-level turbidity measurements. *J. Amer. Water Work. Assn.*
44. Henningsson, B., and B. Carlsson. 1984. Leaching of arsenic, copper and chrome from preservative-treated timber in playground equipment. Presented at the 15th Annual Meeting of the International Research Group on Wood Preservation, Stockholm, Sweden 28 May - 1 June, 1984. Working Group III: Preservatives and methods of treatment. 6 pp.
45. Hilton, J., and G. L. Phillips. 1982. The effect of boat activity on turbidity in a shallow broadland river. *J. Applied Ecol.* 19: 143-150.

46. Holland, L. 1987. Effect of brief navigation-related dewaterings on fish eggs and larvae. *North Am. J. Fish. Man.* 7: 145-147.
47. Holland, L. E. 1986. Effects of barge traffic on distribution and survival of ichthyoplankton and small fishes in the Upper Mississippi River. *Trans. Am. Fish. Soc.* 115: 162-165.
48. Horsfall, L., A. Jelinek, and B. V. Timms. 1988. The influence of recreation, mainly power boating, on the ecology of the Thirlmere Lakes, NSW., Australia. *in Part III, Lakes. 5. Australia, New Zealand, Antarctica. Verh. Internat. Verein. Limnol.* 23: 580-587.
49. Huntington, K. M., and D. C. Miller. 1989. Effects of suspended sediment, hypoxia, and hyperoxia on larval *Mercenaria mercenaria* (Linnaeus, 1758). *J. Shellfish Res.* 8: 37-42.
50. Jaakson, R. 1988. River recreation boating impacts. *J. Waterw. Port, Coast. Oc. - ASCE* 114: 363-367.
51. Jackivicz, T.P. Jr., and L.N. Kuzminski. 1973. A review of outboard motor effects on the aquatic environment. *J. Water Pollut. Cont. Fed.* 45: 1759-1770.
52. Johnston, D. D., and D. J. Wildish. 1982. Effect of suspended sediment on feeding by larval herring (*Clupea harengus harengus* L.) *Bull. Environm. Contam. Toxicol.* 29: 261-267.
53. Kaiser, M.S., and E. K. Fritzel. 1984. Effects of river recreationists on green-backed heron behavior. *J. Wild. Manage.* 48: 561-568.
54. Kearney, V. F., Y. Segal, and M. W. Lefor. 1978. Effects of docks on salt marsh vegetation. Botany Section, U-42, Biological Sciences Group, The University of Connecticut, Storrs, Conn. 06268. Unpublished student manuscript. 31 pp.
55. Keck, R., D. Maurer, and R. Malouf. 1974. Factors influencing the setting behavior of larval hard clams, *Mercenaria mercenaria*. *Proc. Nat. Shell. Ass.* 64: 59-67.
56. Kiorboe, T., F. Mohlenberg, and O. Nohr. 1981. Effect of suspended bottom material on growth and energetics in *Mytilus edulis*. 1981. *Mar. Biol.* 61: 283-288.
57. Kiorboe, T., E. Frantsen, C. Jensen, and G. Sorensen. 1981. Effects of suspended sediment on development and hatching of herring (*Clupea harengus*) eggs. *Estuar. Coast. Shelf Sci.* 13: 107- 111
58. Kuzminski, L. N., and T. P. Jackivicz. 1972. Interaction of outboard motors with the aquatic environment -- Causative factors and effects. Part 1: Causative factors concerning the interaction of outboard motors with the aquatic environment -- A review. Part 2: The effects of the interaction of outboard motors with the aquatic

- environment -- A review. Environmental Engineering Dept. of Civil Engineering, University of Massachusetts, Amherst, MA. Report No. EVE 29-72. 77 pp.
59. Lagler, K. F., A. S. Hazzard, W. E. Hazen, and W. A. Tompkins. 1949. Outboard motors in relation to fish behavior, fish production, and angling success. Fifteenth North American Wildlife Conference - Outboard Boating. July-August 1949. Vol. 4, No. 4: 280-303.
 60. Liddle, M. J., and H. R. A. Scorgie. 1980. The effects of recreation on freshwater plants and animals: a review. *Biol. Conserv.* 17: 183-206.
 61. Lockwood, J.C. 1990. Seagrass as a consideration in the site selection and construction of marinas. Environmental Management for Marinas Conference, September 5-7, Washington, D.C. Technical Reprint Series, International Marina Institute, Wickford, Rhode Island. 11 pp.
 62. Lockwood, J. C. 1991. Shellfish Survey Guidelines. National Marine Fisheries Service, Sandy Hook Laboratory, Highlands, NJ.
 63. Mantoura, R.F.C., P.M. Gschwend, O.C. Zafriou, and K.R. Clarke. 1982. Volatile organic compounds at a coastal site. 2. Short-term variations. *Environ. Sci. Technol.* 16: 38-45.
 64. Marcus, J. M., and T. P. Stokes. 1985. Polynuclear aromatic hydrocarbons in oyster tissue around three coastal marinas. *Bull. Environ. Contam. Toxicol.* 35: 835-844.
 65. Marcus, J. M., and A. M. Thompson. 1986. Heavy metals in oyster tissue around three coastal marinas. *Bull. Environ. Contam. Toxicol.* 36: 587-594.
 66. Matthews, W. 1984. Influence of turbid inflows on vertical distribution of larval shad and freshwater drum. *Trans. Am. Fish Soc.* 113: 192-198.
 67. Meador, J. P., C. A. Krone, D. W. Dyer, and U. Varanasi. 1997. Toxicity of sediment-associated tributyltin to infaunal invertebrates: Species comparison and the role of organic carbon. *Mar. Environ. Res.* 43: 219-241.
 68. Miller, A. C., and B. S. Payne. 1992. Use of field techniques to assess the environmental effects of commercial navigation traffic. Technical Report EL-92-12. Vicksburg, MS: US Army Engineer Waterways Experiment Station.
 69. Milliken, A. S., and V. Lee. 1990. Pollution impacts from recreational boating: A bibliography and summary review. Rhode Island Sea Grant. P 1134. RIU-G-90-002. 26 pp.
 70. Morgan, R. P. II, R. E. Ulanowicz, V. J. Rasin Jr., L. A. Noe, and G. B. Gray. 1976. Effects of shear on eggs and larvae of striped bass, (*Morone saxatilis*), and white perch, (*M. americana*). *Trans. Am. Fish. Soc.*, 1: 149-154.

71. Morrell, J. J., G. G. Helsing, and R. D. Graham. 1984. Marine wood maintenance manual: a guide for proper use of douglas-fir in marine exposures. Forest Research Lab. College of Forestry and Sea Grant College Program, Oregon State Univ. Research Bulletin No. 48. 63 pp.
72. Moss, B. 1977. Conservation problems in the Norfolk broads and rivers of East Anglia, England -- Phytoplankton, boats and the causes of turbidity. *Biol. Conserv.* 12: 95-114.
73. Muehlstein, L.K., D. Porter, and F.T. Short. 1988. *Labyrinthula* sp., a marine slime mold producing symptoms of wasting disease in eelgrass, *Zostera marina*. *Mar. Biol.* 99: 465-472.
74. Muehlstein, L.K., D. Porter, and F.T. Short. 1991. *Labyrinthula zosterae* sp. Nov., the causative agent of wasting disease of eelgrass, *Zostera marina*. *Mycologia* 83: 180-191.
75. Mueller, G. 1980. Effects of recreational river traffic on nest defense by longear sunfish. *Trans. Am. Fish. Soc.* 109: 248-251.
76. Mulvihill, E. L., C. A. Francisco, J. B. Glad, K. B. Kaster, R. E. Wilson, and O. R. Portland, with O. Beeman - Special Consultant. 1980. Biological impacts of minor shoreline structures on the coastal environment: state of the art review. US Fish & Wildlife Service Biological Services Program. FWS/OBS-77/51. 2 Vol.
77. Murphy, K. J., and J. W. Eaton. 1983. Effects of pleasure-boat traffic on macrophyte growth in canals. *J. App. Ecol.* 20: 713-729.
78. Myers, E. P., and E. T. Harding. 1983. Ocean disposal of municipal wastewater: impacts on the coastal environment. Sea Grant College Program, Massachusetts Institute of Technology, Cambridge, MA. Vol. 1. p. 484-487.
79. Neff, J.F. 1985. Polyaromatic hydrocarbons. Pages 416-454. In G.M. Rand and S.R. Petrocelli, eds. Fundamentals of Aquatic Toxicology. Washington, D.C. Hemisphere.
80. Nielsen, L. A., R. J. Sheehan, and D. Orth. 1986. Impacts of navigation on riverine fish production in the United States. Dept. Fisheries & Wildlife Sciences, VA. *Poldkie Archives Hydrobiologie* 33: 277-294.
81. Nimmo, D. R., T. L. Hamaker, E. Matthews, and W. T. Young. 1982. The long-term effects of suspended particulates on survival and reproduction of the mysid shrimp, *Mysidopsis bahia*, in the laboratory. Pages 413-422 in Ecological Stress and the New York Bight: Science and Management. Estuarine Research Federation, Columbia, SC.

82. Nixon, S.W., C.A. Oviatt and S.L. Northby. 1973. Ecology of small boat marinas. Marine Technical Report Series No. 5, University of Rhode Island, Kingston. 20 pp.
83. Nowell, A. R. M., P. A. Jumars, and J. E. Eckman. 1981. Effects of biological activity on the entrainment of marine sediments. *Mar. Geol.* 42: 133-153.
84. O'Connor, J.M., D.A. Neuman, and J.A. Sherk, Jr. 1976. Lethal effects of suspended sediments on estuarine fish. Fort Belvoir, VA, U.S. Coastal Engineering Research Center, Technical Paper 76-20. 26 pp.
85. Orth, R. J. 1977. The importance of sediment stability in seagrass communities. Virginia Institute of Marine Science, Gloucester Point, VA. Contribution No. 710. 20 pp.
86. Orth, R.J., and K.M. Moore. 1983. Chesapeake Bay: An unprecedented decline in submerged aquatic vegetation. *Science* 22: 51-53.
87. Palmer, H. D. 1976. Sedimentation and ocean engineering: structures. Marine sediment transport and environmental management. Wiley-Interscience. p. 519-534.
88. Payne, B.S., K.J. Killgore and A.C. Miller. 1990. Mortality of yolk-sac larvae of paddlefish entrained in high-velocity water currents. *Journal of Mississippi Academy of Sciences*, Vol. 35.
89. Pomeroy, W. M., and J. G. Stockner. 1976. Effects of environmental disturbance on the distribution and primary production of benthic algae in a British Columbia estuary. *J. Fish Res. Board Can.* 33: 1175-1187.
90. Prescott, R. C. 1990. Sources of predatory mortality in the bay scallop *Argopectin irradians* (Lamarck): interactions with seagrass and epibiotic coverage. *J. Exp. Mar. Biol. Ecol.* 144: 63-83.
91. Rhoads, D. C., K. Tenore, and M. Browne. 1975. The role of resuspended bottom mud in nutrient cycles of shallow embayments. *Estuarine Research*: 563-579.
92. Rhoads, D.C. 1973. The influence of deposit-feeding benthos on water turbidity and nutrient recycling. *Am. Jour. Sci.* 273: 1-22.
93. Rhoads, D.C., and D.K. Young. 1970. The influence of deposit-feeding organisms on sediment stability and community trophic structure. *Jour. Mar. Res.* 28: 150-178.
94. Rhoads, D. C., L. F. Boyer, B. L. Welsh, and G. R. Hampson. 1984. Seasonal dynamics of detritus in the benthic turbidity zone (BTZ): implications for bottom-rack molluscan mariculture. *Bull. Mar. Sci.* 35: 536-549.
95. Ross, N. W. 1985. Towards a balanced perspective ... boat sewage. Presented at Docks and Marinas, 12th National Technical Conference, October 7-11, 1985, Madison, Wisconsin. Sea Grant Document RIU-R-85-007.

96. Roy Mann Associates, Inc. 1976. Management planning study: recreational boating on the tidal waters of Maryland. Energy and Coastal Zone Admin., Dept. of Natural Resources, State of Maryland. 214 pp.
97. Saila, S.B. 1980. Estuarine fishery resources and physical estuarine modifications: some suggestions for impact assessment. Pages 603-629 in P. Hamilton and K.B. MacDonald, eds. Estuarine and Wetland Processes. Plenum Publishing Corp., New York, N.Y.
98. Saveland, R.N. 1979. Environmental and management problems associated with recreational boating on the Atlantic Intracoastal Waterway. in Proceedings of the 5th Annual Conference in Resource Allocation Issues in the Coastal Environment. Nov. 6-8, Newport, RI. p. 175-182. [Published by the Coastal Society.]
99. Servizi, J. A., and D. W. Martens. 1992. Sublethal responses of Coho salmon (*Oncorhynchus kisutch*) to suspended sediments. Can. J. Fish. Aquat. Sci. 49: 1389-1395.
100. Shaffer, G. P. 1984. The effect of sedimentation on the primary production of benthic microflora. Estuaries 7: 497-500.
101. Shanks, L. R. Small coastal structures - A review. US Fish & Wildlife Service Office of Biological Services, National Coastal Ecosystems Team, National Space Technologies Laboratories, NSTL Station, MS.
102. Short, F. T. 1987. Effects of sediment nutrients on seagrasses: Literature review and mesocosm experiments. Aquat. Bot. 27: 41-57.
103. Short, F.T., B.W. Ibelings, and C. den Hartog. 1988. Comparison of a current eelgrass disease to the wasting disease of the 1930's. Aquat. Bot. 30: 295-304.
104. Short, F.T., J. Wolf, and G.E. Jones. 1989. Sustaining eelgrass to manage a healthy estuary. Proceedings of Sixth Symposium on Coastal and Ocean Management/ASCE, July 11-14, 1989, Charlestown, SC. p. 3689-3706. American Society of Civil Engineers, New York.
105. Short, F.T., W.C. Dennison, and D.G. Capone. 1990. Phosphorus limited growth in the tropical seagrass *Syringodium filiforme* in carbonate sediments. Mar. Ecol. Prog. Ser. 62: 169-174.
106. Short, F.T., G.E. Jones, and D.M. Burdick. 1991. Seagrass decline: problems and solutions. Pages 439-453 in H.S. Bolton, ed. Coastal wetlands. Coastal Zone '91 Conference-ASCE, Long Beach, CA. American Society of Civil Engineers, New York.

107. Short, F.T., ed. 1992. The ecology of the Great Bay Estuary, New Hampshire and Maine: An estuarine profile and bibliography. NOAA - Coastal Ocean Program Publ. 222 p.
108. Short, F.T., J. Montgomery, C.F. Zimmermann, and C.A. Short. 1993. Production and nutrient dynamics of a *Syringodium filiforme* Kutz seagrass bed in Indian River Lagoon, FL, USA. *Estuaries* 16: 323-334.
109. Short, F.T., D. Porter, H. Iizumi, and K Aioi. 1993. Occurrence of the eelgrass pathogen, *Labyrinthula zosterae*, in Japan. *Disease. Aquat. Org.* 16: 73-77.
110. Short, F.T., D.M. Burdick, and J.E. Kaldy. 1995. Mesocosms experiments quantify the effects of eutrophication on eelgrass, *Zostera marina* L. *Limnol. Ocean.* 40: 740-749.
111. Short, F.T., D.M. Burdick, S. Granger, and S.W. Nixon. 1996. Long-term decline in eelgrass, *Zostera marina* L., linked to increased housing development. Pages 291-298 in J. Kuo, R.C. Phillips, D.I. Walker, and H. Kirkman, eds. *Seagrass Biology: Proceedings of an international workshop, Rottneest Island, Western Australia, 25-29 January 1996.* Nedlands, Western Australia: Sciences UWA.
112. Short, F.T., and D.M. Burdick. 1996. Quantifying eelgrass habitat loss in relation to housing development and nitrogen loading in Waquoit Bay, Massachusetts. *Estuaries* 19: 730-739.
113. Short, F.T., and S. Wyllie-Echeverria. 1996. Natural and human-induced disturbance of seagrasses. *Environ. Conserv.* 23: 17-27.
114. Short, F. T., G. E. Jones, and D. M. Burdick. 1991. Seagrass decline: Problems and solutions. *Coastal Wetlands, Coastal Zone '91 Conference-ASCE, Long Beach, CA.* July 1991. p. 439-453.
115. Short, F. T., D. M. Burdick, J. Wolf, and G. E. Jones. 1993. Eelgrass in estuarine research reserves along the East coast, U.S.A. Part I: Declines from pollution and disease, and Part II: Management of eelgrass meadows. NOAA - Coastal Ocean Program Publ. 107 pp.
116. Short, F. T., J. Wolff, and G. Jones. 1989. Sustaining eelgrass to manage a healthy estuary. *Coastal and Ocean Management/ASCE, July 11-14, 1989.* p. 3689-3706.
117. Smart, M.M., R.G. Rada, D.N. Nielsen, and T. O. Claflin. 1985. The effect of commercial and recreational traffic on the resuspension of sediment in Navigation Pool 9 of the Upper Mississippi River. *Hydrobiologia* 126: 263-274.
118. Stolpe, N. E. 1992. A survey of potential impacts of boating activity on estuary productivity. Unpublished manuscript. Presented at Marine Engines and Vessels Public Workshop, Ann Arbor, Michigan, July 29, 1992.

119. Swenson, W. A., and M. L. Matson. 1976. Influence of turbidity on survival, growth, and distribution of larval lake herring (*Coregonus artedii*). *Trans. Am. Fish. Soc.* 4: 541-545.
120. Thayer, G. W., and M. S. Fonseca. 1984. The ecology of eelgrass meadows of the Atlantic coast: a community profile. FWS/OBS-84-02. 147 pp.
121. Turner, S. J., S. F. Thrush, V. J. Cummings, J. E. Hewitt, M. R. Wilkinson, R. B. Williamson, and D. J. Lee. 1997. Changes in epifaunal assemblages in response to marina operations and boating activities. *Mar. Environ. Res.* 43: 181-200.
122. VanDolah, R. F., P. H. Wendt, and J. J. Manzi. 1992. Effects of marina proximity on the physiological condition, reproduction, and settlement of oyster populations. *J. Shell. Res.* 11: 41-48.
123. Voudrias, E. A., and C. L. Smith. 1986. Hydrocarbon pollution from marinas in estuarine sediments. *Estuar. Coast. Shelf Sci.* 22: 271-274.
124. Walker, D. I., R. J. Lukatelich, G. Bastyan, and A. J. McComb. 1989. Effect of boat moorings on seagrass beds near Perth, Western Australia. *Aquat. Bot.* 36: 69-77.
125. Way, C. M., A. C. Miller, B. S. Payne, and J. Wakeley. 1990. Traffic: An information retrieval system to evaluate the environmental impacts of commercial navigation traffic. USACE Environmental Impact Research Program Tech. Rep. EL-90-13. 17 pp. plus appendices.
126. Weis, J.S., and P. Weis. 1987. Pollutants as developmental toxicants in aquatic organisms. *Environ. Health Persp.* 71: 77-86.
127. Weis, J.S., and P. Weis. 1992. Transfer of contaminants from CDCA-treated lumber to aquatic biota. *J. Exper. Mar. Ecol.* 161: 189-199.
128. Weis, J.S., and P. Weis. 1992. Construction materials in the marine environment: reduction in the epibiotic community on chromated copper arsenate (CCA) treated wood. *Mar. Ecol. Prog. Ser.* 83: 45-53.
129. Weis, P., J.S. Weis, and L. Coohill. 1991. Toxicity to estuarine organisms of leachates from chromated copper arsenate treated wood. *Arch. Environ. Contam. Toxicol.* 20: 118-124.
130. Weis, P., J. S. Weis, A. Greenberg, and T. Nosker. 1992. Toxicity of construction materials in the marine environment: a comparison of chromated-copper-arsenate treated wood and re-cycled plastic. *Arch. Environ. Contam. Toxicol.* 22: 99-106.
131. Weis, P., J. S. Weis, A. Greenberg, and T. Nosker. 1993. Copper, chromium and arsenic in estuarine sediments adjacent to wood treated with chromated-copper-arsenate. *Estuar. Coast. Shelf Sci.* 36: 71-79.

132. Weis, J.S., and P. Weis. 1993. Trophic transfer of contaminants from organisms living by chromated-copper-arsenate (CCA)-treated wood to their predators. *J. Exp. Mar. Biol. Ecol.* 168: 25-34.
133. Weis, J.S., and P. Weis. 1994. Effects of contaminants from chromated copper arsenate-treated lumber on benthos. *Arch. Environ. Contam. Toxicol.* 26: 103-109.
134. Wendt, P.H., R.F. Van Dolah, M.Y. Bobo, T.D. Mathews, and M.V. Levinsen. 1993. A study of wood preservative leachates from docks in an estuarine environment. Marine Resources Div., South Carolina Dept. Nat. Resources CHP Task Number 93 - 1.17. 52 pp.
135. Williams, S. L. 1988. *Thalassia testudinum* productivity and grazing by green turtles in a highly disturbed seagrass bed. *Mar. Biol.* 98: 447-455.
136. Wilson, K. 1989. Handbook for the location, design, construction, operation, and maintenance of boat launching facilities. States organization for boating access, Washington, D.C. 81 pp.
137. Woolson, E. A., and L. R. Gjovik. 1981. The valence state of arsenic on treated wood. Presented at the Annual Meeting of the American Wood-preservers Association, Kissimmee, Florida, April 27-29, 1981. 5 pp.
138. Word, J. Q., J. T. Hardy, E. A. Crecelius, and S. L. Kiesser. 1987. A laboratory study of the accumulation and toxicity of contaminants at the sea surface from sediments proposed for dredging. *Mar. Environ. Res.* 23: 325-338.
139. Wright, D.O., and K. J. Wagner. 1991. Power boats on shallow lakes: A brief summary of literature and experience on Lake Michigan (NY). *Lakeline* 11: 8-12.
140. Wright, L.D., G.C. Greene, J.P.-Y. Maa, and S. Siddiqi. 1992. Passive artificial ventilation of hypoxic estuarine benthic environments: a feasibility study. *J. Coast. Res.* 8: 134-152.
141. Young, D.R., G.V. Alexander, and D. McDermott-Ehrlich. 1979. Vessel-related contamination of southern California harbours by copper and other metals. *Mar. Pollut. Bull.* 10:50-56.
142. Yousef, Y. A., W. M. McLellon, R. H. Fagan, H. H. Zebuth, and C. R. Larrabee. 1978. Mixing effects due to boating activities in shallow lakes. Civil Engineering and Environmental Sciences Dept., Florida Technological University, Environmental Systems Engineering Institute Tech. Rept. ESEI No. 78-10. 352 pp.
143. Yousef, Y. A., W. M. McLellon, and H. H. Zebuth. 1980. Changes in phosphorus concentrations due to mixing by motorboats in shallow lakes. *Water Res.* 14: 841-852.

144. Yousef, Y. A. 1974. Assessing effects on water quality by boating activity. U.S. Environmental Protection Agency National Environmental Research Center, Report EPA-670/2-74-072. 59 pp.
145. Zabawa, C., C. Ostrom, R. J. Byrne, J. D. Boon III, R. Waller, and D. Blades. 1980. Final report on the role of boat wakes in shore erosion in Anne Arundel County, Maryland. Tidewater Administration, Maryland Dept. of Natural Resources. 12/1/80. 238 pp.
146. Zajac, R.N. 1985. The effects of disturbance on temporal and spatial variation in estuarine species richness: does it promote coexistence. *Estuaries* 8: abstract #219.
147. Zieman, J. C. 1976. The ecological effects of physical damage from motor boats on turtle grass beds in southern Florida. *Aquat. Bot.* 2: 127-139.

C. Bibliography: Topics Related to Dredging

Most of these references were contributed by B. Barr.

-
1. Ackefors, H., and S. H. Fonseca. 1969. Preliminary investigations on the effect of sand suction work on the bottom in Oresund. ICES C.M. 1969/E:13, Fisheries Improvement Committee.
 2. Anon. 1987. 21st Annual Directory of Working Dredge Fleets. *World Dredging and Marine Construction* 23: 58-71.
 3. Barnard, J.L., and D. H. Reish. 1959. Ecology of amphipoda-polychaeta of Newport Bay, California. Allen Hancock Foundation Occasional Paper NO. 21.
 4. Bohlen, W. F., D. F. Cundy, and J. M. Tramonitano. 1979. Suspended material distributions in the wake of estuarine channel dredging operations. *Est. Coast. Mar. Sci.* 9: 699-711.
 5. Buoma, A. H., ed. 1976. Shell dredging and its influence on Gulf Coast environments. Gulf Publishing Company, Houston, Texas.
 6. Boyd, M. B., R. T. Saucier, J. W. Keeley, R. L. Montgomery, R. D. Brown, D. B. Mathis, and C. J. Guice. 1972. Disposal of dredge spoil: identification and assessment, and research program development. U. S. Army Engineer Waterways Experiment Station, Vicksburg, MS. Tech. Rep. H-72-8.
 7. Brannon, J. M., I. Smith, J. R. Rose, R. M. Engler, and P. G. Hunt. 1976. Investigation of partitioning of various elements in dredged material. U.S. Army Engineer Waterways Experiment Station, Vicksburg, MS. Tech. Rep. D-76-7.
 8. Brannon, J. M., R. E. Hoeppe, T. C. Sturgis, I. Smith Jr., and D. Gunnison. 1985. Effectiveness of capping in isolating contaminated dredged material from biota and the overlying water. U. S. Army Engineer Waterways Experiment Station, Vicksburg, MS. Tech. Rep. D-85-10.
 9. Brannon, J. M., R. E. Hoeppe, T. C. Sturgis, I. Smith Jr., and D. Gunnison. 1986. Effectiveness of capping a Dutch Kills sediment from biota and overlying waters. U.S. Army Engineer Waterways Experiment Station, Vicksburg, MS. Misc. Paper D-86-2.
 10. Bray, R.N. 1979. *Dredging: a handbook for engineers*. Edward Arnold, Ltd., London, 276 pp.
 11. Brown, C. L., and R. Clark. 1986. Observations on dredging and dissolved oxygen in a tidal waterway. *Water Resour. Res.* 4: 1381-1384.

12. Chesapeake Biological Laboratory. 1970. Gross physical and biological effects of overboard spoil disposal in the upper Chesapeake Bay. University of Maryland, Solomons, MD. NRI Special Report No. 3.
13. Cobb, D. A. 1972. Effects of suspended solids on larval survival of the eastern lobster. *Mar. Technol. Soc. J.* p. 40.
14. Collinson, R. I., and C. P. Rees. 1978. Mussel mortality in the Gulf of La Spezia, Italy. *Mar. Poll. Bull.* 9: 99-101.
15. Conner, W. G., and J. A. Simon. 1979. The effects of oyster shell dredging on an estuarine benthic community. *Est. Coast. Mar. Sci.* 9: 749-758.
16. Conner, W. G., D. Avrano, M. Leslie, J. Slaughter, A. Amr, and F.I. Ravenscroft. 1979. Disposal of dredged material within the New York District: Vol. 1, Present practices and candidate alternatives. Mitre Technical Report MTR-7808.
17. Davis, H. C. 1960. Effects of turbidity producing materials in seawater on eggs and larvae of the clam *Venus (Mercenaria) mercenaria*. *Biol. Bull.* 118: 48-54.
18. deGroot, S.J. 1979. An assessment of the potential environmental impact of large-scale sand dredging for the building of artificial islands in the North Sea. *Ocean Mgmt.* 5: 211-232.
19. Department of Environmental Quality Engineering. 1978. A Guide to the Coastal Wetlands Regulations. DEQE/MCZM publication, pp. 56-67.
20. Environmental Protection Agency. 1976. Impacts of construction activities in wetlands of the United States. EPA/600/3-76-045.
21. Environmental Protection Agency/Corps of Engineers. 1977. Ecological evaluation of proposed discharge of dredged material into ocean waters. U.S. Army Engineer Waterways Experiment Station/EPA publication.
22. Everhardt, W.H., and R.M. Duchrow. 1967. Effects of suspended sediments on aquatic environments. NTIS, U.S. Department of Commerce. P. B. p. 196-641.
23. Florida Coastal Coordinating Council. 1973. Recommendations for development activities in Florida's coastal zone. Florida Dept. of Nat. Resources publication. 20 pp.
24. Folk, R.L. 1974. Petrology of Sedimentary Rocks. Hemphill Publishing Co., Texas. 192 pp.
25. Francinques, N.R., Jr., M.R. Palermo, C.R. Lee, and R.K. Peddicord. 1985. Management strategy for disposal of dredged material: Contaminant testing and controls. U.S. Army Engineer Waterways Experiment Station, Vicksburg, MS. Misc. Paper D-85-1

26. Frankenberg, D., and C.W. Westerfield. 1968. Oxygen demand and oxygen depletion capacity of sediments from Wassau Sound, GA. *Bull. Georgia Acad. Sci.* 26: 342-355.
27. Gerges, M.A., and D.J. Stanley. 1985. Assessing hydrography and man's influence on sediments in the northern Suez Canal. *Mar. Geol.* 65: 325-331.
28. Godcharles, M.F. 1971. A study of the effects of a commercial hydraulic clam dredge on benthic communities in estuarine areas. Fla. Dept. Nat. Resources, Nat. Res. Lab., Tech, Ser. No. 64.
29. Green, R.H. 1979. Sampling design and statistical methods for environmental biologists. John Wiley and Son, New York. 257 pp.
30. Grumman Ecosystems, Inc. 1975. Oceanographic studies to assess the environmental implications of offshore siting of energy generating facilities - New York Field Studies: 1973-1974. New York State Energy Research and Development Authority, New York, New York.
31. Hafferty, A.J., S.P. Pavlou, and W. Hom. 1977. Release of polychlorinated biphenyls (PCB) in a saltwedge estuary as induced by dredging of contaminated sediments. *Sci. Total Envir.* 8: 229-239.
32. Hamilton, C. 1985. New York State Department of Environmental Conservation perspective on dredging in New York's tidal wetlands. Pages 57-59 in *Proceedings of Dredging Workshop, Pt. Lookout, New York. September 10-11, 1985.* New York Coastal Management Program.
33. Hayes, M. O. 1978. Impact of hurricanes on sedimentation in estuaries, bays and lagoons. Pages 323-346 in M. L. Wiley, ed. Estuarine interactions. Academic Press, New York.
34. Herbich, J. B., and S.B. Brahme. 1983. Literature review and technical evaluation of sediment resuspension during dredging. Texas A&M Center for Dredging Studies Report No. COE-266.
35. Hopkins, T.S. 1972. The effects of physical alteration on water quality in Mullato Bayou, Escambia Bay. *Q. Jl. Florida Acad. Sci.* 35: 2 (abstract).
36. Huet, M. 1965. Water quality criteria for fish life. Pages 160-167 in C. Tarzwell, ed. *Biological Problems in Water Pollution*, U.S. Public Health Service publication 999-WP-25.
37. Ingle, R.M. 1952. Studies of the effects of dredging operations upon fish and shellfish. Florida Board of Conservation Technical Report No. 5.

38. Ingle, R.M., A.R. Ceurvels, and R. Leinecker. 1955. Chemical and biological studies of the muds of Mobile Bay. Pages 1-14 in Report to the division of seafood's, Alabama Department of Conservation. University of Miami Contrib. No. 139.
39. Jeane, G.S., and C. J. Pine 1975. Environmental effects of dredging and spoil disposal. *J. Water Pollut. Cont. Fed.* 47: 553-561.
40. Johnson, R.G. 1973. Conceptual models of benthic communities. Pages 148-159 in T.J.M. Schopf, ed. Models in Paleobiology. Freeman, Cooper and Co., San Francisco, CA. 250 pp.
41. Johnston, S.A., Jr. 1981. Estuarine dredge and fill activities: a review of impacts. *Env. Mgmt.* 5: 427-440.
42. Jones, G. 1981. Effects of dredging and reclamation on the sediments of Botany Bay. *Aust. J. Mar. Freshwater Res.*
43. Jones, G. and S. Candy. 1981. Effects of dredging on the macrobenthic infauna of Botany Bay. *Aust. J. Mar. Freshwater Res.* 32: 379-398.
44. Kaplan, E.H., R.R. Walker, M.G. Kraus and S. McCourt. 1975. Some factors affecting the colonization of a dredged channel. *Mar. Biol.* 32: 193-204.
45. Keeley, J. W., and R.M. Engler. 1974. Discussion of regulatory criteria for ocean disposal of dredged materials: elutriate test and rationale, and implementation guidelines. U.S. Army Engineer Waterways Experiment Station, Vicksburg, MS. Misc. Paper D-74-14.
46. Kioboe, T., F. Mohlenberg, and O. Nohr. 1981. Effect of suspended bottom material on growth and energetics in *Mytilus edulis*. *Mar. Biol.* 61: 283-288.
47. Krenkel, P.A., J. Harrison, and J.C. Burdick, III, eds. No date. Dredging and its environmental effects. Proceedings of a specialty conference, ASCE, New York.
48. Krizek, R.J., G.M. Kaladi, and P.L. Hummel. 1973. Engineering characteristics of polluted dredging. U.S. EPA Grants 15070 GCK and R-800948, Northwestern University, Evanston, IL. Tech. Rept. No. 1. 335 pp.
49. LaRoe, E.T. 1977. Dredging-ecological impacts. Pages 610-613 in J.R. Clarke, ed. Coastal ecosystem management. John Wiley and Son, New York. 928 pp.
50. LaSalle, M.W. 1985. Seasonal restrictions on dredging and disposal options. Environmental Effects on Dredging, Tech. Rept. (working draft), U.S. Army Engineer Waterways Experiment Station, Vicksburg, MS.
51. Lee, C.F., and R. H. Plumb. 1973. Literature review for research study for the development of dredged material disposal criteria. Institute for Environments Studies., University of Texas, Dallas. DMRP Rept. D-74-1.

52. Livingston, R.J. 1982. Long-term variability in coastal systems: background noise and environmental stress. Pages 605-621 in G. F. Mayer, ed. Ecological stress and the New York Bight: science and management. Estuarine Research Federation, Columbia, SC.
53. Loosanoff, V.L. 1961. Effects of turbidity on some larval and adult bivalves. Proc. Gulf and Carib. Fish. Inst. 14: 80-95.
54. Lunz, G.R., Jr. 1938. Oyster culture with reference to dredging operations in South Carolina (Part 1) and the effects of flooding of the Santee River in April 1936 on oysters in the Cape Romain area of South Carolina (Part 2). U.S. Army Engineers, South Carolina District. 135 pp.
55. Lunz, G.R., Jr. 1942. Investigation of the effects of dredging on oyster leases in Duvall Co., Florida. (No pages) in Handbook of Oyster Survey, Intercoastal Waterway from Charleston Sound to St. John River. Special Rept. U.S. Army Corps of Engineers, Jacksonville, FL.
56. Lunz, J.D. 1985. Physicochemical alteration of the environment associated with hydraulic cutterhead dredging. (No pages) in Proceedings of Workshop on Entrainment of Larval Oysters During Hydraulic Cutterhead Dredging Operations. College of Marine Studies, University of Delaware, Lewes, DE. for Baltimore District, U.S. Army Corps of Engineers and USACE Waterways Experiment Station.
57. Lunz, J.D., and D.C. Clarke. 1985. Effects of disposal of fine grained sediments on benthos: a point of view. Pages 21-26 in Proceedings of the dredging workshop, Point Lookout, New York, September 10-11, 1985. New York Coastal Management Program.
58. Lunz, J.D., R.J. Diaz, and R.A. Cole. 1978a. Upland and wetland habitat development with dredged material: ecological considerations, synthesis of results. DMRP Tech. Rept. DS-78-15, Environmental Effects Laboratory, U.S. Army Engineer Waterways Experiment Station, Vicksburg, MS.
59. Lunz, J.D., T.W. Ziegler, R.T. Hoffman, R.J. Diaz, E.J. Clairain, and L.J. Hunt. 1978b. Habitat Development field investigations, Windmill Point marsh development site, James River, Virginia. DMRP Tech. Rept. D-77-23, Environmental Effects Laboratory, U.S. Army Engineer Waterways Experiment Station, Vicksburg, MS.
60. Macklin, J.G. 1961. Canal dredging and silting in Louisiana bays. Pub. Inst. Mar. Sci., Univ. Texas 7: 262-314.
61. Malcolm Pirnie, Inc. 1978. Dredging of PCB-contaminated river bed materials, upper Hudson River, New York. New York State Dept. Env. Cons. publication, 3 vols.

62. Mallory, C.W., and M.A. Nawrocki. 1974. Containment area facility concepts for dredged material separation, drying and rehandling. Hittman Assoc., Inc., Columbia, MD. DMRP Contract Rept. D-74-6. 236 pp.
63. Marshall, A.R. 1968. Dredging and filling. Pages 107-113 *in* J.D. Neusom, ed. Marsh and estuary management symposium, T.J. Moran's Sons, Inc., Baton Rouge, LA.
64. May, E.B. 1973. Environmental effects of hydraulic dredging in estuaries. Alabama Mar. Res. Bull. 9: 1-85.
65. McCall, P.L. 1977. Community patterns and adaptive strategies of the infaunal benthos of Long Island Sound. J. Mar. Res. 35: 221-268.
66. McGrorty, S., and C.J. Requing. 1984. The rate of infill and colonization by invertebrates of borrow pits in the Wash (S.E. England). Est. Coast. Shelf. Sci. 19: 303-319.
67. Minello, T.J., R.J. Zimmerman and E.F. Klima. 1987. Creation of fisheries habitat in estuaries. (No pages) *in* M.C. Landon and H. K. Smith eds., Beneficial Uses of Dredged Material, Proceedings of the First Interagency Workshop, 7-9 October, 1986, Pensacola, Florida. Tech. Rept. D-87-1, U.S. Army Engineers Waterways Experiment Station, Vicksburg, MS.
68. Mohr, A.W. 1974. Development and future of dredging. J. Waterw. Harbors Coast ASCE. 100(WW2): 70-83.
69. Morton, J.W. 1976. Ecological impacts of dredging and dredge spoil disposal: a literature review. MS Thesis, Cornell University.
70. Morton, J.W. 1977. Ecological effects of dredging and dredge spoil disposal: a literature review. Tech. Paper No. 94, U.S. Fish and Wildlife Service.
71. National Marine Fisheries Service. 1980. Seasonal restrictions on dredging projects by NMFS in the Northeast. Env. Assessment Branch Rept., contract No. SB 1409(a)-79-C-169.
72. New England Division, Corps of Engineers. 1985. Specification for bioassay and bioaccumulation testing of sediment samples. Attachment to Solicitation No. DACW 33-85-0011.
73. New York District, Corps of Engineers. 1982. Guidance for performing tests on dredged material to be disposed of in ocean waters (unpublished mimeo).
74. Nichols, J.A., G.T. Rowe, C.H. Clifford, and R.A. Young. 1978. In situ experiments on the burial of marine invertebrates. J. Sed. 48: 419-425.

75. North Carolina Dept. Nat. Res. and Community Development. 1985. Handbook for Development in North Carolina's Coastal Areas. North Carolina Division of Coastal Management, 90 pp.
76. O'Connor, B.A. 1983. Sediment transport in the estuarine and coastal environment. *The Dock and Harbour Authority* 63: 324-337.
77. O'Connor, J.M., and S.C. O'Connor. 1983. Evaluation of the 1983 capping operations at the experimental mud dump site, New York Bight Apex. Tech. Rept. D-83-3, prepared by New York University Medical Center, New York, and Valley Ecosystems, Warwick, New York, for the U.S. Army Engineer Waterways Experiment Station, Vicksburg, MS.
78. Oertel, G.F. 1975. Report of hydraulic and sedimentologic study of the offshore disposal area, Savannah, GA, from report to the U.S. Army Corps of Engineers, Savannah District. Skidaway Institute of Oceanography, Savannah, GA.
79. Oliver, J.S., P.N. Slattery, L.W. Hulberg, and J.W. Nybakken. 1977. Patterns of succession in infaunal benthic communities following dredging and dredged material disposal in Monterey Bay. Tech. Rept. D-77-27. U.S. Army Engineer Waterways Experiment Station, Vicksburg, MS.
80. Palermo, M.R. 1986a. Interim guidance for predicting the quality of effluents discharged from confined dredged material disposal areas. Misc. Paper D-86-1, U.S. Army Engineer Waterways Experiment Station, Vicksburg, MS.
81. Palermo, M.R. 1986b. Development of a modified elutriate test for estimating the quality of effluent for confined dredged material disposal areas. Tech. Rept. D-86-4, U.S. Army Engineer Waterways Experiment Station, Vicksburg, MS.
82. Palmer, H.D., and M.C. Gross. 1979. Ocean dumping and marine pollution. Hutchinson and Ross, Inc., Stroudsburg, PA.
83. Pearce, J.B. 1972. Biological survey of submerged refuse. *Mar. Pollut. Bull.* 2: 157-158.
84. Pequegnat, W.G., D.D. Smith, R.M. Darnell, B.J. Presley and R.D. Reid. 1978. An assessment of the potential impact of dredged material disposal in the open ocean. DMRP. Tech. Rept. D-78-2, U.S. Army Engineers Waterways Experiment Station, Vicksburg, MS.
85. Plumb, A.H. 1981. Procedure for handling and chemical analysis of sediment and water samples. Tech. Rept. EPA/CE-81-1, U.S. Army Engineer Waterways Experiment Station, Vicksburg, MS.

86. Poiner, I.R., and R. Kennedy. 1984. Complex patterns of change in the macrobenthos of a large sand bank following dredging: I. Community analyses. *Mar. Biol.* 78: 335-352.
87. Race, M.S. 1985. Critique of present wetlands mitigation policies in the United States based on an analysis of past restoration projects in San Francisco Bay. *Env. Mgmt.* 9: 71-82.
88. Race, M.S., and D. R. Christie. 1982. Coastal zone development: mitigation, marsh creation and decisionmaking. *Env. Mgmt.* 6: 317-328.
89. Radke, L.D., and J.L. Turner. 1967. High concentrations of total dissolved solids block spawning migration of striped bass in San Joaquin River, California. *Trans. Am. Fish. Soc.* 96: 405-407.
90. Rees, C.P. 1980. Environmental impacts of dredging operations. Pages 373-388 in *Third International Symposium on Dredging Technology*, BHRA Fluid Engineering, Bedford, England.
91. Reimold, R.J., and C.J. Durant. Toxaphene content of estuarine fauna and flora before, during and after dredging toxaphene-contaminated sediments. *Pestic. Monit. J.* 8: 44-49.
92. Rhoads, D.C., K. Tenore, and M. Browne. 1975. The role of resuspended bottom mud in nutrient cycles of shallow embayments. Pages 563-582 in L. E. Cronin, ed. *Estuarine research. Vol. I.* Academic Press, Inc., New York.
93. Rhoads, D.C., L. F. Boyer, B. L. Welsh, and G. R. Hampson. 1984. Seasonal dynamics of detritus in the Benthic Turbidity Zone (BTZ): implications for bottom-rack molluscan mariculture. *Bull. Mar. Sci.* 35: 536-549.
94. Rose, C.D. 1973. Monitoring of market-sized oysters (*Crassostrea virginica*) in the vicinity of a dredging operation. *Chesapeake Sci.* 14: 135-138.
95. Rosenberg, R. 1977. Effects of dredging operations on estuarine benthic macrofauna. *Mar. Poll. Bull.* 8: 102-104.
96. Saila, S.B., S.D. Pratt, and T.T. Polgar. 1972. Dredge spoil disposal in Rhode Island Sound. *URI Marine Tech. Rept.* 2. 48 pp.
97. Sawlan, J., and J. Borgeld. 1976. *Geological Oceanography Laboratory Manual*, University of Washington, unpublished mimeo. 35 pp.
98. Shaffer, G.P. 1984. The effect of sedimentation on the primary production of benthic microflora. *Estuaries* 7: 497-500.
99. Shelton, R.J.G. 1971. Sludge dumping in the Thames Estuary. *Mar. Pollut. Bull.* 2: 24-27.

100. Sherk, J.A. 1971. The effects of suspended and deposited sediments on estuarine organisms: literature survey and research needs. Chesapeake Biological Laboratory, Solomons, MD, Contrib. No. 433. 73 pp.
101. Sherk, J. A. 1972. Current status of knowledge of the biological effects of suspended and deposited sediments in Chesapeake Bay. Chesapeake Sci. 13(suppl.): 137-144.
102. Sherk, J.A., J.M. O'Connor, P.A. Neumann, R.D. Prince, and K.V. Wood. 1974. Effects of suspended and deposited sediments on estuarine organisms, Phase II, Final Report No. 74-20, University of Maryland, Natural Resource Institute, Prince Frederick, MD. 259 pp.
103. Sherk, J.A., J.M. O'Connor, and D.A. Neumann. 1975. Effects of suspended and deposited sediments on estuarine environments. Pages 541-558 in L.E. Cronin, ed. Estuarine research, Vol. II. Academic Press, New York.
104. Simon, J.L., and J. P. Dyer III. 1972. An evaluation of siltation created by Bay Dredging and Construction Company during oyster shell dredging in Tampa Bay, Florida, January 1, 1972 to March 3, 1972. Final Research Report, Department of Biology, University of South Florida, Tampa. 60 pp.
105. Slotta, L.S. 1974. Dredging problems and complications. Pages 39-52 in Coastal zone management problems. Oregon State University, Water Resources Research Institute, SEMN- WR-018-74. 90 pp.
106. Stern, E.M., and W.B. Stickle. 1978. Effects of turbidity and suspended materials in aquatic environments: literature review. U.S. Army Engineer Waterways Experiment Station, Vicksburg, MS. Tech. Rept. D-78-21,.
107. Stickney, R.R. 1973. Effects of hydraulic dredging on estuarine animals. World Dredging and Mar. Const. 34: 37.
108. Stickney, R.R., and D. Perlmutter. 1975. Impact of intercoastal waterway maintenance dredging on a mud bottom benthos community. Biol. Conserv. 7: 211-236.
109. Swartz, R.C., W.A. DeBen, F.A. Cole, and L.C.. Bentsen. 1980. Recovery of the macrobenthos at a dredge site in Yaquina Bay, Oregon. Pages 391-408 in R.A. Balcer, ed. Contaminants and sediments, Vol. 2. Ann Arbor Science Publishers, Ann Arbor, MI.
110. Taylor, J.L., and C.H. Saloman. 1968. Some effects of hydraulic dredging and coastal development in Boca Ciega Bay, Florida. U.S. Fish and Wildlife Service Fisheries Bulletin 68: 299-306.

111. Truitt, C.L. 1986. The Duwamish Waterway capping demonstration project: engineering analysis and results of physical monitoring. U.S. Army Engineer Waterways Experiment Station, Vicksburg, MS. Tech. Rept. D-86-2.
112. Turnbull, R.W., and R.C. Hirschfeld. 1982. Dredging of PCB-contaminated sediments, New Bedford Harbor/Acushnet River Estuary, MA. New England Governors' Conference publication.
113. U.S. Army Corps of Engineers. 1986. Beneficial Uses of Dredged Material. Engineer Manual No. 1110-2-5026.
114. U.S. Army Waterways Experiment Station. 1977. Effects of disposal of dredged material on high marsh. Dredged Material Research Program, Information Exchange Bulletin, Vol. D-77-2, Vicksburg, MS.
115. Van Der Veer, H.W., M.J.N. Bergman, and J.J. Beukema. 1985. Dredging activity in the Dutch Wadden Sea: effects on macrobenthic infauna. *Neth. J. Sea Res.* 19: 183-190.
116. Wang, L.K., P.M. Terlecky, and R.P. Leonard. 1977. Engineering and management aspects of dredged material disposal and treatment. *J. Env. Mgmt.* 5: 181-203.
117. White, H.W., and M.A. Champ. 1982. The great bioassay hoax and alternatives. Paper presented at ASTM 2nd Annual Symposium on Testing of Hazardous and Industrial Solid Wastes, Lake Buena Vista, Florida.
118. Windom, H.L. 1976. Environmental aspects of dredging in the coastal zone. *Critical Rev. Env. Control* 6: 91-110.

D. Bibliography of various topics (From Way et al. 1990.)

This bibliography is in a text file on the computer program diskette containing the program "TRAFFIC" by Carl M. Way, US Army Engineer Waterways Experiment Station, Vicksburg, MS. Documentation for this diskette and program is in the following document:

Way, C. M., A. C. Miller, B. S. Payne, and J. Wakeley. 1990. Traffic: An information retrieval system to evaluate the environmental impacts of commercial navigation traffic. USACE Environmental Impact Research Program Tech. Rep. EL-90-13. 17 pp. plus appendices.

A copy of the document and the diskette are on file at the Waquoit Bay National Estuarine Research Reserve, P.O. box 3092, Waquoit, MA 02536.

-
1. Academy of Natural Sciences of Philadelphia. 1980. Analysis of Effect of Tow Traffic on the Biological Components of the Ohio River. US Army Engineer District, Huntington, OH.
 2. Aldridge, D., Payne, B. S., Miller, A. C. 1987. The Effects of Intermittent Exposure to Suspended Solids and Turbulence on Three Species of Freshwater Mussels. *Environmental Pollution*, Vol 45, pp 17-28.
 3. Alger, G. R. 1979. Ship-induced Waves and Physical Measurements on the St. Mary's River. Environmental Evaluation Work Group, Winter Navigation Board, Detroit, MI.
 4. Angino, E. E., and W. J. O'Brien. 1968. Effects of Suspended Material on Water Quality. *International Association of Scientific Hydrology*, Vol 78, pp 120-128.
 5. Arruda, J. A., Marzolf, G. R. and Faulk, R. T. 1983. The Role of Suspended Sediments in the Nutrition of Zooplankton in Turbid Reservoirs. *Ecology*, Vol 64, pp 1225-1235.
 6. Balanin, V. V., and Bykov, L. S. 1975. Selection of Leading Dimensions of Navigation and Channel Sections and Modern Methods of Bank Protection. *Proceedings, Twenty-first International Navigation Congress, Stockholm, Sweden*.
 7. Barnes, R. D. 1987. Invertebrate Zoology. Fifth Edition. W.B. Saunders Company, Philadelphia, PA.
 8. Battelle Laboratories. 1985. Survey of the Unionid Mollusks of the Ohio River in the Vicinity of the William H. Zimmer Station (Ohio River Miles 442.6 to 445.6).

- Submitted to the Cincinnati Gas and Electric Company, Columbus and Southern Electric Company, and The Dayton Power and Light Company.
9. Bayne, B. L., Moore, M. N., Willows, J., Livingstone, D. R., and Salkeld, P. 1979. Measurements of the Responses of Individuals to Environmental Stress and Pollution: Studies with Bivalve Molluscs. *Philosophical Transactions of the Royal Society of London, Series B, Vol 286*, pp 563-581.
 10. Bayne, B. L., Clarke, K. R., and Moore, M. N. 1981. Some Practical Considerations in the Measurement of Pollution Effects on Bivalve Molluscs, and Some Possible Ecological Consequences. *Aquatic Toxicology, Vol 1*, pp 159-174.
 11. Bayne, B. L. and Newell, R. C. 1983. Physiological Energetics of Marine Molluscs. *In K. M. Wilbur & A.S.M. Saleuddin, eds. The Mollusca, Vol. 4, Part 1*, pp 407-515. Academic Press, New York, N.Y.
 12. Becket, D.C., Kasul, R.L., Winfield, L.E., and Bowles, G.E. 1985. Vertical, Horizontal, and Diel Distribution of Invertebrate Drift in the Lower Mississippi River. Technical Report E-87-5, US Army Engineer Waterways Experiment Station, Vicksburg, MS.
 13. Bellrose, R.C., F.L. Pavaglio, Jr. and D.W. Steffect. 1979. Waterfowl Populations and the Changing Environment of the Illinois River Valley. *Illinois Natural History Survey Bulletin, Vol 32*, pp 1-54.
 14. Berger Associates, Ltd. 1980. Environmental and Physical Impact Studies for Gallipolis Locks and Dam, Ohio River, Phase 1 Replacement Study, Vol II, Navigation Impacts. Academy of Natural Sciences.
 15. Berger Associates, Ltd. 1981. Analysis of Impact of Navigation on the Tennessee-Tombigee Waterway. Contract Report for Department of Justice, Washington, D.C.
 16. Berger Associates, LTD. 1981. Inventory of Potential Structural and Non-Structural Alternatives for Increasing Navigation Capacity -- Upper Mississippi River System Plan. Contract Report for Upper Mississippi River Basin Commission, Minneapolis, MN.
 17. Bhowmik, N.G., J.R. Adams, A.P. Bonini, C-Y. Guo, D. Kissler and M. Sexton. 1981a. Resuspension and lateral movement of sediment by two traffic on the Upper Mississippi and Illinois Rivers. Illinois State Water Survey Division, SWS Contract Report 269, for Environmental Work Team, Upper Mississippi River Basin Commission Master Plan Task Force, Minneapolis, MN. pp 112.
 18. Bhowmik, N.G., Demissie M. and Osakada S. 1981b. Waves and Drawdown Generated By River Traffic on the Illinois and Mississippi Rivers. Illinois State Water Survey Division, SWS Contract Report No. 271 for Environmental Work Team,

- Upper Mississippi River basin Commission Master Plan Task Force, Minneapolis, MN. pp 98
19. Bhowmik, N. G., Lee, M. T., Bogner, W. C., and Fitzpatrick, W. 1981c. The Effects of Illinois River Traffic on Water and Sediment Input to a Side Channel. Illinois State Water Survey Contract Report 270 for Environmental Work Team, Upper Mississippi River Basin Commission Master Plan, Minneapolis, MN.
 20. Bhowmik, N. G., Demissie, M., and Guo, C. Y. 1982. Waves Generated by River Traffic and Wind on the Illinois and Mississippi Rivers. University of Illinois Water Resources Center Research Report No. 167.
 21. Bingham, C. R., Cobb, S. P., and Magoun, T. D. 1980. Aquatic Habitat Studies on the Lower Mississippi River, River Mile 480 to 530; Report 4, Diel Periodicity of Benthic Macroinvertebrate Drift. Miscellaneous Paper E-80_1, US Army Engineer Waterways Experiment Station, Vicksburg, MS.
 22. Bjorklund, R.G. 1975. On The Death Of A Midwestern Heronry. *Wilson Bulletin*, Vol 87, pp 284-287.
 23. Boyd, W., and Harber, J. G. 1981. Effects of Navigation and Operation/Maintenance of the Upper Mississippi River System Nine-Foot Channel on Waterfowl Populations. Prepared for the Upper Mississippi River Basin Committee.
 24. Bricelj, V. M., Malouf, R. E. and de Quillfeldt, C. 1984. Growth of Juvenile *Mercenaria mercenaria* and the Effect of Resuspended Bottom Sediments. *Marine Biology*, Vol 84, pp 167-173.
 25. Brown, C.J.D., Clark, C. and Gleissner, B. 1938. The Size of Naiads from Western Lake Erie in Relation to Shoal Exposure. *American Midland Naturalist*, Vol 19, pp 682-701.
 26. Buck, D. H. 1956. Effects of Turbidity on Fish and Fishing. *Transactions of the 21st North American Wildlife Conference*, pp 249-261.
 27. Cairns, J., Jr. 1968. Suspended Solids Standards for the Production of Aquatic Organisms. 22nd Purdue Industrial Waste Conference Purdue Engineering Bulletin, Vol 129, pp 16-27.
 28. Camfield, F. E., Ray R. E. L., and Eckert J. W. 1980. The Possible Impact of Vessel Wakes on Bank Erosion. Prepared by USAE, Fort Belvoir, Virginia, for US Department of Transportation and US Coast Guard, Washington, D.C. Report No. USCG-W-1-80 114 pp. NTIS No. ADA-083-896.
 29. Carlson, R. W. 1984. The Influence of pH, Dissolved Oxygen, Suspended Solids, or Dissolved Solids upon Ventilatory and Cough Frequencies in the Bluegill *Lepomis*

- machrochirus* and Brook Trout *Salvelinus fontinalis*. Environmental Pollution Act, Vol 34, pp 149-169.
30. Chew, R. L. 1969. Investigations of Early Life History of Largemouth Bass in Florida. Project Report F-024-R-02, Florida Game and Freshwater Fish Commission, Tallahassee, FL.
 31. Chutter, F. M. 1969. The Effects of Silt and Sand on the invertebrate Fauna of Streams and Rivers. *Hydrobiologia*, Vol 34, pp 57-76.
 32. Ciborowski, J. J. H., Pointing, P. J. and Corkum, L. D. 1977. The Effect of Current Velocity and Sediment on the Drift and Settlement of the Mayfly *Ephemerella subvaria* McDunnough. *Freshwater Biology*, Vol 7, pp 567-572.
 33. Claflin, T. O., Rada, R. G., Smart, M. M., Nielson, D. N., Scheidt, J. K., and Biltgen, B. A. 1981. The Effects of Commercial and Recreational Navigation on Selected Physical and Chemical Variables in Navigation Pool No. 9, Upper Mississippi River. Contract Report to the Environmental Work Team, Upper Mississippi River Basin Commission, Minneapolis, MN.
 34. Claflin, T. O., Rada, R. G., Smart, M. M., Winfrey, M. R., and Peck, J. H. 1982. The Physical Effects of Commercial Traffic on the Navigable Portion of the Tombigee River. Contract Report to the Law Firm of Brown, Rody, Bonvillian and Gold, Washington, D.C.
 35. Clampett, P. T. 1973. Substrate as a Factor in the Distribution of Pulmonate Snails in Douglas Lake, Michigan, USA. *Malacologia*, Vol 12, pp 379-399.
 36. Clark, W. R. 1981. Assessment of Navigation Effects on Muskrats of pool of the Upper Mississippi River. Final Report to the Upper Mississippi River Basin Commission, Minneapolis, MN.
 37. Clark, W. R., and Iowa Cooperative Research Unit. 1981. Assessment of Navigation Effects on Muskrats in Pool 9 of The Upper Mississippi River. A Report submitted to the US Fish and Wildlife Service and the Upper Mississippi River Basin Commission.
 38. Clark, W. R., and R. T. Clay. 1985. Standing Crop of *Sagittaria* in the Upper Mississippi River. *Canadian Journal of Botany*, Vol 63, pp 1453-1457.
 39. Clarke, A. H. 1982. The Recognition of Ecophenotypes in Unionidae. *In: Report of Freshwater Mollusc Workshop; 26-27 October 1982. US Army Engineer Waterways Experiment Station, CE. Vicksburg, MS. 196 pp.*
 40. Cline, L. D., Short, R. A. and Ward, J. V. 1982. The Influence of Highway Construction on the Macroinvertebrates and Epilithic of a High Mountain Stream. *Hydrobiologia*, Vol 96, pp 149-159.

41. Coker, R.E., A. Shira, H. Clark, and Howard, A. 1921. Natural History and Propagation of Freshwater Mussels. *Bulletin of the US Bureau of Fisheries*, Vol 37: pp 75-182.
42. Cook, P., McGraw, D. and Louis Berger and Associates, Inc. 1981. National Waterways Study Analysis of Navigation Relationships to Other Water Uses. Contract Report for the US Army Corps of Engineers Institute for Water Resources Support Center, Fort Belvoir, VA.
43. Cordone, A. J., and Kelly, D. W. 1961. The Influence of Inorganic Sediment on Aquatic Life in Streams. *California Fish and Game Commission*, Vol 47, pp 189-228.
44. Cross, F. B. 1967. Handbook of Fishes of Kansas, Miscellaneous Publication 45, Museum of Natural History of the University of Kansas, Lawrence, Kansas.
45. Das, M. M. 1969. Relative Effect of Waves Generated by Large Ships and Small Boats in Restricted Waterways. Hydraulic Engineering Laboratory, University of California at Berkeley, Berkeley, CA.
46. Dietz, A. R., Harrison, R. W., Olson, H. E., Grier, D., and Simpkins, C. 1983. National Waterways Study — A Framework for Decision Making — Final Report. US Army Engineer Institute for Water Resources, Water Resources Support Center, Report NWS-83-1, Fort Belvoir, VA.
47. Demissie, M., and Osakada, S. 1981. Waves and Drawdown Generated by River Traffic on the Illinois and Mississippi Rivers. Illinois Institute of Natural Resources, Crafton, IL.
48. Dorris, T. C., and Copeland, B. J., and Lauer, K. J. 1963. Limnology of the Middle Mississippi River; IV, Physical, and Chemical Limnology of River and Chute. *Limnology and Oceanography*, pp 879-88.
49. Eckblad, J. W. 1981. Baseline Studies and Impacts of Navigation on the Benthos and Drift (Work Task 6), on the Quantity of Flow to Side Channels (Work Task 14), and on the Suspended Matter Entering Side Channels (Work Task 16) of Pool 9 of the Upper Mississippi River. Report prepared for the Environmental Work Team, Upper Mississippi River Basin Commission, Minneapolis, MN.
50. Eckblad, J. W., Volden, C. S., and Weilgart, L. S. 1984. Allochthonous drift from backwater to the main channel of the Mississippi River. *American Midland Naturalist*, Vol 11, pp 16-22.
51. Eckblad, J. W., Peterson N. L., Ostlie K., and Temte A. 1977. The Morphometry, Benthos and Sedimentation Rates of a Floodplain Lake in Pool 9 of the Upper Mississippi River. *American Midland Naturalist*, Vol 97, pp 433-443.

52. Ecology Consultants, Inc. 1979. Navigation Effects on the Biological Components of the Upper Mississippi River Aquatic Ecosystem. Prepared for the Upper Mississippi River Basin Commission, Twin Cities, MN.
53. Ellis, M. M. 1936. Erosion Silt as a Factor in Aquatic Environments. *Ecology*, Vol 17, pp 29-42.
54. Ellis, M. M. 1931. Some Factors Affecting the Replacement of the Commercial Freshwater Mussels. US Bureau of Fisheries, Vol I, pp 1-10.
55. Ellison, L.N. and L. Cleary. 1978. Effects of Human Disturbance on Breeding of Double-Crested Cormorants. *Auk*, Vol 95, pp 510-517.
56. Environmental Science and Engineering. 1981. Navigation Impact Study, Illinois River, Pool 26, August 1980, Mississippi River, Pool 9, October 1980, Phase III, Task 9. Prepared for: Illinois Natural History Survey, Grafton, IL.
57. Environmental Science and Engineering. 1988. Report on the Monitoring Study of Relocated Mussels Near Ripley, Ohio. Submitted to Mussel Mitigation Trust Fund Committee, Columbus, Ohio, by Environmental Science and Engineering, Inc., St. Louis, MO. ESE No. 87-856.
58. ERT/Ecology Consultants, Inc. 1979. Potential Environmental Impacts of Mississippi River Year-Round Navigation on Commercial Fishing. Report prepared for the US Army Engineer District, Rock Island, IL.
59. European Inland Fisheries Advisory Commission. 1964. Water Quality Criteria for European Freshwater Fish. Technical Paper No. 1, EIFAC Working Party on Water Quality Criteria for Freshwater Fish, Rome, Italy.
60. Fraser, J. D., Frenzel, L. D. and Mathisen J. E. 1985. The Impact of Human Activities on Breeding Bald Eagles in North-Central Minnesota. *Journal of Wildlife Management*, Vol 49, pp 585-592.
61. Fudge, R. J. P., and Bodaly, R. A. 1984. Post-Impoundment Winter Sedimentation and Survival of Lake Whitefish (*Coregonus clupeaformis*) Eggs in Southern Indian Lake, Manitoba. *Canadian Journal of Fisheries and Aquatic Science*, Vol 41, pp 701-705.
62. Fuehrer, M., and Romish, K. 1977. Effects of Modern Ship Traffic on Inland and Ocean-waterways and Their Structures. Proceedings of the 24th International Navigation Congress, Leningrad, Russia.
63. Fuller, S. L. H. 1974. Clams and Mussels (Mollusca: Bivalvia). Pages 215-273 in C. W. Hart, Jr., and S. L. H. Fuller, eds., Pollution Ecology of Freshwater Invertebrates, Academic Press, New York, N.Y.

64. Fuller, S. L. H. 1978. Freshwater Mussels (Mollusca: Bivalvia: Unionidae) of the Upper Mississippi River: Observations at Selected Sites Within the 9-Foot Channel Navigation Project on Behalf of the United States Army Corps of Engineers. Academy of Natural Sciences of Philadelphia, PA. pp 401.
65. Fuller, T. K. and Robinson W. L. 1982. Some Effects of Winter Shipping on Movements of Mammals Across River Ice. Wildlife Society Bulletin, Vol 10, pp 156-160.
66. Gammon, J. R. 1970. The Effect of Inorganic Sediment on Stream Biota. Water Pollution Control Research Series, Environmental Protection Agency, Cincinnati, OH.
67. Gardner, W. S., Miller III, W. H., and Imlay, M. J. 1981. Free Amino Acids in Mantle Tissues of the Bivalve *Amblema plicata*: Possible Relation to Environmental Stress. Bulletin Environmental Contaminates and Toxicology, Vol 26, pp 157-162.
68. Gates, E. T., and Herbich, J. B. 1977. The Squat Phenomenon and Related Effects of Channel Geometry. Hydraulics in the Coastal Zone, 25th Annual Hydraulics Division Specialty Conference, American Society of Civil Engineers, College Station, TX.
69. Gradall, K. S., and Swenson, W. A. 1982. Responses of Brook Trout and Creek Chubs to Turbidity. Transactions of the American Fisheries Society, Vol 111, pp 392-395.
70. Gray, L. J., and Ward, J. V. 1982. Effects of Sediment Releases from a Reservoir on Stream Macroinvertebrates. Hydrobiologia, Vol 96, pp 177-184.
71. Gregg, R. E., and Bergersen, E. P. 1980. *Mysis relecta*: Effects of Turbidity and Turbulence on Short-term Survival. Transactions of the American Fisheries Society, Vol 109, pp 207-212.
72. Grubb, T.G., Jr. 1977. Weather-Dependent Foraging in Ospreys. Auk, Vol 94, pp 146-149.
73. Gucinski, H. 1982. Sediment Suspension and Resuspension from Small-Craft Induced Turbulence. Prepared for The Environmental Protection Agency, Annapolis, MD.
74. Hagerty, D. J., Spoor, M. F., and Ullrich, C. R. 1981. Bank Failure and Erosion on the Ohio River. Engineering Geology, Vol 17, pp 141-158.
75. Harmon, W. N. 1972. Benthic Substrates: Their Effect on Freshwater Mollusca. Ecology, Vol 53, pp 271-277.
76. Harrison, A. D., and Farina, T. D. W. 1965. A Naturally Turbid Water with Deleterious Effects on Egg Capsules of Planorbid Snails. Annals of Tropical Medicines and Parasitology, Vol 59, pp 327-330.

77. Hawkinson, R. and Grunwald, G. 1979. Observations on the Wintertime Concentration of Catfish in the Mississippi River. Investigations Report No. 365 of the Minnesota Department of Natural Resources, Minneapolis, MN.
78. Hay, D. 1968. Ship Waves in Navigable Waterways. Proceedings of the 11th Conference on Coastal Engineering, London.
79. Heimstra, N. D., Damkot, D. K. and Benson, N. G. 1969. Some Effects of Silt Turbidity on Behavior of Juvenile Largemouth Bass and Green Sunfish. Technical Paper 20 of the US Bureau of Sport Fisheries and Wildlife, Washington, D.C.
80. Helwig, P. C. 1969. An Experimental Study of Ship-generated Water Waves. MS Thesis, Queen's University, Kingston, Ontario.
81. Herricks, E. E., and Gantzer, C. J. 1980. Effects of Barge Passage on the Water Quality of the Kaskaskia River. Civil Engineering Studies, Environmental Engineering Series No. 60, University of Illinois, Urbana, IL.
82. Herricks, E. E., Osborne, L. L., Cairns, C., Gantzer, C., Himelick, D., and Schritt L. 1982. Effects of Barge Passage on Physical, Chemical, and Biological Conditions in the Navigation Reach of the Kaskaskia River. Final Report, Upper Mississippi River Basin Commission, Urbana, IL.
83. Hildreth, D.I. 1976. The Influence of Water Flow Rate on Pumping Rate in *Mytilus edulis* Using a Refined Direct Measurement Apparatus. Journal of the Marine Biological Association of the United Kingdom, Vol 56, pp 311-319.
84. Holland, L. E. 1983. Evaluation of Simulated Drawdown Due to Navigation Traffic on Eggs and Larva of two Fish Species of the Upper Mississippi. US Fish and Wildlife Service, National Fisheries Research Laboratory, LaCrosse, WI.
85. Holland, L. E. 1986. Effects of Barge Traffic on Distribution and Survival of Ichthyoplankton and Small Fishes in the Upper Mississippi River. Transactions of The American Fisheries Society, Vol 115, pp 162-165.
86. Holland, L. E., and Lester, M. L. 1984. Relationship of Young-of-the-Year Northern Pike to Aquatic Vegetation Types in Backwaters of the Upper Mississippi River. North American Journal of Fisheries Management, Vol 4, pp 514-522.
87. Holland, L. E., and Sylvester, J. R. 1983. Distribution of Larval Fishes Related to Potential Navigation Impacts on the Upper Mississippi River, Pool 7. Transactions of the American Fisheries Society, Vol 112, pp 293-301.
88. Horkel, J. D., and Pearson, W. D. 1976. Effects of Turbidity on Ventilation Rates and Oxygen Consumption of Green Sunfish, *Lepomis cyanellus*. Transactions of the American Fisheries Society, Vol 1, pp 107-113.

89. Horne, F. R., and McIntosh, S. 1979. Factors Influencing the Distribution of Mussels in the Blanco River of Central Texas. *The Nautilus*, Vol 94, pp 119-132.
90. Hubert, W. A. Undated. Impacts of Navigation Traffic on Fish. Iowa Cooperative Fishery Research Unit. Iowa State University, Ames, IO.
91. Hubert, W. A. Undated. Assessment of Possible Navigation Impacts on Channel Fishes of Pool 9 Utilizing Data from 1980 Reconnaissance Study. Iowa Cooperative Fishery Research Unit, Iowa State University, Ames, IO.
92. Hubert, W. A., Darnell, G. E. and Dalk, D. E. 1983. Evaluation of Wintering Benthic Macroinvertebrates of Pool 13 of the Upper Mississippi River. Wyoming Cooperative Fish and Wildlife Research Unit, Laramie, WY.
93. Hurst, C. K., and Brebner, A. 1969. Shore Erosion and Protection St. Lawrence River, Canada. Permanent International Association of Navigation Congresses, XXIIInd International Congress, Paris, Sec 1, pp 45-56.
94. Jackivicz, T. P., Jr., and Kuzminski, L. N. 1973. A Review of Outboard Motor Effects on the Aquatic Environment. *Journal of Water Pollution Control Federation*, Vol 45, No. 8, pp 1759-1770.
95. Johnson, D. D., and Widish, D. J. 1982. Effect of Suspended Sediment on Feeding by Larval Herring (*Clupea harengus*). *Bulletin of the Environmental Contaminants and Toxicology*, Vol 29, pp 261-267.
96. Johnson, F. H. 1958. Ship Waves in Navigation Channels. *Proceedings of the 6th Conference on Coastal Engineering*. Berkley, CA. pp 666-690.
97. Johnson, F. H. 1961. Walleye Egg Survival during Incubation on Several Types of Bottom in Lake Winnibigoshish, Minnesota, and Connecting Waters. *Transactions of the American Fisheries Society*, Vol 90, pp 312-322.
98. Johnson, J. H. 1976. Effects of Tow Traffic on Resuspension of Sediments and Dissolved Oxygen Concentration in the Illinois and Upper Mississippi River under Normal Flow Conditions. Technical report Y-76-1, US Army Engineer Waterways Experiment Station, Vicksburg, MS.
99. Johnson, J. K. 1971. Effect of Turbidity on the Rate of Filtration and Growth of the Slipper Limpet, *Crepidula fornicata* Lamarck, 1799. *The Veliger*, Vol 14, pp 315-320.
100. Johnson, J. W. 1958. Ship Waves in Navigation Channels. *Proceedings of the 6th Conference on Coastal Engineering*, Berkeley, CA.
101. Johnson, J. W. 1969. Sguo Waves in Shoaling Waters. *Proceedings of the Conference on Coastal Engineering*, American Society Civil Engineering, Vol 2, pp 1488-1498.

102. Karaki, S. and Van Hoften, J. 1974. Resuspension of Bed Material and Wave Effects on the Illinois and Upper Mississippi Rivers Caused by Boat Traffic. Colorado State University, Fort Collins. Contract No. LMSSD 75-881, Prepared for USAE, St. Louis District. 30 pp.
103. Kat, P. W. 1982. Effects of Population Density and Substratum Type on Growth and Migration of *Elliptio complanata* (Bivalvia: Unionidae). *Malacological Review*, Vol 15, pp 119-127.
104. Killgore, K. J. 1979. The Ecological Relationships of *Hydrilla verticillata* Royle in Lake Conroe, Texas. M. S. Thesis Sam Houston State University. Huntsville, TX.
105. Killgore, K. J., Miller, A. C., and Conley, K. C. 1987. Effects of Turbulence on Yolk-Sac Larvae of Paddlefish. *Transactions of The American Fisheries Society*, Vol 116, pp 670-673.
106. Kiorboe, T., Mohlenberg, F., and Nohr, G. 1981. Effect of Suspended Bottom Material on Growth and Energetics in *Mytilus edulis*. *Marine Biology*, Vol 61, pp 283-288.
107. Kirby-Smith, W.W. 1972. Growth of the Bay Scallop: The Influence of Experimental Water Currents. *Journal of Experimental Marine Biology and Ecology*, Vol 8, pp 7-18.
108. Knight, R. L and S. K. Knight. 1984. Responses of Wintering Bald Eagles to Boating Activity. *Journal of Wildlife Management*, Vol 48, pp 999-1004.
109. Krumholz, L. A., and Minkley, W. L. 1964. Changes in the Fish Populations in the Upper Ohio River Following Temporary Pollution Abatement. *Transactions of the American Fisheries Society*, Vol 93, pp 1-5.
110. Lagler, K. F., J. E. Bardach, and R. R. Miller. 1962. *Ichthyology*. John Wiley and Sons. New York, NY.
111. Laughlin, D. R. and E. E. Werner. 1980. Resource Partitioning in Two Coexisting Sunfish: Pumpkins-seed (*Lepomis gibbosus*) and Northern Longear Sunfish (*Lepomis megalotis peltastes*). *Canadian Journal of Fisheries and Aquatic Sciences*, Vol 37, pp 1411-1420.
112. Lee, M. T., Bogner W. C., and Fitzpatrick W. P. 1981. Water and Sediment Inputs to Selected Side Channels Associated with River Traffic. Paper presented at the 14th Annual Mississippi River Research Consortium, April, 1981, La Crosse, WI.
113. Link, L. F., Jr., and Williamson, A. N., Jr. 1976. Use of Automated Remote Sensing Techniques to Define the Movement of Tow Generated Suspended Material Plumes on the Illinois and Upper Mississippi Rivers. USAE Waterways Experiment Station, Vicksburg, MS. USAE District, St. Louis, MO. 71 pp.

114. Liou, Y. C., and Herbich, J. B. 1976. Sediment Movement Induced by Ships in Restricted Waterways. Report No. 188, US Army Corps of Engineers District, Detroit, Detroit, MI.
115. Liou, Y. C., and Herbisch, J. B. 1977. Velocity Distribution and Sediment Motion Induced by Ship's Propeller in Ship Channels. Proceedings, Hydraulics in the Coastal Zone, ASCE, College Station, TX.
116. Loosanoff, B. L., and Tommers, F. D. 1948. Effect Silt and Other Substances on Rate of Feeding Oysters. Science, Vol 107, pp 69-70.
117. Lubinski, K. S., Seagle, H. H., Bhowmik, N. G., Adams, J. R., Sexton, M. A., Beohnerkempe, J., Allgire, R. L., Davis, D. K., and Fitzpatric, W. 1981. Information Summary of the Physical, Chemical, and Biological Effects of Navigation. Upper Mississippi River Basin Commission, Crafton, IL.
118. Lubinski, K. S., Wallendorf, M. J., and Reese, M. C. 1981. Analysis of Upper Mississippi River System Correlations between Physical, Biological, and Navigation Variables. Upper Mississippi River Basin Commission, Crafton, IL.
119. Lund, J. W. G. 1969. Phytoplankton. In G. A. Rohlich (ed), Eutrophication: Causes, Consequences, Correctives. National Academy of Sciences, Washington, D.C.
120. Mansueti, R. J. 1961. Effects of Civilization on Striped Bass and Other Estuarine Biota of Chesapeake Bay and Tributaries. Proceedings of the Gulf Caribbean Fisheries Institute, 14th Annual Session, Annapolis, MD.
121. McCabe, G. O., and O'Brien, W. J. 1983. The Effect of Suspended Silt on Feeding and Reproduction of *Daphnia pulex*. American Midland Naturalist, Vol 110, pp 324-337.
122. McNown, J. S. 1976. Sinkage and Resistance for Ships in Channels. Journal of the Waterways Harbors and Coastal Engineering Division, No. WW3.
123. Moore, P. G. 1977. Inorganic Particulate Suspensions in the Sea and Their Effects on Marine Animals. Annual Reviews of Oceanography and Marine Biology, Vol 15, pp 225-363.
124. Morgan, R. P., Ulanowicz, R. E., Rasin, V. J., Noe, L. A., and Gray, G.B. 1976. Effects of Shear on Eggs and Larvae of Striped Bass, *Morone saxatilis* and White Perch, *Morone americana*. Transactions of the American Fisheries Society, Vol 106, pp 149-154.
125. Mueller, G. 1980. Effects of Recreational River Traffic on Nest Defense by Longear Sunfish. Transactions of the American Fisheries Society, Vol 109, pp 248-251.

126. Muller, K. 1974. Stream Drift as a Chronobiological Phenomenon Running Water Ecosystems. Annual Review of Ecology and Systematics, Vol 5, pp 309-323.
127. Muncy, R. J., Atchison, G. J., Bulkley, R. V., Menzel, B. W., Perry, L. G., and Summerfelt, R. C. 1979. Effects of Suspended Solids and Sediment on Reproduction and Early Life of Warmwater Fishes: A Review. US EPA Report 600/3-79-042, Corvallis Environmental Research Laboratory, Corvallis, Oregon.
128. Nielsen, L. A., Sheehan, R. J., and Orth, D. J. 1986. Impacts of Navigation on Riverine Fish Production in the United States. Polskie Arcdhiwum Hydrobiologii, Vol 34, pp 277-294.
129. North Star Research Institute. 1973. EIS of the Northern Section of the Upper Mississippi River, Pool 2. Final Report, US Army Engineer District, St. Paul, St. Paul, MN.
130. Ofuya, A. O. 1970. Shore Erosion Ship and Wind Waves, St. Clair, Detroit and St. Lawrence Rivers. Report No. 21, Department of Public Works of Canada, Design Branch, Ontario, Canada.
131. Otto, N. E., Enger, E. P. 1960. Some Effects of Suspended Sediments on Growth of Submersed Pondweeds. United States Department of Interior, Bureau of Reclamation, Division of Engineering Laboratories, Denver, Colorado, General Laboratory Report #227.
132. Payne, B. S., Aldridge, D. W., and Miller, A. C. 1984. Effects of Cyclic Exposure to Suspended Solids on Two Species of Freshwater Unionacean Clams. Technical Report in preparation, US Army Engineer Waterways Experiment Station, Vicksburg, MS.
133. Payne, B. S., and Miller, A. C. 1987. Effects of Current Velocity on the Freshwater Bivalve *Fusconaia ebena*. Bulletin of the American Malacological Union, Inc., Vol 5, pp 177-179.
134. Payne, B. S., and Miller, A. C., and Aldridge, D. W. 1987. Environmental Effects of Navigation Traffic: Laboratory Studies of The Effects on Mussels of Intermittent Exposure to Turbulence and Suspended Solids. Technical Report EL-87-14 of the U.S. Army Engineer Waterways Experiment Station. Vicksburg, MS.
135. Peterson, G. A. 1983. A Pilot Study to Evaluate the Winter Fishery Biology of Pool 18 of the Upper Mississippi River. US Fish and Wildlife Service, Rock Island, IL.
136. Pitlo, J., Jr. 1987. Standing Stock of Fishes in the Upper Mississippi River. Upper Mississippi River Conservation Committee, Rock Island, IL, 28 pp.

137. Poe, T. P., Edsall, T. A., and Hiltunen, J. K. 1979. Effects of Ship-induced Waves in an Ice Environment of the St. Mary's River Ecosystem. Environmental Evaluation Work Group, Winter Navigation Board, MI.
138. Rabeni, C. F., and Gibbs, K. E. 1980. Ordination of Deep River Invertebrate Communities in Relation to Environmental Variables. *Hydrobiologia*, Vol 74, pp 67-76.
139. Rada, R. G., Smart, M. M., Claflin, T. O., Biltgen, B. A., Nielsen, D. N., Scheidt, J. K. 1980. A Characterization of Navigation Pool No. 9, Upper Mississippi River, and Site Selections To Determine Impacts of Commercial and Recreational Navigation. Prepared for the Upper Mississippi River Basin Commission.
140. Rasmussen, J. and Harber, J. G. 1981. Effects of Navigation and Operation/Maintenance of the Upper Mississippi River System Nine-Foot Channel on Commercial Fish and Fishing. Prepared for the Upper Mississippi River Basin Commission, Minneapolis, MN.
141. Rasmussen, J. L. 1983. A Summary of Known Navigation Effects and a Priority List of Data Gaps for the Biological Effects of Navigation on the Upper Mississippi River. Prepared for US Army Corps of Engineers, Rock Island District under Letter Order No. NCR-LO-83-C9. Rock Island, IL., 96 pp.
142. Ritchie, J. C. 1972. Sediment, Fish, and Fish Habitat. *Journal of Soil and Water Conservation*, Vol 27: pp 124.
143. Robbins, W. H., and MacCrimmon, H. R. 1974. The Black Bass in America and Overseas. Biomangement Management and Research Enterprises, Sault Ste Marie, Canada.
144. Robinson, W. E., Wehling, W. E., and Morse, M. P. 1984. The Effect of Suspended Clay on Feeding and Digestive Efficiency of the Surf Clam, *Spisula solidissima* (Dillwyn). *Journal of Experimental Marine Biology and Ecology*, Vol 74, pp 1-12.
145. Rosen, R. A., and Hales, D. C. 1980. Occurrence of Scarred Paddlefish in the Missouri River, South Dakota-Nebraska. *The Progressive Fish-Culturist*, Vol 42, pp 82-85.
146. Rosenthal, H., and Alderdice, D. F. 1976. Sublethal Effects of Environmental Stressors, Natural and Pollutional, on Marine Fish Eggs and Larvae. *Journal of the Fisheries Research Board of Canada*, Vol 33, pp 2047-2065.
147. Salmon, A., and Green, R. H. 1983. Environmental Determinants of Unionid Clam Distribution in the Middle Thames River, Ontario. *Canadian Journal of Zoology*, Vol 61, pp 832-838.

148. Saunders, H. E. 1975. Hydrodynamics in Ship Design, Volume 2. Society of Naval Architects and Marine Engineers, N.Y.
149. Seagle, H. H., and Zumwalt, F. H. 1981. Evaluation of the Effects of Tow Passage on Aquatic Macroinvertebrate Drift in Pool 26, Mississippi River. Upper Mississippi River Basin Commission, Minneapolis, MN.
150. Sherk, J. A., O'Connor, J. M. and Neuman, D. A. 1972. Effect of Suspended and Deposited Sediments upon Estuarine Organisms, Phase I. Reference No. 72-9E, Natural Resource Institute, University of Maryland, Chesapeake Biological Laboratory, Solomon, MD.
151. Sherk, J. A., O'Connor, J. M. and Neuman, D. A. 1974. Effect of Suspended and Deposited Sediments upon Estuarine Organisms, Phase II. Reference No. 74-20, Natural Resource Institute, University of Maryland, Solomon, MD.
152. Sickel, J. 1980. Correlation of Unionid Mussels with Bottom Sediment Composition in the Altamaha River, Georgia. Bulletin of the American Malacological Union, for 1980 , pp 10-13.
153. Sigler, J. W., Bjornn, T. C. and Everest, F. H. 1983. Effects of Chronic Turbidity on Density and Growth of Steelheads and Coho Salmon. Transactions of the Fisheries Society, Vol 113, pp 142-150.
154. Simons, L. 1981. Water Quality in the Upper Mississippi River System Affected by Sediment Resuspended Due to Navigation Activities. Upper Mississippi River Basin Commission, Minneapolis, MN.
155. Simons, D. B., Chen, Y. H., Li, R. M., Ellis, S. S. 1981. Assistance in Evaluation of the Existing River Environment and in Assessment of Impacts of Navigation Activity on the Physical and Biological Environment In the Upper Mississippi River System. Contract Report for the Environmental Work Team, Upper Mississippi River Basin Commission, Minneapolis, MN.
156. Simons, D. B., Li, R. M., Chen, Y. H., Ellis, S. S. 1981. Working Paper 1 for Task C: Water Quality in the Upper Mississippi River System Affected by Sediment Resuspension Due to the Navigation Activities. Contract Report for the Environmental Work Team, Upper Mississippi River Basin Commission, Minneapolis, MN.
157. Simons, D. B., Li, R. M., Chen, Y. H., Ellis, S. S., and Chang, T. P. 1981. Working Paper 2 for Task D: Investigation of Effects of Navigation Traffic Activities on Hydrologic, Hydraulic, and Geomorphic Characteristics. Contract Report to the Environmental Work Team, Upper Mississippi River Basin Commission, Minneapolis, MN.

158. Smith, L. L., Kramer, R. H. and Oseid, D. M. 1966. Long Term Effects of Conifer-groundwood Paper Fiber on Walleyes. Transactions of the American Fisheries Society, Vol 95, pp 60-70.
159. Sorenson, D. L., McCarthy, M. M., Middle-Brooks, E. J., and Porcella, D. G. 1977. Suspended and Dissolved Solids Effects on Freshwater Biota: A Review. Environmental Research Laboratory, US EPA Report 600/3-7-042, Corvallis, OR.
160. Sorenson, R. M. 1967. Investigation of Ship-Generated Waves. Journal of Waterways and Harbor Division, ASCE 93 (WW1): 85-99, Paper 5102.
161. Sorenson, R. M. 1973. Water Waves Produced by Ships. Journal of Waterways, Harbors and Coastal Engineering Division, ASCE 99 (WW2), pp 245-256.
162. Sparks, R. E. 1975. Possible Biological Impacts of Wave Wash and Resuspension of Sediments Caused by Boat Traffic in the Illinois River. US Army Engineer District, St. Louis, St. Louis, MO.
163. Sparks, R. E., Bellrose, F. C., Paveglio, F. L., Sandusky, M. J., Steffeck, D. W., and Thompson, C. M. 1979. Fish and Wildlife Habitat Changes Resulting from Construction of a Nine-foot Channel on Pools 24, 25, and 26 of the Mississippi River and the Lower Illinois River. Illinois Natural History Survey, Havana, IL pp 215.
164. Sparks, R. E., Thomas, R. C., and Schaeffer, D. J. 1980. The Effects of Barge Traffic on Suspended Sediments and Turbidity in the Illinois River. Report for the US Fish and Wildlife Service, Rock Island Field Office, IL 68 pp.
165. Sparks, R. E., and Blodgett, K. D. 1985. Effects of Fleeting on Mussels. Report to the Illinois Department of Conservation, Aquatic Biology Technical Report, 1985 (8), of the Illinois Natural History Survey. 95 pp.
166. Stalmaster, M. V. and J. R. Newman. 1978. Behavioral Responses of Wintering Bald Eagles to Human Activity. Journal of Wildlife Management, Vol 42, pp 506-513.
167. Starrett, W. C. 1972. Man and the Illinois River. In: R.T. Oglesby, C.A. Carlson, and J.A. McCann (eds.), River Ecology and the Impact of Man. Academic Press, New York, NY.
168. Stefan, H. G., and Riley, M. J. 1985. Mixing of a Stratified River by Barge Tows. Water Resources Research, Vol 21, pp 1085-1094.
169. Stelczer, K. 1981. Bed Load Transport Theory and Practice. Water Resource Publications, Littleton, CO.
170. Stern, E. M., and Stickle, W. B. 1978. Effects of Turbidity and Suspended Material in Aquatic Environments. Technical Report D-78-21, US Army Engineer Waterways Experiment Station, Vicksburg, MS.

171. Stevenson, R. J., Mollow, J. M., Peterson, C. G., and Lewis, J. L. 1986. Laboratory Simulation of Navigation Traffic Physical Effects on River Plankton. A Report submitted to the US Army Engineer District, Louisville, Louisville, KY. Contract DACW27-85-R-0043.
172. Suloway, L. 1981. The Unionid (Mollusca:Bivalvia) Fauna of the Kankakee River in Illinois. *American Midland Naturalist*, Vol 105, pp 233-239.
173. Swenson, W. A., and Matson, M. L. 1976. Influence of Turbidity on Survival, Growth, and Distribution of Larval Lake Herring (*Coregonus artedii*). *Transactions of the American Fisheries Society*, Vol 105, pp 541-545.
174. Thompson, D.H. 1977. Declines in Populations of Colonial Waterbirds Nesting Within the Floodplain of the Upper Mississippi River. Pages 26-37 in W.E. Southern, Compiler. *Proceedings, 1977 Conference of the Colonial Waterbird Group*.
175. Thompson, D.H. and M.C. Landin. 1978. An Aerial Survey of Waterbird Colonies Along the Upper Mississippi River and the Interrelationship to Dredged Material Deposits. Technical Report D-78-13, US Army Engineer Waterways Experiment Station, Vicksburg, MS.
176. Thornburg, D.D. 1971. Flock Behavior of Diving Ducks on Keokuk Pool, Mississippi River. M.S. Thesis, Iowa State University, Ames, IO.
177. Thornburg, D.D. 1973. Diving Duck Movements on Keokuk Pool, Mississippi River. *Journal of Wildlife Management*, Vol 37, pp 382-389.
178. Tremblay, J., and L. N. Ellison. 1979. Effects of Human Disturbance on Breeding of Black-crowned Night Herons. *Auk*, Vol 96, pp 364-369.
179. Upper Mississippi River Basin Commission Environmental Work Team. 1981a. Comprehensive Master Plan for the Management of the Upper Mississippi River System: Draft Executive Summary to The Environmental Report," Prepared for the Upper Mississippi River Basin Commission. Data collection and synthesis. Contract by D. McGuiness and Assoc., Hastings, MN.
180. Upper Mississippi River Basin Commission Environmental Work Team. 1981b. Comprehensive Master Plan for the Management of the Upper Mississippi River System: Environmental Report (1st draft)," Prepared for the Upper Mississippi River Basin Commission. Data collection and synthesis prepared by D. McGuiness and Ass., Hastings, MN.
181. Upper Mississippi River Basin Commission Environmental Work Team. 1981c. Comprehensive Master Plan for The Management of the Upper Mississippi River System: Technical Report D-Environmental Report. Prepared for the Upper

- Mississippi River Basin Commission. Data collection and synthesis prepared by D. McGuinness and Ass., Hastings, MN.
182. US Fish and Wildlife Service. 1986. Draft Fish and Wildlife Coordination Act Report for Lock and Dam 26 (Replacement): Second Lock Environmental Impact Statement. Rock Island Ecological Services Field Office, IL.
 183. Van der Schalie, H. 1941. The Taxonomy Of Naiades Inhabiting a Lake Environment. Journal of Conchology, London, Vol 21, pp 246-253.
 184. Vinyard, G. L., and O'Brien, W. J. 1976. Effects of Light and Turbidity on the Reactive Distance of Bluegill (*Lepomis macrochirus*). Journal of the Fisheries Research Board of Canada, Vol 33, pp 2845-2849.
 185. Vos, D.K., Ryder R. A., and Graul W. D. 1985. Response of Breeding Great Blue Herons to Human Disturbance in North Central Colorado. Colonial Waterbirds, Vol 8, pp 13-22.
 186. Wallen, I. E. 1951. The Direct Effect of Turbidity on Fishes. Bulletin, Oklahoma Agricultural and Mechanical College, Vol 48, pp 1-27.
 187. Walne, P.R. 1972. The Influence of Current Speed, Body Size and Water Temperature on the Filtration Rate of Five Species of Bivalves. Journal of the Marine Biological Association of the United Kingdom, Vol 52, pp 345-374.
 188. Wang, J. C. S., and Tatham, T. R. 1971. A Study of the Relationship of Suspended Sediments and Fish Eggs in the Upper Chesapeake Bay and Its Contiguous Waters, with Special Reference to Striped Bass. Ichthyological Associates, Middle, DEL.
 189. Waters, T. F. 1972. The Drift of Stream Insects. Annual Review of Entomology, Vol 17, pp 253-272.
 190. Way, C. M., Hombach, Miller-Way, C. A., Payne, B. S., and Miller, A. C. 1989. Dynamics of Filter-feeding in *Corbicula fluminea* (Bivalvia: Corbiculidae). Canadian Journal of Zoology.
 191. Werschkul, D.F., E. McMahon and M. Leitschuh. 1976. Some Effects of Human Activities on the Great Blue Heron in Oregon. Wilson Bulletin, Vol 88, pp 660-662.
 192. Widdows, J. 1978. Physiological Indices of Stress in *Mytilus edulis*. Journal of the Marine Biological Association of the United Kingdom, Vol 58, pp 125-142.
 193. Widdows, J., Fieth, P., and Worrall, C. M. 1979. Relationship Between Seston, Available Food and Feeding Activity in the Common Mussel *Mytilus edulis*. Marine Biology, Vol 50, pp 195-207.
 194. Wilber, C. G. 1983. Turbidity in the Aquatic Environment. Charles C. Thomas Publisher, Springfield, IL.

195. Wright, T. D. 1982. Potential Biological Impacts of Navigation Traffic. Technical Report E-82-2, US Army Waterways Experiment Station, Vicksburg, MS.
196. Wuebben, J. L., Brown, W. M., and Zabilansky, L. J. 1984. Analysis of Physical Effects of Commercial Vessel Passage through the Great Lakes Connecting Channels. Cold Regions Research and Engineering Laboratory, Hanover, NH.
197. Yousef, Y.A., McLellon W. M., and Zebuth H. H. 1980. Changes in Phosphorous Concentrations Due to Mixing by Motorboats in Shallow Lakes. Water Research, Vol 14, pp 841-852.
198. Yousef, Y. A., McLellon, W. M., Fagan, R. H., Zebuth, H. H., and Larrabee, C. R. 1978. Mixing Effects due to Boating Activities in Shallow Lakes. Technical Report ESEI No. 78-1d, Florida Technical University Environmental Systems Engineering Institute, Orlando, FL.

Appendix E. Workshop attendees; their mailing address, telephone and telefax numbers, and e-mail address.

Last Name	First Name	Address	Phone	Fax	e-mail
Able	Kenneth	Rutgers University Marine Field Station 800 Great Bay Blvd. c/o 132 Great Bay Blvd. Tuckerton, NJ 08087-2004	609-296-5260, ext. 230	609-296-1024	able@artic.rutgers.edu
Barber	Ed	Narragansett Bay Keeper 434 Smith Street Providence, RI 02908-3770			
Bennett	Dery	American Littoral Society Sandy Hook Highlands, NJ 07732	908-291-0055	908-872-8041	
Carlisle	Bruce	Massachusetts Coastal Zone Management 100 Cambridge Street Boston, MA 02202	617-727-9800	617-723-5408	bruce.carlisle@state.ma.us
Caruso	Paul G.	Commonwealth of Massachusetts Division of Marine Fisheries 50 A. Portside Drive Pocasset, MA 02559	508-563-1779, ext. 107	508-563-5482	paul.caruso@state.ma.us
Celander	Malin	Biology Department WHOI Woods Hole, MA 02543	508-289-2368	508-457-2134	mcclander@whoi.edu
Crago	Tracy	Woods Hole Oceanographic WHOI Sea Grant Woods Hole, MA 02543	508-289-2665	508-457-2172	tcrago@whoi.edu
Crawford	Richard	Waquoit Bay National Estuarine Reserve P.O. Box 3092 Waquoit, MA 02536	508-457-0495	617-727-5537	whmerr@capecod.net
Dorsey	Eleanor	CLF 62 Summer Street Boston, MA 02110-1016	617-350-0990	617-350-4030	edorsey@clf.org
Douglas	Vaughn	Division of Federal Aid USF&W Service 300 Westgate Center Drive Hadley, MA 01035	413-253-8501	413-253-8487	vaughn.douglas@mail.fws.gov
Dunlap	Rob	S.C. Dept of Natural Resources DMR, P.O.Box 12599 Charleston, NC 29412	803-762-5067	803-762-5007	dunlapr@mrd.dnr.state.sc.us

Foster	Karen L.	Battelle Duxbury Operations 397 Washington Street Duxbury, MA 02332	781-934-0571	781-934-2124	
Harrington	Brian	Manomet Center for Conservation Sciences P.O.Box 1770 Manomet, MA 02345	508-224-6521	508-224-9220	bharr@manomet.org
Hinch	Kate	Center for Marine Conservation 1725 DeSales Street NW Washington, DC 20036	202-429-5609	202-872-0619	
Janik	David	Coastal Zone Management 20 Riverside Drive Lakeville, MA 02347	508-946-8990	508-946-2835	david.janik@state.ma.us
Joseph	James W.	Bureau of Shellfisheries P.O.Box 400 Trenton, NJ 08625-0400	609-984-5546	609-984-1408	
Kendall	Leslie	Marine Biomedicines & Environ. Science 221 Ft. Johnson Road Charleston, SC 29412	803-762-5540		
Klin	Thomas	Connecticut DEP Long Island Sound Programs 79 Elms Street Hartford, CT 06106-5127	1-800-767-8057	1-800-767-8057	keelhaulem@aol.com
Kruer	Curtis	4565 Louvinia Court Tallahassee, FL 32311	850-216-1894	850-216-1893	crkruer@aol.com
Leavitt	Dale F.	Sea Grant 193 Oyster Pond Road, MS #2 Woods Hole, MA 02543-1525	508-289-2997	508-457-2172	dleavitt@whoi.edu
Ludwig	F. Michael	NMFS Milford Laboratory 212 Rogers Avenue Milford, CT 06460	203-783-4228	203-783-4295	michael.ludwig@noaa.gov
Macfarlane	Sandra	Orleans Conservation Department 19 School Road Orleans, MA 02653	508-240-3700, ext. 425	508-240-3388	
Madin	Laurence	Biology Department WHOI Woods Hole, MA 02543	508-289-2321	508-457-2169	imadin@whoi.edu
McCarthy	George	Jerome Levy Economics Institute Bard College Annandale-on-Hudson, NY 12504	914-876-5620		mccarthy@levy.org
McLaughlin	Larry	USF, Education Outreach 4202 East Fowler Avenue, SVC 1072 Tampa, FL 33620-6910	813-974-2996	813-974-7272	mclaughl@eng.usf.edu

Mele	Andre	Hudson River Sloop Clear Water, Inc. 112 Market Street Poughkeepsie, NY 12601	914-454-7673	914-454-7953	andy@mail.clearwater.org
Moore	Kirk	313 Clairmore Avenue Lanoka Harbor, NJ 08734	609-597-7000	609-597-0355	kirkm@injersey.com
Moore	Michael	Biology Department WHOI Woods Hole, MA 02543	508-298-3228	508-457-2169	mmoore@whoi.edu
Podlich	Margaret	U.S. Clean Water Trust 880 South Pickett Street Alexandria, Virginia 22304	703-823-9550	703-461-2855	cleanh2o@erols.com
Roesler	Jody	Waterway Resources Division Maryland Department of Natural Resources Tawes Building, E-2 Annapolis, MD 21401	410-260-8775 or 410-260-8770	410-260-8779	
Russell	Jenny	Island Foundation, Inc. 589 Mill Street Marion, MA 02738-1553	508-748-2809	508-748-0991	jrussell2@capecod.net
Satchwill	Richard	Coastal Fisheries Lab 1231 Succotash Road, RR#1 Wakefield, RI 02879	401-783-2304 or 401-789-7693	401-783-2760	
Sherwood	Lynn	Division of Marine Fisheries South Shore Office 50A Portside Drive Prossett, MA 02559	508-563-1779, ext. 124 617-727-0394, ext. 124	508-563-5482	lynn.sherwood@state.ma.us
Smith	Jan Peter	Massachusetts Bays National Estuary Prog. Mass CZM 100 Cambridge Street Boston, MA 02202	617-727-9530, ext. 419	617-723-5408	jan.smith@state.ma.us
Stolpe	Nils	3840 Terwood Drive Doylestown, PA 18901	215-345-4790	215-345-4869	njsha@voicenet.com
Tanski	Jay	New York Sea Grant Extension 146 Suffolk Hall SUNY at Stony Brook Stony Brook, NY 11794-5002	516-632-8730	516-632-8216	sgstonyb@cce.cornell.edu
Taylor	Jo Ann	Martha's Vineyard Commission P.O. Box 1447 Oak Bluffs, MA 02557	508-693-3453	508-693-7894	jo-ann.taylor@state.ma.us
Taylor	William	Town of East Hampton/Montauk 159 Pantigo Road East Hampton, NY 11937	516-329-3078		
Torgan	John	Narragansett Baykeeper 434 Smith Street Providence, RI 02908-3770	401-272-3540	401-273-7153	savebay@savethebay.org

Tucker	Robert	NIDEP, Science and Research 401 East State Street, CN 409 Trenton, NJ 08625	609-984-6020	609-292-7340	
Weis	Peddrick	Department of Anatomy University of Medicine & Dentistry of NJ 185 South Orange Avenue Newark, NJ 07103	973-972-4409	973-972-7489	weis@umdnj.edu
Withur	Jay	Town of Vineyard Haven P.O.Box 1237 Vineyard Haven, MA 02568	508-693-7792	508-693-5876	
Woodin	Bruce	Biology Department WHOI Woods Hole, MA 02543	508-289-3227	508-457-2134	bwoodin@whoi.edu or bwoodin@mit.edu

DOCUMENT LIBRARY

Distribution List for Technical Report Exchange – September 1997

University of California, San Diego
SIO Library 0175C
9500 Gilman Drive
La Jolla, CA 92093-0175

Hancock Library of Biology & Oceanography
Alan Hancock Laboratory
University of Southern California
University Park
Los Angeles, CA 90089-0371

Gifts & Exchanges
Library
Bedford Institute of Oceanography
P.O. Box 1006
Dartmouth, NS, B2Y 4A2, CANADA

NOAA/EDIS Miami Library Center
4301 Rickenbacker Causeway
Miami, FL 33149

Research Library
U.S. Army Corps of Engineers
Waterways Experiment Station
3909 Halls Ferry Road
Vicksburg, MS 39180-6199

Institute of Geophysics
University of Hawaii
Library Room 252
2525 Correa Road
Honolulu, HI 96822

Marine Resources Information Center
Building E38-320
MIT
Cambridge, MA 02139

Library
Lamont-Doherty Geological Observatory
Columbia University
Palisades, NY 10964

Library
Serials Department
Oregon State University
Corvallis, OR 97331

Pell Marine Science Library
University of Rhode Island
Narragansett Bay Campus
Narragansett, RI 02882

Working Collection
Texas A&M University
Dept. of Oceanography
College Station, TX 77843

Fisheries-Oceanography Library
151 Oceanography Teaching Bldg.
University of Washington
Seattle, WA 98195

Library
R.S.M.A.S.
University of Miami
4600 Rickenbacker Causeway
Miami, FL 33149

Maury Oceanographic Library
Naval Oceanographic Office
Building 1003 South
1002 Balch Blvd.
Stennis Space Center, MS, 39522-5001

Library
Institute of Ocean Sciences
P.O. Box 6000
Sidney, B.C. V8L 4B2
CANADA

National Oceanographic Library
Southampton Oceanography Centre
European Way
Southampton SO14 3ZH
UK

The Librarian
CSIRO Marine Laboratories
G.P.O. Box 1538
Hobart, Tasmania
AUSTRALIA 7001

Library
Proudman Oceanographic Laboratory
Bidston Observatory
Birkenhead
Merseyside L43 7 RA
UNITED KINGDOM

IFREMER
Centre de Brest
Service Documentation - Publications
BP 70 29280 PLOUZANE
FRANCE

REPORT DOCUMENTATION PAGE	1. REPORT NO. WHOI-98-03	2.	3. Recipient's Accession No.
4. Title and Subtitle The Environmental Impacts of Boating; Proceedings of a Workshop held at Woods Hole Oceanographic Institution, Woods Hole MA USA, December 7 to 9, 1994.			5. Report Date March 1998
7. Author(s) Edited by: Richard E. Crawford, Nils E. Stolpe and Michael J. Moore			6.
8. Performing Organization Rept. No. WHOI-98-03			8. Performing Organization Rept. No. WHOI-98-03
9. Performing Organization Name and Address Woods Hole Oceanographic Institution Woods Hole, Massachusetts 02543			10. Project/Task/Work Unit No.
2. Sponsoring Organization Name and Address Rinehart Coastal Research Center of the Woods Hole Oceanographic Institution and the Mobil Foundation			11. Contract(C) or Grant(G) No. (C) (G)
			13. Type of Report & Period Covered Technical Report
15. Supplementary Notes This report should be cited as: Woods Hole Oceanog. Inst. Tech. Rept., WHOI-98-03.			14.
16. Abstract (Limit: 200 words) Substantiated impacts of boating activity discussed at this workshop include: sediment and contaminant resuspension and resultant turbidity; laceration of aquatic vegetation with loss of faunal habitat and substrate stability; toxic effects of chemical emissions of boat engines; increased turbulence; shearing of plankton; shorebird disturbance; and the biological effects of chemically treated wood used in dock and bulkhead construction. These discussions revealed that many of the issues of concern remain inadequately defined and described. But sufficient hard data was referred to or presented to substantiate the inference that recreational and commercial motor boat operation is far from a benign influence on aquatic and marine environments. This is particularly so in temperate climates due to the unfortunate synchrony, with only a few exceptions, between the peak seasons for boating and the occurrence of planktonic embryonic and larval stages of vertebrates and invertebrates in estuaries and coastal waters. Therefore, the chance of plants and organisms being affected by power boat operation appears to be substantial in shallow, heavily used boating areas such as those along the entire U.S. eastern and Gulf coasts. As such, motor boat operation should be conducted and managed in such a manner as to minimize those impacts.			
17. Document Analysis a. Descriptors boating impacts turbidity pollution b. Identifiers/Open-Ended Terms c. COSATI Field/Group			
18. Availability Statement Approved for public release; distribution unlimited.		19. Security Class (This Report) UNCLASSIFIED	21. No. of Pages 206
		20. Security Class (This Page)	22. Price