

NOAA Technical Memorandum NMFS-NWFSC-42



Viable Salmonid Populations and the Recovery of Evolutionarily Significant Units

June 2000

U.S. DEPARTMENT OF COMMERCE
National Oceanic and Atmospheric Administration
National Marine Fisheries Service

NOAA Technical Memorandum NMFS Series

The Northwest Fisheries Science Center of the National Marine Fisheries Service, NOAA, uses the NOAA Technical Memorandum NMFS series to issue informal scientific and technical publications when complete formal review and editorial processing are not appropriate or feasible due to time constraints. Documents published in this series may be referenced in the scientific and technical literature.

The NMFS-NWFSC Technical Memorandum series of the Northwest Fisheries Science Center continues the NMFS-F/NWC series established in 1970 by the Northwest & Alaska Fisheries Science Center, which has since been split into the Northwest Fisheries Science Center and the Alaska Fisheries Science Center. The NMFS-AFSC Technical Memorandum series is now being used by the Alaska Fisheries Science Center.

Reference throughout this document to trade names does not imply endorsement by the National Marine Fisheries Service, NOAA.

This document should be cited as follows:

McElhany, P., M.H. Ruckelshaus, M.J. Ford, T.C. Wainwright, and E.P. Bjorkstedt. 2000. Viable salmonid populations and the recovery of evolutionarily significant units. U.S. Dept. Commer., NOAA Tech. Memo. NMFS-NWFSC-42, 156 p.

Viable Salmonid Populations and the Recovery of Evolutionarily Significant Units

Paul McElhany, Mary H. Ruckelshaus, Michael J. Ford, Thomas C.
Wainwright, and Eric P. Bjorkstedt*

Northwest Fisheries Science Center
Conservation Biology Division
2725 Montlake Boulevard East
Seattle, Washington 98112-2097

*Southwest Fisheries Science Center
Santa Cruz/Tiburon Laboratory, Salmon Analysis Branch
3150 Paradise Drive
Tiburon, California 94920-1211

June 2000

U.S. DEPARTMENT OF COMMERCE

William M. Daley, Secretary

National Oceanic and Atmospheric Administration

D. James Baker, Administrator

National Marine Fisheries Service

Penelope D. Dalton, Assistant Administrator for Fisheries

Most NOAA Technical Memorandums NMFS-NWFSC are available on-line at the Northwest Fisheries Science Center web site (<http://www.nwfsc.noaa.gov>)

Copies are also available from:
National Technical Information Service
5285 Port Royal Road
Springfield, VA 22161
phone orders (1-800-553-6487)
e-mail orders (orders @ntis.fedworld.gov)

Table of Contents

List of Figures	vii
List of Tables	ix
List of Boxes	xi
EXECUTIVE SUMMARY	xiii
DEFINING A VIABLE SALMONID POPULATION 1	
Introduction.....	1
Purpose and Scope	1
Definitions	2
Short-term Risk Evaluations	4
Population concepts.....	4
General definitions	4
Definition of a population that NMFS will use in applying the VSP concept.....	5
Distinction between Population Definition and Tools for Estimation.....	6
Structure below and above population level.....	6
Borderline situations in defining populations	7
Relationship of the Population Definition to the ESU Definition.....	7
Population Definition and Artificial Propagation.....	9
PARAMETERS FOR EVALUATING POPULATIONS 11	
Introduction to Parameters.....	11
Population parameters.....	11
Guidelines for each population parameter	11
Population Size.....	12
Population Growth Rate and Related Parameters	13
Spatial Structure	18
Diversity.....	19
Integrating the parameters and determining population status.....	23
ESU VIABILITY 25	
Introduction.....	25
Number and Distribution of Populations in a Recovered ESU.....	25
Populations not meeting VSP guidelines	27
IMPLEMENTING THE VSP GUIDELINES 29	
Introduction.....	29
Practical Application.....	29
Uncertainty, Precaution, and Adaptive Management.....	29
Interim Application.....	30
Examples	31
APPENDIX 33	
Applying VSP in the Regulatory Arena.....	33
Listing Criteria	33
Recovery.....	34
Jeopardy	35
Relationship of VSP to Other Concepts.....	35
Relationship to Minimum Viable Population Concepts.....	35
Relationship to Quantitative Population Viability Analysis	36
Relationship to Properly Functioning Conditions	36

Relationship to the Sustainable Fisheries Act (SFA) and Maximum Sustainable Yield (MSY).....	37
Relationship to Other Conservation Assessment Approaches	38
Identifying Populations	38
Introduction to identifying populations.....	38
Types of Information Used in Identifying Populations.....	38
Evidence for independent populations	39
Indicators of population structure	41
Geographic and habitat indicators.....	44
Demographic indicators	46
Genetic indicators.....	49
Identifying populations—combining the evidence	51
Existing Approaches to Identifying Salmon Populations or Groups	51
Population Size.....	53
Introduction.....	53
Density effects.....	54
Environmental variation.....	57
Genetic processes	58
Demographic stochasticity.....	61
Ecological feedback	62
Assessment Methods.....	63
Guidelines.....	64
Population Growth Rate and Related Parameters	64
Introduction.....	64
Why population growth rate is important	67
Why intrinsic productivity and density dependence are important.....	68
Why stage-specific productivity is important	69
Why ancillary data relevant to productivity are important	73
Estimating Population Growth Rate and Related Parameters.....	77
Estimating population growth rate and changes in other parameters.....	78
Estimating population growth rate and detecting trends.....	79
Detecting other pattern in time series: autocorrelation, interventions, and epochs	80
Estimating intrinsic productivity and detecting density dependence.....	81
Critical assumptions	81
Bias and methods for correcting it	82
Analyses that incorporate stage-specific dynamics.....	83
Analyses of populations that include naturally spawning hatchery fish...	84
Spatial Structure	90
Introduction.....	90
General Spatial Patterns	91
Why Spatial Structure is Important	91
Metapopulation theory.....	91
Source-sink dynamics	94
Importance of patch spacing.....	96
Fragmented habitats	97

Assessing Spatial Structure	97
Straying	97
Habitat dynamics	98
VSP Guidelines: Spatial Structure	101
Diversity.....	101
Types of Diversity.....	101
Why Diversity is Important.....	102
Factors that Affect Diversity.....	102
Risks to Diversity.....	105
Selection.....	108
Straying and gene flow.....	114
VSP Guidelines: Diversity.....	122
Viable ESUs	124
Catastrophes.....	124
Long-term Demographic and Evolutionary Processes.....	125
ESU Viability Guidelines.....	126
LITERATURE CITED	127

List of Figures

Figure 1. This figure illustrates why subpopulations, populations, and ESUs are likely to have a biological basis.....	8
Figure 2. Theoretical types of spatially structured populations.....	20
Figure A1a. Distributions of dispersal distances of eelgrass (<i>Zostera marina</i>) based on pollen and seed dispersal.....	42
Figure A1b. Frequency distributions of pollen, seed and combined pollen and seed dispersal estimated by identifying and mapping seedlings and parents.....	43
Figure A2. The figure shows why demographic independence is theoretically a useful factor in designating populations.....	47
Figure A3. Typical shape of parent-offspring (or stock-recruit) curves for populations with no density-dependence (“Linear”), compensation only, and compensation plus depensation.	55
Figure A4. Estimates of spawner:spawner production for Oregon coastal coho salmon (<i>Oncorhynchus kisutch</i>) in three GCGs.	70
Figure A5. Estimates of pre-harvest-recruit:spawner production for Oregon coastal coho salmon (<i>Oncorhynchus kisutch</i>) in three GCGs.	71
Figure A6. Estimates of exploitation rates for three GCGs (North-Mid Coast, Umpqua, Mid-South Coast) of Oregon coastal coho salmon (<i>Oncorhynchus kisutch</i>) and estimated total exploitation rate for coho salmon in the Oregon Production Index Area based on analyses of coded wire tag recoveries.....	72
Figure A7. Changes in parameters of a composite Beverton-Holt model for smolt yield as a function of prespawner abundance for four putative life-history variants of spring chinook salmon (<i>Oncorhynchus tshawytscha</i>) in the Grande Ronde River.	74
Figure A8. Mean weights of coho salmon from rivers on the outer coast of Washington State. Rivers are listed in order from south to north.	75
Figure A9. Mean weights of coho salmon from rivers in Puget Sound. Rivers are listed in order from north to south.	76
Figure A10. Estimated spawner escapement for Wenatchee River summer steelhead (<i>O. mykiss</i>), and Natural Return Ratio (NRR) calculated for a range of values describing the relative reproductive successes of hatchery- and natural-origin spawners.	87
Figure A11. Examples of Ricker-type spawner-recruit models that include the influence of naturally spawning hatchery fish in different ways, fitted to data for Wenatchee River summer steelhead (<i>Oncorhynchus mykiss</i>) for 1984-1994.....	88
Figure A12. Theoretical types of spatially structured populations.	92
Figure A13. Productivity estimated as spawners per spawner by index reach for coho in the Snohomish River, WA.	95
Figure A14. Map of probable spring chinook spawning areas in the Grande Ronde basin.....	99
Figure A11-3a. Percent dead and infected with <i>C. Shasta</i> after 86 days of exposure.....	107

Figure A12-1a. Mean spawn timing of Trask Hatchery coho.....	109
Figure A12-1b. Average daily streamflow for the Nestucca, Siletz, Yaquina, Alsea, and Siuslaw river basins, November through April.....	110
Figure A12-2a. Discriminant scores of morphological variation between wild and hatchery female coho salmon.....	111
Figure A12-3a. The proportion of smolts that were age 1+ by year of migration, and the observed numbers of yearling and two-year-old smolts by year of migration.....	113
Figure A13-1a. Approximate relationship between G_{ST} and N_m at equilibrium.	116
Figure A13-2a. Frequency of the A allele in population 1 with $m_I = 0.2$ or $m_I = 0.05$	118
Figure A14-2a. Time series of allele frequency data at six gene loci for fall chinook salmon from the Snake and upper Columbia Rivers.	120
Figure A14-3a. Days to death by ceratomyxosis from initial exposure of rainbow trout to <i>Ceratomyxa shasta</i> , 1989 and 1990.....	121

List of Tables

Table A1. Estimates of straying (the percentage of marked fish returning to a location other than that in which it was marked) for Pacific salmonids.....	40
Table A11-2a. (Data from Raleigh 1971, Table 1.).....	106

List of Boxes

Box A1. Assigning “resident” and anadromous salmonids to populations.	45
Box A2. Viable Population Size Guidelines	65
Box A3. Critical Population Size Guidelines.....	66
Box A4. Incorporating stage-specific productivity data in evaluations of abundance and productivity trends: harvest estimates for coho salmon (<i>Oncorhynchus kisutch</i>) from coastal Oregon.	70
Box A5. Population dynamics in stage-structured populations and the fate of different life histories in a population.	74
Box A6. Example of ancillary data relevant to population viability: trends in size of coho salmon from different regions.....	75
Box A7. Estimating productivity in populations that include naturally spawning hatchery fish.	85
Box A8. Population growth rate and related parameters guidelines.....	89
Box A9. Spatial Structure Guidelines.....	100
Box A10. Examples of Diversity. Below are three brief examples illustrating trait diversity within and among populations of chinook salmon.....	103
Box A11. Examples of adaptive diversity.....	106
Box A12. Human caused selection.	109
Box A13. Models of genetic variation among populations.....	116
Box A14. Examples of loss of diversity or adaptation due to human-caused gene flow alteration.	119
Box A15. Diversity guidelines.....	123
Box A16. ESU viability guidelines.....	126

EXECUTIVE SUMMARY

This document introduces the viable salmonid population (VSP) concept, identifies VSP attributes, and provides guidance for determining the conservation status of populations and larger-scale groupings of Pacific salmonids. The concepts outlined here are intended to serve as the basis for a general approach to performing salmonid conservation assessments. As a specific application, the VSP approach is intended help in the establishment of Endangered Species Act (ESA) delisting goals. This will aid in the formulation of recovery plans and can serve as interim guidance until such plans are completed.

The approach of the VSP concept and this document is to define a viable population, describe techniques for determining population boundaries, identify parameters useful in evaluating population viability and then set guidelines for assessing population viability status with regard to each of the parameters. Finally guidelines are provided on how to relate individual population viability to the viability of the Evolutionarily Significant Unit (ESU) as whole. The document is based primarily on a review and synthesis of the conservation biology and salmonid literature. A large portion of the document is an appendix devoted to describing the technical rationale behind the population definition and viability guidelines.

We define a viable salmonid population as an independent population of any Pacific salmonid (genus *Oncorhynchus*) that has a negligible risk of extinction due to threats from demographic variation, local environmental variation, and genetic diversity changes over a 100-year time frame. We define an independent population as any collection of one or more local breeding units whose population dynamics or extinction risk over a 100-year time period are not substantially altered by exchanges of individuals with other populations. In other words, if one independent population were to go extinct, it would not have much impact on the 100-year extinction risk experienced by other independent populations. Independent populations are likely to be smaller than a whole ESU.

Population identification is the first step for a VSP analysis. The best method for identifying independent populations uses direct observations of trends in abundance or productivity from groups of fish with known inter-group stray rates. However, such data are rarely available, and proxy evidence must be used to identify population boundaries. Such evidence could include geographic and habitat indicators, demographic indicators and genetic indicators (both neutral molecular markers and quantitative traits). The availability and usefulness of each of these indicators will vary by ESU.

Four parameters form the key to evaluating population viability status. They are abundance, population growth rate, population spatial structure, and diversity. The NMFS focuses on these parameters for three reasons. First, they are reasonable predictors of extinction risk (viability). Second, they reflect general processes that are important to all populations of all species. Third, the parameters are measurable. To facilitate evaluation of populations, we provide a collection of viability guidelines based on our interpretation of currently available data and literature. As with all scientific endeavors, these guidelines can be modified as new data, more rigorous analysis and clearer interpretations are generated.

Abundance is recognized as an important parameter because, all else being equal, small populations are at greater risk of extinction than large populations, primarily because several processes that affect population dynamics operate differently in small populations than they do in large populations. These processes are deterministic density effects, environmental variation, genetic processes, demographic stochasticity, ecological feedback, and catastrophes. Guidelines relating minimum abundance to each of these processes are provided at both the “viable” and “critical” level, where a critical level implies a high risk of extinction over a short time period.

Population growth rate (i.e., productivity over the entire life cycle) and factors that affect population growth rate provide information on how well a population is “performing” in the habitats it occupies during the life cycle. Estimates of population growth rate that indicate a population is consistently failing to replace itself are an indicator of increased extinction risk. Although our overall focus is on population growth rate over the entire life cycle, estimates of stage-specific productivity—particularly productivity during freshwater life-history stages—are also important to comprehensive evaluation of population viability. Other measures of population productivity, such as intrinsic productivity and the intensity of density-dependence may provide important information for assessing a population’s viability. The guidelines for population growth rate are closely linked with those for abundance.

When evaluating population viability, it is important to take within-population spatial structure needs into account for two main reasons: 1) Because there is a time lag between changes in spatial structure and species-level effects, overall extinction risk at the 100-year time scale may be affected in ways not readily apparent from short-term observations of abundance and productivity, and 2) population structure affects evolutionary processes and may therefore alter a population’s ability to respond to environmental change. Spatially structured populations in which “subpopulations” occupy “patches” connected by some low to moderate stray rates are often generically referred to as “metapopulations.” A metapopulation’s spatial structure depends fundamentally on habitat quality, spatial configuration, and dynamics as well as the dispersal characteristics of individuals in the population. Pacific salmonids are generally recognized as having metapopulation structure and the guidelines for spatial structure describe general rules of thumb regarding metapopulation persistence.

Several salmonid traits exhibit considerable diversity within and among populations, and this variation has important effects on population viability. In a spatially and temporally varying environment, there are three general reasons why diversity is important for species and population viability. First, diversity allows a species to use a wider array of environments than they could without it. Second, diversity protects a species against short-term spatial and temporal changes in the environment. Third, genetic diversity provides the raw material for surviving long-term environmental change. In order to conserve the adaptive diversity of salmonid populations, it is essential to 1) conserve the environment to which they are adapted, 2) allow natural process of regeneration and disturbance to occur, and 3) limit or remove human-caused selection or straying that weakens the adaptive fit between a salmonid population and its environment or limits a population's ability to respond to natural selection.

The ESA is not concerned with the viability of populations per se, but rather with the extinction risk faced by an entire ESU. A key question is how many and which populations are

necessary for a sustainable ESU. Three factors need to be considered when relating VSPs to viable ESUs: 1) catastrophic events, 2) long-term demographic processes, and 3) long-term evolutionary potential. We provide a number of guidelines related to these factors with an emphasis on risks from catastrophic events.

The guidelines presented here are intentionally general so they can be applied equally across the wide spectrum of life-history diversity, habitat conditions, and metapopulation structures represented by Pacific salmon. It is left to Technical Recovery Teams and other efforts to develop ESU-specific quantitative delisting criteria based on the principles outlined in VSP. A main concern in translating the guidelines into specific criteria will be the degree of uncertainty in much of the relevant information. Because of this uncertainty, management applications of VSP should employ both a precautionary approach and adaptive management. The precautionary approach suggests that VSP evaluations should error on the side of protecting the resource and adaptive management suggests that management activities should be used as a means of collecting more data to improve the quality of a VSP evaluation.

DEFINING A VIABLE SALMONID POPULATION

Introduction

This document introduces the viable salmonid population (VSP) concept, identifies VSP attributes, and provides guidance for determining the conservation status of populations and larger-scale groupings of Pacific salmonids. The concepts outlined here are intended to serve as the basis for a general approach to performing salmonid conservation assessments. Pacific salmonid risk evaluations can occur at small, local scales or over larger geographic regions—depending on the salmon management entities involved and the purpose of the risk assessment. In this document, we focus on conservation assessments of salmonid populations and Evolutionarily Significant Units (ESUs) because there is an immediate need for such evaluations under the Endangered Species Act (ESA)—a concern that the National Marine Fisheries Service (NMFS) must address. This document is divided into two main sections: 1) an initial discussion of the general concepts underlying the notion of a VSP, and 2) a detailed appendix where we provide technical details to support population identification, population parameter guidelines, and specific examples of how the guidelines pertain to salmonids.

We have confidence in the conceptual foundations underlying both the notion of a VSP and what critical elements should be evaluated when determining viability at the population and ESU scales. However, the approach to applying the VSP concept itself is still in the development stage and is likely to change with experience. We expect that the means of identifying population boundaries and establishing guidelines for population parameters will continue to be refined as further empirical data and modeling efforts are brought to bear on these important issues.

Purpose and Scope

The National Marine Fisheries Service (NMFS) is responsible for evaluating the status of certain salmonids and other marine species under the Endangered Species Act (ESA).¹ For species listed under the ESA, NMFS must determine whether particular management actions are likely to appreciably reduce the species' likelihood of survival and recovery in the wild. NMFS must also guide other entities in fulfilling listed species' needs and in taking actions necessary to recover them to self-sustaining levels. The purpose of this document is to provide an explicit framework for identifying attributes of viable salmonid populations so that parties may assess the effects of management and conservation actions and ensure that their actions promote the listed species' survival and recovery. The VSP concept and the criteria presented in this document are

¹ NMFS shares ESA jurisdiction with the U.S. Fish and Wildlife Service (FWS) and generally retains ESA authority over species that spend a majority of their lives in the marine environment, including anadromous Pacific salmonids (FWS and NMFS 1974). In some cases, NMFS may possess ESA authority over salmonid species that spend all or most of their life histories in freshwater as well. Consequently, the concepts contained in this document are intended to apply broadly to all Pacific salmonid species under NMFS' ESA jurisdiction.

intended both to help formulate recovery plans and to serve as interim guidance until such plans are completed.

When making listing decisions regarding Pacific salmonids (members of the genus *Oncorhynchus*), it is NMFS' policy to list ESUs as "distinct population segments" under the Act. However, there is wide recognition among NMFS, other agencies, and independent scientists for the need to undertake conservation actions at scales smaller than the ESU (Waples 1991c, NMFS 1991, WDF et al. 1993, Kostow 1995, Allendorf et al. 1997). The population is at an appropriate level for examining many extinction processes. As a consequence, the viability analyses discussed in this document are applied primarily at the scale of what are called independent populations, which will almost always be smaller than the scale of an ESU (see the following section "Definitions"). We define population performance measures in terms of four key parameters: abundance, population growth rate, spatial structure, and diversity. We then relate performance and risks at the population scale to risks affecting the persistence of entire ESUs.

The VSP concept consists primarily of two components: 1) Principles for identifying population substructure in Pacific salmonid ESUs, and 2) general principles for establishing biological guidelines to evaluate the conservation status of these populations and, therefore, of entire ESUs. The diversity of salmonid species and populations makes it impossible to set narrow quantitative guidelines that will fit all populations in all situations. The concepts and guidelines outlined in this document are therefore fairly general in nature. More specific guidelines can only be determined through detailed analyses of case-specific information on particular regions and particular species. As of Spring 2000, the concepts outlined in this VSP document have been applied to salmonid conservation planning in the upper Columbia River geographic region (Ford et al. 1999a). Populations have been identified for listed spring-run chinook salmon and steelhead in the upper Columbia River ESUs. Viability targets at the population and ESU levels have been established for both species in the Quantitative Analytical Report (QAR) (Ford et al. 1999a). The "QAR" document was the result of the efforts of a multi-agency team of scientists convened to provide an evaluation of the effects of the Columbia River hydrosystem on ESA-listed Upper Columbia River spring chinook salmon and steelhead. This VSP document provides a conceptual overview of important factors to consider in evaluating the viability of salmonid populations and ESUs. The QAR document offers concrete examples of how the general concepts outlined in VSP might be applied. As further applications of VSP concepts are completed, we expect that more quantitative and general viability guidelines will emerge.

Definitions

A viable salmonid population (VSP)² is an independent population of any Pacific salmonid (genus *Oncorhynchus*) that has a negligible risk of extinction due to threats from demographic variation (random or directional), local environmental variation, and genetic diversity changes (random or directional) over a 100-year time frame. Other processes

² Note that some early drafts of this document used the term "properly functioning population" or "PFP" in place of VSP. We believe the term "viable population" more accurately reflects the authors' intent, which is to describe the population attributes necessary to ensure long-term species survival in the wild.

contributing to extinction risk (catastrophes and large-scale environmental variation) are also important considerations, but by their nature they need to be assessed at the larger temporal and spatial scales represented by ESUs or other entire collections of populations.

The crux of the population definition used here is what is meant by “independent.” An independent population is any collection of one or more local breeding units whose population dynamics or extinction risk over a 100-year time period is not substantially altered by exchanges of individuals with other populations. In other words, if one independent population were to go extinct, it would not have much impact on the 100-year extinction risk experienced by other independent populations. Independent populations are likely to be smaller than a whole ESU and they are likely to inhabit geographic ranges on the scale of entire river basins or major sub-basins. The rationale underlying these definitions will be discussed further in “Population Concepts” (p. 4).

While it is ultimately an arbitrary decision, the 100-year time scale was chosen to represent a “long” time horizon for evaluating extinction risk. It is necessary to evaluate extinction risk at a long time scale for several reasons. First, many recovery actions (such as habitat restoration) are likely to affect population status over the long term. Second, many genetic processes important to population function (such as the loss of genetic diversity or accumulation of deleterious mutations) occur over decades or centuries and current actions can affect these processes for a long time to come. Third, at least some environmental cycles occur over decadal (or longer) time scales (e.g., oceanic cycles—Beamish and Bouillon 1993, Mantua et al. 1997, Hare et al. 1999). Thus, in order to evaluate a population's status it is important to look far enough into the future to be able to accommodate large-scale environmental oscillations and trends.

Note that choosing a time scale of 100 years does not mean that we believe it is possible to predict with great precision a population's status that far into the future. Nonetheless, we can describe those population attributes necessary for a species' long-term persistence. (This is discussed in more detail in Part 2.) Although our time frame for evaluating population viability is 100 years, we recognize and expect that many management actions and their subsequent monitoring will occur over much shorter time scales, and some evolutionary and large-scale demographic processes that can affect ESU viability will occur over much greater time periods. One hundred years was chosen as a reasonable compromise: it is long enough to encompass many long-term processes, but short enough to feasibly model or evaluate. It is worth noting that quantitative and qualitative conservation assessments for other species have often used a 100-year time frame in their extinction risk evaluations (Morris et al. 1999).

Although a population is the appropriate unit of study for many biological processes, it may also be appropriate to evaluate management actions that affect units at smaller or larger spatial and temporal scales. For example, ocean harvest plans may affect multiple-populations, while a habitat restoration plan may only affect a small portion of a single population's habitat. The VSP concept does not preclude establishment of goals at these different scales. However, management actions ultimately need to be related to population and ESU viability.

Short-term Risk Evaluations

In addition to evaluating population viability over long time periods, it is often important to analyze short-term risks relating to population or species persistence. In particular, a number of management decisions made at local, state, and federal levels are based on whether an action will have a significant effect on salmonid population viability over short time spans (e.g., 10 or fewer years). For example, in its decision on the 1995 Hydropower Biological Opinion, NMFS established critical abundance thresholds below which the short-term survival of a population is believed to be in considerable doubt. In another instance, federal, state, and tribal entities had to determine the abundance levels at which a population is at such a high risk of extinction that a captive broodstock program is needed in order to rebuild it (NMFS 1995b—Snake River Salmon Recovery Plan). In most cases, a “critical” population status implies a high risk of extinction over a short time period. In situations where such critical thresholds need to be established, the same population parameters used in determining whether a salmonid population is viable should be considered. In other words, evaluating whether a population is “critical” should involve assessing its abundance, population growth rate, population structure, and diversity. Clearly, the values of the four parameters in a critical population would be lower or less functional than those in a viable population. In “Population Size” (p. 12) we describe guidelines for using abundance to evaluate critical population status.

Population Concepts

General Definitions

In common biological usage, a population is broadly defined as a group of organisms. For example, the Third Edition of the American Heritage Dictionary defines the ecological usage of a population as “all the organisms that constitute a specific group or occur in a specified habitat.” Other common definitions include “any specified reproducing group of individuals” (Chambers Science and Technology Dictionary) and “any group of organisms of the same species living in a specific area” (Academic Press Dictionary of Science and Technology). A common definition of a population from ecology and population biology textbooks may be summarized as “a group of organisms of the same species that occupy the same geographic area during the same time” (e.g., McNaughton and Wolf 1973, Ehrlich and Roughgarden 1987). Thus, the definition of a population is clearly broad enough to be tailored to specific applications. For example, theoretical population genetic models often make use of a panmictic population, defined as a group of individuals that randomly interbreed every generation (e.g., Crow and Kimura 1970). In an evolutionary context, a population is “a group of organisms, usually a group of sexual organisms that interbreed and share a gene pool” (Ridley 1996). In other situations, it may be useful to define populations much more broadly, up to and including entire species (e.g., Ehrlich and Roughgarden 1987).

Definition of a Population NMFS Will Use in Applying the VSP Concept

In the VSP context, NMFS defines an independent population much along the lines of Ricker's (1972) definition of a "stock." That is, "an independent population is a group of fish of the same species that spawns in a particular lake or stream (or portion thereof) at a particular season and which, to a substantial degree, does not interbreed with fish from any other group spawning in a different place or in the same place at a different season." For our purposes, not interbreeding to a "substantial degree" means that two groups are considered to be independent populations if they are isolated to such an extent that exchanges of individuals among the populations do not substantially affect the population dynamics or extinction risk of the independent populations over a 100-year time frame. The exact level of reproductive isolation that is required for a population to have substantially independent dynamics is not well understood, but some theoretical work suggests that substantial independence will occur when the proportion of a population that consists of migrants is less than about 10% (Hastings, 1993). Thus independent populations are units for which it is biologically meaningful to examine extinction risks that derive from intrinsic factors such as demographic, genetic, or local environmental stochasticity.

The degree to which a group of fish has population dynamics that are independent from another group's depends in part on the relative numbers of fish in the two groups. Ten migrants into a group of 1,000 fish would have a much smaller demographic impact than 10 migrants into a group of 10 fish. Practically speaking, applying our definition of a population will involve an assumption about the degree of independence individual fish groups experienced under historical or "natural" conditions (i.e., before the recent or severe declines that have been observed in many populations). It is necessary to consider historical conditions to ensure that a population designation is not contingent on relative conservation status among groups of fish. In some cases, it may be determined that environmental conditions are so altered that either it is impossible to evaluate an ESU's pre-decline population structure or the population structure of the recovered ESU would be substantially different from what it was historically. In these cases, it may be necessary to identify both the current population structure and what the population structure is expected to be after recovery is achieved.

For species like pink and coho salmon, for which the age structure is relatively fixed (e.g., pink salmon mature at 2 years and coho salmon often mature at 3 years), cohorts within a breeding group could technically belong to separate populations as we have defined them. Whether cohorts within a breeding group are treated as separate populations depends on the degree of inter-cohort straying. In cases where there is less than 10% "migration" between cohorts (as could occur when fish come back a year earlier or later than their normal pattern), the cohorts should be treated as separate populations. In practice, because these "temporally isolated" populations occupy essentially the same habitats in space, viability assessments at the population and ESU level should take into account the highly correlated environmental conditions such populations' experience.

The Washington Department of Fish and Wildlife, tribal groups (WDF et al. 1993) and the Oregon Department of Fish and Wildlife (OAR 635-07-501(38)) use population definitions that require some level of reproductive isolation among populations. This focus on demographic

independence is consistent with the manner in which the population concept is often applied in fisheries analysis. As discussed in “Population growth rate and related parameters” (p. 13), estimating spawner/recruitment relationships is a common analytical tool in fisheries biology. To apply these estimates, particularly where density-dependent reproduction is involved, it must be assumed that populations are reproductively isolated. Indeed, inadvertently pooling groups of fish from different independent populations is a major source of error in estimating spawner/recruit relationships (Hilborn and Walters 1992, Ray and Hastings 1996). Whether explicitly stated or not, most analyses using spawner/recruit relationships assume a population (or “stock”) definition similar to the one used in this document.

Distinction between Population Definition and Tools for Estimation

In the Appendix “Identifying populations” (p. 38), we describe several ways to estimate dispersal rates and population boundaries. These include performing mark-recapture studies, exploring correlations in population fluctuations, assessing patterns of phenotypic variation, and using molecular genetic markers to track individuals or to estimate similarity among groups of fish. It is important to emphasize that these techniques are simply tools for estimating population boundaries; they are not part of the population definition itself. For example, genetic marker patterns may show the degree to which groups of fish are reproductively isolated. Our population definition does not in any way stipulate how to interpret those patterns. As a case in point, simply because one group of fish has a statistically detectable set of allele frequency differences from another group, it does not necessarily mean that each group represents an independent population.

Geographic characteristics are another tool that may be used to help identify populations and their boundaries. Spatial distributions of spawning groups—and whole salmonid populations—are constrained by geographic features such as basin and sub-basin structure. The physical locations of suitable habitat within a basin and the fishes' dispersal capabilities combine to determine, in part, the area over which a population is distributed. Nonetheless, it is important to note that populations cannot be defined based on geography, rather they are defined based on biological processes, (i.e., reproductive isolation and demographic independence). Thus biology may cause a population's geographic boundaries to be smaller or larger than a single basin or sub-basin. Given seven species and many life-history variants, the geographic expanse that different populations occupy is likely to vary substantially. An example of how one might use such data to identify populations is provided by Ford et al. (2000).

Structure Below and Above Population Level

A population, as defined in this document, is described as a group of fish that is reproductively isolated “to a substantial degree.” However, as a criterion for defining groups of fish, the degree of reproductive isolation is a relative measure that may vary continuously from pairs of fish to the isolation separating species. The “population” defined here is not, therefore, the only biologically logical grouping that may be constructed. Within a single population, for example, individual groups of fish are often reproductively isolated to some degree from other groups but not sufficiently isolated to be considered independent by the criteria adopted here.

These groups of fish are termed “subpopulations.” (“Spatial Structure,” p. 18, describes subpopulations and spatial structure.)

There may be structure above the level of a population as well as below it. This is explicitly recognized in the ESU designations: an ESU may contain multiple populations connected by some small degree of migration. Thus organisms can be grouped in a hierarchic system wherein we define the levels of individual, subpopulation, population, ESU and, finally, species. Other hierarchic systems made up of more or fewer levels could be constructed. Though reproductive isolation forms a continuum, it is not a smooth continuum, and there exists a biological basis for designating a hierarchy of subpopulations, populations, and ESUs (Figure 1).

Borderline Situations in Defining Populations

Because we are attempting to define discrete population boundaries from largely continuous processes, it is inevitable that there will be situations in which the population status of a group of fish cannot neatly be assigned. There will often be quasi-reproductively isolated groups of fish within a population, referred to as subpopulations (discussed in “Spatial Structure,” p. 18). Deciding whether a group of fish is a marginally independent population or a significantly distinct subpopulation within a larger population will not always be straightforward. Extinction risk models can be utilized that explicitly allow for any level of reproductive isolation, so from a modeling perspective (assuming the degree of reproductive isolation is truly known), the distinction between a population and a subpopulation is reduced to one of semantics. However, it is possible that the management implications of how population substructure is defined could be much greater, depending on how the VSP concept is applied in policy.

Another scenario in which a group of fish will not fit neatly into our definition of a VSP is when the group is demographically independent of other groups, and its “natural” probability of extinction within 100 years is more than “negligible.” Some independent populations may not be viable, even under pristine conditions. It is important to recognize that naturally non-viable independent populations are possible. The implications of these types of populations for ESU viability are discussed in “Populations not meeting VSP guidelines” (p. 27).

Relationship of the Population Definition to the ESU Definition

An ESU is defined by two criteria: 1) it must be substantially reproductively isolated from other conspecific units, and 2) it must represent an important component of the evolutionary legacy of the species (Waples 1991c). Our population definition is based on a single criterion: it must be sufficiently reproductively isolated from other conspecific units so that its population dynamics or risk of extinction are substantially independent of other units over a time frame of at least 100 years (“Definitions,” p. 2). Thus, the two definitions share a common requirement for substantial reproductive isolation; but an ESU must also represent an important component of the species' evolutionary legacy. Consequently, ESUs are generally more reproductively isolated over a longer period of time than are the populations within them.

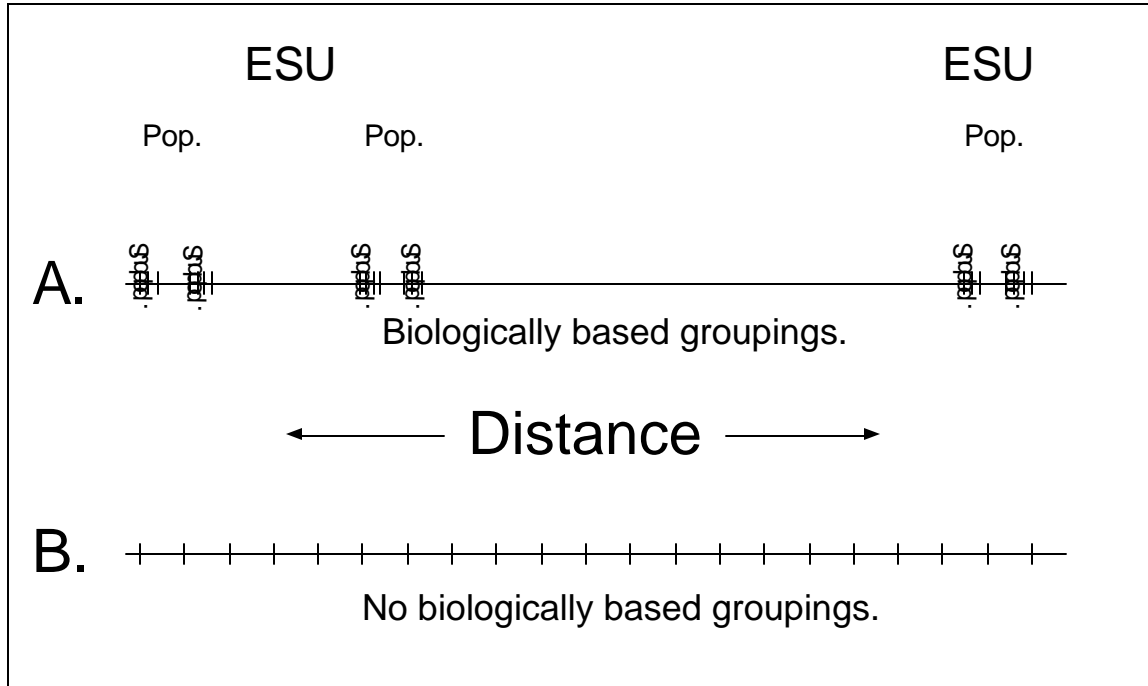

Figure 1. This figure illustrates why subpopulations, populations, and ESUs are likely to have a biological basis. Each vertical line represents a panmictic (completely interbreeding) group of fish. If the probability of mating between two individuals is simply a function of distance and the fish are arranged as in "A," there will be some biological basis for grouping fish into subpopulations, populations, and ESUs. If the fish are arranged as "B" depicts, the probability of mating may still decline with distance, but there are no biologically obvious groupings. The homing tendencies of Pacific salmon—combined with spatial structure of freshwater spawning habitat—suggest that most salmon species will resemble the scenario depicted in "A" rather than that in "B." The distance measure in this figure may represent simple Euclidean distance or a more complex measure, such as a metric involving migration barrier permeability.

No population, as it is defined here, would ever be a member of more than one ESU, but a single ESU may contain multiple populations.

Population Definition and Artificial Propagation

The stated purposes of the ESA are to provide a means whereby the ecosystems upon which endangered and threatened species depend may be conserved, to provide a program for conserving such species, and to take the steps needed to achieve these purposes (ESA sec. 2[b]). The ESA's focus is on natural populations and the ecosystems upon which they depend. Artificial propagation of a listed salmonid species is not a substitute for eliminating the factors causing or contributing to a species' decline (NMFS 1993).

There are hundreds of artificial propagation programs for salmonids in Washington, Oregon, Idaho and California. Collectively, they released several hundred million juvenile fish in the late 1990s (Beamish et al. 1997). Whether by design, as in a supplementation program, or through unintentional straying, hatchery fish often spawn with natural fish in the wild.³ In cases where hatchery fish interbreed with natural fish on spawning grounds and a substantial number of the spawners are fish of hatchery origin, the naturally spawning component cannot be considered demographically independent of the hatchery component. In such cases, hatchery and wild spawning fish are part of the same population. A population that depends upon naturally spawning hatchery fish for its survival is not viable by our definition (see discussion in the Appendix sections "Population size," p. 53 and "Population growth rate and related parameters," p. 64). In contrast, it is possible for hatchery-origin and naturally-produced adults to spawn in the same stream but not be demographically linked to one another. In such cases, the natural- and hatchery-origin groups of fish constitute separate populations. The natural fish could be considered a viable population if they meet the VSP criteria.

³ For the purposes of this document, hatchery fish are defined as fish whose parents were spawned in a hatchery, regardless of parental lineage, and natural fish are defined as fish whose parents spawned in the wild, regardless of parental lineage. These are definitions for clarity only, and imply nothing about the risks or benefits of hatchery programs.

PARAMETERS FOR EVALUATING POPULATIONS

Introduction to Parameters

Population Parameters

Four parameters form the key to evaluating population status. They are: abundance, population growth rate, population spatial structure, and diversity. NMFS focuses on these parameters for several reasons. First, they are reasonable predictors of extinction risk (viability). Second, they reflect general processes that are important to all populations of all species. For example, many factors influence abundance, (e.g., habitat quality, interactions with other species, harvest programs, etc.). Many of these factors are species- or ESU-specific. By focusing on abundance, we can seek general conclusions about an ESU's extinction risk even in the absence of detailed, species-specific information on all of the factors that influence abundance. Third, the parameters are measurable. The Appendix discusses specific methods of estimating population status in the context of each parameter.

Several potential parameters, notably habitat characteristics and ecological interactions, are not components NMFS uses to define population status, even though they are unquestionably important to salmonid population viability. The reason these attributes (and others) are not part of the viability criteria is that their effects are ultimately reflected in the four primary parameters we do examine. Whenever possible, we discuss how these factors influence a specific parameter. For example, a population's spatial structure is to a large degree dictated by habitat structure, and the spatial structure guidelines reflect this fact. Habitat characteristics and ecological interactions both tend to be very species-specific, thus, it is well beyond the scope of this present document to provide guidelines for these factors for every species and life-history type. However, during the recovery planning process, it will be necessary to explore the explicit relationships between habitat characteristics, ecological interactions and population parameters within each ESU.

Guidelines for Each Population Parameter

In order to use the previously mentioned four population parameters to make viability assessments, NMFS has developed a series of guidelines for each parameter. The guidelines are drawn from a survey of the conservation biology and salmonid literature. These guidelines are crude in the sense that they do not take into account the specifics of any particular species or population. However they are also practical because in many situations, population-specific data is not available, or a decision about pending action needs to be made before a detailed analysis can be completed. In these situations, using guidelines may be the best way to evaluate a population's status. To present the guidelines as concisely as possible, this section includes only a brief overview of the rationale behind each of them. The bulk of the data, reasoning, and examples used to create the guidelines are contained in the Appendix. It should be emphasized

that these guidelines are based on our interpretation of currently available data and literature. As with all scientific endeavors, these guidelines can be modified as new data, more rigorous analysis and clearer interpretations are generated.

Population Size

Small populations face a host of risks intrinsic to their low abundance; conversely, large populations exhibit a greater degree of resilience. A large part of the science of conservation biology involves understanding and predicting the effects of population size. All else being equal, small populations are at greater risk of extinction than large populations primarily because several processes that affect population dynamics operate differently in small populations than they do in large populations. These processes are deterministic density effects, environmental variation, genetic processes, demographic stochasticity, ecological feedback and catastrophes (Appendix section “Population size,” p. 53). Deterministic effects of population density fall into two opposing processes: compensation (an increase in productivity with decreasing density) and depensation (a decrease in productivity with decreasing density). Compensation occurs because there is an increasing need to compete for limited resources as a population expands to fill (or exceed) available habitat. The negative relationship between productivity and abundance observed under compensation can give a population substantial resilience. This resilience occurs because any decline in abundance is offset by an increase in productivity, which tends to restore a population to some equilibrium level.

A diverse suite of processes can cause depensatory density effects at small population sizes. These include the inability of potential mates to find one another and increased predation rates when predators are unsatiated (see Appendix section “Population growth rate and related parameters,” p. 64). Depensatory processes at low population abundance (also termed “Allee” effects) result in high extinction risks for very small populations because any decline in abundance further reduces the population's average productivity, resulting in a steep slide toward extinction. Environmental variation can cause small populations to go extinct when chance events reduce survival or fecundity to low levels for an extended time. The genetic processes that may negatively affect small populations include diversity loss, inbreeding depression and the accumulation of deleterious mutations. Demographic stochasticity refers to random events associated with mate choice, fecundity, fertility, and sex ratios that can create higher extinction risks in small populations relative to large populations. Ecological feedback is similar to density-dependent processes, but it emphasizes the role salmon play in modifying their physical and biological environment and it usually operates at time lags absent from density-dependent processes. Examples include the contribution of salmon carcasses to riparian zone nutrient cycles, and the effect of spawning salmon on spawning gravel quality. Both of these processes can contribute to the success of future salmon generations, but they are only significant at relatively high population densities. Catastrophes are environmental events that severely reduce a population size in a relatively short period of time. Because catastrophic events often affect more than one population and the extinction risks associated with catastrophic failure can be relatively independent of population size, the effects of catastrophes are considered in the section on ESU-level viability.

We developed the following guidelines in order to assess population viability in light of the abundance parameter. Note that the ESA's primary focus is on natural populations in their native ecosystems, so when we evaluate abundance to help determine VSP status, it is essential to focus on naturally produced fish (i.e., the progeny of naturally spawning parents). Because extinction risk depends largely on specific life-history strategies and the local environment, setting fish abundance criteria will require application of species or population specific information. For this reason, the following guidelines prescribe factors that need to be considered but do not provide specific numerical criteria.

Two sets of described guidelines that follow are: Viable Size Guidelines and Critical Size Guidelines. (Note that these levels are not equivalent to the ESA concepts of "survival" and "recovery"; see Appendix section "Applying VSP in the regulatory arena," p. 33, for more discussion). A population must meet all of the viable population guidelines to be considered viable with respect to this parameter. If a population meets even one critical guideline, it would be considered to be at a critically low level. Also, note that different guidelines are likely to dominate decisions for different populations. For example, environmental variation (Viable Guideline 1) will often dictate a larger minimum population size than would genetic concerns (Viable Guideline 3), but for some populations genetic concerns may predominate.

Population Growth Rate and Related Parameters

Population growth rate (productivity⁴) and factors that affect population growth rate provide information on how well a population is "performing" in the habitats it occupies during the life cycle. These parameters, and related trends in abundance, reflect conditions that drive a population's dynamics and thus determine its abundance. Changes in environmental conditions, including ecological interactions, can influence a population's intrinsic productivity or the environment's capacity to support a population, or both. Such changes may result from random environmental variation over a wide range of temporal scales (environmental stochasticity). In this section, however, we are most concerned with measures of population growth and related parameters that reflect systematic changes in a population's dynamics.

We focus on population growth rate and related parameters as integrated indicators of a population's performance in response to its environment. Specific characteristics of a population's environment that affect its dynamics, while likely to be similar across populations, are necessarily deferred to individual case studies. In most cases we are concerned with estimating a mean parameter that describes some aspect of population dynamics (such as long-term population growth rate) and with estimating the variance of this parameter. Depending on the question or parameter of interest, estimates of variance may contribute to descriptions of uncertainty in parameter estimates, and consequences of decisions based on such estimates may play an integral role in evaluating the viability of a population. While it is intuitively sensible to

⁴ We use the terms "population growth rate" and "productivity" interchangeably when referring to production over the entire life cycle. We also refer to "trend in abundance" which is simply the manifestation of long-term population growth rate.

Viable Population Size Guidelines

1. **A population should be large enough to have a high probability of surviving environmental variation of the patterns and magnitudes observed in the past and expected in the future.** Sources of such variation include fluctuations in ocean conditions and local disturbances such as contaminant spills or landslides. Environmental variation and catastrophes are the primary risks for larger populations with positive long-term average growth rates.
2. **A population should have sufficient abundance for compensatory processes to provide resilience to environmental and anthropogenic perturbation.** In effect, this means that abundance is substantially above levels where compensatory processes are likely to be important (see Critical Guideline 1 as follows) and in the realm where compensation is substantially reducing productivity. This level is difficult to determine with any precision without high quality long-term data on population abundance and productivity, but can be approximated by a variety of methods.
3. **A population should be sufficiently large to maintain its genetic diversity over the long term.** Small populations are subject to various genetic problems, including loss of genetic variation, inbreeding depression, and deleterious mutation accumulation, that are influenced more by effective population size than by absolute abundance.
4. **A population should be sufficiently abundant to provide important ecological functions throughout its life-cycle.** Salmonids modify both their physical and biological environments in various ways throughout their life cycle. These modifications can benefit salmonid production and improve habitat conditions for other organisms as well. The abundance levels required for these effects depend largely on the local habitat structure and particular species' biology.
5. **Population status evaluations should take uncertainty regarding abundance into account.** Fish abundance estimates always contain observational error, and therefore population targets may need to be much larger than the desired population size in order to be confident that the guideline is actually met. In addition, salmon are short-lived species with wide year-to-year abundance variations that contribute to uncertainty about average abundance and trends. For these reasons, it would not be prudent to base abundance criteria on a single high or low observation. To be considered a VSP, a population should exceed these criteria on average over a period of time.

Critical Population Size Guidelines

1. **A population would be critically low if depensatory processes are likely to reduce it below replacement.** The specific population levels where these processes become important are difficult to determine, although there is theory on mate choice, sex-ratios, and other population processes that may be helpful in placing a lower bound on safe population levels. In general, however, small-population depensatory effects depend largely on density rather than absolute abundance. A species' life-history and habitat structure play large roles in determining the levels at which depensation becomes important.
2. **A population would be critically low if it is at risk from inbreeding depression or fixation of deleterious mutations.** The most important genetic risks for very small populations are inbreeding depression and fixation of deleterious mutations; these effects are influenced more by the effective breeding population size than by absolute numbers of individuals.
3. **A population would be critically low in abundance when productivity variation due to demographic stochasticity becomes a substantial source of risk.** Demographic stochasticity refers to the seemingly random effects of variation in individual survival or fecundity that are most easily observed in small populations. As populations decline, the relative influences of environmental variation and demographic stochasticity changes—with the latter coming to dominate in very small populations.
4. **Population status evaluations should take uncertainty regarding abundance into account.** Fish abundance estimates always contain observational error and therefore population targets may need to be much larger than the desired population size in order to be confident that the guideline is actually met. In addition, salmon are short-lived species with wide year-to-year abundance variations that contribute to uncertainty about average abundance and trends. For these reasons, it would not be prudent to base abundance criteria on a single high or low observation. To be considered critically low, a population would fall below these criteria on average over a short period of time.

use population growth rate as an indicator of risk and viability, the issue of how to do so in a quantitative way is still an area of active research.

Estimates of population growth rate (i.e., productivity over the entire life cycle) that indicate a population is consistently failing to replace itself, are an indicator of increased extinction risk, no matter what the cause. Some evidence suggests that the major extinction risk for Pacific salmonids does not arise from stochastic processes but rather from processes (such as habitat degradation or overharvest) that exert a sustained detrimental effect on a population and result in a chronically low population growth rate and a negative trend in abundance (Emlen 1995, Ratner et al. 1997). Under this scenario, small population size is a transient stage toward deterministic extinction. While stochastic processes certainly affect the time to extinction, they do not affect the likelihood of the outcome.

Although our overall focus is on population growth rate over the entire life cycle, estimates of stage-specific productivity (particularly productivity during freshwater life-history stages) are also important for comprehensive evaluation of population viability. Although declines in stage-specific productivity may not immediately manifest in reduced abundance if offset during other portions of the life cycle, they may indicate reduced resilience to variation in productivity elsewhere in the life cycle. As examples, estimates of smolt production provide a measure of both a population's potential to increase in abundance (should the recent poor ocean conditions abate) and a population's ability to weather future periods of poor ocean conditions. Along similar lines, changes or shifts in traits that are clearly related to productivity (such as size-at-return of spawners) may contribute to evaluations of population viability. Such ancillary data may provide an important source of information that supports more rapid detection of changes in conditions affecting population growth rate in salmonid populations.

Other measures of population productivity, such as intrinsic productivity and the intensity of density-dependence, may provide important information for assessing a population's viability. For example, a population's intrinsic productivity (defined as its maximum growth rate when free of density-dependent limitation) partially determines the abundance at which demographic stochasticity begins to play an important role in determining the fate of the population. Intrinsic productivity is also a measure of a population's ability to rebound from short-term environmental or anthropogenic perturbations (resilience). Analyses of extinction models have highlighted the importance of elucidating the existence and intensity of compensatory density-dependence for estimating a population's extinction risk (Ginzberg et al. 1990). However, obtaining unbiased estimates of a population's intrinsic productivity and the intensity and functional form of density-dependence affecting a population can be difficult due to autocorrelation and observation error in the data. Such difficulties hinder the use of these parameters as independent measures of a population's viability.

Not surprisingly, the guidelines for population growth rate and related parameters are closely linked with those for abundance; indeed, the following guidelines are often conditioned on a population's status in terms of abundance.

Population Growth Rate and Related Parameters Guidelines

1. **A population's natural productivity should be sufficient to maintain its abundance above the viable level.** A population meeting or exceeding abundance criteria for viability should, on average, be able to replace itself. That is, spawner: spawner ratios or cohort-replacement ratios should fluctuate around 1.0 or above. Natural productivity is typically measured as the ratio of naturally-produced spawners born in one broodyear to the number of fish spawning in the natural habitat during that broodyear; population abundance estimates at other life-history stages may also be used, provided such estimates span the entire life cycle (e.g., smolt to smolt estimates).
2. **A viable salmonid population that includes naturally spawning hatchery fish should exhibit sufficient productivity from naturally-produced spawners to maintain population abundance at or above viability thresholds in the absence of hatchery subsidy.** In a strict sense, this guideline suggests that the mean Natural Return Ratio (NRR) for a viable population should fluctuate around 1.0, indicating negligible hatchery influence on the population. In a practical sense, the requirement that a viable population be demographically independent of a hatchery population suggests that a viable population's mean NRR not be less than approximately 0.9, but this estimate neglects other issues related to the influence of hatchery fish on natural production. A viable population should not exhibit a trend of proportionally increasing contributions from naturally spawning hatchery fish.
3. **A viable salmonid population should exhibit sufficient productivity during freshwater life-history stages to maintain its abundance at or above viable thresholds—even during poor ocean conditions.** A population's productivity should allow it both to exploit available habitat and exhibit a compensatory response at low population sizes. When spawner abundance is below the long-term mean, there should be a corresponding increase in per capita smolt production, even though such an increase may not suffice to offset declines in marine survival.
4. **A viable salmonid population should not exhibit sustained declines in abundance that span multiple generations and affect multiple broodyear-cycles.** "Sustained" declines are those that continue longer than the typical lag in response associated with a population's generation time. Thus, sustained declines differ from rapid transitions between one stable level and another (e.g., changes in abundance related to large-scale, low frequency environmental forcing such as those related to oceanic regime shifts). They also differ from short-term, severe perturbations in abundance, such as those related to strong El Niño events that are followed by relatively rapid recovery.
5. **A viable salmonid population should not exhibit trends or shifts in traits that portend declines in population growth rate.** Changes in such traits, such as size and age of spawners, that affect population growth rate are often more easily and precisely quantified than are changes in abundance and thus, may provide earlier indication of declining population growth rate. For example, reduced size of mature individuals in a population may indicate reduced fecundity, lessened ability to reach spawning grounds, a decreased capacity for constructing redds that are deep enough to resist bed scour, or other factors that contribute to reduced production of offspring. Likewise, increasing age-at-return may reduce a population's intrinsic productivity by exposing adults to greater pre-reproductive spawning risk.
6. **Population status evaluations should take into account uncertainty in estimates of population growth rate and productivity-related parameters.** To estimate long-term trends and spawner-recruit ratios, it is important to have an adequate time series of abundance. Unfortunately, such time series, when they exist at all, are often short, contain large observational errors, or both. These constraints may greatly limit the power of statistical analyses to detect ecologically significant trends before substantial changes in abundance have occurred.

Spatial Structure

When evaluating population viability, it is important to take within-population spatial structure needs into account for two main reasons: 1) because there is a time lag between changes in spatial structure and species-level effects, overall extinction risk at the 100-year time scale may be affected in ways not readily apparent from short-term observations of abundance and productivity, and 2) population structure affects evolutionary processes and may therefore alter a population's ability to respond to environmental change (Appendix section "Spatial Structure," p. 90).⁵ A population's spatial structure is made up of both the geographic distribution of individuals in the population and the processes that generate that distribution. Spatially structured populations are often generically referred to as "metapopulations," though the term metapopulation has taken on a number of different meanings. A population's spatial structure depends fundamentally on habitat quality, spatial configuration, and dynamics as well as the dispersal characteristics of individuals in the population.

Because many of the processes that affect small population extinction risk (e.g., genetic risks and demographic stochasticity) depend primarily on breeding structure, we will focus on spawning group distribution and connectivity. Restricting the discussion to spawning groups is practical for the purposes of evaluating viability, but spatial structure exists during all life-history stages. Although we focus on breeding structure, it should be noted that with little or no modification, many of our guidelines could apply to non-breeding spatial structure.

Because freshwater habitat is often quite heterogeneous, salmonids may experience spawning habitat as discrete "patches" whose quality can vary from highly productive to unusable. If straying among patches is limited, the population may be divided into subpopulations. ("Straying" occurs when an individual spawns in a different patch from the one in which it hatched.)⁶ Straying rates form a continuum and, by definition, levels of straying among subpopulations are higher than those found between populations. The spatial scales that define habitat patches and subpopulation boundaries are not strictly defined because such determinations are likely to be species- and population-specific.

⁵ As one example of how a degraded spatial structure can threaten the viability of a population, consider a population divided into subpopulations. A population with a high subpopulation extinction rate can persist only if new subpopulations are founded at a rate equal to the rate at which subpopulations naturally go extinct. If human activity interferes with the formation of new subpopulations by restricting straying patterns or destroying habitat patches suitable for colonization, the population will ultimately go extinct as subpopulations blink out one by one. However, there will be a time lag between the disruption of spatial processes and reductions in the abundance or productivity of the population because abundance will not necessarily decline until subpopulations start going extinct.

⁶ The term "straying" is commonly used in the salmonid literature as we have defined it here. Despite the negative connotations of the word "straying," there is no reason to assume that straying is evolutionarily maladaptive. For non-salmonids, the terms "dispersal" or "migration" are generally used to describe movement away from natal habitats, resulting in breeding in a non-natal location. However, in the salmonid literature dispersal and migration often refer to any movement among habitats and straying is the only term restricted to breeding structure.

A number of different population structures are possible—depending on habitat patch physical stability, subpopulation demographic stability, and the levels of straying among patches (Figure 2). Although there are few data on salmonid breeding spatial structure, what data are available suggest that the habitat patch size and quality vary greatly within a population. This indicates that source-sink or island-mainland dynamics might be common. In contrast, there are few data to support a panmictic or classical metapopulation view of salmonid population spatial structure (see Appendix section “Spatial Structure,” p. 90 for definitions of these terms). It should be emphasized, however, that salmonid spatial structure is not well understood, and there is currently no scientific consensus on what a “typical” spatial structure is. The following guidelines focus on key processes that are likely to be important in maintaining a viable spatial structure, regardless of population type.

Diversity

Several salmonid traits exhibit considerable diversity within and among populations. This variation has important effects on population viability (Appendix section “Diversity,” p. 101). Some of these varying traits are anadromy, morphology, fecundity, run timing, spawn timing, juvenile behavior, age at smolting, age at maturity, egg size, developmental rate, ocean distribution patterns, male and female spawning behavior, physiology and molecular genetic characteristics. Of these traits, some (such as DNA or protein sequence variation) are completely genetically based, whereas others (such as nearly all morphological, behavioral, and life-history traits) usually vary as a result of a combination of genetic and environmental factors.

In a spatially and temporally varying environment, there are three general reasons why diversity is important for species and population viability. First, diversity allows a species to use a wider array of environments than they could without it. For example, varying adult run and spawn timing allows several salmonid species to use a greater variety of spawning habitats than would be possible without this diversity. Second, diversity protects a species against short-term spatial and temporal changes in the environment. Fish with different characteristics have different likelihoods of persisting—depending on local environmental conditions. Therefore, the more diverse a population is, the more likely it is that some individuals would survive and reproduce in the face of environmental variation. Third, genetic diversity provides the raw material for surviving long-term environmental changes. Salmonids regularly face cyclic or directional changes in their freshwater, estuarine, and ocean environments due to natural and human causes, and genetic diversity allows them to adapt to these changes.

Any actions that affect basic demographic and evolutionary processes (e.g., patterns of mutation, selection, drift, recombination, migration, and population turnover) have the potential to alter a species’ diversity. For example, straying and gene flow among populations strongly influence diversity within and among populations. Gene flow refers to the movement of genes from one population to another and results from strays that successfully reproduce. There are a number of ways in which human actions could substantially alter patterns of straying and, therefore, potentially alter patterns of diversity and adaptation among salmonid populations. For example, blocking migration corridors with dams and dewatering rivers can prevent salmonids from homing and thus increase the rate of straying into other populations.

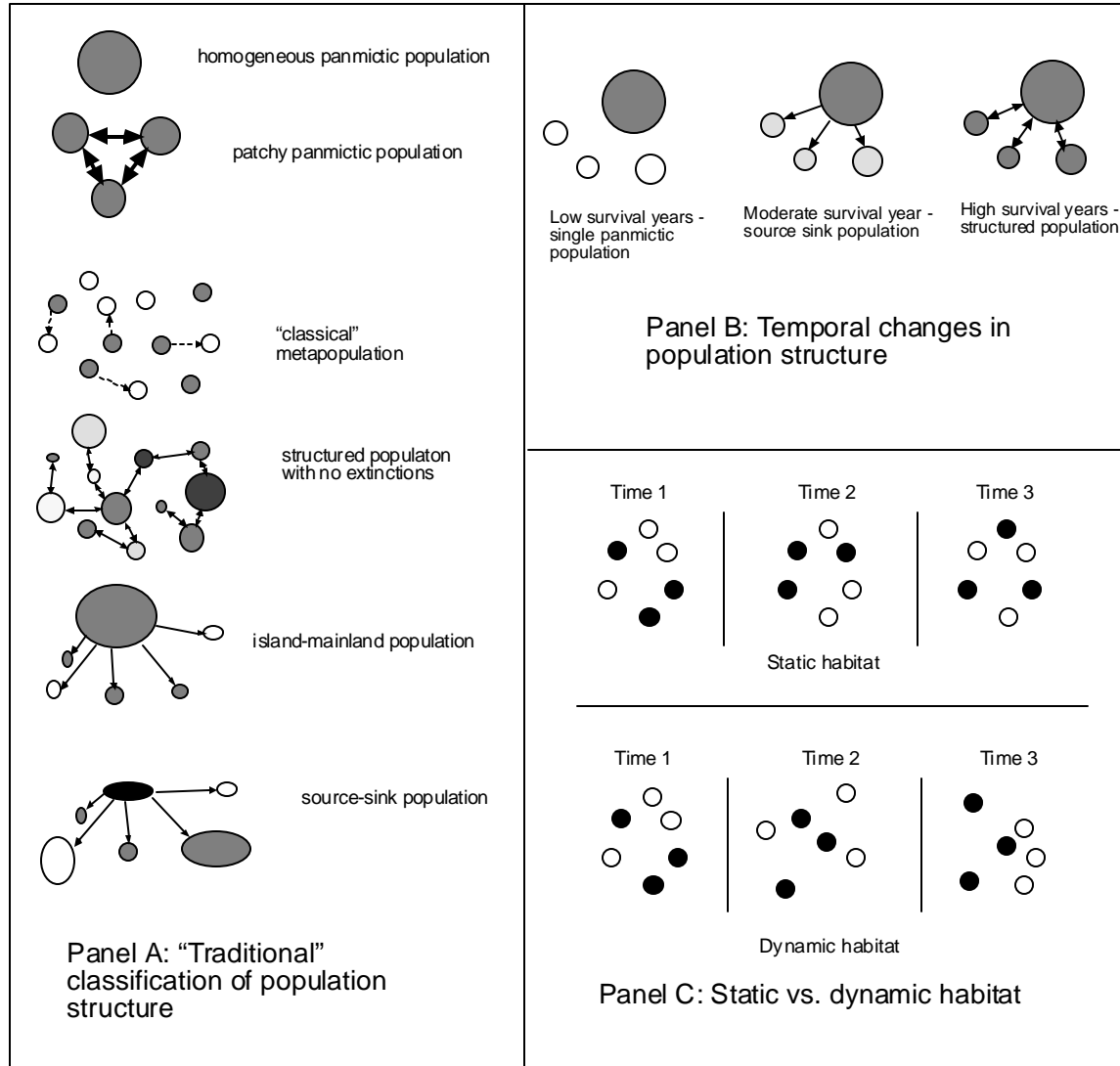

Figure 2. Theoretical types of spatially structured populations. Panel A shows a "traditional" type classification scheme that does not consider correlated environmental effects that impact all subpopulations nor does it explicitly consider the physical dynamics of the habitat patches themselves. The circles indicate habitat patches, with the size of the circle indicating the size or capacity of the patch, and the degree of shading indicating the density of the subpopulation—white indicating an empty patch and black indicating a high density patch. The arrows indicate levels of migration, with thick arrows indicating high migration; thin arrows moderate migration, and dashed arrows indicating intermittent migration. Panel B shows how spatial structure may oscillate over time as a result of correlated environmental changes in survival or productivity among subpopulations. Correlated environmental changes might result, for example, from annual variation in ocean survival that affects all subpopulations. Panel C shows two potential habitat patterns. In a static habitat, the location of suitable patches remains constant over time, though patches may or may not always be occupied. In a dynamic habitat, the location of suitable habitat continually changes, and so the location of subpopulations must also change.

Spatial Structure Guidelines

1. **Habitat patches should not be destroyed faster than they are naturally created.** Salmonid habitat is dynamic, with suitable habitat being continually created and destroyed by natural processes. Human activities should not decrease either the total area of habitat OR the number of habitat patches. This guideline is similar to the population growth rate criterion—i.e., a negative trend has deterministically negative affects on viability—though the relationship between decreasing number of patches and extinction risk is not necessarily linear.
2. **Natural rates of straying among subpopulations should not be substantially increased or decreased by human actions.** This guideline means that habitat patches should be close enough together to allow appropriate exchange of spawners and the expansion of the population into under-used patches, during times when salmon are abundant (see Guideline 3). Also, stray rates should not be much greater than pristine levels, because increases in stray rates may negatively affect a population's viability if fish wander into unsuitable habitat or interbreed with genetically unrelated fish.
3. **Some habitat patches should be maintained that appear to be suitable or marginally suitable, but currently contain no fish.** In the dynamics of natural populations, there may be time lags between the appearance of empty but suitable habitat (by whatever process) and the colonization of that habitat. If human activity is allowed to render habitat unsuitable when no fish are present, the population as a whole may not be sustainable over the long term.
4. **Source subpopulations should be maintained.** Some habitat patches are naturally more productive than others. In fact, a few patches may operate as highly productive source subpopulations that support several sink subpopulations that are not self-sustaining. Protecting these source patches should obviously be of the highest priority. However, it should be recognized that spatial processes are dynamic and sources and sinks may exchange roles over time
5. **Analyses of population spatial processes should take uncertainty into account.** In general, there is less information available on how spatial processes relate to salmonid viability than there is for the other VSP parameters. As a default, historic spatial processes should be preserved because we assume that the historical population structure was sustainable but we do not know whether a novel spatial structure will be.

Diversity Guidelines

1. **Human-caused factors such as habitat changes, harvest pressures, artificial propagation, and exotic species introduction should not substantially alter variation in traits such as run timing, age structure, size, fecundity, morphology, behavior, and molecular genetic characteristics.** Many of these traits may be adaptations to local conditions, or they may help protect a population against environmental variation. A mixture of genetic and environmental factors usually causes phenotypic diversity, and this diversity should be maintained even if it cannot be shown to have a genetic basis.
2. **Natural processes of dispersal should be maintained. Human-caused factors should not substantially alter the rate of gene flow among populations.** Human caused inter-ESU stray rates that are expected to produce (inferred) sustained gene flow rates greater than 1% (into a population) should be cause for concern. Human caused intra-ESU stray rates that are expected to produce substantial changes in patterns of gene flow should be avoided.
3. **Natural processes that cause ecological variation should be maintained.** Phenotypic diversity can be maintained by spatial and temporal variation in habitat characteristics. This guideline involves maintaining processes that promote ecological diversity, including natural habitat disturbance regimes and factors that maintain habitat patches of sufficient quality for successful colonization.
4. **Population status evaluations should take uncertainty about requisite levels of diversity into account.** Our understanding of the role diversity plays in Pacific salmonid viability is limited. Historically, salmonid populations were generally self-sustaining, and the historical representation of phenotypic diversity serves as a useful “default” goal in maintaining viable populations.

Integrating the Parameters and Determining Population Status

The key parameters used to determine whether a population is likely to enjoy long-term viability are abundance, population growth rate, population spatial structure, and diversity. As a rule, these four population attributes cannot be viewed entirely independently. For example, the value ranges for population growth rate considered necessary for a viable population clearly depend on the population's abundance (Appendix section "Population growth rate and related parameters," p. 64). Making an overall determination of population status will usually require some method of integrating the parameters.

We believe the guidelines for each of the four parameters (p. 14, 15, 17, and 21) describe the actions needed to maintain salmonid population viability over a 100-year period. Nevertheless, because the guidelines we provide are qualitative, modeling tools (such as population viability analyses) may prove useful in exploring tradeoffs between parameters such as population size and productivity. For example, a model could be constructed that examines the extinction dynamics of a salmonid population under different population size scenarios and spawner-to-recruit ratios in order to combine a population's characteristics and estimate their effects on viability. Similarly, a structured modeling approach could explore the effects on population viability that different subpopulation numbers, abundance, and distribution would have.

ESU VIABILITY

Introduction

To help understand basic salmonid biology and formulate priorities for salmon management, it is useful to explore the extinction risks that individual population's experience. However, in many cases it is also important to consider how these individual population risks relate to sustainability of larger conservation units such as Genetic Diversity Management Units (GDMU, defined by WDFW), Major Ancestral Lineages (defined by WDFW), or Gene Conservation Groups (defined by ODFW). The ESA is ultimately concerned with the extinction of any entity that qualifies as a "species" under the ESA, which for vertebrate animals includes species, subspecies, or "distinct population segments." According to NMFS policy, groups of salmon populations that represent Evolutionarily Significant Units (ESUs) of the species as a whole are considered distinct population segments and hence, "species" under the ESA. The goal of this section of the document is to discuss factors that should be evaluated when determining the numbers and distribution of VSPs needed to sustain larger conservation units such as ESUs. Like the section on population viability, this section describes only qualitative guidelines for determining ESU viability. The assumption is that in order to determine the necessary population numbers and distribution in a given ESU, case-specific information will be required. Appendix section "ESU Viability Guidelines" (p. 127) provides a more detailed rationale for the guidelines.

Number and Distribution of Populations in a Recovered ESU

By definition, a VSP has a negligible risk (over a time scale of 100 years) of going extinct as a result of genetic change, demographic stochasticity, or normal levels of environmental variability. If these were the only factors influencing viability, a single VSP would be enough to ensure the survival of an entire ESU. However, three additional factors need to be considered in relating VSPs to viable ESUs: 1) catastrophic events, 2) long-term demographic processes, and 3) long-term evolutionary potential. Catastrophic events are sudden, rare occurrences that severely reduce or eliminate an entire population. These events fall outside the scope of the "normal" temporal and spatial scales of environmental variation considered when evaluating VSPs. Long-term demographic processes involve extinction and recolonization of entire populations at time scales greater than 100 years. The concern about long-term evolutionary potential centers on the role diversity plays in ESU viability over time scales that are generally greater than 100 years.

In addition to biological considerations, the ESA defines an endangered species as a species that is "...in danger of extinction in all or a significant portion of its range." The ESA does not define "significant portion of the range" and there is no indication that the phrase is meant to be (or can be) defined entirely in scientific terms. As noted in the appendix section "Applying VSP in the regulatory arena" (p. 33), it will probably be necessary to define "a significant portion of the range" in both scientific and policy terms. Scientifically, a significant

ESU Viability Guidelines

1. **ESUs should contain multiple populations.** If an ESU is made up of multiple populations, it is less likely that a single catastrophic event will cause it to become extinct. Also, ESUs may function as “metapopulations” over the long term and the existence of multiple populations would be necessary for the operation of sustainable population-level extinction/recolonization processes. In addition, multiple populations within an ESU increase the likelihood that a diversity of phenotypic and genotypic characteristics will be maintained, thus allowing natural evolutionary processes to operate and increasing the ESU’s viability in the long term. Obviously, this guideline does not apply to ESUs that appear to contain a single population (e.g., Lake Ozette sockeye). In ESUs containing a single population Guideline 6 becomes increasingly important.
2. **Some populations in an ESU should be geographically widespread.** Spatially correlated environmental catastrophes are less likely to drive a widespread ESU to extinction. This guideline also directly relates to the ESA mandate of protecting a species in a “significant portion of (its) range.”
3. **Some populations should be geographically close to each other.** On long temporal scales, ESUs may function as “metapopulations” and having populations geographically close to one another facilitates connectivity among existing populations. Thus, a viable ESU requires both widespread (Guideline 2) AND spatially close populations.
4. **Populations should not all share common catastrophic risks.** An ESU containing populations that do not share common catastrophic risks is less likely to be driven to extinction by correlated environmental catastrophes. Maintaining geographically widespread populations is one way to reduce risk associated with correlated catastrophes (Guideline 2), but spatial proximity is not the only reason why two populations could experience a correlated catastrophic risk.
5. **Populations that display diverse life-histories and phenotypes should be maintained.** When an ESU’s populations have a fair degree of life-history diversity (or other phenotypic diversity), the ESU is less likely to go extinct as a result of correlated environmental catastrophes or changes in environmental conditions that occur too rapidly for an evolutionary response. In addition, assuming phenotypic diversity is caused at least in part by genetic diversity, maintaining diversity allows natural evolutionary processes to operate within an ESU.
6. **Some populations should exceed VSP guidelines.** Larger and more productive (“resilient”) populations may be able to recover from a catastrophic event that would cause the extinction of a smaller population. An ESU that contains some populations in excess of VSP threshold criteria for abundance and population growth rate is less likely to go extinct in response to a single catastrophic event that affects all populations. It is important to note that the abundance guidelines do not take catastrophes into account. This guideline is particularly relevant if an ESU consists of a single population.
7. **Evaluations of ESU status should take into account uncertainty about ESU-level processes.** Our understanding of ESU-level spatial and temporal process is very limited. ESUs are believed to have been historically self-sustaining and the historical number and distribution of populations serves as a useful “default” goal in maintaining viable ESUs.

portion of the range will be determined by evaluating the risks to ESU persistence at a number of time scales, including those longer than 100 years.

Populations Not Meeting VSP Guidelines

After conducting a viability analysis, a group of fish considered to be an independent population under the VSP definition might not appear to meet the VSP guidelines. There are a number of reasons why a population may appear non-viable. Some of these reasons involve a correct assessment of population status, while others involve some error in assessment. Understanding why a population is not considered viable, and the potential mistakes in reaching that conclusion is important in assessing ESU viability.

A group of fish could be mislabeled as not viable if it has been misidentified as an independent population and should actually be considered to be a subpopulation of a larger group. Population and subpopulation designations fall along a continuum of reproductive isolation, and in borderline cases it is difficult to determine population structure for a group of fish (see “Identifying populations,” p. 51). Ambiguity about population structure may often be a challenging reality in evaluating ESU-level status.

Even if population boundaries are appropriately identified, a population may still be inaccurately characterized as inviable. Evaluating population status with limited data is a difficult task and errors are inevitable. This is particularly true if a population is in some way unusual and comparing it to other salmonid populations would be misleading.

Despite challenges assessing population boundaries and population viability, the conclusions that a population is not viable may be correct. In many areas, human activities have so affected individual survival and fecundity that it is difficult or impossible for an independent, viable population to become established.

An interesting situation exists when a population is independent, but would not be considered viable (i.e., it would not have a negligible risk of extinction in 100 years), even under pristine conditions. There are a number of reasons why independent populations might not be viable, even under pristine conditions. For example, a population may be particularly prone to catastrophic events or large environmental fluctuations, as would be expected on the margins of a species’ range. Alternatively, a population may be so small naturally that it is unlikely to persist for 100 years. Truly independent but inviable populations may periodically be generated by strays from viable populations, and these relatively ephemeral populations would be part of ESU-level metapopulation processes. These types of populations will have to be taken into account on a case-by-case basis when an ESU’s status is being evaluated. They may be quite important to an ESU’s viability if it functions as a large metapopulation with population turnover occurring at relatively short time scales. In an ESU consisting primarily of populations that would be viable under pristine conditions, the potentially viable populations would likely be given highest conservation priority.

IMPLEMENTING THE VSP GUIDELINES

Introduction

ESA recovery plans are required to provide objective, measurable criteria for determining when delisting is warranted (ESA Sec. 4[f]). Delisting criteria are also useful in performing other ESA related activities, such as consultations, permits, habitat conservation plans, and regulations (see “Applying VSP in the regulatory arena,” p. 33). The VSP guidelines presented in this document are intended to guide the development of specific delisting/recovery criteria for Pacific salmon ESUs.

The guidelines presented here are intentionally general so they can be applied equally across the wide spectrum of life-history diversity, habitat conditions, and meta-population structures represented by Pacific salmon. It would be irresponsible to propose specific numerical criteria to be applied uniformly across all Pacific salmon ESUs; specific criteria should take into account species-specific life-history traits and local habitat structure. For example, population structure and abundance criteria for sockeye salmon spawning in a north Washington coastal lake would be expected to differ substantially from those for steelhead spawning in intermittent streams on the Southern California coast. In addition, the type and amount of information available varies considerably by species and region, which will influence the emphasis placed on the various guidelines in specific applications.

Practical Application

Given the generality of these guidelines, it is important to consider how they will be applied in practice to develop biological delisting criteria. NMFS envisions this to be a three-step process:

- 1) Define populations within each ESU.
- 2) Identify VSP criteria for each population.
- 3) Identify ESU-wide delisting criteria based on the VSP population criteria.

These steps are discussed in a draft guidance document for technical recovery teams (NMFS 2000a).

Uncertainty, Precaution, and Adaptive Management

A main concern in translating the guidelines into specific criteria will be the degree of uncertainty in much of the relevant information. There are two widely recognized principles for approaching resource conservation under uncertainty that should be applied in application of VSP: the precautionary approach and adaptive management.

The precautionary approach requires managers to implement conservation measures even in the absence of scientific certainty regarding risks. This approach is widely recommended in harvest management. For example, NMFS' National Standard Guidelines for the Magnuson-Stevens Fishery Conservation and Management Act (50 CFR Part 600, FR 63:24212-24237) specify use of a precautionary approach both for the specification of optimum yield (OY, National Standard 1) and in managing bycatch (National Standard 9). The precautionary approach is also clearly defined in the FAO Code of Conduct for Responsible Fisheries (see discussion in Ch. 5 of Committee on Ecosystem Management for Sustainable Marine Fisheries 1999). We believe this approach to be equally appropriate in other management areas. An application to habitat is discussed briefly by the Committee on Protection and Management of Pacific Northwest Anadromous Salmonids (1996). In practical terms, a precautionary approach results in shifting the burden of proof, putting that burden in favor of resource conservation rather than direct economic benefit. For quantitative criteria, this can be accomplished through careful consideration of appropriate levels of statistical confidence and power in comparing estimated population parameters to criteria.

Adaptive management encourages the design of management policies designed to improve the resource knowledge base through active or passive experimentation (Holling 1978, Walters 1986). General principles for designing adaptive policies are described by Walters (1986). The Committee on Protection and Management of Pacific Northwest Anadromous Salmonids (1996) discussed specific applications to salmon management under the ESA.

Interim Application

We have emphasized the role of technical recovery teams in establishing specific criteria for listed ESUs. However, management actions still need to be taken while recovery teams are being formed and recovery goals are being developed. It may be useful for agencies involved in such actions to establish interim criteria that will be used until recovery plans are adopted. Such interim criteria should be based on a careful consideration of the precautionary principle and adaptive management methods. Often, a full review of population structure will not be possible within management time frames. In such situations, agencies might adopt population definitions already available in state wild fish conservation reports or similar stock-based management plans, provided these definitions are reasonably consistent with the VSP population definition. Interim population definitions and criteria should be based on precautionary application of the VSP criteria. Strong precaution at this stage will help ensure a rapid start along the road to recovery and that no significant parts of the ESU are lost before the full recovery plan is implemented. At the ESU level, we suggest that during this interim period, actions should be taken such that all populations with the ESU retain the potential to achieve viable status. This would ensure that all parts of the system are maintained until a final plan establishes ESU-level criteria. Adaptive management should be emphasized to provide improved information and to allow for changing goals and management strategies as recovery plans are developed.

Examples

The VSP guidelines are currently being applied in formal ESA recovery planning by the Puget Sound and Willamette/Lower Columbia technical recovery teams, but products from these groups are not yet available. (The only example of applying these guidelines is the work of a multi-agency work group preparing a “Quantitative Analytical Report” for upper Columbia River steelhead and spring chinook salmon [Ford et al. 1999a].)

APPENDIX

Applying VSP in the Regulatory Arena

This document focuses on scientific/biological aspects of populations and more complex conservation units, but it is also intended to be useful for a wide variety of applications in the conservation and management of salmonids—at local, state, national, and international levels. Typically these applications require relating biological principles to regulatory language involving terms such as “survival,” “recovery,” and “extinction.” For example, implementation of the federal ESA requires determining when listed species are at risk of extinction or endangerment, when they have reached a level at which they can be delisted, and when they are likely to be jeopardized by a proposed action. This document defines another term, population viability, as a negligible probability of extinction over a 100-year time frame. Although 100 years is a commonly-used time horizon for evaluating extinction risk (or persistence probability) in the field of conservation biology, it does not relate directly to any particular regulatory language described previously. It is beyond the scope of this document to make this formal linkage. Nevertheless, it is useful to briefly review the key regulatory language for federal ESA implementation and to comment in general on how such linkages might be made.

Listing Criteria

The ESA (“Number and distribution of populations in a recovered ESU,” p. 25) defines an “endangered” species as “any species which is in danger of extinction throughout all or a significant portion of its range.” A “threatened” species is “any species which is likely to become an endangered species within the foreseeable future throughout all or a significant portion of its range.” From the perspective of applying VSP to entire ESUs, the relevant terms are “likely to become,” “foreseeable future,” and “significant portion of its range.” Neither NMFS nor the U.S. Fish and Wildlife Service has defined any of these terms in a policy context. Thompson (1991) reviewed existing extinction models and rules of thumb for evaluating population status and noted that although selecting values for extinction probability (p) and time horizon (t) is only partially a biological exercise (and therefore there is no intrinsically “right” answer), conservation biologists commonly choose the values $p = 0.5$ and $t = 100$ years to represent an endangerment threshold. Thompson also suggested that a reasonable interpretation of a “likely” event is one that has at least a 50% chance of occurring. Defining “foreseeable future” is less intuitive. Thompson suggested that something on the order of 10 years might be appropriate, but a number of other interpretations are possible.

Because ESUs are considered “species” under the ESA, and a species can be listed if it is threatened or endangered in “all or a significant portion of its range”, it is essential to take the meaning of this phrase into consideration when applying VSP guidelines to entire ESUs. The common scientific usage of “statistical significance” does not appear to be pertinent here; rather, the relevant meaning of “significant” must be more along the lines of “important; of consequence” (Random House Dictionary, 2nd Edition). “Range” has an obvious geographic

interpretation, and the sections of this document that discuss population abundance and geographic distribution are relevant in this context. In addition, we believe it is important to consider other aspects of the “range” concept when evaluating ESU viability; these might include ecological diversity, life-history diversity, and genetic diversity. The “Diversity” section (p. 19) discusses long-term ecological and evolutionary processes and thus is directly relevant to this concept of “range.” In summary, because the process of determining what constitutes a “significant portion” of a species’ range is only partially based on biological considerations, the technical definitions of these terms are of limited use.

Recovery

NMFS and the U.S. Fish and Wildlife Service define recovery under the Act to be “improvement in the status of a listed species to the point at which listing is no longer appropriate” under the ESA (50 CFR S402.02). This indicates that there is a strong connection between listing and delisting criteria. Thus, the biological criteria used to make listing determinations should also be used to evaluate recovery. However, there are several reasons why listing and delisting criteria values should not be identical. First, if simple threshold values were used for setting criteria, a species that fluctuates around the critical value might require repeated listing and delisting actions even though its status had changed relatively little. Second, listing and delisting criteria require that population trends (and other factors) are considered in addition to abundance, and trends are expected to differ between declining and recovering populations. Finally, delisting should occur only in conjunction with an approved, comprehensive recovery plan that lays out conservation measures that address the factors that led to the initial decline and those that impede recovery. The preceding discussion applies to recovery as the ESA defines it. In addition, the NMFS, states, tribes, and many other stakeholders have an interest in recovering salmon populations to the point at which they can support sustainable harvest or other “broad sense” recovery goals (e.g., to produce fully functional ecosystems). Recognizing this, NOAA has made the following commitment (Garcia 1998):

It is our policy that the recovery of salmonid populations must achieve two goals: 1) Restore salmonid populations to the point where they no longer require the protection of the ESA, and 2) restore salmonid populations to a level that allows meaningful exercise of tribal fishing rights. We see no conflict between the statutory goals of the ESA and the federal trust responsibilities to Indian tribes. Rather, the two federal responsibilities complement one another.

Furthermore, NOAA has an obligation under the Sustainable Fisheries Act to restore depleted populations to optimal levels of abundance and productivity. The VSP concept can be used to inform management decisions in this context. If, for example, it were a management objective to ensure a population's sustainability while providing for a specified level of harvest, VSP guidelines could be used to help determine the population abundance, productivity, diversity, and structure that would be required to achieve this objective.

Jeopardy

Federal agencies cannot undertake or authorize an action that is “likely to jeopardize the continued existence” of a species listed under the ESA (ESA Section 7). Joint NMFS-USFWS regulations define “jeopardize the continued existence of” to mean “to engage in an action that reasonably would be expected, directly or indirectly, to reduce appreciably the likelihood of both the survival and recovery of a listed species in the wild by reducing the reproduction, numbers or distribution of that species” (50 CFR S402.02). In the context of jeopardy, “survival” is “the condition in which a species continues to exist into the future while retaining the potential for recovery” (USFWS and NMFS 1998). The precise meaning of “into the future” is not defined, but it clearly represents something short of the time frames associated with ESA recovery. In contrast, the concept of “long-term survival,” as considered in long-term conservation plans, does not differ substantially from the concept of ESA recovery because both require a high probability that the species will persist for substantial periods of time (Waples 1997). Thus “jeopardy” currently lacks a precise biological definition; instead, it is defined in a legal context that introduces several secondary terms that do not have precise biological definitions. Therefore, it is not surprising that it has been difficult to develop and apply jeopardy standards. We will need clearer definitions or interpretations of these secondary terms before we can forge a formal link between VSP and jeopardy determinations. Nevertheless, it is useful to consider the risks that affect listed species’ survival because that is often the major factor in jeopardy determinations.

For purposes of this discussion, we assume that risks to a species may constitute jeopardy if the risks pose threats to short- or long-term species survival. Some jeopardy evaluations have made use of “critical” thresholds that trigger strong management actions if exceeded. In most cases, a “critical” status means that a population has a non-negligible probability of going extinct over a relatively short time period (e.g., 10 years). A problem with implementing jeopardy standards has been the difficulty in assessing the cumulative effects of a number of actions that have impacts which are necessarily evaluated at small spatial and temporal scales. Using the VSP concept as a framework should help determine the net effects “jeopardy” actions have on population or ESU viability.

Relationship of VSP to Other Concepts

Relationship to Minimum Viable Population Concepts

The VSP concept is closely related to the concept of a minimum viable population (MVP) (Shaffer 1981). Soulé (1987) defines an MVP as a population that is sufficiently abundant and well adapted to its environment that it will persist in the long term without significant artificial demographic or genetic manipulations. Meffe and Carroll (1994) define an MVP as “the smallest isolated population size that has a specified percent chance of remaining extant for a specified period of time in the face of foreseeable demographic, genetic, and environmental stochasticities, plus natural catastrophes.” The MVP concept has been used in a

number of conservation applications, from reserve design to extinction risk analyses (see reviews in Soulé 1987).

Though the VSP concept shares many features with the MVP concept, the two differ in several important ways. First, abundance has historically been the primary factor in defining an MVP (Soulé 1987). A VSP, on the other hand, is defined by a variety of parameters, including population growth rate, population spatial structure, and diversity. Second, although we suggest minimal thresholds for a VSP (see appendix sections “Population growth rate and related parameters” through “Viable ESUs,” p. 64-127), any population that meets or exceeds these thresholds is considered viable. In other words, VSPs include not just minimally viable populations, but more robust populations as well. Finally, the VSP concept is specifically tailored for use with Pacific salmonids and thus emphasizes parameters and criteria that are particularly relevant to this group of species.

Relationship to Quantitative Population Viability Analysis

Population viability analysis (PVA) is a widely-used tool for estimating extinction probabilities (Soulé 1987, Caughley and Gunn 1996) and it is being increasingly applied to salmon populations (Spencer 1999). However, there are presently no models that completely represent the various risks facing salmonid populations. The VSP concept is intended to provide useful benchmarks for evaluating actions, such as harvest or artificial propagation, that directly affect natural populations and for which incremental increases in extinction risk may be difficult or impossible to accurately quantify. The VSP concept is not intended to replace quantitative risk models in situations where these models can be appropriately used, and the concept could be used in conjunction with quantitative models in some cases. For example, the effects of harvest on abundance (one parameter of a VSP) may be relatively easy to quantify and model, but the simple life-cycle models usually used to evaluate and set harvest levels, often are inadequate for accurately estimating extinction risk. The VSP concept, by determining the level of abundance (among other parameters) necessary for long-term survival, could be used in conjunction with a quantitative life-cycle harvest model to determine if a specific harvest action is likely to cause a population to fall below VSP parameters. Until extinction risk can be accurately estimated under a variety of scenarios for Pacific salmonid populations and ESUs, the VSP concept will be of great help in assessing actions that directly or indirectly affect population viability.

Relationship to Properly Functioning Conditions

Although viable salmonid populations clearly require high quality freshwater habitat, this document focuses on population processes and does not attempt to establish the relationship between particular habitat attributes and population viability. This is appropriate given the purpose of this document, which is to provide a foundation for setting recovery goals of listed ESUs. These goals will be based on current and projected status of the fish populations, not on the presence or absence of particular habitat attributes. Of course, assessments of the current and future status of the population will take habitat attributes into consideration, but the fish themselves are the ultimate indicator of whether or not the population continues to be in danger of extinction.

Understanding the relationship between freshwater habitat quantity and quality and population viability is critical in developing recovery plans and in determining the impact of proposed land use activities on fish survival. To assess the effects of actions that may adversely modify a species' habitat, NMFS uses the concept of "Properly Functioning Condition" (PFC, NMFS 1999). PFC defines, based on currently available knowledge, the freshwater spawning and rearing habitat conditions necessary for the long-term survival of Pacific salmon populations. To evaluate the effects of specific habitat actions, NMFS uses analytical tools (e.g., the Matrix of Pathways and Indicators, NMFS 1996) to determine whether an action will maintain, restore, or degrade the values of the parameters that describe properly functioning conditions. The incremental increase in extinction risk from a habitat action is not estimated per se. Instead, PFC describes the freshwater habitat conditions needed for long-term species survival, and subsequent actions are evaluated based on how they affect the habitat conditions. Defining PFC is an ongoing process that will continue to undergo revision, as more scientific data become available. A particular challenge in developing PFC guidelines is relating habitat actions at a variety of spatial scales to population-level responses.

Relationship to the Sustainable Fisheries Act (SFA) and Maximum Sustainable Yield (MSY)

In addition to ESA responsibilities, NMFS has responsibility for administering marine fisheries under the Magnuson-Stevens Fishery Conservation and Management Act, as amended by the Sustainable Fisheries Act of 1996 (SFA). Important concepts in the SFA that relate to population viability include optimum yield (OY), overfishing, and essential fish habitat (EFH). The Pacific Fishery Management Council recently introduced Draft Amendment 14 to the Pacific Coast Salmon Plan (PFMC 1999), which incorporates the SFA provisions into Pacific salmon ocean fisheries management. In developing the VSP concept, we have made no assumptions regarding the allowable level of harvest for listed salmon populations. In this regard, harvest is treated similarly to other management factors that influence salmon populations (i.e., hatcheries, habitat, and hydropower). However, we believe the VSP concept is consistent with the intent of the SFA provisions because populations achieving viable status will likely provide greater ocean and freshwater harvest opportunities.

The VSP guidelines have no explicit relationship to maximum sustainable yield (MSY) analyses for a number of reasons. First, MSY generally deals only with population numbers and VSP takes into account other parameters that affect population viability such as spatial structure and diversity. Also, VSP is concerned with extinction risk, not with setting harvest levels. In addition, VSP analyses focus on estimating extinction risk and examining stochastic processes at small population sizes, issues that are generally not covered in MSY estimates. Assuming MSY is actually being achieved, a wild population harvested at MSY is, by definition, sustainable (VSP)—provided that the time horizon of MSY is the same as VSP and the MSY estimate takes into account all the factors affecting viability, such as genetic diversity and spatial structure.

Relationship to Other Conservation Assessment Approaches

A number of other approaches are used to assess risks at the species and population levels. One of the most widely used is that of the International Union for the Conservation of Nature (IUCN) for its Red Book (IUCN Species Survival Commission 1994). The IUCN rates species on the basis of five general criteria: Population reduction, limited extent of occurrence combined with decline or fluctuation, low population abundance with continuing decline, extremely low abundance, and quantitative viability analysis. These criteria differ from ours in three respects: 1) IUCN criteria are applied to a species as a whole, not to individual populations, 2) some of the IUCN criteria link abundance or geographic range with decline (analogous to our “population growth rate”) while our criteria treat abundance and productivity separately, and 3) we explicitly treat population structure and diversity as separate parameters. Allendorf et al. (1997) proposed criteria for Pacific salmon that were similar to the IUCN criteria, but adapted them specifically to the purpose of ranking threats to individual populations rather than classifying them as individual risk categories (see also Currens et al. 1998, Wainwright and Waples 1998). The specific criteria values proposed here differ somewhat from both the IUCN’s and those developed by Allendorf et al. because they serve a different purpose: we define criteria that are appropriate for classifying populations as viable, sub-viable, or critical within the context of broader ESUs and in concert with the requirements of the ESA. Our criteria differ further from the IUCN’s because we restrict them to a single genus, rather than developing them for all organisms.

Identifying Populations

Introduction to Identifying Populations

Conceiving of and defining a population is relatively straightforward in a theoretical sense. It is another matter to identify populations in nature. In practice, information is limited about the distribution, local abundance, and migratory patterns of a species during their life cycle. For Pacific salmonids, whose life history occurs in such diverse habitats as freshwater tributary streams and ocean environments, the challenges associated with delimiting population boundaries are many. Nevertheless, a number of different types of information can be used to indicate the geographic or temporal boundaries of a salmon breeding population. This section has two main parts. First we briefly outline the kinds of information that can be used to help identify salmon populations. Second, we review approaches to identifying salmonid populations used in management at state, tribal, and federal levels.

Types of Information Used in Identifying Populations

The different types of population boundary indicators discussed in this section apply to all levels of structure, from substructure within populations to the structure of populations within ESUs. Most of the methods described in this section can be used to generate a nested hierarchy of spatial scales over which some level of indicator subdivision can occur. There is spatial

pattern at many scales in the biological and geographical data relevant to salmon, the challenge to scientists managing salmon under the Endangered Species Act is to identify the appropriate groupings of salmon that are most useful for predicting the long-term persistence of populations and ESUs. Making the leap from identifying distinct groups of fish based on similarity of characteristics to identifying distinct populations depends critically on how independent the groups of fish are. As we have defined populations in this document, a group of fish is considered an independent population if migrants from other groups do not appreciably affect the population dynamics or extinction probability of the focal group (see discussion in “Population Concepts,” p. 4).

Evidence for independent populations

The best evidence for identifying populations comes from information on a group’s extinction probability and the degree to which its population dynamics are independent of those of any other group. Such evidence could come from direct observations of trends in abundance or productivity from groups of fish with known inter-group stray rates. If the dynamics or extinction probabilities found in one group of fish is not appreciably affected by strays from any other group, the focal group can be considered an independent population. In rare cases, quasi-natural “experiments” may be available to test the effects inter-group straying has on population dynamics and extinction. Such an experiment may occur where a naturally spawning run is locally extirpated or where a hatchery-derived population is taken out of production. In such cases, the effect on population dynamics of removing migrants from a system can be observed. Because such experiments require good, long-term abundance or productivity information before and after removing a population’s neighboring groups, opportunities to test population independence in this manner are rare. In lieu of empirical information, modeling efforts can be used to test the probability that groups of fish connected by a particular stray rate have independent population or extinction dynamics. Such modeling exercises have been used to explore metapopulation persistence for a number of species (Hanski and Gilpin 1997). In addition, Hastings (1993) showed analytically that under certain conditions, population dynamics remained independent as long as the inter-population migration rate was less than 10% (see also Kendall and Fox 1998).

It is critical to understand the distribution of stray rates between spawning groups in order to model the effects of reproductive isolation on salmonid population trends. Demographic estimates of dispersal include radio-tagging studies, data from coded-wire tag retrievals, and studies of stray rates from wild and hatchery fish (Giger 1972, Lister et al. 1981, Quinn et al. 1991, Labelle 1992, Quinn 1993, Vanderhaegen and Doty 1995). There are few estimates of stray rates for Pacific salmonids (Table A1). Those that do exist indicate that there is high variability within and among species in terms of the percentage of fish that return to streams

Table A1. Estimates of straying (the percentage of marked fish returning to a location other than that in which it was marked) for Pacific salmonids. Straying estimates for some species have been made for fish initially marked in their natural habitats (natural) and for fish reared in hatchery facilities (hatchery).

Species	% Straying	Geographic scale of straying	Natural (N) or Hatchery (H) origin	Geographic region	Reference
Sockeye salmon	0.6 - 1.5	N/A	N	Cultus Lake (Fraser R.), British Columbia	1
Chum salmon	2.2 - 10	350-2000 km	N	Hokkaido, Japan	2
Chum salmon	5.2 - 5.4	≈10 km	H	British Columbia	3
Pink salmon	0.1 - 62	≈ 400-800 km	H	Soviet Union	4
Coho salmon	0.5 - 67 0 - 3.9 1 - 65 0 - 67	California: 10 km; B C: 9 - 159km; Puget Sound: ≤150km; WA coast: ≤150 km	N	Scott and Waddell Creeks in California; British Columbia, Puget Sound, Washington coast	5, 6, 12
Coho salmon	0.0 - 27.7 1 - 7 <0.5 - 4 0 - 12.4 0 - 100* 0 - 99*	B.C.: 7-58 km Puget Sound: ≤150km; WA coast: ≤60 km; Columbia: ≤150 km Hood Canal: ≤50 km Grays Harbor: ≤25 km	H	British Columbia, Puget Sound, Washington coast, Columbia R. basin, Hood Canal	6, 12, 13
Steelhead	2 - 3	10 km	N	Scott and Waddell creeks in California	5
Chinook salmon (fall)	3.2	> 60 km but w/in Columbia basin	N	Columbia River (Lewis R.)	7
Chinook salmon (fall)	89.7 4.6 - 5.7 7 - 86 ≤ 3 2 - 25 5 - 95	Lewis: ≤ 30 km, Lewis: w/in Columbia basin; Sacramento: 48-336 k Puget Sound: ≤150 km WA coast: ≤150km Columbia R: ≤400 km	H	Lewis R., Columbia R. basin, Sacramento R. basin, Puget Sound, Washington coast	7, 9, 11, 12
Chinook salmon (spring)	0.3 - 3.6	98.3% w/in 50 km, 1.7% out of Columbia basin	H	Columbia River (Cowlitz R.)	8
Coastal cutthroat trout	0 - 30	70-150 km	H	Oregon coastal rivers	10

*: straying estimate is expressed as the percentage of adult fish in a stream that originated from another location

References :

1. Foerster 1968 (in Quinn 1993)
2. Sakano 1960
3. MacQuarrie and Bailey 1980 (in Quinn 1993)
4. Glubokovsky and Zhibbotovski 1989 (in Quinn 1993)
5. Shapovalov and Taft 1954
6. Labelle 1992
7. McIsaac 1990 (in Quinn 1993)
8. Quinn and Fresh 1984
9. Quinn et al. 1991
10. Giger 1972
11. Cramer 1989
12. Vanderhaegen and Doty 1995.
13. Ruggerone 1997

other than those in which they were born. The percentage of fish straying from streams in which they are marked can be as high as 95%, but the higher estimates are typically based on smaller sample sizes, so their associated confidence levels are lower (Table A1). It is difficult to make generalizations about the magnitude of stray rate variation among and within species because there are so few estimates and the geographic scales over which they have been made vary greatly. In addition, because of logistical considerations, many of the stray rate estimates are based on movements of marked hatchery fish, and the relative propensities of hatchery and wild fish to stray is not well understood (Quinn 1993).

Genetic estimates of salmonid straying suggest that the gene flow rate is less than the straying rate (see “Diversity,” p. 19). Only strays that successfully spawn and produce viable offspring contribute to gene flow. In addition, both ecological and genetic methods have been used to more directly estimate the distribution of dispersal distances between parent and offspring. The dispersal curve generated is the frequency distribution of offspring (i.e., spawners) as a function of the distance from where they were produced (i.e., where the spawner hatched). These distributions define the area within which mating is expected to occur, or the area encompassing a population. One such method is to estimate neighborhood size, which is a function of the variance in parent-offspring dispersal distributions (Wright 1946, Crawford 1984). Using empirical estimates of dispersal distances between parents and offspring, neighborhood sizes have been estimated for a few bird, plant, and insect species (Barrowclough 1980, Crawford 1984, Levin 1988, Ruckelshaus 1996, Fig. A1a). There are no such estimates for salmonids. Another method for estimating parent-offspring dispersal distributions is to use genetic markers to track individuals of known parentage. This method involves genotyping and spatially mapping parents and their offspring. The dispersal distributions can then be generated by quantifying the distances over which offspring dispersed from their parents (Meagher 1986, Meagher and Thompson 1987, Grosberg 1991, Fig. A1b). There are no such estimates of parent-offspring dispersal distributions for salmonids. Dispersal distributions could be estimated with tagging studies—such as those using Coded Wire Tags (CWTs)—in which juveniles are marked and then monitored to see where they return to spawn (e.g., Quinn and Fresh 1984, Quinn et al. 1991, Labelle 1992). In contrast, by using molecular markers, parents and their offspring can be observed at the exact location of hatching (CWTs can only be employed after a fish may already have migrated some distance from its natal location.) As might be expected, the sample size requirements of such studies will be very large. However, the approach using molecular markers to track individuals of known parentage may be feasible in some salmonid systems.

Indicators of population structure

Empirical information on salmonid stray rates coupled with long-term population abundance data is rarely available. As proxy evidence for identifying a population, spawning groups can be clustered based on similarity of a number of characteristics, and then the degree of independence of the clusters can be estimated using additional information such as the likely stray rates among clusters. Formal clustering algorithms based on distance measures can be used to combine spawning groups (Hartigan 1975). Using any one of these indicators to interpret the degree of reproductive isolation among groups requires an assumption that “all else is equal.” For example, if two spawning groups exhibit a similar characteristic—such as an abundance

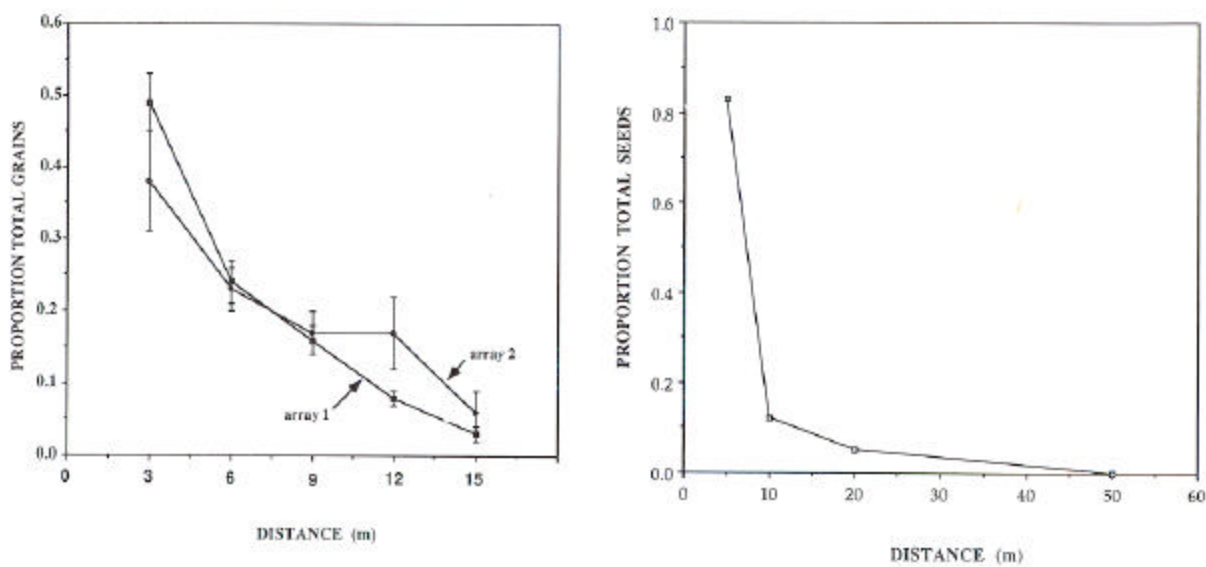

Figure A1a. Distributions of dispersal distances of eelgrass (*Zostera marina*) based on pollen (left graph) and seed (right graph) dispersal. By combining these distributions, the neighborhood area was estimated from $Na = 4\pi(\sigma_p^2/2 + \sigma_s^2)$, where σ_p^2 and σ_s^2 are the variance in pollen- and seed-dispersal distributions, respectively. Results from this population indicated that random mating among individuals occurred on average within a circle of area 524 m² (from Ruckelshaus 1996).

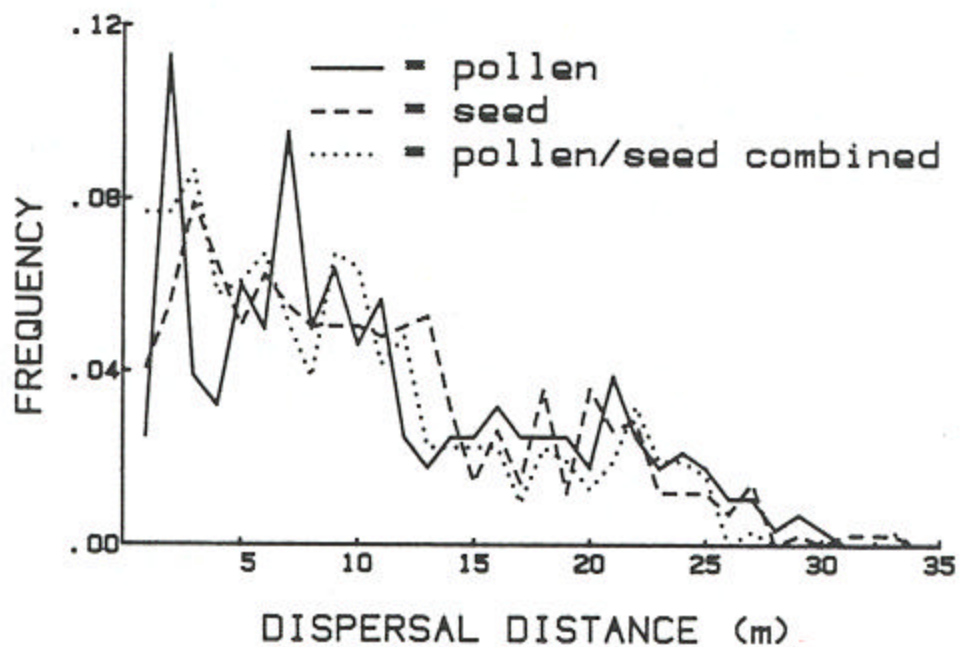

Figure A1b. Frequency distributions of pollen, seed and combined pollen and seed dispersal estimated by identifying and mapping seedlings and parents. Seedlings were assigned to parents based on genealogy reconstruction using 11 polymorphic enzyme marker loci (from Meagher and Thompson 1987).

trend—they would be grouped together in a cluster analysis. Assuming that all else is equal between the groups would lead to the conclusion that those spawning groups are similar in abundance over time because they are demographically linked. However, all else is not equal. For instance, the fish could occur in correlated environmental conditions at any stage of their life history, a situation that would lead to correlated trends in abundance even in the absence of demographic connections (Box A1, Hanski and Gilpin 1997, Kendall et al. 2000). Because it is very difficult to validate such simplifying assumptions, it is better to use multiple, independent indicators to explore similarities among spawning groups. This method offers more confidence that groupings are biologically reasonable and that they actually reflect the degree of reproductive isolation.

Geographic and habitat indicators : A salmon population can be identified, in part, by the likely spatial distribution of its spawning habitat. Physical features such as a river basin's topographical and hydrological characteristics dictate to a large degree where and when salmon can spawn and delimit the spatial area over which a single group of fish can be expected to interact. For example, a group of fish returning to spawn in the upper tributaries of a large river basin such as the Umpqua River on the Oregon coast are not expected to be part of a population that includes another Oregon coastal river drainage, such as the Alsea River. The long distances the fish need to travel to spawning habitat in a large river basin combined with generally accurate homing tendencies make it very unlikely that a single population would encompass multiple basins or large tributaries.

The geographic characteristics of river mouths and estuaries through which salmon migrate can also be instrumental in indicating groups of salmon that are likely to be in the same population. Timing and direction of water flow and spatial distributions of feeding, rearing, and refuge habitats affect salmonid migratory patterns. For example, the freshwater plume produced by the Columbia River is a prominent hydrographic feature along the western coasts of Oregon and Washington. The conditions of the plume vary seasonally; therefore, the timing of the juvenile salmonid downstream migration affects the salinity, temperature, nutrients, and sediment load conditions the fish experience in the plume. These conditions, in turn, affect the likely direction of juvenile fish migrations, their food sources, and their energetic balance.

Geographical and hydrological differences among river drainages imply that ecological characteristics also differ. For example, some river systems consist of many spring-fed streams, and others can be made up of streams whose origins are mostly from glacier- or snowmelt-run off. The productivity, flora, and fauna of glacier- and spring-fed streams are likely to be very different. Information on freshwater and marine habitat characteristics such as temperature, flow regimes, prey, pathogens, and predator species can help define the boundaries of salmon populations. For example, the frequency and types of parasites found in mixed-stock ocean fisheries have been used to identify salmon populations by determining where the parasite species occur in freshwater spawning and rearing habitats (Groot and Margolis 1991). In addition, a population may be identified by examining data on patterns of use of freshwater and marine feeding, rearing, and spawning habitats; these data are derived from stream surveys, angler catch, and ocean sampling.

Box A1. Assigning “resident” and anadromous salmonids to populations.

One example of the importance of understanding the genetic basis for phenotypic variation when defining population boundaries is the difficult issue of deciding whether individuals who spend all of their life history in fresh water (often termed “resident” fish) should be included in the same population as anadromous fish. This challenge arises in populations of *O. mykiss* (steelhead and rainbow trout), *O. clarki clarki* (coastal cutthroat trout), and *O. nerka* (sockeye and kokanee) in many river basins throughout their geographic range (Shapovalov and Taft 1954, Foerster 1968, Barnhart 1986, Trotter 1989). These distinct life-history forms would be considered to be in the same population under the following scenarios. First, it could be that the spawning groups of the two forms are sympatric in time and space—thus allowing interbreeding between the life-history types. If, in this case, the progeny segregate into alternative life-history forms, it would indicate that the phenotypic variation occurs in a single population. Assigning fish to a population is relatively clear in this instance. Alternatively, there could be relatively little inter-breeding between resident and anadromous salmonids within a stream, but there could be enough lability in life-history expression that resident parents give rise to a fraction of anadromous offspring each generation. Those anadromous offspring of resident parents could then interbreed with other anadromous fish. In this case, whether an individual fish remains in fresh water throughout its life cycle or migrates to the ocean would be determined largely by environmental conditions. Under this second scenario, the key information needed to determine whether the different life-history forms are part of a single population is the degree to which genes are exchanged between alternative life-history types. Understanding the genetic (as opposed to environmental) determinants of life-history variation would help in assigning fish with distinct life-history types to appropriate populations. If the life-history forms are primarily genetically determined and the forms do not interbreed, fish with distinct life-history types would not be part of the same population.

There is little empirical evidence supporting either of the above scenarios for any species and, as expected, the degree to which distinct life-history forms appear to interbreed varies geographically. It is clear that for all three species there have been periods when the two life-history forms would have been considered part of the same population; this is because the “resident” form appears to have arisen multiple times evolutionarily (rev. in Busby et al. 1996, Gustafson et al. 1997, Johnson et al. 1999). What this means in practice is that it is not possible to generalize about the extent to which life-history forms within a species are reproductively isolated. In some cases, selective divergence of the two forms may be maintaining them as separate populations (e.g., sockeye and kokanee in British Columbia—Wood and Foote 1996). In other cases, periodic interbreeding during years of high relative abundance of one life-history form may suggest that they are part of a single interbreeding group (e.g., steelhead and rainbow trout in the Deschutes River, Oregon—ODFW 1998). The lack of generality is seen in genetic data for steelhead and “resident” *O. mykiss* suggesting that in some streams, the two life-history forms are not distinguishable, but in others, they are genetically distinct (Wilson et al. 1985, Currens et al. 1987, Leider et al. 1995). Similarly, genetic data for sockeye and kokanee have shown some groups within a lake system to be genetically similar, and others to be distinct (Foote et al. 1989, Craig 1995, Taylor et al. 1996).

In general, the collective biotic and abiotic characteristics of occupied salmonid habitat help define a population because we expect that those ecological characteristics constitute the selective environment in which the salmon exist. If different groups of salmon experience different selective environments and there is very little migration between those environments, we expect those groups' phenotypic characteristics to diverge.

Demographic indicators: To identify a salmonid population, it is necessary to understand the extent to which it is reproductively isolated from other groups of fish. Demographic characteristics such as birth and death rates and fecundity determine the population dynamics of a group of fish. The level of inter-group dispersal influences the degree to which demographic trajectories are correlated among individual groups, depending on the degree to which the environmental conditions are correlated. Estimates of adult dispersal in both freshwater and marine habitats are of critical importance in defining a population unit (see "Evidence for independent populations," p. 39).

Long-term abundance data are another type of demographic information that can help identify a salmon population. Because one of the criteria for defining a population is that it be largely demographically independent from other groups, abundance data may help show whether the demographic trajectories of two proposed populations are largely independent of one another. In cases where the dynamics of two groups of salmon are not correlated with one another, it might be reasonable to conclude that the two groups are not part of the same population—provided environmental variation across the range of the groups can be ruled out as a cause of the uncorrelated dynamics. If the demographics of two groups of salmon do have correlated dynamics, they might still not be part of the same population. In this latter case, it is possible that two groups of organisms occur in environments with correlated conditions—resulting in correlated dynamics between two groups that are not demographically linked (e.g., Grenfell et al. 1998, Kendall and Fox 1998; Fig. A2).

By exploring patterns of abundance among salmonid species within the same geographic area, it is possible to gather additional information on the degree to which correlated environmental conditions drive abundance correlations between spawning groups. Assuming that different species of salmon exhibit different stray rates between spawning sites, any similarities in population dynamics would most likely be due to similarities in common environmental conditions the species are experiencing. Therefore, if more than one species exhibit similar trends in abundance among spawning sites, it would indicate that correlated environmental conditions are the most likely explanation for abundance correlations among populations within a species. Teasing apart the effects of correlated environmental conditions and dispersal to determine the primary cause of population dynamics is a complicated but important exercise (Kendall and Fox 1998, Kendall et al. 2000).

There are few studies that explore the extent of spatial correlation in salmonid population dynamics. Rieman and McIntyre (1996) found weak, but statistically significant positive correlations in bull trout redd counts between streams that were close to one another. The positive correlations in redd counts were stronger between closer streams, just as one would expect if the correlated redd counts were due to correlated environmental conditions or dispersal

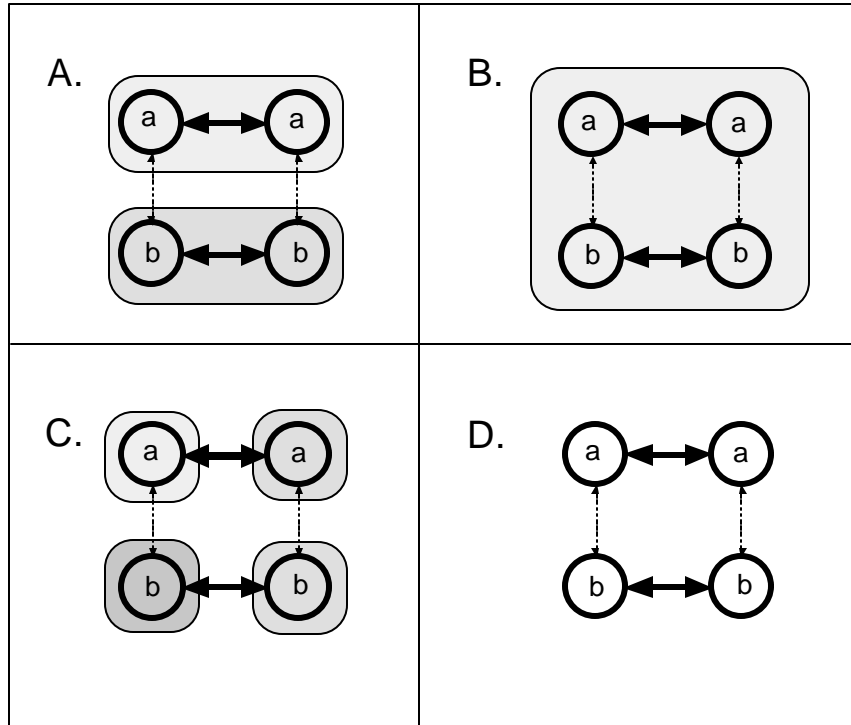

Figure A2. The figure shows why demographic independence is theoretically a useful factor in designating populations. The circles represent functionally panmictic groups of fish, such as might be found at a single river reach. (In a panmictic group, all mature individuals are equally likely to mate with one another.) The arrows represent migration among the breeding groups—heavy arrows represent high migration rates and the dashed arrows represent low migration rates. High migration causes demographic coupling among the groups; low migration causes them to become demographically uncoupled. Breeding groups labeled with the same lower case letter are considered part of the same population. The different patterned areas represent regions with different environmental dynamics. As the text illustrates, the simple scenarios depicted in this figure have important implications for 1) our definition of a population, and 2) how we estimate the parameters for assessing population status.

Scenario A represents the easiest case to interpret, because the demographic and environmental processes have the same boundaries. The two groups labeled “a” are part of the same population because the high rate of migration between them means that any extinction of a single group would only be temporary because the remaining group could recolonize the other—thus rescuing it from extinction. The “a” groups and “b” groups are not considered to form a single population because there are not enough migrants from “b” to prevent the “a” population from going extinct, and vice versa. Because population and environmental boundaries coincide in this scenario, demographic processes and environmental forcing will work in concert to create similar abundance fluctuations in all the groups within a population and independent abundance fluctuations among different populations.

In contrast, both populations in scenario B share the same environmental dynamic. If environmental forcing were strong (i.e., abundance is strongly influenced by varying environmental conditions), then fish abundance would vary in a similar fashion in each population. However, “a” and “b” would still be considered independent populations because the risk of extinction due to demographic processes in “a” is independent of the risk in “b.”

In scenario C, all four groups experience different environmental dynamics, and if environmental forcing were strong, the abundance variation would be independent for all four groups. However, “a” is still a legitimate population because of the high inter-group migration rate. Thus for the “a” groups, individual reaches within a single population may temporarily go “extinct,” but when the population is considered as a whole, as long as a single reach remains extant, the population will survive. These types of substructured populations are discussed in detail in “Spatial Structure,” p. 18.

In scenario D, we show groups of fish in a hypothetically constant environment. In a constant environment, abundance changes would be driven completely by demographic and genetic processes. Even if they were to start with the same population size, the abundance patterns for population “a” would deviate from the abundance pattern of population “b.” Our definition focuses on the extinction risk that independent populations face. As a consequence, separate populations could abstractly be described as being sufficiently isolated, but in a constant environment they would have largely uncorrelated demographic trajectories.

among nearby spawning areas. Milner et al. (1993) explored correlations in salmonid densities between sites within and between tributaries in a river in North Wales. Atlantic salmon and brown trout fry and parr densities were compared at several sites within each of three tributaries to the River Conwy. For both trout and salmon, weakly significant positive density correlations were found both within and between the tributaries, though the variance synchrony was stronger within tributaries than it was at larger spatial scales (Milner et al. 1993). McKinnell (1999) reported on synchronized freshwater catch and recruitment dynamics for Atlantic salmon in Swedish rivers. And, like the other studies, he found a weak relationship between the survival of salmon from different hatcheries and the distance between them. Fish from hatcheries that were closer together were slightly more correlated in terms of marine survival than were fish from hatcheries that were separated by greater distances (McKinnell 1999). Bradford (1999) found positive covariation in coho smolt abundance for streams in Western North America that were separated by distances less than 20-30 km. In summary, the evidence for spatial correlation in salmonid population numbers suggests that abundance variations among fish in streams that are closer to one another tend to be significantly positively correlated, but the correlations are often not very strong.

Genetic indicators: Genetic characteristics are useful in identifying salmon populations because they indicate the extent of reproductive isolation among groups. Molecular genetic markers such as allozymes and nuclear or mitochondrial DNA markers can be used to statistically describe an organism's population structure based on their genetic similarities. In addition, studies of quantitative trait variation (e.g., life-history characteristics) can often help to distinguish salmonid groups. Salmon populations, stocks, and ESUs have been identified with the help of genetic markers and life-history traits (WDF et al. 1993, ODFW 1995, Weitkamp et al. 1995, Busby et al. 1996, Myers et al. 1998, Johnson et al. 1999). The spatial distribution of particular alleles and their frequencies can also be used to define the spatial scale(s) over which groups of salmon are structured. The nature of genetic data allows for a hierarchical exploration of the geographic structuring of salmon populations. Nevertheless, just as it is difficult to use geographic and abundance indicators to identify populations, the extent to which genetic markers can be used to identify independent populations still needs to be determined. Translating the genetic structure of a salmonid species into a set of independent populations is not a simple task, because of the assumptions about population structure that must be made when estimating allele frequencies. As with other indicators of spatial structure, it is necessary to estimate the significance of the genetic structure in terms of population and extinction dynamics in order to identify populations.

For the most part, genetic markers are straightforward indicators of genetic variation among groups. However, there are some instances where genetic data can be uninformative or misleading (Whitlock and McCauley 1999). For example, if there is insufficient variability at marker loci or only a small number of marker loci are used, genetic markers may indicate little or no population structure when it is in fact present. In addition, using molecular genetic markers to estimate degree of reproductive isolation may require certain assumptions (e.g., that the groups of organisms sampled are in drift-migration equilibrium). As discussed elsewhere (see "Diversity," p. 19), salmon populations are dynamic in space and time, and in many cases their evolutionary dynamics are not likely to be at equilibrium. For example, a subpopulation founded by a few individuals during a colonization event is likely to diverge genetically from the

founders' original subpopulation because of the genetic drift that occurs during the sampling from the parent subpopulation. This would be true even if, over the course of many generations, the two subpopulations were connected by high enough levels of migration to be considered part of the same population. Because extinction and recolonization processes are thought to occur relatively frequently in some salmon species in some locations (Mangel and Tier 1994, Dunham and Rieman 1999), it is not a simple matter to attribute causes (e.g., low levels of gene flow vs. recent founding event) to observed population structure. This may also present a problem when attempting to identify populations that have experienced chronic declines in abundance, if, for example, a previously contiguous population has become fragmented into what now appear to be several isolated populations. Rigorous modeling or empirical comparisons to patterns of genetic variation in healthier systems may help overcome some of these potential problems (Currens et al. 1996). Finally, although salmon populations are likely to be commonly perturbed from equilibrium conditions, theoretical work has shown that under some circumstances estimates of inter-population gene flow obtained from population structure statistics approach their equilibrium values fairly rapidly (Slatkin and Barton 1989, Slatkin 1993, Crow and Aoki 1984). Recently developed likelihood methods for estimating gene flow and divergence time may provide more accurate estimates of gene flow than F_{ST} based estimates, especially in non-equilibrium situations (e.g., Nielsen and Slatkin 2000).

It is appealing to use molecular genetic markers to survey and identify salmon populations because of the large sample sizes that can be obtained with relatively little effort. Variation in genetically-based life-history traits can also be used to help determine population boundaries. However, gaining an understanding of the distribution of genetically-based life history and other quantitative traits is much more labor-intensive and, as a result, this information is usually lacking for most natural populations. In practice, phenotypic variation in traits such as run timing, size at migration, and ocean and estuarine migratory patterns has been used to help delineate salmonid groups. This approach is probably most useful at relatively large geographic scales—such as ESUs (e.g., Busby et al. 1996, Myers et al. 1998)—because the potentially confounding effects of environmentally-induced phenotypes are less likely to occur over large geographic regions. Technically, only those phenotypic traits based on underlying genetic variation (rather than environmentally-induced variation) can help define a population because populations are defined on the basis of reproductive isolation and, ultimately, demographic independence (see Figure A2). However, in combination with other population indicators, spatially-structured phenotypic variation within an ESU could be used as a proxy for genetically-based variation.

Rigorous, direct methods for estimating the genetic components of quantitative trait variation involve controlled breeding designs and rearing offspring to life stages that express quantitative traits of interest (Falconer and Mackay 1996). Because of the relatively long generation times for Pacific salmonids, there are many challenges associated with rearing offspring from controlled matings. Indirect evidence for the extent of genetic (vs. environmental) sources of variation in phenotypic traits can be obtained from studies of traits within maternal or paternal families, an approach that is somewhat easier to use for salmon, especially in hatchery populations (Silverstein and Hershberger 1992, Beacham and Evelyn 1992, Heath et al. 1994, Herbert et al. 1998, Mousseau et al. 1998, Hard et al. in press). A few studies of quantitative trait variation in salmon have been conducted and they have found that a

significant portion of the observed phenotypic variation in some life-history and meristic traits is genetically based (see “Diversity,” p. 19). Such results suggest that describing the spatial distribution of life-history variation (and other quantitative traits) for salmon may be a good indicator of population structure, even if the actual genetic basis for trait variation is not known in most cases.

In a comparative review, Healy and Prince (1995) showed that in general, phenotypic variation among salmon populations is much greater than allozyme frequency variation. Molecular markers are ultimately a better tool for grouping fish than phenotypic variation for at least two reasons. First, selection is expected to be greater on quantitative traits than on molecular loci (which are presumed to be neutral). Estimating reproductive isolation from divergence of selected characters requires making a number of restrictive assumptions that are not needed when using neutral markers (Hartl and Clark 1989). Second, some portion of phenotypic variance is due to environmental variation and is therefore of no use in estimating reproductive isolation among groups (Falconer 1981). Nevertheless, where it is difficult to obtain useful data, a useful proxy (e.g., phenotypic variation) is better than no information at all.

The paucity of information on quantitative trait variation among salmon populations has unfortunate consequences in terms of our ability to evaluate population and ESU viability. This is partly because such variation is a good indicator of the extent and nature of a population’s local adaptations. The degree to which a population exhibits local adaptation is an important indicator of its response to environmental changes and, ultimately, the probability of its persistence. More generally, it is useful to know the distribution of locally adapted traits among groups of salmon in order to describe diversity patterns at a number of spatial scales. As “Diversity” (p. 19) discusses, genetic diversity is a critical factor in long-term persistence at the population, ESU, and species levels. It also is an important descriptor of the biological components of the evolutionary lineages that are the focal points for conservation.

Identifying populations—combining the evidence

Without evidence of independent population dynamics or extinction probabilities, identifying populations involves combining stray rate estimates with any information on indicators of population structure discussed previously. Ford et al. (2000) summarizes methods for identifying populations using available data for spring-run chinook salmon and steelhead in the upper Columbia River, Washington, region.

Existing Approaches to Identifying Salmon Populations or Groups

States and other groups that manage salmon have, for management purposes, employed a number of different definitions for particular groups of fish and many of those definitions are similar to the population definition we propose in this document. The Washington Department of Fish and Wildlife (WDFW 1998) defines a stock using Ricker’s (1972) definition; although they do acknowledge that smaller production units may be important and that considerable uncertainty arises when this definition is applied to groups of salmon (WDFW 1998). In practice, salmon stock boundaries have been identified using information on such aspects as run

timing, size and age at migration, ocean migration patterns, spawning locations, and genetic similarities. For the purposes of reporting the status of coastal cutthroat trout, the WDFW introduced the concept of a stock complex, or a “group of stocks typically located within a single watershed or other relatively limited geographic area” (WDFW 1998). The WDFW found that identifying individual stocks of coastal cutthroat trout was more challenging than identifying salmon and steelhead stocks. This was due, in part, to the wide range of migratory behaviors that cutthroat trout exhibit and because there is a great deal of uncertainty about the genetic relationships among different life-history forms (WDFW 1998). The WDFW also uses various genetic, geographic, and life-history data to delineate Genetic Diversity Units (GDUs), and Major Ancestral Lineages (MALs), both of which attempt to define conservation or management units at taxonomic levels higher than populations but lower than species. For example, the WDFW defines an “Upper Columbia Summer + Fall, Snake Fall and Mid- and Lower-Columbia Chinook” Major Ancestral Lineage within which there are 7 Gene Diversity Units (Marshall et al. 1995). Three of these GDUs are contained within the Lower Columbia River chinook salmon ESU (Myers et al. 1998). In other cases, such as Puget Sound chinook salmon, the MAL and the ESU boundaries are equivalent (Marshall et al. 1995, Myers et al. 1998).

Along similar lines, the Oregon Department of Fish and Wildlife (ODFW) also uses a definition of “population” similar to Ricker's (1972) definition. They identify Gene Conservation Groups (GCGs), which are defined as genetically distinct clusters of one or more populations within a taxonomic species that arise when gene flow between the cluster and other populations of the same species is zero (or very low) over a sufficiently long period of time (Kostow et al. 1995, OAR 635-07-501). The GCGs are identified using molecular genetic and geographic information to define groups of spawning populations that have similar genetic and life-history traits (Kostow et al. 1995). The ODFW often uses genetic data to delineate GCG boundaries, but if such data are not available, geographic proximity is used as a guide in identifying groups (Kostow et al. 1995).

Although the WDFW/tribal and the ODFW's population definitions are based on the same Ricker stock definition, in practice, the agencies tend to reach different conclusions as to what constitutes a “population.” The WDFW and tribal (SASSI) stocks (WDF et al. 1993) generally encompass larger geographic areas than what the ODFW would consider a population (Kostow et al. 1995). Part of this difference may result from geographic differences between two states. Nevertheless, a large part of the difference is likely due to different interpretations of the “substantial degree do not interbreed” portion of Ricker's definition. By adding independent population dynamics and extinction risk to Ricker's definition, we are attempting to arrive at the clearest possible interpretation of the word “substantial.”

The Pacific Fishery Management Council's Pacific Coast Salmon Fishery Management Plan recognizes numerous “stocks” of chinook and coho salmon for purposes of ocean harvest management. The plan has no specific criteria for designating stocks, but in general they cover larger areas than do the populations defined here. The proposed draft Amendment 14 to the plan restructures the management stocks slightly to provide more comprehensive coverage of the ESUs defined in NMFS' ESA listings, but retains the larger geographic scale of the present plan (PFMC 1999). We expect that each PFMC stock would be made up of one or more populations as they are defined here.

The state of California delineates separate runs of salmonids based on genetic distinctness and life-history differences such as spatial and temporal variation in run timing and juvenile outmigration (CDFG 1998). They manage these distinct runs (e.g., Central Valley spring vs. fall chinook salmon) separately from one another in setting harvest levels and escapement goals. Their “runs” would probably be composed of several populations as we have defined them in this document. In addition, Barnhart (1994) has used geographic distribution, life history, straying, and genetic data to identify populations and meta-populations of several salmonid species in the Klamath-Trinity Basin of California.

Population Size

Introduction

Small populations face a host of risks intrinsic to their low abundance; conversely, large populations exhibit a greater degree of resilience. A large part of the conservation science literature is directed toward understanding and predicting the effects of population size (Soulé 1986, 1987, Meffe and Carroll 1994, Caughley and Gunn 1996). Population abundance is an important determinant of risk, both by itself and in relationship to other factors. There are a variety of risks associated with the demographics of small populations, including both directional and random effects. Directional effects include two forms of population density-dependence: compensation and depensation. Random effects on population dynamics include demographic stochasticity, environmental stochasticity, and catastrophes (Gilpin 1987, Lande 1993). (Note that only demographic and local environmental stochasticity are considered at the population level here; large-scale environmental effects and catastrophes are considered at the ESU level, see “Viable ESUs,” p. 125.) Lande (1993) used a simple population dynamics model to examine the relative risks associated with these three effects as a function of carrying capacity and long-run population growth rate. He concluded that, for populations with a positive long-run average growth rate, risks from demographic stochasticity are substantial only at very low population sizes, while environmental stochasticity and catastrophes are the dominant risks at higher population sizes. For populations with negative average growth rate, risks from all three types of variation change nearly exponentially with capacity, and thus all may be important.

Small populations also lose adaptive variation and gain maladaptive variation at higher rates than large populations (Mills and Smouse 1994, Lande 1995, Schultz and Lynch 1997), both phenomena generate lower average fitness and a higher probability of extinction. Finally, if populations are declining due to deterministic effects (e.g., habitat degradation or overharvest), population abundance combined with measures of trends and productivity can be an indicator of how long it will take the population to reach a critically low abundance level (Caughley 1994).

Given these considerations, it is clear that risk tends to vary inversely with abundance if other factors are held constant. This means we can, in theory, define simple numeric thresholds to delineate different risk categories ranging from healthy down to extinct. In the following discussion, we focus on two such thresholds: 1) a **Viability** threshold above which populations

have negligible risk of extinction due to local factors, and 2) a **Acritical**@ threshold below which populations are at relatively high risk of extinction in the near future. However, putting numbers on such thresholds is a difficult task for three reasons. First, other factors are not constant and often correlate with abundance levels; this means a pure abundance threshold must be conditional on particular conditions, especially those relating to population trend and variability. Second, the theory relating abundance to extinction risk is based on relatively simple models of population dynamics, and it is not clear how to relate this theory to the complexities of real populations. Third, our ability to accurately measure population abundance and density is quite limited, so there is a great deal of estimation error in any analysis of abundance or risk. For all these reasons, there is a great deal of uncertainty associated with any thresholds that may be established.

All else being equal, small populations are at greater risk of extinction than large populations primarily because several processes that affect population dynamics operate differently in small populations than in large populations. These are: deterministic density effects, environmental variation, genetic processes, demographic stochasticity, ecological feedback, and catastrophes. The first five of these processes are discussed in more detail. Catastrophes (environmental events that severely reduce population abundance in a relatively short amount of time) affect more than one population over a large geographic area, so the effects of catastrophes are considered in the section on ESU-level viability (“Viable ESUs,” p. 125) rather than here.

Density effects

Population ecologists typically divide processes that affect birth and/or death rates into two types: density-dependent effects, and density-independent effects (for example, Nicholson, 1933, Wilson and Bossert 1971, Ricklefs 1973, Hilborn and Walters 1992). Because of the structure of the differential-equation models that describe these different effects, density-independent effects are often termed “linear” effects, while density-dependent effects are termed **Anon-linear**@. Density-dependent effects on population productivity arise from two competing processes: compensation (a decrease in productivity with increasing density) and depensation (an increase in productivity with increasing density). Compensation is a stabilizing influence. With it, an increase in population is offset by a subsequent decline in productivity; it is most important at higher abundance levels. Depensation is a destabilizing influence and is important mainly at very low abundance levels.

Figure A3 illustrates the typical shape of curves relating parental density to offspring density for deterministic populations with positive intrinsic growth rate exhibiting no density-dependence, compensation only, and compensation plus depensation. In this illustration, it is clear that the population with linear dynamics will increase in each generation regardless of abundance and that the population with compensation only will reach a stable equilibrium at a positive abundance where the curve crosses the replacement line. The population with both compensation and depensation has three equilibrium points (points where it crosses the replacement line): stable equilibria at zero (extinction), high abundance, and an unstable equilibrium at intermediate abundance. If population abundance is above the unstable

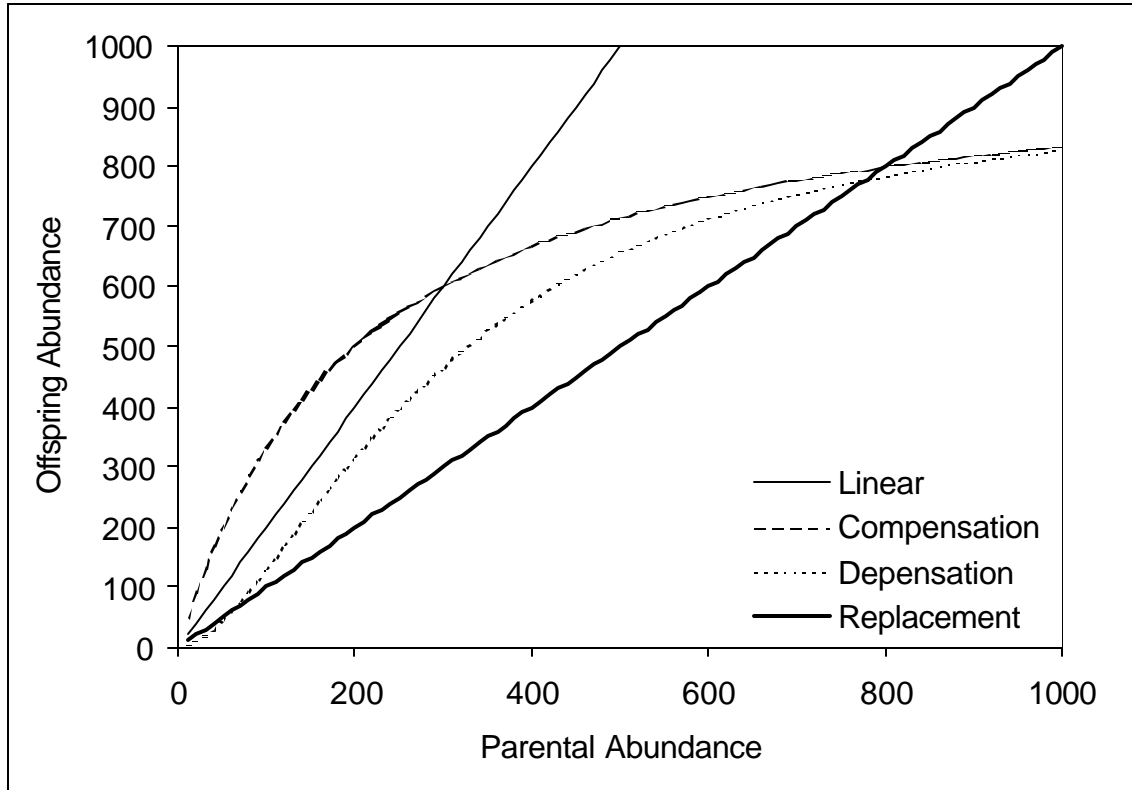

Figure A3. Typical shape of parent-offspring (or stock-recruit) curves for populations with no density-dependence ("Linear"), compensation only, and compensation plus depensation. The replacement line (where offspring equal parents) is included for reference.

equilibrium, the population will more than replace itself and move toward the upper stable point; if it is below the unstable point, it will fail to replace itself and move toward zero.

Compensation at high abundance occurs because there is increasing competition for limited resources as a population expands to fill (or exceed) available habitat. Compensation's negative relationship between productivity and abundance can give a population substantial resiliency because any decline in abundance is offset by an increase in productivity that will tend to restore the population to some equilibrium level. The role of compensation is widely recognized in fishery management through the use of compensatory production models, usually following the form of Ricker or Beverton-Holt recruitment models (Ricker 1975, Hilborn and Walters 1992). For salmon, there is extensive literature discussing models and evidence for compensatory processes in salmon (for example, Ricker 1954, Skud 1973, Solomon 1985, Peterman 1987).

In contrast, when abundance is very low, depensation will accelerate declines and slow recovery. Depensatory processes at low population abundance (also termed "allele effects" or "inverse density dependence") will result in high extinction risks for very small populations because any decline in abundance further reduces a population's average productivity, resulting in a spiraling slide toward extinction. A variety of processes can lead to depensatory population behavior, and such effects are documented for a wide variety of organisms (reviewed by Courchamp et al. 1999). The most commonly cited of these are the uncertainty that mates will be able to find one another in sparse populations (Dennis 1989), randomly skewed sex ratios at low abundance (Gabriel and Bürger 1992), non-linear response of predators to shifting prey abundance (Peterman 1987), and scaling effects of random variation among individuals (Lande 1998). Synergistic interactions among these effects may also increase risks at low abundance (Stephens and Sutherland 1999). Fundamental population theory clearly requires that depensation become significant at some low abundance level in all populations, but the exact level where this occurs, and whether depensation will overcome compensation, depends on the behavior and ecology of individual populations. For example, population density must be high enough to provide sufficient temporal and spatial overlap for males and females to find each other to spawn, but the level of population abundance necessary for this to occur depends on the life-history characteristics of the population in question as well as aspects of the population's habitat. In consequence, populations that return to spawn over long periods of time or inhabit large geographic areas may need to be more abundant to be considered viable than those with more limited spatial or temporal spawning distributions.

In contrast to compensation, fish population models rarely include depensation, although that situation is changing (Ludwig 1998). The direct evidence for depensation in salmonid populations is mixed. Peterman (1987) summarized evidence from a few studies indicating depensatory predation mortality among juvenile salmon, and used a simple population model to show that such mortality could explain observed population dynamics. In contrast, Myers et al. (1995) found significant evidence of depensation in population data for only 2 of 11 populations of salmon examined. Liermann and Hilborn (1997) found only one salmon population out of 27 that clearly exhibited depensation; it was uncertain whether depensation was evident in the remaining 26. Because of the great uncertainty surrounding depensation parameter distributions in their study and the consequences of ignoring depensation if it really is significant, Liermann and Hilborn recommended that fishery analyses employ models that incorporate depensation.

Translating these effects into specific criteria for “viable” or “critical” abundance levels is no simple task. The specific form and function of both compensatory and depensatory processes depend on species- and population-specific life-history characteristics that are difficult to measure accurately. Both types of effect may vary either abruptly or smoothly with changing abundance (for example, Getz and Haight 1989, Dennis 1989), and either pattern could cause abrupt thresholds in population dynamics. When these deterministic effects are combined with stochastic effects, the situation becomes even more intractable. However, some general guidance can be noted. First, it is obvious that a population that is unable to replace itself is in trouble, so we can say that a population is in critical condition when it is so low that depensatory processes are expected to reduce average production below replacement. Similarly, we can say that a population that is near its compensatory stable equilibrium abundance is likely to be safe from deterministic extinction risks; however, such a level may be well above the actual lower threshold of viability as we have defined that term.

Precisely estimating critical population levels based on these principles is impossible without extensive observations of population dynamics across a wide range of abundances; however, a number of approaches can be used to provide reasonable estimates of such levels. Estimates of habitat capacity can be used to define a likely range for compensatory processes. Similarly, theory can be used to establish upper and lower limits for depensatory processes based on mate-finding, predator-prey interactions, sex-ratio stochasticity, etc.

Environmental variation

Environmental variation can cause small populations to go extinct when chance events frequently reduce survival or fecundity to low levels over an extended time. There is an extensive amount of literature on the relationships among extinction risk, persistence time, population abundance and level of variation in demographic parameters (for example, MacArthur and Wilson 1967, Tuljapurkar and Orzack 1980, Goodman 1987, Belovsky 1987, Lande and Orzack 1988, Thomas 1990, Dennis et al. 1991, Lande 1993).

One obvious conclusion from this literature is that there are no simple, generic abundance levels that can be identified as viable; the form of the population model used (e.g., linear or non-linear, simple or age-structured), average parameter values, and degree of environmental variation all combine with abundance to determine extinction risk. In general, model results suggest that numbers greater than 1,000 to 10,000 are often needed to protect a population from moderate-to-high levels of environmental variation (Belovsky 1987, Goodman 1987, Thomas 1990). Thomas (1990) examined both empirical evidence and model results to determine “safe” (i.e., low extinction risk) abundance levels. Thomas concluded that safe levels vary depending on the degree of natural variation in population abundance. However, Thomas did provide guidance regarding appropriate population abundance (geometric mean abundance per generation) for general classes of organisms, suggesting that 1,000 is adequate for species of low variability, and 10,000 is usually adequate for the most variable bird and mammal species. For extremely variable species, such as many insects and the most variable of vertebrates, Thomas recommended increasing these values by an order of magnitude. Salmon have relatively high fecundity (thousands of eggs per female), and therefore have the potential for rapid changes in population abundance. However, unlike insects, salmonids exhibit age-structure and overlapping generations that may reduce the variability of adult populations. Thus, salmonids are probably at

the high end of the variability spectrum for typical vertebrate populations. Thomas= guidance might therefore translate to a recommended safe population abundance of somewhere between 1,000 and 10,000 spawners per generation, depending on the degree of variability in abundance of a given population. Thomas= approach is difficult to apply in practice, because it assumes: 1) a complete census of all individuals in a generation, 2) a population that is stable about some mean value (i.e., no upward or downward trend), and 3) that there are no density-dependent effects. In 1995, NMFS considered using this method to set recovery abundance goals for Snake River salmon populations (NMFS 1995b), but found there was not enough data to categorize populations into Thomas= variability categories except for a number of spring/summer chinook salmon stocks; these stocks exhibited relatively low variability during a thirteen-year period. From this, and considering that the period for which there were data was one of relatively stable environmental conditions, NMFS concluded that variability for these populations was probably low to moderate and thus that safe abundance levels would fall between 1,000 and 5,500 spawners per generation. Considering that spring-summer chinook exhibit a 4- or 5-year mean generation time, these 1,000 to 5,500 spawners per generation would translate to 200-250 to 1,100-1,375 spawners per year.

Genetic processes

There is a great deal of theoretical work relating population size to genetic diversity and the degree of inbreeding within populations (e.g., Wright 1938, Crow and Kimura 1970). There is also a body of theoretical work on the relationship between population size and the accumulation of deleterious alleles and how this affects population viability (Lynch 1990, Lande 1994, 1995, Schultz and Lynch 1997), and on the relationship between the amount of genetic diversity in a population and the population's fitness (e.g., Burger and Lynch 1995). Many of the classical population genetic models that have been used to explore the relationships between population size and level of inbreeding or genetic drift do not accurately correspond to typical salmon life-histories (i.e., semelparous overlapping generations). Waples and Teel (1990) and Waples (1990a, 1990b) have updated some of these models to take into account typical salmon life-history patterns. One aspect of salmon biology that has not received a great deal of attention in population viability models is the fact that salmonids are partially tetraploid (reviewed by Allendorf and Thorgaard 1984). Partial tetraploidy may reduce the severity of inbreeding depression in comparison to the amount seen in diploid organisms because, all else being equal, tetraploids are less homozygous than diploids. However, inbreeding depression has been observed in Pacific salmonids, so the benefits of tetraploidy might not be substantial.

One important concept from population genetic theory is that of effective population size (N_e , Wright 1931, Crow and Kimura 1970). The effective size of a population is defined as the size of an idealized population that would produce the same level of inbreeding or neutral variance in allele frequency (genetic drift) seen in an observed population in which one is interested (see Hartl and Clark 1989, Caballero 1994 for reviews). Attributes of such an idealized population typically include discrete generations, equal sex ratios, binomial variance of reproductive success, random mating, constant breeding, population size, and non-selective gamete-to-adult mortality. Violating any of these attributes usually increases the rate of inbreeding or drift in comparison to the idealized case, and therefore reduces effective size of the population of interest. Effective size can be defined with respect to either inbreeding or genetic

drift, as well as other population attributes (reviewed by Crow and Kimura 1970). For example, the inbreeding effective size refers to the size of an ideal population that would produce the same rate of inbreeding as an observed population. The variance effective size refers to the size of an ideal population that produces the same rate of allele frequency change due to genetic drift as an observed population. The inbreeding and variance effective sizes are usually nearly identical when populations are of constant size, but they generally differ when populations are growing or shrinking (e.g., Crow and Kimura 1970, Ryman et al. 1995). Because almost no natural populations are “ideal,” the effective size of a population is almost always smaller than the observed number of breeding individuals (reviewed by Frankham 1995). Effective size is a useful concept because it is a parameter that can be estimated from real populations, and therefore, acts as a bridge between the complexities of real populations and the necessarily simplified assumptions made in population genetic models. The effective size of a population generally refers to the population size of an entire generation, whereas the effective number of breeders (N_b) refers to the effective number of individuals in a single year (Waples and Teel 1990, Waples 1990a). For species or populations with multiple overlapping age classes (i.e., all the Pacific salmon species except for pink salmon and perhaps some coho salmon populations), the effective population size per generation is approximately equal to the geometric mean of the effective number of breeders per year multiplied by the number of years in a generation (itself approximately equal to the mean age at reproduction). For example, a population with a four-year generation time and a geometric mean N_b of 100/year would have a N_e of ~400/generation (Waples 1990b).

Several examples from fruit flies (reviewed by Wright 1977) and *Tribolium* (Rich et al. 1979) in laboratory settings give empirical evidence of the relationship between population size and the rate of loss of genetic diversity. In natural populations, there are several examples of low levels of genetic diversity associated with known severe bottlenecks; these include elephant seals (Lehman et al. 1993), prairie chickens (Bouzat et al. 1998a, b), and koalas (Houlden et al. 1996). Quinn et al. (1996) found lower levels of protein and DNA heterozygosity in New Zealand chinook salmon than in the Californian founder population, a result consistent with a known founder effect. Waples and Teel (1990) discuss year-to-year changes in protein allele frequencies in Oregon hatcheries that they attributed to genetic drift due to small broodstock sizes. In a literature survey of genetic variation in many species, Nei and Graur (1984) found a small but statistically significant correlation between the level of protein heterozygosity and species-wide abundance. Latter et al. (1995) measured the rate of inbreeding at small effective population sizes in *Drosophila* and found that inbreeding as measured by homozygosity at specific marker loci increased somewhat more slowly than predicted by theory, although substantial inbreeding depression was still observed.

The empirical evidence to date points to a complicated relationship between levels of genetic diversity (as measured by protein or DNA heterozygosity) and population fitness or viability. O'Brien et al. (1983, 1985) suggested that very low levels of heterozygosity in the South African cheetah were correlated with poor fitness (low sperm counts, susceptibility to disease), but other authors have disputed these conclusions (e.g., Pimm 1991). In the case of the prairie chickens cited, a population that experienced a severe reduction in abundance was less fit than two other populations that maintained large population sizes (Bouzat et al. 1998a, b). Leary et al. (1983, 1985a, b) found a correlation between bilateral asymmetry and level of protein heterozygosity in rainbow trout and several studies have found correlations between protein

heterozygosity and fitness in marine invertebrates (e.g., Koehn et al. 1988). Saccheri et al. (1998) found a significant correlation between extinction and level of protein heterozygosity (itself correlated with inbreeding level in this study) in natural populations of butterflies in Finland. Quattro and Vrijenhoek (1989) found a significant correlation between protein heterozygosity and fitness in a Sonoran topminnow. Frankham (1995) summarized studies of genetic variation in a large number of endangered species and found lower than average levels of genetic variation in most of them. The predominance of sexual species and the relative rarity of old asexual lineages also argue for the general importance of genetic variation to animal populations (reviewed by Judson and Normark 1996). Although these and other studies certainly suggest that there is relationship between genetic diversity and population fitness across a wide variety of organisms, there are notable examples where a lack of genetic diversity has not stopped a population from persisting or growing, at least in the short term. In the case of the elephant seal cited, for example, the species has recovered from about 100 individuals in the late 1800's to 125,000 in 1989 (discussed in Caughley and Gunn 1996) despite its near lack of measurable genetic diversity. E.H. Bryant and co-authors have published a series of papers on the quantitative genetic effects of repeated bottlenecks in populations of houseflies and found that additive genetic variation in the morphological traits they measured generally was not reduced by even very severe bottlenecks (e.g., Bryant and Meffert 1990). Finally, in many cases it is difficult to untangle the effects of genetic diversity on population fitness from the effects of inbreeding on population fitness, because genetic diversity and inbreeding are often correlated.

A reduction in fitness associated with inbreeding (inbreeding depression) has been demonstrated for a wide variety of organisms in captivity (reviewed by Wright 1977, Thornhill 1993, Falconer and Mackay 1996, Lynch and Walsh 1998); these include rainbow trout and Atlantic salmon (reviewed by Tave 1993). Further examples of an association between inbreeding and a reduction in fitness or extinction in natural habitats include the evening primrose *Clarkia pulchella* (Newman and Pilson 1997), white-footed mice (Jimenez et al. 1994), and Finnish butterflies (Saccheri et al. 1998) and Sonoran topminnows (Quattro and Vrijenhoek 1989). Frankham (1998) estimated inbreeding coefficients in 210 populations found on islands and concluded that inbreeding depression was sufficiently high to be a contributing factor in the higher rates of extinction that island populations experience in comparison to mainland populations. Several studies have shown that the rate of inbreeding (as opposed to the final level achieved) has an effect on inbreeding depression. For example, Latter et al. (1995) and Latter (1998) found that when *Drosophila* were inbred at a slow rate (~1%/generation), the resulting inbreeding depression was less than the level of depression observed in other studies where the rate of inbreeding was higher. About 25% of the populations that inbred at this slow rate nevertheless went extinct due to genetic causes within a period of 200 generations.

The conservation literature contains a number of recommendations on guidelines for the minimum population sizes needed to avoid deleterious genetic effects. All of these recommendations are based on effective number of breeders per generation and for a number of reasons must only be considered as rough guidelines. In order to avoid inbreeding depression, Franklin (1980) suggested, based on empirical data from animal breeding studies, that an effective size of 50 was reasonable. Franklin (1980) and Soulé (1980) suggested that an effective population size of 500 is necessary to retain sufficient genetic variation for long-term population persistence. This value is based on estimates of the rates at which variation in an isolated population is added by mutations, and removed by drift and selection. Recently Lande

(1995) has pointed out that because ~90% of new mutations are unconditionally deleterious (and therefore do not contribute to future evolution), a more realistic long-term minimum viable effective population size may be closer to 5,000 per generation. Using similar arguments, Lynch (1996) has suggested that an effective size of ~1,000 is usually large enough for a population to maintain genetic variation. Based on the probability of losing rare alleles, Waples (1990a) has suggested that 100 effective breeders/year is necessary to maintain genetic variation in salmon populations in the short-term. These general recommendations have some limitations that must be understood before they are used to help determine levels of abundance necessary for viable salmonid populations. First, they are based on models of single, reproductively isolated populations. As the term is used in this document, a population is substantially reproductively isolated, but may receive low levels of gene flow from other populations. Gene flow, like mutation, is a source of genetic variation, so it is likely that populations connected by gene flow will have somewhat smaller minimum genetically viable population sizes than completely isolated populations. Second, the genetic parameters that form the basis for the Franklin (1980) and Lande (1995) recommendations were estimated from data obtained from only one species (*Drosophila melanogaster*), and must therefore be regarded as preliminary. Nonetheless, these recommendations may be reasonable as starting points for determining the minimum abundance necessary for long-term genetic viability, especially in the absence of additional information.

In order to convert these recommendations of effective population size per generation to salmon spawning abundance per year, it is necessary to know the ratio of the effective number of breeders to the observed number of breeders (N_b/N ratio) and the generation time for the population in question. Several studies suggest that a N_b/N ratio of 0.3 is approximately correct for salmon and steelhead in general (see following Assessment Methods). With this ratio, the recommended minimum long-term genetically viable population sizes discussed above range from 1,670/generation (Franklin 1980 and Soulé 1980) to 16,700/generation (Lande 1995). The minimum spawning size recommended by WDFW (1997) falls in this range (3,000/generation). For populations that spawn at multiple age classes, the spawners/generation value must be divided by the generation length (median age of reproduction) to obtain the corresponding numbers of spawners per year. For example, many chinook salmon populations have about a four-year generation time (reviewed by Healey 1991). A range of ~417 to ~4,170 breeders per year, therefore, may be reasonable minimum values for maintaining sufficient genetic diversity to ensure long-term persistence of chinook salmon populations. Based on genetic evidence, Allendorf et al. (1997) concluded that salmon populations with N_e below 500 (or N below 2,500) per generation would be at high risk and populations with N_e below 50 (or N below 250) per generation would be at very high risk. Wainwright and Waples (1998) noted that if demographic factors were included, thresholds for these categories would be higher, but they did not suggest specific values.

Demographic stochasticity

Demographic stochasticity refers to the effects of apparently random events associated with mate choice, fecundity, fertility, and sex ratio and tend to cause higher extinction risks in small populations than in large ones. Mathematical theory for extinction due to random variation in birth and death rates among individuals in a population was first developed in the 1930s (see Goodman 1987, Gabriel and Bürger 1992), but was first widely applied in developing island biogeography theory (MacArthur and Wilson 1967, Richter-Dyn and Goel 1972). The

importance of sex-ratio stochasticity has only recently been recognized and assessed (Gabriel and Bürger 1992). Most theory addressing demographic stochasticity has made the simplifying assumptions of density-independence and discrete generations with no age structure (e.g., Goodman 1987, Belovsky 1987, Lande 1993), although some has included density-dependence (e.g., Tier and Hanson 1981, Gabriel and Bürger 1992). In isolation, both birth/death rate variation and sex-ratio variation are important factors only at very low abundance (less than about 30 individuals), but in combination they become important at somewhat higher abundance (Gabriel and Bürger 1992), and even more importantly, when combined with environmental stochasticity (Tier and Hanson 1981, Goodman 1987). Lande (1998) demonstrated that demographic stochasticity reduces the mean rate of population increase (a form of depensation, as discussed previously), and this effect becomes stronger as population size declines.

Thus, it is clear that these effects are predominant at very low population abundance, so they are probably more important in establishing critical abundance levels than viable levels (which are more influenced by environmental stochasticity). Effects of demographic stochasticity increase roughly exponentially as population size declines (Goodman 1987, Lande 1993, 1998), but there is no clear critical point at which one can separate high-risk from moderate risk for a particular species or population. However, demographic stochasticity should be considered a risk factor for any population with abundance below a few hundred individuals.

Ecological feedback

Salmon are also important components of their ecosystems, and salmon population size is expected to have an effect on ecosystem function, which, in turn reflexively affects salmon abundance. In a sense, ecological feedback is similar to density-dependent processes, but it emphasizes the role of salmon in modifying their physical and biological environment. In contrast to classical density-dependence, ecological feedback typically involves time lags on the order of a generation or longer. Examples of such feedback include the role of salmon carcasses in riparian zone nutrient cycles, and the effect of spawning salmon on the quality of spawning gravels. Both these processes contribute to the success of future salmon generations, but are only significant at relatively high population densities.

Consider first the role of salmon in riparian zone nutrient dynamics. Salmon spawning areas are often nutrient poor, and salmon carcasses are an important pathway by which marine nutrients (important for both juvenile salmon and other species) enter both freshwater and terrestrial ecosystems (Kline et al. 1990, 1993, 1997, Bilby et al. 1996, 1998, Wipfli et al. 1998). There may be a critical average abundance level below which salmon production is nutrient limited, but this level is likely to vary according to local habitat conditions, and is clearly difficult to quantify. Similarly, redd-construction activities affect the size-distribution and stability of spawning-area sediments (Montgomery et al. 1996, Committee on Protection and Management of Pacific Northwest Anadromous Salmonids 1996). Through this mechanism, abundance in one generation can affect the survival of future generations.

These processes are only two among many interactions between salmonids and their environment. Populations with abundance levels at which these interactions become effective in maintaining natural ecosystem processes have been termed **ecologically functional populations** (Connor 1988). Maintaining enough salmon to provide this level of function in freshwater,

estuarine, and marine environments will promote ecosystems with a full suite of population regulatory mechanisms that may be absent when populations are artificially depressed.

Assessment Methods

Salmon population abundance can be estimated in a variety of ways. Adult dam and weir counts, redd counts, spawner and carcass surveys, harvest estimates, and juvenile counts have all been used to estimate population abundance (see “Diversity,” p. 19, for relevant references). The quantity and quality of data vary considerably across species and geographical regions (e.g., Weitkamp et al. 1995, Busby et al. 1996, Myers et al. 1998) and accurate abundance estimates are only available for a small fraction of the salmon populations inhabiting the Pacific Northwest and California (e.g., WDF et al. 1993, Kostow et al. 1995). In some cases, estimates may be available for all of the populations in a river basin as a group, but not for each population individually (e.g., adult counts of steelhead at Columbia River dams). In other cases, accurate abundance data may be only available for a small number of index streams or stream reaches, and these estimates are used as proxies for other, presumably similar, populations or are expanded to produce basin-wide estimates. Although breeding population size estimates are usually most relevant for assessing status, juvenile abundance estimates may be the only information available for some populations. While juvenile data can be used to assess status, translating that data to adult abundance is not straightforward and requires substantial knowledge of local conditions—including typical survival rates and limiting factors. It is also important to recognize that the ESA and NMFS policy both focus on natural population abundance and the presence of naturally spawning hatchery fish can greatly complicate the interpretation of abundance.

Directly assessing a population's genetically effective size is usually more complicated than assessing abundance because effective size is based not only on the number of spawning fish but also on their variance in reproductive success (see Geiger et al. 1997). There are typically two ways in which a population's current effective population size can be directly measured. The first, reviewed by Caballero (1994), involves estimating effective population size from demographic parameters such as abundance, sex ratios, mating systems, and the fecundity distribution among individuals. The second general method involves estimating effective population size from patterns of genetic variation (reviewed by Waples 1991b). Neither method is routinely easy to apply, and it is likely that for practical purposes a population's effective size will often be inferred from the number of its spawners. In order to do this, it is necessary to have a general idea of the relationship between the effective number of breeders (N_b) and the actual number of spawners in a population. N_b/N ratios estimated from six populations of Snake River spring chinook and one population of Sacramento River winter chinook range from a low of 0.013 (Bartley et al. 1992) to a high of 0.7 (Waples et al. 1993, R. Waples⁷) and average approximately ~0.2 to ~0.4. The large range is most likely due both to large sampling errors in estimating N_b and real biological differences among populations.

⁷ Robin Waples, NWFSC, 2725 Montlake Blvd. E, Seattle, WA 98112. Pers. comm.

Guidelines

In light of the preceding discussion, we have developed a set of guidelines (following) for assessing adequacy of a population's abundance. Note that the ESA's primary focus is on natural populations in their native ecosystems (e.g., Waples 1991c, Hard et al. 1992). When evaluating abundance for the purposes of determining VSP status it is essential to focus on naturally produced fish (i.e., the progeny of naturally spawning parents). Because risk to populations depends largely on specific life-history strategies and the local environment, it is not possible to use simple population theory to rigorously determine adequate abundance levels. For this reason, the following guidelines prescribe factors that need to be considered, but do not provide specific numerical criteria.

The following guidelines are separated into two general categories: 1) those defining a viable population, and 2) those identifying critically low abundance. A population would be considered to have viable abundance only if all of the viability guidelines are met, i.e., the guideline requiring the highest abundance in any given situation will effectively determine whether that population is considered viable. A population would be considered to be at critically low abundance if any of the critical guidelines were met. Also, note that different elements are likely to dominate decisions for different populations—for example, viability Guidelines 2 and 4 (Box A2) would be most restrictive for populations with extensive habitat available, while 1 and 3 would be most restrictive where habitat capacity is limited. In addition, environmental variation (Guideline 1) will often dictate a minimum population size that is larger than genetic concerns would (Guideline 3).

Population Growth Rate and Related Parameters

Introduction

In this Appendix we discuss population growth rate (productivity⁸) and factors that affect population growth rate as parameters for assessing population viability. We also review how estimates of population growth rate and related parameters are considered in the context of processes that occur at larger spatial and temporal scales, and in relation to other parameters discussed in this document. Our purpose here is not to explore the myriad mechanisms which influence population growth rate and drive changes in population size, but rather to emphasize the importance of detecting such changes and how estimates of population growth rate and

⁸ We use the terms “population growth rate” and “productivity” interchangeably when referring to production over the entire life cycle. We also refer to “trend in abundance” which is the manifestation of long-term population growth rate.

Box A2. Viable Population Size Guidelines.

1. **A population should be large enough to have a high probability of surviving environmental variation of the patterns and magnitudes observed in the past and expected in the future.** Sources of such variation include fluctuations in ocean conditions and local disturbances such as contaminant spills or landslides. Environmental variation and catastrophes are the primary risks for larger populations with positive long-term average growth rates.
2. **A population should have sufficient abundance for compensatory processes to provide resilience to environmental and anthropogenic perturbation.** In effect, this means that abundance is substantially above levels where compensatory processes are likely to be important (see following Critical Guideline 1, Box A3) and in the realm where compensation is substantially reducing productivity. This level is difficult to determine with any precision without high quality long-term data on population abundance and productivity, but can be approximated by a variety of methods.
3. **A population should be sufficiently large to maintain its genetic diversity over the long term.** Small populations are subject to various genetic problems (including loss of genetic variation, inbreeding depression, and deleterious mutation accumulation) that are influenced more by effective population size than by absolute abundance.
4. **A population should be sufficiently abundant to provide important ecological functions throughout its life-cycle.** Salmonids modify both their physical and biological environments in various ways throughout their life cycle. These modifications can benefit salmonid production and improve habitat conditions for other organisms as well. The abundance levels required for these effects depend largely on the local habitat structure and particular species biology.
5. **Population status evaluations should take uncertainty about abundance into account.** Fish abundance estimates always contain observational error, and therefore population targets may need to be much larger than the desired population size in order to be confident that the guideline is actually met. In addition, salmon are short-lived species with wide year-to-year abundance variations that contribute to uncertainty about average abundance and trends. For these reasons, it would not be prudent to base abundance criteria on a single high or low observation. To be considered a VSP, a population should exceed these criteria on average over a period of time.

Box A3. Critical Population Size Guidelines.

- 1. A population would be critically low if depensatory processes are likely to reduce it below replacement.** The specific population levels where these processes become important are difficult to determine, although there is theory on mate choice, sex-ratios, and other population processes that may be helpful in placing a lower bound on safe population levels. In general, however, small-population depensatory effects depend largely on density rather than absolute abundance. A species' life-history and habitat structure play large roles in determining the levels at which depensation becomes important.
- 2. A population would be critically low if it is at risk from inbreeding depression or fixation of deleterious mutations.** The most important genetic risks for very small populations are inbreeding depression and fixation of deleterious mutations; these effects are influenced more by the effective breeding population size than by absolute numbers of individuals.
- 3. A population would be critically low in abundance when productivity variation due to demographic stochasticity becomes a substantial source of risk.** Demographic stochasticity refers to the seemingly random effects of variation in individual survival or fecundity that are most easily observed in small populations. As populations decline, the relative influences of environmental variation and demographic stochasticity changes—with the latter coming to dominate in very small populations.
- 4. Population status evaluations should take uncertainty regarding abundance into account.** Fish abundance estimates always contain observational error, and therefore population targets may need to be much larger than the desired population size in order to be confident that the guideline is actually met. In addition, salmon are short-lived species with wide year-to-year abundance variations that contribute to uncertainty about average abundance and trends. For these reasons, it would not be prudent to base abundance criteria on a single high or low observation. To be considered critically low, a population should fall below these criteria on average over a short period of time.

related parameters are useful for evaluating population health. We focus on population growth rate and related parameters as integrated indicators of a population's performance in response to its environment. Specific characteristics of a population's environment that affect its dynamics, while likely to be similar across populations are necessarily deferred to individual case studies. In most cases, we are concerned with estimating a mean parameter that describes some aspect of population dynamics (such as long-term population growth rate), and with estimating the variance of this parameter. Depending on the question or parameter of interest, estimates of variance may contribute to descriptions of uncertainty in parameter estimates, which in turn support analysis of the consequences of decisions based on such estimates. Alternately, estimates of variance in a population's dynamics may play an integral role in evaluating the viability of a population. While it is intuitively sensible to use population growth rate as an indicator of risk and viability, the issue of how to do so in a quantitative way is still an area of active research.

Estimating population growth rate and related parameters generally follows one of two closely related approaches: 1) using time series analysis and related techniques to identify temporal patterns, or 2) using various analyses to identify functional relationships that describe the dynamics of a population. For the most part, analyses that contribute most significantly to assessing a population's viability will fall under the first approach, time series analysis. Estimating long-term mean and variability in population growth rate are a prime example that is discussed in some detail as follows, but evaluating changes in other parameters relevant to population growth rate are also addressed using similar techniques. Estimating intrinsic productivity and the intensity of density-dependence affecting a population fall under the second approach.

Why population growth rate is important

In general, when assessing population status, any sustained trend in abundance and the corresponding estimate of long-term population growth rate are likely to provide the most obviously useful information. Declining abundance has been identified as a prominent risk factor for salmonid populations (Nehlsen et al. 1991, WDF et al. 1993, Weitkamp et al. 1995, Busby et al. 1996, Allendorf et al. 1997, Myers et al. 1998). We also consider trends in abundance—which reflect of long-term mean population growth rate—to be important measures of population viability. Analysis of stochastic population models emphasize long-term population growth and temporal variance in population growth rate as important factors in determining a population's extinction dynamics (Lande 1993, 1998, Middleton and Nisbet 1997, Foley 1997, Fagan et al. in press). This approach rests on the assumption that past observations provide a useful predictor of future dynamics. This means that the population is expected to exhibit future dynamics consistent with those observed in the past, both in terms of the mean trajectory and the level of variation over time.

While estimates of long-term mean population growth and its associated variance are essential for assessing population viability, other temporal patterns or substantial departures from previously consistent patterns may provide useful information for assessing the status of a population in an appropriate context. For instance, some temporally variable processes, such as quasi-cyclic patterns in marine conditions (Beamish et al. 1999, Hare et al. 1999), may drive

important, but transitory, changes in productivity with obvious implications for abundance. Temporal autocorrelation in factors affecting productivity may also have important implications for population viability (Foley 1997) and for our ability to detect systematic changes in population abundance (Bence 1995). Thus, the potential existence of temporal patterns other than smooth monotonic trends in time series of abundance (or other productivity-related parameters) should not be ignored.

Although trends can arise as a consequence of simple random variation in the environment (e.g., a sequence of low productivity years analogous to a run of “heads” in sequential flips of a coin), we are most concerned with trends in abundance or productivity-related parameters that indicate systematic changes in a population's dynamics. Accordingly, we make the assumption that systematic changes in conditions that affect population growth rate, rather than stochastic random walks, underlie any sustained trend in abundance. Some evidence suggests that the major extinction risk for Pacific salmonids does not arise from stochastic processes but rather from processes, such as habitat degradation or overharvest. These processes exert a sustained detrimental effect on a population and result in chronically low population growth rate and a negative trend in abundance (see Emlen 1995, Ratner et al. 1997). Under this scenario, small population size is simply a transient stage on the way to deterministic extinction, and while stochastic processes certainly affect the time to extinction, they do not affect the likelihood of the outcome. Where appropriate, as in discussions of statistical power to detect a trend of a given magnitude, we treat changes in abundance due to environmental stochasticity as “noise” that acts to obscure persistent trends. But, we also emphasize the importance of variance in population growth rate in understanding the extinction dynamics of populations. Estimates of the magnitude of such “noise” are a vital parameter in any evaluation of population viability.

Why intrinsic productivity and density dependence are important

Population growth rate, as previously defined, reflects realized productivity. However, assumptions regarding the existence of density dependence in a population's dynamics (whether or not future changes in population size are related to population size in relation to resources now or at some time in the past) can have profound implications for predictions of extinction dynamics as part of evaluating a population's viability (Ginzburg et al. 1990). Therefore, intrinsic productivity (the maximum production expected for a population sufficiently small relative to its resource supply not to experience density dependence) remains an important parameter for evaluating population status, as does its complementary parameter carrying capacity. Parameter carrying capacity measures the size of a population sustainable by the environment. Fortunately, the assumption that a population exhibits dynamics independent of population size (i.e., density independence) offers a conservative initial evaluation of a population's status.

Intrinsic productivity is an important indicator of population viability for at least two reasons. First, it is a measure of a population's ability to rebound from short-term environmental or anthropogenic perturbations (resilience). Second, intrinsic growth rate partially determines the abundance at which demographic stochasticity begins to play an important role in determining the fate of the population (Lande 1998).

Carrying capacity is a function of intrinsic productivity and the intensity with which density-dependent mechanisms affect individuals in a population (itself, in turn, a function of the capacity of the environment to support a population). Capacity parameters are important for evaluating population viability in that they describe the scope for a population or some component of a population to exceed requisite abundance thresholds (see “Population Size,” p. 12, for further discussion of abundance).

A suite of difficulties limits our ability to estimate a population's intrinsic productivity and the intensity of density dependence affecting a population accurately. Therefore, despite some possible solutions to these problems (discussed as follows), we do not advocate criteria for viability based solely on the intrinsic productivity of a population, although such estimates may provide a useful context for evaluating the status of a population and its potential for recovery. Of course, for some populations, particularly depleted populations, density dependence may not be detected, and density-independent models may provide a suitable, parsimonious description of the data. This assumption should be tested whenever possible, with the recognition that using a density-independent model represents a conservative default approach. Also, for some populations, available data may support construction of more detailed models (e.g., Emlen 1995, Botsford and Brittnacher 1998, Ratner et al. 1997). We will not debate here the degree to which increasingly complex models provide better support for viability assessments. In other cases, data are rare or of poor quality, and models provide a simple heuristic framework for making preliminary evaluations and identifying data priorities.

Why stage-specific productivity is important

Population growth rate (production realized over the entire life cycle) is the bottom line of any population assessment. However, estimates of stage-specific productivity (productivity realized over some discrete portion of the life cycle) may provide important supplemental information for evaluating a population's viability and the scope for improvement in a population's performance. For instance, estimates of stage-specific productivity may support efforts to relate population growth rates to other parameters used in viability assessments and to other conservation or restoration frameworks (e.g., PFC). This is true both for estimates of realized stage-specific production and for estimates of intrinsic productivity and capacity parameters that describe stage-specific dynamics.

Accounting for known changes in productivity during a specific life-history stage may be the only way to identify opposing trends in productivity during other life-history stages that are otherwise masked in estimates of productivity over the entire life cycle. For example, spawner:spawner ratios for coho salmon along the Oregon coast suggest stable levels of production over the last 40 years. However, a drastic reduction in harvest mortality in recent years masks what appears to be a substantial decline in production of pre-harvest recruits in these populations (Box A4). In this case, failure to resolve stage-specific production and to recognize the opposing effects of changes in pre-harvest recruit:spawner productivity and spawner:pre-harvest recruit productivity might have prevented recognition of a decline in production of pre-harvest recruits that, if not arrested, would result in declines in abundance that could no longer be offset by reductions in harvest. In a similar example, redd counts of summer chinook salmon in the Similkameen River have exhibited an approximately stable level over the last several

Box A4. Incorporating stage-specific productivity data in evaluations of abundance and productivity trends: harvest estimates for coho salmon (*Oncorhynchus kisutch*) from coastal Oregon.

Estimates for (pre-harvest) recruits per spawner and escapement per spawner for coho salmon (*O. kisutch*) from the Oregon coast illustrate the importance of considering productivity over different portions of the life cycle when evaluating trends in abundance. Figures A4 and A5 show estimates of recruits per spawner (R:S)—an estimate of productivity from spawners to “recruits,” and spawners per spawner (S:S)—an estimate of productivity over the entire life cycle for three gene conservation groups (GCGs, as defined by ODFW). For all three GCGs, R:S values have been declining, while S:S values suggest a relatively stable pattern hovering near replacement. Exploitation of coastal Oregon coho salmon has been historically high (40-90%), but it has been declining in recent years (Figure A6). The failure of Oregon coho salmon populations to rebound following the reduction in fishing mortality provides evidence that the production of pre-harvest recruits has declined as well.

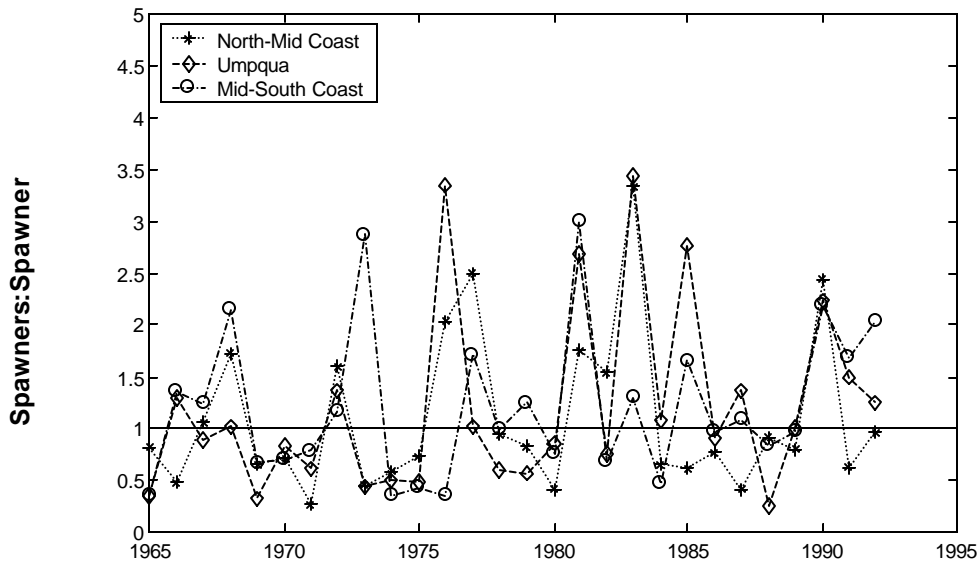

Figure A4. Estimates of spawner:spawner production for Oregon coastal coho salmon (*Oncorhynchus kisutch*) in three GCGs.

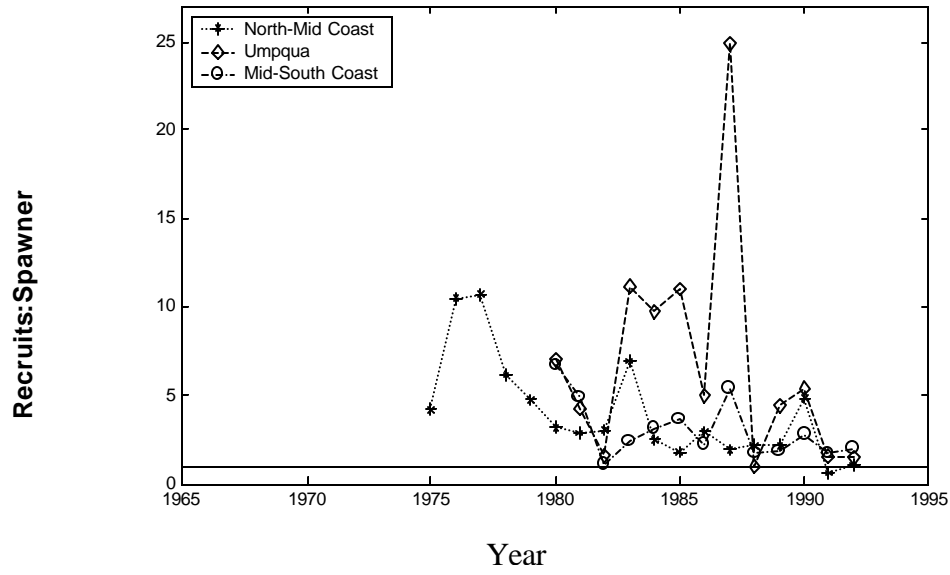

Figure A5. Estimates of pre-harvest-recruit:spawner production for Oregon coastal coho salmon (*Oncorhynchus kisutch*) in three GCGs.

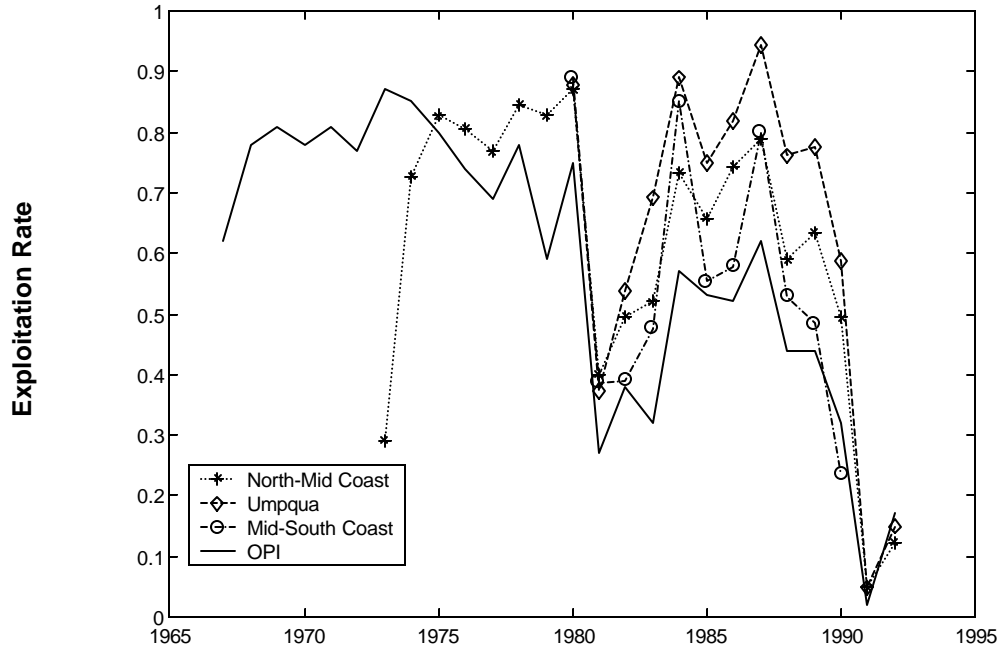

Figure A6. Estimates of exploitation rates for three GCGs (North-Mid Coast, Umpqua, Mid-South Coast) of Oregon coastal coho salmon (*Oncorhynchus kisutch*) and estimated total exploitation rate for coho salmon in the Oregon Production Index Area based on analyses of coded wire tag recoveries. Note the sharp decline in exploitation rate beginning in the late 1980's and extending through the early 1990's.

decades, but the harvest rate on this population has fallen substantially over the same time period. This suggests that the population's productivity may have declined as well (Waknitz et al. 1995).

Note that in both examples discussed, we are unable to determine conclusively whether the apparent decline in realized productivity is a consequence of declining intrinsic productivity or due to increasingly strong density-dependent limitation. Mobernd et al. (1997) point out that declines in either productivity or environmental capacity that affect a particular life-history stage can exert similar overall effects on production through the entire life cycle. Estimates of stage-specific productivity are therefore important for populations in which individuals' use of resources (e.g., duration of the life cycle spent in a given habitat) varies substantially among life-history trajectories such that distinct life-history variants respond differently to changes in environmental conditions that affect a specific life-history stage (e.g., Mobernd et al. 1997, Box A5). Variation in population growth rates linked to differences in stage-specific dynamics among alternative life histories has obvious implications for life-history diversity in a population and vice versa (see following and "Diversity," p. 19).

Understanding the dynamics of stage-specific productivity and how they affect population viability may also be important for situations in which the dynamics of one life-history stage dominate the dynamics of the entire life cycle. For example, a lack of habitat suitable for overwintering parr is thought to limit smolt production in some populations of coho salmon along the Oregon Coast to the degree that the parr experience a "bottleneck" with the potential to mask productivity changes in earlier history stages or to limit the capacity of a watershed to produce adults (Nickelson et al. 1992, Bradford et al. 1997). In this case, estimates of intrinsic productivity and capacity for other life-history stages indicate the potential for the population to increase in abundance should conditions that limit overwinter survival be ameliorated.

Why ancillary data relevant to productivity are important

Ancillary data relevant to productivity include measurements of any characteristic having clear links to reproductive success or survival, such as size of outmigrating smolts or size- and age-at-maturity of adult fish. Incorporating such data into status evaluations is analogous to examining stage-specific productivity, in that it may provide opportunity to detect changes that may be of little importance in current population dynamics, yet may influence a population's overall productivity in the future.

One example where ancillary data were used as part of a risk assessment is the case of Puget Sound/Strait of Georgia coho salmon (*Oncorhynchus kisutch*). In this assessment, a sustained decline in size-at-return of adult fish was interpreted as an indication of increased risk for Puget Sound/Strait of Georgia coho salmon populations (Box A6, Weitkamp et al. 1995). In contrast, coho salmon populations from rivers along the outer coast of Washington State exhibited consistent size-at-return. Additional risks related to changes in size-at-return were not inferred for these populations. Declines in size-at-return and, in some cases, increases in age-at-return have been documented in a number of salmon stocks (Ishida et al. 1993, Bigler et al. 1996, Pyper and Peterman 1999). Either may be expected to reduce a population's productivity.

Box A5. Population dynamics in stage-structured populations and the fate of different life histories in a population.

Mobrand et al. (1997) used a stage-structured model to illustrate how changes in environmental conditions exert different influences on different life-history variants and how that may underlie observed changes in the proportions of different life-history types in a population of spring run chinook salmon (*Oncorhynchus tshawytscha*) in the Grand Ronde River (Figure A7). Life histories that require different series of habitats experience environmental changes differently, such that some strategies have been rendered entirely unviable by observed changes, while others remain extant, although at depressed levels.

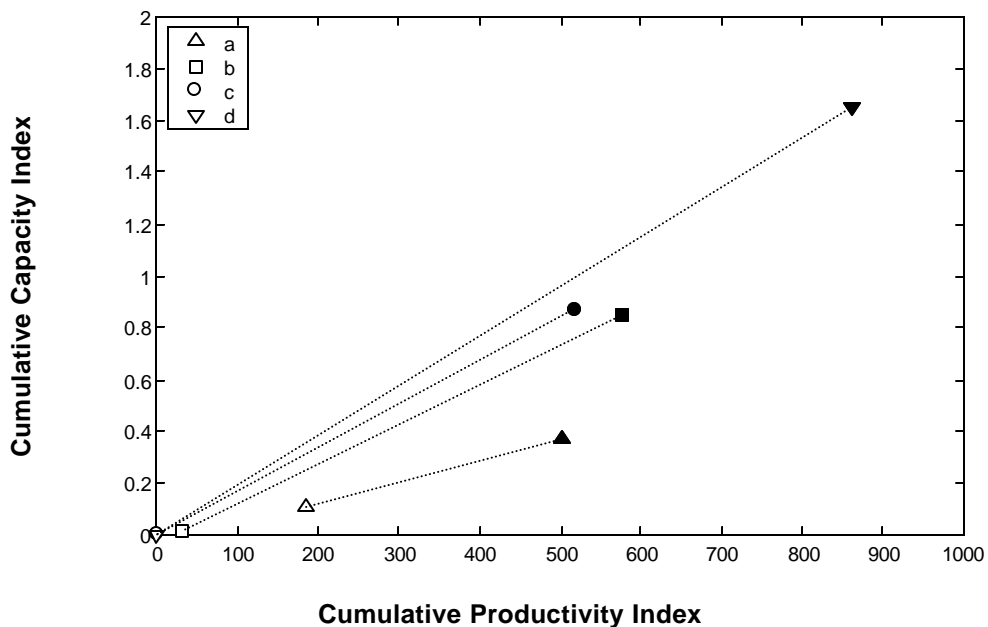

Figure A7. Changes in parameters of a composite Beverton-Holt model for smolt yield as a function of prespawner abundance for four putative life-history variants of spring chinook salmon (*Oncorhynchus tshawytscha*) in the Grande Ronde River (redrawn from Mobrand et al. 1997, Lestelle et al. 1996.). Filled symbols indicate estimated historical values; open symbols indicate estimated current. Life history variants differ in timing and usage of freshwater habitats by juveniles prior to downstream migration. They may be described roughly as follows: (a) freshwater rearing through the summer and winter; following emergence occurs solely in the upper reaches of the watershed where spawning takes place, (b) freshwater rearing occurs in upper reaches of the watershed during the summer after emergence, followed by substantial downstream displacement in the fall and overwintering in lower reaches of the river, (c) freshwater rearing through the summer and winter; following emergence occurs just downstream from habitats where spawning takes place—downstream dispersal occurs immediately after emergence, and (d) early freshwater rearing occurs in the same pattern as in (c), but individuals move downstream and leave the Grande Ronde watershed before the onset of winter.

Box A6. Example of ancillary data relevant to population viability: trends in size of coho salmon from different regions.

Figures A8 and A9 illustrate regional-scale trends in the size of adult coho salmon from watersheds along the Pacific coast of Washington State and from watersheds emptying into Puget Sound. Adult coho size was generally stable (and perhaps increasing) in coastal populations but declined substantially in Puget Sound populations.

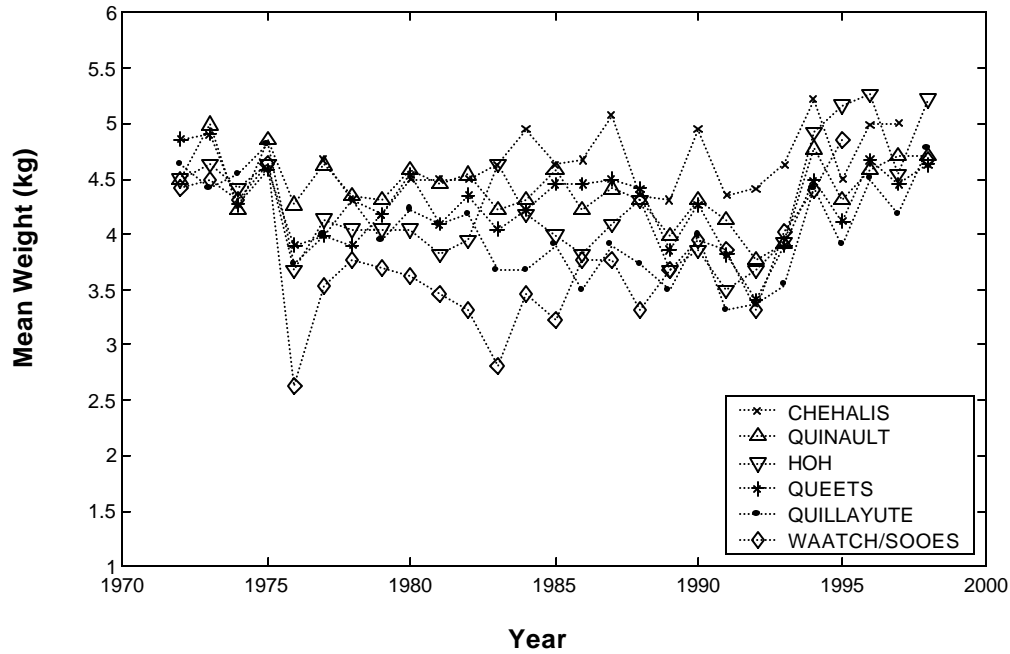

Figure A8. Mean weights of coho salmon from rivers on the outer coast of Washington State. Rivers are listed in order from south to north.

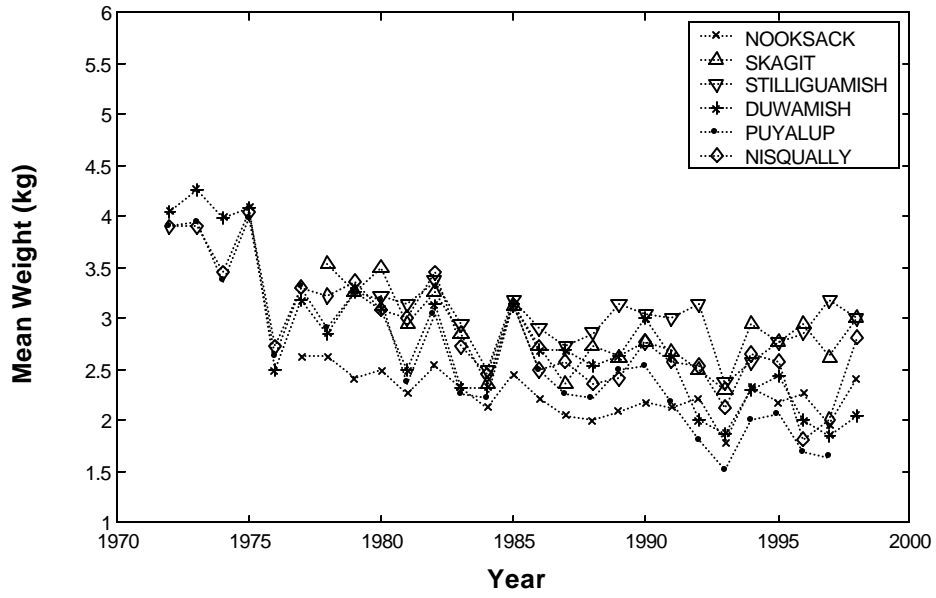

Figure A9. Mean weights of coho salmon from rivers in Puget Sound. Rivers are listed in order from north to south.

Reduced size-at-maturity has obvious implications for individual fecundity and may reduce individuals' ability to reach upstream spawning grounds (Hinch and Rand 1998) or to dig redds sufficiently deep to resist scour (DeVries 1997). Delayed reproduction subjects individuals to greater pre-reproductive mortality risk, although this may be partially or completely offset by increases in size (and hence fecundity) with age. Density-dependent effects, possibly related to hatchery production or other production enhancement practices, have been implicated as underlying causes for changes in size- and age-at-return (Ishida et al. 1993, Bigler et al. 1996, Pyper and Peterman 1999). Size-selective harvest also alters the size- and age-at-maturity in a salmon population—usually it reduces both because the selection is against larger fish that mature at older ages (Healey 1986, Hankin 1993). In the latter case, productivity may actually appear to increase at the cost of reduced life-history diversity (Hilborn 1985).

Estimating Population Growth Rate and Related Parameters

For applications to field data, both analytical approaches previously mentioned use time series of estimated abundance for one or more life-history stages. Numerous methods have been developed for estimating abundance at various stages in the salmonid life cycle (e.g., Hankin and Reeves 1988, MacDonald and Smith 1980, English et al. 1992, Irvine et al. 1992, Dempson and Stansbury 1991, Labelle 1994, Hilborn et al. 1999). Obviously, the quality of data used to evaluate any parameter relating to population viability strongly affects the reliability and level of uncertainty associated with the results of the analysis. Most techniques for estimating abundance provide some estimate of the magnitude of observation error (the area-under-the-curve technique for estimating spawner escapement is a notable exception, yet appears to outperform other analyses in terms of accuracy [English et al. 1992, Hilborn et al. 1999]).

Our focus in this Appendix is on understanding the dynamics of individual populations—this is explicitly assumed in our discussion of issues related to intrinsic productivity and density dependence. Note that spatial structure can have profound implications for estimating population growth rate, detecting important trends, and understanding population dynamics. Spatial variation in population dynamics, particularly source-sink dynamics (*sensu* Pulliam 1988), can obscure trends in abundance (Brawn and Robinson 1996, Cooper and Mangel 1999). A population's dynamics may depend importantly on interactions with other populations during life-history stages that share a common habitat (Bigler et al. 1996, Pyper and Peterman 1999, Bjorkstedt SWFSC, unpublished results). Depending on rates of dispersal, metapopulation structure may introduce non-linear dynamics in which a rapid “crash” to lower abundance or even extinction may occur with little or no warning in the form of declining trends (Hanski et al. 1994). Spatial structure is discussed in greater detail in “Spatial Structure,” p. 18.

Two issues relevant to data quality also bear special emphasis. First, failure to use appropriate sampling designs may generate data that are not necessarily representative of the population as a whole (e.g., counts from non-representative index reaches may reflect abundance only in the most productive areas of a population's range). This can strongly affect the validity of parameter estimates and any viability assessment based on biased data and analysis. Meir and Fagan (2000) find that systematic over- or underestimates of abundance generally have little impact on estimated extinction dynamics. However, they assume that such estimates, although

biased, are a simple multiplicative function of actual abundance while we are more concerned here with cases in which abundance estimates are non-representative and reflect actual abundance in a strongly non-linear way. For example population abundance estimates based solely on counts in productive reaches may miss important declines in abundance as the distribution of the population contracts into favorable habitats.

Second, analyses must be sure to avoid the influence of spurious autocorrelations arising as a consequence of ignoring inherent temporal structure in the data. For example, some salmonid populations exhibit limited life-history variability and thus have consistently independent broodyear cycles (e.g., pink salmon, coho salmon in the southern part of the species range, and sockeye salmon). Autocorrelation is likely to be apparent in abundance time series for such populations, primarily at time lags corresponding to the average generation time. For example, the persistence of dominant, sub-dominant, and weak broodyear cycles in many sockeye salmon populations, the independence of even- and odd-year pink salmon runs, and the disparity in abundance between broodyear cycles of coho salmon in central California are all cases of spurious autocorrelation in abundance time series. Such autocorrelation, if unaccounted for, tends to inflate the variance in the data. Unaccounted for autocorrelation also hinders attempts to detect trends in abundance, estimate population growth rate, or discern underlying functional relationships that describe population dynamics. Real autocorrelation, whether due to intrinsic or extrinsic causes, has an important influence on extinction dynamics that bears on assessments of population viability (Foley 1997).

Estimating population growth rate and changes in other parameters

Observational time series of abundance (or other characteristics of populations or individuals) contain four sources of variation: 1) trend, 2) “interventions” or “epochs” marked by unusual shifts in the underlying pattern or short-term departures from “regular” patterns, respectively, 3) autocorrelation arising from intrinsic factors (e.g., density dependence, sequential “baby-boom” signals at intervals that correspond to generation times) or extrinsic factors (e.g., autocorrelated environmental forcing), and 4) random error (Barker and Sauer 1992, Thomas 1996). A number of statistical techniques exist for analyzing time series for trends and other temporal patterns. Unfortunately, though the literature contains some guidelines for using different analytical techniques (e.g., Berryman et al. 1988), there is no clear guidance on how to approach time series analysis, and thus model selection remains a fairly subjective process (Jassby and Powell 1990, Thomas 1996, and references therein). Therefore, we recommend, as have others (Thomas 1996, Mangel and Hilborn 1997), pursuing multiple approaches, testing the statistical power of alternative methods to discern temporal patterns of interest, such as trends of a given magnitude and direction, and comparing the ability of alternative models to describe the data.

Detailed analysis of temporal variation in a time series of abundance data might include examining a suite of time series models that include various combinations of autoregressive terms, moving averages, intervention terms, covariates, etc. However, available time series are often short, particularly time series of abundances at scales appropriate to individual populations. Therefore, we focus on simple approaches as follows, and touch upon relevant aspects of more complicated temporal patterns that provide context for evaluating population viability in terms of

estimated population growth rate. The latter include addressing the influence of (non-spurious) serial autocorrelation, detecting rapid, step-like changes in a time series through intervention analysis, and analysis of singular or rare short-term events through epoch analysis. We focus the discussion that immediately follows on approaches for estimating population growth rate and issues that must be considered when doing so. However, much of what follows is also applicable to detecting trends and other temporal patterns in other parameters relevant to productivity.

Estimating population growth rate and detecting trends

Productivity is typically measured as the ratio between the number of recruits from a given broodyear and the number of spawners in that broodyear. Multiplying the abundance of spawners by this ratio yields the number of recruits. By extension, the growth rate of a population over multiple generations is, at least approximately, the product of productivities for each generation. The mean growth rate of a population corresponds to the slope of a plot of estimated abundance—following appropriate transformation—against time. For species that have determinate semelparous life histories and non-overlapping generations, long-term population growth rate is the simple product of population growth rate realized by each generation. Life history variation and overlapping broodyear cycles in anadromous salmonids requires more complicated analyses to estimate population growth rate, both for a single generation and over a longer time period. Not surprisingly, developing accurate estimates of the mean and variability in a population's growth rate requires a) abundance estimates for a period spanning several generations, and b) information on life-history variation in the population.

Regression-based approaches provide relatively simple means for estimating trends in time series and are a useful way to analyze short time series. Thomas (1996) lists four general types of regression analysis and discusses the advantages and disadvantages of each. To estimate population growth rate, regression methods based on exponential (linear-multiplicative) models are the simplest and most appropriate approach. In essence these analyses amount to fitting an additive model to logarithmically transformed abundance data. For other parameters of interest, such as changes in size-at-return, other regression models may be more appropriate since the mechanism is not so clearly a multiplicative process as it is in the case of population growth.

Regression analysis, using an exponential model, is an appealing approach to estimating population growth rate because it is conceptually simple, corresponds to the multiplicative nature of population dynamics, requires estimation of few parameters, and provides unbiased estimates of the trend even in cases where interventions and autocorrelation are present in the data set (Thomas 1996). Although temporal autocorrelation does not bias estimates of mean population growth rate, autocorrelation does result in the breadth of confidence intervals regarding the estimated trend being underestimated. This in turn, increases the likelihood of Type I error (i.e., erroneously reporting a non-existent trend or non-zero population growth rate) (Hurlburt 1984, Bence 1995).

Regression analyses are also appealing due to the relative ease with which statistical power can be estimated for regression analyses that are based on exponential models (Gerrodette 1987, 1991, Link and Hatfield 1990, Nickerson and Brunell 1997). Estimating statistical power

of an analysis allows the results to be evaluated. Evaluation focuses on the minimum effect that is detected given the quality of the data (the number of observations, the precision of the observations, etc.). Such information is essential for describing potential worst-case consequences of proceeding as if the analysis accurately represented true conditions (Peterman and Bradford 1987, Peterman 1990, Taylor and Gerrodette 1993, Korman and Higgins 1997).

Proceeding with a straightforward regression analysis on log-transformed abundance data is not appropriate—life-history variation must be accounted for lest it bias an analysis. One approach to dealing with difficulties arising from indeterminate life cycles and overlapping generations is to estimate so-called “cohort replacement rates” (Botsford and Brittnacher 1998). This may be accomplished by fitting the coefficients of a linear renewal equation (appropriately structured to accommodate the population’s life history) to a time series of abundance estimates. Doing so is relatively straightforward for populations in which life history is relatively inflexible so that spawning runs are strongly and consistently dominated by a single-age class and broodyear cycles are largely independent of each other (i.e., determinate, semelparous life histories). In such a case, recruitment in one year is related to spawner abundance one generation time in the past (e.g., two years for pink salmon, three for central California coho populations, and four for some Fraser River sockeye populations). For populations with more variable life histories (e.g., chum, chinook, and some populations of sockeye and coho), estimating productivity and other population parameters requires models that account for spawner age distributions and corresponding data to parameterize such models. For example, estimates of recruitment used to estimate productivity for a population of chinook salmon with a maximum age-at-return of 5 years old must equal the 3-, 4-, and 5-year old spawners originating from the same broodyear. In many cases, there is little data on yearly variation in the age composition of spawning adults, and a mean distribution based on a few years’ data, or data from another population must be used. Doing this introduces extra uncertainty into estimates of productivity, and may make it difficult to fit the model to abundance data (Botsford and Brittnacher 1998). This problem has been addressed in at least two population viability analyses for salmon populations. Botsford and Brittnacher (1998) estimated the distribution of cohort replacement rates for winter-run Sacramento River chinook salmon using a linear renewal equation approach under the assumption that population dynamics are density-independent. Emlen (1995) used a more intensive, simulation-based approach to estimate parameters for a density-dependent model for Snake River chinook salmon. Dennis et al. (1991) developed regression-based estimates of the mean and variance of population growth rate from abundance time series for use in a diffusion model for estimating extinction risk. This approach has been adapted to indeterminate semelparous salmonid life cycles (CRI, 2000).

Detecting other pattern in time series: autocorrelation, interventions, and epochs

Serial autocorrelation in abundance time series (the dependence of each observation on previous conditions) can accurately affect the ability to estimate the variance in population growth rate or variation about trends in other parameters. Estimating autocorrelation in short time series, typical of abundance data for salmonid populations is a difficult task. Bence (1995) explores techniques for adjusting variances estimated from short time series data for the effects of autocorrelation.

Intervention analysis provides a means of detecting rapid transitions between periods of relative stability in a time series of data (Box and Tiao 1975). Hare, Francis, and colleagues (Hare et al. 1999) used intervention analysis to identify periods of relatively high and low total regional salmon production in Alaska, and coinciding, out-of-phase patterns of productivity in the Pacific Northwest. Their analyses indicate that rapid shifts in salmon abundance and production appear to be driven by changes in large-scale climate patterns that exhibit similar step-like transitions. Note, however, that these results emerged from analyses conducted on aggregated data sets that comprised many populations and thus, reduced the contribution of observation error from any single population. Thus, intervention analysis is less likely to be applicable to abundance time series for a single population because of the greater relative effects of observation error in time series of abundance for individual populations.

Epoch analysis (Prager and Hoenig 1989, 1992) provides a technique for determining if an unusual event in a time series is related to unusual environmental conditions. One example that may prove useful in viability analysis is the case of identifying “outliers” that have a readily identifiable mechanistic basis, such as the dramatic effect of El Niño-Southern Oscillation (ENSO) events, on the productivity and abundance of a population.

Estimating intrinsic productivity and detecting density dependence

Much of ecology and fisheries science has focused on developing models and analyses to estimate intrinsic productivity and the intensity of density-dependence in populations. Detailed reviews of relevant analytical methods and applications may be found in Hilborn and Walters (1992), Quinn and Deriso (1998), and the extensive literature on stock-recruitment relationships (e.g., Iles 1994). Dennis, Taper and colleagues have developed statistical tests to detect density dependence in time series of abundance estimates (Dennis and Taper 1994, Dennis et al. 1998, and see Shenk et al. 1998 for discussion of the statistical validity of these tests). Examples of simple models commonly used to describe spawner-recruit relationships in salmonid populations include the Ricker (1954) and Beverton-Holt (1957) models. More complex models that accommodate life-history structure and environmental or ecological covariates may be useful in cases where data are sufficient to parameterize such models accurately. Also, analyses that employ maximum likelihood methods and information criteria offer a way to simultaneously fit and evaluate a large suite of models in order to identify the model form that best captures the information in the data (Zeng et al. 1998). Such methods have been successfully demonstrated in relatively data-rich systems but they have rarely been applied to salmon populations (but see Hooten 1995 for examples based on spring and summer chinook from the Columbia River). Bayesian analyses continue to be developed, and provide powerful techniques for estimating parameters while accounting for correlation among parameters and uncertainty associated with parameter estimates (Punt and Hilborn 1997, McAllister and Kirkwood 1998, Millar and Meyer 2000).

Critical assumptions

Fitting population dynamics models to time series of abundance requires two critical assumptions: 1) that the real functional relationship between spawners and recruits that underlies the observed data is stationary (Dennis et al. 1991, Hilborn and Walters 1992), and 2) that the

population is homogeneous (Hilborn 1985). For the assumption that the spawner-recruit relationship is stationary to hold, the average dynamics and magnitude of variability in the population must remain constant through time. Rapid changes in marine survival that appear to accompany large-scale changes in oceanographic conditions (reviewed in Hare et al. 1999) provide a natural case in which this assumption is violated. Anthropogenic actions, such as ongoing degradation of freshwater habitats, also cause non-stationarity in a population's underlying dynamics. In some cases, the data support a model that treats productivity or capacity as a function of time or environmental conditions in order to account for changes in the underlying dynamics of a population. In an analysis for spring-run chinook salmon (*Oncorhynchus tshawytscha*) in the Umpqua River, Ratner et al. (1998) used a model that incorporated an exponential decline in available habitat over time to model the observed negative trend in abundance. In another example, population dynamics of chinook salmon in the San Joaquin River, predicted by a model that treated recruitment as a function of river flow conditions better matched observed dynamics than did models that lacked environmental covariates (S. Lindley, SWFSC, unpublished data). Statistical analyses that use information criteria to guide model selection may help determine appropriate model structure (e.g., density dependence or independence, temporally variable or constant parameters, etc.) as well as estimate parameter values from population abundance data sets (Zeng et al. 1998, Lele et al. 1998).

The assumption that the population is homogeneous requires that: 1) the data are from a single, well-mixed population rather than a collection of populations that exhibit different demographic parameters (Ricker 1973, Hilborn 1985) or a population occupying a spatially heterogeneous habitat, and 2) that life-history variants do not represent independent groups within a putative population. When analyzing data from a structured population, differences in productivity or capacity among subpopulations and life-history variants must be taken into account, otherwise productivity is likely to be overestimated, particularly if the population is already in a depleted state (Hilborn 1985). This may have drastic implications for less productive populations and life-history variants that, not surprisingly, are more vulnerable to depletion. If subpopulations that comprise a population are linked by substantial migration, depletion of less productive populations may be less of an issue as more productive populations may be expected to subsidize less productive neighbors. Likewise, if life-history variation is not strongly heritable, the component of the population exhibiting a more productive life-history strategy may produce some offspring that exhibit alternative, less productive life histories. This in turn would subsidize less productive elements of life-history diversity within a population. However, heritability of life-history parameters, such as age-at-maturation (Hankin et al. 1993), may make any changes in population dynamics, related to shifts in life-history variation, difficult to counter or reverse.

Bias and methods for correcting it

Even when the assumptions required for fitting a simple population model to abundance data are satisfied, natural variability and measurement error may introduce substantial biases into spawner recruit estimates. In general, such analyses overestimate intrinsic productivity and the intensity of density-dependence, and underestimate serial autocorrelation (Walters and Ludwig 1981, Walters 1985, 1990, Korman et al. 1995, Myers and Barrowman 1995). Use of estimates

of population dynamics parameters biased in this way to estimate extinction risk will estimate risks that are much lower than actually exist in a population. An analysis of sockeye salmon stocks suggests that such biases appear to be strongest for populations with low productivity and strongly autocorrelated residual error (Korman et al. 1995). Thus, for populations that exhibit dynamics consistent with increased risk of extinction, biases in estimates of population dynamics parameters may lead to substantial underestimation of such risk and overestimation of population viability.

There are at least four methods for countering the biases inherent in analyses of functional relationships in the dynamics of a population: 1) using formulae that have been developed to partially correct for such biases (e.g., Walters 1990), 2) determining the relationship between parameter estimates and observation error using simulation methods and subsequently, using extrapolation to predict parameter values for data in which observation error is absent (Solow 1998, and references therein), 3) attempting to reduce unexplained process error by identifying and accounting for environmental signals in recruitment data (e.g., Welch 1986, Kope and Botsford 1988, Iles and Beverton 1998, S. Lindley, SWFSC unpublished data), and 4) simulating abundance data from population dynamics models that include parameters estimated from data, re-estimating the models from the simulated data, subtracting the different initial parameter estimates, and repeating the cycle as necessary (Ratner et al. 1997).

Analyses that incorporate stage-specific dynamics

Simple population dynamics models ignore any age- or stage-structure that may exist in a population, and are unable to capture important differences in how the abundance of different population components respond to changes in environmental conditions. However, in many cases, extending simple population models to accommodate life-history structure is a straightforward, albeit difficult, process that requires more data to parameterize the resulting models (for examples cast in diverse modeling frameworks, see Tuljapurkar and Caswell 1996 and references therein). Structured-population models allow analyses to incorporate information on stage-specific dynamics and thereby generate a more complete picture of a population's dynamics (see Emlen 1995, Botsford and Brittnacher 1998, Ratner et al. 1997). Models for structured populations (e.g., Mousalli and Hilborn 1986, Caswell 1989, Cushing 1996, Emlen 1995, Yamauchi and Matsumiya 1997, Bjorkstedt 2000) provide a framework for assessing potential population viability implications of changes in factors affecting stage-specific production (e.g., Mobernd et al. 1997). Such analyses typically consist of evaluating the sensitivity or elasticity that a structured-population model (in matrix form) exhibits in response to small changes in productivity parameters at a given life stage (Caswell 1989, Grant and Benton 2000). This is a powerful technique, but must be used with some caution to be sure its results do not conflict with biological reality (Mills et al. 1999).

Productivities estimated for discrete life-history stages are often treated as independent of productivity during other parts of the life cycle (e.g., freshwater v. marine survival [Bradford 1995]), and therefore taken as an indication of the "performance" of a population in a given habitat. This assumption may not always hold (see Bjorkstedt 2000 and references therein), which may have important implications for evaluating population viability and recovery options,

particularly for populations that interact in common habitats during some portion of the life cycle (Bjorkstedt, SWFSC, unpublished results).

Analyses of populations that include naturally spawning hatchery fish

The ESA and NMFS policy both focus on natural population abundance. The VSP definition is consistent with this in stating that a population that is dependent on hatchery production is not a viable one. Given the tight connection between abundance and productivity, it is therefore necessary to estimate natural productivity of hatchery-influenced populations rigorously. Special problems arise when attempting to estimate productivity for a population in which fish produced in hatcheries constitute a substantial proportion of the naturally spawning adults. Not surprisingly, estimates of natural productivity are very sensitive to errors in estimating the relative abundance of naturally produced and hatchery fish. Not surprisingly, valid estimates of natural productivity are impossible to obtain for supplemented populations in which the abundance of naturally-produced and hatchery-produced fish on the spawning grounds are not estimated separately.

The influence that naturally spawning hatchery fish have on natural productivity is governed by two factors: 1) relative reproductive success of naturally spawning hatchery fish and naturally born fish, and 2) density dependence in reproductive success, which in turn depends on the relative competitive abilities of hatchery- and naturally-produced fish and the proportion of each in the spawning population (Fleming and Gross 1993). Natural Return Ratios is defined as the number of naturally-produced fish that are born during a given broodyear and subsequently return to spawn, divided by the total number of fish on the natural spawning grounds (including naturally spawning hatchery fish) in that broodyear (Busby et al. 1994). The definition has been used as a measure of natural productions in previous population assessments. However, the calculation of NRR implicitly assumes density-independent population dynamics. This assumption detracts from the value of NRR as a measure of natural production. Box A7 discusses how the NRR concept may suitably be extended to analyzing populations that include naturally spawning hatchery fish. Note that in practice and in these analyses, offspring of naturally spawning hatchery fish, by virtue of having survived in the natural environment, are counted as natural spawners when they return.

From a purely demographic perspective, theoretical models provide some guidance for what proportion of a naturally spawning population may be of hatchery origin for that population to exhibit dynamics largely independent of hatchery influence. Hastings (1993), using a simple density-dependent model for two populations linked by dispersal, demonstrated that at least under some conditions, the abundance in one population remained uncorrelated with that of the other population, provided that immigration did not exceed approximately 10% of the receiving population (see Kendall and Fox 1998 for a more thorough treatment of this model). From an explicit metapopulation perspective, Dreschler and Wissel (1997) demonstrated that extinction dynamics for a local population could be treated as independent of larger scale dynamics so long as immigration remained at least at an order of magnitude smaller than the growth rate of the local population. Based on these two models, an initial guideline for the proportion of naturally spawning hatchery fish, in a population that is consistent with the natural population having independent dynamics, is approximately 10%. This corresponds to a (density-independent) NRR

Box A7. Estimating productivity in populations that include naturally spawning hatchery fish.

Estimating natural productivity from a population that includes naturally spawning hatchery fish requires information on the origin of spawners producing natural fish, i.e., the number of spawners born in the natural environments and the number of hatchery strays spawning in natural habitats. One measure of productivity typically calculated from such data is a Natural Return Ratio (NRR), calculated as:

$$NRR = \frac{R_N}{(S_N + S_H)} \quad (A7a)$$

Where R_N is the number of recruits from parents spawning in the natural environment (regardless of parental origin) that were born in a given broodyear, and the parental population giving rise to those recruits is made up of naturally-born fish, S_N , and hatchery fish, S_H , returning to the spawning grounds. Note that (A7a) implicitly assumes that hatchery fish have reproductive success equivalent to that of wild fish. Also, by rearranging the expression to solve for the number of recruits

$$R_N = NRR (S_N + S_H) \quad (A7b)$$

(and noting the similarity between the calculation of NRR and models of density-independent population growth), it is seen that the NRR explicitly disregards the possibility that density-dependence could affect a population. For these two reasons, the uncritical use of NRR in evaluating the productivity of a population is not recommended.

The sensitivity of NRR to violation of the two assumptions implicit in its calculation, may be addressed using simple, but more complete, models that incorporate productivity and density-dependence as functions of the abundance of both “hatchery” and “natural” spawners. A Beverton-Holt model for a wild population affected by hatchery strays may be written as

$$R_N = (S_N + f S_H) \left(\frac{\mathbf{a}}{1 + \mathbf{b}(S_N + g S_H)} \right) \quad (A7c)$$

where \mathbf{a} is the intrinsic productivity of the (wild) population, \mathbf{b} describes the intensity of density-dependence affecting the population, f indicates the relative (proportional) reproductive success of hatchery fish, g describes the (proportional) competitive effectiveness of hatchery fish under whatever density-dependent mechanisms limit reproductive success. (Note that g itself may be a function of the natural:hatchery composition of the spawning population [Fleming and Gross 1993], a complication that, for simplicity, we do not address here.) An analogous Ricker model may be written as

$$R_N = \mathbf{a}(S_N + f S_H) \exp\{\mathbf{b}(S_N + g S_H)\}. \quad (A7d)$$

Note that if $f = 0$ and $g = 0$, the wild population has dynamics independent of hatchery influence. Similarly, if $f = 0$ but $g > 0$, hatchery fish on the spawning grounds effectively reduce the productivity of the wild population but do not contribute to the next generation. If both $f > 0$ and $g > 0$, hatchery fish may contribute to natural production, but may limit the production of offspring from parents of natural-origin through density-dependent limitation or by matings between naturally- and hatchery-produced spawners. A case where hatchery fish contribute to wild production but do not exert a density-dependent effect (e.g., $f > 0$ and $g = 0$) is

biologically implausible (it is possible for hatchery fish to contribute to production without a density-dependent effect, but only if the wild component of the population also exhibits density-independent dynamics, e.g., $\mathbf{b} = 0$, in which case the value of g is irrelevant). The effect of increased density-dependent limitation of per capita productivity may be especially important if the number of strays is sufficient to cause the number of fish in the spawning population to exceed the population's normal carrying capacity (see discussion of pseudo-sinks in "Spatial Structure," p. 18).

An analysis of estimated spawners (partitioned by origin) for summer steelhead (*Oncorhynchus mykiss*) from the Wenatchee River illustrates the sensitivity of NRR calculated with Equation (Figure A10) to the reproductive success of hatchery fish relative to that of natural fish (Figure A10). Analyses using Ricker models, that incorporate different ways hatchery strays may affect the production of wild returns indicate that hatchery- and natural-born fish may have similar contributions to natural production of Wenatchee River summer steelhead (Figure A11). Note that this analysis does not attempt to estimate f or g —rather, this example is intended only to illustrate a proof of concept for incorporating more comprehensive population dynamics into estimation of natural production.

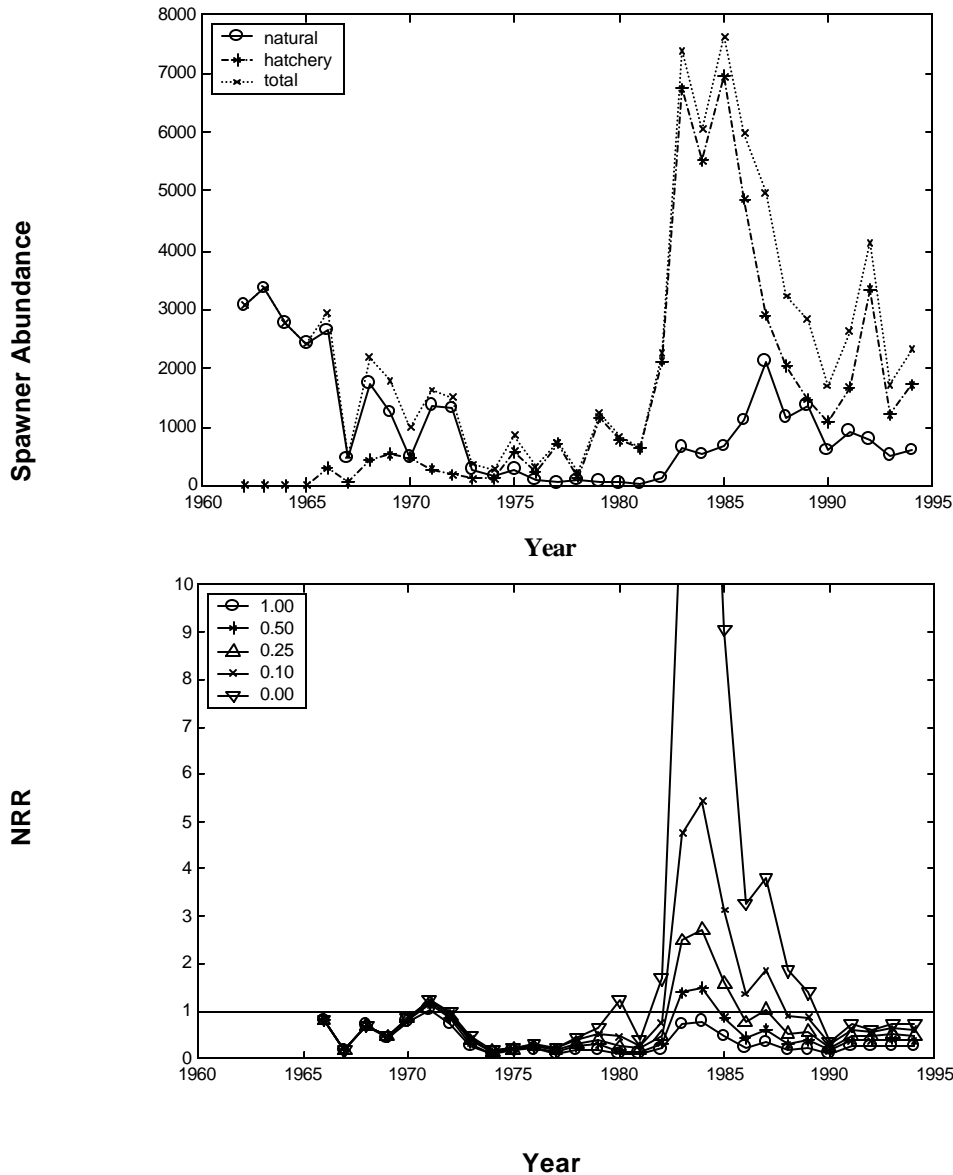

Figure A10. Top panel: estimated spawner escapement for Wenatchee River summer steelhead (*O. mykiss*), broken down into naturally spawning hatchery fish and spawners of natural origin (data from StreamNet). Bottom panel: Natural Return Ratio (NRR) calculated for a range of values describing the relative reproductive successes of hatchery- and natural-origin spawners (NRR reaches a maximum of 16 in calculations based on the assumption that hatchery strays contribute nothing to natural returns). In this example, the population's dynamics are assumed to be density-independent, and each estimate includes estimated production from 2-6 year old spawners (crudely based on data from Howell et al. 1985, as cited in Busby et al. 1996).

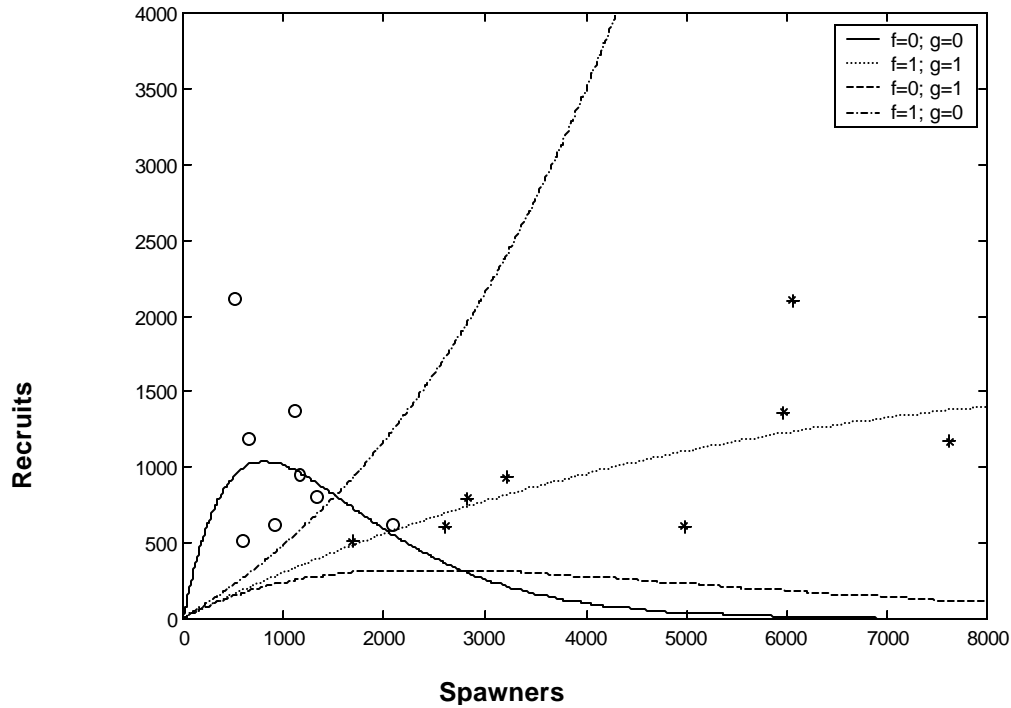

Figure A11. Examples of Ricker-type spawner-recruit models that include the influence of naturally spawning hatchery fish in different ways, fitted to data for Wenatchee River summer steelhead (*Oncorhynchus mykiss*) for 1984-1994. This time period was selected in an attempt to avoid violating the assumption of stationarity in the underlying dynamics—this period is marked by roughly consistent returns of natural spawners. Open circles are data for natural returns plotted against spawners of natural origin. Asterisks are data for natural returns plotted against combined spawners of both hatchery and natural origin. Each curve describes the best-fit model (Equation A7d) under a particular set of assumptions about the contribution and density-dependent effect of naturally spawning hatchery fish (see text for details). The parameters for the different curves are

f	g	a	b
0	0	3.47	-1.2×10^{-3}
1	1	0.33	-7.7×10^{-5}
0	1	0.36	-4.1×10^{-4}
1	0	0.40	2.0×10^{-4}

Note that the case of $f = 1$ and $g = 0$ —that is, a case in which a fish may contribute to production without exerting a density-dependent effect given that density dependence is significantly affects the population's dynamics—is biologically implausible. (If density dependence is non-existent, i.e., $b = 0$, the value of g is irrelevant.) This example is intended as an illustration only, and no attempt has been made in this example to find best fits for f and g in these models.

Box A8. Population growth rate and related parameters guidelines.

1. **A population's natural productivity should be sufficient to maintain its abundance above the viable level.** A population meeting or exceeding abundance criteria for viability should, on average, be able to replace itself. That is, spawner:spawner ratios or cohort-replacement ratios should fluctuate around 1.0 or above. Natural productivity is typically measured as the ratio of naturally-produced spawners born in one broodyear to the number of fish spawning in the natural habitat during that broodyear. Population abundance estimates at other life-history stages may also be used, provided such estimates span the entire life cycle (e.g., smolt to smolt estimates).
2. **A viable salmonid population that includes naturally spawning hatchery fish should exhibit sufficient productivity from naturally-produced spawners to maintain population abundance at or above viability thresholds in the absence of hatchery subsidy.** In a strict sense, this guideline suggests that the mean Natural Return Ratio (NRR) for a viable population should fluctuate around 1.0—indicating negligible hatchery influence on the population. In a practical sense, the requirement that a viable population be demographically independent of a hatchery population suggests that a viable population's mean NRR not be less than approximately 0.9, but this estimate neglects other issues related to the influence of hatchery fish on natural production. A viable population should not exhibit a trend of proportionally increasing contributions from naturally spawning hatchery fish.
3. **A viable salmonid population should exhibit sufficient productivity during freshwater life-history stages to maintain its abundance at or above viable thresholds—even during poor ocean conditions.** A population's productivity should allow it both to exploit available habitat and exhibit a compensatory response at low population sizes. When spawner abundance is below the long-term mean, there should be a corresponding increase in per capita smolt production, even though such an increase may not suffice to offset declines in marine survival.
4. **A viable salmonid population should not exhibit sustained declines in abundance that span multiple generations and affect multiple broodyear-cycles.** “Sustained” declines are those that continue longer than the typical lag in response associated with a population's generation time. Thus, sustained declines differ from rapid transitions between one stable level and another (e.g., changes in abundance related to large-scale, low frequency environmental forcing such as those related to oceanic regime shifts). They also differ from short-term, severe perturbations in abundance (such as those related to strong El Niño events) that are followed by relatively rapid recovery.
5. **A viable salmonid population should not exhibit trends or shifts in traits that portend declines in population growth rate.** Changes in such traits, such as size and age of spawners, that affect population growth rate are often more easily and precisely quantified than are changes in abundance and thus, may provide earlier indication of declining population growth rate. For example, reduced size of mature individuals in a population may indicate reduced fecundity, lessened ability to reach spawning grounds, a decreased capacity for constructing redds that are deep enough to resist bed scour, or other factors that contribute to reduced production of offspring. Likewise, increasing age-at-return may reduce a population's intrinsic productivity by exposing adults to greater pre-reproductive spawning risk.
6. **Population status evaluations should take into account uncertainty in estimates of population growth rate and productivity-related parameters.** To estimate long-term trends and spawner-recruit ratios, it is important to have an adequate time series of abundance. Unfortunately, such time series, when they exist at all, are often short and contain large observational errors, or both. These constraints may greatly limit the power of statistical analyses to detect ecologically significant trends before substantial changes in abundance have occurred.

of 0.9. It must be emphasized, however, that establishing criteria for natural production in hatchery-influenced populations must take into account factors besides the demographic measures discussed here, and are likely to require more conservative criteria than that suggested by the preceding argument.

Spatial Structure

Introduction

Any viability evaluation must consider spatial structure within a population (or group of populations) because spatial structure affects extinction risk in ways that may not be readily apparent from short-term observations of abundance and productivity (Hanski and Gilpin 1997, Tilman and Lehman 1997, Cooper and Mangel 1999). The spatial structure of a population refers both to the spatial distributions of individuals in the population and the processes that generate that distribution. Spatial structures that consist of groups of individuals in discrete patches are often generically referred to as “metapopulations,” though the term has assumed a variety of meanings over the years (Hanski and Simberloff 1997). A population’s spatial structure depends fundamentally on habitat quality and spatial configuration, and the dynamics and dispersal characteristics of individuals in the population.

Because many of the processes that affect small population extinction risk (e.g., genetic risks and demographic stochasticity) depend primarily on breeding structure, we will focus on spawning group distribution and connectivity. Restricting the discussion to spawning groups is a practical step in evaluating population viability, but it should be noted that spatial structure is likely to be important during all life-history stages.

Spatial structure in spawning aggregations of salmonids is a natural consequence of the species’ ability to home to natal watersheds, natal tributaries within watersheds, and (potentially) natal reaches within tributaries. Homing provides a mechanism for maintaining a hierarchy of reproductive isolation among groups of fish that reflects the dendritic structure of watersheds (Policansky and Magnuson 1998). Straying (i.e., the return of individuals to freshwater habitats other than that in which they were born—Table A1) offsets both the demographic and genetic isolation of such groups. We refer to groups of fish that are relatively reproductively isolated from other groups within a population as “subpopulations”.

In this section we first briefly describe general spatial structure patterns that may occur and then discuss a few simple spatial models that illustrate why spatial structure is an important parameter in assessing population viability. (This will not be an exhaustive discussion of the spatial models that may apply to salmonids.) We conclude the section by summarizing the current understanding of spatial structure in salmonids and describing how spatial structure can be assessed. The effect of spatial structure on genetic processes is discussed in the “Diversity” section, p. 101.

General Spatial Patterns

Several schemes for classifying population spatial structure have been developed (e.g., Harrison and Taylor 1997, Gilpin 1993). Figure A12 illustrates some potential spatial patterns described in the general ecological literature. The dynamic spatial pattern of a population depends on the movement patterns of individuals (straying) and the structure of the habitat. The spatial patterns shown in Figure A12 all assume that the habitat is divided into discrete “patches” surrounded by unsuitable habitat. Patch attributes that affect spatial patterns are size, number, quality, spatial distribution, and stability. As panel B shows, fluctuations in abundance can also affect the observed spatial pattern. A single population may simultaneously exhibit multiple types of spatial structure, depending on the spatial and temporal scale examined. For example, at a large spatial scale a group of fish may show a source-sink dynamic, while at the local scale of an individual patch, the group may be panmictic.

In a panmictic population, every mature individual is equally likely to mate with every other mature individual of the opposite gender. In a patchy panmictic population, the habitat is divided into discrete patches, but movement (straying) is so high that the breeding pattern is panmictic and no subpopulations are formed. The term “classic metapopulation” refers to the type of population structure first modeled by Levin (1969). In a classic metapopulation, the habitat is divided into discrete patches, all of which are identical in every way and migration is equally likely among all patches. Subpopulation extinction and the colonization of empty habitats drive the dynamics of a classic metapopulation. There is a substantial amount of theoretical literature on metapopulations and they are discussed in some detail as follows. What we are referring to as a “structured population with no extinction” is a variant of a classic metapopulation in which there is sufficient straying so that subpopulations are “rescued” from extinction by migrants, but straying is insufficient to create a patchy panmictic population. Island-mainland systems consist of a single large stable population (“mainland”) surrounded by smaller subpopulations (“islands”) that are prone to extinction. Because of the asymmetry in subpopulation size, straying is also asymmetrical, with most migration occurring from the mainland to the islands. Source-sink populations are similar to island-mainland systems in that migration is asymmetrical. However, in source-sink systems, the asymmetry occurs because highly productive source populations send a relatively large number of migrants to the sink subpopulations, which are not self-sustaining and would deterministically go extinct in the absence of migrants from the source (Pulliam 1988).

Why Spatial Structure is Important

Metapopulation theory

Levins (1969) coined the term metapopulation to describe a “population of populations.” Here, we will refer to a metapopulation as a set of subpopulations, to avoid confusing it with the definition of population used in this document and various definitions in the literature. Groups of populations (as we define them) may also act as metapopulations at larger temporal and spatial scales than the within population level. This possibility is discussed in the section on ESU viability (“Viable ESUs,” p. 125).

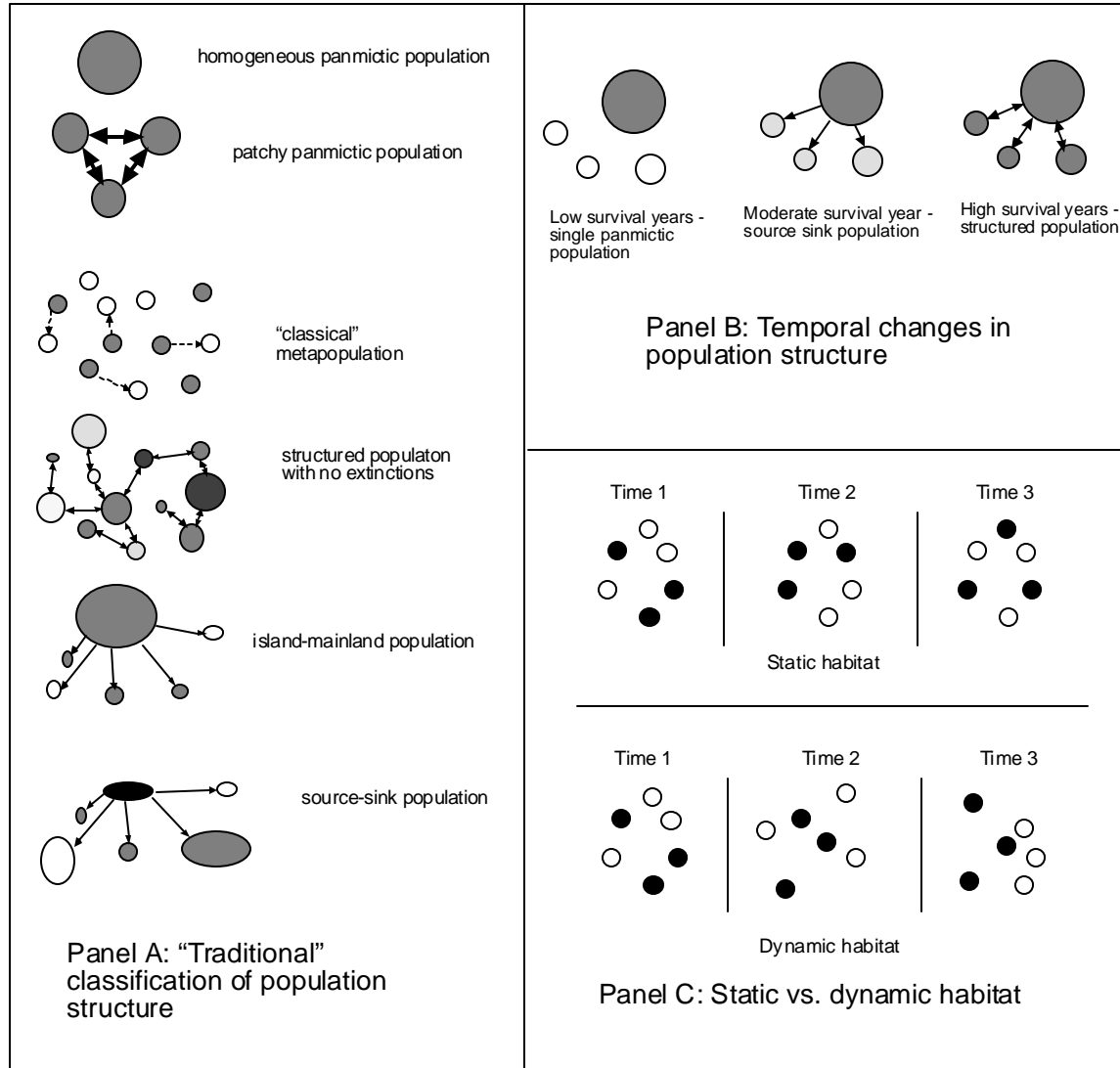

Figure A12. Theoretical types of spatially structured populations. Panel A shows a "traditional" type classification scheme that does not consider correlated environmental effects that impact all subpopulations, nor does it explicitly consider the physical dynamics of the habitat patches themselves. The circles indicate habitat patches, with the size of the circle indicating the size or capacity of the patch, and the degree of shading indicating the density of the subpopulation—white indicating an empty patch and black indicating a high density patch. The arrows indicate levels of migration, with thick arrows indicating high migration, thin arrows moderate migration, and dashed arrows indicating intermittent migration. Panel B shows how spatial structure may oscillate over time as a result of correlated environmental changes in survival or productivity among subpopulations. Correlated environmental changes might result, for example, from annual variation in ocean survival that affects all subpopulations. Panel C shows two potential habitat patterns. In a static habitat, the location of suitable patches remains constant over time, though patches may or may not always be occupied. In a dynamic habitat, the location of suitable habitat continually changes, and so the location of subpopulations must also change.

The “classic” Levins metapopulation model (Levins 1969, 1970) assumes the environment is divided into discrete patches of suitable habitat. These patches may represent different streams or stream sections that may be occupied by different subpopulations. Two processes, subpopulation extinction and patch colonization via migration from occupied patches, interact to create a dynamic pattern of occupied and empty patches. The dynamic equation of the Levins model is:

$$\frac{dp}{dt} = mp(1 - p) - ep$$

Where p is the fraction of occupied patches, m is the rate at which strays colonize new patches, and e is the rate at which subpopulations go extinct (because of natural habitat dynamics or intrinsic subpopulation dynamics). By solving the equation for the equilibrium proportion of occupied patches, it can be shown that a metapopulation will persist only when the colonization rate exceeds the extinction rate ($m > e$).

This simple model makes several key predictions relevant to the conservation of endangered species. First, at equilibrium, some suitable patches will remain unoccupied. Using a slight modification of the Levins model, Hanski et al. (1996) explored the ecological consequences of destroying suitable (though perhaps temporarily unoccupied) patches. The basic dynamic model to determine minimum viable metapopulation size is:

$$\frac{dp}{dt} = mp(h - p) - ep,$$

Where p , m and e are as above and $1-h$ is the fraction of habitat patches destroyed by human alteration. At equilibrium, the metapopulation persists (i.e., equilibrium $p > 0$) only when $h < e/m$. This leads to a general rule of thumb which Hanski et al. (1996) called the Levins Rule: “A necessary and sufficient condition for metapopulation survival is that the remaining number of habitat patches following a reduction in patch number exceeds the number of empty but suitable patches prior to patch destruction.”

A second key result of the metapopulation modeling is that there may be substantial time lags between the destruction of habitat patches and observable decreases in abundance or population growth rate (Levins 1969, Wennergren et al. 1995, Hanski et al. 1996, McCarthy et al. 1997, Tilman and Lehman 1997, Cooper and Mangel 1999). If habitat patch destruction focuses on suitable, but temporarily unoccupied patches, population abundance may remain relatively stable until subpopulations in occupied patches begin to go extinct. The rate at which subpopulations go extinct may be slow relative to the time scale over which trends in abundance are evaluated. The productivity of the population (spawners per spawner) may also appear to be relatively stable after habitat patch destruction because the problem that habitat destruction creates is a lack of suitable targets for colonization, not declining productivity in occupied patches. Metapopulations that persist for some period of time but are ultimately doomed to extinction because there is an insufficient number of habitat patches for them to inhabit, have been referred to as “the living dead” (Hanski et al. 1996).

A third result is that the metapopulation persistence depends critically on the colonization rate which, in salmonids, is tied to straying patterns among patches. A decrease in movement among patches could cause the subpopulation extinction rate to exceed the patch colonization rate—causing metapopulation extinction. Since straying in salmonids tends to decrease with

distance, increasing the inter-patch distance may result in a non-viable salmonid population.

The metapopulation models presented make the simplifying assumptions that all patches are equal except with regard to occupancy, every patch is equally accessible to every other patch, and internal patch dynamics are irrelevant.⁹ It is not clear to what extent the Levins' type metapopulation models apply to salmonids (or any organism for that matter (Harrison 1994, Harrison and Taylor 1997)). As we discuss in the following, many of the essential features of salmonid biology such as discrete, dynamic habitat patches and limited straying, are captured in the models. However, the patch-occupancy type models may poorly describe salmonid population spatial structure if straying is very high. Hanski and others (Day and Possingham 1995, Gyllenberg and Hanski 1997, Gyllenberg et al. 1997, Hastings and Harrison 1994) have explored variations of the basic metapopulation model presented. Their results indicate that the number of suitable patches is likely to be an important predictor of overall metapopulation survival, even when many of the strict Levins' assumptions are relaxed. As long as: a) the habitat is broken up into discrete patches, b) there is some limited straying among patches, and (c) we assume that there is some natural process driving subpopulation turn-over, we must consider the number of suitable habitat patches available to the population and recognize that the population may not be able to survive if that number is reduced. Note that the individual patches themselves do not have to remain constant, only the mean number of them. Patch turnover is a natural process and conservation approaches that seek to preserve specific patches of suitable habitat in perpetuity may be doomed to failure (Reeves et al. 1995).

Source-sink dynamics

Habitat patches differ in quality and this is reflected in productivity differences among subpopulations. Data on coho salmon in the Snohomish River, WA is consistent with this hypothesis, since some patches consistently show higher numbers of spawners per spawner than other patches (Figure A13). This differentiation among habitat patches can lead to a source-sink dynamic in which some subpopulations (the sources) have a higher productivity and are self-sustaining, while other subpopulations (the sinks) have a lower productivity, are not self-sustaining, and only persist because there is an influx of strays from the source population (Pulliam 1988). Schlosser and Angermeier (1995), citing work by Reimers (1973) on Oregon chinook, argue that source-sink dynamics may be common in lotic systems and care must be taken to protect source populations. Cooper and Mangel (1999) discuss the theoretical and management implications of source-sink dynamics in salmonids and they also note that an important goal in a source-sink system is protection of source populations.

It can be very difficult to identify source and sink populations. Simple observations of abundance do not reveal source-sink dynamics; sink subpopulations can be much larger than the source population. The key issue in defining sources and sinks is productivity. Subpopulation productivity is impossible to document by examining only adult spawners unless it is clear what

⁹ In a classical metapopulation, subpopulations are assumed to have independent probabilities of extinction. Independent extinction risk is one of the criteria in our definition of a population, not a subpopulation. However, the population criterion of independent extinction risk refers only to intrinsic factors (e.g., demographic stochasticity). If subpopulation turnover is driven by extrinsic factors (e.g., habitat dynamics), subpopulations may show independent extinction risks, even though they are demographically coupled.

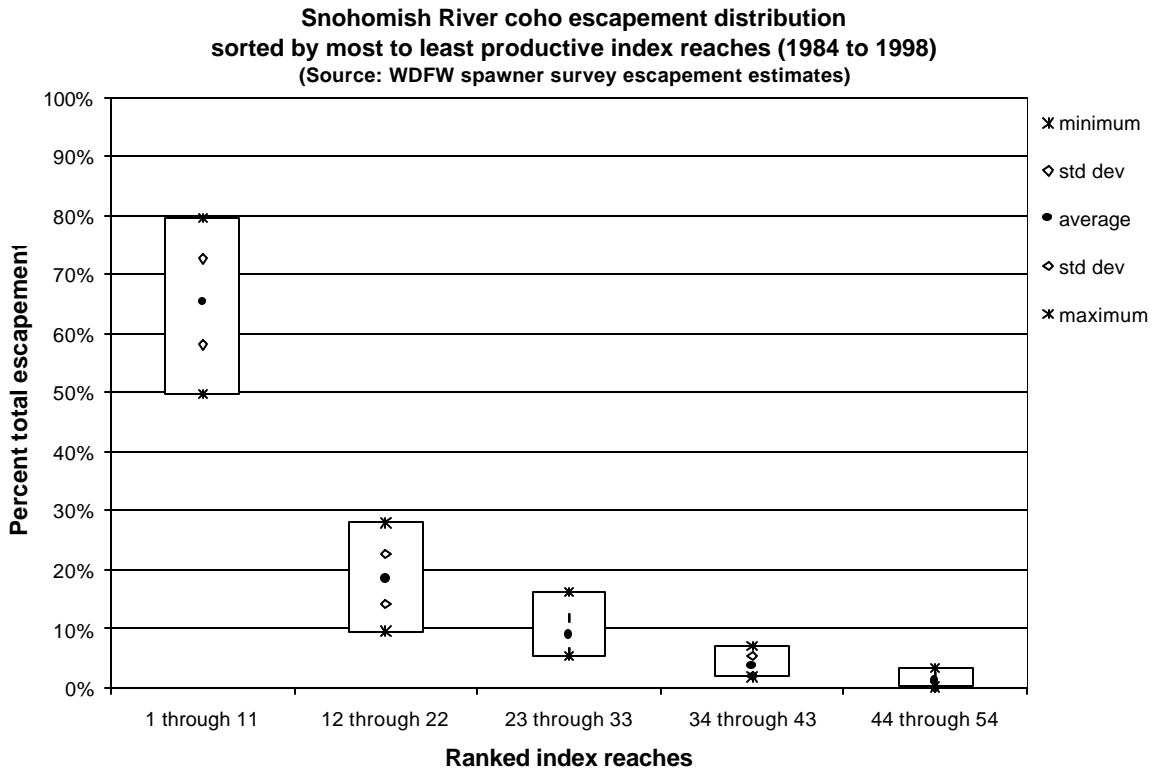

Figure A13. Productivity estimated as spawners per spawner by index reach for coho in the Snohomish River, WA (Bilby et al. 1999). The data is consistent with the idea that some reaches have consistently higher productivity than others do. However, without data on the straying patterns among reaches, it is difficult to determine whether or not spawner per spawner data reflects reach specific productivity.

proportion of the spawners returning to a patch hatched there. Such data generally are not available. Another way to document subpopulation productivity is to look at the number of fry produced per spawner. This approach is only valid if fry can be attributed to a specific subpopulation. That is, sampling must be conducted before fry from one subpopulation mingle with those from other subpopulations. Using an analogous approach to study bird populations, Brawn and Robinson (1996) examined the productivity of neotropical migrants in the mid-west by observing the number of fledglings produced per breeding female. Most populations they surveyed were actually sink populations, despite apparently stable abundance counts spanning decades.

In many salmonid systems, hatchery populations may serve as sources and wild populations as sinks. For example, in the upper Columbia steelhead ESU, over 50% of the spawners in the natural spawning grounds are estimated to be first generation hatchery fish (Chapman et al. 1994). Under the population growth rate guidelines, such a system would not be considered a VSP.

Importance of patch spacing

In terrestrial species, adequate migration corridors are important because they provide physical connection between subpopulations so that colonization of patches can equal or exceed extinction. Several recent efforts in conservation biology have focused on the pros and cons of “migration corridors” (Fahrig and Merriam 1994, Hess 1996, Lidicker and Koenig 1996, Simberloff et al. 1992). Since the frequency of straying tends to decrease with distance from the natal patch (see following), patch spacing is the primary factor determining “migration corridors” in salmonids¹⁰. If habitat patches are too widely spaced, then patch extinction or destruction may outpace colonization. Thus, the spatial arrangement of habitat patches must be considered when assessing spatial structure, because it affects the probability that colonization can occur should empty (but suitable) habitat become available. This process has been explored in a number of theoretical “stepping-stone” models (e.g., Kareiva 1990, Bascompte and Sole 1996). In an empirical study of a bull trout metapopulation, Dunham and Reiman (1999) found a decrease in patch occupancy with increasing distance from an occupied patch. In their generic salmonid metapopulation model, Cooper and Mangel (1999) used (without empirical validation) an exponential function to describe the decrease in straying probability with increasing distance. The model shows subpopulation persistence decreasing with distance from a source population, indicating the need to consider the spatial distribution of patches in evaluating population viability.

As illustrated in Figure A12, populations may expand into new habitat patches during times of high productivity (for example during periods of high ocean survival). This may occur even if the quality of adjacent patches is lower than in the “core” patch. These “marginal”

¹⁰ All anadromous fish start the return to spawn from the ocean. If a spawning habitat patch is accessible from the ocean, fish from every subpopulation in a population should have physical access to the site (assuming there are no phenotypic differences among subpopulations regarding migratory ability). Thus, physical barriers are less likely to limit straying among existing subpopulations in salmonids than in terrestrial systems, and the primary factor limiting straying among subpopulations is the extent of homing fidelity and the physical (or temporal) distance between patches.

patches may still contribute to population abundance during favorable years and thus help buffer the population from extinction. However, if patches are too far apart, populations may not be able to expand to new patches in times of high productivity. Thus, the spacing of habitat patches that rarely contain fish may affect population viability.

Fragmented habitats

Populations that were historically panmictic may currently exist as a collection of subpopulations because their habitat has been fragmented (Reeves et al. 1995, Harrison and Taylor 1997). If there is little straying among the fragments, each of the subpopulations effectively becomes their own demographically independent population, which may be too small to be viable. Provided there is some level of straying among fragments, a new metapopulation structure may be established. Although a novel metapopulation structure may be stable, stability is difficult to verify. We therefore recommend that historical structure be considered as a default goal for spatial structure (Guideline 5). It is important to note that restoring a fragmented habitat to continuity would reduce the total number of habitat patches but increase the total amount of habitat area. This provides an exception to Guideline 1, which states that the number of suitable patches should not be declining in a viable population.

Assessing Spatial Structure

To determine the applicability of patch dynamic models (e.g., the Levin's model) to salmonid conservation, it is first necessary to determine whether subpopulations and patches even exist, and if they do, at what spatial and temporal scales. In this section, we briefly review information on spatial structure in salmonids and indicate the types of data needed to evaluate a population's spatial structure.

Straying

Subpopulations are delineated by degree of reproductive isolation; therefore straying estimates can be very useful in estimating population structure. The entire suite of tools discussed in the section "Identifying Populations" (p. 38) can be used to estimate straying patterns and the degree of reproductive isolation among subpopulations. Perhaps the best method for directly measuring straying patterns involves studying tagged individuals. Unfortunately, such studies are scarce. In Table A1, we summarize studies that directly measure the rate of straying among groups of fish. Many studies report large ranges in stray rate—reflecting either great diversity in stray rates among species and populations, very imprecise estimates of stray rate, or both. Most of the published stray rate studies examined a fairly broad spatial scale, using hatchery fish, or both. So it is difficult to draw conclusions about within-population site fidelity among natural spawners. One general conclusion that can be reached from the salmonid stray rate data is that straying declines with distance from natal streams, though the exact shape of the dispersal curve is unknown. At a very local spatial scale, salmonids are not expected to show site fidelity because homing to the particular square meter of gravel where they hatched is likely to be maladaptive. Because very small-scale habitat changes are common, the particular spawning site where an individual hatched may no longer exist when

the fish returns. A completely inflexible homing strategy would not result in successful spawning. At the other extreme, the studies clearly show a pattern of homing fidelity at the scale of relatively large river systems such that it is possible to make reasonable estimates of population boundaries. It is at the within-population scale that data on homing fidelity are particularly lacking. Data on straying (or dispersal) is notoriously difficult to get for any species, a fact that has important implications for obtaining reliable estimates of extinction risk (Wennergren et al. 1995). This lack of reliable stray pattern estimates is perhaps the greatest deterrent to applying quantitative spatial viability models in salmonids.

Habitat dynamics

Stream surveys suggest that salmonids spawn in discrete patches interspersed with areas containing no spawners. For example, data on the spawning distribution of spring-run chinook salmon in the Grande Ronde River (Figure A14) indicate that the basin is divided into a number of discrete spawning areas. We have not conducted an analysis of this system, but it is reasonable to hypothesize that these groups of fish may each represent one or more subpopulations occupying discrete patches. This map shows that spatial resolution in the available data is limited; data at a finer resolution would undoubtedly reveal discrete spawning patch locations within each of the shaded regions. Although spawner distribution data provide some information about the spatial distribution of spawning habitat, it is important to note that it is not valid to equate the two (i.e., fish may mistakenly spawn in unsuitable habitat and, conversely, suitable habitat may not contain any fish). In addition, it is not clear whether the current spawner distribution represents a stable structure or an unstable artifact of recent human habitat disruptions.

As an alternative to using spawner distribution surveys to describe habitat structure, the spatial distribution of the habitat itself can be directly measured. By surveying streams for a number of physical and biotic characteristics associated with spawning habitat, it is theoretically possible to produce a map of suitable spawning areas (e.g., CLAMS project). The difficulty with this approach arises when attempting to identify the characteristics and evaluate the quality of suitable habitat. Several quantitative indices that attempt to correlate habitat characteristics with salmonid productivity have been developed (e.g., NMFS PFC matrix of pathways and indicators), however the accuracy of these indices is difficult to evaluate. Many efforts to estimate habitat spatial distribution and quality rely on subjective expert opinion (e.g., Cedar River survey [Cedar River HCP 1999]); this may be accurate in some cases, but it is difficult to apply uniformly. In a recent effort to quantify habitat structure, NMFS researchers (Bilby et al. 1999) have correlated habitat attributes with coho salmon production in Washington's Snohomish River, and they have identified physical attributes that are useful for evaluating habitat structure. The study reveals a patchy distribution of spawning in the Snohomish River system and suggests that some habitat patches consistently have higher productivity than others do (Figure A13). There are a number of possible interpretations of this pattern, but one obvious possibility is that habitat patches vary greatly in quality.

At some temporal and spatial scale, physical processes change the spatial structure of spawning habitat. Natural processes constantly rearrange river substrates, alter river depths, or completely change the course of a river (Benda 1994, Reeves et al. 1995). Bisson et al. (1997)

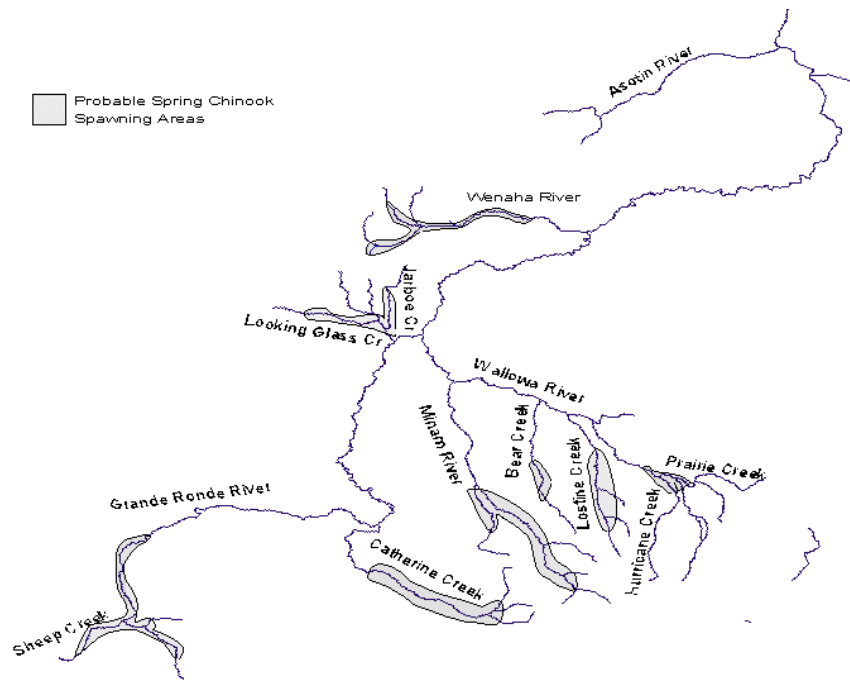

Figure A14. Map of probable spring chinook spawning areas in the Grande Ronde basin. (Redrawn from map in NWPPC 1994.)

Box A9. Spatial Structure Guidelines.

1. **Habitat patches should not be destroyed faster than they are naturally created.** Salmonid habitat is dynamic, with suitable habitat being continually created and destroyed by natural processes. Human activities should not decrease either the total area of habitat OR the number of habitat patches. This guideline is similar to the population growth rate criterion—i.e., a negative trend has deterministically negative affects on viability—though the relationship between decreasing number of patches and extinction risk is not necessarily linear.
2. **Natural rates of straying among subpopulations should not be substantially increased or decreased by human actions.** This guideline means that habitat patches should be close enough together to allow appropriate exchange of spawners and the expansion of the population into under-used patches during times when salmon are abundant (see Guideline 3). Also, stray rates should not be much greater than pristine levels because increases in stray rates may negatively affect a population's viability if fish wander into unsuitable habitat or interbreed with genetically unrelated fish.
3. **Some habitat patches should be maintained that appear to be suitable or marginally suitable, but currently contain no fish.** In the dynamics of natural populations, there may be time lags between the appearance of empty but suitable habitat (by whatever process) and the colonization of that habitat. If human activity is allowed to render habitat unsuitable when no fish are present, the population as a whole may not be sustainable over the long term.
4. **Source subpopulations should be maintained.** Some habitat patches are naturally more productive than others. In fact, a few patches may operate as highly productive source subpopulations that support several sink subpopulations that are not self-sustaining. Protecting these source patches should obviously be of the highest priority. However, it should be recognized that spatial processes are dynamic and that sources and sinks may exchange roles over time
5. **Analyses of population spatial processes should take uncertainty into account.** In general, there is less information available on how spatial processes relate to salmonid viability than there is for the other VSP parameters. As a default, historic spatial processes should be preserved because we assume that the historical population structure was sustainable but we do not know whether a novel spatial structure will be.

provide a table of the temporal frequency and spatial extent of disturbance events likely to affect salmon habitat. The data on coho salmon in the Snohomish River suggest that the location and quality of habitat patches can remain stable for more than 15 years at a time (Figure A13), though it is difficult to determine how much these results reflect other river basins or species. The dynamic nature of spawning habitat provides an added challenge in assessing spatial structure. To evaluate viability, we must not only understand the current habitat structure, but also anticipate its future patterns of occupancy and suitability.

VSP Guidelines: Spatial Structure

While it is easy to demonstrate theoretically that spatial structure is an important parameter for assessing population viability, it is difficult to develop generic guidelines regarding structure. If habitat occurs in discrete patches, but fish stray randomly to any patch, then any changes in habitat quantity or quality are likely to be quickly reflected by changes in population abundance and productivity. In such a case, it would not generally be necessary to extensively evaluate spatial structure and the resources for doing so could be used elsewhere. However, if straying is limited to the point where something approaching a classical metapopulation structure is created, or habitat productivity generates a source-sink dynamic, knowledge of a population's spatial structure could be crucial. Although the following guidelines are designed to apply to a broad range of populations, a key recommendation is to invest in empirical research on spatial processes in order that more refined guidelines may be developed and the crucial question of spatial scale can be addressed.

Diversity

This section discusses the relationships between diversity and population viability. In this context, diversity refers to the distribution of traits within and among populations. These range in scale from DNA sequence variation at single genes to complex life-history traits. The goal of this section is to summarize what is known about diversity's importance to salmonid population viability. The section "Population Size" (p. 53) discusses the relationship between population size and some factors, such as inbreeding and genetic drift, that affect genetic diversity. This section focuses on diversity itself as a factor affecting population viability, as opposed to simply viewing it as an attribute of effective population size.

Types of Diversity

The scientific literature extensively reviews and discusses salmonid diversity—both within and among populations (recent reviews include Ricker 1972, Groot and Margolis 1991, Taylor 1991, Healey and Prince 1995, Weitkamp et al. 1995, Busby et al. 1996, Gustafson et al. 1997, Myers et al. 1998 and Johnson et al. 1999). Salmonid traits often exhibit considerable diversity within and among populations. This variation has important effects on population viability. Some of these varying traits are anadromy, morphology, fecundity, run timing, spawn timing, juvenile behavior, age at smolting, age at maturity, egg size, developmental rate, ocean distribution patterns, male and female spawning behavior, physiology and molecular genetic

characteristics. Of these traits, some (such as DNA or protein sequence variation) are completely genetically based, whereas others (such as nearly all morphological, behavioral, and life-history traits) usually vary as a result of a combination of genetic and environmental factors (see Ricker 1972, Taylor 1991 and Healey and Price 1995 for reviews). Box A10 provides several examples of variation of traits within and among populations of chinook salmon.

Why Diversity is Important

In a spatially and temporally varying environment, there are three general reasons why diversity is important for species and population viability. First, diversity allows a species to use a wider array of environments than they could without it. For example, variation in adult run and spawn timing allows several salmonid species to use a greater variety of spawning habitats than would be possible without this diversity (see reviews in Groot and Margolis 1991). Second, diversity protects a species against short-term spatial and temporal changes in the environment. Fish with different characteristics have different likelihoods of persisting, depending on local environmental conditions. Therefore, the more diverse a population is, the more likely it is that some individuals would survive and reproduce in the face of environmental variation. For example, all of the Pacific salmonid species except pink salmon vary with respect to age at maturity (see reviews in Groot and Margolis 1991). This diversity has the effect of spreading a population out over several years, thus protecting the population against poor environmental conditions or catastrophic losses in any particular year. Third, genetic diversity provides the raw material for surviving long-term environmental changes. Salmonids regularly face cyclic or directional changes in their freshwater, estuarine, and ocean environments due to natural and human causes. Genetic diversity allows them to adapt to these changes. For example, it has been hypothesized that river-type sockeye salmon are essential for species survival during times of glacial advance, when the more highly adapted (and currently more abundant) lake-forms go extinct in areas covered by ice (Wood 1995).

Factors that Affect Diversity

Genetic diversity within and among populations is primarily affected by five forces: mutation, selection, drift, recombination, and migration¹¹ (reviewed by Hartl and Clark 1989). Phenotypic diversity is influenced by the genes that guide development, by random environmental effects, and by developmental processes that allow the same genotype to display different phenotypes in different environments (phenotypic plasticity). Until the middle of this century, many salmon biologists believed that observed phenotypic differences among populations were most likely due to phenotypic plasticity expressed by more or less genetically uniform individuals (discussed by Ricker 1972). Under this assumption, it would be difficult to argue that there is a strong relationship between diversity and population or species viability. This is because any individual would presumably be able to express the range of observed phenotypes under appropriate environmental conditions, although non-genetic diversity might still be important in buffering populations against environmental stochasticity. Over the last half of the century, the paradigm has shifted toward the view that much of the observed diversity within and among salmonid

¹¹These are the primary forces that are most relevant to our discussion. There are additional forces that affect genetic variation, such as transposable elements and retroviruses.

Box A10. Examples of Diversity. Below are three brief examples illustrating trait diversity within and among populations of chinook salmon.

Example A10-1. Peak spawn timing of chinook salmon in the Pacific Northwest and California. Figure A10-1a illustrates spawn timing diversity among chinook salmon in different streams. We do not know to what extent these differences are due to genetic or environmental variation, or both.

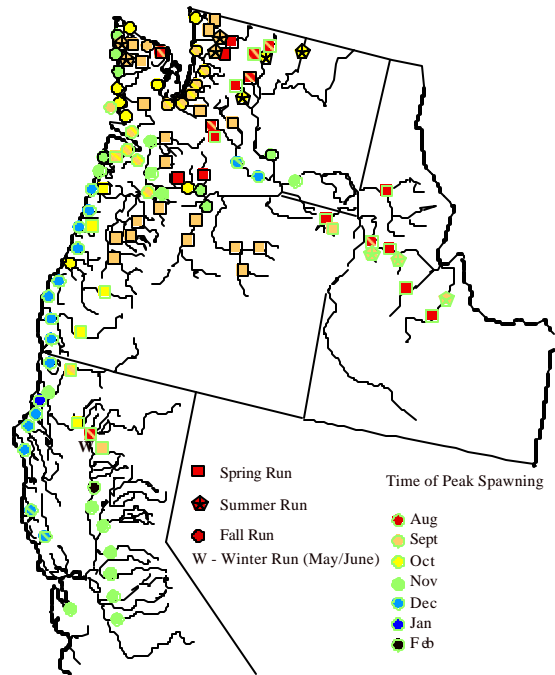

Figure A10-1a. (Reproduced from Myers et al. (1998, Figure 10).)

Example A10-2. Behavioral variation in chinook salmon fry. Taylor (1988) studied behavioral differences between several British Columbian chinook salmon populations. Figure A10-2a shows the duration of “lateral displays” (an agonistic behavior) among chinook salmon fry whose parents originated from four different British Columbia streams. The fry were hatched and reared in a common environment, suggesting that the differences have a genetic basis.

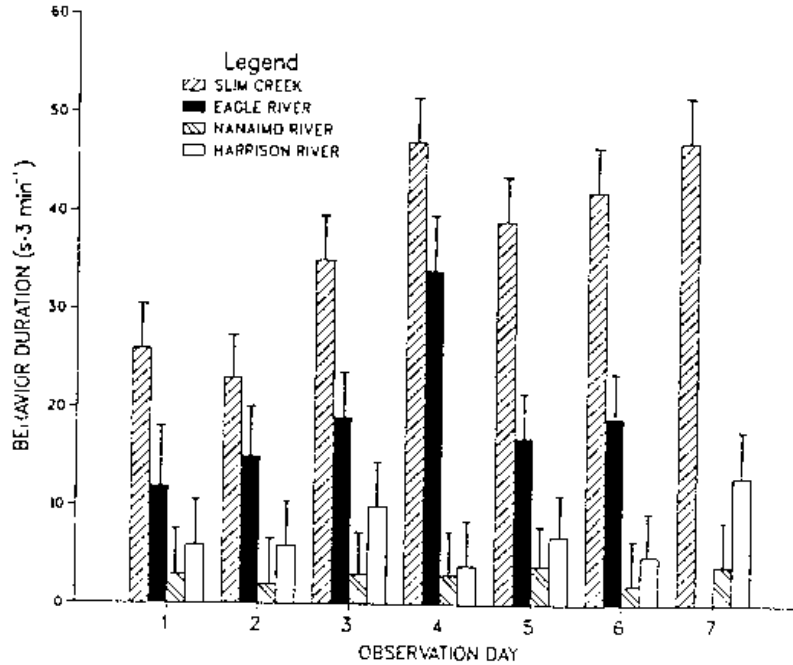

Figure A10-2a. (Reproduced from Taylor (1988).)

Example A10-3. DNA sequence variation at the transferrin gene. Figure A10-3a shows the nucleotide sites at the transferrin gene that vary among six chinook salmon individuals sampled from the Imnaha River, Oregon. The top part of the figure is a schematic diagram of the exon/intron structure of the gene, and the bottom part of the figure shows nucleotide sites that vary among the six individuals sampled. Only variation in exon sites is shown. “R,” “Y,” “K,” “M,” “S,” and “W” refer to A/G, C/T, G/T, A/C, G/C, and A/T heterozygotes, respectively.

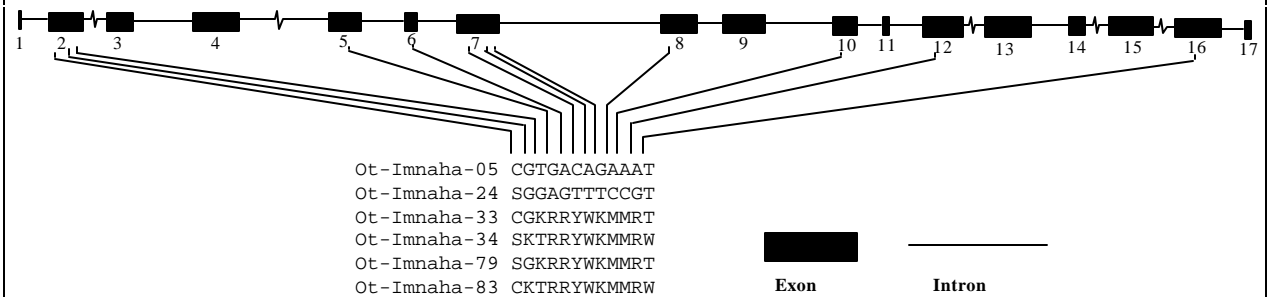

Figure A10-3a. Data from Ford et al. (1999).

populations is both genetically and environmentally influenced, and therefore at least partially heritable. Under this paradigm, diversity takes on more significance because it would be difficult to replace once lost. There is considerable evidence to show that observed patterns of diversity are at least partly based on genetic factors (reviewed by Ricker 1972, Taylor 1991): salmonid homing behavior means that different spawning groups are likely to be at least partially reproductively isolated from each other, thus promoting genetic differentiation (e.g., Foerster 1936, Quinn and Fresh 1984, Labelle 1992, Quinn 1993); 2) common garden experiments have demonstrated that observed differences between populations often remain when fish from different populations are reared in a common environment (e.g., Taylor 1988, Tallman 1986, Clark et al. 1992, Withler et al. 1987); 3) breeding studies that allow the genetic variance of specific traits to be estimated have shown that many of the traits that differ within and among natural populations are genetically variable (reviewed by Tave 1993); and 4) population surveys of variation in protein and DNA sequences have directly shown that salmonids are genetically variable within and among populations (e.g., Parkinson 1984, Gharret et al. 1987, Reisenbichler and Phelps 1989, Utter et al. 1989, Wood et al. 1994, Weitkamp et al. 1995, Myers et al. 1998, Gustafson et al. 1998, Ford 1998).

Although it is now generally accepted that much of the observed diversity within and among salmonid species has at least some genetic basis, the adaptive importance of this diversity is still uncertain. Natural selection is one force that could create differences among populations, but differences could also arise from non-adaptive processes such as genetic drift (e.g., Adkinson 1995). Box A11 provides several examples of (apparently) adaptive diversity, and Ricker (1972), Taylor (1991), and Healey and Prince (1995) provide many examples of differences among salmonid stocks that appear to be adaptive. There are many cases of management concern, however, where there may simply be no data on the adaptive significance of observed differences among populations (or even whether there are phenotypic or genetic differences among populations). It is also important to note that the absence of phenotypic differences between two populations does not mean that the two populations are not locally adapted. For example, the populations may differ genetically in ways that allow the expression of a common phenotype in two distinct environments (see Example 1 in Box A11), or they may simply differ in traits that have not been examined. There are management and conservation costs associated with both, incorrectly assuming that adaptive differences among populations exist when in fact they do not or incorrectly assuming that no differences exist when in fact they do. In the former case, unnecessary time or scarce resources might be spent on management actions designed to conserve differences that do not exist or are not important, while in the latter case important genetic variation could be lost.

Risks to Diversity

Actions that affect patterns of mutation, selection, drift, recombination, and migration all have the potential to reduce or alter adaptive patterns of diversity. Mutation and drift are primarily influenced by the genetically effective size of a population, and are discussed in “Population Size” (p. 53). This section focuses on how selection and gene flow affect patterns of diversity.

Box A11. Examples of adaptive diversity. In his review of local adaptation in salmonids, Taylor (1991) used the following criteria to determine if there was evidence that a trait was locally adaptive: 1) the trait must have a genetic basis, (2) differential expression of the trait must result in differences in survival or reproductive capacity, and 3) a selective mechanism must be demonstrated. Several examples for salmon populations that at least come close to meeting these criteria are discussed as follows.

Example A11-1. Differences in development time in chum salmon. Healey and Prince (1995) present an example of local adaptation drawn from work on three spawning groups of chum salmon studied by Tallman (1986) and Tallman and Healey (1991, 1994). The three groups spawn at different times in two streams, Bush and Walker Creeks, that empty into Ladysmith Harbor on Vancouver Island less than 2 km apart from each other. There are two spawning runs in Bush Creek, an early run with peak spawning in late October and a late run with peak spawning in late November. The Walker Creek group has a still later peak, spawning in mid-December. Despite these differences in spawn timing, the timing of fry emergence and downstream migration is similar among the three groups, with Walker Creek fry actually migrating slightly earlier than the Bush Creek fry. Differences in the development rates remain when the groups are brought into a common environment, which suggests that these differences are genetically based. The groups maintain their phenotypic differences despite fairly high levels of straying among them (Tallman and Healey 1994), evidence that the differences among the populations are selectively maintained. No selective mechanism has been convincingly demonstrated, but Tallman and Healey (1991) hypothesize that conditions in Ladysmith Harbor may select for an optimal time of fry outmigration despite differences in spawning time and incubation temperature among the runs. If so, this is intriguing because it provides an example of genetic adaptation for phenotypic uniformity (Tallman and Healey 1991).

Example A11-2. Fry migratory behavior. Upon emerging from the gravel, fry in many river systems must migrate upstream or downstream to rearing areas (reviewed in Groot and Margolis 1991). Several studies have demonstrated that in some populations the tendency to migrate in a particular direction is innate. The data in the following table are from Raleigh (1971); they show the percentage of fry that moved upstream or downstream in an artificial channel. The fry hatched from fertilized eggs that were collected from sockeye salmon spawning in the Stellako River—an inlet stream to Fraser Lake, British Columbia, and from the Chilko River—an outlet stream to Chilco Lake, British Columbia. There is a clear difference between the two groups in a common environment, which suggests that the difference is genetically based. Sockeye salmon normally spend a year or two rearing in a lake before migrating to sea (reviewed by Burgner 1991), and a very plausible selective mechanism in this case is the need to move in the correct direction to find the lake rearing environment. Similar innate differences in migratory behavior between inlet and outlet spawners have been found in other populations of sockeye salmon (Quinn 1985), as well as in populations of rainbow and cutthroat trout (Raleigh 1971, Kelso et al. 1981).

Stellako River Group – Inlet spawners			Chilko River Group – Outlet spawners		
Upstream	Downstream	Not trapped	Upstream	Downstream	Not trapped
0.5%	99%	0.5%	58%	40.5%	1.5%

Table A11-2a. (Data from Raleigh 1971, Table 1.)

Example A11-3. Resistance to *Ceratomyxa shasta*. The infectious stage of the freshwater salmon parasite *C. shasta* is found in some watersheds but not in others. Zinn et al. (1977) examined the susceptibility of four fall chinook hatchery populations to *C. shasta* (see figure below). Three of the populations originated from the Columbia River Basin, where the infectious stage of the parasite is present, and the fourth originated from the Trask River, where the parasite is absent. The three Columbia River populations all are resistant to the disease, whereas as the Trask River population is highly susceptible. Resistance to the disease is believed to be genetically based (e.g., Ibarra et al. 1994), and the selective mechanism is death due to the infectious agent.

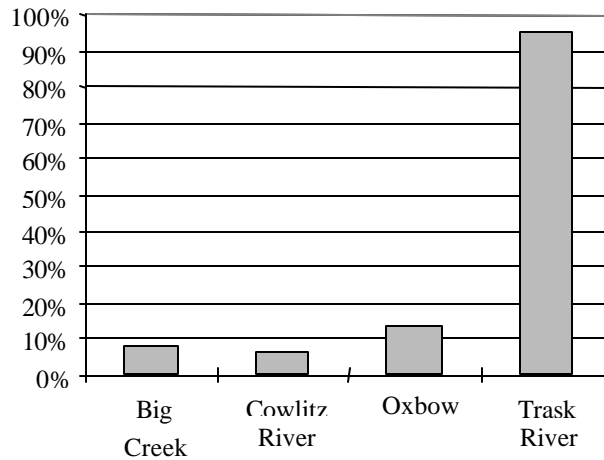

Figure A11-3a. Percent dead and infected with *C. Shasta* after 86 days of exposure. (From Zinn et al. 1977, Table 3.)

Selection

Selection refers to the differential fitness expressed by individuals exhibiting one version of a trait in comparison to individuals exhibiting a different version of the trait. For example, if salmon that return to spawn at a particular time are more successful than those that spawn earlier or later, there is natural selection for the intermediate spawn time. Humans can also control selection. For example, Donaldson (1968) discusses the use of artificial selection to breed for desirable traits in chinook salmon and steelhead. If the variation has an appropriate genetic basis, natural or artificial selection will alter the distribution of the trait being selected (reviewed by Endler 1986, Falconer and Mackay 1996). Additionally, if multiple traits share some of the same genes, selection pressures operating on one trait can cause correlated changes in other traits (e.g., Lande and Arnold 1983).

Adaptation refers to the process by which natural selection increases a population's fitness in its environment. Many natural salmonid populations appear to be highly adapted to local environments (reviewed by Taylor 1991 and see examples in Box A11). However, these adaptations can be threatened by human-caused selection for traits that are not adaptive in the natural environment. For example, size is highly correlated with fecundity in salmonids (reviewed by Groot and Margolis 1991). If large individuals in a population are harvested at higher rates than smaller individuals, this can reduce the mean size of fish in a population and, as a consequence, reduce fecundity as well (e.g., Ricker 1981). Box A12 provides several specific examples of human-caused selection in salmonids that appear to cause either a loss of phenotypic diversity or a loss of adaptation to the natural environment or both.

The time it takes for a population to adapt to a set of conditions varies among populations and species. Several salmonid species are divided into subgroups that may have been relatively isolated for many tens of thousands of years. Ocean and stream type chinook salmon in the Columbia and Fraser Rivers, for example, have quite divergent life-history patterns (reviewed by Healey 1991). Population genetic analysis suggests that these two life-history forms may have diverged over 50,000 years ago (Myers et al. 1998, Ford 1998). Inland and coastal forms of steelhead display similarly high levels of genetic divergence (Allendorf 1975, reviewed by Busby et al. 1996). On the other hand, there is good evidence that salmon are capable of recolonizing new habitat and adapting to new conditions very rapidly. For example, salmon populations currently occupy large geographic areas that were inaccessible to salmon during the last glacial advance ~14,000 years ago (reviewed by Pielou 1991), suggesting that at least over long time scales salmon are flexible enough to adapt to new conditions. An apparent example of much more rapid adaptation is the introduction of Sacramento River chinook salmon to New Zealand early in the 20th century. Over the last nine decades, the originally introduced population has not only naturally colonized additional rivers but has also become somewhat diversified morphologically (Kinnison et al. 1998).

It is worth spending a moment to discuss natural selection and adaptation as they relate to the NMFS's concept of an Evolutionarily Significant Unit (ESU—Waples 1991c). Evolution embraces a continuum of concepts, ranging in meaning from small changes in allele frequencies over a few generations to major changes in morphology over geological time scales (e.g.,

Box A12. Human caused selection.

Example A12-1. Spawn timing in Oregon coho. The spawn timing of some stocks of Oregon coast coho salmon has shifted toward early dates over the last 45 years, apparently due to artificial and natural selection in hatcheries (Nickelson et al. 1986). For example, Figure A12-1a shows the mean spawn timing of Trask River Hatchery coho from 1950 to 1994. Nickelson et al. (1986) compared the abundance of juvenile and adult coho salmon in 30 streams on the Oregon coast from 1980 to 1985, 15 of which were supplemented with hatchery-produced presmolts from 1980 to 1982, and 15 of which were unsupplemented controls. The hatchery populations used for supplementation included the Trask River (and other) Hatchery fish with advanced spawn timing. The 15 supplemented streams showed increased total juvenile densities during the period of stocking, but the adult densities were not significantly altered. In fact, the relative densities of late spawning adults actually declined in the supplemented streams compared to the controls. Nickelson et al. (1986) suggested the early spawn timing of the hatchery populations used for supplementation was maladaptive in these streams because the fry from early spawners experienced greater mortality from spring floods than later emerging fry (Figure A12-1b). Although they did not rule out other possible factors such as poor survival of the hatchery fish during other parts of their life cycle.

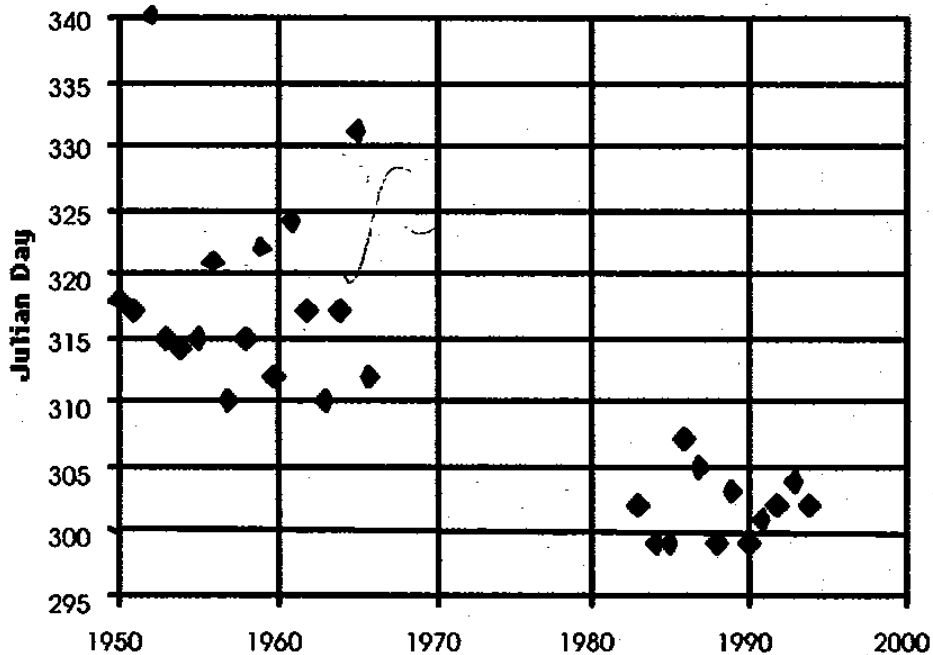

Figure A12-1a. Mean spawn timing of Trask Hatchery coho. (Data from Natural Resources Consultants (1995).)

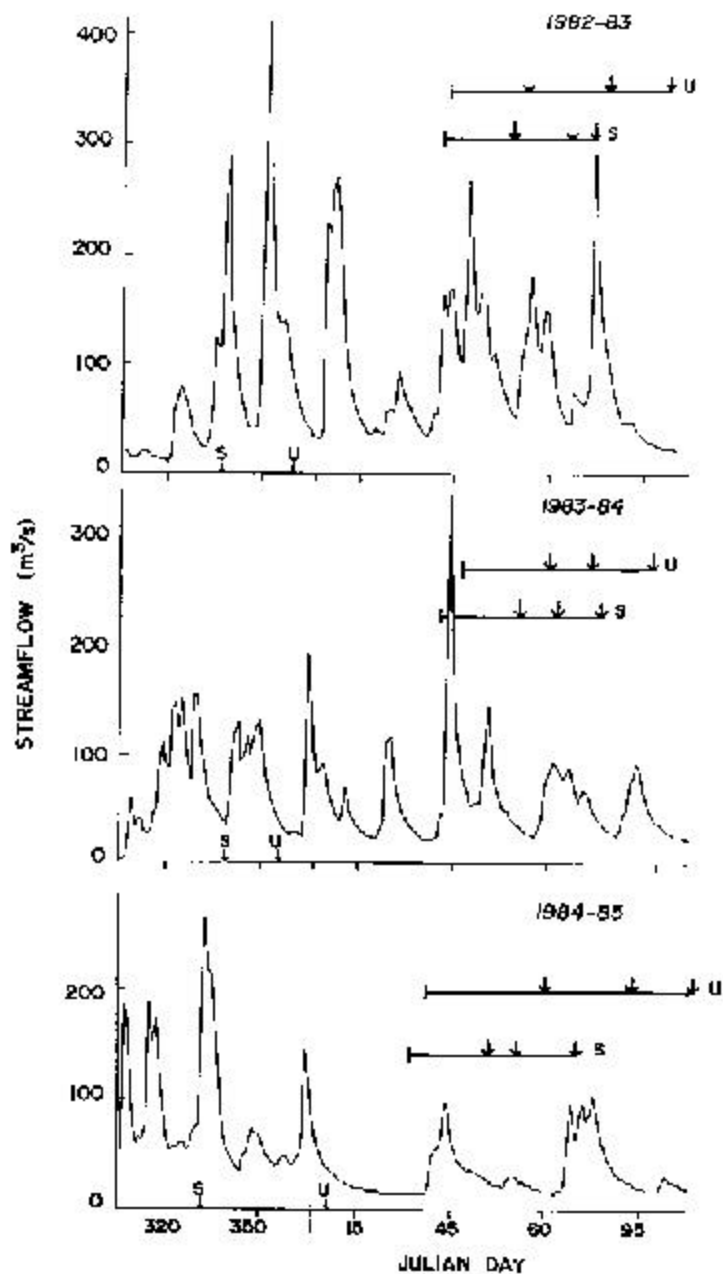

Figure A12-1b. Average daily streamflow for the Nestucca, Siletz, Yaquina, Alsea, and Siuslaw river basins, November through April. The arrows on the horizontal axis designate the time at which 75% of the spawners had been observed in the stocked (S) and in the unstocked (U) study streams. The estimated period from beginning until 75% emergence is shown by the horizontal lines labeled S and U. The arrows represent the completion of 25, 50, and 75% of emergence.

Example A12-2. Alteration of morphology and behavior in hatcheries. Fleming and Gross (1989) compared the morphology of coho salmon from 13 wild and 5 hatchery populations, and found that the hatchery populations differed from the wild populations in ways they predicted using adaptationist arguments. For example, they predicted that the removal of female breeding competition in hatcheries would relax selection for female secondary sex characteristics. Figure A12-2a (reproduced from Fleming and Gross 1989) shows that this prediction was correct: traits associated with breeding competition (size, kype development, and color) were significantly changed in hatchery populations compared to wild populations.

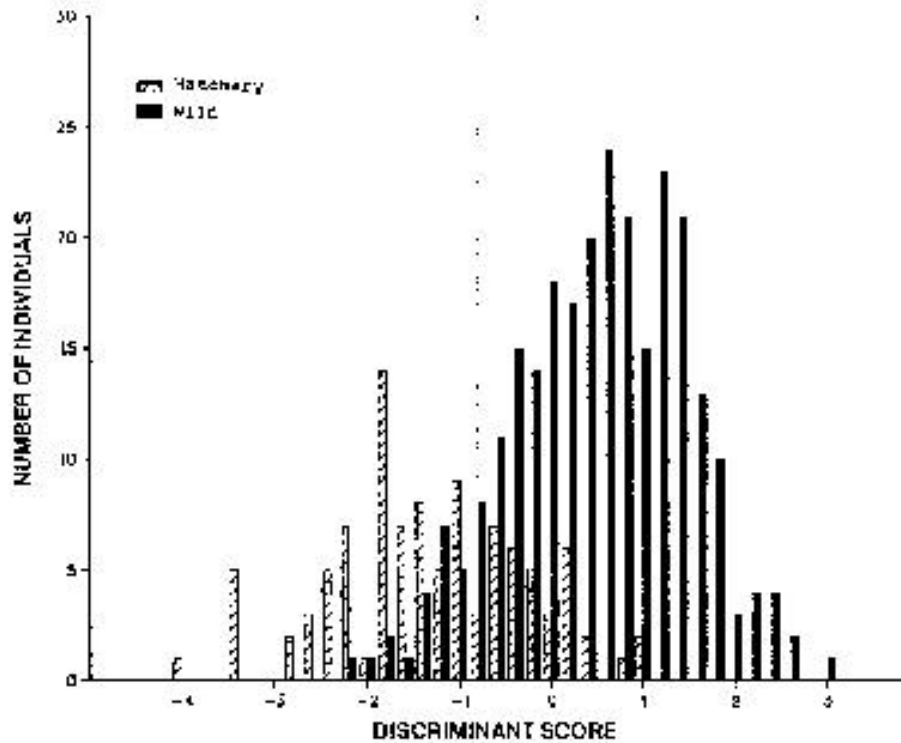

Figure A12-2a. Discriminant scores of morphological variation between wild ($N = 266$) and hatchery ($N = 102$) female coho salmon (*Lorenzetta* females excluded). The standardized canonical discriminant function is: $0.488(\text{kype}) + 0.201(\text{color}) + 0.283(\text{anal base}) + 0.324(\text{dorsal height}) - 0.138(\text{pelvic}) + 0.171(\text{pectoral}) - 0.195(\text{caudal peduncle}) + 0.484(\text{body length})$ ($r = 0.622$, $P_2 < 0.001$). The vertical line represents the point of discrimination between hatchery and wild fish based upon the discriminant function. (Reproduced from Fleming and Gross (1989).)

In another paper, the same authors compared breeding behavior and success in a common environment between coho salmon from one hatchery population that had been in culture for 4-5 generations and 2 nearby wild populations. One of their findings was that the courting frequency and breeding success of male coho salmon from the hatchery populations was significantly poorer than that found in either wild population (Figure A12-2b). It is not clear from their results whether the observed differences were the result of environmental or genetic differences between the populations.

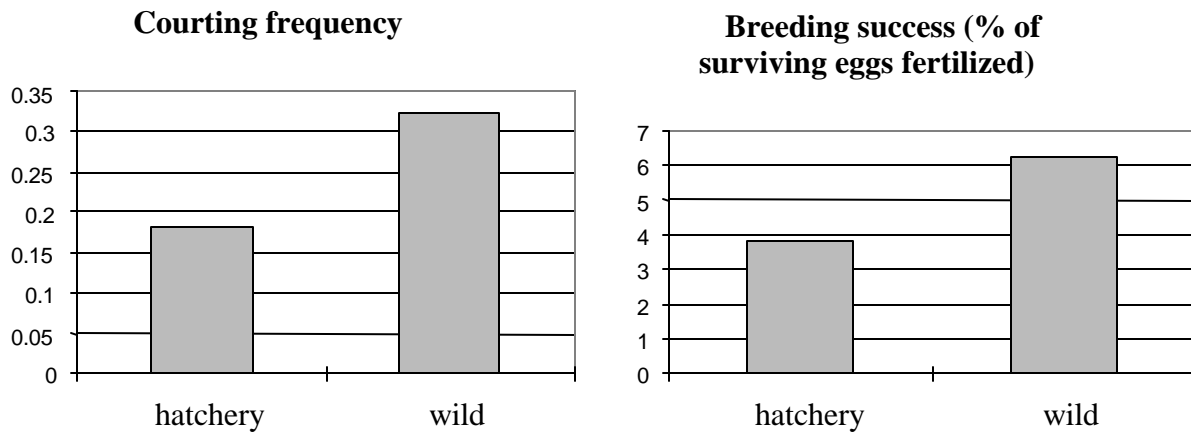

Figure A12-2b. (Data from Fleming and Gross 1993, Table 6.)

Example A12-3. Selection produced by habitat alteration. Many of the examples of local adaptation that Taylor (1991) reviewed involve adaptation to the freshwater environment, so it is reasonable to infer that altering this environment would affect patterns of phenotypic and genetic diversity (see Healey and Prince 1995 for additional discussion). Hartman et al. (1984) and Holtby (1987) provide an example of this from a 15-year study of the effects of logging on coho salmon in Carnation Creek, British Columbia. One of the effects of logging was an increase in the water temperature during incubation, which resulted in a large change in the relative proportions of one-year-old and two-year-old smolts (Figure A12-3a, reproduced from Holtby 1987). From these data, it is not possible to determine whether the observed change in phenotype is due to a plastic response to a new environment, genetic change, or a combination of these factors.

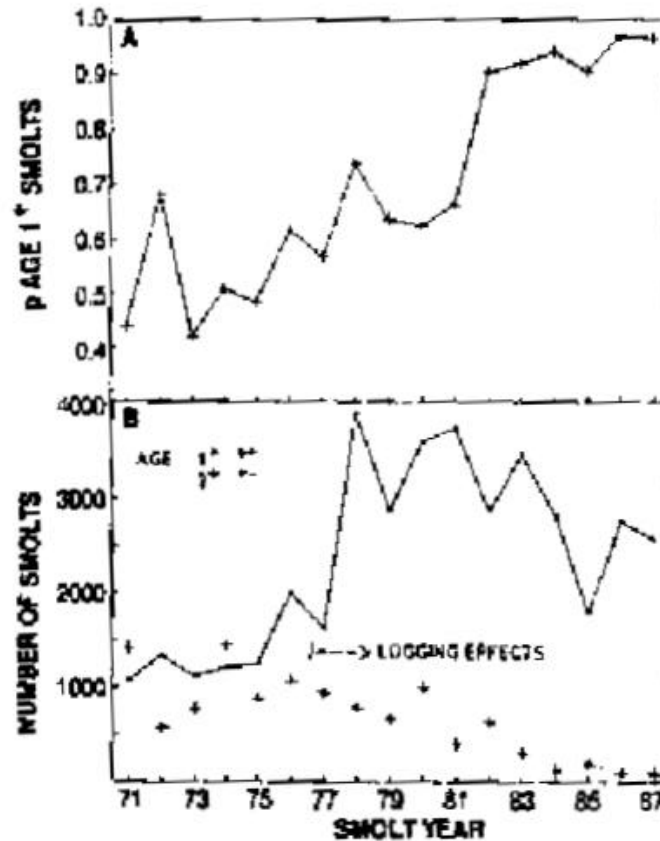

Figure A12-3a. A) The proportion of smolts that were age 1+ by year of migration. B) The observed numbers of yearling (1+) and two-year-old (2+) smolts by year of migration. Note that for any particular cohort, the two-year-old smolts migrate one year after the yearlings. The change in the age composition of smolts resulted from the dramatic increase in the numbers of the younger age group (1+) rather than an abrupt decline in the numbers of older smolts. (Reproduced from Holtby 1987.)

Kimura 1983, Endler 1986, Mayr 1988). The key to the NMFS's ESU concept is that populations or groups of populations identified as ESUs are believed to have been on largely independent evolutionary trajectories for many (probably at least hundreds) of generations, and have therefore had an opportunity to become substantially genetically differentiated from other ESUs. In other words, ESUs are populations or groups of populations that have been reproductively isolated for a sufficient period of time such that they have accumulated a substantial component of the diversity present in the entire biological species. Not all of the differences among ESUs are necessarily adaptive or are the result of natural selection, but adaptations are clearly an important factor in determining if two reproductively isolated populations are in different ESUs (Waples 1991c).

Selection from human activities can potentially rapidly erode the adaptive fit between an ESU or population and its environment, increasing the risk of extinction. We do not believe that it is currently feasible to set quantitative guidelines on how much diversity a population or ESU can lose and remain viable. Qualitatively, we suggest that in order for a population to be considered viable, human-caused factors such as habitat changes, harvest pressures, artificial propagation, or exotic species introductions should not substantially alter variation in the population.

Straying and gene flow

Straying and gene flow strongly influence patterns of diversity within and among populations. In this context, straying occurs when a fish returns to spawn in a population other than its parents' population. Such strays may or may not successfully reproduce and leave offspring. Gene flow refers to the movement of genes from one population to another, resulting when strays successfully reproduce. The rate of gene flow is therefore influenced both by the rate of straying among populations and by the level of selection against strays (see Felsenstein 1976, 1997 and Adkinson 1995 for recent theoretical treatments and reviews). For example, Chilcote et al. (1986) and Leider et al. (1990) estimated that hatchery steelhead (introduced from another tributary) that spawned naturally in the Kalama River, Washington, produced only about one-tenth as many returning adults per spawner as the local wild fish, resulting in a gene flow rate into the wild population that was much lower than would be predicted based on the observed proportion of hatchery spawners. Information on stray rates comes primarily from experiments that involve monitoring the spawning location of fish that are marked or tagged in their home area as juveniles (e.g., Foerster 1936, Quinn and Fresh 1984, Quinn et al. 1991, Labelle 1992). The rate of gene flow among populations, on the other hand, has usually been estimated by fitting population genetic models to observed patterns of molecular genetic variation (reviewed by Slatkin 1985). Gene flow and straying rates have only been estimated for the same groups of populations a few times, and in each of these cases the rate of gene flow was estimated to be less than the rate of straying (Quinn et al. 1987, Labelle 1992, Tallman and Healey 1994). The methods used to estimate gene flow and straying in these studies were not precise enough, to make accurate estimates of gene flow/stray rate ratios. For most species of Pacific salmonid, straying and gene flow appear to occur in broadly hierarchical patterns, although the details of these patterns vary considerably among species. For example, in a review of straying studies, Quinn (1993) found that salmon stray with greater frequency to nearby populations than to distant ones. Patterns of molecular genetic variation for most species fall into a similar pattern,

where geographically proximate populations are generally more genetically similar (and therefore have higher estimated levels of gene flow) than geographically distant populations (e.g., Utter et al. 1989, Ford 1998).

There are many theoretical population genetic models that can be used to interpret the observed patterns of diversity among salmonid populations, and Box A13 provides examples of two such models. The main conclusions from these (and similar) models are: 1) The level of divergence among populations at selectively neutral alleles is a function of the number of effective strays among populations. This is consistent with the empirical observation that both straying and molecular genetic divergence appear to be generally correlated with geographic proximity; 2) Selection can maintain genetic differences between populations in different environments despite relatively high levels of gene flow between the populations. If selection is sufficiently strong, a locally selected trait can be maintained at high frequency despite a large influx of individuals exhibiting an alternative form of the trait (see Example 1 in Box A11); and 3) If a local environment selects against strays because of genetic factors at multiple loci, the rate of recombination among these loci will affect the total strength of selection against strays (Barton 1983). That is, the lower the rate of recombination, the more efficiently selection will remove locally deleterious alleles. In salmonids, most traits likely to be involved in local adaptation are quantitative traits that are probably controlled by many genes (reviewed by Hard 1995). Because salmon have a large number of chromosomes (reviewed by Sola et al. 1981), it is probably reasonable to assume that levels of recombination among genes contributing to quantitative traits will be high—making selection against strays potentially less effective than might be the case in animals with fewer chromosomes.

There are a number of ways in which human actions can substantially alter patterns of straying and, therefore, patterns of diversity and adaptation among salmonid populations. For example, blocking migration corridors with dams and dewatering rivers can prevent salmonids from homing and thus increase the rate of straying into other populations. Box A14 provides several examples of how human actions have significantly altered straying patterns.

A reasonable way to approach setting VSP guidelines for acceptable levels of human-caused gene flow among salmonid populations is to base the thresholds on estimates of naturally occurring gene flow among natural salmon populations (Ryman et al. 1995). These natural rates of gene flow allowed salmonid populations to persist and adapt to local conditions for many generations, and it is therefore reasonable to assume that maintaining them would protect the genetic diversity that currently exists among and within populations. Limiting human-caused gene flow is particularly important when such gene flow occurs among different ESUs, because ESUs are believed to contain adaptations that have been shaped by natural selection over the course of hundreds of generations and to contain a substantial component of a species-genetic diversity (Waples 1995). Loss of an ESU, either through extinction or through loss of its unique genetic attributes, due to excess gene flow from outside the ESU, would therefore be a significant, and probably irreplaceable, loss to the diversity of the species as a whole.

It is possible to estimate rates of gene flow among natural populations from patterns of molecular genetic variation (see “Types of information used in identifying populations,” p. 39,

Box A13. Models of genetic variation among populations. There is a large body of literature on modeling the effects of mutation, selection, drift, and migration on patterns of variation among populations. In the following, we provide two examples of such models.

Example A13-1. Single locus, selectively neutral alleles, island model. Takahata and Nei (1984), and Crow and Aoki (1984) explored a model of gene flow that assumed that a finite number of populations were connected by equal rates of gene flow. G_{ST} (a multi-allele version of Wright's F_{ST}) is a useful statistic for quantifying the relative amounts of variation within and among populations, and varies from 0 (no variation among populations) to 1 (all variation among populations). The approximate relationship between G_{ST} and the number of migrants per generation, Nm , at migration-drift equilibrium is plotted in Fig A13-1a for five populations (the exact number of populations does not substantially change the relationship). The figure shows that, in this model, the level of population differentiation changes very rapidly with increasing gene flow. For example, if the populations were previously at equilibrium between gene flow and drift, and Nm is changed from 0.1 to 10, G_{ST} for neutral alleles would be expected to change from 0.6 to 0.02. When gene flow is increased from an old equilibrium level, the time it takes G_{ST} to approach its new equilibrium value is on the order of $1/m$ generations. If the effective population sizes in the example above were 100, G_{ST} would be near its equilibrium value in about 10 generations. A similar relationship between G_{ST} and Nm holds for many non-island patterns of migration (e.g., Crow and Aoki 1984, Slatkin 1993).

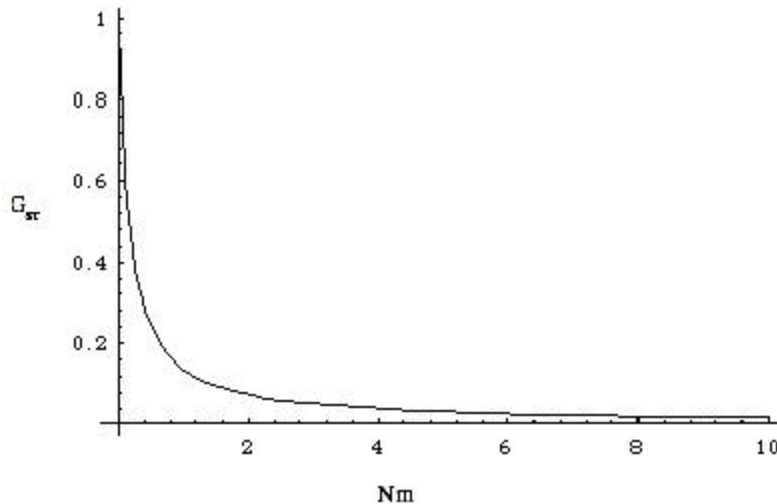

Figure A13-1a. Approximate relationship between G_{ST} and N_m at equilibrium.

Example A13-2. Single locus models of selection and migration. Felsenstein (1976) extensively reviewed general selection and migration models. As an illustration of the sorts of results these models produce, we summarize the relatively simple model of Bulmer (1972). See Adkison (1995) and Felsenstein (1997) for recent examples of how these concepts may be applied to Pacific salmonids.

Bulmer's model was formulated for an arbitrary number of populations, but for the sake of simplicity, we only present an example of the two-population case. For a single locus with two alleles, A and a , let p_1 and p_2 be the frequencies of allele A in populations 1 and 2, respectively. Let the relative fitness of the genotypes AA , Aa and aa be $1 - s_1$, 1 and $1 - t_1$, respectively in population 1, and $1 - s_2$, 1, and $1 - t_2$, respectively, in population 2. The model assumes a life-cycle that consists of viability selection within each population, migration among populations, and then random mating within each population. The recursion equations describing the change in the frequencies of the A allele in each population are:

$$\dot{p}_1 = \frac{(1 - m_1)(p_1^2(1 - s_1) + p_1q_1)}{1 - t_1q_1^2 - s_1p_1^2} + \frac{m_1(p_2^2(1 - s_2) + p_2q_2)}{1 - t_2q_2^2 - s_2p_2^2},$$

and

$$\dot{p}_2 = \frac{m_2(p_1^2(1 - s_1) + p_1q_1)}{1 - t_1q_1^2 - s_1p_1^2} + \frac{(1 - m_2)(p_2^2(1 - s_2) + p_2q_2)}{1 - t_2q_2^2 - s_2p_2^2}.$$

Where m_1 is the proportion of population 1 that consists of migrants from population 2, and m_2 is the proportion of population 2 that consists of migrants from population 1. Although this model has not been fully solved analytically, it is easy to explore its behavior iteratively using a computer. For example, running the model for 100 generations with parameters $p_1 = 0.01$, $p_2 = 0.99$, $s_1 = t_2 = 0.1$, $s_2 = t_1 = -0.1$, $m_1 = 0.2$ and $m_2 = 0.0$ results in the elimination of the a allele in both populations (Figure A13-2a). In other words, this scenario corresponds to a case where a locally favored allele is eliminated by continual one-way gene flow from a different population that lacks the allele. Even though the local allele is at a selective advantage compared to the migrant allele, the local allele is eliminated from the population. Running the model with all the same parameter values except $m_1 = 0.05$, results in the maintenance of the a allele in population 1 (Figure A13-2a). In this case, the rate of migration of the alternative allele was not high enough to completely overcome the selective advantage of the local allele. This example illustrates how, under this model, a relatively small absolute difference in the rate of gene flow can make a big difference in the patterns of diversity among populations.

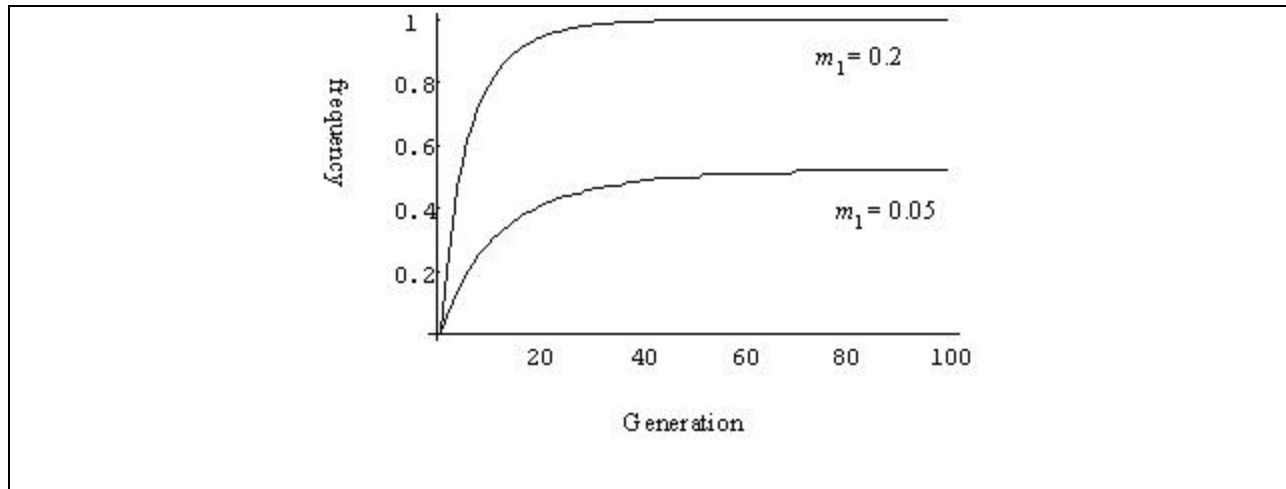

Figure A13-2a. Frequency of the A allele in population 1 with $m_1 = 0.2$ (top line) or $m_1 = 0.05$ (bottom line).

Box A14. Examples of loss of diversity or adaptation due to human-caused gene flow alteration.

Example A14-1. Grand Coulee Dam. The construction of Grand Coulee Dam in 1939 blocked anadromous fish from reaching over 1,800 river kilometers of the Columbia River Basin (reviewed by Mullan et al. 1992). In order to mitigate this effect, all anadromous fish were trapped at Rock Island Dam from 1939 to 1943 and were either released to spawn in tributaries between Rock Island Dam and Grand Coulee Dam, or they spawned in hatcheries and their offspring were released in this area (Mullan et al. 1992, Chapman et al. 1994). Although the effects of this process on among-population diversity cannot be easily quantified (because pre-dam data on population attributes are scant), it is likely that this random mixing of anadromous salmonids from several major subbasins caused substantial diversity losses among the populations.

Example A14-2. Straying of Columbia River fall chinook into the Snake River. In their status review of Snake River fall chinook salmon, Waples et al. (1991) illustrate the effects stray Columbia River fall chinook have on allozyme allele frequencies in Snake River fall chinook. Figure A14-2a shows temporal changes in allele frequencies of fall chinook in the Columbia River (wild fish from the Hanford Reach and fish from Priest Rapids Hatchery) and Snake River (wild fish sampled at Ice Harbor Dam and fish sampled at Lyons Ferry Hatchery). Strays from Columbia River hatcheries (primarily fall chinook reared at Bonneville Hatchery and released in the Umatilla River) first started appearing in the Snake River in significant numbers in the late 1980s, and about the same time, allele frequencies in Snake River fall chinook converged toward the allele frequencies of the Columbia River groups. (Note that the allele frequency plotted for Snake River fall chinook at the PEP-LT locus in 1985 is incorrect. It is actually 0.875, rather than the 0.90 plotted in the figure [A. Marshall¹²].)

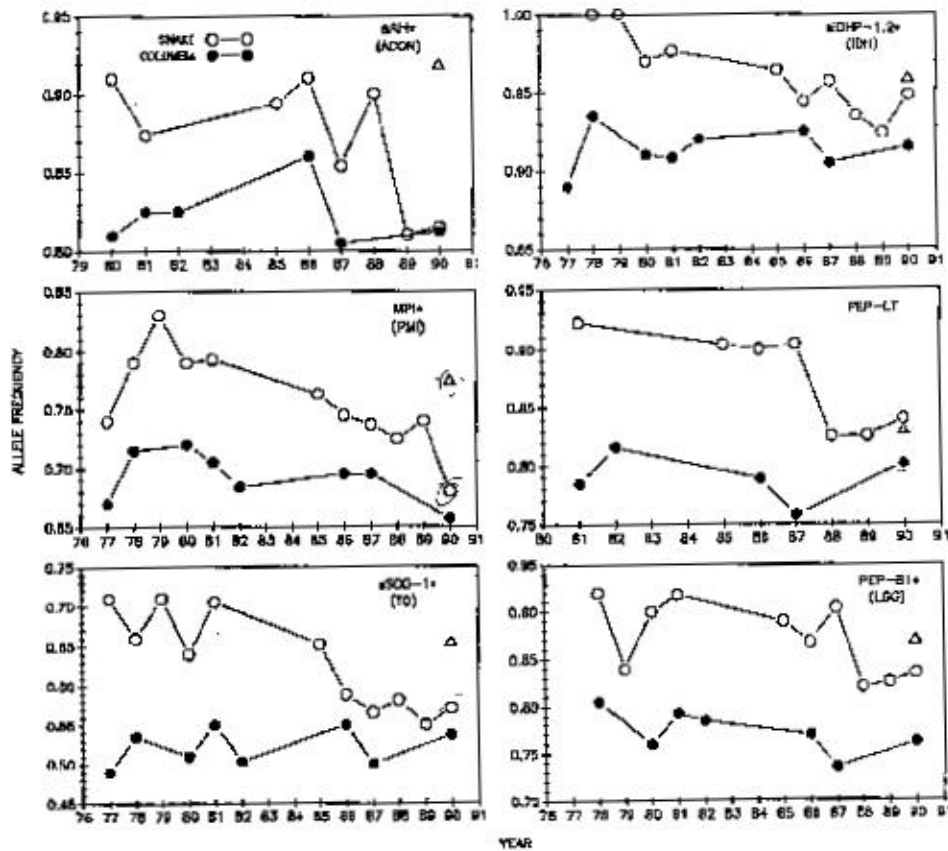

Figure A14-2a. Time series of allele frequency data at six gene loci for fall chinook salmon from the Snake and upper Columbia Rivers, based on NMFS and WDF data summarized by Busack (1991b, Table 10). Old locus names (as used by Utter et al. 1982) are shown in parentheses below current names. Upper Columbia River data points are for wild samples from the Hanford Reach area and samples from Pries Rapids Hatchery; unweighted averages were used in combining multiple samples from the same year. Pre-1985 samples for the Snake River are for presumably wild fish collected at Ice Harbor Dam; later samples are from Lyons Ferry Hatchery. Two Lyons Ferry samples were analyzed in 1990; the open circle represents the sample of returning CWT Lyons Ferry fish (primarily from the 1986 brood). (Reproduced from Waples et al. 1991.)

¹² Anne Marshall, WDFW, 600 Capital Way N., Olympia, WA 98501-1091. Pers. comm. April 2000.

Example 14-3a. Loss of resistance to *C. shasta* in Metolius River rainbow trout. Differential resistance to locally endemic pathogens is one type of local adaptation. Currens et al. (1997) provide an example of how introgression of non-local genes can reduce the fitness of a locally-adapted population. The freshwater parasite *C. shasta* is present in much of the Columbia River Basin, but generally absent from coastal systems. Salmonid populations in the Columbia River Basin are generally resistant to the parasite, whereas coastal populations are generally susceptible (see Example A11-3). Currens et al. (1997) compared the resistance to *C. shasta* of a) native Deschutes River rainbow trout and steelhead collected from areas with no history of hatchery releases, b) hatchery rainbow trout from stocks originally derived from susceptible coastal populations and planted in the Metolius River for many decades, and c) natural-origin Metolius River rainbow trout. The Metolius River trout had allozyme allele frequencies and phenotypic trait distributions that were intermediate between the native Deschutes River trout and the coastal-origin hatchery stocks released into the Metolius River— indicating that Metolius River trout populations had hybridized with the non-native hatchery stocks. The Metolius River populations were also intermediate in susceptibility to *C. shasta*—indicating that gene flow from these non-native populations has reduced the local populations' resistance to this pathogen.

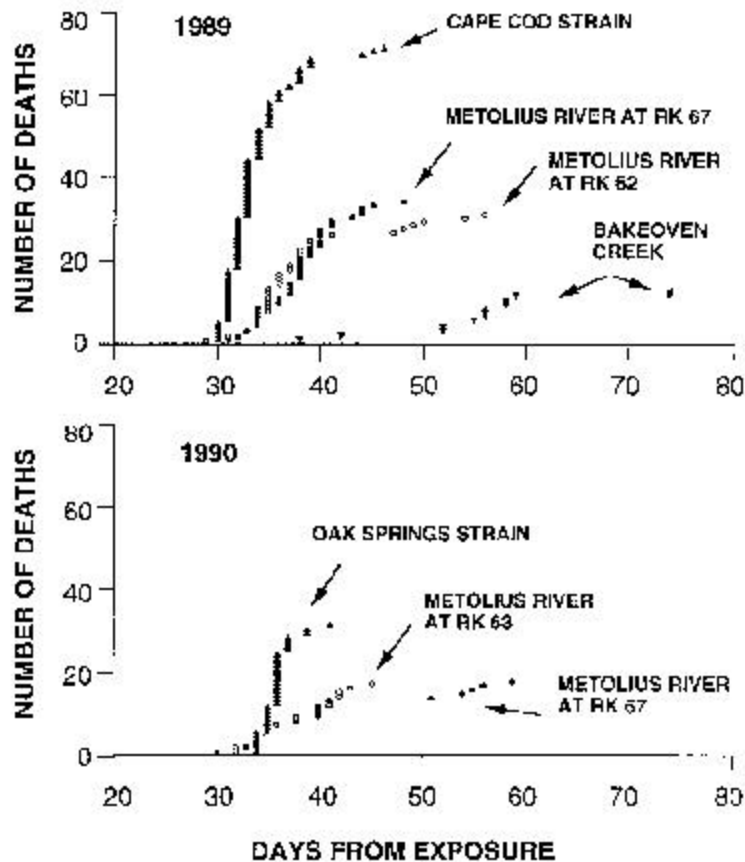

Figure A14-3a. Days to death by ceratomyxosis from initial exposure of rainbow trout to *Ceratomyxa shasta*, 1989 and 1990. The Cape Cod and Oak Springs strains are coastal origin hatchery stocks that were commonly planted in the Metolius River. The Metolius River fish are natural-origin fish sampled from the Metolius River, and the Bakeoven Creek fish are native juvenile steelhead sampled from Bakeoven Creek. (Reproduced from Currens et al. 1997.)

and references therein). This is the approach advocated by Ryman et al. (1995), who suggest that acceptable rates of introgression be based on estimates of Nm , the number of genetically effective migrants into a population per generation. Under an infinite island model of migration, approximate values of Nm can be estimated from the relationship $Nm = 1/(4F_{ST} - 4)$ (see Box A13 and discussion in “Types of information used in identifying populations,” p. 39). Rates of gene flow among geographically diverse salmonid populations have been estimated using population genetic survey data, and estimated levels of gene flow based on the genetic data are generally very low. For example, Utter et al. (1989) surveyed variation among West Coast chinook salmon at 25 polymorphic allozyme loci, and estimated F_{ST} among major drainages (roughly corresponding to the chinook salmon ESUs—Myers et al. 1998) to be 0.06. This estimate of F_{ST} results in an estimate of Nm of about four migrants per generation, which for chinook salmon is about one migrant per year. Because these major drainages typically contain thousands of spawners each generation, an estimate of four migrants per generation implies that only a very small fraction of the genetically effective spawners in each major drainage are migrants from other major drainages (e.g., if a major drainage contains $N = 1,000$ effective spawners per generation, then $m = \sim 0.4\%$). Similar levels among drainage genetic variation are found for other species (e.g., steelhead, Reisenbichler et al. 1992; sockeye, Wood et al. 1994). In addition, Johnson et al. (1999) recently used large unpublished NMFS and WDFW allozyme data sets to estimate F_{ST} among ESUs of five Pacific salmonid species—chum, coho, and chinook salmon, and steelhead and cutthroat trout. Based on these F_{ST} estimates, the average number of migrants per generation between ESUs ranges from ~ 2.5 (chinook salmon) to ~ 13 (chum salmon). Based on these examples, the average proportion of an ESU that consists of genetically effective migrants from other ESUs appears to be very small, certainly far less than 1%. We therefore conclude that if human factors (e.g., habitat degradation or hatcheries) cause sustained rates of gene flow among ESUs to be greater than $\sim 1\%$, this should definitely be cause for concern. The choice of a 1% threshold is somewhat arbitrary and this guideline may in fact be quite a bit higher than the natural rate of gene flow among many ESUs. We think a $\sim 1\%$ guideline is reasonable, however, for two reasons. First, it seems likely that ESUs can sustain rates of gene flow somewhat larger than they experienced historically and still remain viable. Second, it seems unlikely that any guideline lower than $\sim 1\%$ could be effectively monitored. Setting straying guidelines for populations within ESUs can be based on a similar approach, but due to considerable variation among ESUs no single gene flow threshold is likely to apply within all ESUs.

VSP Guidelines: Diversity

There is compelling evidence that patterns of phenotypic diversity within and among Pacific salmonid populations are strongly influenced by the environments these populations inhabit (reviewed by Ricker 1972, Taylor 1991, Healey and Prince 1995). There is less compelling but still considerable evidence that much of this diversity is adaptive (reviewed by Taylor 1991, see examples in Box A11) and that if it is lost or substantially altered population viability would decrease. In fact, as the examples in Boxes A12 and A14 illustrate, human-caused losses of diversity and adaptation have contributed to the poor status of some Pacific Northwest salmonid populations. This suggests that in order to conserve the adaptive diversity of salmonid populations, it is essential to: 1) conserve the environment to which they are adapted (e.g., Healey and Prince 1995), 2) allow natural process of regeneration and disturbance to occur

Box A15. Diversity guidelines.

1. **Human-caused factors such as habitat changes, harvest pressures, artificial propagation, and exotic species introduction should not substantially alter variation in traits such as run timing, age structure, size, fecundity, morphology, behavior, and molecular genetic characteristics.** Many of these traits may be adaptations to local conditions or they may help protect a population against environmental variation. A mixture of genetic and environmental factors usually causes phenotypic diversity, and this diversity should be maintained even if it cannot be shown to have a genetic basis.
2. **Natural processes of dispersal should be maintained. Human-caused factors should not substantially alter the rate of gene flow among populations.** Human caused inter-ESU stray rates that are expected to produce (inferred) sustained gene flow rates greater than 1% (into a population) should be cause for concern. Human caused intra-ESU stray rates that are expected to produce substantial changes in patterns of gene flow should be avoided.
3. **Natural processes that cause ecological variation should be maintained.** Phenotypic diversity can be maintained by spatial and temporal variation in habitat characteristics. This guideline involves maintaining processes that promote ecological diversity, including natural habitat disturbance regimes and factors that maintain habitat patches of sufficient quality for successful colonization.
4. **Population status evaluations should take uncertainty about requisite levels of diversity into account.** Our understanding of the role diversity plays in Pacific salmonid viability is limited. Historically, salmonid populations were generally self-sustaining, and the historical representation of phenotypic diversity serves as a useful “default” goal in maintaining viable populations.

(e.g., Reeves et al. 1995), and 3) limit or remove human-caused selection or straying that weakens the adaptive fit between a salmonid population and its environment or limits a population's ability to respond to natural selection (e.g., Ryman et al. 1995).

Viable ESUs

Three factors need to be considered when relating VSPs to viable ESUs: 1) Catastrophic events, 2) long-term demographic processes, and 3) long-term evolutionary potential. In this section we describe the effect each of these factors has with respect to viability and we lay out guidelines for evaluating ESU viability.

Catastrophes

A catastrophe is a sudden event that severely reduces or eliminates an entire population. For the purposes of this discussion “severe” reductions involve elimination of more than 75% of the breeding adults, though we acknowledge that this is a somewhat arbitrary threshold that may be modified to reflect the dynamics of a particular population or ESU. By “sudden,” we mean events that happen within a single season, though the impact may not be observed until several seasons later. Events that unfold over a longer time span are discussed in the sections on long-term demographics and evolution. It should be noted that environmental events form a continuum from catastrophes to the “normal” environmental variation considered in VSP analysis.

Historically, natural catastrophes that affect entire populations were probably rare events at the 100-year time scale (Bisson et al. 1997). However, human activity may have increased the frequency of some types of catastrophe. We considered the effects of catastrophes at the ESU level rather than at the individual population level for three reasons: 1) because they have the potential to affect large as well as small populations, catastrophes can differ qualitatively from the stochastic processes considered in VSP evaluations, 2) concerns about catastrophic risk may extend beyond the 100-year time scale used to evaluate VSPs, and 3) catastrophic events can affect more than one population at a time, making it appropriate to evaluate catastrophic risk at the ESU-level. Although we are discussing catastrophes at the level of the ESU, it will generally be necessary to evaluate the catastrophic risk in terms of individual populations, and then integrate this information in an overall assessment of ESU status. Catastrophic events may be of natural or anthropogenic origin or a combination of the two. Natural catastrophes include volcanoes, earthquakes, disease epidemics, extreme weather, landslides, and unusual fires. Anthropogenic catastrophes include oil and chemical spills, dam construction, water diversion/dam failures, and major miscalculations in harvest plans. Catastrophes may also result from the interaction of natural and anthropogenic effects. For example, a rainstorm that would have little effect on a salmonid population under pristine conditions could become a catastrophe in a heavily modified landscape that has been clear-cut or intensively urbanized. Thus, human activities can increase the frequency of some types of catastrophic events. Bisson et al. (1997) list different types of natural and anthropogenic disturbances that affect salmon populations and attempt to estimate the frequency of each.

Catastrophes can profoundly affect extinction risk. In fact, models predict that the rate and severity of catastrophes can be the most important factor in determining a population's extinction risk (Menges 1990, Lande 1993, Mangel and Tier 1994). For example, the recovery plan for the federally-listed southern sea otter in California identified catastrophic oil spills as the primary risk to population viability. Recovery goals were based on quantitative estimates of the risks associated with this type of catastrophe (Ralls et. al. 1996). Given the number of potential catastrophic threats facing salmonid populations, in many situations we would expect catastrophes to have a substantial influence on extinction risk. Thus, most of the guidelines regarding ESU viability focus on catastrophic risk.

If estimates of the per-population rate of catastrophic events can be obtained, it may be possible to get an estimate of the extinction risk posed by catastrophes to the entire ESU. Reliability theory is a branch of probability modeling that is used by engineers to predict the rate of device failure as a function of the rate of failure of the individual components in the device (Barlow and Proschan 1975, Leemis 1995, Wolstenholme 1999). Populations may be considered as "components" in the "device" that is the ESU (Ruckelshaus et. al, 2000). Using reliability theory, scenarios involving different combinations of populations can be explored to test hypotheses about ESU viability. In a simple scenario, for example, ESU extinction risk from catastrophes may be estimated after assuming that five populations are necessary for ESU persistence and all five populations have the same risk of catastrophic extinction. This can be compared to a scenario in which only two populations are assumed necessary. Using the tools of reliability theory, it is possible to explore quite complicated scenarios in which populations have different catastrophic risks of failure, certain populations or "types" of populations are considered a priori to be essential for viability and in which population recovery is possible. The major obstacle in the application of reliability theory is obtaining accurate estimates of catastrophe rates.

Long-term Demographic and Evolutionary Processes

The VSP guidelines focus on processes that occur at temporal scales of 100 years or less. However, an ESU's long-term viability also depends on population extinction and recolonization processes that occur over longer time scales. Because catastrophic events are certain to occur at one point or another, we expect populations or groups of salmonid populations occasionally to become extinct from natural causes. In addition to catastrophic events, gradual, but significant climatic shifts can lead to population extinction, as can habitat changes arising from ecological succession or changes in environmental conditions. After a catastrophic event or climate shift we expect a new configuration of populations to arise within an ESU as some populations are lost and new populations are established. All of these large-scale changes in ESU structure may be accompanied by changes in evolutionary dynamics and genetic characteristics.

Although long-term (>100 year) demographic and evolutionary processes unarguably operate in salmonid ESUs, it is difficult to make credible quantitative predictions about ESU viability over long time spans. There is a general recognition that among-population genetic and phenotypic diversity is important to persistence and that the spatial distribution of diversity influences long-term dynamics, but it is difficult to generalize beyond these simple statements.

Therefore, perhaps the best recommendation with regard to long-term processes is ESU Viability Guideline 7, which recommends that when in doubt, we should strive to maintain historic population numbers and distributions.

ESU Viability Guidelines

Box A16. ESU viability guidelines.

1. **ESUs should contain multiple populations.** If an ESU is made up of multiple populations, it is less likely that a single catastrophic event will cause it to become extinct. Also, ESUs may function as “metapopulations” over the long term and the existence of multiple populations would be necessary for the operation of sustainable population-level extinction/recolonization processes. In addition, multiple populations within an ESU increase the likelihood that a diversity of phenotypic and genotypic characteristics will be maintained, thus allowing natural evolutionary processes to operate and increasing the ESU’s viability in the long term. Obviously, this guideline does not apply to ESUs that appear to contain a single population (e.g., Lake Ozette sockeye). In ESUs containing a single population, Guideline 6 becomes increasingly important.
2. **Some populations in an ESU should be geographically widespread.** Spatially correlated environmental catastrophes are less likely to drive a widespread ESU to extinction. This guideline also directly relates to the ESA mandate of protecting a species in a “significant portion of (its) range.”
3. **Some populations should be geographically close to each other.** On long temporal scales, ESUs may function as “metapopulations” and having populations geographically close to one another facilitates connectivity among existing populations. Thus, a viable ESU requires both widespread (Guideline 2) AND spatially close populations.
4. **Populations should not all share common catastrophic risks.** An ESU containing populations that do not share common catastrophic risks is less likely to be driven to extinction by correlated environmental catastrophes. Maintaining geographically widespread populations is one way to reduce risk associated with correlated catastrophes (Guideline 2), but spatial proximity is not the only reason why two populations could experience a correlated catastrophic risk.
5. **Populations that display diverse life-histories and phenotypes should be maintained.** When an ESU’s populations have a fair degree of life-history diversity (or other phenotypic diversity), the ESU is less likely to go extinct as a result of correlated environmental catastrophes or changes in environmental conditions that occur too rapidly for an evolutionary response. In addition—assuming phenotypic diversity is caused at least in part by genetic diversity—maintaining diversity allows natural evolutionary processes to operate within an ESU.
6. **Some populations should exceed VSP guidelines.** Larger and more productive (“resilient”) populations may be able to recover from a catastrophic event that would cause the extinction of a smaller population. An ESU that contains some populations in excess of VSP threshold criteria for abundance and population growth rate is less likely to go extinct in response to a single catastrophic event that affects all populations. It is important to note that the abundance guidelines do not take catastrophes into account. This guideline is particularly relevant if an ESU consists of a single population.
7. **Evaluations of ESU status should take into account uncertainty about ESU-level processes.** Our understanding of ESU-level spatial and temporal process is very limited. ESUs are believed to have been historically self-sustaining and the historical number and distribution of populations serve as a useful “default” goal in maintaining viable ESUs.

LITERATURE CITED

- Adkison, M. D. 1995. Population differentiation in Pacific salmon: Local adaptation, genetic drift, or the environment? *Can. J. Fish. Aquat. Sci.* 52: 2762-2777.
- Allendorf, F. W. 1975. Genetic variability in a species possessing extensive gene duplication: Genetic interpretation of duplicate loci and examination of genetic variation in populations of rainbow trout. Ph.D. Thesis. University of Washington, Seattle, WA, 98 p.
- Allendorf, F. W., and G. H. Thorgaard. 1984. Tetraploidy and the evolution of salmonid fishes. *In* B. J. Turner (ed.), *Evol. Genet. Fish.* p. 1-53. Plenum Press, New York.
- Allendorf, F. W., D. Bayles, D. L. Bottom, K. P. Currens, C. A. Frissell, D. Hankin, J. A. Lichatowich, W. Nehlsen, P. C. Trotter, and T. H. Williams. 1997. Prioritizing Pacific salmon stocks for conservation. *Conserv. Biol.* 11: 140-152.
- Barker, R. J., and J. R. Sauer. 1992. Modeling population change from time series data. *In* D. R. McCullough and R. Barrett (eds.), *Wildlife 2001: Populations*, p.182-194. Elsevier, New York.
- Barlow, R. E., and F. Proschan. 1975. *Statistical theory of reliability and life testing probability models.* Holt, Rinehart and Winston, New York, 290 p.
- Barnhart, R. A. 1986. Species profiles: Life histories and environmental requirements of coastal fishes and invertebrates (Pacific Southwest)—steelhead. *U.S. Fish Wild. Serv. Biol. Rep.* 82: 11-60.
- Barnhart, R. A. 1995. Salmon and steelhead populations of the Klamath-Trinity Basin, California. *In* T. J. Hassler (ed.), *Klamath Basin Fisheries Symposium*, p. 73-97. California Cooperative Fishery Unit. Humboldt State University, Arcata, CA.
- Barrowclough, G. 1980. Gene flow, effective population sizes, and genetic variance components in birds. *Evolution* 34: 789-798.
- Bartley, D., M. Bagley, G. Gall, and B. Bentley. 1992. Use of linkage disequilibrium data to estimate effective size of hatchery and natural fish populations. *Conserv. Biol.* 6: 365-375.
- Barton, N. H. 1983. Multilocus clines. *Evolution* 37: 454-471.
- Bascompte, J., and R. V. Sole. 1996. Habitat fragmentation and extinction thresholds in spatially explicit models. *J. Anim. Ecol.* 65: 465-473.
- Beacham, T. D., and T. P. T. Evelyn. 1992. Genetic variation in disease resistance and growth of chinook, coho, and chum salmon with respect to vibriosis, furunculosis, and bacterial kidney disease. *Tran. Am. Fish. Soc.* 121: 456-485.

- Beamish, R. J., and D. R. Bouillon. 1993. Pacific salmon production trends in relation to climate. *Can. J. Fish. Aquat. Sci.* 50: 1002-1016.
- Beamish, R. J., C. Mahnken, and L. M. Neville. 1997. Hatchery and wild production of Pacific salmon in relation to large-scale, natural shifts in productivity of the marine environment. *ICES J. Mar. Sci.* 54: 1200-1215.
- Beamish, R. J., D. J. Noakes, G. A. MacFarlane, L. Klyshatorin, V. V. Ivanov, and V. Kurashov. 1999. The regime concept and natural trends in the production of Pacific salmon. *Can. J. Fish. Aquat. Sci.* 56: 516-526.
- Belovsky, G. E. 1987. Extinction models and mammalian persistence. In M. E. Soulé (ed.), *Viable populations for conservation*, p. 35-57. Cambridge University Press, Cambridge, MA.
- Bence, J. R. 1995. Analysis of short time series: correcting for autocorrelation. *Ecology* 76: 628-639.
- Benda, L. E. 1994. Stochastic geomorphology in a humid mountain landscape. Ph.D. Thesis. University of Washington, Seattle, WA, 356 p.
- Berryman, D., B. Bobee, D. Cluis, and J. Haemmerli. 1988. Nonparametric tests for trend detection in water quality time series. *Water Resour. Bull.* 24: 545-556.
- Beverton, R. J. H., and S. J. Holt. 1957. On the dynamics of exploited fish populations. *Minist. Agric. Fish. (UK)*, London, 533 p.
- Bigler, B. S., D. W. Welch, and J. H. Helle. 1996. A review of size trends among North Pacific salmon (*Oncorhynchus* spp.). *Can. J. Fish. Aquat. Sci.* 53: 455-465.
- Bilby, R. E., B. R. Fransen, and P. A. Bisson. 1996. Incorporation of nitrogen and carbon from spawning coho salmon into the trophic system of small streams: Evidence from stable isotopes. *Can. J. Fish. Aquat. Sci.* 53: 164-173.
- Bilby, R. E., B. R. Fransen, P. A. Bisson, and J. K. Walter. 1998. Response of juvenile coho salmon (*Oncorhynchus kisutch*) and steelhead (*Oncorhynchus mykiss*) to the addition of salmon carcasses to two streams in southwestern Washington, USA. *Can. J. Fish. Aquat. Sci.* 55: 1909-1918.
- Bilby, B. E., G. R. Pess, B. Feist, and T. J. Beechie. 1999. Freshwater Habitat and Salmon Recovery: Relating Land Use Actions to Fish Population Response. *Proceedings of the Fish Habitat Workshop*, National Marine Fisheries Service. Seattle, WA, 28 p.

- Bisson, P. A., G. H. Reeves, R. E. Bilby, and R. J. Naiman. 1997. Watershed management and Pacific salmon: Desired future conditions. *In* D. J. Stouder, P. A. Bisson, and R. J. Naiman (eds.), *Pacific salmon and their ecosystems*, p. 447-474. Chapman and Hall, New York.
- Bjorkstedt, E. P., unpubl. data. National Marine Fishery Service, southwest Fishery Science Center, 3150, Paradise Dr., Tiboron, CA 94920-1205.
- Bjorkstedt, E. P. 2000. Stock-recruitment relationships for life cycles that exhibit concurrent density dependence. *Can. J. Fish. Aquat. Sci.* 54: 459-467.
- Botsford, L. W., and J. G. Brittnacher. 1998. Viability of Sacramento winter-run chinook salmon. *Conserv. Biol.* 12: 65-79.
- Bouzat, J. L., H. H. Cheng, H. A. Lewin, R. L. Westemeier, J. D. Brown, and K. N. Paige. 1998a. Genetic evaluation of a demographic bottleneck in the Greater Prairie Chicken. *Conserv. Biol.* 12: 836-843.
- Bouzat, J. L., H. A. Lewin, and K. N. Paige. 1998b. The ghost of genetic diversity past: Historical DNA analysis of the greater prairie chicken. *Am. Nat.* 152: 1-6.
- Box, G. E. P., G. C. Tiao. 1975. Intervention analysis with applications to economic and environment problems. *J. Am. Stat. Assoc.* 70: 70-79.
- Bradford, M. J. 1995. Comparative review of Pacific salmon survival rates. *Can. J. Fish. Aquat. Sci.* 52: 1327-1338.
- Bradford, M. J. 1999. Temporal and spatial trends in the abundance of coho salmon smolts from Western North America. *Trans. Am. Fish. Soc.* 128: 840-846.
- Bradford, M. J., G. C. Taylor, and J. A. Allan. 1997. Empirical review of coho salmon smolt abundance and prediction of smolt production at the regional level. *Trans. Am. Fish. Soc.* 126: 49-64.
- Brawn, J. D., and S. K. Robinson. 1996. Source-sink population dynamics may complicate the interpretation of long-term census data. *Ecology* 77: 3-12.
- Brown, L. G. 1995. Mid-Columbia River summer steelhead stock assessment: A summary of the Priest Rapids steelhead sampling project 1986-1994 cycles. WA. Dep. Fish Wild. Progress Report Number AF95-02, 85 p.
- Bryant, E. H., and M. Meffert. 1990. The effects of bottlenecks on genetic variation, fitness and quantitative traits in the housefly. *In* E. C. Dudley (ed.), *Fourth International Congress of Systematic and Evolutionary Biology*, p. 591-601. Dioscordies Press, Portland, OR.
- Bulmer, M. G. 1972. Multiple niche polymorphism. *Am. Nat.* 106: 254-257.

- Burger, R., and M. Lynch. 1995. Evolution and extinction in a changing environment: A quantitative-genetic analysis. *Evolution*. 49: 151-163.
- Burgman, M. A., S. Ferson, and H. R. Akcakaya. 1993. Risk assessment in conservation biology. Chapman and Hall, New York, 314 p.
- Burgner, R. L. 1991. Life history of sockeye salmon *Oncorhynchus nerka*. In C. Groot and L. Margolis (eds.), Pacific salmon life histories, p. 3-117. University of British Columbia Press, Vancouver, B. C.
- Busby, P. J., T. C. Wainwright, G. J. Bryant, L. J. Lierheimer, R. S. Waples, F. W. Waknitz, and I. V. Lagomarsino. 1996. Status review of West Coast steelhead from Washington, Idaho, Oregon, and California. NOAA Tech. Memo. NMFS-NWFSC-27, 261 p.
- Busby, P. J., T. C. Wainwright, and R. S. Waples. 1994. Status review for Klamath Mountains Province steelhead. NOAA Tech. Memo. NMFS-NWFSC-19, 130 p.
- Caballero, A. 1994. Developments in the prediction of effective population size. *Heredity* 73: 657-679.
- California Department of Fish and Game (CDFG). 1998. Report to the Fish and Game Commission: a status review of the spring-run chinook salmon (*Oncorhynchus tshawytscha*) in the Sacramento River drainage. California Department of Fish and Game Candidate Species Status Report 98-01.
- Caswell, H. 1989. Matrix Population Models: Construction, Analysis, and Interpretation. Sinauer, Associates, Sunderland, MA, 328 p.
- Caughley, G. 1994. Directions in conservation biology. *J. Anim. Ecol.* 63: 215-244.
- Caughley, G., and A. Gunn. 1996. Conservation biology in theory and practice. Blackwell Science, Cambridge, MA, 459 p.
- Chapman, D., C. Pevan, T. Hillman, A. Giorgi, and F. Utter. 1994. Status of summer steelhead in the mid-Columbia River. Don Chapman Consultants Inc., Boise, ID, 235 p.
- Chilcote, M. W., S. A. Leider, and J. J. Loch. 1986. Differential reproductive success of hatchery and wild summer-run steelhead under natural conditions. *Trans. Am Fish Soc.* 115: 726-735.
- Clarke, W. C., R. E. Withler, and J. E. Shelbourn. 1992. Genetic control of juvenile life history pattern in chinook salmon (*Oncorhynchus tshawytscha*). *Can J. Fish. Aquat. Sci.* 49: 2300-2306.

- Connor, R. N. 1988. Wildlife populations: Minimally viable or ecologically functional? *Wildl. Soc. Bull.* 16: 80-84.
- Cooper, A. B., and M. Mangel. 1999. The dangers of ignoring metapopulation structure for the conservation of salmonids. *Fish. Bull.* 97: 213-226.
- Courchamp, F., T. Clutton-Brock, and B. Grenfell. 1999. Inverse density-dependence and the Allee effect. *Trends Ecol. Evol.* 14: 405-410.
- Craig, J. K. 1995. Genetic divergence in spawning color of sympatric forms of sockeye salmon (*Oncorhynchus nerka*): Investigation of an unknown form. Master's Thesis. University of Washington, Seattle, WA, 105 p.
- Cramer, S. P. 1989. Contribution of Sacramento Basin hatcheries to ocean catch and river escapement of fall chinook salmon. S. P. Cramer and Associates, Inc., Gresham, OR, 113 p.
- Crawford, T. J. 1984. What is a population? *In* B. Shorrocks (ed.), *Evolutionary Ecology*, p. 135-173. Blackwell International, Oxford.
- Crow, J., and K. Aoki. 1984. Group selection for a polygenic behavioral trait: estimating the degree of population subdivision. *Proc. Nat. Acad. Sci. (USA)* 81: 6073-6077.
- Crow, J. F., and M. Kimura. 1970. *An introduction to populations genetics theory*. Harper & Row, New York, 591 p.
- Currens, K. P., S. L. Stone, and C. B. Schreck. 1987. A genetic comparison of rainbow trout (*Salmo gairdneri*) above and below Izee Falls in the John Day River, Oregon. Genetics Lab Report (87) 2. Oregon Cooperative Fisheries Research Unit, Department of Fisheries and Wildlife, Oregon State University. Corvallis, OR, 34 p.
- Currens, K., J. Lannan, B. Riddell, D. Tave, and C. Wood. 1996. *U.S. v. Oregon* dispute resolution. Responses of the independent scientific panel to questions about the interpretation of genetic data for spring chinook salmon in the Grand Ronde Basin. Draft Report, 43 p.
- Currens, K. P., A. R. Hemmingsen, R. A. French, D. V. Buchanan, C. B. Schreck, and W. L. Hiram. 1997. Introgression and susceptibility to disease in a wild population of rainbow trout. *N. Am. J. Fish. Manage.* 17: 1065-1078.
- Currens, K. P., F. W. Allendorf, D. Bayles, D. L. Bottom, C. A. Frissell, D. Hankin, J. A. Lichatowich, P. C. Trotter, and T. A. Williams. 1998. Conservation of Pacific salmon: Response to Wainwright and Waples. *Conserv. Biol.* 12: 1148-1149.
- Cushing, J. M. 1996. Nonlinear Matrix Equations and Population Dynamics. *In* S. Tuljapurkar and H. Caswell (eds.), *Structured-population models in marine, terrestrial, and freshwater systems*, p. 205-243. Chapman & Hall.

- Day, J. R., and H. P. Possingham. 1995. A stochastic metapopulation model with variability in patch size and position. *Theor. Popul. Biol.* 48: 333-360.
- Dempson, J. B., and D. E. Stansbury. 1991. Using partial counting fences and a two-sample stratified design for mark-recapture estimation of an Atlantic salmon smolt population. *N. Am. J. Fish. Manage.* 11.
- Dennis, B. 1989. Allee effects: Population growth, critical density, and the chance of extinction. *Natural Resource Modeling* 3: 481-538.
- Dennis, B., W. P. Kemp, and M. L. Taper. 1998. Joint density dependence. *Ecology* 79: 426-441.
- Dennis, B., P. L. Munholland, and J. M. Scott. 1991. Estimation of growth and extinction parameters for endangered species. *Ecol. Monogr.* 61: 115-143.
- Dennis, B., and M. L. Taper. 1994. Density dependence in time series observations of natural populations: Estimation and testing. *Ecol. Monogr.* 64: 205-224.
- DeVries, P. 1997. Riverine salmonid egg burial depths: review of published data and implications for scour studies. *Can. J. Fish. Aquat. Sci.* 54: 1685-1698.
- Donaldson, L. R. 1968. Selective breeding of salmonids fishes. *In* W. J. McNeil (ed.), *Marine Aquaculture. Selected papers from the conference on marine aquaculture*, p. 65-74. Oregon State University Press, Corvallis, OR.
- Dunham, J. B., and B. E. Rieman. 1999. Metapopulation structure of bull trout: influences of physical biotic and geometrical landscape characteristics. *Ecol. Apps.* 9: 642-655.
- Ehrlich, P. R., and J. R. Roughgarden. 1987. *The Science of Ecology*. MacMillian Publishing Company, New York, 710 p.
- Emlen, J. M. 1995. Population viability of the Snake River chinook salmon (*Oncorhynchus tshawytscha*). *Can. J. Fish. Aquat. Sci.* 52: 1442-1448.
- Endler, J. A. 1986. *Natural Selection in the Wild*. Princeton University Press, Princeton, NJ, 337 p.
- English, K. K., R. C. Bocking, and J. C. Irvine. 1992. A robust procedure for estimating salmon escapement based on the area-under-the-curve method. *Can. J. Fish. Aquat. Sci.* 49: 1982-1989.
- Fagan, W. F., E. Meir, and J. L. Moore. In press. Variation thresholds for extinction and their implications for conservation strategies. *Am. Nat.*

- Fahrig, L., and G. Merriam. 1994. Conservation of fragmented populations. *Conserv. Biol.* 8: 50-59.
- Falconer, D. S. 1981. *Introduction to Quantitative Genetics*. Longman Group Ltd., Essex, England, 340 p.
- Falconer, D. S., and T. F. C. Mackay. 1996. *Introduction to Quantitative Genetics*. Longman Group Ltd., Essex, England, 464 p.
- Felsenstein, J. 1976. The theoretical population genetics of variable selection and migration. *Annu. Rev. Genet.* 10: 253-280.
- Felsenstein, J. 1997. Population differentiation and evolutionary processes. *In* W. S. Grant (ed.), *Genetic effects of straying of non-native hatchery fish into natural populations*, p. 31-43. NOAA Tech. Memo. NMFS-NWFSC-30.
- Fleming, I. A., and M. R. Gross. 1993. Breeding success of hatchery and wild coho salmon (*Oncorhynchus kisutch*) in competition. *Ecol. Apps.* 3: 230-245.
- Fleming, I. A., and M. R. Gross. 1989. Evolution of adult female life history and morphology in a Pacific salmon (coho: *Oncorhynchus kisutch*). *Evolution* 43: 141-157.
- Foerster, R. E. 1936. The return from the sea of sockeye salmon (*Oncorhynchus nerka*) with special reference to percentage survival, sex proportions and progress of migration. *J. Biol. Board Can.* 3: 26-42.
- Foerster, R. E. 1968. The sockeye salmon, *Oncorhynchus nerka*. *Bull. Fish. Res. Board Can.* 162: 422.
- Foley, P. 1994. Predicting extinction times from environmental stochasticity and carrying capacity. *Conserv. Biol.* 8: 124-137.
- Foley, P. 1997. Extinction models for local populations. *In* I. A. Hanski and M. E. Gilpin (eds.), *Metapopulation biology: ecology genetics and evolution*, p. 215-246. Academic Press, San Diego, CA.
- Foote, C. J., C. C. Wood, and R. E. Withler. 1989. Biochemical genetic comparison of sockeye salmon and kokanee, the anadromous and nonanadromous forms of *Oncorhynchus nerka*. *Can. J. Fish. Aquat. Sci.* 46: 149-158.
- Ford, M. J. 1998. Testing models of migration and isolation among populations of chinook salmon (*Oncorhynchus tshawytscha*). *Evolution* 52: 539-557.

- Ford, M., P. Budy, C. Busack, D. Chapman, T. Cooney, T. Fisher, J. Geiselman, T. Hillman, J. Lukas, C. Peven, C. Toole, E. Weber, and P. Wilson. 1999a. Upper Columbia River steelhead and spring chinook salmon population structure and biological requirements. Draft report prepared by the Upper Columbia River Steelhead and Spring Chinook Salmon Biological Requirements Committee, dated 14 December 1999. National Marine Fisheries Service, Northwest Fisheries Science Center.
- Ford, M. J., P. J. Thornton, and L. K. Park. 1999b. Natural selection promotes divergence of transferrin among salmonid species. *Mol. Ecol.* 8: 1055-1061.
- Frankham, R. 1995. Effective population size/adult population size ratios in wildlife: A review. *Genet. Resour.* 66: 95-107.
- Frankham, R. 1998. Inbreeding and extinction: Island population. *Conserv. Biol.* 12: 665-675.
- Franklin, I. R. 1980. Evolutionary change in small populations. *In* M. E. Soulé and B. A. Wilcox (eds.), *Conservation Biology, An Evolutionary-Ecological Perspective*, p. 135-149. Sinauer Associates, Sunderland, MA.
- Gabriel, W., and R. Bürger. 1992. Survival of small populations under demographic stochasticity. *Theor. Popul. Biol.* 41: 44-71.
- Garcia, T. 1998. Letter from Terry Garcia (Assistant Secretary for Oceans and Atmosphere Department of Commerce) to Ted Strong (Executive Director of the Columbia River Inter-Tribal Fish Commission) re: federal trust responsibility to the four Columbia River Treaty Tribes and the Endangered Species Act, dated 21 June 1998. 2 p. U.S. Department of Commerce, Assistant Secretary for Oceans and Atmosphere, Washington D.C., 20230.
- Geiger, H. J., W. W. Smoker, L. A. Zhivotovsky, and A. J. Gharrett. 1997. Variability of family size and marine survival in pink salmon (*Oncorhynchus gorbuscha*) has implications for conservation biology and human use. *Can. J. Fish. Aquat. Sci.* 54: 2684-2690.
- Gerrodette, T. 1987. A power analysis for detecting trends. *Ecology* 68: 1364-1372.
- Gerrodette, T. 1991. Models for power of detecting trends—a reply to Link and Hatfield. *Ecology* 72: 1889-1892.
- Getz, W. M., and R. G. Haight. 1989. Population harvesting: Demographic models of fish, forest, and animal resources. *Monogr. Popul. Biol.* 27. Princeton University Press, Princeton, NJ, 391 p.
- Gharrett, A. J., S. M. Shirley, and G. R. Tromble. 1987. Genetic relationships among populations of Alaskan chinook salmon (*Oncorhynchus tshawytscha*). *Can. J. Fish. Aquat. Sci.* 44: 765-774.

- Giger, R. D. 1972. Ecology and management of coastal cutthroat trout in Oregon. Fisheries Research Report. Oregon State Game Commission, Corvallis, OR, 61 p.
- Gilpin, M. 1993. Metapopulations and wildlife conservation: approaches to modeling spatial structure. In D. R. McCullough (ed.), *Metapopulations and wildlife conservation*, p. 11-27. Island Press, Washington D.C.
- Gilpin, M. E. 1987. Spatial structure and population vulnerability. In M. E. Soulé (ed.), *Viable populations for conservation*, p. 125-139. Cambridge University Press, Cambridge, MA.
- Ginzburg, L. R., S. Ferson, and H. R. Akçakaya. 1990. Reconstructability of density dependence and the conservative assessment of extinction risks. *Conserv. Biol.* 4: 63-70.
- Glubokovsky, M. K., and L. A. Zhibbotovski. 1989. Population structure of pink salmon. In A. B. Zhermunki, V. V. Effremov, and M. K. Glubokovsky (eds.), *Transactions of Salmon Management of the Far East*, p. 34-51. USSR Academy of Sciences, Far Eastern Section, Vladivostok.
- Goodman, D. 1987. The demography of chance extinction. In M. E. Soulé (ed.), *Viable populations for conservation*, p. 11-34. Cambridge University Press, Cambridge.
- Grant, A., and T. G. Benton. 2000. Elasticity analysis for density-dependent populations in stochastic environments. *Ecology* 81: 680-693.
- Grant, W. S. 1997. Genetic effects of straying of non-native hatchery fish into natural populations: Proceedings of the Workshop 1-2 June 1995. Seattle, WA, 130 p.
- Grenfell, B. T., K. Wilson, B. F. Finkenstadt, T. N. Coulson, S. Murray, S. D. Albon, J. M. Pemberton, T. H. Clutton-Brock, and M. J. Crawley. 1998. Noise and determinism in synchronized sheep dynamics. *Nature* 394: 674-677.
- Groot, C., and L. Margolis. 1991. *Pacific Salmon Life Histories*. University of British Columbia Press, Vancouver, B. C., 564 p.
- Grosberg, R. K. 1987. Limited dispersal and proximity-dependent mating success in the colonial ascidian *Botryllus schlosseri*. *Evolution* 41: 372-384.
- Grosberg, R. K. 1991. Sperm-mediated gene flow and the genetic structure of a population of the colonial ascidian *Botryllus schlosseri*. *Evolution* 45: 130-142.
- Gustafson, R., T. C. Wainwright, G. A. Winans, F. W. Waknitz, L. T. Parker, and R. S. Waples. 1997. Status Review of Sockeye Salmon from Washington and Oregon. NOAA Tech. Memo. NMFS-NWFSC, Seattle, WA, 282 p.

- Gyllenberg, M., and I. Hanski. 1997. Habitat deterioration, habitat destruction and metapopulation persistence in a heterogeneous landscape. *Theor. Popul. Biol.* 52: 198-215.
- Gyllenberg, M., I. Hanski, and A. Hastings. 1997. Structured metapopulation models. *In* I. Hanski and M. E. Gilpin (eds.), *Metapopulation biology: Ecology, genetics, and evolution*, p. 93-122. Academic Press, San Diego, CA.
- Hankin, D. G., and G. H. Reeves. 1988. Estimating total fish abundance and total habitat area in small streams based on visual estimation methods. *Can. J. Fish. Aquat. Sci.* 45: 834-844.
- Hankin, D. G., J. W. Nicholas, and T. W. Downey. 1993. Evidence for inheritance of age of maturity in chinook salmon (*Onchorhynchus tshawytscha*). *Can. J. Fish. Aquat. Sci.* 50.
- Hanski, I., and M. E. Gilpin. 1997. *Metapopulation biology: ecology, genetics and evolution*. Academic Press, San Diego, CA, 512 p.
- Hanski, I., and D. Simberloff. 1997. The metapopulation approach, its history, conceptual domain, and application to conservation. *In* I. Hanski and M. E. Gilpin (eds.), *Metapopulation biology: Ecology, genetics and evolution*, p. 5-26. Academic Press, San Diego, CA.
- Hanski, I., A. Moilanen, and M. Gyllenberg. 1996. Minimum viable metapopulation size. *Am. Nat.* 147: 527-541.
- Hard, J. J. 1995a. Genetic monitoring of life-history characters in salmon supplementation: Problems and opportunities. *Am. Fish. Soc. Symp.* 15: 212-225.
- Hard, J. J. 1995b. A quantitative genetic perspective on the conservation of intraspecific diversity, Evolution and the Aquatic Ecosystem: Defining unique units in population conservation, p. 304-326. *Am. Fish. Soc. Symp.*
- Hard, J. J., R. P. Jones Jr., M. R. Delarm, and R. S. Waples. 1992. Pacific Salmon and Artificial Propagation under the Endangered Species Act. NOAA Tech. Memo. NMFS-NWFSC-2, 56 p.
- Hard, J. J., G. A. Winans, and J. C. Richardson. In press. Phenotypic and genetic architecture of juvenile morphometry in chinook salmon. *J. Hered.*
- Hare, S. R., N. J. Mantua, and R. C. Francis. 1999. Inverse production regimes: Alaska and West coast Pacific salmon. *Fisheries* 24: 6-14.
- Harrison, S. 1994. Metapopulations and conservation. *In* P. J. Edwards, R. M. May, and N. R. Webb (eds.), *British ecological society symposium; large-scale ecology and conservation biology*, p. 111-128.

- Harrison, S., and A. D. Taylor. 1997. Empirical evidence for metapopulation dynamics. *In* I. Hanski and M. E. Gilpin (eds.), *Metapopulation biology: Ecology, genetics and evolution*, p. 27-42. Academic Press, San Diego, CA.
- Hartigan, J. A. 1975. *Clustering algorithms*. Wiley and Sons, New York, 351 p.
- Hartl, D. L., and A. G. Clark. 1989. *Principles of Population Genetics*. Sinauer Associates, Sunderland, MA, 682 p.
- Hartman, G. F., L. B. Holtby, and J. C. Scrivener. 1984. Some effects of natural and logging-related winter stream temperature changes on the early life history of coho salmon (*Oncorhynchus kisutch*) in Carnation Creek, British Columbia. *In* W. R. Meehan, T. R. Merrell, and T. A. Hanley (eds.), *Fish and wildlife relationships in old-growth forests*, p. 141-149. Proceedings of a symposium sponsored by Alaska District, American Institute of Fishery Research Biologists, Northwest Section, The Wildlife Society, Alaska Council on Science and Technology, Juneau, AK.
- Hastings, A. 1993. Complex interactions between dispersal and dynamics: Lessons from coupled logistic equations. *Ecology* 74: 1362-1372.
- Hastings, A., and S. Harrison. 1994. Metapopulation dynamics and genetics. *Annu. Rev. Ecol. Syst.* 25: 167-188.
- Healey, M. C. 1991. The life history of chinook salmon (*Oncorhynchus tshawytscha*). *In* C. Groot and L. Margolis (eds.), *Life history of Pacific salmon*, p. 313-393. University of British Columbia Press, Vancouver, B. C.
- Healey, M. C., and A. Prince. 1995. Scales of variation in life history tactics of Pacific salmon and the conservation of phenotype and genotype. *Am. Fish. Soc. Symp.* 17: 176-184.
- Heath, D. D., R. H. Devlin, J. W. Heath, and J. K. Iwama. 1994. Genetic, environmental and interaction effects on the incidence of jacking in *Oncorhynchus tshawytscha* (chinook salmon). *Heredity* 72: 146-154.
- Hess, G. 1996. Disease in metapopulation models: Implications for conservation. *Ecology* 77: 1617-1632.
- Hilborn, R. 1985. Apparent stock recruitment relationships in mixed stock fisheries. *Can. J. Fish. Aquat. Sci.* 42: 718-723.
- Hilborn, R., and M. Mangle. 1997. *The Ecological Detective: Confronting Models with Data*. Princeton University Press, Princeton, NJ, 315 p.
- Hilborn, R., and C. J. Walters. 1992. *Quantitative fisheries stock assessment: Choice, dynamics, & uncertainty*. Chapman and Hall, New York, 570 p.

- Hilborn, R., B. G. Bue, and S. Sharr. 1999. Estimating spawning escapements from periodic counts: a comparison of methods. *Can. J. Fish. Aquat. Sci.* 56: 888-896.
- Hinch, S. G., and P. S. Rand. 1998. Swim speeds and energy use of upriver-migrating sockeye salmon (*Onchorhynchus nerka*): Role of local environment and fish characteristics. *Can. J. Fish. Aquat. Sci.* 55: 1821-1831.
- Holling, C. S. 1978. *Adaptive Environmental Assessment and Management*. John Wiley & Sons, New York, 377 p.
- Holtby, L. B. 1987. The effects of logging on the coho salmon of Carnation Creek, British Columbia. *Applying 15 years of Carnation Creek Results*, p. 159-174. Nanaimo, B. C.
- Hooten, M. M. 1995. Distinguishing forms of statistical density dependence and independence in animal time series data using information criteria. Ph.D. Thesis. Montana State University, Bozeman, MT, 150 p.
- Houlden, B. A., P. R. England, A. C. Taylor, W. D. Greville, and W. B. Sherwin. 1996. Low genetic variability of the koala *Phascolarctos cinereus* in south-eastern Australia following a severe population bottleneck. *Mol. Ecol.* 5: 269-281.
- Howell, P., K. Jones, D. Scarnecchia, W. LaVoy, Kendra, and D. Ortmann. 1985. Stock assessment of Columbia River anadromous salmonids Volume II: Steelhead stock summaries stock transfer guidelines—information needs. Final Report to Bonneville Power Administration. Bonneville Power Administration, P.O Box 3621, Portland OR 97208, 1032 p.
- Hurlburt, S. 1984. Pseudoreplication and the design of ecological field experiments. *Ecol. Monogr.* 54: 187-211.
- Ibarra, A. M., R. P. Hedrick, and G. A. E. Gall. 1994. Genetic analysis of rainbow trout susceptibility to the myxosporean, *Ceratomyxa shasta*. *Aquaculture* 120: 239-262.
- Iles, T. C. 1994. A review of stock-recruitment relationships with reference to flatfish populations. *Neth. J. Sea Res.* 32: 399-420.
- Iles, T. C., and R. J. H. Beverton. 1998. Stock, recruitment and moderating processes in flatfish. *J. Sea Res.* 39: 41-55.
- International Union for the Conservation of Nature (IUCN). 1994. *International Union for the Conservation of Nature Red List Categories*. IUCN Species Survival Commission. Gland, Switzerland, 21 p.
- Irvine, J. R., R. C. Bocking, K. K. English, and M. Labelle. 1992. Estimating coho salmon (*Oncorhynchus kisutch*) spawning escapements by conducting visual surveys in areas selected using stratified random and stratified index sampling designs. *Can. J. Fish. Aquat. Sci.* 49: 1972-1981.

- Ishida, Y., I. Soto-o, M. Kaeriyama, S. McKinnel, and K. Nagasawa. 1993. Recent changes in age and size of chum salmon (*Oncorhynchus keta*) in the North Pacific Ocean and possible causes. *Can. J. Fish. Aquat. Sci* 50: 290-295.
- Jassby, A. D., and T. M. Powell. 1990. Detecting changes in ecological time series. *Ecology* 71: 2044-2052.
- Jimenez, J. A., K. A. Hughes, G. Alaks, L. Graham, and R. C. Lacy. 1994. An experimental study of inbreeding depression in a natural habitat. *Science* 266: 271-273.
- Johnson, O., M. H. Ruckelshaus, W. S. Grant, F. W. Waknitz, A. M. Garrett, G. J. Bryant, K. Neely, and J. J. Hard. 1999. Status Review of Coastal Cutthroat Trout from Washington, Oregon and California. NOAA Tech. Memo. NMFS-NWFSC. Seattle, WA, 292 p.
- Judson, O. P., and B. B. Normark. 1996. Ancient asexual scandals. *Trends Ecol. Evol.* 11: 41-46.
- Kareiva, P. 1990. Population dynamics in spatially complex environments: theory and data. *Trans. R. Soc. Lond. B* 330: 175-190.
- Kelso, B., and T. Northcote. 1981. Current Response of Young Rainbow Trout from Inlet and Outlet Spawning Stocks of a British Columbia Lake. *Theor. Appl. Limnol.* 21: 1214-1221.
- Kendall, B. E., and G. A. Fox. 1998. Spatial structure, environmental heterogeneity, and population dynamics: Analysis of the coupled logistic map. *Theor. Popul. Biol.* 54: 11-37.
- Kimura, M. 1983. The neutral theory of molecular evolution. Cambridge University Press, Cambridge, MA, 367 p.
- Kinnison, M., M. Unwin, N. Boustead, and T. Quinn. 1998. Population-specific variation in body dimensions of adult chinook salmon (*Oncorhynchus tshawytscha*) from New Zealand and their source population, 90 years after introduction. *Can. J. Fish. Aquat. Sci.* 55: 554-563.
- Kline, T. C. J., J. J. Goering, and R. J. Piorkowski. 1997. The effect of salmon carcasses on Alaskan freshwaters. *In* A. M. Milner and M. W. Osweed (eds.), *Freshwaters of Alaska Ecological Syntheses*. *Ecol. Stud.*, p. 179-204. Springer, New York.
- Kline, T. C. J., J. J. Goering, O. A. Mathisen, P. H. Poe, and P. L. Parker. 1990. Recycling of elements transported upstream by runs of Pacific salmon: I. ^{15}N and ^{13}C evidence in Sashin Creek, southeastern Alaska. *Can. J. Fish. Aquat. Sci.* 47: 136-144.

- Kline, T. C., Jr., J. J. Goering, O. A. Mathisen, P. H. Poe, P. L. Parker, and R. S. Scalen. 1993. Recycling of elements transported upstream by runs of Pacific salmon: II. ^{15}N and ^{13}C evidence in the Kvichack River watershed, Bristol Bay, southwestern Alaska. *Can. J. Fish. Aquat. Sci.* 50: 2350-2365.
- Koehn, R. K., W. J. Diehl, and T. M. Scott. 1988. The differential contribution by individual enzymes of glycolysis and protein catabolism to the relationship between heterozygosity and growth rate in the coot clam *Mulinia lateralis*. *Genetics* 118: 121-130.
- Kope, R. G., and L. W. Botsford. 1988. Detection of environmental influence on recruitment using abundance data. *Can. J. Fish. Aquat. Sci.* 45: 1448-1458.
- Korman, J., and P. S. Higgins. 1997. Utility of escapement time series data for monitoring the response of salmon populations to habitat alteration. *Can. J. Fish. Aquat. Sci.* 54: 2058-2067.
- Korman, J., R. M. Peterman, and C. J. Walters. 1995. Empirical and theoretical analyses of correction of time-series bias in stock-recruitment relationships of sockeye salmon (*Oncorhynchus nerka*). *Can. J. Fish. Aquat. Sci.* 52: 2174-2189.
- Kostow, K. 1995. Biennial report on the status of wild fish in Oregon. Oregon Department of Fish and Wildlife Report, 217 p. + app.
- Labelle, M. 1992. Straying patterns of coho salmon (*Oncorhynchus kisutch*) stocks from southeast Vancouver Island, B.C. *Can. J. Fish. Aquat. Sci.* 49: 1843-1855.
- Labelle, M. 1994. A likelihood method for estimating Pacific salmon escapement based on fence counts and mark-recapture data. *Can. J. Fish. Aquat. Sci.* 51: 552-566.
- Lande, R. 1988a. Demographic models of the northern spotted owl (*Strix occidentalis*). *Oecologia* 75: 601-607.
- Lande, R. 1988b. Genetics and demography in biological conservation. *Science* 241: 1455-1460.
- Lande, R. 1993. Risks of population extinction from demographic and environmental stochasticity and random catastrophes. *Am. Nat.* 142: 911-927.
- Lande, R. 1994. Risk of population extinction from fixation of new deleterious mutations. *Evolution* 48: 1460-1469.
- Lande, R. 1995. Mutation and Conservation, p. 782-791. *Conserv. Biol.*
- Lande, R. 1998. Demographic stochasticity and Allee effect on a scale with isotropic noise. *Oikos* 83: 353-358.

- Lande, R., and S. J. Arnold. 1983. The measurement of selection on correlated characters. *Evolution* 37: 1210-1226.
- Lande, R., and S. H. Orzack. 1988. Extinction dynamics of age-structured populations in a fluctuating environment. *Proc. Nat. Acad. Sci. USA* 85: 7418-7421.
- Lande, R., and S. Shannon. 1996. The role of genetic variation in adaptation and population persistence in a changing environment. *Evolution* 50: 434-437.
- Latter, B. D. H. 1998. Mutant alleles of small effect are primarily responsible for the loss of fitness with slow inbreeding in *Drosophila melanogaster*. *Genetics* 148: 1143-1158.
- Latter, B. D. H., J. C. Mulley, D. Reid, and L. Pascoe. 1995. Reduced genetic load revealed by slow inbreeding in *Drosophila melanogaster*. *Genetics* 139: 287-297.
- Leary, R. F., F. W. Allendorf, and K. L. Knudsen. 1983. Developmental stability and enzyme heterozygosity in rainbow trout. *Nature* 301: 71-72.
- Leary, R. F., F. W. Allendorf, and K. L. Knudsen. 1985a. Developmental instability and high meristic counts in interspecific hybrids of salmonid fishes. *Evolution* 39: 1318-1326.
- Leary, R. F., F. Allendorf, and K. L. Knudsen. 1985b. Developmental instability as indicator of reduced genetic variation in hatchery trout. *Trans. Am. Fish. Soc.* 114: 230-235.
- Leemis. 1995. *Reliability: probabilistic models and statistical method*. Prentice-Hall, Englewood Cliffs, NJ, 319 p.
- Lehman, M., R. K. Wayne, and B. S. Stewart. 1993. Comparative levels of genetic variability in harbour seals and northern elephant seals as determined by genetic fingerprinting. *Symp. Zool. Soc. London* 66: 49-60.
- Leider, S., S. R. Phelps, and P. L. Hulett. 1995. Genetic analysis of Washington steelhead: Implications for revision of genetic conservation management units. WA. Dep. Fish Wild. Progress Report. Washington Department of Fish and Wildlife, Olympia, WA, 21 p.
- Leider, S. A., P. L. Hulett, J. J. Loch, and M. W. Chilcote. 1990. Electrophoretic comparison of the reproductive success of naturally spawning transplanted and wild steelhead trout through the returning adult stage. *Aquaculture* 88: 239-252.
- Lele, S., M. L. Taper, and S. Gage. 1998. Statistical analysis of population dynamics in space and time using estimating functions. *Ecology* 79: 1489-1502.
- Lestelle, L. C., L. E. Moberg, J. A. Lichatowich, and T. S. Vogel. 1996. Applied ecosystem analysis-a primer, EDT: The ecosystem diagnosis and treatment method. Available at <http://www.efw.bpa.gov/cgi-bin/FW/publications.cgi>. Bonneville Power Administration, Portland, OR.

- Levin, D. 1988. Consequences of stochastic elements in plant migration. *Am. Nat.* 132: 643-651.
- Levins, D. A. 1970a. Developmental instability and evolution in peripheral isolates. *Am. Nat.* 104: 343-353.
- Levins, R. 1969. Some demographic and genetic consequences of environmental heterogeneity for biological control. *Bull. Entomol. Soc. Am.* 15: 237-240.
- Levins, R. 1970b. Extinction. In Gerstenharber (ed.), *Some mathematical problems in biology*, p. 75-107. Am. Math. Soc., Providence, RI.
- Lidicker, W. Z., and W. D. Koenig. 1996. Responses of terrestrial vertebrates to habitat edges and corridors. In D. R. McCullough (ed.), *Metapopulations and Wildlife Conservation*, p. 85-109. Island Press, Washington D.C.
- Liermann, M., and R. Hilborn. 1997. Depensation in fish stocks: A hierarchic Bayesian meta-analysis. *Can. J. Fish. Aquat. Sci.* 54: 1976-1984.
- Lindley, S. Unpubl. data. Analyses on the population dynamics of San Joaquin River chinook as a function of river flow. National Marine Fisheries Service, Southwest Fisheries Science Center, 3150 Paradise Dr., Tiboron, CA 94920-1205.
- Link, W. A., and J. S. Hatfield. 1990. Power calculations and model selection for trend analysis: A comment. *Ecology* 71: 217-1220.
- Ludwig, D. 1998. Management of stocks that may collapse. *Oikos* 83: 397-402.
- Lynch, M. 1990. Mutation load and the survival of small populations. *Evolution* 44: 1725-1737.
- Lynch, M., and B. Walsh. 1998. *Genetics and Analysis of Quantitative Traits*. Sinauer Associates, Sunderland, MA, 980 p.
- MacArthur, R. H., and E. O. Wilson. 1967. *The theory of island biogeography*. Monographs in population biology 1. Princeton University Press, Princeton, NJ, 203 p.
- MacDonald, P. D. M., and H. D. Smith. 1980. Mark-recapture estimation of salmon smolt runs. *Biometrics* 36: 401-417.
- Mangel, M., and C. Teir. 1994. Four facts every conservation biologist should know about persistence. *Ecology* 75: 607-614.
- Mantua, N. J., S. R. Hare, Y. Zhang, J. M. Wallace, and R. C. Francis. 1997. A Pacific interdecadal climate oscillation with impacts on salmon production. *Bull. Am. Meteorol. Soc.* 78: 1069-1079.

- Marshall, A. R., C. Smith, R. Brix, W. Dammers, J. Hymer, and L. LaVoy. 1995. Genetic diversity units and major ancestral lineages for chinook salmon in Washington. *In* C. B. a. J. B. Shaklee (ed.), Genetic diversity units and major ancestral lineages of salmonid fishes in Washington, p. 111-173. Washington Department of Fish and Wildlife, Olympia, WA.
- Mayr, E. 1988. *Toward a New Philosophy of Biology*. Belknap Press of Harvard University Press, Cambridge, MA, 564 p.
- McAllister, M. K., and G. P. Kirkwood. 1998. Bayesian stock assessment: A review and example application using the logistic model. *ICES J. Mar. Sci.* 55: 1031-1060.
- McCarthy, M. A., D. B. Lindenmayer, and M. Drechsler. 1997. Extinction debts and risks faced by abundant species. *Conserv. Biol.* 11: 221-226.
- McCullough, D. R., (ed.) 1996. *Metapopulations and wildlife conservation*. Island Press, Washington, D.C., 429 p.
- McIsaac, D. O. 1990. Factors affecting the abundance of 1977-1979 brook wild fall chinook salmon (*Oncorhynchus tshawytscha*) in the Lewis River, Washington. Ph.D. Thesis. University of Washington, Seattle, WA, 174 p.
- McKinnell, S. M., and O. Karlstrom. 1999. Spatial and temporal covariation in the recruitment and abundance of Atlantic salmon populations in the Baltic sea. *ICES J. Mar. Sci.* 56: 433-443.
- McNaughton, S. J., and L. L. Wolf. 1973. *General Ecology*. Holt, Rinehard and Winston, Inc., New York, 710 p.
- McQuarrie, D. W., and D. D. Bailey. 1980. Adult returns to Thornton Creek. *In* K. Sandercock (ed.), Proc. 31st Annual NW Fish Cult. Conf., p. 36-44. Fisheries and Oceans Canada (DFO), 555 West Hastings St., Vancouver, B.C. V6S 5G3 Canada.
- Meagher, T. 1986. Analysis of paternity within a natural population of *Chamaelirium luteum*. I. Identification of male parentage. *Am. Nat.* 128: 199-215.
- Meagher, T., and E. Thompson. 1987. Analysis of parentage for naturally established seedlings of *Chamaelirium luteum* (Liliaceae). *Ecology* 68: 803-812.
- Meffe, G. K., and C. R. Carroll. 1994. *Principles of Conservation Biology*. Sinauer Associates, Inc., Sunderland, MA, 600 p.
- Meir, E., and W. F. Fagan. 2000. Will observation error and biases ruin the use of simple extinction models? *Conserv. Biol.* 14: 148-154.

- Menges, E. S. 1990. Population viability analysis for an endangered plant. *Conserv. Biol.* 4: 52-62.
- Middleton, D. A. J., and R. M. Nisbet. 1997. Population persistence times: Estimates, models and mechanisms. *Ecol. Apps.* 7: 107-117.
- Millar, R. B., and R. Meyer. 2000. Bayesian stat-space modeling age-structured data: fitting a model is just the beginning. *Can. J. Fish. Aquat. Sci.* 57: 43-50.
- Mills, L. S., and P. E. Smouse. 1994. Demographic consequences of inbreeding in remnant populations. *Am. Nat.* 144: 412-431.
- Mills, L. S., D. F. Doak, and M. J. Wisdom. 1999. Reliability of conservation actions based on elasticity analysis of matrix models. *Conserv. Biol.* 13: 815-829.
- Milner, N. J., R. J. Wyatt, and M. D. Scott. 1993. Variability in the distribution and abundance of stream salmonids, and the associated use of habitat models. *J. Fish Biol.* 43 (Suppl. A): 103-119.
- Mobrand, L. E., J. A. Lichatowich, L. C. Lestelle, and T. S. Vogel. 1997. An approach to describing ecosystem performance "through the eyes of salmon". *Can. J. Fish. Aquat. Sci.* 54: 2964-2973.
- Montgomery, D. R., J. M. Buffington, N. P. Peterson, D. Schuett-Hames, and T. P. Quinn. 1996. Stream-bed scour, egg burial depths, and the influence of salmonid spawning on bed surface mobility and embryo survival. *Can. J. Fish. Aquat. Sci.* 53: 1061-1070.
- Morris, W., D. Doak, M. Groom, P. Kareiva, J. Fieberg, L. Gerber, P. Murphy, and D. Thomson. 1999. A practical handbook for population viability analysis. The Nature Conservancy, Washington D.C.
- Mousalli, E., and R. Hilborn. 1986. Optimal stock size and harvest rate in multistage life history models. *Can. J. Fish. Aquat. Sci.* 43: 135-141.
- Mousseau, T. A., K. Ritland, and D. D. Heath. 1998. A novel method for estimating heritability using molecular markers. *Heredity* 80: 218-224.
- Mullan, J. W., K. R. Williams, G. Rhodus, T. W. Hillman, and J. D. McIntyre. 1992. Production and Habitat of Salmonids in Mid-Columbia River Tributary Streams. U.S. Fish and Wildlife Service: 489 p.
- Myers, J. M., R. G. Kope, G. J. Bryant, D. Teel, L. J. Leirheimer, T. C. Wainwright, W. S. Grant, F. W. Waknitz, K. Neely, S. T. Lindley, and R. S. Waples. 1998. Status review of chinook salmon from Washington, Idaho, Oregon and California, 443 p.

- Myers, R. A., N. J. Barrowman, J. A. Hutchings, and A. A. Rosenberg. 1995. Population dynamics of exploited fish stocks at low population levels. *Science* 269: 1106-1108.
- National Marine Fisheries Service (NMFS). 1991. Notice of Policy: Policy on applying the definition of species under the Endangered Species Act to Pacific salmon. *Fed. Reg.* 56: 58612-58616.
- National Marine Fisheries Service (NMFS). 1993. Interim policy on artificial propagation of Pacific salmon under the Endangered Species Act. *Fed. Reg.* 58: 17573-17576.
- National Marine Fisheries Service (NMFS). 1995a. Endangered Species Act-Section 7 Consultation, Biological Opinion, Reinitiation of Consultation on the 1994-1998 Operation of the Federal Columbia River Power System and Juvenile Transportation Program in 1995 and Future Years.
- National Marine Fisheries Service (NMFS). 1995b. Proposed Recovery Plan for Snake River Salmon, pag. var.
- National Marine Fisheries Service (NMFS). 1996. Making Endangered Species Act Determinations of Effect for Individual or Grouped Actions at the Watershed Scale.
- National Marine Fisheries Service (NMFS). 1997. Proposed recovery plan for the Sacramento River winter-run chinook salmon, pag. var.
- National Marine Fisheries Service (NMFS). 1999. Endangered and threatened species; threatened status for three chinook salmon evolutionarily significant units (ESUs) in Washington and Oregon, and endangered status for one chinook salmon ESU in Washington. *Fed. Reg.* 64: 14308-14328.
- National Marine Fisheries Service (NMFS). 2000a. Draft Recovery Planning Guidance for Technical Recovery Teams. National Marine Fisheries Service, Northwest Fisheries Science Center. Seattle, WA, 20 p.
- National Marine Fisheries Service (NMFS). 2000c. A standardized quantitative analysis of risks faced by salmonids in the Columbia River basin, National Marine Fisheries Service, Northwest Fisheries Science Center, Cumulative Risk Initiative. Seattle, WA, 127 p.
- National Research Council. 1966. Committee on Protection and Management of Pacific Northwest Anadromous Salmonids. *Upstream: Salmon and Society in the Pacific Northwest*. National Academy Press, Washington, D.C. 472 p.
- National Research Council. 1999. Committee on Ecosystem Management for Sustainable Marine Fisheries. *Sustaining Marine Fisheries*. National Academy Press, Washington, D.C., 164 p.
- Nehlsen, W., J. E. Williams, and J. A. Lichatowich. 1991. Pacific salmon at the crossroads: Stocks at risk from California, Oregon, Idaho, and Washington. *Fisheries* 16: 4-21.

- Nei, M., and D. Graur. 1984. Extent of protein polymorphisms and the neutral mutation theory. *Evol. Biol.* 17: 73-118.
- Newman, D., and D. Pilson. 1997. Increased probability of extinction due to decreased genetic effective population size: Experimental population of *Clarkia pulchella*. *Evolution* 51: 354-362.
- Nicholson, A. J. 1933. The balance of animal populations. *J. Anim. Ecol.* 2: 132-178.
- Nickelson, T. E., and P. W. Lawson. 1998. Population viability of coho salmon, *Oncorhynchus kisutch*, in Oregon coastal basins: application of a habitat-based life cycle model. *Can. J. Fish. Aquat. Sci.* 55: 2383-2392.
- Nickelson, T. E., M. F. Solazzi, and S. L. Johnson. 1986. Use of hatchery coho salmon (*Oncorhynchus kisutch*) psmolts to rebuild wild populations in Oregon coastal streams. *Can. J. Fish. Aquat. Sci.* 43: 2443-2449.
- Nickelson, T. S., J. D. Rodgers, S. L. Johnson, and M. F. Solazzi. 1992. Seasonal Changes in Habitat Use by Juvenile Coho Salmon (*Oncorhynchus kisutch*) in Oregon Coastal Streams. *Can. J. Fish. Aquat. Sci.* 49: 783-789.
- Nickerson, D. M., and A. Brunell. 1997. Power analysis for detecting trends in the presence of concomitant variables. *Ecology* 79: 1442-1447.
- Northwest Pacific Power Council (NWPPC). 1994. Grande Ronde model watershed program, Report 6b GR. Northwest Pacific Power Council and Grande Ronde Model Watershed Program, La Grande, OR.
- O'Brien, S. J., D. E. Wildt, D. Goldman, C. R. Merrill, and M. Bush. 1983. The cheetah is depauperate in genetic variation. *Science* 221: 459-462.
- O'Brien, S. J., M. E. Roelke, L. Marker, A. Newman, C. A. Winkler, D. Meltzer, L. Colly, J. F. Evermann, M. Bush, and D. E. Wildt. 1985. Genetic basis for species vulnerability in the cheetah. *Science* 227: 1428-1434.
- Pacific Fishery Management Council (PFMC). 1999. Draft Amendment 14 to the Pacific Coast Salmon Plan (1997). Pacific Fishery Management Council, Portland, OR.
- Parkinson, E. A. 1984. Genetic variation in populations of steelhead trout (*Salmo gairdneri*) in British Columbia. *Can. J. Fish. Aquat. Sci.* 41: 1412-1420.
- Peterman, R. M. 1987. Review of the components of recruitment in Pacific salmon. *Am. Fish. Soc. Symp.* 1: 417-429.

- Peterman, R. M. 1990. Statistical power analysis can improve fisheries research and management. *Can. J. Fish. Aquat. Sci.* 47: 2-15.
- Peterman, R. M., and M. J. Bradford. 1987. Statistical power of trends in fish abundance. *Can. J. Fish. Aquat. Sci.* 44: 1879-1889.
- Pielou, E. C. 1991. *After the Ice Age: The return of life to glaciated North America.* University of Chicago Press, Chicago, IL, 366 p.
- Pimm, S. L. 1991. *The balance of nature? Ecological issues in the conservation of species and communities.* University of Chicago Press, Chicago, IL, 434 p.
- Policansky, D., and J. J. Magnuson. 1998. Genetics, metapopulations, and ecosystem management of fisheries. *Ecol. Apps.* 8: S119-S123.
- Prager, M. H., and J. M. Hoenig. 1989. Superposed epoch analysis: a randomization test of environmental effects on recruitment with application to chub mackerel. *Trans. Am. Fish. Soc.* 118: 608-618.
- Prager, M. H., and J. M. Hoenig. 1992. Can we determine the significance of key-event effects on a recruitment time series? A power study of superposed epoch analysis. *Trans. Am. Fish. Soc.* 121: 123-131.
- Pulliam, H. R. 1988. Sources, sinks and population regulation. *Am. Nat.* 132: 652-661.
- Punt, A. E., and R. Hilborn. 1997. Fisheries stock assessment and decision analysis: The Bayesian approaches. *Rev. Fish Biol. Fish.* 7: 35-63.
- Pyper, B. J., and R. M. Peterman. 1999. Relationship among adult body length, abundance, and ocean temperature for British Columbia and Alaska sockeye salmon (*Onchorhynchus nerka*). *Can. J. Fish. Aquat. Sci.* 565: 1711-1720.
- Quattro, J. M., and R. C. Vrijenhoek. 1989. Fitness differences among remnant populations of the endangered Sonoran topminnow. *Science* 245: 976-978.
- Quinn, T. 1985. Homing and the evolution of sockeye salmon (*Oncorhynchus nerka*). *Contrib. Mar. Sci.* 68: 353-366.
- Quinn, T. J. II, and R. B. Deriso. 1999. *Quantitative Fish Dynamics.* Oxford University Press, 542 p.
- Quinn, T. P., and K. Fresh. 1984. Homing and straying in chinook salmon (*Oncorhynchus tshawytscha*) from Cowlitz River hatchery, Washington. *Can. J. Fish. Aquat. Sci.* 41: 1078-1082.

- Quinn, T. P. 1993. A review of homing and straying of wild and hatchery-produced salmon. *Fish. Res.* 18: 29-44.
- Quinn, T. P., R. S. Nemeth, and D. O. D. O. McIsaac. 1991. Homing and straying patterns of fall chinook salmon in the lower Columbia River. *Trans. Am. Fish. Soc.* 120: 150-156.
- Quinn, T. P., C. C. Wood, L. Margolis, B. E. Riddell, and K. D. Hyatt. 1987. Homing in wild sockeye salmon (*Oncorhynchus nerka*) populations as inferred from differences in parasite prevalence and allozyme allele frequencies. *Can. J. Aquat. Sci.* 44: 1963-1971.
- Quinn, T. P., J. L. Nielsen, C. Gan, M. J. Unwin, R. Wilmot, C. Guthrie, and F. M. Utter. 1996. Origin and genetic structure of chinook salmon, *Oncorhynchus tshawytscha*, transplanted from California to New Zealand: Allozyme and mtDNA evidence. *Fish. Bull.* 94: 506-521.
- Raleigh, R. F. 1971. Innate control of migrations of salmon and trout fry from natal gravels to rearing areas. *Ecology* 52: 291-297.
- Ralls, K., D. P. Demaster, and J. A. Estes. 1996. Developing a criterion for delisting the southern sea otter under the U.S. Endangered Species Act. *Conserv. Biol.* 10: 1528-1537.
- Ratner, S., R. Lande, and B. B. Roper. 1997. Population viability analysis of spring chinook salmon in the South Umpqua River, Oregon. *Conserv. Biol.* 11: 879-889.
- Ray, C., and A. Hastings. 1996. Density dependence: are we searching at the wrong spatial scale? *J. Anim. Ecol.* 65: 556-566.
- Reeves, G. H., L. E. Benda, K. M. Burnett, P. A. Bisson, and J. R. Sedell. 1995a. A disturbance-based ecosystem approach to maintaining and restoring freshwater habitats of evolutionarily significant units of anadromous salmonids in the Pacific Northwest. *Am. Fish. Soc. Symp.* 17: 334-349.
- Reeves, G. H., J. D. Hall, and S. V. Gregory. 1995b. The impact of land-management activities on coastal cutthroat trout and their freshwater habitats. *In* J. D. Hall, P. A. Bisson, and R. E. Gresswell (eds.), *Sea-run cutthroat trout. Biology, management and future conservation*, p. 138-144. *Am. Fish. Soc.*
- Reimers, P. E. 1973. The length of residence of juvenile fall chinook salmon in Sixes River, Oregon. *Research Reports of the Fish Commission of Oregon* 4:2:43.
- Reisenbichler, R. R., J. D. McIntyre, M. F. Solazzi, and S. W. Landino. 1992. Genetic variation in steelhead of Oregon and Northern California. *Trans. Am. Fish. Soc.* 121: 158-169.

- Reisenbichler, R. R., and S. R. Phelps. 1989. Genetic variation in steelhead (*Salmo gairdneri*) from the North Coast of Washington. *Can. J. Fish. Aquat. Sci.* 46: 66-73.
- Rich, S. S., A. E. Bell, and S. P. Wilson. 1979. Genetic drift in small populations of *Tribolium*. *Evolution* 33: 579-584.
- Richter-Dyn, N., and N. S. Goel. 1972. On the extinction of colonizing species. *Theor. Popul. Biol.* 3: 406-433.
- Ricker, W. E. 1954. Stock and recruitment. *J. Fish. Res. Board Can.* 11: 559-623.
- Ricker, W. E. 1972. Hereditary and environmental factors affecting certain salmonid populations. In R. C. Simon and P. A. Larkin (eds.), *The Stock Concept in Pacific Salmon*, p. 27-160. University of British Columbia, Vancouver, B. C.
- Ricker, W. E. 1973. Two mechanisms that make it impossible to maintain peak-period yields from stocks of Pacific salmon and other fishes. *J. Fish. Res. Board Can.* 30: 1275-1286.
- Ricker, W. E. 1975. Computation and interpretation of biological statistics of fish populations. Environment Canada, Ottawa, 382 p.
- Ricker, W. E. 1981. Changes in the average size and average age of Pacific salmon. *Can. J. Fish. Aquat. Sci.* 38: 1636-1656.
- Ricklefs, R. E. 1973. *Ecology*. Chiron Press, Newton, MA, 861 p.
- Ridley, M. 1996. *Evolution*. Blackwell Science, Cambridge, MA, 719 p.
- Rieman, B. E., and J. D. McIntyre. 1996. Spatial and temporal variability in Bull Trout redd counts. *N. Am. J. Fish. Manage.* 16: 132-141.
- Ruckelshaus, M. 1996. Estimation of genetic neighborhood parameters from pollen and seed dispersal in the marine angiosperm *Zostera marina* L. *Evolution* 50: 856-864.
- Ruckelshaus, M., P. McElhany, and M. J. Ford. 2000. Recovering species of conservation concern: Are populations expendable? In S. Levin and P. Kareiva (eds.), *Expendable Species*. Princeton University Press, Princeton, NJ, pag. var.
- Ruggerone, G. T. 1997. Straying of coho salmon from hatcheries and net pens to streams in Hood Canal and Grays Harbor, Washington, during 1995. Natural Resources Consultants, Inc. Gladstone, OR, 72 p.
- Ryman, N., P. E. Jorde, and L. Laikre. 1995a. Supportive breeding and variance effective population size. *Conserv. Biol.* 9: 1619-1628.

- Ryman, N., F. Utter, and K. Hindar. 1995b. Introgression, supportive breeding, and genetic conservation, p. 341-365. *In* J. D. Ballour, M. Gilpin, and T. J. Foose (eds.), *Population Management for Survival & Recovery*. Columbia University Press, New York.
- Saccheri, M. K., M. Kuussaari, M. Kankare, P. Vikman, W. Fortelius, and I. Hanski. 1998. Inbreeding and extinction in a butterfly metapopulation. *Nature* 392: 491-494.
- Sakano, E. 1960. Results from marking experiments on young chum salmon in Hokkaido, 1951-1959. *Sci. Rep. Hokkaido Salmon Hatchery* 915: 17-38.
- Schlosser, I. J., and P. L. Angermeier. 1995. Spatial variation in demographic processes of lotic fishes: conceptual models, empirical evidence, and implications for conservation. *In* J. L. Nielsen (ed.), *Evolution and the aquatic ecosystem: defining unique units in population conservation*, p. 392-401. *Am. Fish. Soc. Symp.* Bethesda, Maryland.
- Schultz, S. T., and M. Lynch. 1997. Mutation and extinction: The role of variable mutational effects, synergistic epistasis, beneficial mutations, and degree of outcrossing. *Evolution* 51: 1363-1371.
- Seattle Public Utilities (SPU). 1998. Cedar River Habitat Conservation Plan, Public Comment Draft. Seattle, WA, pag. var.
- Shaffer, M. L. 1981. Minimum population sizes for species conservation. *Bioscience* 31: 131-134.
- Shapovalov, L., and A. C. Taft. 1954. The life histories of the steelhead rainbow trout (*Salmo gairdneri gairdneri*) and silver salmon (*Oncorhynchus kisutch*) with special reference to Waddell Creek, California, and recommendations regarding their management, 375 p.
- Shenk, T. M., G. C. White, and K. P. Burnham. 1998. Sampling-variance effects on detecting density dependence from temporal trends in natural populations. *Ecol. Monogr.* 68: 445-463.
- Silverstein, J. T., and W. K. Hershberger. 1992. Precocious maturation in coho salmon (*Oncorhynchus kisutch*): estimation of the additive genetic variance. *J. Hered.* 83: 282-286.
- Simberloff, D., J. A. Farr, J. Cox, and D. W. Mehlman. 1992. Movement corridors: conservation bargains or poor investment? *Conserv. Biol.* 6: 493-504.
- Skud, B. E. 1973. Factors regulating the production of pink salmon. *Rapp. P. V. Réun. Cons. Int. Explor. Mer* 164: 106-112.
- Slatkin, M. 1985. Gene flow in natural populations. *Annu. Rev. Ecol. Syst.* 16: 393-430.

- Slatkin, M. 1993. Isolation by distance in equilibrium and non-equilibrium populations. *Evolution* 47: 264-279.
- Slatkin, M., and N. H. Barton. 1989. A comparison of three indirect methods for estimating average levels of gene flow. *Evolution* 43: 1349-1368.
- Sokal, R. R., and F. J. Rohlf. 1981. *Biometry*. W. H. Freeman and Company, 859 p.
- Sola, L. S., S. Cataudella, and E. Capanna. 1981. New developments in vertebrate cytotaxonomy. III. Karyology of bony fishes: A review. *Genetica* 54: 285-328.
- Solomon, D. J. 1985. Salmon stock and recruitment, and stock enhancement. *J. Fish. Biol.* 27(Suppl. A): 45-57.
- Solow, A. R. 1998. On fitting a population model in the presence of observation error. *Ecology* 79: 1463-1466.
- Soulé, M. E. 1980. Thresholds for survival: maintaining fitness and evolutionary potential. *In* M. E. Soulé and B. A. Wilcox (eds.), *Conservation Biology*, p. 151-170. Sinauer Associates, Inc., Sunderland, MA.
- Soulé, M. E., (ed.) 1986. *Conservation biology: The science of scarcity and diversity*. Sinauer Associates, Sunderland, MA, 584 p.
- Soulé, M. E., (ed.) 1987. *Viable populations for conservation*. Cambridge University Press, Cambridge, 189 p.
- Spencer, P. D. 1999. Recent developments in population viability analysis, with specific reference to Pacific salmon, 30 p.
- Stephens, P. A., and W. J. Sutherland. 1999. Consequences of the Allee effect for behaviour, ecology, and conservation. *Trends Ecol. Evol.* 14: 401-405.
- Takahata, N., and M. Nei. 1984. F_{ST} and G_{ST} statistics in the finite island model. *Genetics* 107: 501-504.
- Tallman, R. F. 1986. Genetic differentiation among seasonally distinct spawning populations of chum salmon, *Oncorhynchus keta*. *Aquaculture* 57: 211-217.
- Tallman, R. F. 1988. Seasonal isolation and adaptation among chum salmon, *Oncorhynchus keta* (Walbaum), populations. Ph.D. Thesis. University of British Columbia, Vancouver, B. C., 374 p.
- Tallman, R. F., and M. C. Healey. 1991. Phenotypic differentiation in seasonal ecotypes of chum salmon, *Oncorhynchus keta*. *Can. J. Fish. Aquat. Sci.* 48: 661-671.

- Tallman, R. F., and M. C. Healey. 1994. Homing, straying, and gene flow among seasonally separated populations of chum salmon (*Oncorhynchus keta*). *Can. J. Fish. Aquat. Sci.* 51: 577-588.
- Tave, D. 1993. *Genetics for Fish Hatchery Managers*, Second ed. AVI Publishing Co., New York, 415 p.
- Taylor, B. L., and T. Gerrodette. 1993. The uses of statistical power in conservation biology: the vaquita and northern spotted owl. *Conserv. Biol.* 7: 489-500.
- Taylor, E. B. 1988. Adaptive variation in rheotactic and agonistic behavior in newly emerged fry of chinook salmon, *Oncorhynchus tshawytscha*, from ocean- and stream-type populations. *Can. J. Fish. Aquat. Sci.* 45: 237-243.
- Taylor, E. B. 1991. A review of local adaptation in Salmonidae, with particular reference to Pacific and Atlantic salmon. *Aquaculture* 98: 185-207.
- Taylor, E. B., C. J. Foote, and C. C. Wood. 1996. Molecular genetic evidence for parallel life history evolution within a Pacific salmon (sockeye salmon and kokanee, *Oncorhynchus nerka*). *Evolution* 50: 401-416.
- Thomas, C. D. 1990. What do real population dynamics tell us about minimum viable population sizes? *Conserv. Biol.* 4: 324-327.
- Thomas, C. D., M. C. Singer, and D. A. Boughton. 1996. Catastrophic extinction of population sources in a butterfly metapopulation. *Am. Nat.* 148: 957-975.
- Thomas, L. 1996. Monitoring long-term population change: why are there so many analysis methods? *Ecology* 77: 49-58.
- Thompson, G. G. 1991. Determining minimum viable populations under the Endangered Species Act. NOAA Tech. Memo. NMFS F/NWC-198, 78 p.
- Thornhill, N. W., (ed.) 1993. *The Natural History of Inbreeding and Outbreeding*. University of Chicago Press, Chicago, IL, 575 p.
- Tier, C., and F. B. Hanson. 1981. Persistence in density dependent stochastic populations. *Math. Biosci.* 53: 89-117.
- Tilman, D., and P. Kareiva. 1997. *Spatial ecology*. Princeton University Press, Princeton, NJ.
- Tilman, D., and C. L. Lehman. 1997. Habitat Destruction and species extinctions. In D. Tilman and P. Kareiva (eds.), *Spatial Ecology*, p. 233-249. Princeton University Press, Princeton, NJ.

- Trotter, P. C. 1989. Coastal cutthroat trout: A life history compendium. *Trans. Am. Fish. Soc.* 118: 463-473.
- Tuljapurkar, S., and H. Caswell. 1996. Structured-population models in marine, terrestrial, and freshwater systems (18). Chapman & Hall.
- Tuljapurkar, S. D., and S. E. Orzack. 1980. Population dynamics in variable environments I. Long-run growth rates and extinction. *Theor. Popul. Biol.* 18: 314-342.
- U.S. Fish and Wildlife Service (USFWS), and National Marine Fisheries Service (NMFS). 1998. *Endangered Species Consultation Handbook*, pag. var.
- Utter, F., G. Milner, G. Stahl, and D. Teel. 1989. Genetic population structure of chinook salmon, *Oncorhynchus tshawytscha*, in the Pacific Northwest. *Fish. Bull.* 87: 239-264.
- Vanderhaegen, G. 1995. Homing of coho and fall chinook salmon in Washington. Washington Department of Fish and Wildlife. Olympia, WA, 68 p.
- Wainwright, T. C., and R. S. Waples. 1998. Prioritizing Pacific salmon stocks for conservation: Response to Allendorf et al. *Conserv. Biol.* 12: 1144-1147.
- Waknitz, F. W., G. M. Matthews, T. Wainwright, and G. A. Winans. 1995. Status review for mid-Columbia River summer chinook salmon, 80 p.
- Walters, C. J. 1985. Bias in the estimation of functional relationships from time series data. *Can. J. Fish. Aquat. Sci.* 42: 147-149.
- Walters, C. J. 1986. *Adaptive Management of Renewable Resources*. Macmillan, New York, 374 p.
- Walters, C. J. 1990. A partial bias correction factor for stock-recruitment parameter estimation in the presence of autocorrelated environmental effects. *Can. J. Fish. Aquat. Sci.* 47: 516-519.
- Walters, C. J., and D. Ludwig. 1981. Effects of measurement errors on the assessment of stock-recruitment relationships. *Can. J. Fish. Aquat. Sci.* 38: 704-710.
- Waples, R. 1998. Separating the wheat from the chaff: patterns of genetic differentiation in high gene flow species. *J. Heredity* 89: 438-450.
- Waples, R. S. 1990a. Conservation genetics of Pacific salmon. III. Estimating effective population size. *J. Heredity* 81: 277-289.
- Waples, R. S. 1990b. Conservation genetics of Pacific salmon. II. Effective population size and rate of loss of genetic variability. *J. Heredity* 81: 267-276.

- Waples, R. S. 1991a. Genetic interactions between hatchery and wild salmonids: Lessons from the Pacific Northwest. *Can. J. Fish. Aquat. Sci.* 48: 124-133.
- Waples, R. S. 1991b. Genetic methods for estimating the effective size of cetacean populations. *Rep. Int. Whaling Comm*: 279-300.
- Waples, R. S. 1991c. Pacific salmon, *Oncorhynchus* spp., and the definition of "species" under the Endangered Species Act. *Mar. Fish. Rev.* 53: 11-21.
- Waples, R. S. 1995. Evolutionarily significant units and the conservation of biological diversity under the Endangered Species Act. In *Evolution and the Aquatic Ecosystem: Defining unique units in population conservation*. *Am. Fish. Soc. Symp.* 17:8-27.
- Waples, R. S., and D. J. Teel. 1990. Conservation genetics of Pacific salmon. I. Temporal changes in allele frequency. *Conserv. Biol.* 4: 144-155.
- Waples, R. S., O. W. Johnson, P. B. Aegersold, C. K. Shiflett, D. M. VanDoornik, D. J. Teel, and A. E. Cook. 1993. A genetic monitoring and evaluation program for supplemented populations of salmon and steelhead in the Snake River Basin, 50 p.
- Washington Department of Fish and Wildlife (WDFW). 1997. Final environmental impact statement for the wild salmonid policy, 133 p.
- Washington Department of Fish and Wildlife (WDFW). 1998. Washington salmonid stock inventory, coastal cutthroat trout appendix. Washington Department of Fish and Wildlife. Olympia, WA, 280 p
- Washington Department of Fish and Wildlife and Western Washington Treaty Indian Tribes (WDFW and WWTIT). 1993. 1992 Washington Salmon and Steelhead Stock Inventory, Olympia, WA, 212 p. + app.
- Weitkamp, L. A., T. C. Wainwright, G. J. Bryant, G. B. Milner, D. J. Teel, R. G. Kope, and R. S. Waples. 1995. Status review of coho salmon from Washington, Oregon and California, 258 p.
- Welch, D. W. 1986. Identifying the stock-recruitment relationship for age-structured populations using time-invariant matched linear filters. *Can. J. Fish. Aquat. Sci.* 43: 108-123.
- Wennergren, U., M. Ruckelshaus, and P. Kareiva. 1995. The promise and limitations of spatial models in conservation biology. *Oikos* 74: 349-356.
- Whitlock, M. C., and D. E. McCauley. 1999. Indirect measures of gene flow and migration: F_{ST} is not equal to $1/(4Nm + 1)$. *Heredity* 82: 117-125.

- Wilson, E. O., and W. H. Bossert. 1971. A primer of population biology. Sinauer Associates, Stamford, CT, 192 p.
- Wilson, G. M., W. K. Thomas, and A. T. Beckenbach. 1985. Intra- and inter-specific mitochondrial DNA sequence divergence in Salmon: Rainbow, steelhead and cutthroat trouts. *Can. J. Zool.* 63: 2088-2094.
- Wipfli, M. S., J. Hudson, and J. Caouette. 1998. Influence of salmon carcasses on stream productivity: Response of biofilm and benthic macroinvertebrates in southeastern Alaska, USA. *Can. J. Fish. Aquat. Sci.* 55: 1503-1511.
- Withler, R. E., W. C. Clarke, B. E. Riddell, and H. Kreiberg. 1987. Genetic variation in freshwater survival and growth of chinook salmon (*Oncorhynchus tshawytscha*). *Aquaculture* 64: 85-96.
- Wolstenholme, L. C. 1999. Reliability modeling: a statistical approach. Chapman and Hall/CRC, Boca Raton, 256 p.
- Wood, C. C. 1995. Life history variation and population structure in sockeye salmon. *Am. Fish. Soc. Symp.* 17: 195-216.
- Wood, C. C., and C. J. Foote. 1996. Evidence for sympatric genetic divergence of anadromous and non-anadromous morphs of sockeye salmon (*Oncorhynchus nerka*). *Evolution* 50: 1265-1279.
- Wood, C. C., B. E. Riddell, D. T. Rutherford, and R. E. Withler. 1994. Biochemical genetic survey of sockeye salmon (*Oncorhynchus nerka*) in Canada. *Can. J. Fish. Aquat. Sci.* 51: 114-131.
- Wright, S. 1931. Evolution in Mendelian populations. *Genetics* 16: 97-159.
- Wright, S. 1938. Size of population and breeding structure in relation to evolution. *Science* 87: 430-431.
- Wright, S. 1946. Isolation by distance under diverse mating systems. *Genetics* 31: 39-59.
- Wright, S. 1977. Evolution and the genetics of populations. Volume 3. Experimental results and evolutionary deductions. University of Chicago Press, Chicago, IL.
- Yamauchi, A., and Y. Matsumiya. 1997. Population dynamics and fishery policy for migratory resources with two migration paths. *Can. J. Fish. Aquat. Sci.* 54: 2303-2313.
- Zeng, Z., R. M. Moweirski, M. L. Taper, B. Dennis, and W. P. Kemp. 1998. Complex population dynamics in the real world: Modeling the influence of time-varying parameters and time lags. *Ecology* 79: 2193-2209.

Zinn, J. L., K. A. Johnson, J. E. Sander, and J. L. Fryer. 1977. Susceptibility of salmonid species and hatchery stocks of chinook salmon (*Oncorhynchus tshawytscha*) to infections by *Ceratomyxa shasta*. J. Fish. Res. Board Can. 34: 933-936.

Recent NOAA Technical Memorandums NMFS
published by the
Northwest Fisheries Science Center

NOAA Tech. Memo.
NMFS-NWFSC-

- 41 **Flagg, T.A., B.A. Berejikian, J.E. Colt, W.W. Dickhoff, L.W. Harrell, D.J. Maynard, C.E. Nash, M.E. Strom, R.N. Iwamoto, and C.V.W. Mahnken. 2000.** Ecological and behavioral impacts of artificial production strategies on the abundance of wild salmon populations. A Review of practices in the Pacific Northwest. 92 p. NTIS number pending.
- 40 **McCain, B.B., D.W. Brown, S.-L. Chan, J.T. Landahl, W.D. MacLeod, Jr., M.M. Krahn, C.A. Sloan, K.L. Tilbury, S.M. Pierce, D.G. Burrows, and U. Varanasi. 2000.** National benthic surveillance project: Pacific Coast. Organic chemical contaminants, cycles i to vii (1984-90). 121 p. NTIS number pending.
- 39 **Hinton, S.A. and R.L. Emmett. 2000.** Biological surveys of the Trestle Bay enhancement project, 1994, 1996-97. 72 p. NTIS PB2000-103344.
- 38 **Flagg, T.A. and C.E. Nash (editors). 1999.** A conceptual framework for conservation hatchery strategies for Pacific salmonids. 48 p. NTIS PB99-170003.
- 37 **Johnson, O.W., M.H. Ruckelshaus, W.S. Grant, F.W. Waknitz, A.M. Garrett, G.J. Bryant, K. Neely, and J.J. Hard. 1999.** Status review of coastal cutthroat trout from Washington, Oregon, and California. 292 p. NTIS PB99-140469.
- 36 **Collier, T.K., L.L. Johnson, M.S. Myers, C.M. Stehr, M.M. Krahn, and J.E. Stein. 1998.** Fish Injury in the Hylebos Waterway of Commencement Bay, Washington. 576 p. NTIS PB98-137581.
- 35 **Myers, J.M., R.G. Kope, G.J. Bryant, D. Teel, L.J. Lierheimer, T.C. Wainwright, W.S. Grant, F.W. Waknitz, K. Neely, S.T. Lindley, and R.S. Waples. 1998.** Status review of chinook salmon from Washington, Idaho, Oregon, and California. 443 p. NTIS PB98-128473.
- 34 **Genovese, P.V., and R.L. Emmett. 1997.** Desktop geographic information system for salmonid resources in the Columbia River basin. 32 p. NTIS PB98-118383.
- 33 **Gustafson, R.G., T.C. Wainwright, G.A. Winans, F.W. Waknitz, L.T. Parker, and R.S. Waples. 1997.** Status review of sockeye salmon from Washington and Oregon. 282 p. NTIS PB98-128861.
- 32 **Johnson, O.W., W.S. Grant, R.G. Kope, K. Neely, F.W. Waknitz, and R.S. Waples. 1997.** Status review of chum salmon from Washington, Oregon, and California. 280 p. NTIS PB98-128663
- 31 **Sampson, D.B., and P.R. Crone (editors). 1997.** Commercial fisheries data collection procedures for U.S. Pacific coast groundfish. 189 p. NTIS number pending.

Most NOAA Technical Memorandums NMFS-NWFSC are available on-line at the
Northwest Fisheries Science Center web site (<http://www.nwfsc.noaa.gov>).