

## Two threatened Caribbean coral species have contrasting responses to combined temperature and acidification stress

Chris Langdon <sup>1\*</sup>, Rebecca Albright,<sup>2</sup> Andrew C. Baker,<sup>1</sup> Paul Jones<sup>3</sup>

<sup>1</sup>Department of Marine Biology and Ecology, Rosenstiel School of Marine and Atmospheric Science, University of Miami, Miami, Florida

<sup>2</sup>Institute for Biodiversity Science & Sustainability, California Academy of Sciences, San Francisco, California

<sup>3</sup>CIMAS/Rosenstiel School of Marine and Atmospheric Science, University of Miami, Miami, Florida

### Abstract

There is growing evidence that different coral species and algal symbionts (*Symbiodinium* spp.) can vary greatly in their response to rising temperatures and also ocean acidification. In a fully crossed factorial experimental design, two threatened Caribbean reef-building coral species, *Acropora cervicornis* hosting a mixture of *Symbiodinium* clades A and C and *Orbicella faveolata* hosting *Symbiodinium* D, were exposed to combinations of a normal (26°C) and elevated (32°C) temperature and normal (380 ppm) and elevated (800 ppm) CO<sub>2</sub> for 62 d and then recovered at 26°C and 380 ppm or 32°C and 380 ppm for an additional 56 d. CO<sub>2</sub> enrichment did not confer enhanced thermal tolerance as had been suggested in other studies. *A. cervicornis* was more sensitive to heat stress (maximum monthly mean +1.5°C) experiencing 100% mortality after 25 d while all *O. faveolata* survived. Conversely, *O. faveolata* was more sensitive to high CO<sub>2</sub> experiencing a 47% reduction in growth while *A. cervicornis* experienced no significant reduction. It is predicted that *A. cervicornis* is unlikely to survive past 2035. *O. faveolata* with D symbionts might survive to 2060 and later but its abundance will be impacted by CO<sub>2</sub> effects on recruitment potential.

Global warming and ocean acidification (OA) are widely recognized as key threats to the long-term survival of coral reefs. Rapidly warming oceans are resulting in more frequent and severe mass bleaching events (Hughes et al. 2017), while the uptake of CO<sub>2</sub> by the surface ocean is driving down the pH making it more difficult for corals and other organisms to build their skeleton and shells (Doney et al. 2009). High levels of atmospheric CO<sub>2</sub> have been related to several mass extinction events of corals and other marine calcifiers over the past 300 million years (Veron 2008; Hönisch et al. 2012). Although similarities with past events exist in terms of the magnitude of the change in ocean chemistry, the changes projected for the next several hundred years are unparalleled in the rate of the change (Hönisch et al. 2012). To survive, corals will have to acclimatize and/or adapt more quickly than they ever have before.

Several studies have made projections about how coral reefs will fare in the face of global warming. Donner (2009) predicted that by 2030, >80% of coral reefs could begin experiencing harmfully frequent bleaching events ( $p > 0.2$  per year) assuming the A1F1 business as usual CO<sub>2</sub> emission

scenario. A more recent analysis by van Hooidonk et al. (2013) utilizing the latest projections from the IPCC 5<sup>th</sup> Assessment Report (AR5) predicted that the majority of reefs could begin to bleach annually by 2040–2060 depending on emission scenario. Donner (2009) showed that if corals are capable of +1.5°C of thermal adaptation they could push that tipping point back by 50–80 yr.

Hoegh-Guldberg et al. (2007) was the first to explicitly include OA in projections of how corals will fare in the future. Assuming that coral reef net accretion requires an aragonite saturation state of  $\geq 3.3$ , based on where reefs are found today (Kleypas et al. 1999), they predicted that coral reefs would begin to fail when atmospheric CO<sub>2</sub> exceeded 500 ppm. Pandolfi et al. (2011) pointed out that, although lab, mesocosm, and field studies indicate that the impact of acidification is consistently negative (Kroeker et al. 2010), the relationship with saturation state is highly variable and often nonlinear. Sensitivity to decreases in pH seems to be reduced when corals are given weeks, rather than days, to acclimate (Marubini et al. 2001; Reynaud et al. 2003; Ries et al. 2009) when they have abundant food (Ries et al. 2009; Edmunds 2011; Towle et al. 2015), or are supplied with high levels of inorganic nutrients (Langdon and Atkinson 2005; Ezzat et al. 2016). This broad range of variability in sensitivity

\*Correspondence: clangdon@rsmas.miami.edu

to pH may partly be explained by differences in experimental methodology, but it is likely that there are real differences between species. Some species may be more OA-hardy than others, either highly efficient calcifiers or able to direct more energy to calcification. Given the right environmental conditions, such as abundant supply of food or high concentrations of inorganic nutrients, some corals may be able to divert excess energy to calcification and partially offset the impact of high CO<sub>2</sub>. Learning the energetic cost of calcification may be key to predicting the response of corals to future OA. Energetically replete corals may be relatively insensitive to OA while energetically depleted corals such as those that are bleached or partially bleached may display a heightened sensitivity to OA.

Both bleaching due to warming and decreased calcification due to acidification are stress responses of the coral-algal holobiont. It is reasonable to expect that the stress response to one will affect the response to the other stressor. One such interaction was suggested above, i.e., that a partially or wholly bleached coral that has lost some or all the photosynthetic product from its algal symbionts (*Symbiodinium* spp.) may be less able to devote energy from reserves or from heterotrophy to calcification and hence may exhibit a heightened sensitivity to OA as the upper temperature limit is approached. In addition, some studies that modulate the CO<sub>2</sub> enrichment technique to simulate the natural way ocean carbonate chemistry is being perturbed are finding that elevated CO<sub>2</sub> can cause a bleaching-like response in corals at temperatures not normally associated with thermal bleaching. These observations include decreased symbiont density and decreased net photosynthesis on both a per unit area of coral tissue basis and a per symbiont cell basis in corals exposed to natural light levels (700–1200 μmol m<sup>-2</sup> s<sup>-1</sup> noon max) and temperatures of 26–29°C for 4–8 weeks (Anthony et al. 2008; Kaniewska et al. 2012). The fact that two earlier studies failed to observe a CO<sub>2</sub> mediated bleaching response may be explained by the much lower light levels employed in those studies (150–350 μmol m<sup>-2</sup> s<sup>-1</sup> of artificial light) (Reynaud et al. 2003; Schneider and Erez 2006; Crawley et al. 2009). The studies by Schneider and Erez (2006) and Crawley et al. (2009) were also of short duration (< 4 d). Exposure to natural high light levels for many weeks may be needed for the buildup of physiological stress caused by the elevated CO<sub>2</sub> to be observed. Bleaching caused by acidification raises the possibility that corals exposed to elevated CO<sub>2</sub> might either bleach at a lower temperature, or bleach at the same temperature but after a shorter period of thermal stress, compared to corals exposed to only elevated temperature.

The response of corals and their algal symbionts to changes in the inorganic carbon species depends on how those changes are produced. Over timescales of 1 week, studies have shown that doubling the bicarbonate concentration has a positive effect on the rate of photosynthesis (per unit

chlorophyll) and this dominates the effects of pH (Weis 1993; Marubini et al. 2008). However, under future climate scenarios, the predicted increase in dissolved CO<sub>2</sub> will be balanced by equivalent decreases in carbonate ion concentrations and only very slight increases in bicarbonate concentrations (Caldeira and Wickett 2003; Raven et al. ). Under these conditions, a CO<sub>2</sub>-fertilization effect is only expected if the symbionts are limited by present day CO<sub>2</sub> concentration. *Symbiodinium* spp. are known to possess a carbon-concentrating mechanism (CCM) to increase the concentration of CO<sub>2</sub> available to Rubisco and suppress the competing oxygenation pathway (Leggat et al. 1999). However, CCMs differ in their design and efficiency between algal species (Giordano et al. 2005); thus, it is conceivable that some *Symbiodinium* phylotypes possess less efficient CCMs (relying to a greater extent on the passive, diffusive uptake of CO<sub>2</sub> than others). Brading et al. (2011) investigated the effect of doubling pCO<sub>2</sub> on four free-living phylotypes of *Symbiodinium* and found that A1 and B1 were unaffected but the photosynthesis of A2 and the growth of A13 were enhanced by 60%. The conclusion was that corals hosting these phylotypes might perform better under OA conditions.

Here, we investigated the effects of extended exposure to elevated temperature (32°C) and CO<sub>2</sub> (800 ppm), both alone and in combination, on the growth and photochemistry of two threatened species of reef-building Caribbean coral, *Orbicella faveolata* and *Acropora cervicornis*. Following 9 weeks of these treatment conditions, the recovery of the corals at 26°C/380 ppm and 32°C/380 ppm was also monitored. We believe that this is the first study to quantify CO<sub>2</sub> response in terms of linear extension (LE) and the ability of corals to recover LE following removal of heat stress and/or acidification stress, valuable to understanding how such conditions will affect corals in coming decades and how they are recorded in coral skeletons.

## Materials and methods

### Environmental context

It is important to place the temperature and CO<sub>2</sub> treatment levels chosen for this experiment in the context of the conditions the corals are experiencing in the field. Figure 1A shows a composite annual temperature record for the Florida Reef Tract (FRT). Hourly temperature data from NOAA C-MAN stations spanning the FRT (Fowey Rocks, Molasses, Sand Key, and Sombrero) for the years 1988–2016 were binned and averaged by year-day. The annual average temperature varies from year to year between 25.9°C and 26.9°C. Seasonally, temperature swings between 23.0°C and 30.2°C. The warmest month of the year is August and the maximum monthly mean (MMM) for the period 1988–2016 was 30.5°C.

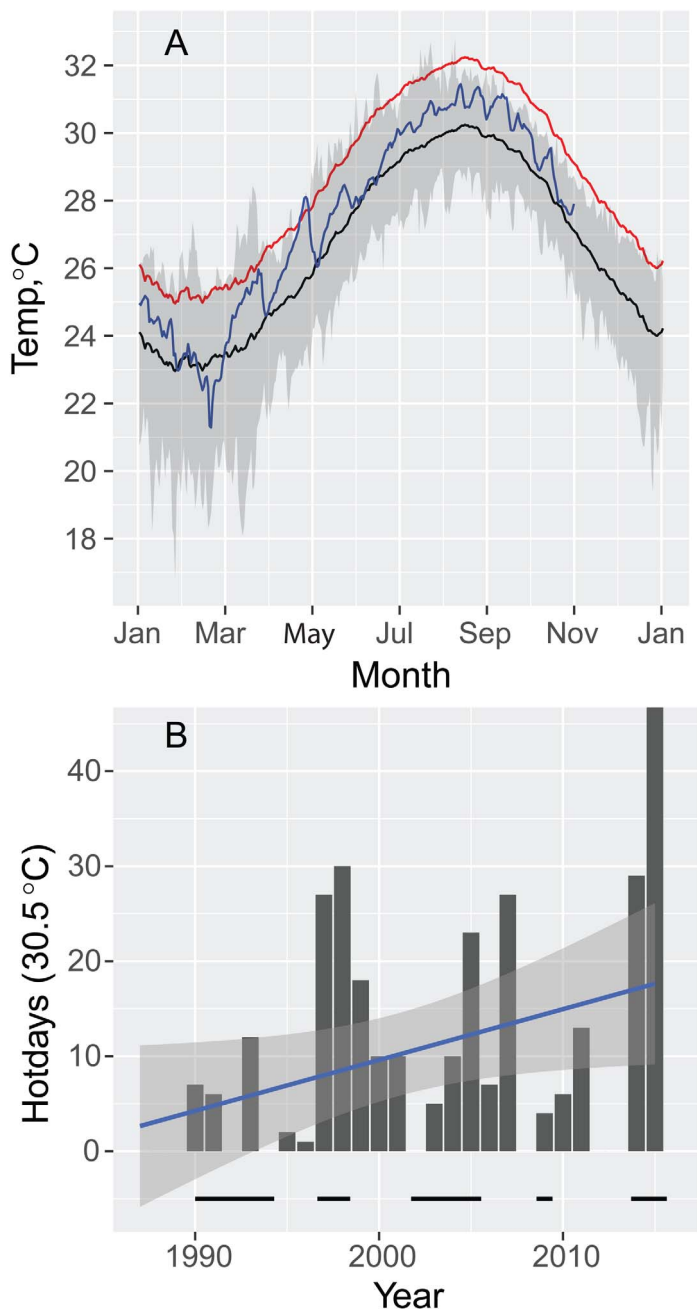
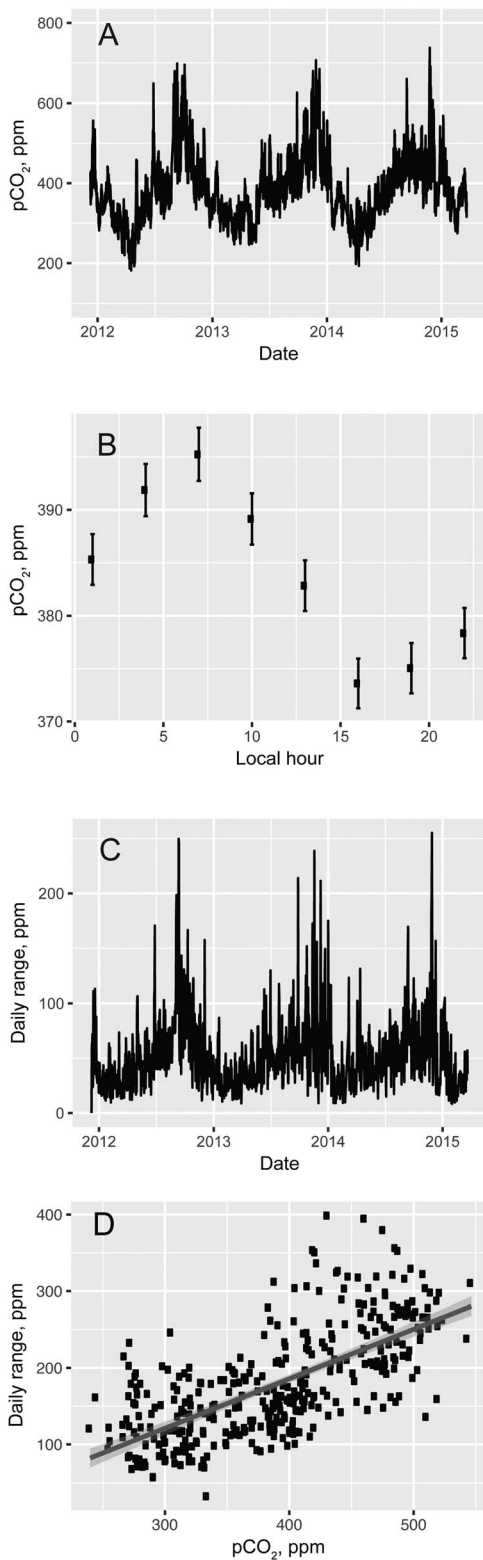

**Fig. 1.** (A) Composite annual temperature cycle for the years 1988–2015 based on instrumental temperature data from NOAA C-MAN stations spanning the FRT (Fowey Rocks, Molasses Reef, Sand Key, and Sombrero Reef). Black line shows the daily mean by year day and the gray band the daily minimum (3<sup>rd</sup> percentile) and maximum (97<sup>th</sup> percentile). Blue line shows the annual temperature cycle in 2015 averaged across the FRT. Red line shows the annual cycle in the year 2100 if temperatures warm by +2°C. (B) Number of consecutive days in a year that mean daily temperature is  $\geq 30.5^{\circ}\text{C}$ . Solid horizontal lines denote years of strong El Niño (Multi-Environmental Index  $> 0.3$ ). Blue line shows best-fit linear regression line ( $y = -1060 + 0.54 * \text{Year}$ ,  $r^2 = 0.14$ ,  $p = 0.044$ ) and the gray band shows the 95% confidence interval (CI).

Studies have shown that coral populations are highly adapted to the prevailing local and regional thermal regime and that the threshold for coral bleaching is 1–3°C above the regional MMM (Howells et al. 2011, 2013). A temperature anomaly of  $\sim 1^{\circ}\text{C}$  above the MMM is a frequently used threshold for severe bleaching (Gleeson and Strong 1995). However, Manzello et al. (2007) found that the threshold for severe bleaching on the FRT was better estimated as  $\text{MMM} + 0.6^{\circ}\text{C}$  suggesting that Florida corals might be a little more prone to bleaching than corals in other regions. They also reported that the simple to compute index,  $\text{days} \geq 30.5^{\circ}\text{C}$ , had similar predictive power to MMM for predicting severe bleaching events on the FRT. Figure 1B shows the cumulative heat stress defined as  $\text{days} \geq 30.5^{\circ}\text{C}$  computed from the pooled FRT data set described above. Years with high cumulative heat stress tend to coincide with strong El Niño years (Multivariate ENSO Index  $\geq 0.3$ ). Regression analysis found that summer-time heat stress has been increasing over the years 2000–2015 by  $0.54 \pm 0.25$  (SE) days per year ( $R^2 = 0.14$ ,  $F_{1,27} = 4.46$ ,  $p = 0.044$ ). Manzello (2015) made the prediction that based on measured rates of warming on the FRT severe bleaching events ( $\text{MMM} > 0.6^{\circ}\text{C}$ ) could become an annual occurrence sometime between 2020 and 2034. In the present study, we chose our high temperature treatment to be  $32.0^{\circ}\text{C}$ , equivalent to a summer-time maximum temperature anomaly of  $+1.5^{\circ}\text{C}$ , well within the range of projected end of century warming of  $1.4\text{--}5.8^{\circ}\text{C}$  (IPCC).

Compared to temperature much less is known about the variability in  $\text{CO}_2$  concentrations that corals experience at present. A NOAA Ocean Acidification Buoy has been collecting  $\text{pCO}_2$  data at a patch reef in the middle Keys since December 2011 (Sutton et al. ). Figure 2 shows the variability in  $\text{pCO}_2$  that corals on the FRT are experiencing on seasonal, daily, and hourly time scales. From 2012–2015, seawater  $\text{pCO}_2$  averaged  $395 \pm 86$  ppm (mean  $\pm$  SD) (Fig. 2A), close to the atmospheric mean concentration of  $394 \pm 7$ . Seasonally, seawater  $\text{pCO}_2$  goes through a low of 200–240 ppm in early April and a maximum of 600–700 ppm in late November/early December. This is a result of net reef autotrophy during the early months of the year, changing to net heterotrophy during later months (Muehllehner et al. 2016). Data were binned and averaged by time of day to create a figure of the diel cycle of  $\text{pCO}_2$  averaged over the  $\sim 3.5$  yr of data (Fig. 2B).  $\text{pCO}_2$  reaches a maximum near dawn and a minimum in the late afternoon. The amplitude of the dawn to dusk swing averages 25 ppm. This diel cycle is the result of net photosynthesis during the day and respiration at night and like the seasonal cycle in Fig. 2A is clear evidence that biological processes are driving much of the observed variability in  $\text{pCO}_2$ . Figure 2C shows the daily range in  $\text{pCO}_2$  defined as the difference between the maximum and minimum in each 24 h period. The variability ranges from 15 ppm to 300 ppm and that there is clear seasonality with the low variability from January to May and high variability from June to December.

A regression of daily range against daily average  $p\text{CO}_2$  found that there was a significant correlation ( $y = -72.96 + 0.64 p\text{CO}_2$ ,  $R^2 = 0.45$ ,  $p < 0.00001$ ) (Fig. 2D).



**Fig. 2.**

As seawater takes up  $\text{CO}_2$  with little change in total alkalinity (TA), the buffering capacity decreases (Egleston et al. 2010). This means that processes that alter dissolved inorganic carbon (DIC) and total alkalinity (TA) concentrations (photosynthesis, respiration, calcification, dissolution) will have bigger impacts on  $p\text{CO}_2$ , pH, and  $\Omega_{\text{ar}}$  as OA progresses. For example, if  $p\text{CO}_2$  reaches  $3\times$  preindustrial, diurnal, and seasonal variations in  $p\text{CO}_2$ , pH and  $\Omega_{\text{ar}}$  caused by photosynthesis and respiration would be increased by 40–60%. This means that, as the ocean acidifies over coming decades, corals will not only experience a higher mean  $\text{CO}_2$  concentration but will also significantly greater  $\text{CO}_2$  variability on daily and seasonal time scales. This could mean that pH low enough to cause dissolution could start to be observed during the night and during the fall and winter months many decades before current projections are forecasting.

Taking all of this into account, we chose our  $p\text{CO}_2$  levels to simulate the present day and  $3\times$  preindustrial conditions, i.e., 400 ppm and 840 ppm. Note that the IPCC business as usual scenario (RCP8.5) assumes unchecked  $\text{CO}_2$  emissions and projects that  $\text{CO}_2$  will reach 900 ppm by the year 2100 (IPCC). We also designed our experimental setup to simulate the natural diel swing in carbonate chemistry including that the amplitudes should be larger in the high  $\text{CO}_2$  treatments.

#### Coral collection and preparation

Colonies of *O. faveolata* were obtained in May 2007 from a sea wall at Truman Harbor, Key West, Florida (Permit FKNMS 2007-028). Until the time of the experiment in 2009, they were maintained in outdoor tanks supplied with running seawater from nearby Bear Cut, Biscayne Bay, Florida. Colonies of *A. cervicornis* were obtained from the Smithsonian Lab in Fort Pierce, Florida. These corals had been kept in a large public display aquarium for many years. The original colonies were collected from Dania Beach, Broward County (W. Hoffman pers. comm.). Microcolonies of *O. faveolata* were prepared from eight different parent colonies, each presumed to represent a different genotype because they came from different locations on the sea wall and must have originally recruited to the vertical seawall (built in the early 1950s) as a result of sexual reproduction. Microcolonies were prepared using a 2.5 cm diameter coring drill and glued to squares of 0.5" thick PVC to facilitate handling and the measurement of vertical extension. Microcolonies ( $N = 9$ ) from each parent were distributed haphazardly but evenly between the eight treatment tanks. Small branches ( $N = 9$ ) of

**Fig. 2.** (A) Time series of  $p\text{CO}_2$  at Cheeca Rocks Reef, Islamorada, Florida based on data collected by NOAA MAPCO2 Buoy (Sutton et al. 2016). (B) Composite diel cycle of  $p\text{CO}_2$  vs. local hour. Error bars are SE. (C) Time series of the daily range (maximum–minimum) of  $p\text{CO}_2$ . (D) Relationship between the daily range and daily mean  $p\text{CO}_2$ . Blue line shows best-fit linear regression line ( $y = -73.0 + 0.65p\text{CO}_2$ ,  $r^2 = 0.45$ ,  $p < 0.00001$ ) and the gray band shows the 95% confidence interval (CI).

*A. cervicornis*, each ~ 3 cm long, bearing a single apical polyp, were snipped from eight different parent colonies, and epoxied to small squares of PVC. In the case of the *A. cervicornis*, no assumptions were made regarding genotype because the colonies used in the experiment were themselves the result of repeated propagation by fragmentation in the aquaria at the Smithsonian lab over several years. Regardless, parent colony was not tracked through the experiment in either species, which was unfortunate because subsequent studies have found significant genotypic variability in growth rate and bleaching susceptibility in these species (Drury et al. 2017; Towle et al. 2017). However, at the time of this study, genotyping services for these species were not readily available.

### Experimental set-up

The Corals and Climate Change Laboratory at the University of Miami consists of 12 fiberglass tanks (50 cm × 60 cm) each containing 48 L of seawater, located in an outdoor structure covered by a 60.2-mm sheet of polypropylene plastic and a layer of shade cloth so that the tanks are exposed to attenuated natural sunlight but protected from the wind and rain. Each tank is provided a continuous supply of high quality natural seawater from a pumping system that draws from an inlet located in nearby Bear Cut, Biscayne Bay, Florida. Nutrient concentrations at the intakes to the RSMAS seawater system averaged 0.9 μM NO<sub>3</sub>, 0.3 μM NH<sub>4</sub>, and 0.03 μM PO<sub>4</sub>. These compare to mean concentrations of 0.12 μM NO<sub>3</sub>, 0.2 μM NH<sub>4</sub>, and 0.02 μM PO<sub>4</sub> on the FRT (SERC-FIU Water Quality Monitoring Network). Given that the dissolved inorganic nitrogen (DIN) : P of the intake water is 46 : 1 (i.e., strongly P-limited), it is unlikely that the elevated NO<sub>3</sub> of the intake water has any impact on the photosynthesis or growth of the corals in this experiment. The seawater was supplied to the aquaria from a header tank at a constant rate of 30 mL min<sup>-1</sup>. This rate was determined to exceed the daily rate of evaporation and demand for DIC and TA by corals by a sufficient margin to maintain the salinity and carbonate chemistry at levels comparable to the source water.

A schematic of the systems used to control the temperature and CO<sub>2</sub> in the experimental tanks is shown in Fig. 3. Each experimental tank was connected to a 200-L sump tank. A submersible 500-GPH pump circulated the water between the sump and the experimental tank every 8.5 min. The sump tanks contained a heat exchanging coil of 30' of 1" plastic irrigation tubing and a 1.5-kW titanium heater. An Omega Instruments CN7833 digital temperature controller determines whether the heater or a solenoid valve is energized. If the solenoid is energized, chilled freshwater at 20°C circulates through the heat exchanging coil. This configuration can hold the daily average temperature of the experimental tanks to within ± 0.1°C. The heat exchanging capacity was intentionally sized so that it does not suppress the

natural diurnal swing in temperature that shallow coral reef water naturally experiences (i.e., ~ 0.3–0.5°C).

The CO<sub>2</sub> control system bubbled the seawater in each of the sump tanks either with outside air or outside air enriched with pure CO<sub>2</sub> gas to a specified level. Mass flow controllers (Sierra Instruments 810C) set the treatment gas concentrations by controlling the mixing ratio of ambient outside air and pure CO<sub>2</sub>. Tanks were bubbled with the gas mixtures using Venturi injectors. The sump tanks were covered, but the experimental tanks were open to exchange gas with the atmosphere. For this reason, it was necessary to empirically adjust the composition of the CO<sub>2</sub> enriched—air mixture until the desired CO<sub>2</sub> level in the experimental tanks was achieved. After this adjustment, the CO<sub>2</sub> concentrations in the experimental tanks were checked weekly by moving the equilibrator from tank to tank. Experience has shown that this arrangement yields daily average CO<sub>2</sub> levels that are stable day-to-day to within ± 50 ppm. Like the temperature control system, this arrangement permitted the CO<sub>2</sub> level in the tanks to undergo a natural diurnal cycle, the phasing and amplitude of which is like what is experienced in natural coral reef environments. Diel variability in pCO<sub>2</sub> levels varied by 97 ppm in the control tanks and 308 ppm in the high CO<sub>2</sub> tanks, within the range that they experience in the field (Fig. 2C).

A Hobo U30 data acquisition system (Onset Computer) logged light and temperatures for each tank every 5 min. Light averaged 3.7 ± 0.2 mol quanta m<sup>-2</sup> d<sup>-1</sup> (*n* = 66) during the experiment (average midday instantaneous irradiance was 327 μmol quanta m<sup>-2</sup> s<sup>-1</sup>). For comparison, corals on a patch reef in the Florida Keys assuming a typical depth of 5 m receive an average 3.8 mol quanta m<sup>-2</sup> d<sup>-1</sup> at the same time of year based on Odyssey PAR logger deployments at Cheeca Rocks reef (C. Langdon unpubl. data). Corals were fed twice a week with Ziegler's Larval Diet AP100 (Aquatic Ecosystems).

### Experimental design

The experiment employed a fully crossed factorial design with two temperatures and two CO<sub>2</sub> levels duplicated with two tanks at each of the four conditions (26°C—390 ppm, 26°C—800 ppm, 32°C—390 ppm, and 32°C—800 ppm) with nine *O. faveolata* and nine *A. cervicornis* microcolonies in each of the eight tanks. The codes LTLC, LTHC, HTLC, and HTHC are used as shorthand for each of the treatments (LT—low temp, HT—high temp, LC—low CO<sub>2</sub>, HC—high CO<sub>2</sub>). Following the treatment phase of the experiment, corals in the high temperature and high CO<sub>2</sub> tanks recovered at control conditions to determine the ability of the two species to recover following a prolonged period of stress. The timing of the experiment is given below.

*Phase 1:* Preconditioning (30 January 2009–11 March 2009) 40 d—Corals were haphazardly distributed among eight of the experimental tanks. There were nine

A

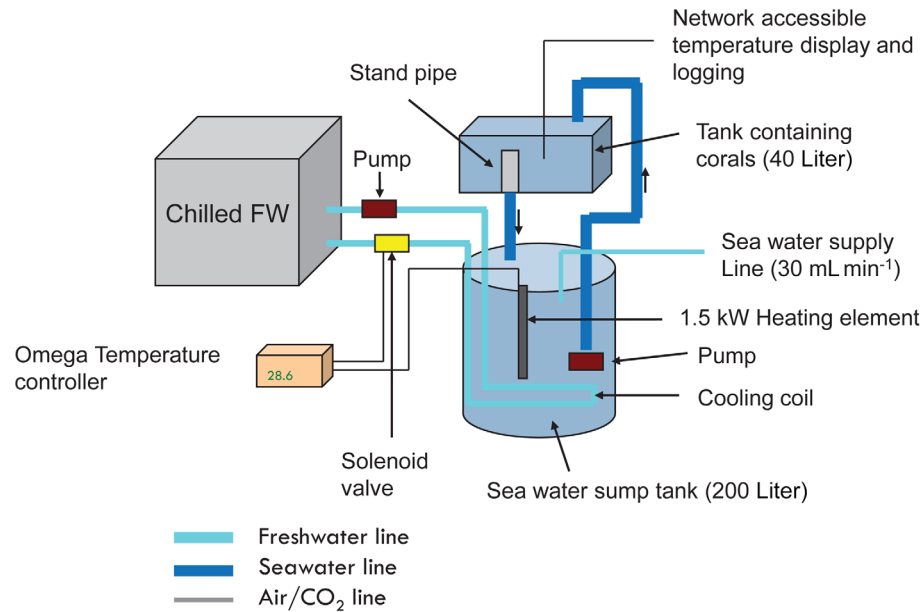

B

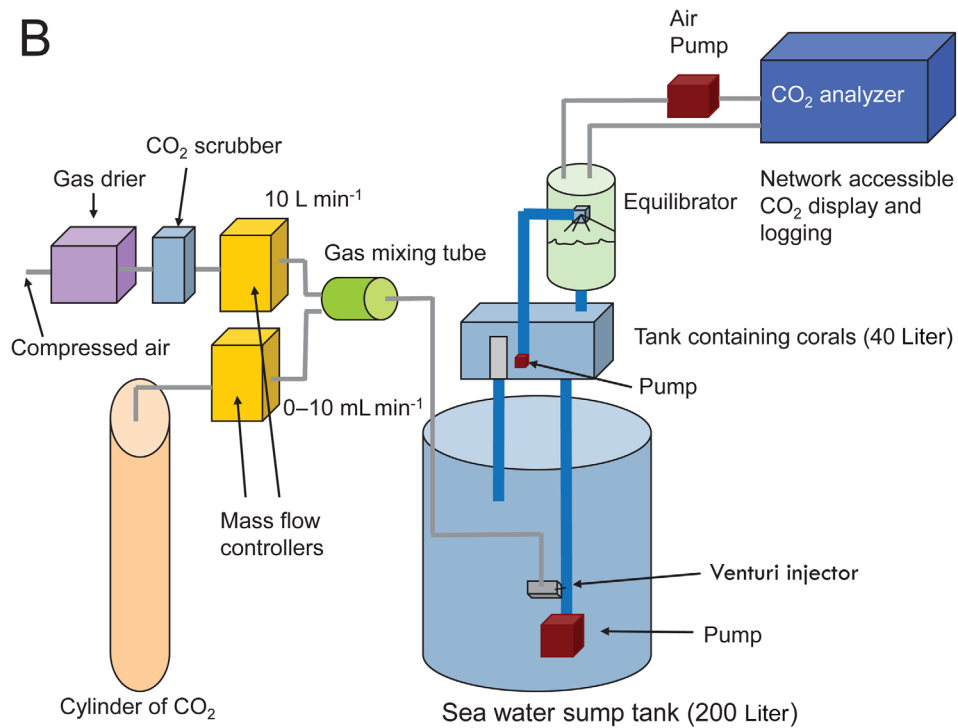

**Fig. 3.** Schematic of tank system. (A) Temperature control. (B) CO<sub>2</sub> control.

microcolonies of each species in each tank. All eight tanks were set to 26.0°C and 380 ppm CO<sub>2</sub>. Skeletal growth was measured weekly.

*Phase 2:* Ramping to treatment conditions (11–19 March 2009)—Temperature and CO<sub>2</sub> in the treatment tanks were

slowly ramped up over an 8-d period. Temperature was increased by 0.75°C per day. Other studies have increased temperature at rates of 0.6°C per day (Schoepf et al. 2015) and 2.0°C per day (Díaz-Almeyda et al. 2017). pCO<sub>2</sub> was ramped up at 50 ppm per day.

**Phase 3:** Treatment (20 March 2009–21 May 2009) 62 d—Tanks 2 and 8 at 26°C—380 ppm, tanks 4 and 7 at 26°C—800 ppm, tanks 3 and 6 at 32°C—390 ppm, and tanks 1 and 5 at 32°C—800 ppm. These conditions were held for 9 weeks. Skeletal growth and photochemistry were measured on all 144 corals weekly.

**Phase 4:** Ramp down (22 May 2009–02 June 2009)—High temperature and high CO<sub>2</sub> conditions were ramped down to control conditions over 8 d.

**Phase 5:** Recovery (03 June 2009–29 July 2009) 56 d—The ability to recover LE after a period of high temperature and/or high CO<sub>2</sub> was tested. Corals that had been in the LTHC treatment were recovered at LTLC to test for the effect of removing CO<sub>2</sub> stress. Corals that had been in the HTLC treatment were recovered at LTLC to test for the effect of removing the high temperature stress. Corals in the HTHC treatment were split with some recovered at LTLC to test for the effect of returning to control conditions and the rest were recovered at HTLC to test for the effect of removing high CO<sub>2</sub> alone.

#### Chemical and physical measurements

Temperature in each of the eight experimental tanks and photosynthetically available radiation was measured and logged every 5 min throughout the experiment using a HOBO 30 data acquisition system. Salinity in each tank was measured weekly using a YSI Model 30 Temperature/Salinity meter that was calibrated prior to each use against a 50.0 mSiemen standard solution. The mole fraction of CO<sub>2</sub> (pCO<sub>2</sub> in ppm) in the tanks was measured using a shower-head style equilibrator coupled with a Licor 820 CO<sub>2</sub> gas analyzer. The partial pressure of CO<sub>2</sub> in units of  $\mu\text{atm}$  was computed using the `x2pco2` function in the `seacarb` package in R. The Licor was calibrated daily against a zero and a 700-ppm span gas using a Valco multiport valve and a microcontroller that at 07:00 h each day would switch the Valco valve from the equilibrator port to the zero-gas port for 5 min followed by 5 min in the span gas position and then return to the equilibrator port position for the remainder of the day. The partial pressure of CO<sub>2</sub> in the equilibrator was logged every 5 min by the HOBO acquisition system. The equilibrator was moved from tank to tank to collect data on the variability in each of the tanks over a 5-d period. Each tank was done in rotation over the course of the experiment. On Wednesday of each week, between 12:00 h and 13:00 h, the equilibrator was moved to each of the eight tanks to collect a snap shot of the midday pCO<sub>2</sub>. Midday was chosen because this is the time of day when the CO<sub>2</sub> level in the tanks crosses the mid-point between the early morning maximum and the late afternoon minimum. Weekly 250 mL water samples were also collected at midday, fixed with 0.2 mL saturated HgCl<sub>2</sub> and TA. TA was measured in duplicate on an automated open-cell Gran titrator (precision 0.2%). The HCl titrant was standardized against certified reference material (Andrew

Dickson Lab, Scripps Institute of Oceanography). The carbonate parameters DIC, pH<sub>T</sub>, and  $\Omega_{\text{ar}}$  were computed from the measured temperature, salinity, pCO<sub>2</sub>, and TA using the R package `seacarb` version 3.2.4 (Gattuso et al. ).

#### Coral growth

Growth was measured as vertical LE of the coral skeleton using an optical micrometer. LE was the focus of this study because it has not previously been shown to be responsive to OA conditions even though the expectation is that if calcification is affected LE should be as well. Showing an OA effect on LE is important because it means that it might be possible to look for skeletal markers of OA stress events in a coral's history by looking for co-occurrences of low LE and low pH based on  $\delta^{11}\text{B}$ . New instrumentation described below was used to make these measurements. A Keyence model 4000 laser displacement micrometer was used to profile the height of the *O. faveolata* colonies and a Keyence model 7000 was used for profiling the height of the *A. cervicornis* colonies. The different model of micrometer was dictated by the differing geometries of the two corals. The calibration of both micrometers was checked against gauge blocks of known height and confirmed to be accurate to within  $\pm 3 \mu\text{m}$ . In both cases, the corals were attached to a mechanical stage driven by a stepper motor that moved the coral past a beam of light at precise 64-micron steps. Each coral was glued to a carefully machined PVC mount. In the base of the mount were two index holes that engaged into stainless steel pins on the mechanical stage of the micrometer. This permitted each coral to be precisely and reproducibly mounted to the stage from week to week. Each coral PVC mount had a precisely machined, flat-topped stainless-steel pin affixed to one end of the mount. Each week when a coral was measured the micrometer was first zeroed on the top of stainless steel pin. This arrangement made it possible to measure coral heights from week to week with a reproducibility of  $\pm 2 \mu\text{m}$ . For *O. faveolata*, the average height of the colony across a central transect of the 2-cm diameter colony was measured each week. For *A. cervicornis*, the highest point of the colony was recorded. Corals were out of the water for no more than 2 min for the colony height measurement. Growth rate, in units of microns of LE per day, was calculated by linear regression of height vs. date and determining the slope of the best-fit line. The first 2 weeks of data following the transition to new conditions was excluded from the analysis because growth was observed to take up to 2 weeks to stabilize under the new conditions.

Before the experiment began, the LE of all corals was measured over a 40-d period. The objective was to collect data to test for a tank effect on growth, however, in the process we found that some corals had LE rates that were very low or even 0 despite otherwise looking healthy. A histogram of LE revealed that 2 out of the 72 *O. faveolata* corals were clear outliers growing at just 0–7% of the median rate (3.9  $\mu\text{m}$

$d^{-1}$ ). Similarly, we found that there was a group of 12 *A. cervicornis* corals that were clear outliers growing at 0–18% of the median rate ( $155 \mu m d^{-1}$ ). The decision was made to exclude these corals from statistical analyses based on the criteria that they fell below the 12th percentile for LE and therefore were performing subpar physiologically and could respond to the temperature and  $CO_2$  treatments in ways that might not be characteristic of healthy individuals of the species, i.e., their inclusion might bias the results. This decision had the following impact on the sample size in each of the treatments (*O. faveolata*: LTLC = 18, LTHC = 18, HTLC = 16, HTHC = 18; *A. cervicornis*: LTLC = 16, LTHC = 13, HTLC = 17, HTHC = 15).

### Photochemical efficiency

To quantify photochemical activity, hereafter referred to as photochemical efficiency (PE), we measured the maximum quantum yield of photosystem II ( $F_v/F_m$ ) with an Imaging-PAM (Walz, Germany) after 60 min of dark acclimation at the end of the light cycle. The Imaging-PAM measured the fluorescence properties and mean  $F_v/F_m$  at five  $0.8 \text{ cm}^2$  areas of interest (AOI) that were haphazardly selected on each coral and measured weekly during the treatment phase of the experiment. The AOIs were located along the central axis of the coral fragment avoiding the apical tip since it contains few symbionts. Corals were out of the water for approximately 1 min.

### Symbiont identification

To identify and quantify the *Symbiodinium* types hosted by the corals, tissue from a single polyp was excavated using the corner of a new razor blade. Tissues were preserved in 1% SDS/DNAB buffer and the DNA extracted using a modified organic extraction protocol (Baker et al. 1997). Extracted DNA was analyzed with quantitative polymerase chain reaction (PCR) (qPCR) assays that specifically quantify *Symbiodinium* clades A, B, C, and D (Cunning and Baker 2013). This was, of necessity, done at the level of clade because primers/probes for different taxa within each clade have not been designed or tested for qPCR. A symbiont clade was considered present in a sample when there was amplification of the target in two technical replicates and no amplification in the no-template controls. The proportion of each clade in a sample was calculated and corals were classified according to the dominant clade (> 90%).

### Statistical analysis

Statistical analyses were completed in R version 3.2.0. Data were checked for normality and homoscedasticity using a Shapiro–Wilkes test and Levene’s test, respectively. All data were assessed for a tank effect (random factor), which was not significant. Two-way, full-factorial ANOVAs were run (temperature  $\times$   $CO_2$ ) for growth (LE) and PE. Alpha for all tests was set at 0.05. Paired *t*-tests were used to analyze the

significance of changes in LE associated with taking corals from stress to recovery conditions.

## Results

### Experimental conditions

Temperature,  $CO_2$ , and other water chemistry parameters are presented in Table 1. The diel periodicity of  $CO_2$  is shown in Fig. 4. The amplitude of daily swing was 100 ppm in the control tanks and 300 ppm in the high  $CO_2$  tanks well within the range of daily variability that corals are experiencing on the FRT today (Fig. 2C,D).

### *Symbiodinium* identification

*O. faveolata* colonies were found to host clade D (> 90%). While we were not able to analyze for subtype, only type D1a (*Symbiodinium trenchii*) has been found in Caribbean corals to date (Pettay et al. 2015). Colonies with this symbiont tolerate temperatures 1–2°C higher than other symbionts but may suffer growth tradeoffs (Cunning et al. 2015; Pettay et al. 2015). *A. cervicornis* colonies were found to host a mixture of clades A and C. We did not identify these symbionts to the subtype level, but A3 is the only A subtype documented in *A. cervicornis* in the Florida Keys to date (first reported by LaJeunesse 2002). The subtypes of C present were not determined. Although considerable physiological variability exists within and among subtypes within clades (Díaz-Almeyda et al. 2017), the A- and C-types found in *A. cervicornis* are generally considered to be thermally sensitive compared to D1a. (Howells et al. 2011; Díaz-Almeyda et al. 2017).

### PE and mortality

Symbiont PE and percentage mortality changed over time in the control and treatment tanks (Fig. 5A,B). PE data for *A. cervicornis* ends on day 24 because all the corals in the high temperature treatments had died by the next sampling date. Two-way ANOVAs were performed on the PE values observed on the last two-time points for each species. There was a significant temperature  $\times$   $CO_2$  interaction for *O. faveolata* (ANOVA,  $F_{1,12} = 5.1$ ,  $p = 0.043$ ) (Table 2; Fig. 6A). A post hoc Tukey HSD test found that high  $CO_2$  had a significant effect at 26°C with PE in the low  $CO_2$  treatment being significantly greater than in the high ( $0.48 \pm 0.01$  vs.  $0.43 \pm 0.01$ ,  $p = 0.046$ ) but not at 32°C ( $0.38 \pm 0.01$  vs.  $0.38 \pm 0.01$ ). There was a significant main effect of temperature with PE at 26°C being significantly greater than at 32°C ( $0.45 \pm 0.01$  vs.  $0.38 \pm 0.01$ ,  $p = 0.000005$ ). Temperature had a significant effect on *A. cervicornis* PE (ANOVA,  $F_{1,12} = 18.2$ ,  $p < 0.001$ ) (Table 2; Fig. 6B). A post hoc test showed that PE at 26°C was significantly greater than at 32°C ( $0.48 \pm 0.03$  vs.  $0.29 \pm 0.03$ ,  $p = 0.011$ ). *O. faveolata* experienced 0% mortality after 62 d at 32°C. All 18 of the *A. cervicornis* corals in the HTLC and HTHC treatments were completely bleached by day 25 and a few days later they all experienced rapid tissue



**Table 1.** Summary of physical and chemical conditions during the preconditioning, treatment, and recovery phases of the experiment.

Stage	Tank	Code	Temp °C	Salinity	$\mu\text{mol kg}^{-1}$		pH	pCO <sub>2</sub> μatm	Ω <sub>ar</sub>
					TA	DIC			
Precondition	All tanks		26	35.9	2432	2076	8.09	369	4.03
				0.5	52	45	0.02	16	0.17
Treatment	2	LTLC	26	36.7	2341	1995	8.08	363	3.83
				0.8	38	26	0.02	13	0.18
	8	LTLC	26	36.2	2385	1995	8.08	368	3.91
				0.9	19	20	0.02	20	0.13
	4	LTHC	26	36.7	2339	2133	7.84	714	2.45
				1.0	28	21	0.02	37	0.12
	7	LTHC	26	36.3	2386	2186	7.82	755	2.43
				1.0	22	26	0.02	41	0.07
	3	HTLC	32	36.9	2382	1977	8.07	366	4.65
				1.1	34	30	0.01	37	0.11
	6	HTLC	32	37.4	2414	1995	8.08	359	4.81
				1.2	26	16	0.01	9	0.14
	1	HTHC	32	36.7	2357	2115	7.81	764	2.92
				0.9	35	24	0.03	42	0.17
5	HTHC	32	36.8	2381	2131	7.83	738	4.81	
			1.1	31	31	0.03	57	0.17	
Recovery	2	LTLC	26	33.6	2361	2030	8.09	365	3.83
				0.7	71	55	0.02	17	0.24
	8	LTLC	26	33.8	2385	2061	8.08	374	3.86
				0.8	8	12	0.00	1	0.00
	4	LTLC	26	33.8	2405	2078	8.07	388	3.80
				0.2	21	27	0.02	25	0.11
	7	LTLC	26	33.9	2370	2034	8.09	362	3.87
				0.8	11	26	0.01	20	0.11
	3	LTLC	26	33.7	2374	2049	8.08	378	3.78
				0.9	56	46	0.01	12	0.14
	6	LTLC	26	34.1	2369	1992	8.06	386	4.47
				0.2	65	57	0.02	30	0.24
	1	HTLC	32	33.7	2390	2000	8.08	368	4.65
				0.6	56	45	0.01	0	0.18
5	HTLC	32	33.9	2373	1986	8.08	368	4.59	
			0.3	28	21	0.00	0	0.09	

Means ± SD.

necrosis (RTN), which resulted in tissue sloughing and death within 24–48 h (i.e., 100% mortality).

#### LE under treatment conditions

There was a significant temperature × CO<sub>2</sub> interaction effect for *O. faveolata* (ANOVA,  $F_{1,63} = 9.6$ ,  $p < 0.003$ ) (Table 2; Fig. 7A). A post hoc comparison test found that high CO<sub>2</sub> had a significant effect at 26°C with LE in the low treatment being significantly greater than in the high ( $4.45 \pm 0.54$  vs.  $2.40 \pm 0.32 \mu\text{m d}^{-1}$ ,  $p = 0.008$ ) but not at 32°C ( $-0.44 \pm 0.29$

vs.  $-0.28 \pm 0.26 \mu\text{m d}^{-1}$ , not significant (NS)). There was a significant main effect of temperature with LE at 26°C being significantly greater than at 32°C ( $3.43 \pm 0.25$  vs.  $-0.36 \pm 0.25$ ,  $p < 0.0001$ ). Temperature had a significant main effect on *A. cervicornis* (ANOVA,  $F_{1,57} = 181.3$ ,  $p < 0.0001$ ) (Table 2; Fig. 7B). A post hoc test showed that LE was significantly faster at 26°C than at 32°C ( $129.0 \pm 7$  vs.  $0 \pm 0$ ,  $p < 0.0001$ ). CO<sub>2</sub> did not have a significant effect at either temperature. Growth ceased in the 32°C treatments after  $14 \pm 2$  (SD) days for *A. cervicornis* and after  $20 \pm 9$  (SD)

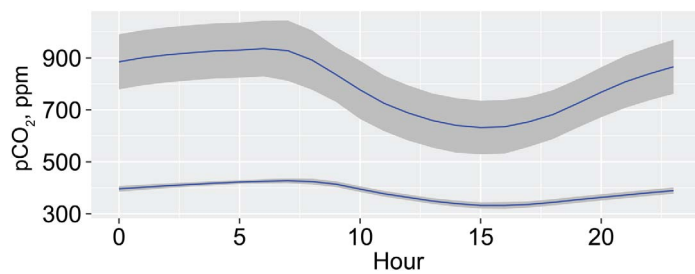

**Fig. 4.** Composite curves showing the diel variability of  $p\text{CO}_2$  in the control and high  $\text{CO}_2$  tanks. The curves were created by binning the 62 d of 5-min data into 24 hourly bins and averaging. The gray bands represent the SD of the hourly means. The variability about the diel curve in the control tanks was very small and just barely visible at the scale shown.

days for *O. faveolata*. The *O. faveolata* corals in the high-temperature treatments were 18–25  $\mu\text{m}$  shorter at the end of the heat stress period accounting for the negative LEs.

#### LE under recovery conditions

The results of the recovery experiment are shown in Fig. 8. Recovery of *O. faveolata* in the LTHC treatment at low  $\text{CO}_2$  significantly increased LE from  $2.41 \pm 0.32 \mu\text{m d}^{-1}$  to  $3.91 \pm 0.35 \mu\text{m d}^{-1}$  [Paired *t*-test,  $T(17) = 5.0$ ,  $p < 0.0001$ ,  $\text{dif} = 1.5 \pm 0.3$ ]. Recovery of *O. faveolata* from the HTLC treatment at low temperature and low  $\text{CO}_2$  significantly increased LE from  $-0.44 \pm 0.29 \mu\text{m d}^{-1}$  to  $4.57 \pm 0.57 \mu\text{m d}^{-1}$  [Paired *t*-test,  $T(11) = 8.5$ ,  $p < 0.000001$ ,  $\text{dif} = 5.2 \pm 0.6$ ]. Recovery of *O. faveolata* from the HTHC treatment at low temperature and low  $\text{CO}_2$  significantly increased LE from  $-0.28 \pm 0.26 \mu\text{m d}^{-1}$  to  $7.30 \pm 0.35 \mu\text{m d}^{-1}$  [Paired *t*-test,  $T(2) = 16.2$ ,  $p = 0.004$ ,  $\text{dif} = 9.4 \pm 0.6$ ]. Recovery of *O. faveolata* from the HTHC treatment at high temperature and low  $\text{CO}_2$  had no significant effect on LE  $-0.28 \pm 0.26 \mu\text{m d}^{-1}$  vs.  $0.29 \pm 0.15 \mu\text{m d}^{-1}$  [Paired *t*-test,  $T(14) = 0.9$ ,  $p = 0.38$ ,  $\text{dif} = 0.21 \pm 0.2$ ]. Recovery of *A. cervicornis* from the LTHC treatment at low  $\text{CO}_2$  had no significant effect on LE [Paired *t*-test,  $T(14) = 0.64$ ,  $p = 0.27$ ] (not shown).

#### Discussion

This study investigated the responses of two Caribbean coral species to elevated temperature and  $\text{CO}_2$ . Specifically, we were interested in the combined effects of these two stressors on the PE and skeletal growth of corals. The former parameter was chosen because it is a sensitive indicator of the bleaching response, and the latter because it is a measure of the process that builds the reef framework. Below we discuss our results and how they fit into the framework of our growing understanding of how corals will respond to climate change.

#### Projected impacts of warming

The threatened Caribbean species *A. cervicornis* and *O. faveolata* differ considerably in their thermotolerance. If

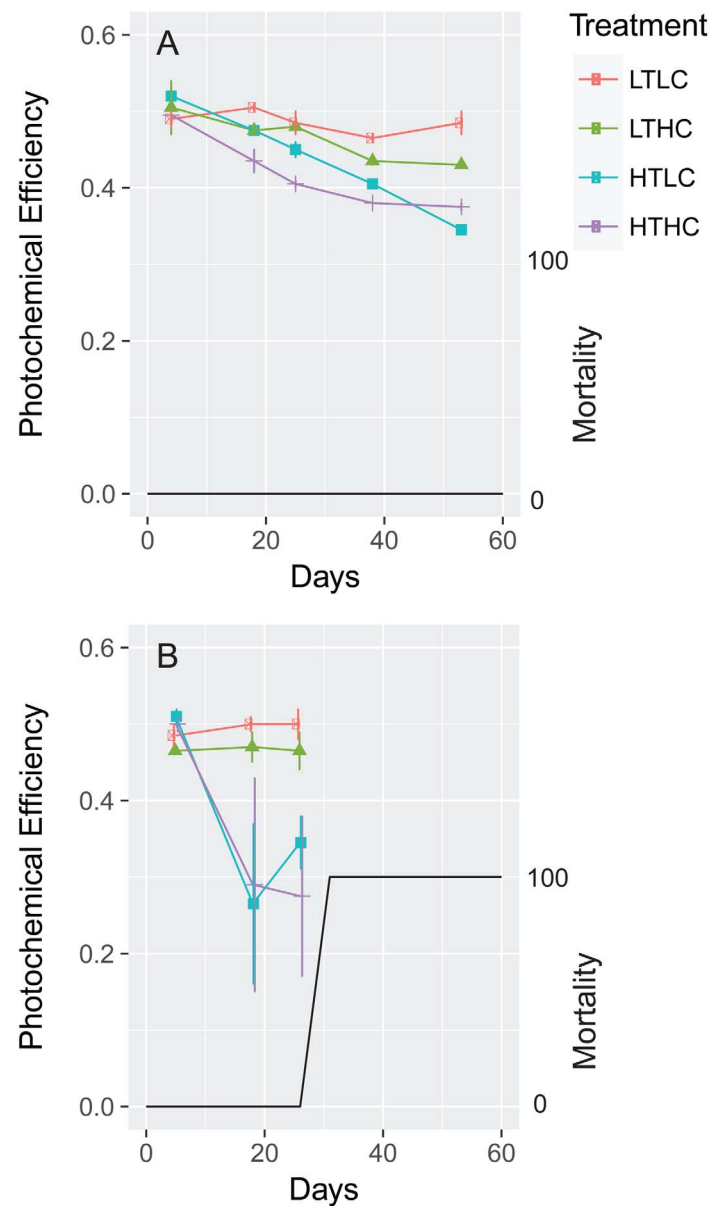
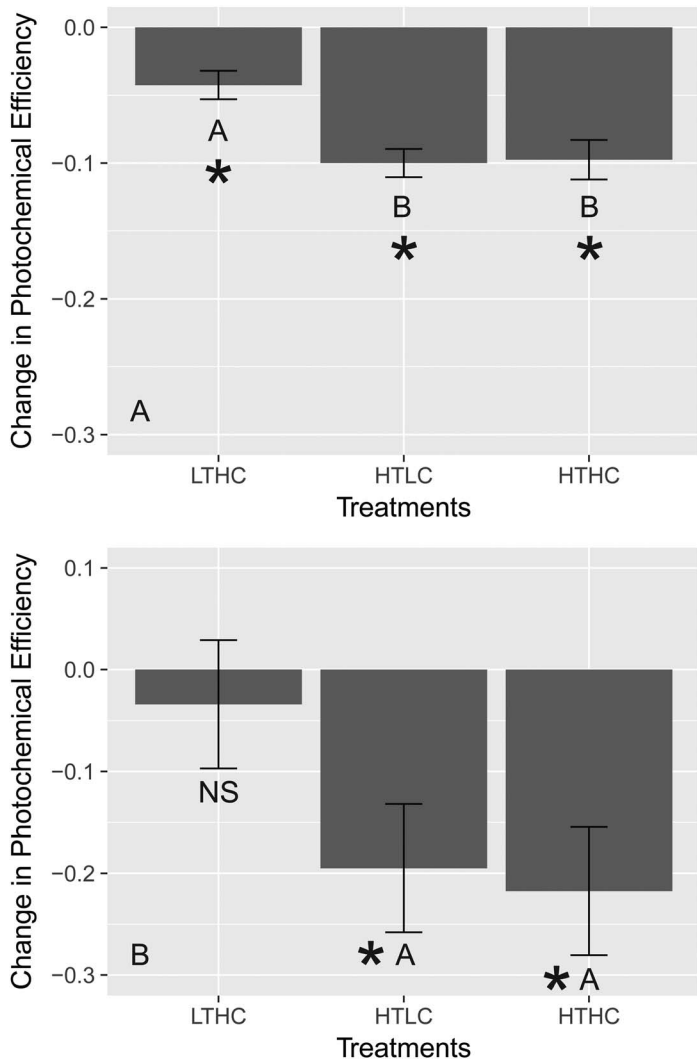
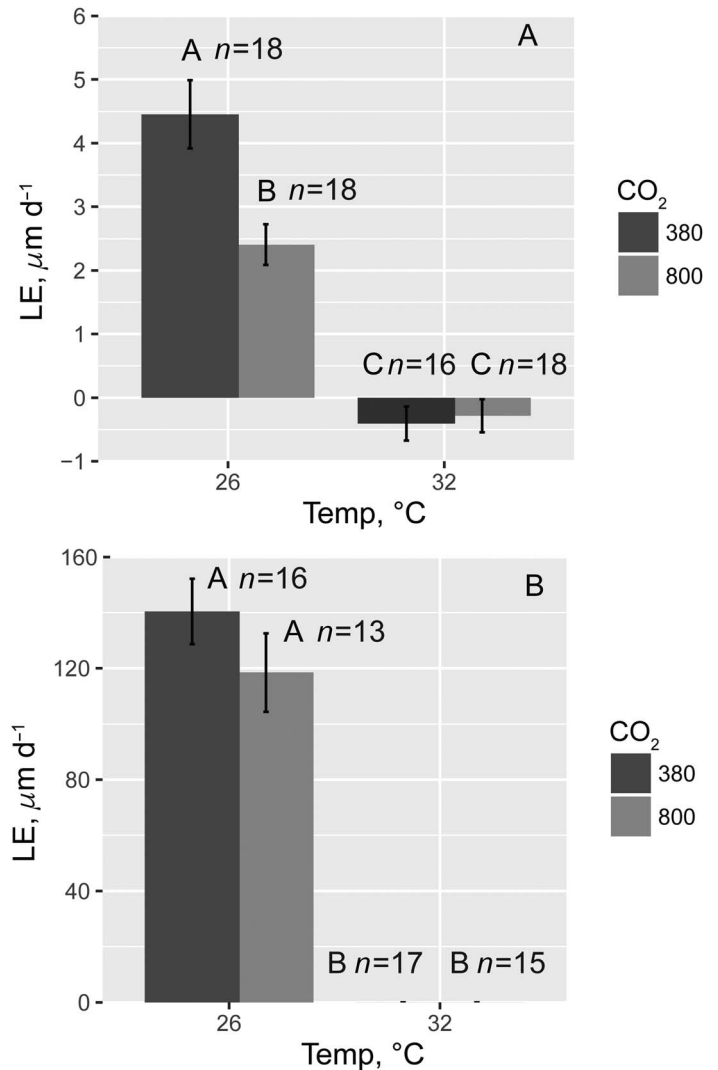

**Fig. 5.** PE as a function of days of treatment conditions; (A) *O. faveolata*; (B) *A. cervicornis*. Error bars are SE. Black lines show the percent mortality in the high-temperature treatments.

temperatures *in vivo* would exceed  $32^\circ\text{C}$  for more than 24 consecutive days, there is a high probability that *A. cervicornis* would experience not just bleaching but also RTN, i.e., tissue sloughing and death within 24–48 h. Schoepf et al. (2015) also observed that a high percentage (75%) of *Acropora* experienced RTN and mortality within 5–6 d of heat stress at  $\text{MMM} + 2^\circ\text{C}$  and suggested that the pathogen *Vibrio* spp. might be involved (Luna et al. 2007). A connection between bleaching and disease in this taxon should be a focus of future studies. Conversely, *O. faveolata* could survive 62 d of exposure to  $32^\circ\text{C}$  and potentially suffer only a hiatus in growth. It is possible that this could increase its

**Table 2.** Results of full factorial two-way ANOVA on dependent variables: growth and photosynthetic efficiency.

Species	Factor	Source	df	F	p	Species	Factor	Source	df	F	p
<i>O. faveolata</i>	Growth	Temp	1	108.3	<0.0001	<i>A. cervicornis</i>	Growth	Temp	1	181.3	<0.0001
		CO <sub>2</sub>	1	6.8	0.011			CO <sub>2</sub>	1	1.5	0.24
		Temp × CO <sub>2</sub>	1	9.6	0.003			Temp × CO <sub>2</sub>	1	1.6	0.204
	Photosynthetic efficiency	Temp	1	60.7	<0.0001		Photosynthetic efficiency	Temp	1	18.2	0.001
		CO <sub>2</sub>	1	4.0	0.067			CO <sub>2</sub>	1	0.4	0.5
		Temp × CO <sub>2</sub>	1	5.1	0.043			Temp × CO <sub>2</sub>	1	0.01	0.91

**Fig. 6.** Effect size of treatments relative to control; (A) *O. faveolata* after 53 d; (B) *A. cervicornis* after 25 d. Asterisks denote effects that were significantly different from the controls,  $p < 0.0001$ . Error bars are SE. Dissimilar letters denote means significantly different from each other ( $p < 0.05$ ).**Fig. 7.** The effect of temperature and CO<sub>2</sub> on growth rate of (A) *O. faveolata* and (B) *A. cervicornis*.  $n$  denotes the number of replicate corals in each treatment. Error bars are SE. Dissimilar letters denote means that were significantly different,  $p < 0.05$ .

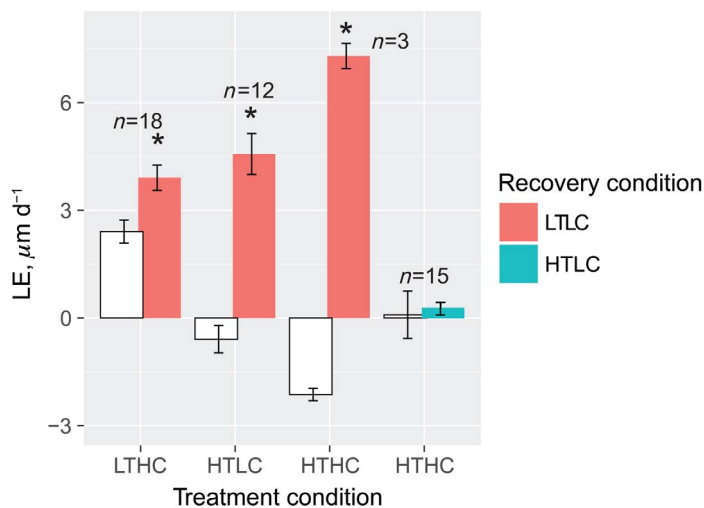

**Fig. 8.** Response of *O. faveolata* during the recovery phase. Asterisks denote corals that exhibited significant recovery based on a paired *t*-test,  $p < 0.00001$ . White bars denote growth under the preceding treatment condition indicated on the *x*-axis. Colored bars denote growth under the recovery condition indicated in the legend. Note that corals in the HTHC treatment were split into a group recovered at control conditions ( $n = 3$ ) and a group that was recovered at HTLC ( $n = 15$ ). Error bars are SE.

susceptibility to disease, but in this study, we followed the corals post-stress for 56 d and did not observe any incidence of disease within that period, even though the *A. cervicornis* that died following bleaching were in the same tanks.

We can use the environmental data analyzed for this study to put the heat stress threat into a historical perspective and to make some projections on how these two species may fare in coming decades if CO<sub>2</sub> emissions continue their present trajectory. Figure 1A shows that days with a mean temperature  $\geq 32^\circ\text{C}$  have been extremely rare on the FRT and for the reef tract composite there were 0 occurrences between 1987 and 2015 (black line). If sea surface temperature warms  $+2^\circ\text{C}$  by the end of century and temperature maintains its historical phasing and seasonal amplitude the annual temperature cycle in 2100 will resemble the red line in Fig. 1A. Adding  $+2^\circ\text{C}$  to the historical temperature data, suggests that 24 consecutive days with a mean temperature  $\geq 32^\circ\text{C}$  may not occur until  $\sim 2100$ . However, this projection needs to be qualified by the fact that warming also has a stochastic component, as shown in Fig. 1B. With a frequency of approximately every 5–7 yr, there are especially warm summers in the Florida Keys that are often correlated with El Niño events in the equatorial Pacific. During the exceptionally warm year of 2015, summer temperatures were  $+0.79^\circ\text{C}$  higher than the historical mean (blue line in Fig. 1A). If we add a climate warming of  $+1.1^\circ\text{C}$  to the 2015 temperature record for the Keys, we reach the severe bleaching/mortality threshold for *A. cervicornis* of 24  $\text{d} \geq 32^\circ\text{C}$ . Consequently, when temperatures reach  $1.1^\circ\text{C}$  above the 1987–

2015 historical mean, there is a high probability of a widespread mortality event for *A. cervicornis* in the Florida Keys. The RCP8.5 emissions scenario predicts a  $+1^\circ\text{C}$  warming by 2035 (IPCC ). Performing a similar exercise for *O. faveolata* we find that a climate warming of  $+1.6^\circ\text{C}$  is needed before a summer exceeding 62  $\text{d} \geq 32^\circ\text{C}$  is likely to occur. This corresponds to the year 2060 on the RCP8.5 temperature increase curve (IPCC ). However, we were not able to stress *O. faveolata* to the point of mortality in this study so the threshold of 62 d at  $32^\circ\text{C}$  is likely conservative. We conclude that there is a chance that *O. faveolata* hosting D1a symbionts might survive warming of  $> +1.6^\circ\text{C}$  and potentially survive to the year 2060 and possibly to the end of the century.

### Projected impacts of OA

By the end of the century, corals are going to be exposed to CO<sub>2</sub> concentrations that are double the present day and triple the pre-industrial concentration that they experienced for  $> 400,000$  yr (Barnola et al. 1999). It has been shown that some phylotypes of *Symbiodinium* (A2 and A13) show a CO<sub>2</sub>-fertilization effect on growth or photosynthesis in the free-living state (Brading et al. 2011). It is not known if they would show the same response when *in-hospite* and if the enhanced photosynthesis would translate into enhanced calcification. It has also been suggested that elevated CO<sub>2</sub> would result in reduced gene expression for the CCM and that in turn could free up energy, N, and Fe for other critical processes (Raven et al. 2011). Another mechanism, proposed by Cunning and Baker (2013) is that increased CO<sub>2</sub> could lead to reduced bleaching susceptibility because it has been shown to reduce symbiont density in corals (Anthony et al. 2008; Kaniewska et al. 2012) and they demonstrated that corals with lower symbiont density were less susceptible to bleaching, possibly because reactive oxygen species (ROS) production was reduced.

In this study, we observed that high CO<sub>2</sub> did not reduce bleaching susceptibility of either species in the high temperature treatments. We did observe a statistically significant reduction in PE of *O. faveolata* at  $26^\circ\text{C}$ . The other large impact of elevated CO<sub>2</sub> in this study was the 47% reduction in LE of *O. faveolata*. Consider the long-term demographic consequences of a 47% reduction of skeletal growth. Mortality of juvenile corals is high as shown by a caging study and declines with increasing colony size (Baria et al. 2010) implying that reduced growth will increase mortality. The slower a coral grows the more years pass before that coral can contribute habitat space to the other fauna on the reef. It also means that there is a greater chance that a coral will die before it has had a chance to reach sexual maturity and pass its genotype on to future generations. Sexual maturity in corals is a function of colony size (Sakai 1998; St. Gelais et al. 2016) so slower growth means a longer generation time. Finally, fecundity is a function of colony surface area (Sakai 1998; St. Gelais et al. 2016) so slower growth means a

life time of reduced egg production for each new coral colony. While corals are not dying as a direct result of elevated CO<sub>2</sub>, the long-term effect is likely to be fewer and smaller corals on the reef producing less structure for the other fauna.

The fact that elevated CO<sub>2</sub> depressed the LE of *O. faveolata* but not *A. cervicornis* is interesting. It has previously been reported that feeding can mitigate the effect of elevated CO<sub>2</sub> on calcification of corals (Edmunds 2011; Towle et al. 2015), presumably by providing a source of additional energy to support increased proton-pumping. However, both species have been shown to be able to exploit heterotrophy (Towle et al. 2015, 2017) and both were well fed in this study. Bedwell-Ivers et al. (2017) may have hit on the answer when they suggested that the mechanism behind the effect of elevated CO<sub>2</sub> on calcification might be linked to a species-specific CO<sub>2</sub>-mediated dysfunction in the photosynthetic machinery of the zooxanthellae. They observed that elevated CO<sub>2</sub> caused reduced photosynthesis and calcification of *Porites divaricata* but had no effect on the photosynthesis or calcification of *A. cervicornis*. In this study, we observed that elevated CO<sub>2</sub> reduced LE and PE of *O. faveolata* and no effect on LE or PE of *A. cervicornis*. This finding is consistent with the hypothesis that a CO<sub>2</sub>-mediated effect on calcification is dependent on an underlying CO<sub>2</sub>-mediated effect on the photosynthetic machinery of the zooxanthellae. The reason behind why elevated CO<sub>2</sub> would disrupt the photosynthetic machinery of the symbionts in some corals and not others remains to be explored but symbiont genotype is an obvious avenue to explore.

## Conclusions

We conclude that, absent genotypic changes (i.e., selection) on either coral hosts or their symbionts, rising temperatures will control the fate of *A. cervicornis*, likely limiting its persistence in the Florida Keys beyond 2035. However, we do not find evidence that temperature will control the fate of *O. faveolata* until 2060 at the earliest and possibly not until the end of the century if warming is limited to +2°C. Instead, we find that CO<sub>2</sub> will control the fate of *O. faveolata* through indirect but well understood effects stemming from reduced skeletal growth (i.e., increased size-dependent mortality of juvenile colonies, increased time to sexual maturity, and reduced fecundity of smaller colonies).

## References

- Anthony, K. R. N., D. I. Kline, G. Diaz-Pulido, S. Dove, and O. Hoegh-Guldberg. 2008. Ocean acidification causes bleaching and productivity loss in coral reef builders. *Proc. Natl. Acad. Sci. USA* **105**: 17442. doi:10.1073/pnas.0804478105
- Baker, A. C., Rowan, R. and Knowlton, N. (1997). Symbiosis ecology of two Caribbean acroporid corals. 8th International Coral Reef Symposium. **2**: 1295–1300.
- Baria, M. V. B., J. R. Guest, A. J. Edwards, P. M. Aliño, A. J. Heyward, and E. D. Gomez. 2010. Caging enhances post-settlement survival of juveniles of the scleractinian coral *Acropora tenuis*. *J. Exp. Mar. Biol. Ecol.* **394**: 149–153. doi:10.1016/j.jembe.2010.08.003
- Barnola, J. M., D. Raynaud, C. Lorius, and N. I. Barkov. 1999. Historical CO<sub>2</sub> record from the Vostok ice core. ORNL.
- Bedwell-Ivers, H. E., M. S. Koch, K. E. Peach, L. Joles, E. Dutra, and C. Manfrino. 2017. The role of in hospite zooxanthellae photophysiology and reef chemistry on elevated pCO<sub>2</sub> effects in two branching Caribbean corals: *Acropora cervicornis* and *Porites divaricata*. *ICES J. Mar. Sci.* **74**: 1103–1112. doi:10.1093/icesjms/fsw026
- Brading, P., M. E. Warner, P. Davey, D. J. Smith, E. P. Achterberg, and D. J. Suggett. 2011. Differential effects of ocean acidification on growth and photosynthesis among phylotypes of *Symbiodinium* (Dinophyceae). *Limnol. Oceanogr.* **56**: 927–938. doi:10.4319/lo.2011.56.3.0927
- Caldeira, K., and M. E. Wickett. 2003. Anthropogenic carbon and ocean pH. *Nature* **425**: 365. doi:10.1038/425365a
- Crawley, A., D. Kline, S. Dunn, K. Anthony, and S. Dove. 2009. The effect of ocean acidification on symbiont photorespiration and productivity in *Acropora formosa*. *Glob. Chang. Biol.* **16**: 851–863. doi:10.1111/j.1365-2486.2009.01943.x
- Cunning, R., and A. C. Baker. 2013. Excess algal symbionts increase the susceptibility of reef corals to bleaching. *Nat. Clim. Chang.* **3**: 259–262. doi:10.1038/nclimate1711
- Cunning, R., P. Gillette, T. Capo, K. Galvez, and A. C. Baker. 2015. Growth tradeoffs associated with thermotolerant symbionts in the coral *Pocillopora damicornis* are lost in warmer oceans. *Coral Reefs* **34**: 155–160. doi:10.1007/s00338-014-1216-4
- Díaz-Almeyda, E. M., and others. 2017. Intraspecific and interspecific variation in thermotolerance and photoacclimation in *Symbiodinium* dinoflagellates. *Proc. R. Soc. B Biol. Sci.* **284**: 20171767. doi:10.1098/rspb.2017.1767
- Doney, S. C., V. Fabry, R. A. Feely, and J. Kleypas. 2009. Ocean acidification: The other CO<sub>2</sub> problem. *Ann. Rev. Mar. Sci.* **1**: 169–192. doi:10.1146/annurev.marine.010908.163834
- Donner, S. D. 2009. Coping with commitment: Projected thermal stress on coral reefs under different future scenarios. *PLoS One* **4**: e5712. doi:10.1371/journal.pone.0005712
- Drury, C., D. Manzello, and D. Lirman. 2017. Genotype and local environment dynamically influence growth, disturbance response and survivorship in the threatened coral, *Acropora cervicornis*. *PLoS One* **12**: e0174000. doi:10.1371/journal.pone.0174000
- Edmunds, P. J. 2011. Zooplanktivory ameliorates the effects of ocean acidification on the reef coral *Porites* spp. *Limnol. Oceanogr.* **56**: 2402–2410. doi:10.4319/lo.2011.56.6.2402

- Egleston, E. S., C. L. Sabine, and F. M. M. Morel. 2010. Revelle revisited: Buffer factors that quantify the response of ocean chemistry to changes in DIC and alkalinity. *Global Biogeochem. Cycles* **24**: GB1002. doi:10.1029/2008GB003407
- Ezzat, L., E. Towle, J.-O. Irisson, C. Langdon, and C. Ferrier-Pagès. 2016. The relationship between heterotrophic feeding and inorganic nutrient availability in the scleractinian coral *T. reniformis* under a short-term temperature increase. *Limnol. Oceanogr.* **61**: 89–102. doi:10.1002/lno.10200
- Gattuso, J. P., Epitalon, J. M., Lavigne, H., Orr, J. Gentili, B., Proye, AZ., Soetaert, K., Rae, J. (2018). seacarb: seawater carbonate chemistry with R. R package version 3.2.6. <https://cran.rproject.org/package=seacarb>.
- Giordano, M., J. Beardall, and J. A. Raven. 2005. CO<sub>2</sub> concentrating mechanisms in algae: Mechanisms, environmental modulation, and evolution. *Annu. Rev. Plant Biol.* **56**: 99–131. doi:10.1146/annurev.arplant.56.032604.144052
- Gleeson, M. W., and A. E. Strong. 1995. Applying MCSST to coral reef bleaching. *Adv. Space Res.* **16**: 151–154. doi:10.1016/0273-1177(95)00396-V
- Hoegh-Guldberg, O., and others. 2007. Coral reefs under rapid climate change and ocean acidification. *Science* **318**: 1737–1742. doi:10.1126/science.1152509
- Hönisch, B., and others. 2012. The geological record of ocean acidification. *Science* **335**: 1058–1063. doi:10.1126/science.1208277
- Howells, E. J., V. H. Beltran, N. W. Larsen, L. K. Bay, B. L. Willis, and M. J. H. van Oppen. 2011. Coral thermal tolerance shaped by local adaptation of photosymbionts. *Nat. Clim. Chang.* **2**: 116. doi:10.1038/nclimate1330
- Howells, E. J., R. Berkelmans, M. J. H. van Oppen, B. L. Willis, and L. K. Bay. 2013. Historical thermal regimes define limits to coral acclimatization. *Ecology* **94**: 1078–1088. doi:10.1890/12-1257.1
- Hughes, T. P., and others. 2017. Global warming and recurrent mass bleaching of corals. *Nature* **543**: 373–377. doi:10.1038/nature21707
- IPCC, 2014: Climate Change 2014: Synthesis Report. Contribution of Working Groups I, II and III to the Fifth Assessment Report of the Intergovernmental Panel on Climate Change [Core Writing Team, R.K. Pachauri and L.A. Meyer (eds.)]. IPCC, Geneva, Switzerland, 151 pp.
- Kaniewska, P., P. R. Campbell, D. I. Kline, M. Rodriguez-Lanetty, D. J. Miller, S. Dove, and O. Hoegh-Guldberg. 2012. Major cellular and physiological impacts of ocean acidification on a reef building coral. *PLoS One* **7**: e34659. doi:10.1371/journal.pone.0034659
- Kleypas, J. A., J. McManus, and L. A. B. Menez. 1999. Environmental limits to coral reef development. Where do we draw the line? *Am. Zool.* **39**: 146–159. doi:10.1093/icb/39.1.146
- Kroeker, K. J., R. L. Kordas, R. N. Crim, and G. G. Singh. 2010. Meta-analysis reveals negative yet variable effects of ocean acidification on marine organisms. *Ecol. Lett.* **13**: 1419–1434. doi:10.1111/j.1461-0248.2010.01518.x
- LaJeunesse, T. C. 2002. Diversity and community structure of symbiotic dinoflagellates from Caribbean coral reefs. *Mar. Biol.* **141**: 387–400. doi:10.1007/s00227-002-0829-2
- Langdon, C., and M. J. Atkinson. 2005. Effect of elevated pCO<sub>2</sub> on photosynthesis and calcification of corals and interactions with seasonal change in temperature/irradiance and nutrient enrichment. *J. Geophys. Res.* **110**: C09S07. doi:10.1029/2004JC002576
- Leggat, W., M. R. Badger, and D. Yellowlees. 1999. Evidence for an inorganic carbon-concentrating mechanism in the symbiotic dinoflagellate *Symbiodinium* sp. *Plant Physiol.* **121**: 1247–1255. doi:10.1104/pp.121.4.1247
- Luna, G. M., F. Biavasco, and R. Danovaro. 2007. Bacteria associated with the rapid tissue necrosis of stony corals. *Environ. Microbiol.* **9**: 1851–1857. doi:10.1111/j.1462-2920.2007.01287.x
- Manzello, D. P. 2015. Rapid recent warming of coral reefs in the Florida Keys. *Sci. Rep.* **5**: 16762. doi:10.1038/srep16762
- Manzello, D. P., R. Berkelmans, and J. C. Hendee. 2007. Coral bleaching indices and thresholds for the Florida Reef Tract, Bahamas, and St. Croix, US Virgin Islands. *Mar. Pollut. Bull.* **54**: 1923–1931. doi:10.1016/j.marpolbul.2007.08.009
- Marubini, F., H. Barnett, C. Langdon, and M. J. Atkinson. 2001. Dependence of calcification on light and carbonate ion concentration for the hermatypic coral *Porites compressa*. *Mar. Ecol. Prog. Ser.* **220**: 153–162. doi:10.3354/meps220153
- Marubini, F., C. Ferrier-Pagès, P. Furla, and D. Allemand. 2008. Coral calcification responds to seawater acidification: A working hypothesis towards a physiological mechanism. *Coral Reefs* **27**: 491–499. doi:10.1007/s00338-008-0375-6
- Muehllhner, N., C. Langdon, A. Venti, and D. Kadko. 2016. Dynamics of carbonate chemistry, production and calcification of the Florida Reef Tract (2009–2010): Evidence for seasonal dissolution. *Global Biogeochem. Cycles* **30**: 661–688. doi:10.1002/2015GB005327
- Pandolfi, J. M., S. R. Connolly, D. J. Marshall, and A. L. Cohen. 2011. Projecting coral reef futures under global warming and ocean acidification. *Science* **333**: 418–422. doi:10.1126/science.1204794
- Pettay, D. T., D. C. Wham, R. T. Smith, R. Iglesias-Prieto, and T. C. LaJeunesse. 2015. Microbial invasion of the Caribbean by an Indo-Pacific coral zooxanthella. *Proc. Natl. Acad. Sci. USA* **112**: 7513–7518. doi:10.1073/pnas.1502283112
- Raven, J. A., Caldeira, K., Elderfield, H., Hoegh-Guldberg, O., Liss, P. Riebesell, U., Shepherd, J., Turley, C., Watson, A.J. 2005. Ocean acidification due to increasing atmospheric carbon dioxide, The Royal Society: 60.
- Raven, J. A., M. Giordano, J. Beardall, and S. C. Maberly. 2011. Algal and aquatic plant carbon concentrating mechanisms in relation to environmental change. *Photosynth. Res.* **109**: 281–296. doi:10.1007/s11120-011-9632-6

- Reynaud, S., N. Leclercq, S. Romaine-Lioud, C. Ferrier-Pages, J. Jaubert, and J.-P. Gattuso. 2003. Interacting effects of CO<sub>2</sub> partial pressure and temperature on photosynthesis and calcification in a scleractinian coral. *Glob. Chang. Biol.* **9**: 1660–1668. doi:10.1046/j.1365-2486.2003.00678.x
- Ries, J. B., A. Cohen, and D. C. McCorkle. 2009. Marine calcifiers exhibited mixed responses to CO<sub>2</sub>-induced ocean acidification. *Geology* **37**: 1131–1134. doi:10.1130/G30210A.1
- Sakai, K. 1998. Effect of colony size, polyp size, and budding mode on egg production in a colonial coral. *Biol. Bull.* **195**: 319–325. doi:10.2307/1543143
- Schneider, K., and J. Erez. 2006. The effect of carbonate chemistry on calcification and photosynthesis in the hermatypic coral *Acropora eurystoma*. *Limnol. Oceanogr.* **51**: 1284–1293. doi:10.4319/lo.2006.51.3.1284
- Schoepf, V., M. Stat, J. L. Falter, and M. T. McCulloch. 2015. Limits to the thermal tolerance of corals adapted to a highly fluctuating, naturally extreme temperature environment. *Sci. Rep.* **5**: 17639. doi:10.1038/srep17639
- St. Gelais, A. T., A. Chaves-Fonnegra, A. S. Brownlee, V. N. Kosmynin, A. L. Moulding, and D. S. Gilliam. 2016. Fecundity and sexual maturity of the coral *Siderastrea side-rea* at high latitude along the Florida Reef Tract, USA. *Invertebr. Biol.* **135**: 46–57. doi:10.1111/ivb.12115
- Sutton, A., C. Sabine, D. Manzello, S. Musielewicz, S. Maenner, C. Dietrich, R. Bott and J. Osborne (2016). Partial pressure (or fugacity) of carbon dioxide, pH, salinity and other variables collected from time series observations using Bubble type equilibrator for autonomous carbon dioxide (CO<sub>2</sub>) measurement, Carbon dioxide (CO<sub>2</sub>) gas analyzer and other instruments from MOORING\_CHEECA\_80W\_25N in the Coastal Waters of Florida, Florida Keys National Marine Sanctuary and North Atlantic Ocean from 2011-12-07 to 2015-03-22. NOAA National Centers for Environmental Information. Version 2.2.
- Towle, E., I. Enochs, and C. Langdon. 2015. Threatened Caribbean coral is able to mitigate the adverse effects of ocean acidification on calcification by increasing feeding rate. *PLoS One* **10**: e0139398. doi:10.1371/journal.pone.0139398
- Towle, E., A. N. Palacio-Castro, A. C. Baker, and C. Langdon. 2017. Source location and food availability determine the growth response of *Orbicella faveolata* to climate change stressors. *Reg. Stud. Mar. Sci.* **10**: 107–115. doi:10.1016/j.rsma.2017.01.007
- van Hooijdonk, R., J. A. Maynard, and S. Planes. 2013. Temporary refugia for coral reefs in a warming world. *Nat. Clim. Chang.* **3**: 508–511. doi:10.1038/nclimate1829
- Veron, J. E. N. 2008. Mass extinctions and ocean acidification: Biological constraints on geological dilemmas. *Coral Reefs* **27**: 459–472. doi:10.1007/s00338-008-0381-8
- Weis, V. M. 1993. Effect of dissolved inorganic carbon concentration on the photosynthesis of the symbiotic sea anemone *Aiptasia pulchella* Carlgren: Role of carbonic anhydrase. *J. Exp. Mar. Biol. Ecol.* **174**: 209–225. doi:10.1016/0022-0981(93)90018-J

#### Acknowledgments

Marie Letourneau and Alyssa Anderson spent many hours analyzing the optical micrometer data. Carolina Mor helped with the chemical analyses. A complete set of data files can be found at BCO-DMO ([www.bcodmo.org](http://www.bcodmo.org)) under the project name “Combined effects of temperature and acidification stress on two Caribbean coral species.” Funding for this study from the National Science Foundation is gratefully acknowledged (OCE-0547169). Corals for this study were collected under FKNMS permit no. 2007-028. Nutrient data provided by the SERC-FIU Water Quality Monitoring Network which is supported by SFWMD/SERC Cooperative Agreement 4600000352 and EPA Agreement X7-96410603-3).

#### Conflict of Interest

None declared.

Submitted 26 June 2017

Revised 21 January 2018

Accepted 9 April 2018

Associate editor: Bradley Eyre