



UNITED STATES DEPARTMENT OF COMMERCE  
National Oceanic and Atmospheric Administration

National Marine Fisheries Service  
Alaska Fisheries Science Center  
Auke Bay Laboratories  
Ted Stevens Marine Research Institute  
17109 Point Lena Loop Road  
Juneau, Alaska 99801-8344  
Fax (907) 789-6094

**FINAL Project Instructions**

**Date Submitted:** August 17, 2015

**Platform:** NOAA Ship *Oscar Dyson*

**Project Number:** **DY-15-08/09** (OMAO)

**Project Title:** BASIS, EMA/FOCI

**Project Dates:** September 5 to September 18, 2015 (DY-15-08)  
September 21 to October 6, 2015 (DY-15-09)

Prepared by:  Dated: 8/17/2015  
Alex G. Andrews III  
Chief Scientist  
Ecosystem Monitoring and Assessment Program

Approved by:  Dated: 8/17/2015  
Edward V. Farley, Jr.  
Program Manager  
Ecosystem Monitoring and Assessment Program

Approved by:  Dated: 8/17/15  
Phillip R. Mundy  
Director  
Auke Bay Laboratories

Approved by: \_\_\_\_\_ Dated: \_\_\_\_\_  
Commander Joe C. Bishop, NOAA  
Acting Commanding Officer  
Marine Operations Center – Pacific



## I. Overview

### A. Brief Summary and Project Period

Project Period: September 5– October 6, 2015

This research area is focused on improving and reducing uncertainty in stock assessment models of important commercial fish species in the Bering Sea through the collection of fisheries oceanographic indices.

### B. Days at Sea (DAS)

Of the 30 DAS scheduled for this project, 27 DAS are funded by an OMAO allocation, 0 DAS are funded by a Line Office Allocation, 3 DAS are Program Funded, and 0 DAS are Other Agency funded. This project is estimated to exhibit a High Operational Tempo.

### C. Operating Area

Eastern Bering Sea (see Appendix 1, 2).

### D. Summary of Objectives

**Note: Several major changes from past BASIS surveys are: 1) trawls at predetermined grid stations will be fished as oblique tows NOT surface tows, and 2) we will no longer divide the 24 hour period into day and night operations; day and night operations will be the same.**

Summary of Objectives: Fisheries (oblique, midwater, and beam trawls) and oceanographic survey to:

(1) Describe the community structure, biomass, energetic status, diets, and biological composition of epi-pelagic nekton including Pacific salmon, Pacific cod, age-0 pollock, jellyfish, herring, capelin and sand lance.

(2) Collect electronic oceanographic data including CTD (Conductivity-temperature-depth) vertical profiles of temperature, salinity, light transmission, chlorophyll a fluorescence, dissolved oxygen, photosynthetic available radiation (PAR). Continuously (along-track) collect sea surface temperature, salinity, chlorophyll a (chl-a) fluorescence data and above surface PAR (Hobo PAR sensor and data logger).

(3) Collect biological oceanographic samples (water and plankton) at trawl stations; i.e. zoo- and ichthyoplankton data using a 20 and 60 cm bongo samplers (oblique tow with 150  $\mu$ m and 505  $\mu$ m nets, respectively to near bottom or 300 m), and nutrients, chl-a, dissolved oxygen, and salinity using Niskin bottles attached to the carousel housing the CTD. These samples are collected to yield environmental indices of the current status and trends in the Bering Sea ecosystem.

(4) Conduct beam trawls for age 0 and age 1 arrowtooth flounder and other flat- and demersal fishes. Beam trawls will be conducted only at stations between 100 and 200 m depth.

(5) Conduct jellyfish sampling and experimentation to determine the diets and feeding rates of the dominant large jellyfish, *Chrysaora melanaster*, on fish eggs and larvae and on important fish prey (copepods, ichthyoplankton, euphausiids). Experiments will run in 24 hour intervals and require dip-netting of up to 150 individuals.

(6) Collect and analyze phytoplankton samples from Niskin bottles for taxonomic information using a bench-top phytoplankton imaging system (flow cytoBot) and a flow cytometer at a subset of stations.

(7) Collect water from Niskin bottles and conduct primary production experiments with stable (non-radioactive) isotopes using deck-board incubators cooled with surface seawater. Experiments will be conducted at a subset of stations.

(8) PMEL and AFSC will conduct oceanographic sampling along the standard 70 m isobath transect, at Designated Biological Observation (DBO) area 1, transects over the Bering Canyon and along the Unimak Box during DY-15-09.

(9) Collect microzooplankton samples from Niskin bottles at a subset of stations.

(10) Sort zooplankton to taxa for energetics analysis (fatty acids and genetics) and conduct deckboard incubation experiments on *Calanus* spp. at a subset of stations.

(11) Bering Sea mooring (M2) may be retrieved during DY-15-09. It is not expected that the Dyson will need to recover moorings, and will only serve as a backup if a charter vessel (R/V Aquilla) is unable to retrieve the moorings.

E. Participating Institutions

AFSC - Alaska Fisheries Science Center, Juneau, AK and Seattle, WA

PMEL - Pacific Marine Environmental Laboratory, Seattle, WA

USFWS – United States Fish and Wildlife Service, Anchorage, AK

WHOI – Woods Hole Oceanographic Institution, Woods Hole, MA

F. Personnel/Science Party: name, title, gender, affiliation, and nationality

Name (Last, First)	Title	Date Aboard	Date Disembark	Gender	Affiliation	Nationality
Andrews, Alex	Chief Scientist	8/18	9/18	M	AFSC	USA
Cooper, Dan	Fish Res. Biol.	9/3	10/7	M	AFSC	USA
Cieciel, Kristin	Fish Res. Biol.	9/3	9/18	F	AFSC	USA
Spear, Adam	Fish Res. Biol.	9/3	9/18	M	AFSC	USA
Ferm, Nissa	Fish Res. Biol.	9/3	9/18	F	AFSC	USA
Tabisola, Heather	Oceanographer	9/3	9/18	F	PMEL	USA
Strausz, David	Oceanographer	9/3	10/7	M	PMEL	USA
Auburn-Cook, Mary	Fish Res. Biol.	9/3	10/6	F	AFSC	USA
Dalke, Heather	Fish Res. Biol.	9/3	10/6	F	AFSC	USA
Reedy, Marty	Sea Bird Obs.	9/3	10/6	M	USFWS	USA
Eisner, Lisa	Chief Scientist	9/19	10/7	F	AFSC	USA
Harpold, Colleen	Fish Res. Biol.	9/19	10/6	F	AFSC	USA
Doyle, Miriam	Fish Res. Biol.	9/19	10/7	F	AFSC	USA
Strasburger, Wess	Fish Res. Biol.	9/19	10/7	M	AFSC	USA
Tarrant, Ann	Oceanographer	9/19	10/7	F	WHOI	USA
Proctor, Peter	Oceanographer	9/19	10/7	M	PMEL	USA

## G. Administrative

### 1. Points of Contacts:

Alex Andrews (Chief Scientist, DY-15-08), AFSC, 17109 Point Lena Loop Road, Juneau, AK 99801, ph: 907-789-6655, [Alex.Andrews@noaa.gov](mailto:Alex.Andrews@noaa.gov)

Lisa Eisner (Chief Scientist, DY-15-09), AFSC, 7600 Sand Point Way NE, Bldg 4, Seattle, WA 98115, ph: 206-526-4060, [Lisa.Eisner@noaa.gov](mailto:Lisa.Eisner@noaa.gov)

Dan Cooper (Alternate), AFSC, 7600 Sand Point Way NE, Bldg 4, Seattle, WA 98115, ph: 206-526-4330, [Dan.Cooper@noaa.gov](mailto:Dan.Cooper@noaa.gov)

Ed Farley (EMA Program Manager), AFSC, 17109 Point Lena Loop Road, Juneau, AK 99801, 907-789-6085, [Ed.Farley@noaa.gov](mailto:Ed.Farley@noaa.gov)

Janet Duffy-Anderson (RP Program Manager), AFSC, 7600 Sand Point Way NE, Bldg 4, Seattle, WA 98115, ph: 206-526-6465, [Janet.Duffy-Anderson@noaa.gov](mailto:Janet.Duffy-Anderson@noaa.gov)

Phyllis Stabeno (PMEL Program Manager), PMEL, 7600 Sand Point Way NE, Bldg 3, Seattle, WA 98115, ph: 206-526-6453, [Phyllis.Stabeno@noaa.gov](mailto:Phyllis.Stabeno@noaa.gov)

#### **Oscar Dyson**

CO cell: 206-271-4475

XO cell: 206-295-0775

CME cell: 206-604-4685

Iridium: 808-659-0050

Underway VIOP: 301-713-7778

INMARSAT: 011-870-336-995-920 (voice)

Field Operations Officer, Lt. Carl Rhodes

[Ops.oscar.dyson@noaa.gov](mailto:Ops.oscar.dyson@noaa.gov)

2. Diplomatic Clearances

None Required.

3. Licenses and Permits

This project will be conducted under the Scientific Research Permit (U.S.) issued by the Alaska Regional Office, National Marine Fisheries Service (Permit number 2015-B1), and a Fish Resource Permit issued by the State of Alaska (Permit number CF-15-057). The Chief Scientists will be included as an authorized participant on both permits.

## II. Operations

The Chief Scientist is responsible for ensuring the scientific staff are trained in planned operations and are knowledgeable of project objectives and priorities. The Commanding Officer is responsible for ensuring all operations conform to the ship's accepted practices and procedures.

A. Project Itinerary:

**DY-15-08**

Sep 3 Embark scientists in Dutch Harbor, AK  
Sep 5 Depart Dutch Harbor, AK for eastern Bering Sea  
Sep 5 - 17 Fish/Ocean survey  
Sep 18 Arrive Dutch Harbor, AK  
Sep 18 - 19 Disembark scientific party

**DY-15-09**

Sep 19 Embark scientists in Dutch Harbor, AK  
Sep 21 Depart Dutch Harbor, AK for eastern Bering Sea  
Sep 21 – Oct 3 Fish/Ocean survey  
Oct 6 Arrive Kodiak, AK  
Oct 6 - 7 Disembark scientific party

B. Staging and Destaging:

The scientific gear necessary for the project will be shipped to Kodiak and loaded onto NOAA Ship *Oscar Dyson* along with DY 15-07 survey gear prior to departure from Kodiak on 20 (Sunday) August 2015.

Most scientific gear will be offloaded in Kodiak, AK at the end of DY 15-08/09 survey on 6 (Tuesday) October 2015. **Request DY transport biological and oceanographic samples, equipment, and chemicals to Newport, OR. Request DY transport pelagic trawls and bridles to Newport, OR for annual maintenance.**

C. Operations to be Conducted:

**1. DY-15-08 Only.** Perform several test tows with new NETS 156 pelagic trawl. Since this is the first time using this trawl we would like to perform test tows to evaluate trawl performance. We would like to attach Simrad net sounder and ITI sensors to collect net mensuration data. This will give us an opportunity to adjust tom weights and headrope flotation as needed. We will consult with CO and OPS officer to select an area where the water depth and weather will allow for a variety of tests.

**2. DY-15-08 & DY-15-09.** Survey operations will be conducted during day and night-time periods. Therefore, we request 24 hour operations, with sufficient deck and survey support for all operations. Stations will be sampled using a systematic grid design with stations spaced every 30 minutes of Latitude and 1 degree of Longitude. The main survey grid will cover the area from 160° W to 173° W at locations with water depths of at least 25 meters (see Appendix 1). We have achieved stations of this depth in the past on *Oscar Dyson*, but as always, we can modify trawl station locations if the CO chooses.

**3. DY-15-08 & DY-15-09.** Pelagic trawl operations require that the NETS 156 pelagic trawl be loaded onto the net reel. A pair of NETS five-meter alloy doors and thirty fathom wire rope bridals will be used with the trawl. We may need to experiment with adding tom weights to the footrope and trawl floats to the headrope to obtain an adequate vertical mouth opening. A second pair of NETS doors will be stored on board the vessel as backup gear. A Stauffer (also known as Anchovy, Cobb) trawl will be loaded onto the second net reel as a spare net. Thirty fathom bridles and the NETS doors will be used to fish the net Stauffer trawl. A spare shrimp trawl will be aboard as an additional backup. We request that the Chief Boatswain keep a trawl gear logbook to record all modifications made to trawl gear during the project. An average of 5 pelagic trawl hauls and an occasional opportunistic targeted midwater per 24 hrs is anticipated.

Pelagic trawl haul duration will vary depending on water depth, beginning when the doors go in and ending when the doors come out. The Simrad FS-70 3<sup>rd</sup> wire net sounder **will** be placed on the kite at the headrope to provide real-time net dimensions. In addition, SBE39 sensors will be placed on the headrope and footrope of the surface trawl to collect data on vertical spread and location in the water column. Potentially, Simrad ITI sensors (i.e. trawl monitoring system) will be attached to the footrope for real-time depth information. Since we are testing a new pelagic trawl, we may also want to use the Simrad ITI sensors to measure spread at other areas of the trawl. Since we are unfamiliar with the NETS 156 pelagic trawl, we will place small cameras on the trawl to learn more about the water flow characteristics and possible areas of fish escapement.

Targeted midwater trawl hauls will be made to identify acoustic backscatter and to provide fish samples and other biological data. Targeted midwater trawl hauls will be conducted during day and night time hours when suitable backscatter conditions are encountered. Tow duration will depend on the echosign present, but it is generally anticipated that no more than 30 minutes will be spent within the scattering layer (estimate excludes trawl deployment/recovery times). The Simrad FS-70 system **will** be used for all targeted midwater hauls. Additionally, an SBE39 sensor will be attached to the trawl headrope and another to the footrope to estimate net mouth vertical opening.

Biological data collected from each haul will include species composition by weight and number, sex composition, length frequencies, whole fish weight, maturities, salmon scales, and otoliths.

**4. DY-15-08 & DY-15-09.** Acoustic data will be collected continuously with a Simrad ER60 echo integration system incorporating centerboard-mounted transducers at 18, 38, 70, 120, and 200 kHz. The centerboard should be left in the **intermediate** position during the entire project. It is requested that vessel not operate other echo sounders or acoustic equipment that interferes with collection of scientific acoustic data unless it is unsafe to navigate without them. The bow thrusters, Doppler speed log and bridge Furuno depth sounder should all be secured, as long as it is safe to do so as determined by the ship's OOD, as they degrade the quality of acoustic data.

**5. DY-15-08 & DY-15-09.** At each predetermined trawl station, small fishes and zooplankton will be sampled using fine-mesh nets: 60 cm diameter bongo nets (oblique tow) with 505 (Net 1) and 505 (Net 2) micron nets, and a 20 cm bongo array with 150 micron nets. Zooplankton net tows will occur during day and night-time hours. The bongo net will be deployed on one of the oceanographic winches with conducting wire (using real time CTD data collected with an SBE19 or SBE 49). Plankton samples will be preserved in 5% buffered formalin. 60Bon Net 1 (505 mesh) will be preserved for zoo- and ichthyoplankton and 60Bon Net 2 will be sorted at sea for special projects and then discarded. 20 Bon Net 1 will be preserved for zooplankton, 20 Bon Net 2 will be sorted for special projects (time permitting) and discarded. Zooplankton tows will be to near-bottom (5-10 m from bottom) or 300 m (if bottom depths are > 300 m).

**6. DY-15-08 & DY-15-09.** CTD casts will be conducted at each surface trawl station and *ad-hoc* casts may be necessary to document changes in oceanographic characteristics during the survey. For each cast, instruments and 5 or 10 L Niskin bottles will be added to the ship's CTD carousel. Instruments added to the ship's SBE 911+ CTD include secondary TC sensors, a PAR spherical sensor (Biospherical Instruments QSP 2300), chl-a fluorometer with turbidity sensor (Wet Labs ECO FL-NTU), beam transmissometer (Wet Labs C-star), and two dissolved oxygen sensors (SBE 43). See fact sheets for all instruments. CTD casts will be to near-bottom (5-10 m from bottom).

**7. DY-15-08 & DY-15-09.** We will collect along-track surface measurements of temperature, salinity, chlorophyll a fluorescence with the ship's thermosalinograph (TSG) system (SBE-45, Wet Labs WetStar fluorometer).

**8. DY-15-08 & DY-15-09.** Water samples collected with Niskin bottles attached to the CTD will be sampled for chlorophyll a, nutrients, salinity, oxygen, phytoplankton taxa, primary production experiments and possibly microzooplankton (preserved with Lugols). Primary production experiments using stable (non-radioactive) isotopes will be conducted at a subset of stations using deck-board incubators cooled with surface seawater. Chl-a and primary production samples must be stored in the -80 freezer.

**9. DY-15-08 & DY-15-09.** Above surface PAR data will be continually recorded with a HoBo PAR sensor and data logger mounted on the flying bridge.

**10. DY-15-08 Only.** Up to 200 samples of the target species *Chrysaora melanaster* will be collected for gut analysis. Jellyfish will be netted from the hero deck at the surface with a long-handled dip-net or with a 1-m “gel net” to keep sample intact and to minimize net damage. If time allows on station, we may request that the hero deck platform be deployed to allow for easier netting of specimens further away from the ship’s hull. A total of 25 specimens will be collected per station to allow analysis of the relationship between the local diet and local oceanographic, zooplankton, and pelagic fish community observations. Upon collection, individual jellyfish will be weighed and measured, and all gut and appendage contents will be immediately preserved in 5% formalin in separate containers. Samples will be processed for diet analysis in the laboratory or onboard depending on vessel staffing and time.

**11. DY-15-08 Only.** Gut evacuation experiments will be conducted September 5 - 18 to estimate digestion times of different prey types by the jellyfish, *C. melanaster*. During the BASIS surveys aboard NOAA Ship *Oscar Dyson*, 40 jellyfish will be dip-netted from the sea surface and placed in 20 20-L containers filled with 80-µm filtered seawater at ambient temperatures in total darkness. Individual feeding intensity will be factored into determining digestion rates. Ten jellyfish will be removed and preserved at 0, 2, 4, and 6h intervals. Individual jellyfish will be placed in separate containers in 5% buffered formalin and gut contents will be enumerated as above. Deck space for tanks with seawater access will be needed; approximately a 6 foot by 6 foot footprint.

**12. DY-15-08 & DY-15-09.** Beam trawls will be conducted at each predetermined trawl station where bottom depth is between 100 and 200 meters. A modified plumb-staff, 3-m beam trawl will be deployed to collect juvenile flatfishes and demersal gadids from the seafloor.

We request assistance from the Bridge, Survey, and Deck Dept with deployment, fishing/monitoring, and retrieval of beam trawls. We will use the ITI (trawl eye) system to monitor depth of the trawl in real time. Assistance from the Bridge and Deck department with ITI (trawl eye) is requested for deployment, retrieval, and keeping it charged. An SBE-39 will be attached to a steel ring on the beam trawl bridle. We request assistance from the survey department to initialize the SBE-39 and download the data from each tow.

The trawl codend should be inverted and inspected after each trawl to ensure all juvenile flatfish and other small taxa are retained.

Processing:

Sorting: Upon retrieval of trawl to the deck, contents will be emptied into the trawl sorting conveyor and photographed (identify station/haul in photo) for associated benthic fauna and substrata. Rinsing the entire catch may be necessary if it is muddy. Fish should be sorted into the following taxonomic groups: Flatfish species [flatfish juveniles (<120 mm TL) may be sorted separately from larger fish], walleye pollock, Pacific cod, Arctic cod, other expedient and logical taxonomic fish groups (ex. poachers, snailfishes, sculpin).

Invertebrates are to be sorted into the following taxonomic groups: Hermit crabs, gastropods, king crab to species, chionoecetes spp., other crabs, sea stars, brittle stars, sponge, bivalves and bivalve shell (greater than ½ of a shell), worm tubes, shrimps, and



other taxonomic groups as possible.

Subsamples may be rinsed with a 2 mm sieve if muddy.

Lengths: lengths for the following taxonomic groups will be recorded: < 120 mm TL juvenile flatfish to species (TL mm), flatfish > 12 cm TL to species (TL cm), Pacific cod (age-0 SL mm, age-1+ TL cm), walleye pollock (age-0 SL mm, age-1+ FL cm), Arctic cod (FL mm).

#### STORAGE:

After counting and weighing, flatfish juvenile species groups containing fish < 120 mm TL, age-0 walleye pollock, and age-0 Pacific cod will be saved and frozen (1 bag per species) in the -80 C freezer in the rough lab. Project, date, station, haul, and species should be recorded on the outside of the bag and inside on a bag label. After 24 hours, bags of frozen fish may be transferred to the (-20 F, slime lab freezer).

Chionoecetes crabs will also be preserved by freezing. Please mark station/haul/species/Ryer (inside label and outside bag).

All other species may be discarded.

#### 13. **DY-15-08 & DY-15-09.** Standard station activities include:

- CTD cast with Niskin water sample collection.
- Jellyfish (when present near surface) sampled with dipnet.
- Oblique bongo net tow (FOCI set-up, 20 & 60 cm bongo).
- Pelagic oblique trawl (average 5 tows/day)
- Targeted mid-water trawl (opportunistically; location and duration determined at sea).
- Beam trawl (only at stations between 100 and 200 m depth).

We expect activities and travel between stations to take 4 to 6 hours, depending on schedule for the mid-water trawl.

We plan for 2 scientific teams with 12 hour shifts each. It is likely that the first shift will begin on or around 06:00 am and end at 18:00 and the second shift will begin around 18:00 and end around 06:00. When time allows, we request assistance from the survey techs sorting and processing the fish catch.

**14. DY-15-09 Only.** A multinet will be deployed at select stations (see Appendix 2). The Multi Plankton Sampler MultiNet Type Midi will be used at select stations to determine vertical distribution of fish larvae and zooplankton (0.333 mm mesh). The sampling will be focused over Bering Canyon, approximately 12 stations. The exact number and location will be determined by the scientific party at sea and may be adjusted depending on conditions and project priorities.

During multinet deployment, we request assistance from the ship's Electronics Technician, Survey Technician and / or Deck Department as needed to help set

up the electronic and physical termination, rig the MultiNet for fishing, and help trouble shoot the MultiNet. We also request help switching between the Bongo and MultiNet on the aft Oceowinch as needed during the project.

The MultiNet has a steel frame with a square mouth opening of 0.5 x 0.5 m that can be used with up to 5 nets to sample different water depths. This net requires a conducting cable and will be deployed off the aft oceanographic winch that the Bongo array is usually attached to. Before deployment of the Multinet, the Seacat and Bongo array will be detached and the MultiNet will be electronically and physically terminated to that conducting wire. For the stations over Bering Canyon, the MultiNet will be used in place of the Bongo (after the CTD). If we have gear problems with the Multinet, the Bongo will be used as a backup. When we are done using the MultiNet, the Seacat and Bongo Array will be reconnected to continue the rest of our routine sampling. The MultiNet plankton samples will be processed in a similar manner as those from the Bongo, filtered and preserved in 1.8% Buffered Formaldehyde (5% buffered formalin).

Winch / Fishing Rates (Multinet)

- Ship Speed: ~2.5-3 knots (may need to be adjusted based on conditions)
  - Wire Payout Rate: 20 m per. min.
  - Wire Retrieval Rate: no more than 10 m per min., possibly slower TDB by scientific party based on how much water is being filtered.
  - Target Wire Angle 55° (acceptable range 50°-60°)
  - Maximum Gear Depth: ~ 300 m or 10m off bottom
- MOA Buttons Needed for SCS
- In the water (surface)
  - At Depth
  - Net 1
  - Net 2
  - Net 3
  - Net 4
  - Net 5
  - Out of the water (surface)

Approximate Sampling Intervals (may change depending on bottom depth and sampling needs):

- 0-25 m
- 25-50 m
- 50-100 m
- 100-200 m
- 200-300 m

**15. DY-15-08 & DY-15-09.** The Scientific Computing System (SCS) will be configured to log data from a large array of sensors during the project including data from the thermosalinograph, CTD casts, weather data (particularly above surface PAR or other light measurements and wind speed and direction), etc.

**16. DY-15-09 Only.** 70-m isobaths. This portion of the project will serve to continue a long-term time series of observations describing the physical and biological properties of the Bering Sea shelf. Information will be collected

through CTD casts and water sampling, underway shipboard measurements and plankton tows along the 70m isobath and at stations around the moorings. Activities: CTD - 70 m isobaths (chlorophyll 0, 10, 20, 30, 40, 50 m; nutrients 0, 10, 20, 30, 40, 50, near-bottom). Stations will likely be occupied from south to north. A CTD cast will be the first operation at each station. At every other station along the isobath, a bongo tow will occur. When at the stations around or at each mooring, both a CTD and bongo will be done and when at the mooring stations triplicate CalVET (i.e. vertical zooplankton sampling nets) tows will be completed as the last operation.

Bongo towing 70 m isobath: Paired, 60 cm/20 cm bongo nets will be deployed. The 60 cm diameter bongo nets (oblique tow) will be rigged with 505 (Net 1) and 333 (Net 2) micron nets and the 20 cm bongo nets will be rigged with 153 micron nets (Nets 1&2). The bongo net will be deployed on the aft oceanographic winch with conducting wire (using real time CTD data collected with an SBE19 or SBE 49). Plankton samples will be preserved in 5% buffered formalin. 60Bon Net 1 (505 mesh) and Net 2 will both be preserved for future zooplankton sorting (a between net catch comparison will be performed). 20 Bon Net 1 will be preserved in buffered formalin and 20 Bon Net 2 will be discarded or used for special projects.

**17. DY-15-09 Only.** At Distributed Biological Observatory (DBO) stations (located southeast of St Lawrence island, see Appendix 1,2), CTDs and bongo tows will be conducted.

**18. DY-15-09 Only.** Unimak CTD Box. A CTD (with nutrient and chlorophyll samples) will be deployed at each of 18 stations in a “box” around Unimak Pass. A 20/60 cm bongo will be deployed at every station within Unimak Pass and every other station on the other sides of the box for collection of mesozooplankton. If there is not enough time to complete the entire box, the top priority is the western side of the box (UBW1, UBW2, UBW3, UBW4) and second priority is the stations in Unimak Pass (UBS1, UBS2, UBS3, UBS4).

**19. DY-15-09 Only.** Mooring operations (for schematics see Appendix 3). It is not expected that the Dyson will need to recover moorings, and will only serve as a backup if a charter vessel (R/V Aquilla) is unable to retrieve the moorings. Prior to recovery of moorings, calibration CTDs with nutrient and chlorophyll samples will be completed approximately 0.5 miles from the mooring sites.

#### D. Dive Plan

All dives are to be conducted in accordance with the requirements and regulations of the NOAA Diving Program (<http://www.ndc.noaa.gov/dr.html>) and require the approval of the ship's Commanding Officer.

Dives are not planned for this project.

#### E. Applicable Restrictions

Conditions which preclude normal operations: None known.

F. Marine Mammal, Endangered, and Protected Species

During fishing operations, take all proactive steps to avoid deploying the gear in any situation where there is a high likelihood for an incidental take of protected species or marine mammals. This could mean delaying a set or moving to a suitable alternate site. Be on the look for marine mammals or other protected species prior to initiating a tow and also at haul back.

Within 24 hours of any incidental take of, or injuries or mortalities to, marine mammals as a result of operations, the Chief Scientist/Field Party Chief shall report incident to the vessel CO, Jon Kurland (jon.kurland@noaa.gov, 907-586-7638) or Robyn Angliss (robyn.angliss@noaa.gov, 206-526-4032), and guy.fleischer@noaa.gov and jeff.napp@noaa.gov with cc to john.c.clary@noaa.gov. This information will be entered into the Protected Species Incidental Take (PSIT) system per instructions below.

Seabirds can be sampled and retained for salvage – if take involves seabird, include Shannon Fitzgerald in notification at shannon.fitzgerald@noaa.gov. If take involves ESA-listed bird, retain specimen and we will notify FWS (to issue collection authority). Do not retain gulls – except Kittiwakes. Albatross are high priority.

**KEY ACTIONS IN RESPONSE TO ALL INCIDENTAL TAKES**

1. Prior to the project, communicate and coordinate with vessel crew about established protected species incidental take reporting and handling procedures whether NOAA, charter, or partner project. Ensure regional ESA biologists and pertinent staff are in the PSIT email alert notification list. The Office of Law Enforcement (OLE) will be notified of takes via PSIT email alert system for all non-marine mammal takes including seabirds within 48 hours of the event.
2. Notify the geographically-appropriate Regional Stranding Response Coordinator (numbers in this document) immediately following the incidental take of a marine mammal. Stranding Response Coordinator will contact Office of Law Enforcement (OLE). For live injured/uninjured marine mammals, priority should be to release the animal before notifying stranding response networks. NOTE: If Coordinators are unreachable, collect pertinent PSIT information and release animal and/or retain carcass if logistically feasible.
3. For a sea turtle or protected fish (injured/live/dead), follow the Terms and Conditions stated in your Fisheries Independent Monitoring Biological Opinion regarding reporting and data collection. If you do not have a current Biological Opinion, contact your designated Regional or Science Center Protected Species Point of Contact for instructions.
4. For handling, sampling and salvaging seabirds (ESA and non-ESA listed), contact regional United States Fish and Wildlife Service (USFWS) points of contact or NMFS regional seabird coordinator. If you have a permit, report seabird takes to PSIT.

**PRE-PROJECT ACTIONS**

- 1) Prior to the project, communicate and coordinate with vessel crew about established protected species incidental take reporting and handling procedures whether NOAA, charter, or partner project.
- 2) Ensure regional ESA biologists and pertinent protected resources staff is in the PSIT email alert notification list.
- 3) The NMFS Chief Scientist or Designee shall contact the appropriate Regional Stranding Network and query about additional numbers or specific contacts to reach in case of an incidental take of a marine mammal.

### **WHAT TO DO WITH LIVE, INJURED OR UNINJURED MARINE MAMMAL**

If a live, injured or uninjured marine mammal is incidentally captured, the animal should be released immediately.

- 1) Considering human safety, work from the vessel as quickly and carefully as possible to free the animal from the gear. Ensure the animal can continue to breathe while freeing from the gear.
- 2) If it can be done immediately without further harming the animal, photograph the animal (dorsal and ventral sides including dorsal fin, flanks, head/jaw) and gear interaction at time of capture and when free from gear prior to release and collect required PSIT information.
- 3) If animal is NOT brought aboard the vessel and taking photos is not an option, provide a comprehensive summary of the incident following requirements described under 'PSIT narrative' in this document.
- 4) Notify Regional Stranding Response Coordinator about the incident.
- 5) Submit take information for submission to PSIT and attach any forms, photos, and narrative to the take record within a week of the event.

Note: Untrained personnel should not attempt to handle live injured/uninjured marine mammals or disentangle large whales. In the event of a large entangled whale, immediately call your regional entanglement response network.

### **WHAT TO DO WITH DEAD MARINE MAMMAL OR SEA TURTLE?**

- 1) Notify Regional Stranding Network Coordinator about the take of a dead marine mammal.
- 2) For sea turtle takes, simply report the take/s to PSIT and follow the instructions listed in your Biological Opinion or follow Regional or Science Center Protected Species Point of Contact instructions.
- 3) If logistically feasible, the animal should be hauled aboard the vessel and retained for pick up by the local Stranding Network. Develop a plan with Stranding Network Coordinator or regional ESA biologist and/or relevant Center scientist for carcass pickup and subsequent necropsy.

- 4) If the animal cannot be hauled aboard due to human safety consideration or there is no feasible way for carcass retention onboard, release animal after necessary information is collected as described below.
- 5) Photos of the carcass should be taken: Dorsal fin, ventral side, and flank for marine mammals, as well as signs of entanglement, scars, and injuries. This also includes collecting required PSIT data.
- 6) Submit take information for submission to PSIT and attach any forms, photos, and narrative to the take record.

### **PSIT Reporting**

Report [1] Species involved, [2] number dead, number injured and released, or number uninjured and released, [3] date and time, [4] latitude and longitude, [5] any mitigation measures taken, [6] other comments or observations germane to this take. Note if photo was taken.

In addition to the required PSIT information please complete a narrative which includes the following information.

#### **1) Animal Condition (include photos)**

Code 1 – Live Animal

Code 2 – Fresh Dead

Code 3 – Moderate Decomposition

Code 4 – Advanced Decomposition

#### **2) Mention if animal escaped or was released.**

**3) Indicate if the animal or other marine mammals or sea turtles were seen in the vicinity of the vessel during fisheries operations.**

**4) Animal condition post-release: Describe any observed injuries, the condition and behavioral state of released or injured animal (e.g., no obvious injuries and animal swam away vigorously, did not swim away vigorously, animal surfaced to breathe, animal sank to bottom, or blood in water observed).**

**5) If gear was still attached to animal after release, describe how the gear was cut and approximately how much gear is left and where it is still entangled/injured.**

**6) Photos: Provide comprehensive photographic evidence or written description of live/dead or injured animal. Provide pictures (if possible) of how the animal was entangled in the gear, and any gear-related interactions such as wounds or constrictions.**

**7) Decision-making: Include rationale for any discretionary decisions taken by Chief Scientist/crew.**

8) Describe possible causes for incidental capture of the animal and any additional mitigation measures that were taken, or might be taken to prevent similar captures in all subsequent operations.

### **ENTANGLEMENT RESPONSE NETWORK NUMBER**

Alaska Region: 1-877-925-7773

## **III. Equipment**

### **A. Equipment and Capabilities provided by the ship (itemized)**

#### **1. Acoustic Equipment**

- GPS with NEMA 183 to ER60 (2)
- 50/200 kHz ES60 Bridge sounder
- Furuno FE-700 fathometer
- Acoustic echosounders (5)

#### **2. Trawling Equipment**

- 3rd wire FS-70 net sonar with winch and accessories (2)
- Simrad ITI net mensuration system (2)
- Furuno CN24-40 headrope transducer
- Stern trawl capabilities for pelagic and beam trawls
- Slack lines and door legs

#### **3. Oceanographic Equipment**

- Both starboard oceanographic winches with conducting cable, slip rings and blocks. Forward winch terminated for CTD/rosette; aft winch terminated for SeaCat/FastCat.
- Seabird SBE 911+CTD System
- Seabird SBE19+CTD and PDIM for real time data on zooplankton tows
- SBE45 Thermosalinograph with fluorometer
- Wire speed indicators and readout for both hydrographic winches visible in Dry Lab or where SEACAT operations occur
- Weather instr. For above surface PAR, wind speed/direction
- Ship's crane

#### **4. Biological Sampling Equipment**

- Fish lab conveyor system
- Catch sorting and weighing table
- Marrel M60 60kg scale (2)
- Marrel M60 6kg scale (2)
- Elect. Fish meas. Board (2)

#### **5. Computing equipment**

- Scientific Computing System

#### **6. Sample storage equipment**

- Supercold freezer (-80C)
- Walk in freezer (-10C)
- Stand up freezer (-20C)
- Hazmat storage cabinets

#### **7. Laboratory and exterior working space**

- Use of Pentium PC in Dry and/or Computer Lab for data analysis,
- Scientific Computer System (SCS)

- Video monitors in Dry, Chemistry, and Wet labs for viewing SCS and Electronic MOA output
  - Laboratory space with exhaust hood, sink, lab tables, and storage space
  - Sea-water hoses and spray nozzles to wash nets (quarterdeck and aft deck),
  - Adequate deck lighting for night-time operations,
  - Navigational equipment including GPS and radar,
  - Safety harnesses for working on starboard sampling station/hero platform and fantail
  - Ship's crane(s) used for loading and/or deploying gear and supplies
  - Surface seawater on aft deck for jellyfish experiments, primary production experiments, and zooplankton starvation experiments (see special project 2 below).
- B. Equipment and Capabilities provided by the scientists (itemized)
1. Acoustic Equipment (500lbs)
  2. Trawling Equipment (11,000lbs)
    - New NETS pelagic trawl w/ accessories (1; 900lbs)
    - Mod-Stauffer trawl w/ accessories (1; 900lbs)
    - Shrimp trawl w/ accessories (1; 800lbs)
    - NETS 5.0m doors with accessories (2 sets; 3,000lbs)
    - 5x7 v doors (two sets: 1250lbs)
    - Spare webbing & twine
    - Spare hardware
    - Tom weights 100 lbs (4 ea 100 lb clump wts)
    - 3-m beam trawls (2)
    - All accessories to make trawls fishable and spare web if available
  3. Oceanographic Equipment (1,500lbs)
    - Biospherical !SP2300 PAR sensor
    - Wet labs ECO Fluorometer and turbidity sensor (FL-NTU)
    - Wet labs C-star Transmissometer
    - SBE 43 dissolved oxygen sensor (2)
    - Secondary TC sensors for SBE 911+
    - SBE 19Plus SeaCat
    - SBE 49 FastCat
    - Niskin Bottles 10 L (need 10 total+ spares) with silicon tubing
    - Filter racks and pumps (3)
    - Microscopes (compound, dissecting, stereo) (4)
    - 20 & 60 cm Bongo frames, 505/335/153 mesh nets, cod ends, weights, and flowmeters
    - CalVET frame and 53  $\mu$ m mesh nets, cod ends, and flow meters
    - Multinet
    - Two wire-angle indicators
    - Bench-top phytoplankton imaging systems (flow CytoBot and flow cytometer)
    - Deck-board incubators (2) for primary production experiments
    - Deck-board tanks for jellyfish experiments



- Biological supplies (misc.) \*
4. Biological Sampling Equipment (500lbs)
    - Dynamometer
    - Marel M60 60 kg scale (2); already on ship (MACE)
    - Marel M60 6 kg scale (2); already on ship (MACE)
    - Mechanical platform scale (2); already on ship (MACE)
    - Fish baskets (30); already on ship (MACE)
    - Fish catch logging system (CLAMS); already on ship (MACE)
    - Elect. Fish meas. Board (2); already on ship (MACE)
  5. Miscellaneous scientific sampling and processing equipment
    - Dishpans (10, MACE)
    - 5-gal buckets (5)
    - Wading pools (small and large)
    - Two length board and strips for adult fish
    - Three length boards for small fish
    - SBE-39 temperature and depth sensor (MACE) for beam trawl
    - Triple-beam balance for small fish weights
    - 1000 Zip-loc bags (12")
    - Sieves, jar holder, funnels, squirt bottles
    - 30 cases of 32-oz jars, closures, and labels
    - 10 flowmeters, calibration data, hardware for attaching and maintaining them
    - Preservative-dispenser equipment
    - Hazardous materials spill kit
    - Spare wire angle indicator
  6. Computing equipment (50lbs)
    - IBM compatibles w/XP Op.System\*
    - Printers\*
    - Laptops
    - Cruise Operations Database (COD) software and forms

#### **IV. Hazardous Materials**

##### **A. Policy and Compliance**

The Chief Scientist is responsible for complying with FEC 07 Hazardous Materials and Hazardous Waste Management Requirements for Visiting Scientific Parties (or the OMAO procedure that supersedes it). By Federal regulations and NOAA Marine and Aviation Operations policy, the ship may not sail without a complete inventory of all hazardous materials by name and quantity, MSDS, appropriate spill cleanup materials (neutralizing agents, buffers, or absorbents) in amounts adequate to address spills of a size equal to the amount of chemical brought aboard, and chemical safety and spill response procedures. . Documentation regarding those requirements will be provided by the Chief of Operations, Marine Operations Center, upon request.

Per OMAO procedure, the scientific party will include with their project instructions and provide to the CO of the respective ship 30 days before departure:

- List of chemicals by name with anticipated quantity
- List of spill response materials, including neutralizing agents, buffers, and absorbents
- Chemical safety and spill response procedures, such as excerpts of the program's Chemical Hygiene Plan or SOPs relevant for shipboard laboratories
- For bulk quantities of chemicals in excess of 50 gallons total or in containers larger than 10 gallons each, notify ship's Operations Officer regarding quantity, packaging and chemical to verify safe stowage is available as soon as chemical quantities are known.

Upon embarkation and prior to loading hazardous materials aboard the vessel, the scientific party will provide to the CO or their designee:

- An inventory list showing actual amount of hazardous material brought aboard
- An MSDS for each material
- Confirmation that neutralizing agents and spill equipment were brought aboard sufficient to contain and cleanup all of the hazardous material brought aboard by the program
- Confirmation that chemical safety and spill response procedures were brought aboard

Upon departure from the ship, scientific parties will provide the CO or their designee an inventory showing that all chemicals were removed from the vessel. The CO's designee will maintain a log to track scientific party hazardous materials. MSDS will be made available to the ship's complement, in compliance with Hazard Communication Laws.

Scientific parties are expected to manage and respond to spills of scientific hazardous materials. Overboard discharge of hazardous materials is not permitted aboard NOAA ships.

## B. Inventory

See Appendix 4.

## C. Chemical safety and spill response procedures

Chemicals will be transported, stored and used in a manner that will avoid any spills and adequate containment, absorbents and cleanup materials will be available in the event of a chemical spill.

The scientific chemicals to be used for this project are: (1) ethyl alcohol (100%) and (2) formaldehyde (37%). Other chemicals brought aboard are consumer products in consumer quantities. Dilutions of the scientific chemicals will be used to preserve in faunal organisms collected with bongo nets, as described in the Operations section of these Project Instructions. Use of these chemicals and the specified dilutions will only occur in exterior locations on the ship away from air intakes. Scientific chemicals shall not be disposed over the side.

Standard Operating Procedures and Information Sheets are provided here for the scientific chemicals. Included are details concerning personal protective equipment, work area

precautions, special handling and storage requirements, spill and accident procedures/first aid, waste disposal and other pertinent information. Both small and large spills are of particular concern. In both cases, the spill response is intended to first contain the spill and then neutralize it. This may be easily accomplished for small spills depending on the degree of vessel motion and the prevailing environmental conditions. In all cases, the first responder should quickly evaluate the risks of personal exposure versus the potential impacts of a delayed response to the spill and act accordingly. For example, if the spill is small and it is safe to do so, a neutralizing agent should be rapidly applied to encircle/contain the spill and then cover it. However, a large formaldehyde spill (> 1 L) is extremely hazardous and individuals at risk of exposure should immediately leave the area. The CO or OOD should be notified immediately so that a response team with self-contained breathing apparatus (SCBA) can be deployed to complete the cleanup operation or dispense the hazard with a fire hose directed overboard. The vessel's course should be adjusted to minimize exposure of personnel to wind-driven vapors and to limit spread of the spill due to vessel motion. The reportable quantity (RQ) of formaldehyde is 1,000 pounds and the RQ for ethyl alcohol is 5,000 pounds which greatly exceed the quantities brought aboard for this project.

#### **ACID**

- Wear appropriate protective equipment and clothing during clean-up. Keep upwind. Keep out of low areas.
- Ventilate closed spaces before entering them.
- Stop the flow of material, if this is without risk. Dike the spilled material, where this is possible.
- **Large Spills:** Dike far ahead of spill for later disposal. Use a non-combustible material like vermiculite, sand or earth to soak up the product and place into a container for later disposal.
- **Small Spills:** Wipe up with absorbent material (e.g. cloth, fleece). Clean surface thoroughly to remove residual contamination.
- Never return spills in original containers for re-use.
- Neutralize spill area and washings with soda ash or lime. Collect in a non-combustible container for prompt disposal.
- J. T. Baker NEUTRASORB® acid neutralizers are recommended for spills of this product.

#### **Formalin/Formaldehyde**

- Ventilate area of leak or spill. Remove all sources of ignition.
- Wear appropriate personal protective equipment.
- Isolate hazard area. Keep unnecessary and unprotected personnel from entering. Contain and recover liquid when possible.
- Use non-sparking tools and equipment. Collect liquid in an appropriate container or absorb with an inert material (e. g., vermiculite, dry sand, earth), and place in a chemical waste container.
- Do not use combustible materials, such as saw dust.

### Inventory of Spill Kit supplies

Product Name	Amount	Chemicals it is useful against	Amount it can clean up	Notes
VWR Spill kit	1	-aldehydes		
Formalex	2 – 1 gal.	Formaldehyde cleanup (all concentrations)	1.5 gallons 1:1 control	Formalex will be used in conjunction with Fan-Pads to reduce total spill volume
Fan-Pads	1 roll (50 sheets)	Formaldehyde cleanup (all concentrations)	50 sheets=50-150 ml spills	Formalex will be used in conjunction with Fan-Pads to reduce total spill volume
3 M Pads	10 pads	Ethanol cleanup	10 pads=10-250 ml spills	Pads may be reused if dried out
Nitrile Gloves	4 pairs each S,M, L, XL	For all cleanup procedures	N/A	Gloves will be restocked by each survey group
Eye protection	4 pairs	Formaldehyde cleanup	N/A	Eye protection will be cleaned before reuse
Tyvex Lab Coats	2 coats	Formaldehyde cleanup	N/A	Coats will be cleaned with Fan-Pads and Formalex before reuse
Plastic Bags	2	Formaldehyde cleanup/Fan Pads	N/A	Bags may be packed full and sealed

#### D. Radioactive Materials

No Radioactive Isotopes are planned for this project.

#### E. Inventory (itemized) of Radioactive Materials – N/A

## V. Additional Projects

### A. Supplementary (“Piggyback”) Projects

#### Description:

1. Nutrient and dissolved oxygen sample analysis will be conducted on-board ship by scientists from PMEL.

#### Oxygen Measurements

The procedure is based on that of Carpenter. Winkler titrations will be conducted according to WOCE/CLIVAR protocols, and described in detail in GO\_SHIP Repeat Hydrography Manual, Report number 14, ICPO Publication Series No. 134, Version 1, 2010. On each cast, the number of samples and the depths sampled will depend on the oxygen profile from the CTD. In deep water, samples will be collected at every depth below 100 m. On the shelf, samples will usually be collected in the upper layer on one station and in the bottom layer on the next station. End point determinations of the Winkler titration will be determined by an amperometric method. Thiosulfate will be standardized for each batch of sample titrations, and blanks will be measured periodically during the project. Side by side comparison of this method with the photometric method show differences 0.06% or +/- 0.15 umol/kg. The automated amperometric titrator was designed by Chris Langdon at RSMAS in Miami.

2. Zooplankton collected with 505- $\mu$ m mesh (or possibly 150 - $\mu$ m mesh) nets at 3-4 stations will be analyzed for fatty acid genetics (**DY-15-09 Only**). Juvenile copepods (*C. marshallae*/glacialis C5 copepodids) will be live-sorted under a stereo microscope. The copepods will be individually photographed and either frozen (for lipid analysis), stored in RNAlater (non-toxic liquid used for RNA preservation), or utilized in a starvation (deckboard incubation) experiment. The starvation experiment will be set up as early as possible in the project. Copepods will be added to sixteen 1-L bottles (10-20 per bottle) and either fed natural phytoplankton (coarsely filtered surface seawater) or starved (finely filtered surface seawater) and placed in deckboard incubators cooled with surface seawater (either tanks used for jellyfish digestion experiments or tanks used for primary production experiments). Animals from two bottles per treatment (fed or starved) will be sampled at each of 4 time points (1, 3, 7, and 12 days, timing adjusted as needed based on logistics).

### B. NOAA Fleet Ancillary Projects

No NOAA Fleet Ancillary Projects are planned.

## VI. Disposition of Data and Reports

Disposition of data gathered aboard NOAA ships will conform to NAO 216-101 *Ocean Data Acquisitions* and NAO 212-15 *Management of Environmental Data and Information*. To guide the implementation of these NAOs, NOAA’s Environmental Data Management Committee (EDMC) provides the *NOAA Data Documentation Procedural Directive* (data documentation) and *NOAA Data Management Planning Procedural Directive* (preparation of Data Management Plans). OMAO is developing procedures and allocating resources to manage OMAO data and Programs are encouraged to do the same for their Project data.

- A. Data Classifications: *Under Development*
  - a. OMAO Data
  - b. Program Data
- B. Responsibilities: *Under Development*

## **VII. Meetings, Vessel Familiarization, and Project Evaluations**

- A. Pre-Project Meeting: The Chief Scientist and Commanding Officer will conduct a meeting of pertinent members of the scientific party and ship's crew to discuss required equipment, planned operations, concerns, and establish mitigation strategies for all concerns. This meeting shall be conducted before the beginning of the project with sufficient time to allow for preparation of the ship and project personnel. The ship's Operations Officer usually is delegated to assist the Chief Scientist in arranging this meeting.
- B. Vessel Familiarization Meeting: The Commanding Officer is responsible for ensuring scientific personnel are familiarized with applicable sections of the standing orders and vessel protocols, e.g., meals, watches, etiquette, drills, etc. A vessel familiarization meeting shall be conducted in the first 24 hours of the project's start and is normally presented by the ship's Operations Officer.
- C. Post-Project Meeting: The Commanding Officer is responsible for conducted a meeting no earlier than 24 hrs before or 7 days after the completion of a project to discuss the overall success and short comings of the project. Concerns regarding safety, efficiency, and suggestions for future improvements shall be discussed and mitigations for future projects will be documented for future use. This meeting shall be attended by the ship's officers, applicable crew, the Chief Scientist, and members of the scientific party and is normally arranged by the Operations Officer and Chief Scientist.
- D. Project Evaluation Report

Within seven days of the completion of the project, a Customer Satisfaction Survey is to be completed by the Chief Scientist. The form is available at <http://www.oma.noaa.gov/fleeteval.html> and provides a "Submit" button at the end of the form. Submitted form data is deposited into a spreadsheet used by OMAO management to analyze the information. Though the complete form is not shared with the ships', specific concerns and praises are followed up on while not divulging the identity of the evaluator.

## **VIII. Miscellaneous**

- A. Meals and Berthing

The ship will provide meals for the scientists listed above. Meals will be served 3 times daily beginning one hour before scheduled departure, extending throughout the project, and ending two

hours after the termination of the project. Since the watch schedule is split between day and night, the night watch may often miss daytime meals and will require adequate food and beverages (for example a variety of sandwich items, cheeses, fruit, milk, juices) during what are not typically meal hours. Special dietary requirements for scientific participants will be made available to the ship's command at least seven days prior to the project.

Berthing requirements, including number and gender of the scientific party, will be provided to the ship by the Chief Scientist. The Chief Scientist and Commanding Officer will work together on a detailed berthing plan to accommodate the gender mix of the scientific party taking into consideration the current make-up of the ship's complement. The Chief Scientist is responsible for ensuring the scientific berthing spaces are left in the condition in which they were received; for stripping bedding and linen return; and for the return of any room keys which were issued. The Chief Scientist is also responsible for the cleanliness of the laboratory spaces and the storage areas utilized by the scientific party, both during the project and at its conclusion prior to departing the ship.

All NOAA scientists will have proper travel orders when assigned to any NOAA ship. The Chief Scientist will ensure that all non NOAA or non Federal scientists aboard also have proper orders. It is the responsibility of the Chief Scientist to ensure that the entire scientific party has a mechanism in place to provide lodging and food and to be reimbursed for these costs in the event that the ship becomes uninhabitable and/or the galley is closed during any part of the scheduled project.

All persons boarding NOAA vessels give implied consent to comply with all safety and security policies and regulations which are administered by the Commanding Officer. All spaces and equipment on the vessel are subject to inspection or search at any time. All personnel must comply with OMAO's Drug and Alcohol Policy dated May 17, 2000 which forbids the possession and/or use of illegal drugs and alcohol aboard NOAA Vessels.

#### B. Medical Forms and Emergency Contacts

The NOAA Health Services Questionnaire (NHSQ, NF 57-10-01 (3-14)) must be completed in advance by each participating scientist. The NHSQ can be obtained from the Chief Scientist or the NOAA website <http://www.corporateservices.noaa.gov/noaaforms/eforms/nf57-10-01.pdf>.

All NHSQs submitted after March 1, 2014 must be accompanied by [NOAA Form \(NF\) 57-10-02](#) - Tuberculosis Screening Document in compliance with [OMAO Policy 1008](#) (Tuberculosis Protection Program).

The completed forms should be sent to the Regional Director of Health Services at the applicable Marine Operations Center. The NHSQ and Tuberculosis Screening Document should reach the Health Services Office no later than 4 weeks prior to the start of the project to allow time for the participant to obtain and submit additional information should health services require it, before clearance to sail can be granted. Please contact MOC Health Services with any questions regarding eligibility or completion of either form. Ensure to fully complete each form and

indicate the ship or ships the participant will be sailing on. The participant will receive an email notice when medically cleared to sail if a legible email address is provided on the NHSQ.

The participant can mail, fax, or email the forms to the contact information below. Participants should take precautions to protect their Personally Identifiable Information (PII) and medical information and ensure all correspondence adheres to DOC guidance ([http://ocio.os.doc.gov/ITPolicyandPrograms/IT\\_Privacy/PROD01\\_008240](http://ocio.os.doc.gov/ITPolicyandPrograms/IT_Privacy/PROD01_008240)).

The only secure email process approved by NOAA is [Accellion Secure File Transfer](#) which requires the sender to setup an account. [Accellion's Web Users Guide](#) is a valuable aid in using this service, however to reduce cost the DOC contract doesn't provide for automatically issuing full functioning accounts. To receive access to a "Send Tab", after your Accellion account has been established send an email from the associated email account to [accellionAlerts@doc.gov](mailto:accellionAlerts@doc.gov) requesting access to the "Send Tab" function. They will notify you via email usually within 1 business day of your approval. The "Send Tab" function will be accessible for 30 days.

Contact information:

Regional Director of Health Services  
Marine Operations Center – Pacific  
2002 SE Marine Science Dr.  
Newport, OR 97365  
Telephone 541-867-8822  
Fax 541-867-8856  
Email [MOP.Health-Services@noaa.gov](mailto:MOP.Health-Services@noaa.gov)

Prior to departure, the Chief Scientist must provide an electronic listing of emergency contacts to the Executive Officer for all members of the scientific party, with the following information: contact name, address, relationship to member, and telephone number.

#### C. Shipboard Safety

Hard hats are required when working with suspended loads. Work vests are required when working near open railings and during small boat launch and recovery operations. Hard hats and work vests will be provided by the ship when required.

Wearing open-toed footwear or shoes that do not completely enclose the foot (such as sandals or clogs) outside of private berthing areas is not permitted. At the discretion of the ship CO, safety shoes (i.e. steel or composite toe protection) may be required to participate in any work dealing with suspended loads, including CTD deployment and recovery. The ship does not provide safety-toed shoes/boots. The ship's Operations Officer should be consulted by the Chief Scientist to ensure members of the scientific party report aboard with the proper attire.

#### D. Communications

A progress report on operations prepared by the Chief Scientist may be relayed to the program office. Sometimes it is necessary for the Chief Scientist to communicate with another vessel, aircraft, or shore facility. Through various means of communications, the ship can usually



accommodate the Chief Scientist. Special radio voice communications requirements should be listed in the project instructions. The ship's primary means of communication with the Marine Operations Center is via email and the Very Small Aperture Terminal (VSAT) link. Standard VSAT bandwidth at 128kbs is shared by all vessels staff and the science team at no charge. Increased bandwidth in 30 day increments is available on the VSAT systems at increased cost to the scientific party. If increased bandwidth is being considered, program accounting is required and it must be arranged through the ship's Commanding Officer at least 30 days in advance.

#### E. IT Security

Any computer that will be hooked into the ship's network must comply with the *OMAO Fleet IT Security Policy* 1.1 (November 4, 2005) prior to establishing a direct connection to the NOAA WAN. Requirements include, but are not limited to:

- (1) Installation of the latest virus definition (.DAT) file on all systems and performance of a virus scan on each system.
- (2) Installation of the latest critical operating system security patches.
- (3) No external public Internet Service Provider (ISP) connections.

Completion of the above requirements prior to boarding the ship is required.

Non-NOAA personnel using the ship's computers or connecting their own computers to the ship's network must complete NOAA's IT Security Awareness Course within 3 days of embarking.

#### F. Foreign National Guests Access to OMAO Facilities and Platforms

Foreign National access to the NOAA ship or Federal Facilities is not required for this project.

### **VIII. Appendices**

1. Map of study area.
2. Station/Waypoint List (coordinates in Latitude, Longitude: degree-minutes).
3. Mooring schematics
4. Chemical inventory and spill response.

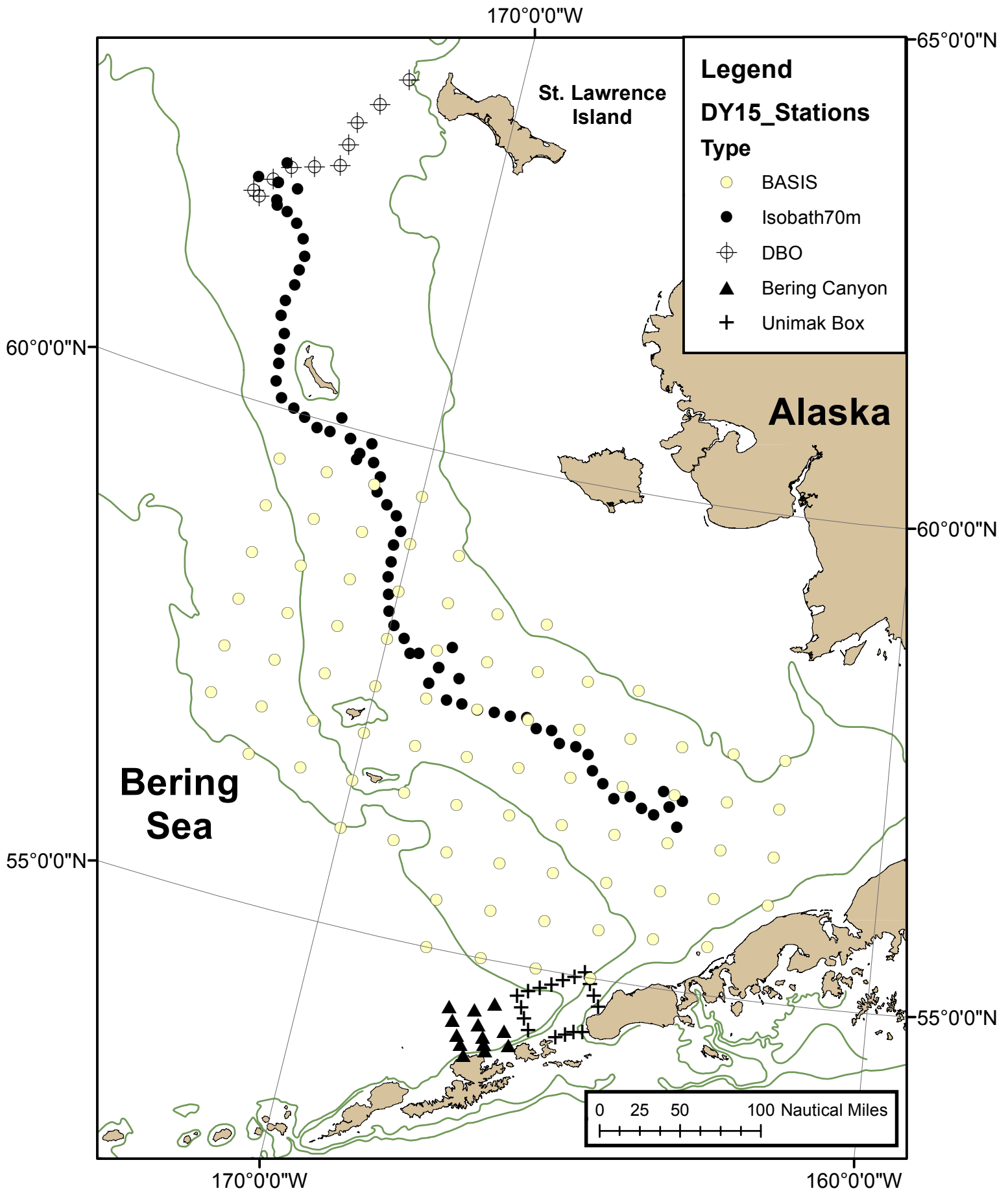

Type	StnID	Latdd	Londd	Lat Deg	Lon Min	Lon Deg	Lon Min	Operation	bottom depth
BASS	1	55.0000	-165.0000	55	0.00	-165	0.00	CTD/BON/TRAWL	
BASS	2	55.5000	-165.0000	55	30.00	-165	0.00	CTD/BON/TRAWL	
BASS	3	55.5000	-164.0000	55	30.00	-164	0.00	CTD/BON/TRAWL	
BASS	4	55.5000	-163.0000	55	30.00	-163	0.00	CTD/BON/TRAWL	
BASS	5	56.0000	-163.0000	56	0.00	-163	0.00	CTD/BON/TRAWL	
BASS	6	56.0000	-162.0000	56	0.00	-162	0.00	CTD/BON/TRAWL	
BASS	7	56.5000	-162.0000	56	30.00	-162	0.00	CTD/BON/TRAWL	
BASS	8	57.0000	-162.0000	57	0.00	-162	0.00	CTD/BON/TRAWL	
BASS	9	57.5000	-162.0000	57	30.00	-162	0.00	CTD/BON/TRAWL	
BASS	10	56.5000	-163.0000	56	30.00	-163	0.00	CTD/BON/TRAWL	
BASS	11	57.0000	-163.0000	57	0.00	-163	0.00	CTD/BON/TRAWL	
BASS	12	57.5000	-163.0000	57	30.00	-163	0.00	CTD/BON/TRAWL	
BASS	13	57.5000	-164.0000	57	30.00	-164	0.00	CTD/BON/TRAWL	
BASS	14	57.0000	-164.0000	57	0.00	-164	0.00	CTD/BON/TRAWL	
BASS	15	56.5000	-164.0000	56	30.00	-164	0.00	CTD/BON/TRAWL	
BASS	16	56.0000	-164.0000	56	0.00	-164	0.00	CTD/BON/TRAWL	
BASS	17	56.0000	-165.0000	56	0.00	-165	0.00	CTD/BON/TRAWL	
BASS	18	56.5000	-165.0000	56	30.00	-165	0.00	CTD/BON/TRAWL	
BASS	19	57.0000	-165.0000	57	0.00	-165	0.00	CTD/BON/TRAWL	
BASS	20	57.5000	-165.0000	57	30.00	-165	0.00	CTD/BON/TRAWL	
BASS	21	58.0000	-165.0000	58	0.00	-165	0.00	CTD/BON/TRAWL	
BASS	22	58.0000	-166.0000	58	0.00	-166	0.00	CTD/BON/TRAWL	
BASS	23	57.5000	-166.0000	57	30.00	-166	0.00	CTD/BON/TRAWL	
BASS	24	57.0000	-166.0000	57	0.00	-166	0.00	CTD/BON/TRAWL	
BASS	25	56.5000	-166.0000	56	30.00	-166	0.00	CTD/BON/TRAWL	
BASS	26	56.0000	-166.0000	56	0.00	-166	0.00	CTD/BON/TRAWL	
BASS	27	55.5000	-166.0000	55	30.00	-166	0.00	CTD/BON/TRAWL	
BASS	28	55.0000	-166.0000	55	0.00	-166	0.00	CTD/BON/TRAWL	
BASS	29	55.0000	-167.0000	55	0.00	-167	0.00	CTD/BON/TRAWL	
BASS	30	55.5000	-167.0000	55	30.00	-167	0.00	CTD/BON/TRAWL	
BASS	31	56.0000	-167.0000	56	0.00	-167	0.00	CTD/BON/TRAWL	
BASS	32	56.5000	-167.0000	56	30.00	-167	0.00	CTD/BON/TRAWL	
BASS	33	57.0000	-167.0000	57	0.00	-167	0.00	CTD/BON/TRAWL	
BASS	34	57.5000	-167.0000	57	30.00	-167	0.00	CTD/BON/TRAWL	
BASS	35	58.0000	-167.0000	58	0.00	-167	0.00	CTD/BON/TRAWL	
BASS	36	58.5000	-167.0000	58	30.00	-167	0.00	CTD/BON/TRAWL	
BASS	37	58.5000	-168.0000	58	30.00	-168	0.00	CTD/BON/TRAWL	
BASS	38	58.0000	-168.0000	58	0.00	-168	0.00	CTD/BON/TRAWL	
BASS	39	57.5000	-168.0000	57	30.00	-168	0.00	CTD/BON/TRAWL	
BASS	40	57.0000	-168.0000	57	0.00	-168	0.00	CTD/BON/TRAWL	
BASS	41	56.5000	-168.0000	56	30.00	-168	0.00	CTD/BON/TRAWL	
BASS	42	56.0000	-168.0000	56	0.00	-168	0.00	CTD/BON/TRAWL	
BASS	43	55.5000	-168.0000	55	30.00	-168	0.00	CTD/BON/TRAWL	
BASS	44	55.0000	-168.0000	55	0.00	-168	0.00	CTD/BON/TRAWL	
BASS	45	56.0000	-169.0000	56	0.00	-169	0.00	CTD/BON/TRAWL	
BASS	46	56.5000	-169.0000	56	30.00	-169	0.00	CTD/BON/TRAWL	
BASS	47	57.0000	-169.0000	57	0.00	-169	0.00	CTD/BON/TRAWL	
BASS	48	57.5000	-169.0000	57	30.00	-169	0.00	CTD/BON/TRAWL	
BASS	49	58.0000	-169.0000	58	0.00	-169	0.00	CTD/BON/TRAWL	
BASS	50	58.5000	-169.0000	58	30.00	-169	0.00	CTD/BON/TRAWL	
BASS	51	59.0000	-169.0000	59	0.00	-169	0.00	CTD/BON/TRAWL	
BASS	52	59.5000	-170.0000	59	30.00	-170	0.00	CTD/BON/TRAWL	
BASS	53	59.0000	-170.0000	59	0.00	-170	0.00	CTD/BON/TRAWL	
BASS	54	58.5000	-170.0000	58	30.00	-170	0.00	CTD/BON/TRAWL	
BASS	55	58.0000	-170.0000	58	0.00	-170	0.00	CTD/BON/TRAWL	
BASS	56	57.5000	-170.0000	57	30.00	-170	0.00	CTD/BON/TRAWL	
BASS	57	57.0000	-170.0000	57	0.00	-170	0.00	CTD/BON/TRAWL	
BASS	58	56.5000	-170.0000	56	30.00	-170	0.00	CTD/BON/TRAWL	
BASS	59	56.0000	-170.0000	56	0.00	-170	0.00	CTD/BON/TRAWL	
BASS	60	56.5000	-171.0000	56	30.00	-171	0.00	CTD/BON/TRAWL	
BASS	61	57.0000	-171.0000	57	0.00	-171	0.00	CTD/BON/TRAWL	
BASS	62	57.5000	-171.0000	57	30.00	-171	0.00	CTD/BON/TRAWL	
BASS	63	58.0000	-171.0000	58	0.00	-171	0.00	CTD/BON/TRAWL	
BASS	64	58.5000	-171.0000	58	30.00	-171	0.00	CTD/BON/TRAWL	
BASS	65	59.0000	-171.0000	59	0.00	-171	0.00	CTD/BON/TRAWL	
BASS	66	59.5000	-171.0000	59	30.00	-171	0.00	CTD/BON/TRAWL	
BASS	67	59.5000	-172.0000	59	30.00	-172	0.00	CTD/BON/TRAWL	
BASS	68	59.0000	-172.0000	59	0.00	-172	0.00	CTD/BON/TRAWL	
BASS	69	58.5000	-172.0000	58	30.00	-172	0.00	CTD/BON/TRAWL	
BASS	70	58.0000	-172.0000	58	0.00	-172	0.00	CTD/BON/TRAWL	
BASS	71	57.5000	-172.0000	57	30.00	-172	0.00	CTD/BON/TRAWL	
BASS	72	57.0000	-172.0000	57	0.00	-172	0.00	CTD/BON/TRAWL	
BASS	73	56.5000	-172.0000	56	30.00	-172	0.00	CTD/BON/TRAWL	
BASS	74	57.0000	-173.0000	57	0.00	-173	0.00	CTD/BON/TRAWL	
BASS	75	57.5000	-173.0000	57	30.00	-173	0.00	CTD/BON/TRAWL	
BASS	76	58.0000	-173.0000	58	0.00	-173	0.00	CTD/BON/TRAWL	
BASS	77	58.5000	-173.0000	58	30.00	-173	0.00	CTD/BON/TRAWL	
BASS	78	59.0000	-173.0000	59	0.00	-173	0.00	CTD/BON/TRAWL	
BASS	79	59.5000	-173.0000	59	30.00	-173	0.00	CTD/BON/TRAWL	
DBO	DB01.1	62.0100	-175.0600	62	0.60	-175	3.60	ADCF/ROS/NET/MUD* <sup>S</sup>	
DBO	DB01.2	62.0500	-175.2100	62	3.00	-175	12.60	ADCF/ROS/NET/MUD* <sup>S</sup>	
DBO	DB01.3	62.2100	-174.8700	62	13.14	-174	52.61	CTD	
DBO	DB01.4	62.3900	-174.5700	62	23.40	-174	34.20	ADCF/ROS/NET/MUD* <sup>S</sup>	
DBO	DB01.5	62.4600	-174.0800	62	28.68	-174	4.98	CTD	
DBO	DB01.6	62.5600	-173.5500	62	33.60	-173	33.60	ADCF/ROS/NET/MUD* <sup>S</sup>	
DBO	DB01.7	62.7870	-173.5000	62	47.22	-173	30.00	CTD	
DBO	DB01.8	63.0300	-173.4600	63	1.80	-173	27.60	ADCF/ROS/NET/MUD* <sup>S</sup>	
DBO	DB01.9	63.2800	-173.0800	63	16.80	-173	4.80	CTD	
DBO	DB01.10	63.6040	-172.5910	63	36.24	-172	35.46	CTD	
Iobath70m	M2-S	56.6667	-168.8670	56	40.0002	-168	52.02	CTD/BON	76
Iobath70m	M2-W	56.7667	-164.3338	56	46.0002	-164	20.02	CTD/BON	74
Iobath70m	70M3	56.8087	-164.583333	56	48.52	-164	34.9988	CTD/BON	74
Iobath70m	70M5	56.8597	-165.1215	56	51.58	-165	7.29	CTD/BON	74
M2/15884-2A		56.8666	-164.0099	56	52.00	-164	3.00	Surface Mooring	73.00
M2/15884-2A		56.8667	-164.0667	56	52.00	-164	4.00	Subsurface Mooring	73.00
Iobath70m	70M2/M2	56.8670	-164.0690	56	52.02	-164	4.14	CTD/BON	72
Iobath70m	70M2/M2	56.8670	-164.0690	56	52.02	-164	4.14	3 C/VeTs	72
Iobath70m	70M4	56.9095	-164.8275	56	54.57	-164	49.65	CTD	72
Iobath70m	M2-E	56.9452	-163.8277	56	56.71	-163	49.96	CTD/BON	72
Iobath70m	70M6	56.9938	-165.3775	56	59.57	-165	23.65	CTD	72
Iobath70m	M2-N	57.01667	-164.21667	57	1.0002	-164	13.0002	CTD/BON	69
Iobath70m	70M7	57.1070	-165.6150	57	6.42	-165	36.90	CTD/BON	71
Iobath70m	70M8	57.2627	-165.7465	57	15.76	-165	44.70	CTD	70
Iobath70m	70M9	57.3217	-166.0097	57	19.30	-166	0.58	CTD/BON	71
Iobath70m	70M10	57.32233	-166.32833	57	19.3888	-166	19.5798	CTD	71
Iobath70m	70M12	57.4290	-166.8120	57	25.14	-166	48.20	CTD	71
Iobath70m	70M11	57.438	-166.5125	57	26.28	-166	30.75	CTD	71
Iobath70m	70M14	57.4988	-167.34417	57	29.93	-167	20.6502	CTD	71
Iobath70m	70M16	57.50067	-167.98617	57	30.0402	-167	59.1702	CTD	71
Iobath70m	70M15	57.50117	-167.6653	57	30.0702	-167	39.92	CTD/BON	72
Iobath70m	70M17	57.5208	-168.3063	57	31.25	-168	18.38	CTD/BON	72
Iobath70m	70M13	57.52233	-167.08117	57	31.3888	-167	2.2802	CTD/BON	70
Iobath70m	70M18	57.52445	-168.6135	57	31.47	-168	36.81	CTD	72
Iobath70m	70M19/M4-S	57.653	-169.02	57	39.18	-169	1.2	CTD/BON	70
Iobath70m	M4-E	57.7653	-168.4652	57	43.92	-168	27.91	CTD/BON	72
M4/1485-4B		57.8863	-168.4681	57	49.58	-168	52.99	Subsurface Mooring	70.00
M4/1485-4A		57.8333	-168.8791	57	26.00	-168	52.75	Subsurface Mooring	70.00
Iobath70m	70M21/M4	57.8330	-168.8920	57	49.98	-168	53.52	CTD/BON	72
Iobath70m	70M21/M4	57.8330	-168.8920	57	49.98	-168	53.52	3 C/VeTs	72
Iobath70m	M4-W	57.9280	-169.322	57	55.68	-169	19.32	CTD/BON	68
Iobath70m	70M23	57.9088	-168.5013	57	54.53	-169	30.06	CTD	70
Iobath70m	M4-N	58.0662	-168.7902	58	3.07	-168	43.57	CTD/BON	71
Iobath70m	70M24	58.04217	-169.6727	58	2.5302	-169	40.36	CTD/BON	72
Iobath70m	70M25	58.14717	-169.9317	58	8.8302	-169	55.0902	CTD	72
Iobath70m	70M26	58.2850	-170.0028	58	16.92	-170	5.57	CTD/BON	72
Iobath70m	70M27	58.4455	-170.18567	58	26.73	-170	11.1402	CTD	74
Iobath70m	70M28	58.6165	-170.2755	58	36.99	-170	16.51	CTD/BON	73
Iobath70m	70M29	58.7843	-170.29167	58	46.4598	-170	17.6202	CTD	72
Iobath70m	70M30	58.94833							

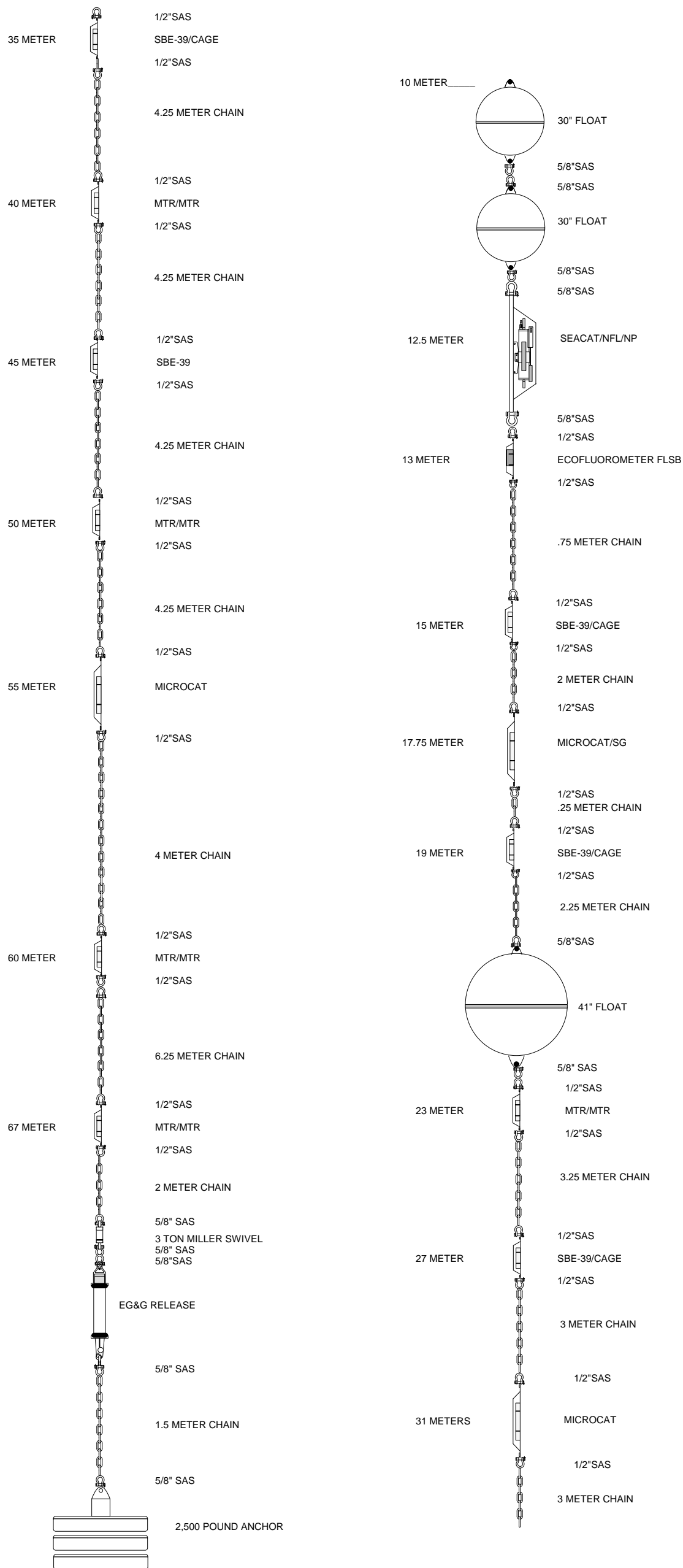

SUBSURFACE INSTRUMENTS		
DEPTH (M)	INST.	SER #
12.5	SEACAT/NFL/NP	
13	Eco-Flour FLSB	
15	SBE-39	
17.75	MicroCat/sg	
19	SBE-39	
23	MTR/MTR	
27	SBE-39	
31	MICROCAT	
35	SBE-39	
40	MTR/MTR	
45	SBE-39	
50	MTR/MTR	
55	MICROCAT	
60	MTR/MTR	
67	MTR/MTR	
72	BOTTOM	



**NOAA-PMEL-FOCI**  
 7600 Sandpoint Way NE  
 Seattle, Wa. 98115  
 (206) 526-6175

**MOORING:** 14BS-4B  
**LOCATION:** BERING SEA, SITE 4

DESIGN BY: MIKE CRAIG	DATE: 11 JULY 2014
DRAWN BY:	DATE:



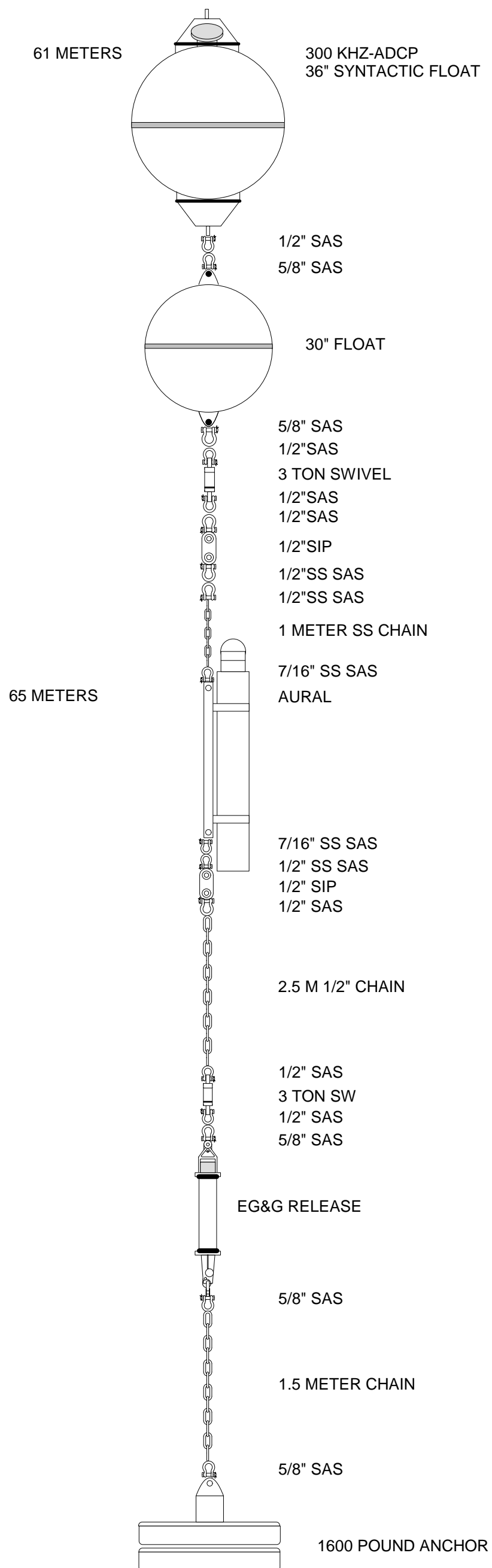



INSTRUMENT	DEPTH M	SERIAL NO.
300 kHz ADCP	61	
AURALS	65	
BOTTOM	72	
 NOAA-PMEL-FOCI 7600 Sandpoint Way NE Seattle, Wa. 98115 (206) 526-6175		
MOORING:	14BSP-4A	
LOCATION:	BERING SEA SITE 4	
DESIGN BY: MIKE CRAIG	DATE: 13 MAY 2014	
DRAWN BY:	DATE:	

59 METERS

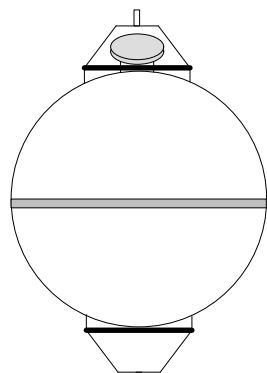

300 KHZ-ADCP  
36" SYNTACTIC FLOAT

1/2" SAS  
5/8" SAS

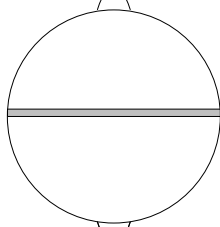

30" FLOAT

5/8" SAS  
1/2" SAS  
3 TON SWIVEL  
1/2" SAS  
1/2" SAS  
1/2" SIP  
1/2" SS SAS  
1/2" SS SAS  
1 METER STAINLESS STEEL CHAIN

63 METERS

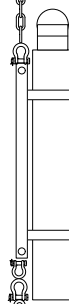

7/16" SS SAS

AURAL

7/16" SS SAS  
1/2" SS SAS

.75 METER 1/2" SS CHAIN

1/2" SS SAS  
3/4" SS SAS

65 METERS

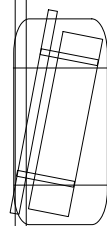

AWCP

3/4" SS SAS  
1/2" SS SAS  
1/2" SIP  
1/2" SAS  
5/8" SAS

67 METERS

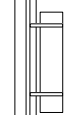

PAL

5/8" SAS  
1/2" SAS  
3 TON SWIVEL  
1/2" SAS  
5/8" SAS

EG&G 8242 RELEASE

RELEASE LINK  
5/8" SAS

1.5 METER 1/2" CHAIN

5/8" SAS

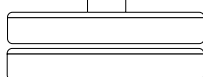

1600 POUND ANCHOR

INSTRUMENT	DEPTH M	SERIAL NO.
300 KHZ ADCP	59	
AURAL	63	
AWCP	65	
PAL	67	
BOTTOM	70	



**NOAA-PMEL-FOCI**  
7600 Sandpoint Way NE  
Seattle, Wa. 98115  
(206) 526-6180

**MOORING:** 14BSP-5A

**LOCATION:** BERING SEA, SITE 5

**DRAWN BY:** Mike Craig **DATE:** 12 MAY 2014

**APPROVED BY:** **DATE:**



61 METERS

300 KHZ-ADCP  
36" SYNTACTIC FLOAT

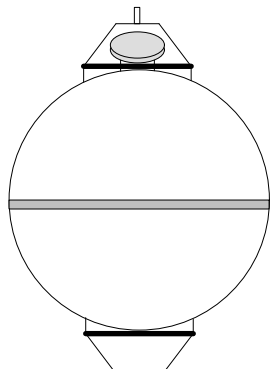

1/2" SAS  
5/8" SAS

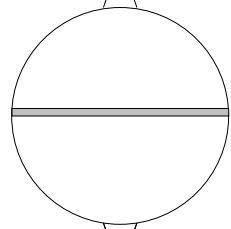

30" FLOAT

5/8" SAS  
1/2" SAS  
3 TON SWIVEL  
1/2" SAS  
1/2" SAS  
1/2" SIP  
1/2" SS SAS  
1/2" SS SAS  
1 METER STAINLESS STEEL CHAIN

64 METERS

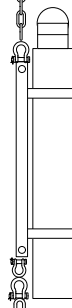

7/16" SS SAS

AURAL

7/16" SS SAS  
1/2" SS SAS

.75 METER 1/2" SS CHAIN

1/2" SS SAS  
3/4" SS SAS

66 METERS

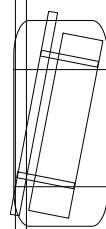

AWCP

3/4" SS SAS  
1/2" SS SAS  
1/2" SIP  
1/2" SAS

1 METER CHAIN

1/2" SAS  
3 TON SWIVEL  
1/2" SAS  
5/8" SAS

ORE 8242 RELEASE

5/8" SAS

1.5 METER CHAIN

5/8" SAS



1600 POUND ANCHOR

INSTRUMENT	DEPTH M	SERIAL NO.
300 KHZ ADCP	61	
AURAL	64	
AWCP	66	
BOTTOM	71	

 <b>NOAA-PMEL-FOCI</b> 7600 Sandpoint Way NE Seattle, Wa. 98115 (206) 526-6175	
<b>MOORING:</b>	<b>14BSP-8A</b>
<b>LOCATION:</b>	<b>BERING SEA, SITE 8</b>
<b>Mike Craig</b>	<b>DATE: 12 MAY 2014</b>
<b>APPROVED BY:</b>	<b>DATE:</b>

## Records for Mooring: 15BSM-2A

### Deployment

Cruise Number: **DY1504**

Deployment Date/Time (GMT):  
**2015-05-01 04:57:39**

GPS latitude: **56 51.995 N**

GPS longitude: **164 2.996 W**

CTD cast no: **CTD022**

Actual Deployment Depth (m): **0**

Timekeeper: **Peter Proctor**

Chief Scientist: **Peter Proctor**

### Recovery

Cruise Number:

Recovery Date/Time (GMT):

GPS latitude:

GPS longitude:

CTD cast no:

Timekeeper:

Chief Scientist:

### Pre-Deployment

Estimated latitude (N): **56 52.0 N**

Estimated longitude (W): **164 3.0 W**

Estimated Deployment depth: **72**

Estimated Recovery Date: **2015-10-01**

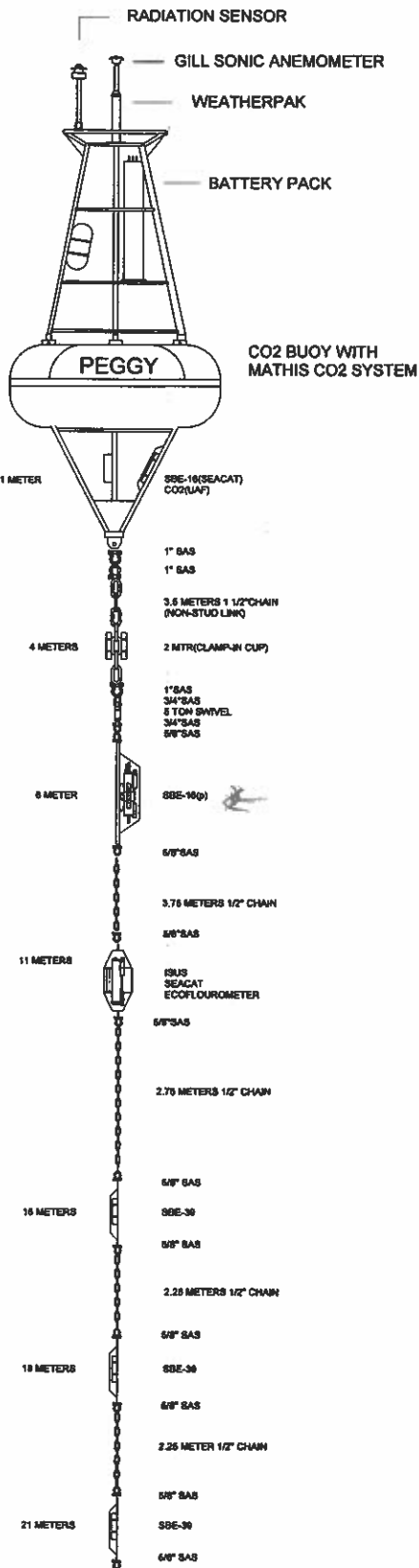

NO LOOSE OR UNSUPPORTED CHAIN OR  
HARDWARE ON THIS MOORING.  
SUBSURFACE AURAL NEARBY.  
ANCHOR DEPLOY CHAIN OK

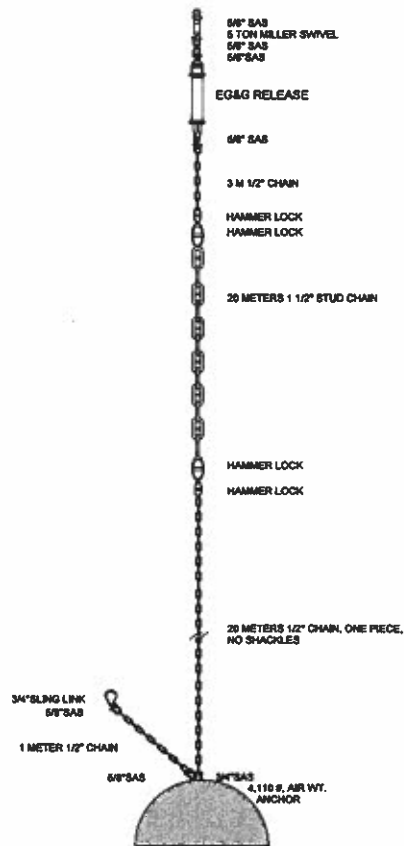
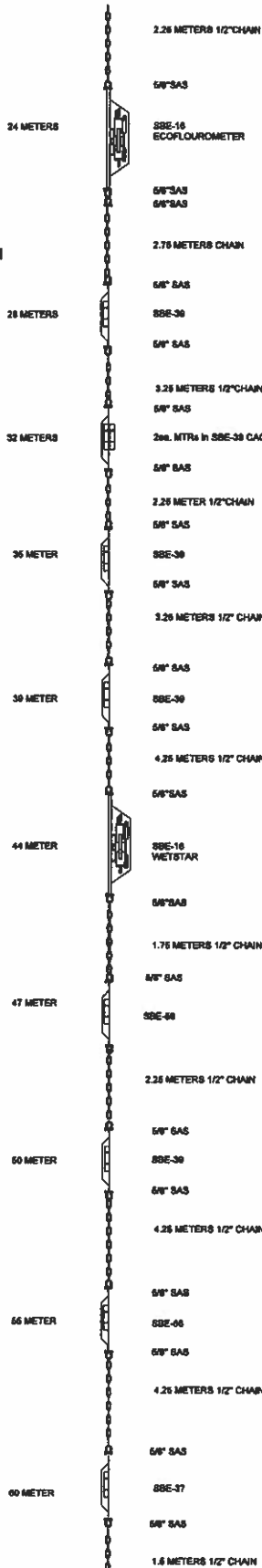

SCOPE 1:1.5		
SURFACE INSTRUMENTS		
INST	SER #	
WEATHERPAK		
GILL SONIC		
LinkQuest Mod		
DCU Iridium		
EPPLEY RADIATION		
SUBSURFACE INSTRUMENTS		
DEPTH (M)	INST.	SER #
1	MICROCAT	
1	ISUS	
4	MTR	
4	MTR	
6	SBE-16(P)	
11	ISUS	
11	SBE-16	
11	ECOFLOUR	
15	SBE-39	
18	SBE-39	
21	SBE-39	
24	SBE-16	
24	ECOFLOUR	
28	SBE-39	
32	MTR	
32	MTR	
35	SBE-39	
39	SBE-39	
44	SBE-16	
44	WETSTAR	
47	SBE-56	
50	SBE-39	
55	SBE-56	
60	SBE-37	
	AC.REL.	
72	BOTTOM	
<b>NOAA-PMEL-FOCI</b> 7600 Sandpoint Way NE Seattle, Wa. 98115 (206) 626-6189		
MOORING:	15BSM-2A	
LOCATION:	BERING SEA	
DRAWN BY:	MIKE CRAIG	DATE: 9 MARCH 2014
APPROVED BY:		DATE:

## Records for Mooring: 15BSP-2A

### Deployment

Cruise Number: **DY1504**

Deployment Date/Time (GMT):  
**2015-05-02 04:33:00**

GPS latitude: **56 52.00 N**

GPS longitude: **164 04.00 W**

CTD cast no: **CTD027**

Actual Deployment Depth (m): **73**

Timekeeper: **Peter Proctor**

Chief Scientist: **Peter Proctor**

### Recovery

Cruise Number:

Recovery Date/Time (GMT):

GPS latitude:

GPS longitude:

CTD cast no:

Timekeeper:

Chief Scientist:

### Pre-Deployment

Estimated latitude (N): **56 52 N**

Estimated longitude (W): **164 4 W**

Estimated Deployment depth: **72**

Estimated Recovery Date: **2015-10-01**

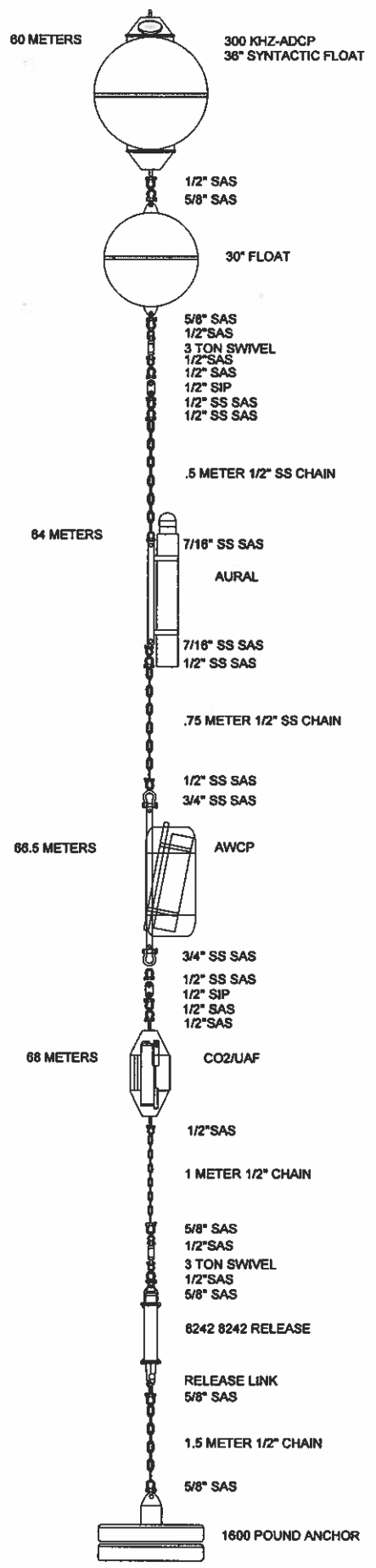

INSTRUMENT	DEPTH M	SERIAL NO.
300 KHZ ADCP	60	
AURAL	64	
AWCP	66.5	UAF
UAF/CO2	68	
BOTTOM	72	

**NOAA-PMEL-FOCI**  
7600 Sandpoint Way NE  
Seattle, Wa. 98115  
(206) 526-6180

**MOORING:** 15BSP-2A

**LOCATION:**

**DRAWN BY:** MIKE CRAIG      **DATE:** 7 APRIL 2015

**APPROVED BY:**                      **DATE:**

Common Name	Amount	Respondee	Spill Response
Formaldehyde 37%	2 - 20 l, 1 - 15 l	Chief Scientist	Gloves Eye Protection Fan-Pads Formalex Plastic Bag
Ethyl Alcohol 100% Genetic Grade	2 - 4 l, 1 - 0.75 l	Chief Scientist	Gloves 3M Sorbent Pads Plastic bag
Sodium Borate Solution, Saturated 5-6%	1 - 20 l	Chief Scientist	Gloves Paper towels Plastic bag
Sodium Borate Powder	1 - 500 g	Chief Scientist	Gloves Wet paper towels Plastic Bag
3M Manganese chloride	2 - 500ml = 1000ml	Peter Proctor	Gloves Plastic Bag Broom/dustpan Absorbant (kitty litter)
4M Sodium iodide/8M Sodium hydroxide	2 - 500ml = 1000ml	Peter Proctor	Gloves Plastic Bag Broom/dustpan Base neutralizer Absorbant (kitty litter)
5M Sulfuric acid	2 - 500ml = 1000ml	Peter Proctor	Gloves Plastic Bag Broom/dustpan Acid neutralizer Absorbant (kitty litter)
0.16M Sodium thiosulfate	2 - 500ml = 1000ml	Peter Proctor	Gloves

0.0016M Potassium iodate	2 - 500ml = 1000ml	Peter Proctor	Plastic Bag Broom/dustpan Absorbant (kitty litter) Gloves Plastic Bag Broom/dustpan
Decontamination Concentrate Solution 5.25%	40ml	Lisa Eisner	Spill control A
Bacteriostatic Concentrate Solution	36ml	Lisa Eisner	Spill control A
Extended Flow Cell Clean 5%	8ml	Lisa Eisner	Spill control A
Citric Acid, anhydrous > 99%	25g	Lisa Eisner	Spill control A
Potassium Nitrate 15N	1mg	Lisa Eisner	Gloves Plastic Bag Broom/dustpan

### **SPILL CONTROL**

#### **A: ACID**

- Wear appropriate protective equipment and clothing during clean-up. Keep upwind. Keep out of low areas.
- Ventilate closed spaces before entering them.
- Stop the flow of material, if this is without risk. Dike the spilled material, where this is possible.
- Large Spills:** Dike far ahead of spill for later disposal. Use a non-combustible material like vermiculite, sand or earth to soak up the product and place into a container for later disposal.
- Small Spills:** Wipe up with absorbent material (e.g. cloth, fleece). Clean surface thoroughly to remove residual contamination.
- Never return spills in original containers for re-use.
- Neutralize spill area and washings with soda ash or lime. Collect in a non-combustible container for prompt disposal.
- J. T. Baker NEUTRASORB® acid neutralizers are recommended for spills of this product.

Notes

Dyson loaded 2/4/2014, working volume for all Spring and Fall projects. MSDS, hygiene plan, and SOPs provided at time of loading.

Loaded 2/4/2014, working volume for all Spring and Fall projects.

Loaded 2/4/2014, not a regulated chemical

Loaded 2/4/2014, not a regulated chemical (in spill kit)

On board

On board

On board

On board



On board

For use in cleaning flow cytometer.  
Store in Chem lab cabinets

For use in cleaning flow cytometer.  
Store in Chem lab cabinets

For use in cleaning flow cytometer.  
Store in Chem lab cabinets

For use in cleaning flow cytometer.  
Store in Chem lab cabinets

For Primary Production expts. Store  
in Chem lab cabinets