

SHORELINE EROSION IN VIRGINIA



Scott Hardaway
Gary Anderson

GC
57.2
.V515
no. 31

SEA GRANT PROGRAM
Marine Advisory Service

Virginia Institute of Marine Science
College of William and Mary
Gloucester Point, Virginia 23062

*Copies of this publication may be ordered
for \$1.00 each from the Sea Grant Communications Office,
Virginia Institute of Marine Science, Gloucester Point, VA 23062*

16006

Virginia Institute of Marine Science Sea Grant
Program

GC57.2 .V515 no. 31
7802463

OCT 23 1987

SHORELINE EROSION IN VIRGINIA

SCOTT HARDAWAY
GARY ANDERSON

Virginia Institute of Marine Science
Gloucester Point, VA 23062

Property of CSC Library

U. S. DEPARTMENT OF COMMERCE NOAA
COASTAL SERVICES CENTER
2234 SOUTH HOBSON AVENUE
CHARLESTON, SC 29405-2413

Designed and Edited by Kevin Gray

October 1980

A Sea Grant Advisory Service of the
College of William and Mary

Educational Series No. 31

ACKNOWLEDGEMENTS

This publication is the result of research sponsored by the Virginia Institute of Marine Science Institutional Sea Grant Program, supported by the Office of Sea Grant.

Thanks go to Jean Belvin and Cynthia Gaskins for typing the numerous drafts. Special appreciation goes to Cheryl Teagle for composing the final manuscript.

TABLE OF CONTENTS

SHORELINE EROSION IN VIRGINIA	1
CAUSE	1
EFFECT	3
SHORELINE VARIABLE.....	4
COASTAL PROCESSES	5
WIND AND WAVES.....	5
CURRENTS	5
BEACH.....	5
SHORE TYPES.....	5
SEDIMENT BANKS	6
MARSH SHORELINES.....	7
BARRIER BEACHES AND SPITS	8
MAN MODIFIED	9
SHORE PROTECTION METHODS	11
VERTICAL RETAINING STRUCTURES (Bulkheads, Seawalls and Revetments)	12
GROINS AND JETTIES.....	14
BREAKWATERS (Solid and Floating)	15
SUBMERGED SILL	15
DESIGN CONSIDERATIONS.....	16
RIPRAP REVETMENTS.....	16
BULKHEADS.....	17
GABION REVETMENT	18
GROINS AND JETTIES.....	18
SUBMERGED SILL	19
BREAKWATERS	19
VEGETATIVE CONTROL	21
MARSH GRASS	22
RIVERBANK SLOPE CONTROL.....	22

INTRODUCTION

Virginia has over 5,000 miles of tidal shoreline. Several different shore types occur in the Tidewater region including the low-lying barrier islands of the Eastern Shore, the ocean front headland-barrier spit of southeastern Virginia, and the shores of the Chesapeake Bay and other estuaries which range from high bluffs to tidal marshes. In order to put shore erosion in proper perspective as a natural phenomenon, one must examine the recent geologic history of the region.

Much of shoreline erosion is a direct product of high energy storms like hurricanes and northeasters. The rate and amount of erosion along a specific shoreline may vary from year to year. The rate of erosion will depend upon the following factors: (1) storm frequency; (2) storm type and direction; (3) storm intensity and duration; and (4) resulting wind tides, currents, and waves. Also, the presence of man-made structures (bulkheads, groins, etc.) will modify the erosion process, increasing or decreasing it to a degree depending on the type, location, design, etc., of the structure (O'Connor, et al., 1978).

The problem of shoreline erosion is most acute when coastal property with improvements is threatened by a rapidly receding shore bank. Many waterfront properties are bought and developed each year with little or no consideration of the shoreline situation. Consequently, additional money must be spent for erosion protection structures.

Shoreline protection structures must be adequately designed and correctly placed to be effective under the severest of storm conditions. Inadequate installation or design may result in failure or deleterious effects to adjacent waterfront properties. In many cases a structure is not needed and protection of a shore bank may be accomplished by vegetative means, such as the planting of appropriate grasses, shrubs or vines to stabilize the bank, beach or nearshore area.

Virginia's coast is a dynamic and active environment as well as a beautiful place to live. Sound judgement in coastal development is essential to effective control of shoreline erosion.

-C. Scott Hardaway

SHORELINE EROSION IN VIRGINIA

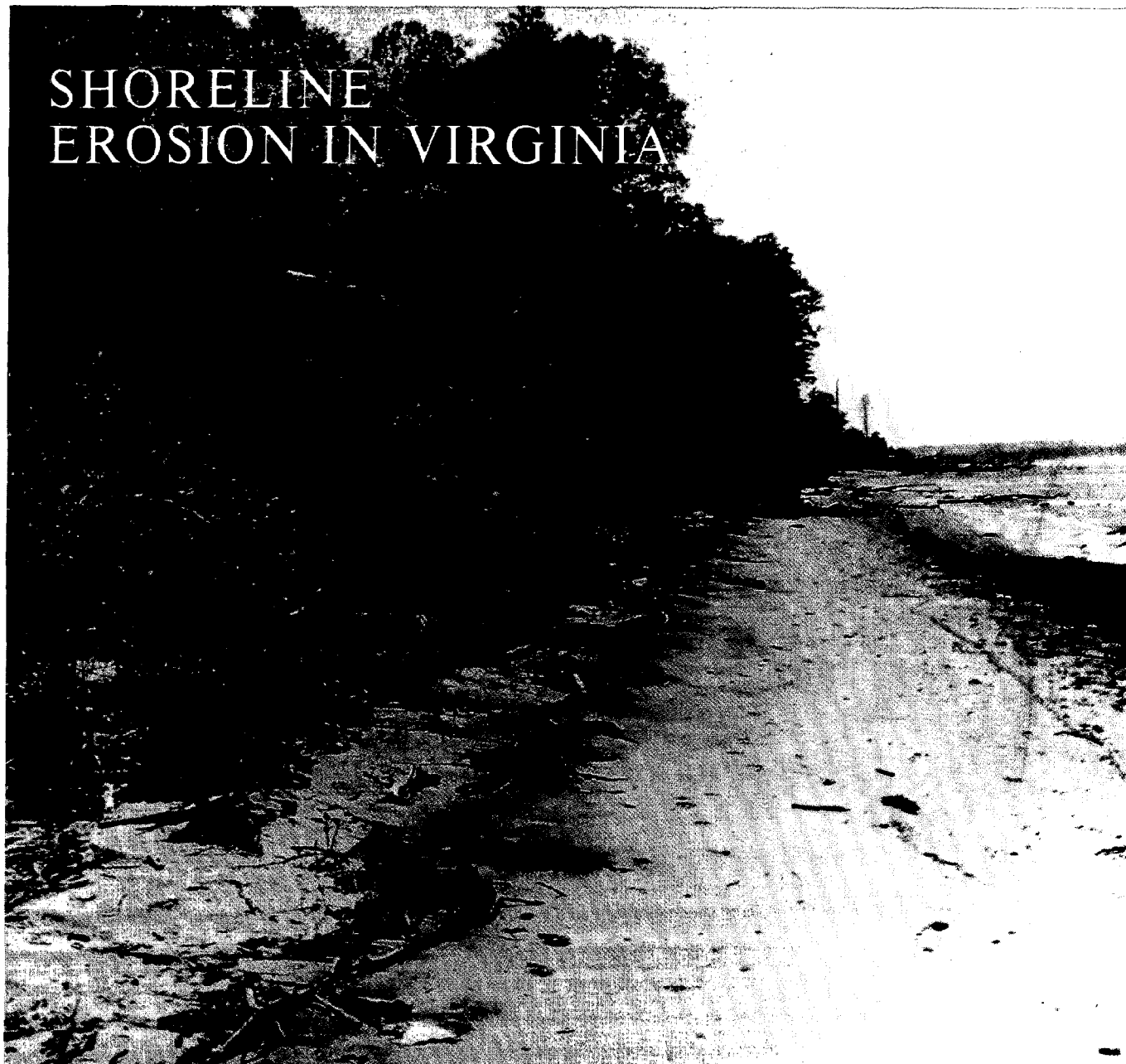

THE CAUSE

The Chesapeake Bay and its tributaries are drowned river valleys of the ancestral Susquehanna River system (Figure 1). Drowned river valleys where seawater from the ocean and freshwater from upland rivers mix freely are called estuaries. The circulation in the estuaries is influenced by the astronomical tidal conditions, the amount of fresh water run-off and the shape of the basin.

The Chesapeake Bay and its

tributary estuaries are a geologically young portion of the Virginia coastal system. About 15,000 years ago, the ocean shoreline was about 60 miles east of the Virginia Capes and sea level was some 300 feet lower than it is today. Much of the ocean's water was locked up in the great ice sheets which covered the northern half of North America during the Late Pleistocene glacial epoch. As the glaciers began to melt and recede in response to a gradually warming climate, the

melt waters began to raise the level of the oceans. The rising sea level caused the shoreline and coastal system to slowly migrate upward and westward across the continental shelf. Today's estuaries are formed as the rising sea level floods the topographically low river and stream valleys. As sea level continues to rise, the coastal lands of Virginia continue to flood.

The process of shoreline migration is better known as shoreline erosion. In the estuaries of

Figure 1 — Chesapeake Bay and its tributaries.

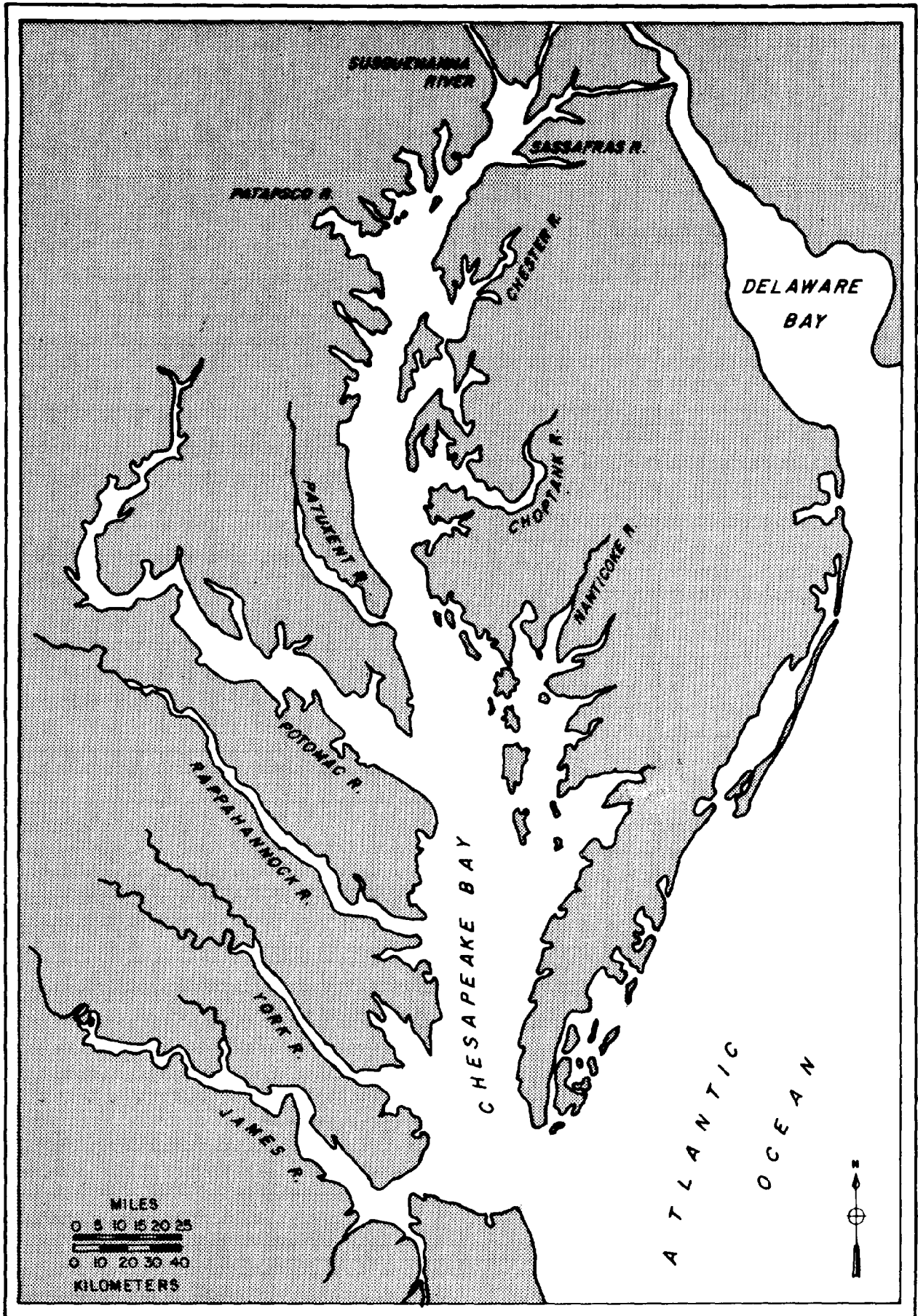

Virginia, shoreline erosion is a continuing process which has been operating for several thousand years. Rates of erosion are dependent upon specific shoreline variables and varying storm conditions, according to location. Locally, a shoreline may appear stable or actually accrete sediments. However, such a situation is anomalous and is usually short-lived.

Shoreline erosion on a daily basis is minimal. Severe erosion occurs during periods of high energy storms such as northeasters and hurricanes. Therefore, the rate of erosion at any specific location depends upon the following conditions (Riggs, et al., 1978):

1. Storm frequency
2. Storm type and direction
3. Storm intensity and duration
4. Resulting wind tides, current and wave storm surge

Seasonal wind patterns vary in the Chesapeake Bay region. From late fall to spring the dominant wind direction is from the north and northwest. During the late spring, the dominant wind shifts to the southwest and continues so until the following fall. Northeast storms which occur from late fall to early spring are associated with eastward moving storm fronts. Frequently there is a period of intense north or northeast winds following the passage of the front. Hurricanes can occur from mid-summer to late fall. Hurricanes are less frequent than other storms but sustained winds of 74 knots and wave heights of over five feet make hurricanes an unwelcome visitor to waterfront property owners.

EFFECT

There are over 5,000 miles of shoreline along the Virginia portion of Chesapeake Bay and its tributaries. The major tributaries are the James, York, Rappahannock and Potomac Rivers. The

TABLE 1.
AVERAGE SHORELINE EROSION RATES - TIDEWATER VIRGINIA

YORK RIVER		
NORTH SIDE	EROSION RATES	AVERAGE
Gloucester Co.	- 0.5 ft/yr	- 0.4 ft/yr
King and Queen Co.	- 0.3 ft/yr	- 0.4 ft/yr
SOUTH SIDE		
EROSION RATES		
AVERAGE		
York Co.	- 0.9 ft/yr	
James City Co.	- 1.8 ft/yr	- 1.2 ft/yr
New Kent Co.	- 0.9 ft/yr	
JAMES RIVER		
NORTH SIDE	EROSION RATES	AVERAGE
Newport News	- 0.8 ft/yr	
James City	- 0.1 ft/yr	- 0.45 ft/yr
SOUTH SIDE		
EROSION RATES		
AVERAGE		
Isle of Wight Co.	- 1.8 ft/yr	
Surry Co.	- 1.2 ft/yr	- 1.5 ft/yr
RAPPAHANNOCK RIVER		
NORTH SIDE	EROSION RATES	AVERAGE
Lancaster Co.	- 0.6 ft/yr	
Richmond Co.	- 0.6 ft/yr	- 0.6 ft/yr
SOUTH SIDE		
EROSION RATES		
AVERAGE		
Middlesex Co.	- 1.0 ft/yr	
Essex Co.	- 1.2 ft/yr	- 1.1 ft/yr
CHESAPEAKE BAY		
WESTERN SHORE	EROSION RATES	AVERAGE
Gloucester Co.	- 0.6 ft/yr	
Hampton	- 1.0 ft/yr	
Lancaster Co.	- 1.4 ft/yr	
Mathews Co.	- 0.8 ft/yr	
Northumberland Co.	- 1.0 ft/yr	
York Co.	- 1.5 ft/yr	- 0.9 ft/yr
EASTERN SHORE		
EROSION RATES		
AVERAGE		
Accomack Co.	- 1.5 ft/yr	
Northampton Co.	- 0.7 ft/yr	
Fisherman's Is.	+ 11 ft/yr	- 1.0 ft/yr
SOUTHERN SHORE		
EROSION RATES		
AVERAGE		
Virginia Beach	- 1.7 ft/yr	
Norfolk	- 1.2 ft/yr	
Nansemond	- 1.2 ft/yr	- 1.4 ft/yr

shorelines of these tributary estuaries are highly dissected by numerous lateral tidal creeks.

From about 1850 to 1950 the Virginia Chesapeake Bay and its tributaries lost over 21,000 acres of land to shoreline erosion.

Average shoreline erosion rates for this period are shown in Table 1. The bay side of the Eastern Shore, the Peninsula, west side of the Bay and the south side of the tributary estuaries have the highest relative erosion rates. This can be attributed to shore-

line exposure to the northwest, north and northeast directions from where the severest seasonal winds originate. Individual segments of shoreline have experienced erosion rates of more than seven feet per year. However, one or two feet per year is more common. For the 2,365 miles of estuarine shoreline measured, the average rate of erosion is about 0.7 feet per year (Byrne, et al., 1979). The Virginia Institute of Marine Science defines severe erosion as any shoreline segment with a rate of two or more feet

per year (Figure 2). Shoreline erosion becomes a problem when coastal property with improvements (house, cottage, etc.) are threatened by a rapidly receding shore bank.

SHORELINE VARIABLES

Many variables affect the estuarine shorelands of Virginia. The importance of any given variable depends on the site. Some of the important variables include:

1. *Wave height - this variable is in turn dependent upon the fetch*

(the length of open water facing the shoreline), the wind speed, direction and duration, and the nearshore water depth.

2. *Depth offshore - shallow water, such as tidal flats, helps reduce wave energy better while deeper water in the nearshore area allows a greater proportion of the wave energy to reach the shore.*

3. *Bank height - the height of the shore bank im-*

mediately behind the sediment beach (if present) or shoreline. For a given recession rate, the bank height determines how much material enters the estuarine system.

4. *Bank composition - tight clay or well cemented sand resist erosion better than soft clay or uncemented sand.*

5. *Width and elevation of sand beach - a sand beach is a natural buffer to wave activity.*

6. *Abundance of vegetation - vegetation (grasses and vines) on the shore bank nearshore and beach help hold the sediment and baffle wave action.*

7. *Shoreline geometry - the general shape of the shoreline. Irregular shorelines like marshes tend to break up wave energy better than straight shorelines.*

8. *Shoreline orientation - the general geographic direction the shoreline faces along with the fetch, influences the degree of exposure to wind wave attack.*

9. *Boat wakes - waves from boat wakes may severely affect a shoreline which is close to or on a boat channel.*

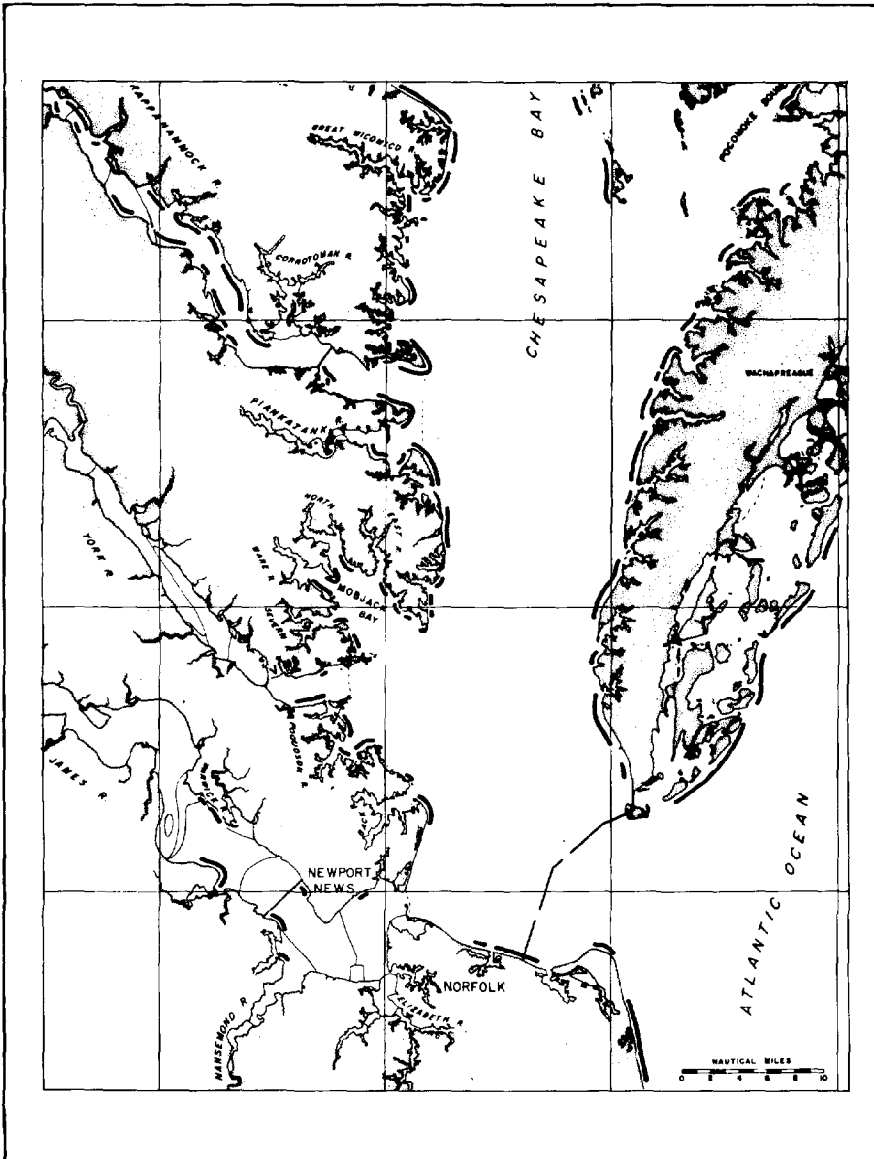

In addition, the presence of man-made structures (bulkheads, groins, etc.) modify the process of erosion by increasing it or decreasing it to a degree depending on the type, location and design of the structure.

Figure 2 – Green lines indicate erosion rates of two or more feet per year.

COASTAL PROCESSES

WIND AND WAVES

Waves are created by wind. The size of the waves is a function of fetch (distance over water which the wind blows), wind velocity and depth of the water. Storm winds generate large waves which do the most damage to shorelands on the open bay and ocean. During northeast storms and hurricanes the water level itself may be dramatically elevated (storm surge) so the wave attacks the shore at elevations higher than normal.

CURRENTS

There are basically two types of currents which figure prominently in the coastal processes acting in the Chesapeake Bay system. These are tidal currents and longshore currents. Tidal currents are generated by the periodic rise and fall of the astronomical tide. These tidal currents are most noticeable at the entrances to harbors and tidal creeks.

The longshore current moves parallel and adjacent to the

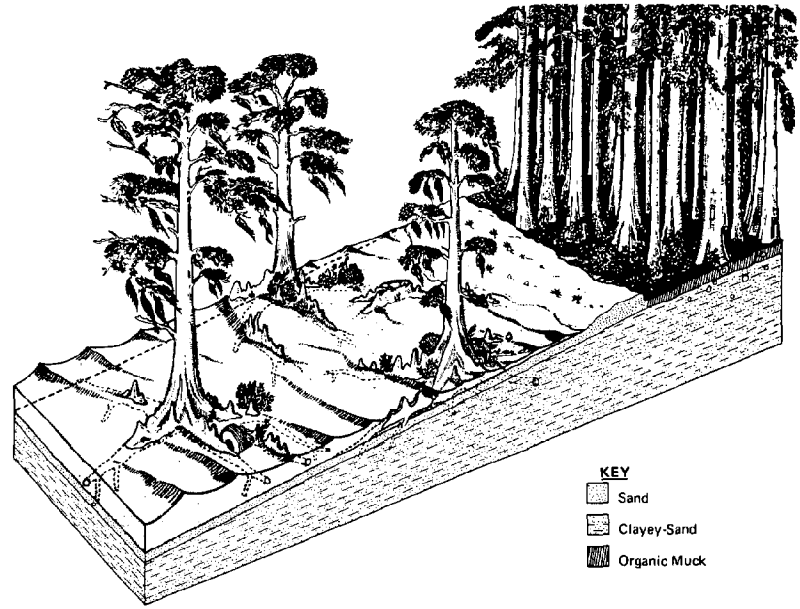

Figure 4 — The cypress fringe damping erosion wave forces and trapping sediments is illustrated in this figure. The cypress trees can form a natural bulkhead which dissipates wave energy and traps sand.

shore. It is generated by waves which strike a shoreline at an angle. Waves and currents working along a shoreline mold a shoreline's configuration and cause the movement of sediment to and from the shore. The movement of sand either parallel to shore, onshore or offshore is known as *littoral transport*. Although sand may move along a shoreline in either direction, there is usually a net movement in one direction.

SHORE TYPES

Five basic types of shoreline exist in the Virginia coastal system. These are:

1. *Swamp forest*
2. *Sediment banks*
3. *Marsh*
4. *Barrier beaches and spits*
5. *Man-modified*

Their distribution is a function of topography and the regional slope of the Chesapeake Bay drainage system.

Swamp forests occur as rivers flood plain vegetation (Figure 4). As sea level rises and floods the upland river basins, the flood plains become the receding shoreline. In Virginia, extensive reaches of swamp forest shorelines occur in the upper portions of the tributary estuaries and their lateral creeks.

Swamp forests contain a variety of tree species including Bald Cypress (*Taxodium distichum*), Black Gum (*Nyssa sylvatica*), and Tupelo Gum (*Nyssa aquatica*). The massive above ground root system and flared trunk of the Bald Cypress make it relatively resistant to wave action and erosion. However,

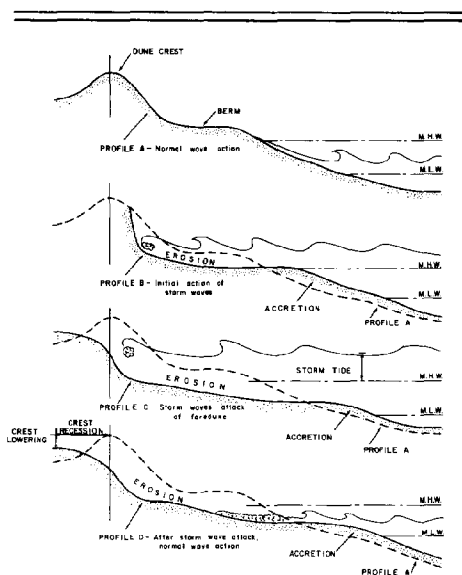

Figure 3 — Creation of nearshore bar during a storm.

BEACH

Beaches, no matter how extensive, are natural landforms resulting from wave action and represent a buffer zone between the land and water. During storm periods, waves may carry much of the beach sands offshore to form a bar (Figure 3). This helps dissipate the energy of the waves before they reach the shore. With the return of calmer weather, the bar sands slowly migrate back to the beach. Longshore sand movement usually occurs also. The direction of beach sands movement must be taken into account when designing coastal structures for erosion protection (groins, breakwaters and bulkheads).

its vulnerability to flooding makes swamp forest shorelines undesirable for development.

SEDIMENT BANKS

Sediment banks are composed of varying mixtures of gravel, sand, silt and clay (Figure 5). They range in height from a few feet to over 100 ft. above mean high water. Usually, a sand beach will exist along the base of the bank with much of the beach sand coming from erosion of the bank.

Sediment banks occur as interstream divides (between creeks) in the Chesapeake Bay system. The higher banks (> 15 feet) are found along the lateral tributaries and on the bay side of the East-

tern Shore in South Accomack County and Northampton County. Low sediment banks (< 14 feet) occur mostly along the small creeks and embayments on the west side of the Chesapeake Bay.

Active erosion of sediment banks produces almost vertical exposed scarp with fallen trees and logs littering the beach and nearshore area. Erosion of high banks is caused by rainwash and groundwater which saturates the face of the bank causing sliding and slumping. Wave action during storms causes additional slumping by undercutting the base of the high bank. Low banks are most vulnerable to wave activity which will overtop the bank during storms and carry

off large chunks of fastland.

Abating active erosion of a sediment bank requires vegetating the face of the bank. To best accomplish this, the slope of the bank should be reduced. A recommended slope gradient is 4:1 (4 horizontal to 1 vertical). However, it may be possible to affect vegetative bank stabilization on as much as a 1:1 slope if the bank is "dry" and has no groundwater springs "weeping" out.

Once the eroding bank is stabilized by grading, the toe or base must be protected against waves and high water which will undercut the sloped bank and eventually renew the erosion problem. There are basically two methods for accomplishing this. One is to build up a sand beach,

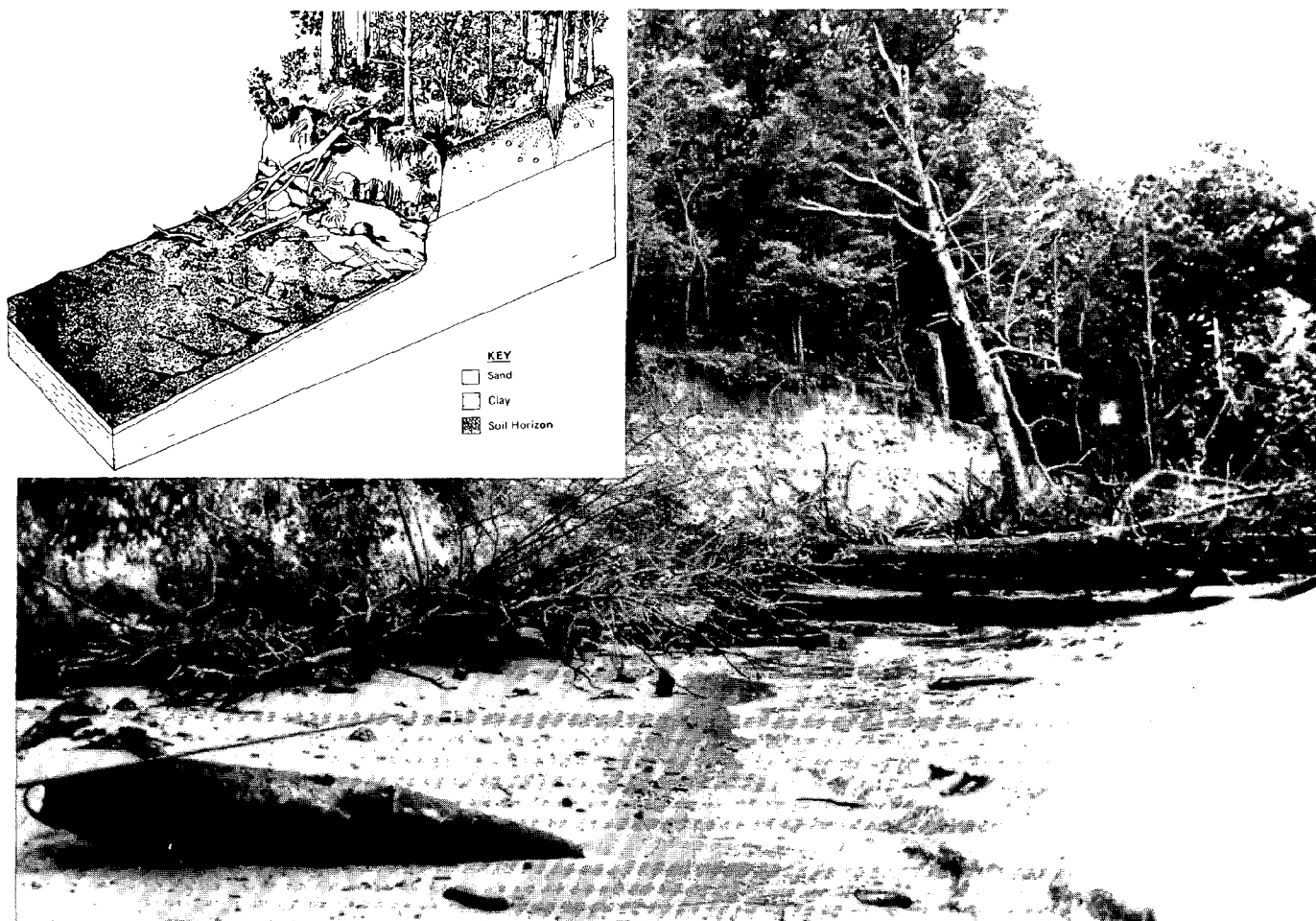

Figure 5 — Erosion of sediment banks is the primary source of material for the beaches along the estuarine shoreline. (Upper right) storm waves undercut the high bank causing slump blocks, along with the vegetative cover, to slide onto the beach. In this illustration, the slump blocks are reduced by further wave action, leaving behind debris of fallen timber.

the other is to harden the toe of the bank (refer to section of "Shore Protection Methods").

Sand can be trapped by groins, submerged sills and breakwaters. Care must be exercised in emplacing those structures to prevent sand starvation of adjacent shorelines. The enhanced beach helps dissipate wave energy against the bank. However, during large storms, water levels and waves may overtop an established beach and severely attack the sediment bank. In many cases, a beach is not enough to prevent bank erosion, consequently, the toe of the bank must be hardened.

Hardening the shoreline can be done by building a bulkhead, seawall or revetment. These methods are often costly and must be constructed properly to prevent premature failure.

If a sediment bank shoreline is exposed to small distances of open water, it may be possible to plant a marsh grass fringe (Figure 6). Marsh grass will baffle wave action and also help trap sand. This has been done effectively in many areas and it can be a viable and relatively inexpensive measure to slow shoreline erosion.

MARSH SHORELINES

Marsh shorelines are extensive marsh (wetlands) plains (Figure 7) or narrow fringes in front or riverward of sediment banks. Marshes also occur along the flood plains of embayed lateral creeks. These creeks are subject to daily tidal fluctuations and usually have a defined channel.

Figure 6 — Fringe marshes offer excellent natural buffers to erosion. The marsh grass greatly reduces wave energy acting on the shoreline.

Figure 7 — Extensive marsh plains occur along many low lying areas bordering the Chesapeake Bay.



Figure 8 depicts tidal wetlands of Virginia and the vegetative zonation of plant species. There are 212,000-225,000 acres of tidal marshes in Virginia. In addition to their value as an essential link in the estuarine food chain, marshes also act as effective buffers to erosion of the fastland. Their low elevation and matted root system make marshes more resistant to wave erosion than sediment banks exposed to the same fetch conditions.

Extensive marshes act as large sponges to help reduce the flood hazard in some coastal areas. Fringing marshes occurring along sediment banks greatly reduce wave action. Actively eroding marsh shorelines are characterized by exposed and undercut peat banks (Figure 9). Marshes are also valuable to waterfowl as a source of food and habitat.

BARRIER BEACH AND SPITS

A beach system is comprised of a beach, a dune, and a marsh complex behind the dune (Figure

10). This situation exists along the barrier islands of Virginia's Eastern Shore and to a lesser extent along the Bay facing shoreline of Accomack, Mathews, and York Counties.

Barrier beaches generally operate with a limited amount of sand. The beach and dune system react to existing weather conditions by attempting to attain and

maintain a state of equilibrium. There is usually little input of sand from actively eroding fastland. When a severe storm impinges on a barrier system, beach and dune sand can be carried through a breach in the dune line and deposited on the marsh. These features are called washovers. Washovers reduce the amount of sand available to the

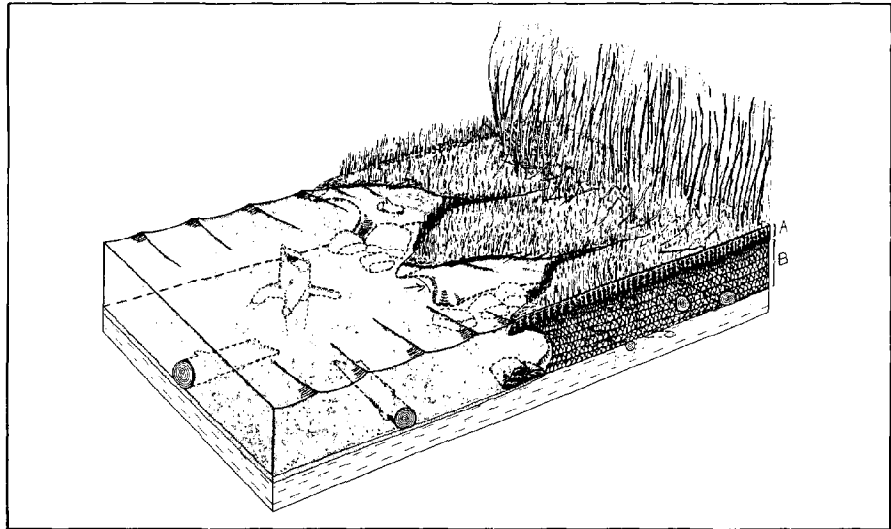

Figure 9 - The factors involved in erosion of the brackish marsh shoreline are illustrated. During low tide, wave action erodes the softer underlying peat (B), undercutting the firm surface layer (A). The peat shelf breaks into blocks that fall into the water, leaving U-shaped notches along the bank.

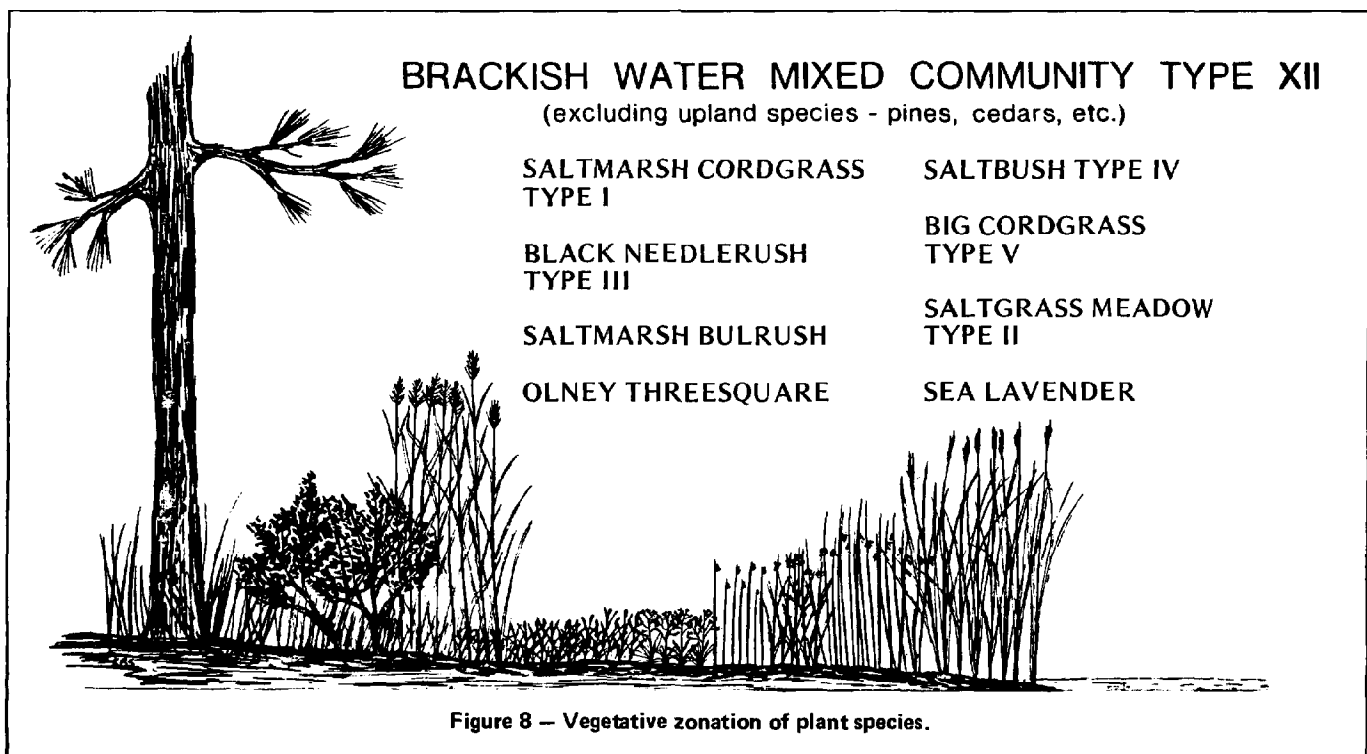

Figure 8 - Vegetative zonation of plant species.



Figure 10 — Extensive low-lying dune shorelines occur along bay shores in Hampton, Mathews County and Northumberland County.

active beach, forcing the beach to react to a reduced sand supply by retreating. In many instances this retreat exposes the surface of marsh peat covered by previous washovers (*Figure 11*).

Spits are active sand features found at the downdrift end of barrier beaches. They are also defined as tongues of sand moving across the mouths of lateral creeks. One example of a spit is Willoughby Spit where the Hampton Roads Bridge Tunnel enters Norfolk. This mile long sand spit is said to have formed in a single hurricane storm in 1806 (*Figure 12*).

Sand spits may advance across small creek entrances if enough sand is moving alongshore which results in temporarily closing the creek. Larger lateral creeks maintain their channel opening by tidal flushing. However, even these naturally maintained channels are not deep enough for continued use by some vessels. This navigation problem is solved by maintenance dredging of the channel and/or stabilizing the inlet with jetties.

Some barrier beaches lack a marsh complex behind the dune system. Such shorelines exist along the south shore of Chesapeake Bay and between Cape Henry and Sandbridge. They also retreat by the same process as

described previously.

Development on the barrier beaches and spits is precarious due to the shifting nature of sand. Ocean shorelines are the most dangerous because of high wave energy potential generated over long fetch conditions, high storm surge and deeper nearshore water depths. Rigid structures (cottages, bulkheads and seawalls) placed on the dunes and beaches usually create adverse effects by causing loss of beach and subsequent undermining of the structure during severe storms.



Figure 11 — The dune shorelines recede by washovers during storms. This often exposes a peat horizon which was once a living marsh behind the dune system bayward of its current position.

MAN MODIFIED

Man modified shorelines are any of the previous shore types which have been altered in some fashion by man (*Figure 13*). These alterations or modifications include bank grading, beach nourishment, and protective structures. Much of Virginia's coastline has been developed in one way or another. Over 800 miles of Bay shoreline has a housing density of six or more structures per mile.

Shoreline protection to a large degree has been haphazard and piecemeal in nature. Along any given shoreline, the number of different protective methods often equals the number of people living there. This often is ineffective in controlling the problem of shoreline erosion. For example, an improperly designed or poorly constructed bulkhead may fail, creating problems for the owner and adjacent neighbors. Groin installations often do well to protect the updrift shoreline by trapping sand, but may cause serious sand starvation and erosion downdrift.

Rather than using this approach, shoreline erosion should be addressed on a reach basis with full consideration for the net effectiveness of the structural

or other methods employed (Byrne, et al., 1978). A *reach* is a shoreline unit where there is a mutual interaction between the forces of erosion and/or the sediment supply. It may be advantageous for a waterfront community to seek out advisory or engineering services, whether public or private, to insure a sensible approach to their shoreline situation.

Figure 13 — Wooden bulkheads are a popular method of slowing shoreline erosion. If properly installed, they will generally last 10-15 years.

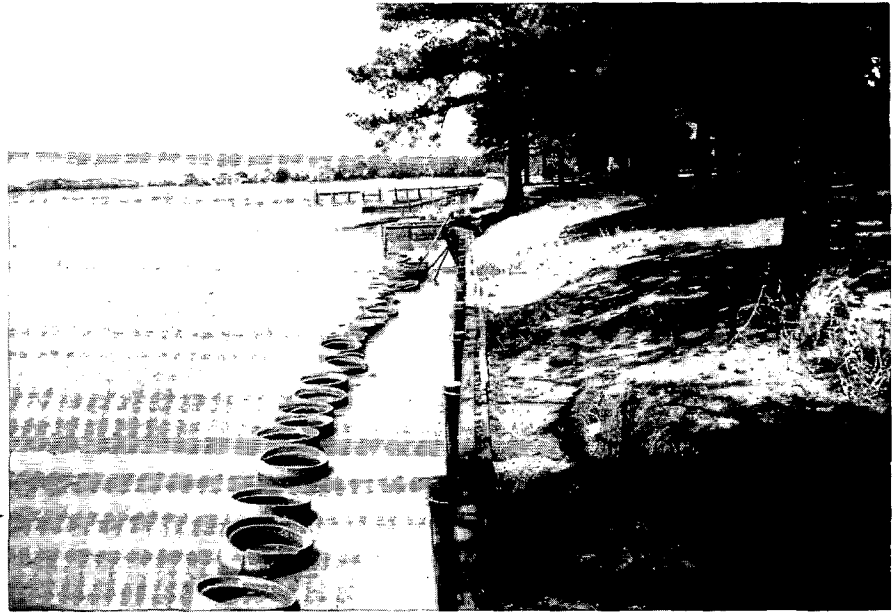
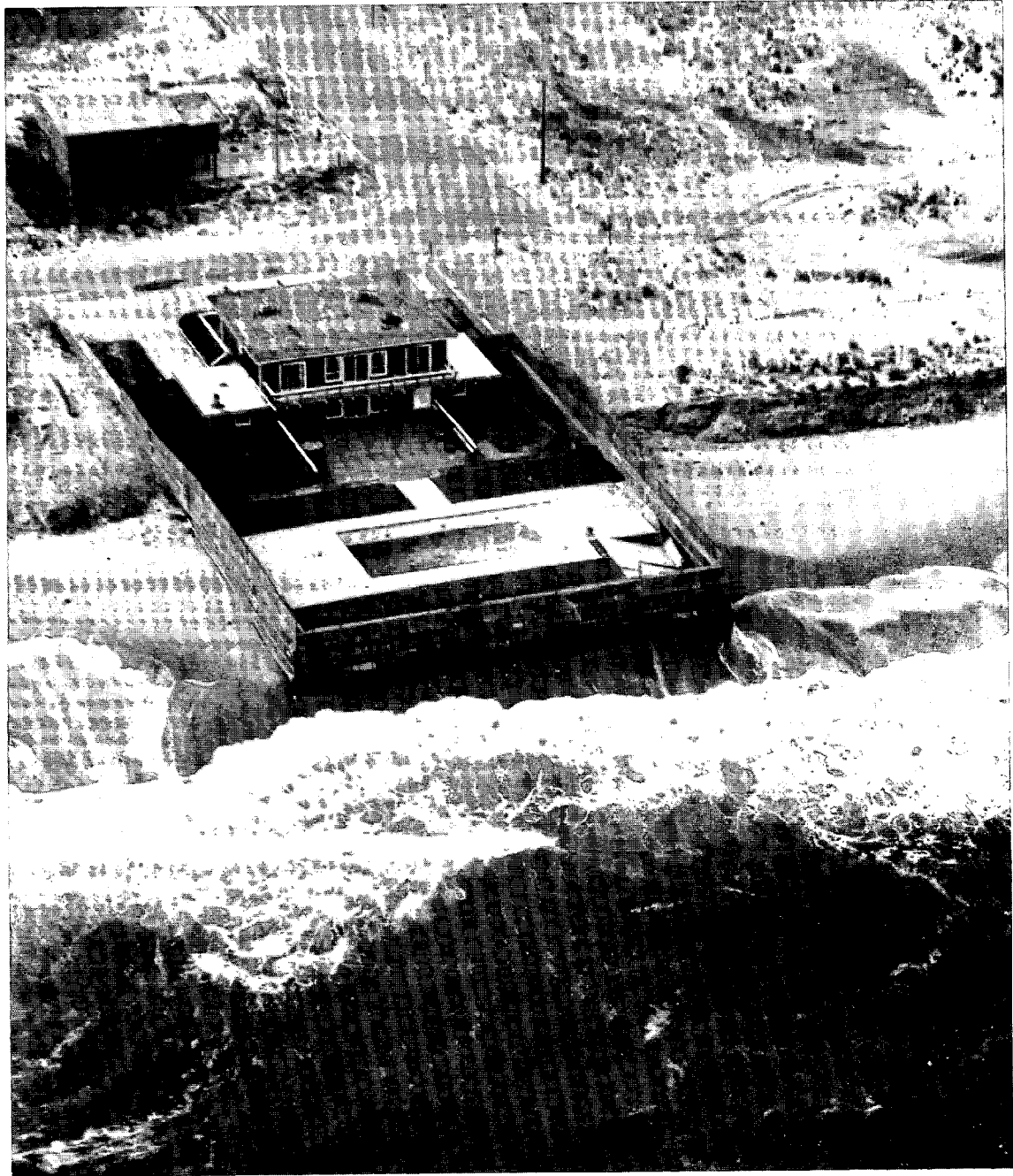

Figure 12 — Willoughby Spit as seen from the air on March 3, 1973.





SHORE PROTECTION METHODS

The problem of shore erosion is often overlooked by the prospective or present owner of shoreline property. Average rates of erosion calculated for discrete segments of a shoreline rarely present the true picture. Some areas remain stable for many years and then suffer extreme erosion. These erosion rates reflect the relative severity of erosion in one area versus another. In response to sudden increases in the erosion rate, many landowners install forms of shore protective structures whether it is the proper structure or not. In many instances improper structures only serve to accelerate the erosion. Failures stem from the use of improper materials, improper installation, or poor advice. No patent answers exist because each situation is unique; nor is there a guarantee that any system will solve the problem. Construction of proper shore protective structures is also expensive. In many cases, the cheapest solution is not always the best. There are several protection shore methods which, if properly designed for a particular estuarine shoreline, can be effective in abating erosion. Some of the methods are:

VERTICAL RETAINING STRUCTURES (BULKHEADS, SEAWALLS, REVETMENTS)

The respective definitions of these structures vary little although different construction materials are sometimes associated with each structure (Figures 14A & B, 15, 16A & B). Vertical structures act to retain the fastland material and to prevent wave induced erosion. In one way, they can be thought of as defensive structures. However, in many situations, vertical structures lead to the loss of the beach which may front them.

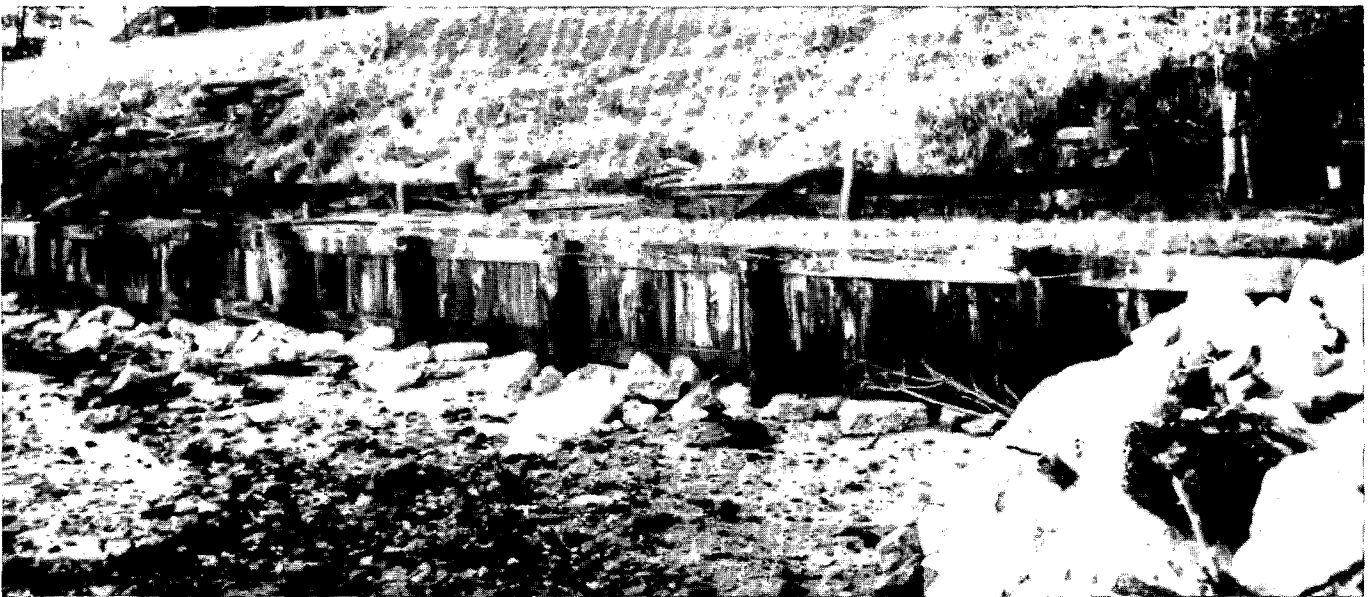
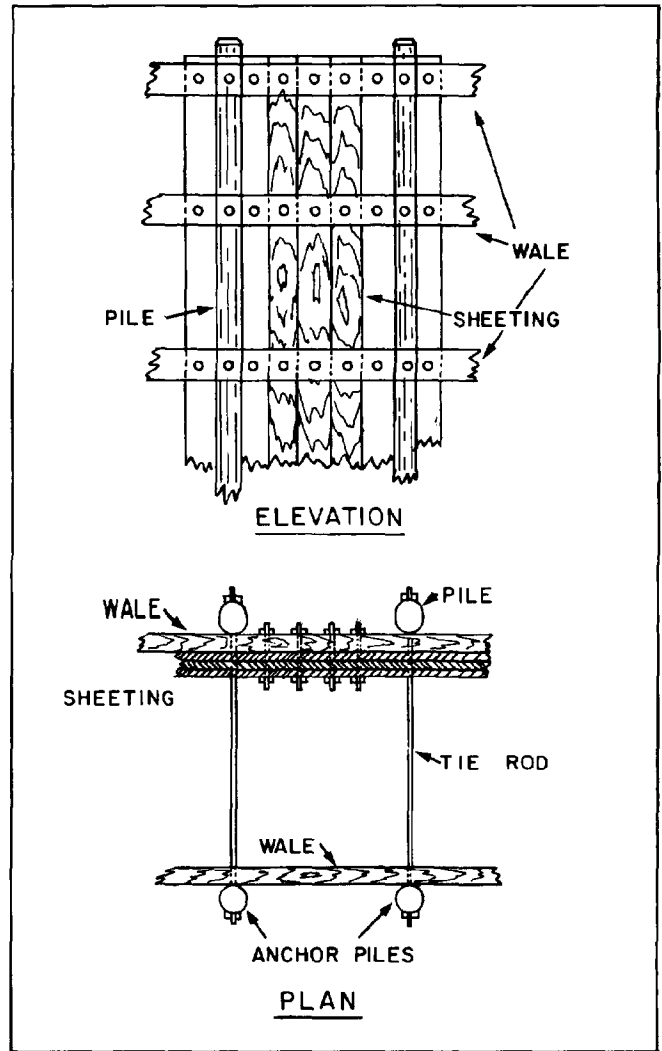

Figure 14A — Wooden bulkhead. Figure 14B (top right) timber sheet - pile bulkhead.

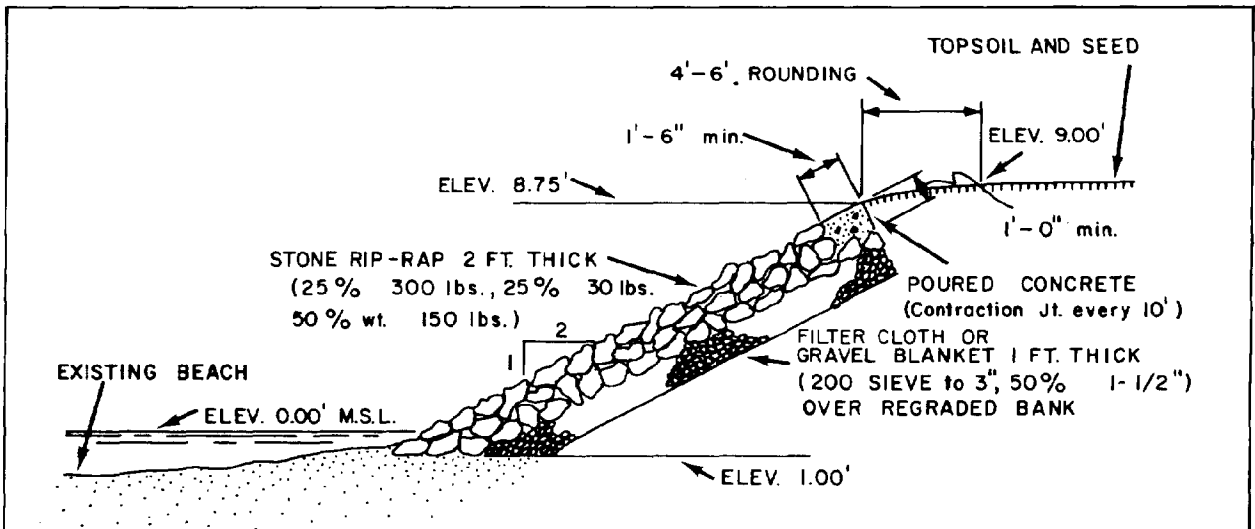
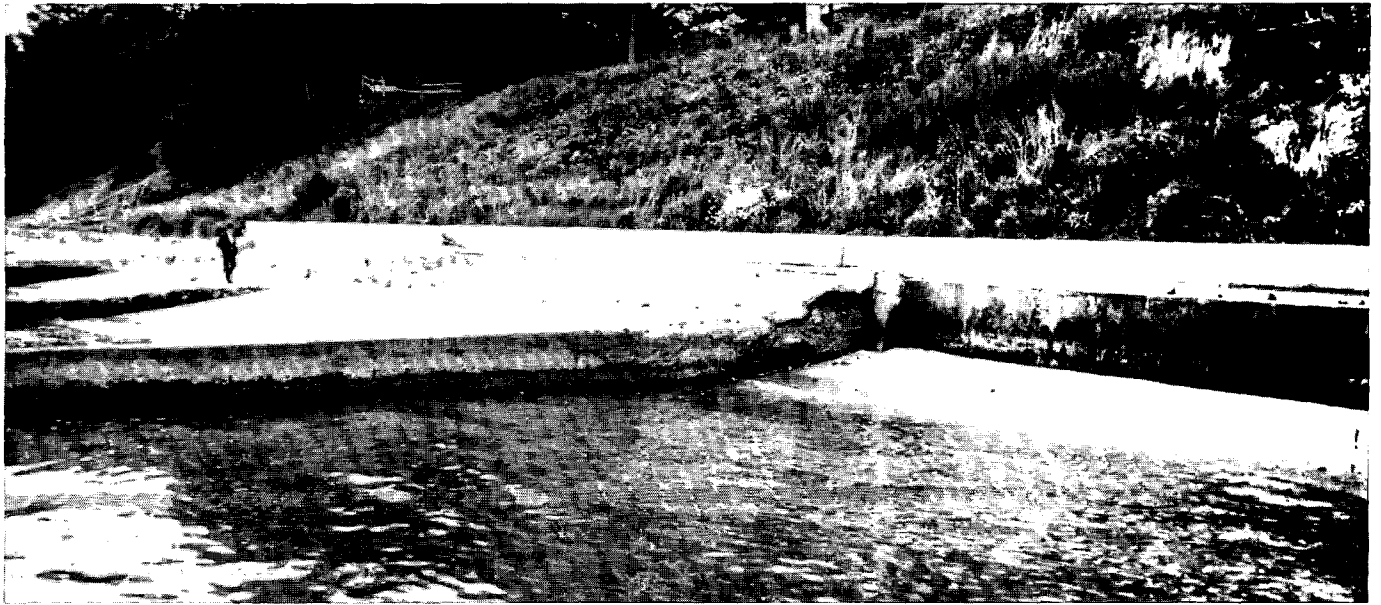
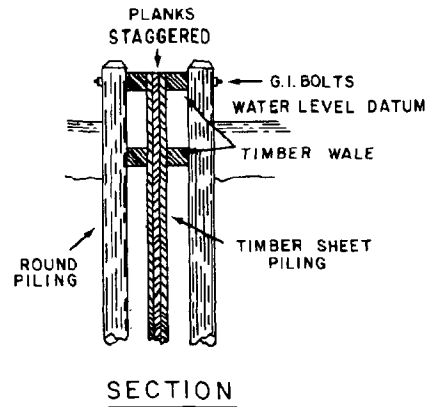

Figure 15 — Concrete seawall (top). Figure 16B (bottom) small riprap revetment. Figure 16A (middle) riprap revetment.

During times of abnormally high water, waves may overtop the beach and strike the bulkhead. Most of this energy is reflected off the wall. The reflected wave then meets the next incoming wave and creates a zone of extreme turbulence where they meet. This turbulence causes scouring of beach material near the base of the bulkhead. Over a period of time, this can lead to the deterioration of the beach if there is an insufficient input of sand. In addition, age or improper construction can lead to small cracks in a bulkhead. This can result in leaching of fine material from behind the bulkhead. In many instances, erosion will continue on each side resulting in the flanking of the structure.



GROINS AND JETTIES

Groins and jetties are vertical structures oriented perpendicular to the shoreline. Groins are used on open shorelines to trap the littoral transport of sand parallel to the beach. When functioning properly, groins will widen and heighten a beach.

Jetties are structures used to define and protect an inlet or harbor entrance from shoaling. Shoaling

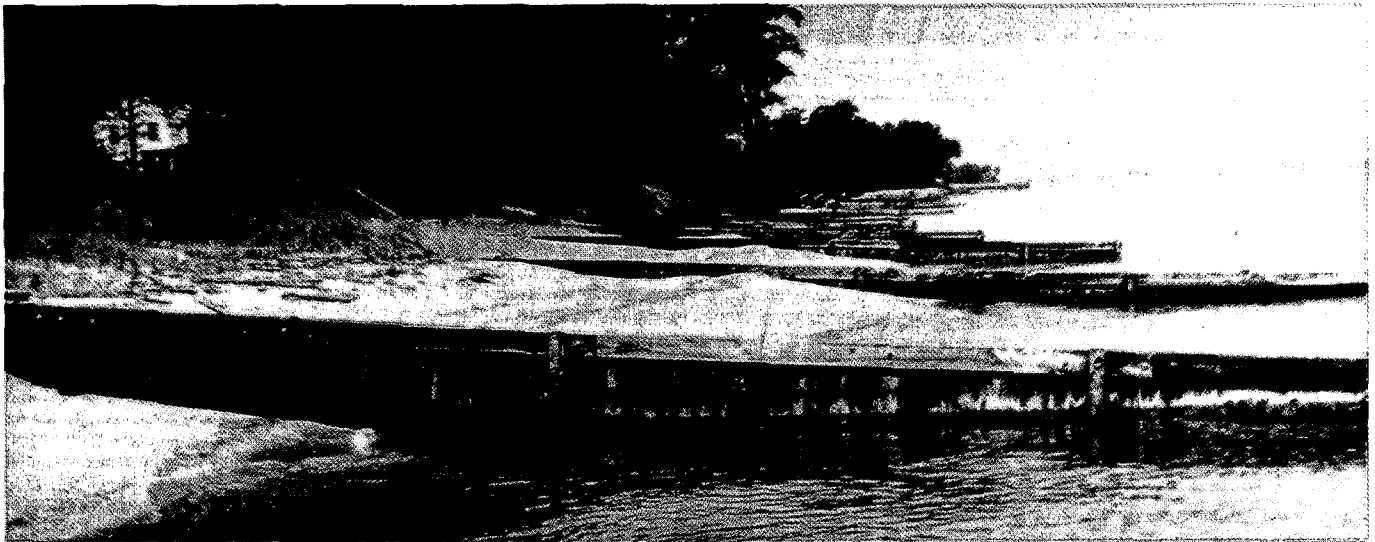
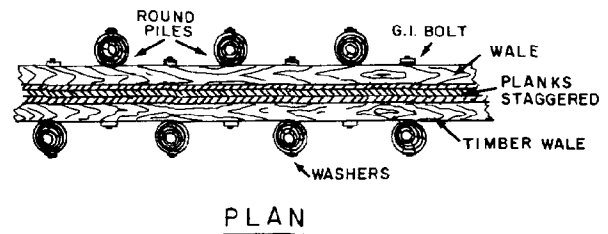

is usually the product of the littoral transport of sand towards and into the inlet. Jetties can also serve to make inlet access easier by reducing wave height (Figures 17A & B).

Imperative in the success of groins is an adequate supply of sand to quickly fill the groins and then begin bypassing sand. An inadequate supply of sand can lead to accelerated erosion downdrift of the groin. In some cases, this accelerated erosion can flank the groin rendering it totally useless (see Figure 18).



Figure 17A – Groin field. Figure 17B (upper right) Timber sheet-pile groin.

Figure 18 – Groin which has been flanked by severe erosion.

BREAKWATERS (SOLID AND FLOATING)

A solid breakwater is a structure usually constructed of stone, which serves to reduce wave height (Figures 19A & B). This reduction of wave height reduces the erosive power of the waves striking the beach or entering a harbor. As solid breakwaters work to resist the full power of the incoming waves, the structure must be massive. If not designed and placed properly, they can lead to accelerated nearshore currents which can cause erosion. Used incorrectly, they can halt the parallel littoral sand transport leading to accelerated erosion downdrift.

A different type of breakwater becoming popular is the floating breakwater (Figure 20). Numerous designs have been proposed and some have been tested. Two general categories, rigid and flexible, have arisen with various benefits added to each. Most designs have a floating structure tethered to the bottom. Instead of working to totally eliminate waves from passing the structure as does a solid breakwater, floating breakwaters act as filters to the incoming waves by reducing the wave energy behind the structure. In some cases substantial

reduction in wave height can be achieved. The small waves are the first to be dampened out.

SUBMERGED SILL

Although the submerged sill is new to the Chesapeake Bay, it was first employed over 40 years ago. It consists of a detached structure constructed parallel to the shore along the extent of the eroding shore. To date, sandbags, gabions and wood have been used as construction materials.

The principle involved is known as a perched beach. As illustrated (Figures 21A & B) the desired effect is to elevate the profile of the beach. If successful, a protective layer of sand exists at the base of a cliff or bulkhead. Because this layer is significantly higher than the unprotected backshore height, additional protection is afforded during storm elevated water levels. This system offers protection from all wave angles and at higher water levels. In essence, it resembles a "permanent" bar situated at the step of the beach.

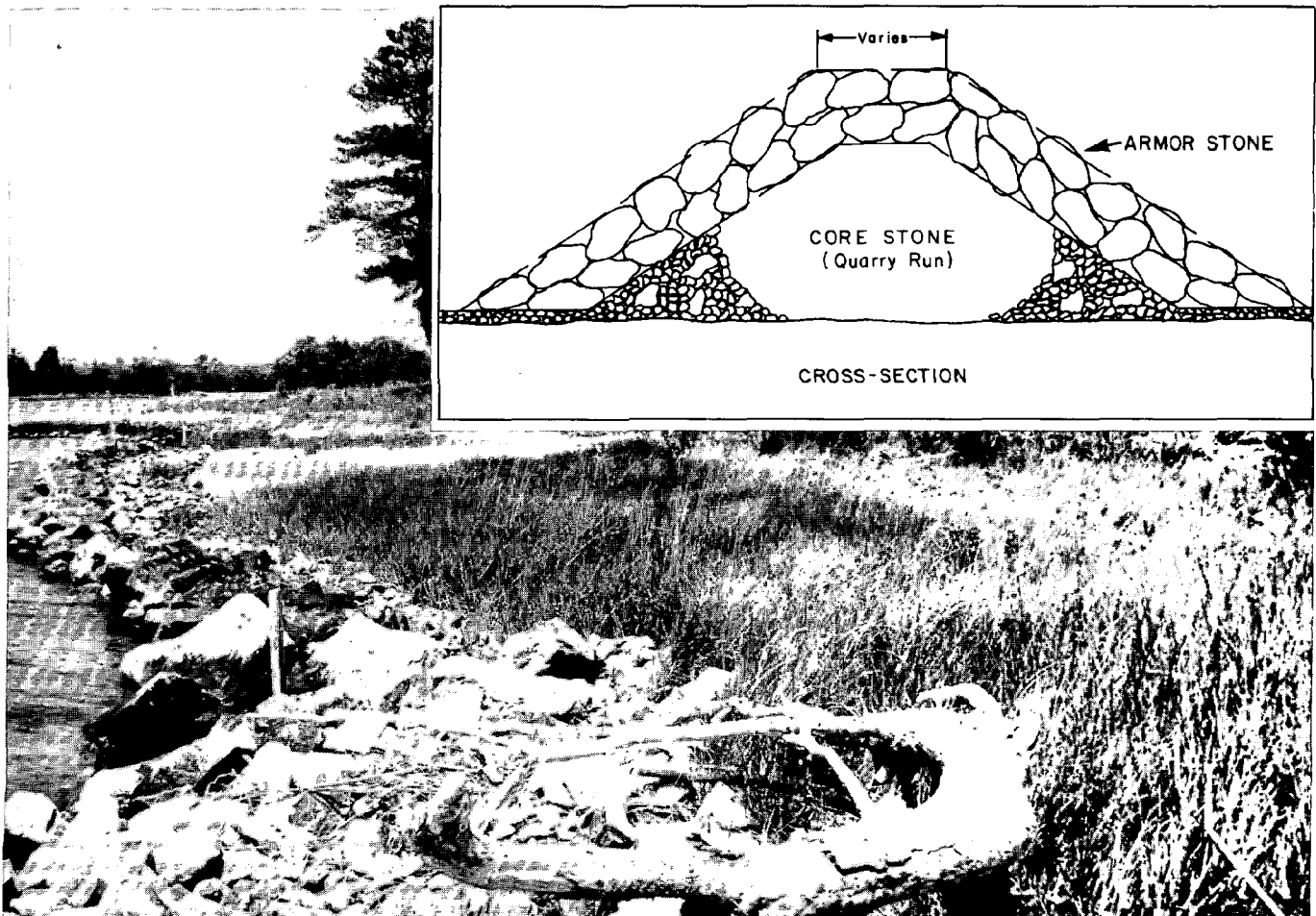
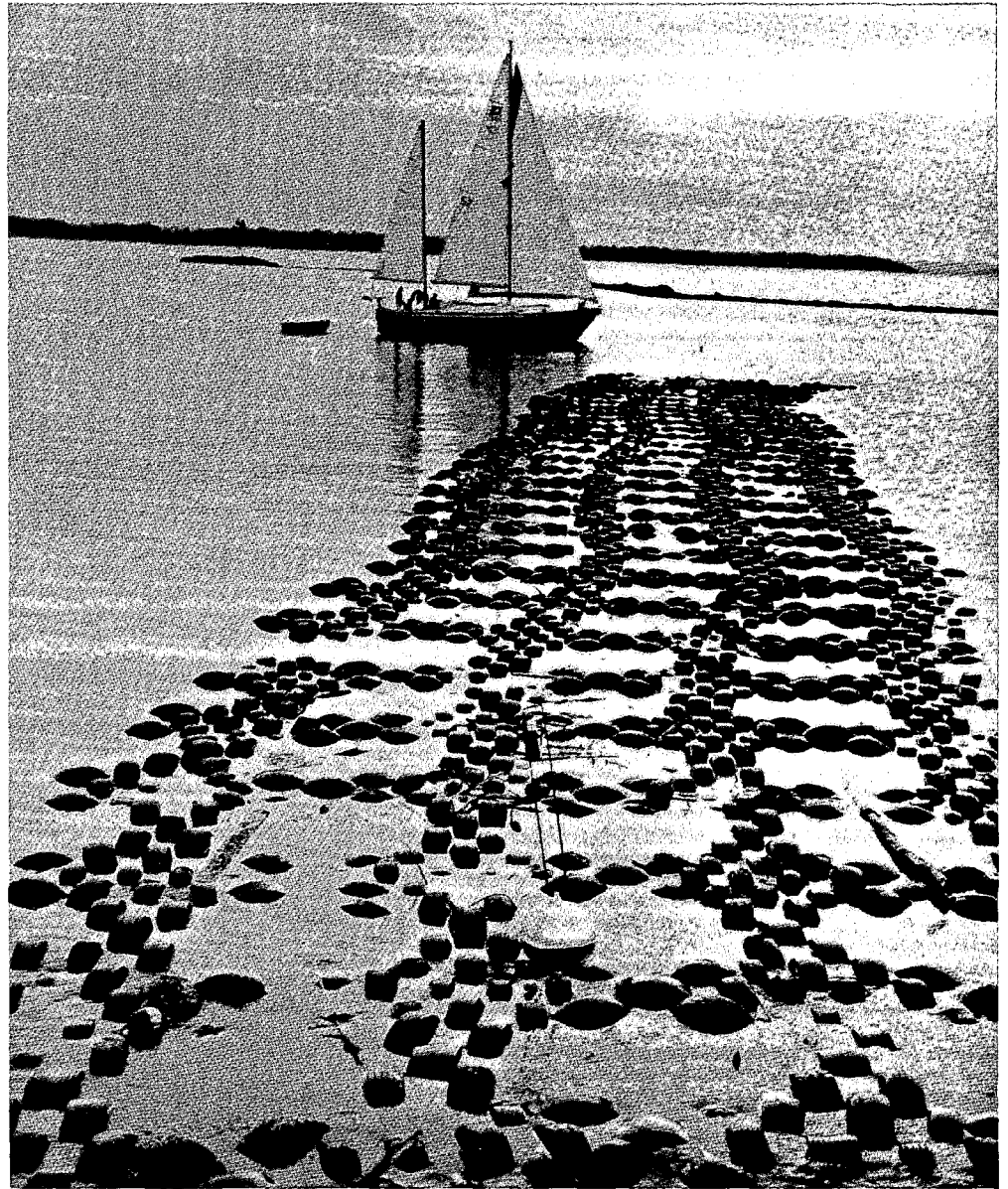

Figure 19A – Small stone breakwater. Figure 19B (upper right) generalized cross section of a large stone breakwater.

Figure 20 — Floating
tire breakwater.



The sources of material to fill the system come from three areas. The first area is that which drifts along parallel to the beach. The second area is that which is moved onshore from offshore, and the third area is that which is introduced by rain runoff erosion of the cliff face behind the structure. The percentage of input from these three sources varies with the location. Beach nourishment can also be used to fill the system.

As with any structure, the submerged sill has its drawbacks. It can be a swimmer and boating hazard. Also, it can be too effective in halting the parallel transport of sand along a beach. Construction materials such as the sandbag are susceptible to ice damage and vandalism. It is generally restricted to areas which have significant volumes of sand within the beach system.

DESIGN CONSIDERATIONS

BULKHEADS, SEAWALLS, REVETMENTS

Effective designs for these structures vary with the forces which these structures must deal with. However, certain considerations may apply according to the location.

RIPRAP REVETMENTS

1. *The stone or rubble should be placed as opposed to dumped at the site.*

Rationale: Placing assures good interlocking of the individual stones. The proper slope for the material can be easily attained.

2. *Stone or rubble of sufficient size to resist the maximum expected wave forces should be used.*

Rationale: Many failures of riprap structures stem from insufficient stone size. Waves during storm conditions remove the material too small, thus leading to failure of the whole structure.

3. *A protective apron should extend from the toe of the structure.*

Rationale: Although the rough nature of a riprap structure removes a portion of a wave energy, some is still reflected. When this reflected wave meets the next incoming wave, an area of intense scouring occurs immediately in front of the structure. This scour undercuts the structure, allows it to slump, and eventually leads to its failure.

4. *The use of filter cloth is strongly recommended.*

Rationale: By their nature, riprap structures are porous. However, this porosity can lead to the failure of the structure. The constant flooding of the structure due to tidal action and the passage of ground water and rain runoff through the structure can leach fastland material from behind it. Filter cloth acts to prevent this leaching of material. It is emplaced first and then the stone is placed on top of it.

BULKHEADS

Vertical sheet pile bulkheads can be constructed from a variety of materials. Among these are wood, steel, aluminum, asbestos concrete and concrete. Gabions can also be used to construct vertical structures.

WOOD BULKHEADS

1. *Vertical tongue and groove sheet pile is preferred.*

Rationale: All treated wood warps and shrinks after exposure to the elements. The tongue and groove configuration reduces the risk of spaces opening between the sheet pile which would allow fastland material to leach through the opening. Tongue and groove cannot reduce this risk in cases of faulty construction.



Figure 21A — Sandbag sill.

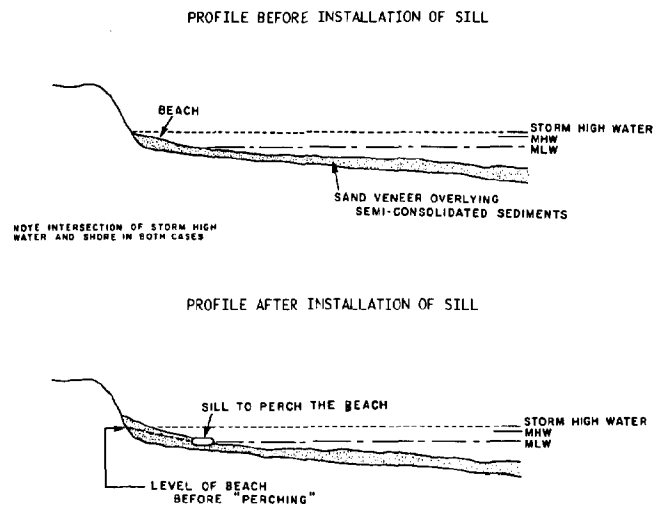

Figure 21B — Perched beach concept.

2. *As a minimum, depth of penetration should be equal to the exposed portion.*

Rationale: A common cause of bulkhead failure is inadequate penetration. Many people assume that the beach will remain in front of the bulkhead. However, in storms, waves can remove the beach leaving a minimum length of sheet pile penetrating the stable bottom. The weight of the cliff material being retained causes the bulkhead to topple. In other cases, the inadequate penetration of the bulkhead allows the retained fastland to leach out the bottom of the bulkhead. To insure adequate penetration, it is necessary to establish where the

stable layer begins. In most areas throughout the lower Chesapeake Bay, this layer generally coincides with a reddish brown clay layer which exists under the beaches.

3. *Emplacement of filter cloth is recommended.*

Rationale: The application of filter cloth behind a tongue and groove bulkhead acts as it does with riprap. Because the wood shrinks and warps, small openings can appear between the sheet pile. The filter cloth then acts to prevent the leaching of the fastland material out through these openings. It is also very helpful at the junction of two structures. As an added measure of protection, the bulkhead can be backfilled with gravel or other coarse material and then regular fill.

4. *Adequate tiebacks and backfill are necessary.*

Rationale: A common cause of bulkhead failure is the lack of substantial system of tiebacks. Common mistakes are: tiebacks too close to the bulkhead, spaced too far apart, tieback material is incapable of resisting the stresses placed on it, and insufficient size deadmen or screw anchors.

5. *Weep holes may be necessary.*

Rationale: In certain areas, ground water collects behind a bulkhead. It then becomes necessary to release this pressure by having small openings through the bulkhead. These openings are stuffed with wads of filter cloth to prevent leaching of fine materials. They are usually placed above the mean high water mark.

6. *Riprap at the toe of the bulkhead may be necessary.*

Rationale: In certain high energy areas, the scour associated with bulkhead jeopardizes the integrity of the structure. To minimize this impact, an apron of riprap should be placed at the base of the bulkhead. The approach also provides a remedial repair for a failed vertical retaining structure.

7. *Return walls should be well tied into the fastland.*

Rationale: On an open bulkhead, waves can be focused where the

return wall joins the fastland. To prevent the flanking of the bulkhead, the return wall should be entrenched in the fastland. In addition, a riprap cornice may be necessary. This riprap serves to reduce the scout of waves focused at the ends of the wall.

GABION REVETMENT

1. *Gabions should be entrenched into the clay layer below the beach (Figure 22).*

Rationale: As with other vertical structures, some scour can occur on the seaward side of the structure. Gabions placed on top of sand will be undermined, causing the structure to fail.

2. *Filter cloth should be placed under, or on the backside of the gabion revetment.*

Rationale: Gabions are similar to riprap in their use. The filter cloth prevents leaching of fine grained material from behind the structure. The filter cloth beneath the structure helps prevent undue settling of the structure.

GROINS AND JETTIES

Groin systems vary greatly depending on wave climate. The following comments concern an impermeable, fixed height groin.

1. *Tongue and groove sheet pile should be used.*

Rationale: As with a bulkhead, the tongue and groove helps prevent the leaching of material through the structure. In most areas a minimum of two-inch thick sheet pile is necessary.

2. *Round pile should be placed on alternating sides at an equal spacing.*

Rationale: This type of configuration provides good strength and inhibits undue flexing which can result if the structure does not fill equally on each side.

3. *Ratio of sheet pile penetration to exposure should, as a minimum, be equal.*

Rationale: Initially, the groin is a free standing structure. Until it is full, waves can vibrate a structure out of the bottom if the penetration is inadequate. In addition, if the fill is differential, i.e., one side only,

the weight of the sand and water can topple the groin.

4. *The groins should be constructed in a sequential manner.*

Rationale: In most areas, there is a net drift in a certain direction. Thus, the first groin should be constructed on the downdrift end of the project. Construction of the next groin should begin when the first groin fills completely. In this way the beach itself can determine the optimum spacing and length of the groins. While this sequential construction is desirable, repeated contractors' mobilization costs may be prohibitive.



Figure 22 – Gabion revetment.

SUBMERGED SILL

These considerations refer primarily to the use of sandbags to form the sill. Gabions and mortar filled bags are also effective in perching a beach.

1. *Grain size should be ¼ millimeter or larger.*
Rationale: This size sand is necessary to prevent the bags from losing material through their pores.

2. *Sills should be used in areas with good sand supplied on the beaches.*

Rationale: Insufficient supply of sand to the beach can cause deleterious effects to downdrift shores.

3. *Although not a general rule, the sill is usually most effective when placed at, or near the mean low water line.*

Rationale: This position is usually sufficient to insure adequate back-shore height. When the system fills however, placement too far offshore generally results in failure.

BREAKWATERS

Rubble mound (riprap) or gabion breakwaters act to build up beach material and reduce wave action against the shoreline during storms. In some cases their benefits tend to outweigh their expense.

1. *Like the riprap revetment, the stone should be of sufficient size to resist the maximum expected wave forces.*

Rationale: Wave forces during storms will roll undersize stone off the slope of the structure.

2. *For gapped breakwaters, spacing and distance offshore must be engineered properly considering all the design variables for a given shoreline.*

Rationale: Breakwaters placed too far offshore may be ineffective in reducing wave forces. Too wide a gap between breakwater units may result in increased erosion on the shoreline midway between the units.

ADVISORY SERVICES

In order to help the shoreline property owners in Virginia, several agencies offer free advice on shoreline problems. These agencies are:

Virginia Shoreline Erosion Advisory Service
P. O. Box 1024
Gloucester Point, VA 23062
(804) 693-3388

Virginia Institute of Marine Science
Gloucester Point, VA 23062
Attn: Mr. Scott Hardaway
(804) 642-2111, Ext. 280

Soil Conservation Service
Warsaw, VA 22572
Attn: Mr. Blaine DuLaney
(804) 333-6931

Army Corps of Engineers
804 Front Street
Norfolk, VA 23510
Attn: Jim Melchor
(804) 625-8201, Ext. 271

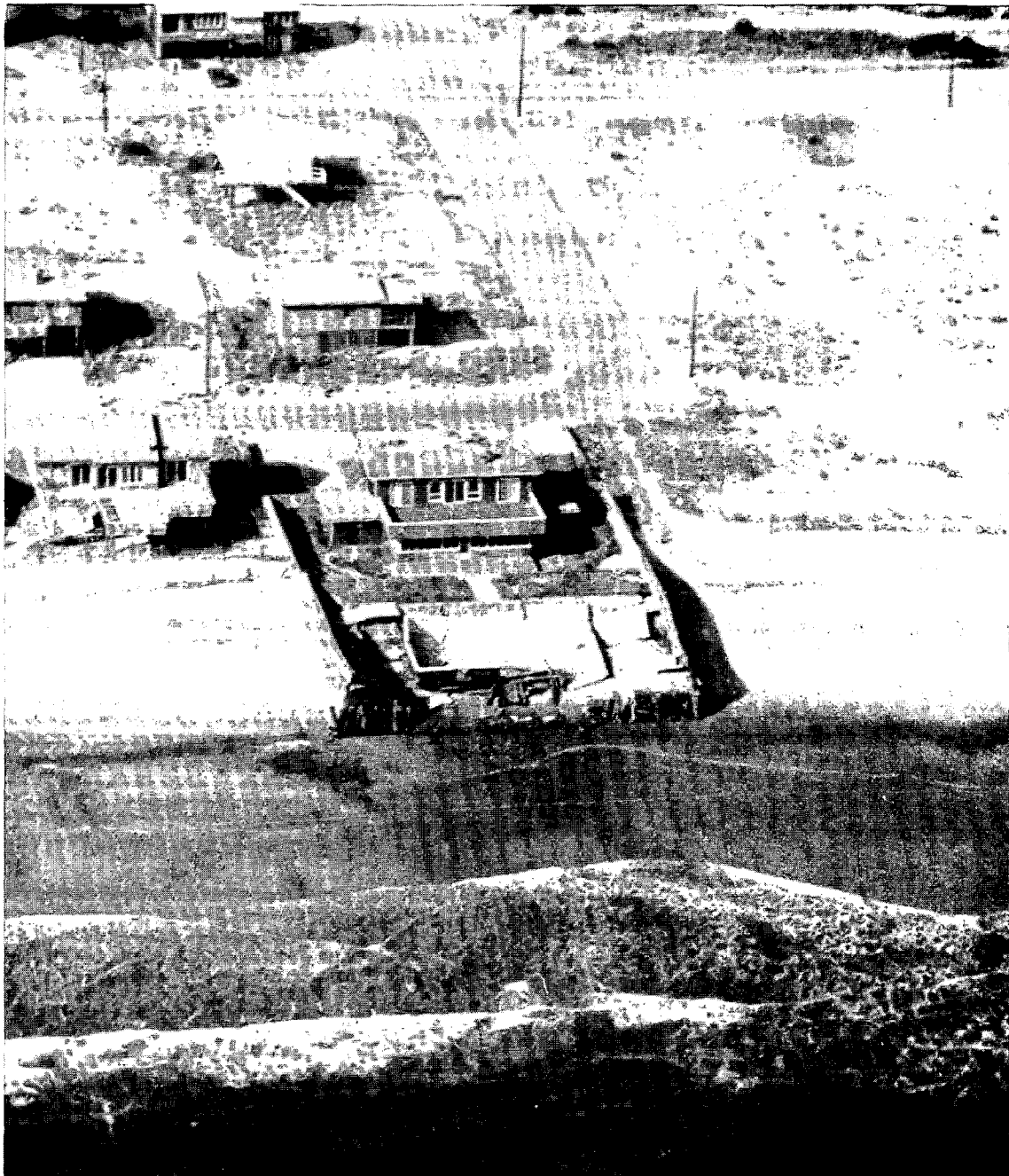

Building a structure close to the Atlantic Ocean may result in severe damage during storm events. The photograph on page 11 shows a Virginia coastal residence with pool in the Summer of 1978. The photograph on this page was taken in October 1979 after a storm of moderate intensity.

VEGETATIVE CONTROL

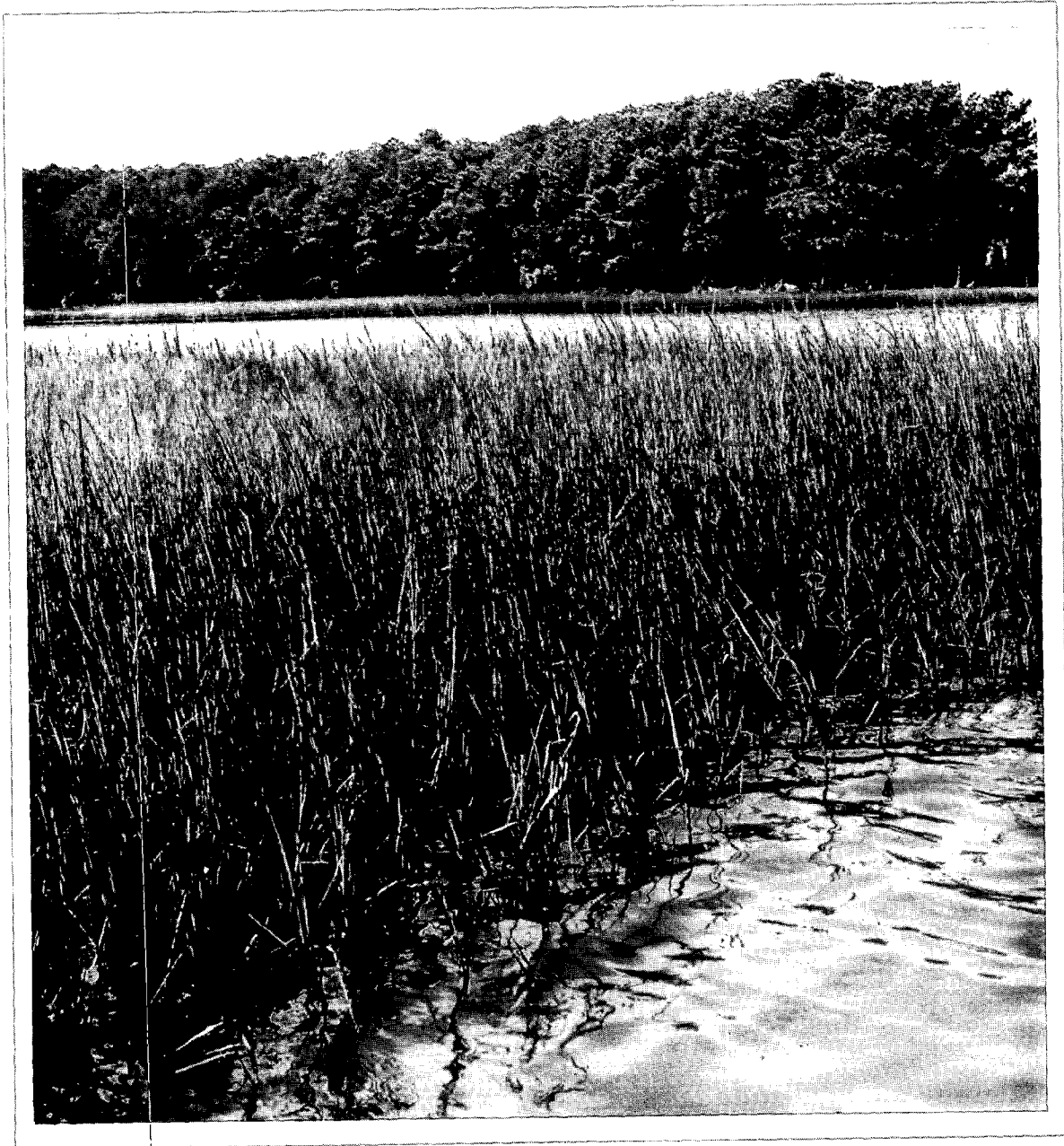

MARSH GRASS

Propagation of various species of marsh grass may be done to curb erosion along an eroding sediment bank where no marsh exists or to enhance an existing marsh shoreline. *Table 2* lists some plant species and their adaptability to tidal elevations, water and soil salinities. Fertilization of new seeds, sprigs or plugs is essential for good marsh grass growth and development.

The question arises as to the viability of marsh grass as an erosion buffer along a given shoreline. Too much open water where wave forces can build is not conducive to marsh grass growth. *Figure 23* depicts a general rule which may be applied to site suitability. This does not guarantee success, but the low cost of the method to abate shoreline erosion may warrant some experimentation.

RIVERBANK SLOPE CONTROL

Exposed sediment banks with no vegetative cover are unstable and susceptible to high rates of erosion by rainwash, groundwater and wave action. Getting some type of flora to grow on the surface of the slope will do much to reduce the erosion. However, it is often necessary to grade the bank back to reduce the slope for the planting of grasses. *Table 3* lists some plants which have been used to control riverbank erosion. Fertilization is almost essential for a good and quick growth of ground cover.

Getting vegetation established on a slope is sometimes not enough. The top or base of the bank should be stabilized to insure the rest of the graded slope remains intact. In areas susceptible to high storm wave conditions, this toe stabilization will be in the form of a bulkhead or a riprap revetment. In more protected areas, planting a marsh grass fringe may be all that is needed.

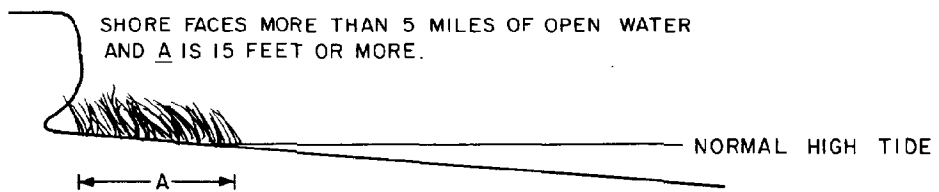

Figure 23 — Marsh site suitability scheme.

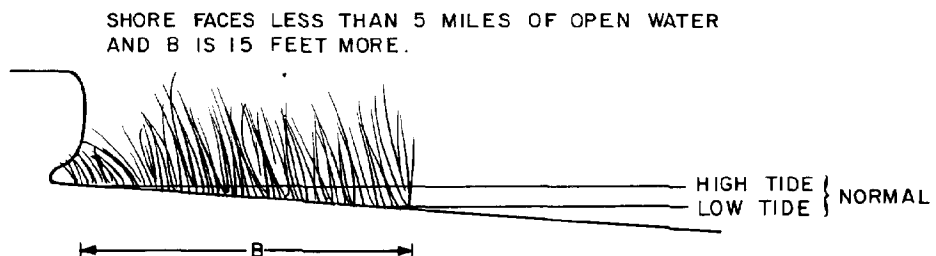

TABLE 2: MARSH PLANTS AND THEIR ADAPTABILITY TO TIDES AND SALINITY

Adaptability to Tide Elevation	Species	Adaptability to Water and Soil Salinities
MT - MHW	<i>Juncus roemerianus</i> (Needlerush)	brackish and freshwater
MT - MHW; sh	<i>Peltandra virginica</i> (Arrow-arum)	freshwater
MT - MHW; sh	<i>Pontederia cordata</i> (Pickerelweed)	freshwater
MT - MHW; sh	<i>Sagittaria latifolia</i> (Duck Potato)	freshwater
MT - MHW	<i>Scirpus americanus</i> (Common Threesquare)	brackish and freshwater
MT - MHW	<i>Scirpus robustus</i> (Saltmarsh Bulrush)	brackish and freshwater
MT - MHW	<i>Spartina alterniflora</i> (Cordgrass)	salt and brackish water
MT - MHW; sh	<i>Typha angustifolia</i> (Narrowleaf Cattail)	brackish and freshwater
MT - MHW; sh	<i>Typha latifolia</i> (Broadleaf Cattail)	freshwater
above MHW	<i>Distichlis spicata</i> (Saltgrass)	salt and brackish water
above MHW	<i>Festuca elatior</i> (Fescue, Kentucky 31)	salt-tolerant
above MHW	<i>Panicum amarulum</i> (Coastal Panicgrass)	salt-tolerant
above MHW	<i>Panicum virgatum</i> (Switchgrass)	salt-tolerant
above MHW	<i>Spartina cynosuroides</i> (Big Cordgrass)	brackish and freshwater
above MHW	<i>Spartina patens</i> (Saltmarsh Hay)	salt and brackish water
dune	<i>Ammophila breviligulata</i> (American Beachgrass)	salt-tolerant

**TABLE 3:
RIVERBANK EROSION CONTROL WITH PLANTS**

by Norman T. Beal, Extension Agent
VPI & SU Extension Division

Plants are the ultimate controllers of erosion on soils of any slope. They vary widely in their ability to be successfully established on a bank, and to thrive. They hold the soil by one principal means—their roots. Following are categories of plants that have been successfully utilized for erosion control.

GRASSES

- *Ryegrass (*Lolium* species)
- *Bermudagrass † (*Cynodon dactylon*) ††
- *Lovegrass (*Eragrostis* species)

SHRUBS

- Indian currant † (*Symphoricarpos vulgaris*)
- Florida jasmine †† (*Jasminum nudiflorum*)
- Trailing roses (*Rosa wichuriana*, *R. max* Graf.)
- Sumac † sp. (*Rhus glabra*, *R. typhina*)
- *Lespedeza (*Lespedeza sericea*)
- Forsythia †† (*Forsythia suspensa*, f.x. "Arnold's dwarf")
- Rose acacia † (*Robinia hispida*)

TREES

- Willow species*
 - *black ††† (*salix nigra*)
 - weeping ††† (*s. babylonica*)
- Poplar species*
 - Quaking aspen (*Populus tremuloides*)
 - Hybrid poplars ††† (p.x)
 - Lombardy poplar ††† (p. *nigra italica*)

*River birch (*Betula nigra*)

Maple species

- *Silver maple (*Acer saccharinum*)
- *Boxelder (*A. negundo*)
- *Fishbait tree (*catalpa speciosa*)
- *Sweetgum (*Liquidambar styraciflua*)
- *Empress tree (*Paulownia tomentosa*)

**Elm species*

- American elm (*Ulmus americana*)
- Chinese elm (*U. pumila*)

GROUNDCOVERS

- Bamboo †
 - dwarf bamboo (*Sasa pygmaea*) 18"
 - golden bamboo (*Phyllostachys aurea*) 25'
 - cane reed (*Arundinaria tecta*) 10'
- Knotweed †
 - Mexican bamboo (*Polygonum cuspidatum*) 8'
- English Ivy †† (*Lonicera halliana*)
- Halls honeysuckle (*Lonicera halliana*)
- Daylily (*Hemerocallis* species) 2'

* Established from seed

† Spreads by rhizomes

†† Roots from tips or joints

††† Establish from hardwood cuttings – early spring before leaves appear.

PHOTO AND SKETCH REFERENCES

- Figure 3. State of California - The Resources Agency, 1976, Shoreline Protection in California, p. 22.
- Figures 4, 5 and 9. Bellis, Vincent, Michael P. O'Connor and Stanley R. Riggs, 1975, Estuarine Shoreline Erosion in the Albermarle-Pamlico Region of North Carolina, pp. 27-43.
- Figure 8. Marine Resources Commission, 1974, Wetland Guidelines, p. 32.
- Figures 15B, 16B, 17B and 19B. U.S. Army Coastal Engineering Research Center, 1978, Shore Protection Manual.
- Figure 20. DeYoung, Bruce, Enhancing Wave Protection with Floating Tire Breakwaters.
- Figure 21B. Anderson, Gary L., Robert J. Byrne, David W. Byrd and Gary M. Chianakas, 1978, Demonstration Project in Low-Cost Shoreline Erosion Control, p. 13.
- Figure 23. Environmental Concern, St. Michaels, Maryland 21663.
- Photographs: VIMS Remote Sensing Center, C. Alston photos. p. 11 and p. 20.
- All other photographs VIMS/Sea Grant Shoreline Erosion Advisory Service, C. S. Hardaway photos.

REFERENCES

- Byrne, Robert and Gary Anderson. 1977. Shoreline Erosion in Tidewater Virginia. Special Report in Applied Marine Science and Ocean Engineering No. 111 of the Virginia Institute of Marine Science, Gloucester Point, VA.
- O'Connor, M. P., V. J. Bellis and S. R. Riggs. 1978. Relative Estuarine Shoreline Erosion Potential in North Carolina, Department of Geology and Botany. East Carolina University, Greenville, NC.
- Riggs, S. R., V. J. Bellis and M. P. O'Connor. 1978. Shoreline Erosion and Accretion: A Process Response of the Shore Zone and Environment of North Carolina. Department of Geology and Botany, East Carolina University, Greenville, NC.

DATE DUE			
GAYLORD No. 2333			PRINTED IN U.S.A.

The College of  William & Mary

	VIMS SEA GRANT PROGRAM	
---	---------------------------------	--

NOAA COASTAL SERVICES CENTER LIBRARY

 3 6668 14107 1698