

U.S. DEPARTMENT OF COMMERCE  
NATIONAL OCEANIC AND ATMOSPHERIC ADMINISTRATION  
NATIONAL WEATHER SERVICE  
NATIONAL METEOROLOGICAL CENTER

OFFICE NOTE 331

DEVELOPMENT OF A SCIENTIFIC BASIS FOR WEATHER PREDICTION

NORMAN A. PHILLIPS  
PRINCIPAL SCIENTIST, NATIONAL WEATHER SERVICE

MAY 1987

THIS IS AN UNREVIEWED MANUSCRIPT, PRIMARILY INTENDED FOR  
INFORMAL EXCHANGE OF INFORMATION AMONG NMC STAFF MEMBERS.

It was about forty year ago that the present World Meteorologist Organization took shape as a reorganized form of its illustrious predecessor, the International Meteorological Organization. These forty years have coincided with major advances in the technique of weather forecasting, especially the prediction of motions on the synoptic and larger scales. Three developments have supported this advance --- better data and distribution of data, vastly more powerful computing machinery, and an increased theoretical understanding of the atmosphere and the forecasting problem that it presents.

Many problems remain, however. In my view the chief limitation for reliable and accurate large scale forecasts beyond one day is inadequate data. An inability to represent moist convection in current forecast models also seems to be a serious problem, especially in warm climates. But I am not sure whether the limitation here arises from inadequate theory, from inadequate data, or whether it is perhaps a problem for which there may never be a satisfactory solution in practical terms.

Since the spatial distribution of data is not homogeneous, an important question is the following.

How rapidly do influences from a region of poor data spread to those regions for which an accurate forecast is desired?

I will devote my lecture to this topic.

It is by no means a new topic. In fact, this question seems to have been first raised by H. Ertel, some years before the age of the electronic computer. In 1939 C. Rossby published his famous wave formula based on his model of the atmosphere as a homogeneous non-divergent layer of rotating fluid. Two years later, in 1941, Ertel published a paper whose translated title is "The impossibility of exact weather forecasts based on synoptic pressure charts from limited portions of the earth." (SLIDE 1 ) In this paper Ertel derived Rossby's equations

for a barotropic model from some slightly more general principles than were used by Rossby. Please note that Ertel uses the word "exact" in his title. In the paper Ertel draws attention to the fact that the pressure tendency is determined by inverting a horizontal Laplacian operator. In other words, the pressure tendency at one point is, in principle, affected by the distribution of vorticity advection over the entire globe. Synoptic charts from a limited area, for example, the region of Europe and the North Atlantic, would not supply the needed information. Ertel also showed by calculation that if one assumed that the pressure tendency was zero on the boundary of a limited region, and then solved the Laplacian within that region, the error introduced at the boundary would extend well within the region.

Eight years later, Charney, Fjortoft and von Neumann made the first numerical forecasts on the ENIAC electronic computer. They used Rossby's barotropic model for this purpose. Contrary to Ertel's admonition, they solved the equations over a limited region (SLIDE 2 ). They did not linearize the equations as Rossby and Ertel had done, because the computer could perform the non-linear calculations almost as fast as it could do the linear equations. Today we would not consider these forecasts as very good. But they were good enough to initiate the modern era of numerical weather prediction.

From a scientific point of view, the major success of this first forecast with an electronic computer was the demonstration that a meaningful forecast was possible with Rossby's non-divergent model and, it must be added, the interpretation of that rather ambiguous concept with the help of the quasi-geostrophic theory that Charney had developed. The difficulty encountered by L. Richardson 30 years earlier was surmountable with ordinary radiosonde data. Charney's basic premise was correct --- you did not have to measure the small

difference between the true wind and the geostrophic wind to make a forecast.

What about Ertel's warning about the pitfalls of forecasting for a limited region? Before Charney, Fjortoft and von Neumann made their computations on the ENIAC, Charney had made an estimate of the smallest region for which a one-day forecast could be made, without it being contaminated by unknown influences from outside. His main tool for getting this estimate was the idea of group velocity. This concept had been introduced into meteorology in 1945 by Rossby. It can be thought of as being primarily a means to get approximate solutions to linearized equations under those special conditions where it is sufficient to consider only a narrow range of frequencies and wave-lengths. I ask your indulgence now for a quick review. (SLIDE 3 )

We consider a solution of the full set of linearized equations that has a wave-like field of this form.  $F$  is the amplitude and  $\psi$  is the phase. We begin by defining the partial derivatives of the phase with respect to time and space by the frequency for the negative time derivative, and the three wave number components  $k$ ,  $l$ , and  $m$  for the three space derivatives. The effect of physics now enters through the frequency equation that results from introducing this notation into the full set of linearized equations. We assume that  $\omega$  is real.  $\omega$  is a function of the wave numbers, and any coefficients that existed in the original linear equations. If these coefficients vary with space and time, we must allow the function  $\omega$  to also vary with space and time through the appearance of the variable coefficients in the frequency equation. A simple example is the ordinary acoustic formula where the speed of sound varies with height because the temperature varies with height.

The fact that  $\omega$  and the wave numbers are the partial derivatives of the same phase function means that they are not completely independent of one another. For example the x-derivative of the y-wave number  $l$  is equal to the y-derivative of the x-wave number  $k$ . These relationships can be exploited if we define the group velocity as follows. Its components are defined as the derivatives of  $\omega$  with respect to each of the wave numbers. The result is the following four statements. They say that the frequency and wave numbers will be constant for an observer moving with the group velocity appropriate to that frequency and wave number, except as the frequency equation has variable coefficients. An observer moving with the group velocity is said to trace out a ray.

In meteorological applications the coefficients are almost always independent of longitude and time. If we identify  $x$  as being eastward, then both  $k$  and  $\omega$  will be constant for such an observer.

Finally, we can define the wave action,  $A$ . It is equal to the wave energy  $E$ , divided by what might be called the intrinsic frequency, that is the frequency that would exist if the fluid did not have a mean motion. The energy  $E$ , is in turn proportional to the square of the amplitude  $F$ . The important thing about this is that the total amount of wave action in a volume is constant if the surface of that volume moves with the group velocity. This is expressed mathematically by this equation. For example, in places where the coefficients vary in such a way as to make the group velocity convergent, the observer moving along a ray will observe an increase in the wave action.

These ideas are related to the well-known WKB analyses that are so useful in physics. Like them, they lose their precision in circumstances where the coefficients in the equations vary significantly within one wave length.

This will be a problem for the Rossby waves of main interest to us.

Let's return now to the problem faced by Charney in 1949, in his attempt to justify the use of the new electronic computer for weather prediction. His quasi-geostrophic theory had identified Rossby waves as the primary wave process, and that acoustic or gravity waves did not play a direct role in large-scale motions. When superimposed on a uniform basic current, the Rossby frequencies are as follows (SLIDE 4). Internal waves are waves with a sinusoidal structure in the vertical. The frequencies of internal Rossby waves are given by this formula.  $\bar{u}$  is the uniform basic current, "beta" is Rossby's parameter,  $f$  is the Coriolis parameter,  $N$  is the Brunt-Vaisala frequency, and  $H$  is the pressure scale height. The frequency of these waves depends on all three wave number components,  $k$ ,  $l$ , and  $m$ . They therefore have group velocity components in all three directions.

In addition to the internal modes of oscillation, there is also an external Rossby wave. Its vertical structure is that of the trapped acoustic wave discovered many years ago by Lamb. Its frequency is given by this formula. Its frequencies are much higher than those of the internal modes. In fact, its frequencies are almost the same as that of Rossby waves for a hypothetical non-divergent atmosphere. Since its vertical structure is not sinusoidal, its group velocity is only horizontal. However, its relatively high frequency makes it the most effective means to disperse Rossby waves in the horizontal.

I draw your attention to the fact that in both formulas, the square of the wave numbers appears in the denominator. This means that the Rossby frequencies will be very small for short wave lengths, and large for large wave lengths. By the same token, we must expect that large values of the group velocity will tend to be associated with very long wave lengths.

We can now differentiate these formulas with respect to the wave numbers to get the group velocity expressions. We can then differentiate again to locate the wave number values where the group velocities will take on their maximum values. After this is done we can insert typical values for  $f$ , "beta",  $N$  and  $H$  and get the actual values. The results are on the next SLIDE (5).

These values are disconcertingly large. Perhaps the most forbidding value is the vertical component. This is associated with the internal Rossby modes. According to this figure, a two-day forecast might require initial data up to 30 kilometers. This is the limit of radiosonde observations. A forecast for only seven days, for example, would need initial data up to 100 kilometers. The maximum values for the horizontal components of the group velocity are also large. They come from the external or barotropic form of the Rossby wave.

However, we can note that in all cases, these large group velocity values occur at very long wave lengths-- for the zonal component, the meridional component, and the vertical component. These are the circumstances under which the WKB and group velocity arguments might be wrong. To consider this possibility we must investigate the exact solutions of the linearized equations, paying particular attention to the spherical geometry and the exact variation of the Coriolis parameter. Before we do this, however, let me return once more to the Ertel - Charney problem. Charney also found these large values, or at least values almost this large. He argued quite reasonably that the circumference of the earth would place a limit on how long the horizontal wave lengths could be. In this way he could argue that the  $-175$  degrees per day value for the most negative zonal group velocity should be reduced to  $-28$  degrees per day. There was not much he could do to reduce the meridional value, however. It has to

stay at about 30 degrees of latitude per day. In the case of the vertical component, it turns out that Charney made an error. His incorrect formula gave him a maximum value of only 4.5 kilometers per day, too small by a factor of three.

Charney's final argument, however, was a bold one. He argued that experience with day-to-day changes in upper-level flow patterns showed that those changes were, for the most part, limited to a moderately narrow belt of latitude. And that it could be assumed that nothing was changing at the northern and southern boundary of that channel.

Charney refers to Ertel's earlier papers only in <sup>a</sup>footnote<sup>1</sup>. This leads me to suspect that he was unaware of Ertel's work until after he had submitted his own analysis for publication. But in retrospect, I believe, it is fair to interpret Charney's resolution of this problem as follows:

Yes, Ertel is correct, and

yes, Rossby waves with long wave lengths could transmit influences rapidly,

But----- the observations indicate that this process is not too important for a one-day forecast.

We should be thankful that Charney tempered his mathematical insight with an awareness of how flow patterns seemed to change in the actual atmosphere. Otherwise he might have been dismayed at the difficulty of the forecast problem.

Nowadays, however, we are interested in making forecasts for more than one day. Some centers even have the audacity to make routine forecasts for ten days! For such forecasts we cannot pretend that the activity is limited to a limited belt of latitude --- the entire globe must be considered, and we must



depart, at least for a while, from the convenience of the WKB group velocity arguments.

The study of the global scale oscillations of the atmosphere has a long history, beginning with Pierre Laplace in the early nineteenth century. Important advances were made by many others, among whom we might especially mention Margules, Hough, and Taylor. The mathematics involved is not too exotic, but it is not trivial. A definitive study had to await the availability of modern computers. This study was done twenty years ago by Longuet-Higgins. For our purpose, we need pay attention only to his results for free oscillations. These can be divided into two Classes, a fact that was discovered independently by Margules and by Hough in the late nineteenth century. Class I contains gravity waves and internal acoustic waves. The acoustic waves disappear if we make the hydrostatic assumption. The Second Class of solutions consists of what we now call Rossby waves. The next SLIDE ( 6 ) shows the frequencies for the gravity waves and Rossby waves, corresponding to the external Lamb mode in the vertical. The abscissa is the zonal wave number,  $s$ . Positive values denote waves moving to the east, and negative values denote waves moving to the west. The ordinate is the frequency, in cycles per 12 hours.

The top set of frequency curves are for the First Class gravity waves. They have large frequencies. The number associated with each curve denotes the north-south wave number, large numbers corresponding to short north-south wave lengths. The frequency of the gravity waves increases for short horizontal wave lengths. The lower set of curves are the Rossby waves. As is well-known, they move westward in the absence of a zonal current. Their frequency gets smaller when the horizontal wave lengths get small. The highest frequency of the Rossby waves is this point. It corresponds to a period of about 20 hours,

and will move rapidly westward at the rate of about 320 degrees of longitude per day. These Rossby waves with smaller north-south wave lengths move westward much more slowly, at the rate of only several degrees of longitude per day. This difference in retrograde speed will become very significant when we come to discuss the important effect of zonal currents on Rossby waves. I have marked off a region of very small wave numbers. Lindzen and his collaborators in 1984 published a paper reporting their success in identifying the presence in atmospheric analyses at 500 mbs of height patterns that move westward in agreement with the theoretical phase speeds for Rossby waves. These are the frequencies that they found. They evidently found no evidence of waves with lower frequencies. I will later indicate why this should be so from a theoretical viewpoint.

The effective east-west group velocity can be computed by numerical differentiation of these curves. The top Rossby curve will have one peak value, directed eastward. All of the others will have two maxima. One of these will be directed westward, at small zonal wave numbers. The other maximum will be directed eastward, at larger zonal wave numbers. I have listed the values obtained in this way on the top half of the next SLIDE ( 7 ). The numbers are not noticeably smaller than the maximum values obtained from the WKB theory.

The same procedure can be applied to the dependence of the Rossby frequencies on the vertical wave number,  $m$  . When this is done, the following values result. Again, they are not smaller than the maximum value of 15 km per day obtained from the WKB approach.

In spite of this, the technique of numerical forecasting, as practiced nowadays, is capable of making forecasts in extratropical latitudes that have,

most of the time, some usefulness as long as 5 to 6 days in the future. This is being done with little or no data above 30 kilometers, and with very little data over the oceans. Evidently the theoretical group velocity arguments that I have made so far are too pessimistic. Why is this?

Part of the answer could be that there is little energy in these longest wavelengths. But much of the answer seems to be in the effect of the mean zonal wind in the atmosphere. Only a uniform zonal wind has been considered so far in the group velocity arguments. On the next SLIDE (8) I show a schematic picture of the mean zonal wind field. I have purposely made this very schematic, because I will want to avoid the possibility that the results I will soon show you depend on some small peculiarity of the assumed zonal wind field. Furthermore, on any given day, the values may differ somewhat from the seasonal mean.

On the left side is the typical distribution for the winter hemisphere and on the right side I show the typical summer hemisphere. The main differences are in the stratosphere. The winter pattern of westerly flow culminates in a strong westerly jet at 65 kilometers. In summer this stratospheric pattern is replaced by easterly flow culminating in a strong easterly jet at 65 kilometers. The eddy motion is also different in winter and summer. The next SLIDE (9) shows a flow pattern for the week centered on January 5 1972. The analysis is based mostly on rocketsonde wind data, with some help from satellite temperatures. The wind values are shown in knots, with a full triangular barb denoting 50 knots. The speeds are impressive. They reach about 100 meters per second, and the indication is that much of the energy is in very long zonal waves. For the week of August 16 1972 (SLIDE 10) the pattern is much different. The mean flow is from the east, and the eddy velocities are very much smaller.

The generally accepted theory to explain this is that put forth by Charney and Drazin in 1961. Their mathematics is condensed onto the next SLIDE ( 11 ). We start with the geostrophic potential vorticity equation for a perturbation on a zonal current  $\bar{u}$ . "Phi prime" is the perturbation geopotential. This time we will consider a variable zonal current, so that  $\bar{u}$  is a function of both latitude and height. The factor in square brackets on the right side is the latitudinal gradient of the potential vorticity in the basic state. I denote it by the symbol "beta prime". "Beta prime" is almost always positive in the atmosphere. For a traveling wave disturbance, the differential equation for the amplitude becomes this. After division by the factor  $(\bar{u} - C)$ , it takes this form. If this coefficient on the right side is positive, the solution for the amplitude will be wave-like. Since "beta prime" is positive, the condition for a wave-like solution reduces to the following.

For the simplest possible interpretation, we take the mean zonal wind to be a constant. The criterion then becomes this. This is the principal mathematical result of the Charney-Drazin paper. The most common application of these results has been for steady motion, for which we can put  $C$  equal to zero. Thus, a wave-like propagation in the meridional plane of steady Rossby waves is only possible in mean currents that are from the west, but not too strong. For nonsteady motions, with  $C$  not equal to zero, the waves must move less rapidly to the east than the basic current.

In its simplest form, this criterion did not really originate with Charney and Drazin. In 1948 Professor Paul Queney derived this criterion as the condition under which uniform flow from the west over a mountain ridge would produce a standing Rossby wave. Its significance for more general types of motion was not recognized, however, until Charney and Drazin wrote their paper.

It provides an immediate and simple explanation for the relative absence of large-scale disturbances in the summer stratosphere and in the easterlies of low latitudes.

Before leaving this slide, I draw your attention to the factor  $\bar{u} - C$ . Since it really multiplies the highest order derivatives in the equation, it will give rise to an essential singularity wherever  $\bar{u} - C$  vanishes. We will return to this later on.

Since the Charney-Drazin paper there have been many applications of linearized theory to explain the vertical and meridional propagation of large-scale wave energy. Perhaps the most successful of these was that by Matsuno in 1970, who explained the existence of the strong anticyclone that exists over Alaska in the stratosphere. (SLIDE 12 ) He did this by introducing the observed 500-mb geopotential as a known forcing at the bottom of a linear model. The agreement he reached between his theoretical result and the observations is remarkable. Since that time his results have been interpreted in terms of group velocity by Hayashi and by Held. According to them, the anticyclone is caused by air flow over the Himalayas. An important role in producing the main response in the stratosphere and over Alaska is played by the baroclinic zonal current. It does this by sorting out the response of different vertical wave numbers to orographic forcing at a point source.

Another popular steady state problem has been the latitudinal propagation of eddy energy into higher latitudes from a hypothetical steady source of vorticity in equatorial latitudes. One can imagine that a maintained area of convection would create a steady pattern of divergence aloft, which, if it were not exactly on the equator, could give rise to a fixed source of anticyclonic vorticity. According to the Charney-Drazin theorem, this will not propagate

into higher latitudes unless the convection were occurring in a region where the mean zonal winds were from the west. The central and western longitudes of the Pacific Ocean are regions where the mean zonal flow in the upper troposphere is often westerly instead of the weak easterlies that characterize the tropical belt as a whole. Hoskins and his collaborators at the University of Reading have used linear models to calculate the vorticity patterns that are set up in response to this steady forcing. Similar ideas were advanced in the early years of this decade by Webster, Opsteegh and van den Dool. This process is one of the hypotheses in the TOGA part of the World Climate Research Program.

The linear model calculations by Hoskins and Karoly lend themselves to a particularly clear visualization in terms of the group velocity of barotropic Rossby waves. In this problem, as in others, horizontal dispersion is done most effectively by the external or barotropic mode of the Rossby waves. On the other hand, convection will normally produce cyclonic vorticity in low levels and anticyclonic vorticity at upper levels. This pattern will project onto internal Rossby modes; it will not produce any energy in the external mode. But a baroclinic current can convert internal mode Rossby energy into energy of the external mode, as has been shown recently by Kasahara and da Silva Diaz.

The next SLIDE ( 13 ) introduces the notation used by Hoskins and Karoly. They use Mercator coordinates  $x$  and  $y$  instead of longitude ' $\lambda$ ' and latitude ' $\theta$ '. The barotropic Rossby frequency formula takes this form:  $u_M$  is the basic current divided by the cosine of the latitude, and  $\beta_M$  ("beta sub m") is proportional to the gradient of the mean vorticity. In terms of the general WKB theory I showed earlier, this frequency relation has a dependence only on  $y$ . Therefore the frequency " $\omega$ " and the zonal wave number (" $k$ ")

will be constant along a ray. Only the y wave number "l" will change along a ray.

It is very convenient to organize things around the stationary wave number "K<sub>s</sub>" introduced by Hoskins and Karoly. This is the value of the two-dimensional wave number that will result in a frequency of zero. K<sub>s</sub> is a function of y. A typical distribution is shown here. In very low latitudes, K<sup>s</sup> is imaginary because u is negative. North of the zero wind line it has its largest value, and then decreases at higher latitudes.

I will soon show you a graphical picture of this dispersion relation . In order to do so, it is convenient to use K<sub>s</sub> to make the horizontal wave numbers non-dimensional. We will make the frequency non-dimensional with the factor  $\bar{u} K_s$  . This gives us a simple non-dimensional form for the frequency equation. Zero frequency is now set by having the square of the non-dimensional wave numbers equal to one. The real group velocity is now simply  $\bar{u}$  times the non-dimensional group velocity.

This next SLIDE (14) is a graph of this non-dimensional frequency equation. The abscissa is the non-dimensional x wave number, and the ordinate is the non-dimensional y wave number. The frequency is zero along the ordinate and on the circle whose radius is one. The group velocity is given by the gradient of the frequency with respect to the wave numbers. It is therefore perpendicular to isolines of constant frequency. The OVERLAY to this slide contains arrows indicating the direction of the group velocity. At large wave numbers the group velocity is directed toward the east. This represents conditions where the wave number is so large that the Rossby effect can be ignored, and the eastward advective effect of the basic current is the only important process. At small wave numbers inside the circle, we have a contrasting picture, with a considerable variety of directions, and, as shown by the large gradient of

the frequency, we have large values of the group velocity.

Two additional points about this diagram are important. First, the third quadrant is the image of the first quadrant; The frequency and both wave numbers have changed sign, but the phase velocity and group velocities are not changed. Similarly, the second quadrant is the image of the fourth quadrant. It is therefore sufficient for us to consider only the first and fourth quadrants.

The second important point concerns the circle of zero frequency. Along this circle the group velocity has a very simple distribution. It is directed outward along the wave number vector, and always with an eastward component. The magnitude changes from zero when  $k'$  is zero to a value of two when  $l'$  is zero. I think you can see why there have been many studies of the dispersion of steady state Rossby waves, and almost no studies of the dispersion of non-steady Rossby waves!

Suppose we have a steady vorticity source at some latitude where the zonal wind is from the west. The shape of the source will select the dominant values of the wave numbers near the source. The localized nature of the source will require all combinations of  $k'$  and  $l'$ . We see immediately that the final steady-state wave train that results will consist of one ray that takes off on a path to the northeast, and one that takes off to the southeast. As the rays leave the source, in the final steady state, they must satisfy the WKB requirement that the frequency is zero, and that the dimensional zonal wave number  $k$  stays constant. These two conditions are expressed by this relation for  $l'$ . On the previous slide we saw that  $K_g$  decreases poleward. Along the northeastward ray,  $l'$  is positive, and it will therefore decrease in magnitude. The ray point stays on the unit circle, however, and therefore the ray must



become oriented in a more zonal direction. A more detailed analysis shows that it will reach a limiting latitude as  $l'$  passes through zero. At this time the wave energy density along the ray path will be a maximum. This latitude is called the "turning point" latitude. The ray is gradually reflected here and moves off to the southeast.

The southeastward ray starts out from the source region with a negative value of  $l'$ . It will encounter increasing values of  $K_S$  as it moves equatorward, It therefore acquires an increasingly negative value of  $l'$ , and turns more and more toward the equator. The magnitude of the group velocity grows smaller, but the ray will eventually reach the critical latitude where the zonal current vanishes. The proper way to resolve this singularity is not known. It is possible to do so mathematically by invoking either viscosity, or non-linear effects. Some years ago, Dickenson studied the mathematics of this singularity. He showed that it would take a long time, of the order of a month, in order to establish the idealized singularity that is called for by the assumption of a wave moving steadily with the zonal speed "C". In any event, there seems to be no recognition by the atmosphere of this mathematical singularity. At least I know of no synoptic analyses that document special phenomena that occur at a critical latitude.

The next SLIDE ( 15 ) is an example of ray paths computed by Hoskins and Karoly for a basic zonal wind at 500 mbs. They show only the northeastward ray because the hypothetical steady vorticity source is located at 15 degrees latitude, very close to the critical latitude at 500 millibars. These paths also showed up in the patterns of vorticity response that they obtained by using a complete linearized model with 5 layers and a hypothetical vorticity source in the subtropics. It is these ray paths that are thought to be related

to the teleconnection patterns of high correlation that have been described by Wallace and Gutzler ( SLIDE 16 ) . The final answer on this subject is not in yet, however. Lindzen, for example, has recently expressed a warning that the responses to fixed vorticity sources can be quite sensitive to the pattern of zonal winds that are used in the linear model.

These steady state solutions are very suggestive and interesting, but I personally find that the presence of the critical singularity is bothersome and artificial. When Charney made his study of the theoretical spread of horizontal influences, he and his collaborator Arnt Eliassen supplemented their consideration of the east-west group velocity with a calculation of what they called the "influence function". This was in effect a "Greens function" in the normal mathematical sense, in that it was the function that directly mapped the initial field as a function of longitude, into the forecast solution for some later time. I have therefore done a similar thing for a barotropic influence function with respect to latitude.

The principal technical difference is that Charney and Eliassen had a vorticity equation with constant coefficients. They could therefore compute the influence function precisely. We here are interested in the effect of a variable zonal mean current. The calculation must therefore be done numerically.

The procedure is quite straightforward. The final result will be in the form of a sum over latitude. (SLIDE 17) It is therefore best to use the sine of the latitude as the latitude variable. The computations are done separately for each zonal wave number. The barotropic vorticity equation for this wave number is simply expressed numerically with finite differences in the sine of the latitude. Suppose we are interested in the influence function for a particular

latitude. Let's call this the "output latitude". To compute the influence function for a forecast at this output latitude, we begin by making a forecast in which the initial value is set equal to zero everywhere except at one latitude, where it is given a value of one. We can call this the "input latitude". The forecast values at the "output latitude" are recorded. The forecast is then repeated with a new "input latitude", and so on until all latitudes have had their turn as an input latitude. In the computations I used 100 latitudes between the poles, and Runge-Kutta 4-th order integration with a two-hour time step.

I have computed eight such influence functions. I did it for the output latitude of 0 degrees and for the output latitude of 45 degrees north. For each of these I computed the influence function for zonal wave number two and six. Finally, I did the computations for an atmosphere with no zonal wind and for an atmosphere with a very simple zonal wind profile. That profile is shown here. It has a broad jet of 20 meters per second at 30N, and a weak easterly wind of 4 meters per second at the equator. It was symmetric in latitude, and the mean vorticity gradient was everywhere positive. The extreme values of the zonal current were based on the well-known climatological compilations by Oort and Rasmussen. But I forced them into a smooth symmetric pattern so as to avoid any sensitivity to accidental irregularities. Furthermore, the longitudinally averaged zonal wind can change from week to week. Care was taken that the numerical treatment was accurate, by doing some sample calculations with 200 points and with time steps of one hour, and by solving test cases corresponding to Rossby-Haurwitz waves.

The answers are in the form of complex numbers. This is because they must propagate in latitude both the phase and amplitude of the zonal wave number in question. The forecast streamfunction distribution at the output

latitude has this form. In my diagrams I will show only the absolute value of  $I$ . Cancellation could occur if the phase of the answers varied rapidly with the input latitude. This did not occur.

We look first at the influence function for the equator, i.e. the output latitude was zero.(SLIDE 18) The top diagram is for zonal wave number two and the bottom part of the diagram is for zonal wave number six. The left side of the diagram is for the case of no basic current, and the right side is for the simple symmetric zonal wind. Since the zonal wind is symmetric, the response at the equator is symmetric, so I need show only one hemisphere. In the case of no zonal wind, influences from middle latitudes appear quickly at the equator. They do this at the rate of about 30 degrees per day, in agreement with the WKB group velocity calculations for zonal wave number two. The patterns persist in an oscillatory manner, indicating an awareness of the possible existence of the fundamental Rossby modes of oscillation in a resting atmosphere.

On the right side we see the effect of adding the basic current. The symbol  $J$  marks the latitude of the jet maximum, and the heavy bar here shows where the zonal wind is easterly. At day one there is little difference from the no wind case. But at later days, the influence of the higher latitudes is less than it was at one day, by a factor of approximately two.

The bottom part of the diagram is for zonal wave number 6. The addition of the basic current has an even more pronounced effect here than it did for wave number 2. The disruptive effect of the basic current now shows up already at day one, and the reduction of the middle latitude influence at later days is more marked.

An explanation for this behavior can be found in a theorem derived by Dikii and Kitayev (SLIDE 19). They studied the character of the normal modes of oscillation that can exist in a barotropic atmosphere with a zonal flow that varied with latitude. "Alpha" denotes the angular velocity of the basic flow. They showed that any discrete modes must have a zonal angular velocity that is more retrograde than the minimum angular velocity present in the basic current, and that the remaining modes will form a continuous spectrum whose angular velocities are less than the maximum angular velocity present in the basic current. Evidently the symmetric zonal profile I have used is enough to eliminate all discrete modes for wave number six.

The influence function for 45N with zonal wave number two is on the next (SLIDE 20). When there is no basic current, we again see a sensitivity to the possible presence of normal modes of large scale . At 8 days, for example, the forecast at 45 degrees in the Northern Hemisphere is influenced as much by initial conditions in the Southern Hemisphere as it is by initial conditions in the subtropics of the Northern Hemisphere. The addition of a zonal current again changes this. The influence of the opposite hemisphere is reduced, and we find an increased sensitivity to initial conditions at latitudes between the easterlies and the jet maximum. This latter effect seems to be even larger than the effect of initial conditions at 35 and 40 degrees, that are closer to the output latitude. I have no explanation for this.

The next SLIDE (21) is again for the output latitude of 45 North , but for wave number six. It shows the same behavior as the previous slide showed for wave number two, but more markedly so.

These results verify the qualitative conclusions that meteorologists have reached from the steady state form of the Charney-Drazin theorem. But they do so without the confusion of the critical latitudes:

The average distribution of zonal wind in the troposphere is such as to inhibit the latitudinal dispersion of influences into, out of, and through the tropical easterlies in a barotropic mode.

I believe that it is impossible to overestimate this fact from a historical point of view. You recall that I began this lecture by pointing out the profound difference between the conclusions of Ertel and Charney: Ertel concluded that any exact prediction must include the entire globe, whereas Charney postulated that reasonably accurate forecasts could be obtained by considering only a limited portion of the globe. We now see the theoretical reason why Charney's hypothesis turned out to be correct. I look at this partial insulation of the main latitude belts from one another as an exceptionally fortunate feature for the development of meteorological science. It provided a protected environment in which numerical weather prediction could be tested and proved without the need for global data sets, and with only the most limited of electronic computers.

I have of course overstated the case somewhat, for dramatic effect. The statement does not apply, as we have seen, to the barotropic modes of very large scale. These are relatively unaffected by the zonal winds because of their rapid retrogression toward the west. The existence of these modes has now been documented very well. I referred to this when I showed you the sample frequency curves for the global barotropic Rossby modes. This documentation is a fascinating story, but one that we do not have time enough to dwell on today. For our purposes it is sufficient to note that their amplitudes are small enough that only occasionally do they seem to contribute significantly

to anomalies in the large-scale flow patterns.

A second exception is one that I have also mentioned earlier. This is that at higher elevations, the mean zonal wind in the tropics is not quite so easterly as it is at 500 millibars. And in certain longitude belts, for example, the eastern Pacific, the average zonal wind is from the west. Webster and Holton, and Simmons, have shown that this can provide a duct through which disturbances of relatively short zonal scale can propagate into the opposite hemisphere.

Let us turn attention now to the vertical propagation of influences. In a resting atmosphere the WKB treatment indicated propagation speeds as high as 16 kilometers per day for motions of large horizontal scale, while the Charney-Drazin theorem showed that vertical propagation would not be possible through the summer easterlies, and that only motions of very large horizontal scale might be able to propagate through the strong westerlies of the winter stratosphere. Dickenson studied the winter stratospheric problem in a more quantitative manner in the late 1960's. (SLIDE 22) He showed that steady state perturbations generated in the winter troposphere could propagate vertically along two paths. These paths would avoid the strong westerlies in the mean stratospheric jet. One path was upward and toward higher latitudes. He called this the "polar wave guide". You remember that the sample map I showed for a January week at the 0.4 millibar level had most of the strong flow at high latitudes, north of 50 degrees. This seems to verify Dickenson's theory for the polar wave guide. Dickenson also found a possibility for wave energy to go up and equatorward. He concluded that this was not too efficient a path, however, because wave energy could be absorbed at the zero wind line where the winter stratospheric westerlies change into the summer easterlies of the opposite hemisphere.

Almost all studies of vertical propagation, like those of Dickenson that I just described, and the study by Matsuno that I referred to earlier, have concentrated on the steady state and on the upward propagation of influences. From the point of view of forecasting, however, a more relevant question would seem to be

Is it important that the initial conditions for a numerical forecast include an accurate representation of flow patterns in the upper stratosphere?

If those regions contain little or no eddy energy, the answer to this question is presumably no. The slide that I showed earlier for a sample week in January at the 0.4 millibar level had maximum winds somewhat in excess of 100 meters per second, and that most of the eddy energy seemed to be in zonal wave numbers one and two. Does this represent a significant amount of energy?

All types of perturbation analyses agree that the proper measure of energy density includes a normalization factor proportional to the mean density. The measure I will use is that suggested by Eckart in his book on atmospheric and oceanic hydrodynamics. (SLIDE 23) His analysis suggests an additional factor proportional to the speed of sound in the basic state. This is a small effect compared to that of the mean density. On this graph I have plotted, as a function of latitude, the root mean square velocity that Oort and Rasmussen find to be typical of the stationary eddies in winter at the level of 200 millibars, located around a height of 12 kilometers. These values are appropriate for comparison because they have a large horizontal scale, similar to the eddies at 0.4 millibars. The 0.4 millibar surface is at a height of about 50 kilometers. The ratio of the Eckart density factor between these two levels is about 14. I have therefore relabelled the ordinate on the



right side by a factor of fourteen. The speeds on the 0.4 millibar map included the mean zonal wind as well as the eddies. It therefore seems that the kinetic energy density at the 50 kilometer level is somewhat smaller than that at the 200-mb level near the tropopause. However, once we have done this normalization, the total amount of energy in a layer is given by an integral with respect to height. Numerical models nowadays normally pay attention to data up to about only 25 kilometers. There seems to be plenty of energy to worry about above this height, and we cannot simply dismiss the middle and upper parts of the stratosphere because they do not contain enough energy. The maximum vertical group velocity of about 15 kilometers per day of course does not mean that all of the influence will propagate at this speed, but the theoretical indications are that this should be considered.

Some practical information on this point is available from a study in 1981 by Derome. He examined the development with time of the errors in zonal wave number two in an ensemble of seven 10-day forecasts by the European Center for Medium Range Weather Forecasts. Hollingsworth and other scientists at the Center had studied these forecasts previously. They showed that these forecasts had a persistent error in zonal wave number two in moderately high latitudes. This error was in the form of two negative centers in 500-mb height and sea-level pressure centered over the west coast of Canada and over Europe. Later studies showed this error pattern to be common, and I believe that it still forms part of the systematic error of the ECMWF forecasts. Derome plotted the average error in wave number two at 56 degrees North as a function of pressure and time. This next SLIDE (24) shows his results, replotted as a function of height and time. The error appears first at the top of the model, located at about 25 millibars, or about 25 kilometers.

The dashed lines show slopes of 6 kilometers per day, 4 kilometers per day, and 2 kilometers per day. The downward progression of the error is most rapid in the beginning, quite in accordance with a large value for the maximum vertical group velocity. At later times the progression is not so rapid, and is more consistent with non-extreme values for the vertical group velocity.

In a related study, Beaudoin and Derome reexamined the model that Matsuno used to explain the stratospheric Aleutian anticyclone. In his numerical model Matsuno had a top at 65 kilometers and a vertical finite-difference increment of 2.5 kilometers. Beaudoin and Derome repeated the calculation by varying top height, varying the top boundary conditions, and varying the vertical resolution. Their results are summarized in the next (SLIDE 25 ). The radiation condition that they refer to is the boundary condition used by Matsuno. It is one that is readily applied to linearized equations and amounts to selecting only that part of the linearized solution that corresponds to an upward propagation of energy through the top boundary. This is not a straightforward matter to use in non-linear numerical integrations, however, where the normal practice is instead to set the vertical velocity equal to zero at the top. Beaudoin and Derome found this practice to be satisfactory if the top was at 65 kilometers. They also found that a vertical resolution of 5 kilometers seemed to be satisfactory if the top was as high as 65 kilometers. Their results are for a steady state, and address only the problem of calculating the upward propagation of influence. If their results also apply to downward transmission some simple arithmetic shows that serious tests of the influence of the upper stratosphere would require only a modest increase in the total number of levels in the present state-of-the art forecast systems.

Mechoso and his collaborators at the University of California have published a study recently in which they explored the benefit of including additional layers in the middle stratosphere to a global forecast model. Their experiments were not very many. But they indicate that a better representation of the middle and upper stratosphere can make a difference in forecasts beyond 5 days.

We have looked now at the development of theory and understanding of the spread of large-scale influences with latitude and with height. I will close with some examples of the zonal propagation of errors, because I think they bring home very dramatically the limitation that inadequate data now imposes on the accuracy of numerical weather prediction beyond one or two days. The first SLIDE ( 26 ) is from a theoretical calculation I made in 1976. This was a study to examine what improvement in forecasts might be expected from the availability of satellite temperatures over the oceans. The diagram shows the theoretical estimate of the growth and movement of errors at 500 millibars as a function of longitude, and time. The cross-section has the Pacific Ocean on the left, and part of the Atlantic Ocean on the right. Forecast time, in days, increases downward from the top of the chart.

The initial errors begin with a value of about 10 meters over North America, where the radiosonde coverage was dense. In this example, there were no satellite temperatures over the ocean, but, on the other hand, it was assumed that there was no analysis error at sea-level. Over the Pacific the hypothetical analysis system therefore assigned moderately large initial errors, as large as 40 meters. The errors move eastward and amplify as the process of baroclinic instability in the model begins to operate on the errors. The calculations assumed a perfect forecast model, so the large errors developing over North America are due solely to errors in the initial analysis.

By ten days the maximum errors are well on their way to Europe.

The next SLIDE ( 27 ) shows some statistics of error fields for the month of December 1986 from one of the models at the National Meteorological Center in Washington. The top chart is the mean 500-millibar map for the month. The four lower diagrams show the standard deviation of the errors for 12-hour forecasts, for 24-hour forecasts, for 36-hour forecasts, and for 48-hour forecasts. The heavy line on each of these charts shows the average eastward displacement with time of this hypothetical line of particles that is located just off the west coast at zero hours. The errors progress somewhat faster than this mean motion line, either because of Rossby wave dispersion, because the winds are stronger at higher elevations, or because of an overall increase in the error level from instabilities.

I make similar charts every month for all of the standard models at the National Meteorological Center. I also do this for the forecasts that we receive from the Meteorological Office of the United Kingdom and from the European Center. The models differ from one another mostly with respect to their average errors. But the distribution in space and time of the standard deviation of the errors is similar for all the models, in pattern and amplitude. Between them the five models represent quite different methods of analysis, methods of integration, and also methods of calculating physical processes.

A particularly striking individual example is shown by the 48-hour forecasts made from 1200 Greenwich on the 29 of January, 1987 (SLIDE 28 ). Here is the initial flow pattern over North America at 500 millibars, and the flow pattern 48 hours later. Each of 5 models made large errors in forecasting the development of the trough in the center of the United States and the behavior of the trough that started off the West Coast.

The next SLIDE (29) has the errors from the new regional model that has been in operation for two years. Notice that the errors are already large at 12 hours, when they consist only of this positive and negative couplet. During the next 36 hours of the forecast these move eastward, and a new positive error center develops in advance of them. This type of development downstream is a common one, and was explained theoretically many years ago by Rossby and his student T.C. Yeh. It is illustrated very well in the so-called "transplant experiment" in the joint FGGE report by the European Center, the Meteorological Office of the United Kingdom, and the National Meteorological Center. The next SLIDE ( 30 ) is from the old regional model used in Washington. It has the same error pattern. The next SLIDE (31) is from the global model used in Washington. The error pattern repeats. The next SLIDE (32) is from the British forecasts. It also has this error pattern. Finally, we have the forecast errors made by the European Center model. (SLIDE 33 ).

It might be thought that satellite data would have corrected this analysis error. There was essentially no satellite data available for the Washington and British analyses in this region for the 1200 Greenwich analysis. But there was a great deal of satellite data in the eastern Pacific six hours earlier (SLIDE 34 ).

The conclusion seems inescapable to me that numerical modelling in extra-tropical latitudes has reached the point where data limitations over the oceans is now the major obstacle to improving the range of accurate forecasts.

Let me bring this rather long lecture to a close by summarizing the three principal points I have tried to make.

1. Latitudinal propagation of errors.

The climatological distribution of mean zonal wind acts to reduce the rapid latitudinal transfer of influences. This was important in the first two decades of numerical prediction when computers were limited and global data did not exist.

2. Vertical propagation of errors.

There is evidence that initial conditions throughout the stratosphere should be considered in making forecasts beyond five days. Models must have reasonable vertical resolution in that region.

3. Zonal propagation of errors.

Analysis errors over the oceans have become the main source of error in large scale forecasts in the extratropics.

## REFERENCES

- Beaudoin, C., and J. Derome, 1976: On the modelling of stationary waves. Atmosphere, 14, 245-253.
- Charney, J., 1949: On a physical basis for numerical prediction of large-scale motions in the westerlies. J. Meteor., 6, 371-185.
- Charney, J., and P. Drazin, 1961: Propagation of planetary-scale disturbances from the lower into the upper atmosphere. J. Geo. Res., 66, 83-109.
- Charney, J., and A. Eliassen, 1949: A numerical method for predicting the perturbations of the middle-latitude westerlies. Tellus, 1, no. 1, 38-54.
- Charney, J., R. Fjortoft, and J. von Neumann, 1950: Numerical integration of the barotropic vorticity equation. Tellus, 2, 237-254.
- Derome, J., 1981: On the average errors of an ensemble of forecasts. Atmosphere, 19, 103-127.
- Dickenson, R., 1968: Planetary Rossby waves propagating vertically through weak westerly wind wave guides. J. Atm. Sci., 25, 984-1002.
- Dickenson, R., 1970: Development of a Rossby-wave critical level. J. Atm. Sci., 27, 627-633.
- Dikii, L., and V. Katayev, 1971: Calculation of the planetary wave spectrum by the Galerkin method. Izv. Atm. Oceanic Phys., 7, 1031-1038. (Eng. transl. Amer. Geophys. Union, pp 682-686.)
- Eckart, C., 1960: Hydrodynamics of oceans and atmospheres. Oxford, Pergamon, 290 pp.
- Ertel, H., 1941: Die Unmöglichkeit einer exakten Wetterprognose auf Grund synoptischer Luftdruckkarten von Teilgebieten der Erde. Meteor. Z., 58, 309-313.
- Ertel, H., 1944: Wettervorhersage als Randwertproblem. Meteor. Z., 61, 181-190.
- Finger, F., et al., 1975: Synoptic analyses, 5-, 2-, and 0.4 millibar surfaces for January 1972 through June 1973. NASA SP-3091, Washington, 205 pp.
- Hayashi, Y., 1981: Vertical-zonal propagation of a stationary planetary wave packet. J. Atm. Sci., 38, 1197-1205.
- Held, I., 1983: Stationary and quasi-stationary eddies in the extra-tropical atmosphere. In Large-Scale Dynamical Processes in the Atmosphere, Ed. B. Hoskins and R. Pearce., Acad. Press, London, 397 pp.
- Hollingsworth, A., K. Arpe, M. Tiedtke, M. Capaldo, and H. Savijarvi, 1980: The performance of a medium range forecast model in winter--impact of physical parameterizations. Mon. Wea. Rev., 108, 1736-1773.
- Hollingsworth, A., A. Lorenc, M. Tracton, K. Arpe, G. Cats, S. Uppala, and P. Kallberg, 1985: The response of numerical weather prediction systems to FGGE level IIB data. Part I: Analyses. Q. J. Royal Meteor. Soc., 111, 1-66.

- Hoskins, B., and D. Karoly, 1981: The steady linear response of a spherical atmosphere to thermal and orographic forcing. J. Atm. Sci., 38, 1179-1196.
- Lindzen, R., D. Straus, and B. Katz, 1984: An observational study of large-scale atmospheric Rossby waves during FGGE. J. Atm. Sci., 41, 1320-1335.
- Longuet-Higgins, M., 1968: The eigenfunctions of Laplace's tidal equations over a sphere. Phil. Trans. Royal Soc., London, A, 1132, 262, pp 511-607.
- Matsuno, T., 1970: Vertical propagation of stationary planetary waves in the winter Northern Hemisphere. J. Atm. Sci., 27, 871-883.
- Mechoso, C., M. Suarez, K. Yamazaki, A. Kitoh, and A. Arakara, 1986: Numerical forecasts of tropospheric and stratospheric events during the winter of 1979: Sensitivity to the model's horizontal resolution and vertical extent. In Anomalous Atmospheric Flows and Blocking. (R. Benzi, B. Saltzman, and A. Wiin-Nielsen, Eds.) Adv. in Geophysics, 20. Acad. Press, New York, 459 pp.
- Opsteegh, J. and H. van den Dool, 1980: Seasonal differences in the stationary response of a linearized primitive equation model: Prospects for long range weather forecasting? J. Atm. Sci., 37, 2169-2185.
- Phillips, N., 1976: The impact of synoptic observing and analysis systems on flow pattern forecasts. Bull. Amer. Meteor. Soc., 57, 1225-1240.
- Queney, P., 1948: The problem of airflow over mountains: a summary of theoretical studies. Bull. Amer. Meteor. Soc., 29, 16-26.
- Wallace, J. and D. Gutzler, 1981: Teleconnections in the geopotential height field during the Northern Hemisphere winter. Mon. Wea. Rev., 109, 784-812
- Webster, P., and J. Holton, 1982: Cross-equatorial response to middle-latitude forcing in a zonally varying basic state. J. Atm. Sci., 39, 722-733.



# Meteorologische Zeitschrift

Herausgegeben von

Dr. F. Steinhäuser, Wien, Hohe Warte und Dr. R. Süring, Potsdam, Kastanien-Allee 28

Bd. 58, Heft 9

Braunschweig

September 1941

Die Unmöglichkeit einer exakten Wetterprognose auf Grund synoptischer  
Luftdruckkarten von Teilgebieten der Erde

Mit 2 Abbildungen

Von Hans Ertel, Meteorologisches Institut der Universität Berlin

$$D = \frac{\partial}{\partial t} + \frac{U_{\lambda}}{a \cos \varphi} \frac{\partial}{\partial \lambda} = \frac{\partial}{\partial t} + \Omega \frac{\partial}{\partial \lambda}$$

$$D \operatorname{div} \operatorname{grad} p + \frac{2 \omega}{a^2} \frac{\partial p}{\partial \lambda} = 0$$

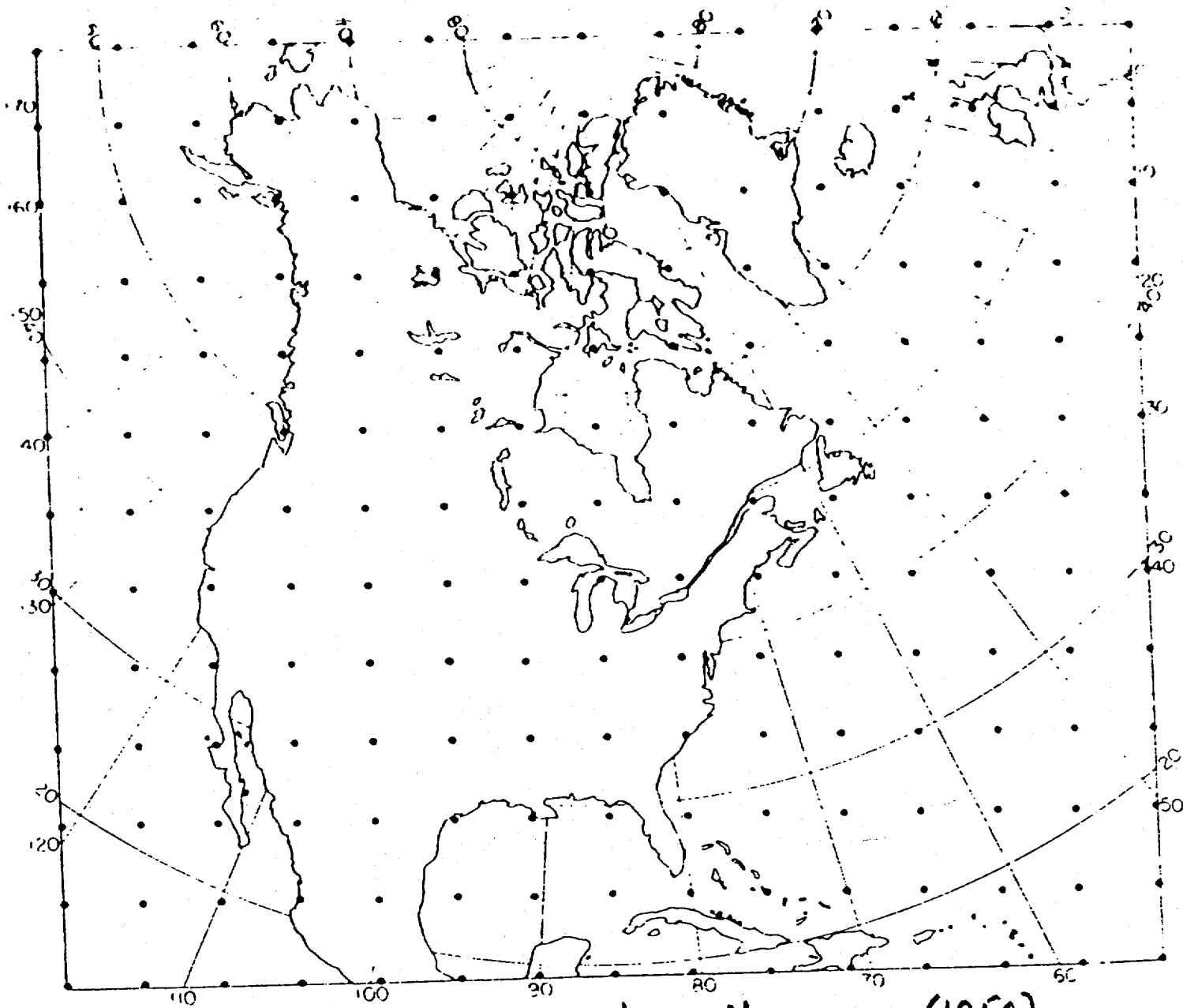

*Charney, Fjørtoft and von Neumann (1950)*

Fig. 1. A typical finite-difference grid used in the computations. A strip two grid intervals in width at the top and side borders and one grid interval in width at the lower border is not shown.

$$f = \text{Re } F(\underline{x}, t) e^{i\psi(\underline{x}, t)}$$

FREQUENCY:  $\omega = -\partial\psi/\partial t$

WAVE NUMBER:  $k = \partial\psi/\partial x$

$$l = \partial\psi/\partial y$$

$$m = \partial\psi/\partial z$$

FREQUENCY FORMULA:

$$\omega = \Omega(k, l, m; \underline{x}, t)$$

EXAMPLE:  $\omega^2 = C_s^2 (k^2 + m^2)$ ,  $C_s^2 = \gamma RT(\rho)$ .

---

GROUP VELOCITY:

$$\underline{C}_{mg} \equiv \frac{\partial\Omega}{\partial k}, \frac{\partial\Omega}{\partial l}, \frac{\partial\Omega}{\partial m}$$

$$\frac{\partial\omega}{\partial t} + \underline{C}_{mg} \cdot \nabla\omega = -\frac{\partial\Omega}{\partial t}, \quad \frac{\partial l}{\partial t} + \underline{C}_{mg} \cdot \nabla l = \frac{\partial\Omega}{\partial y}$$

$$\frac{\partial k}{\partial t} + \underline{C}_{mg} \cdot \nabla k = \frac{\partial\Omega}{\partial x}, \quad \frac{\partial m}{\partial t} + \underline{C}_{mg} \cdot \nabla m = \frac{\partial\Omega}{\partial z}$$

RAY:  $d\underline{x}/dt = \underline{C}_{mg}$ .

---

WAVE ACTION:  $A = \frac{\text{Energy}}{\omega - \underline{k} \cdot \underline{U}}$ ,

Energy  $\propto |F|^2$

$$\frac{\partial A}{\partial t} + \nabla \cdot A \underline{C}_{mg} = 0$$

# ROSSBY WAVES ON UNIFORM CURRENT $\bar{u}$ .

INTERNAL MODES:

$$\omega = k\bar{u} - \frac{\beta k}{k^2 + l^2 + \frac{f^2}{N^2} \left[ m^2 + \frac{1}{4H^2} \right]}$$

$$\beta = \frac{df}{dy} = 2\Omega \cos\vartheta / a$$

$$f = 2\Omega \sin\vartheta,$$

$$N^2 = g \frac{d \ln \theta}{dz},$$

$$H = \frac{RT}{g} \sim 7 \text{ kms}$$

$$\frac{f^2}{N^2} \sim 10^{-4}$$

EXTERNAL MODE: ("Barotropic")

$$\omega = k\bar{u} - \frac{\beta k}{k^2 + l^2 + f^2/c_s^2}$$

$$\omega(\text{EXT}) \gg \omega(\text{INT})$$

## MAXIMUM ROSSBY GROUP VELOCITIES

Zonal (to East)  $\bar{u} + 20 \text{ m sec}^{-1} = \bar{u} + 22 \text{ deg. long./day}$   
at  $L_x = 12,000 \text{ km}$   
 $L_y = \infty$

Zonal (to West)  $\bar{u} - 159 \text{ m sec}^{-1} = \bar{u} - 175 \text{ deg. long./day}$   
at  $L_x = \infty$   
 $L_y = \infty$

Meridional  $\pm 40 \text{ m sec}^{-1} = \pm 31 \text{ deg. lat./day}$   
at  $L_x = L_y = 28,000 \text{ km}$

Vertical

$15 \text{ km day}^{-1}$   
at  $L_x = 20,000 \text{ km}$   
 $L_y = \infty$   
 $L_z = 200 \text{ km.}$

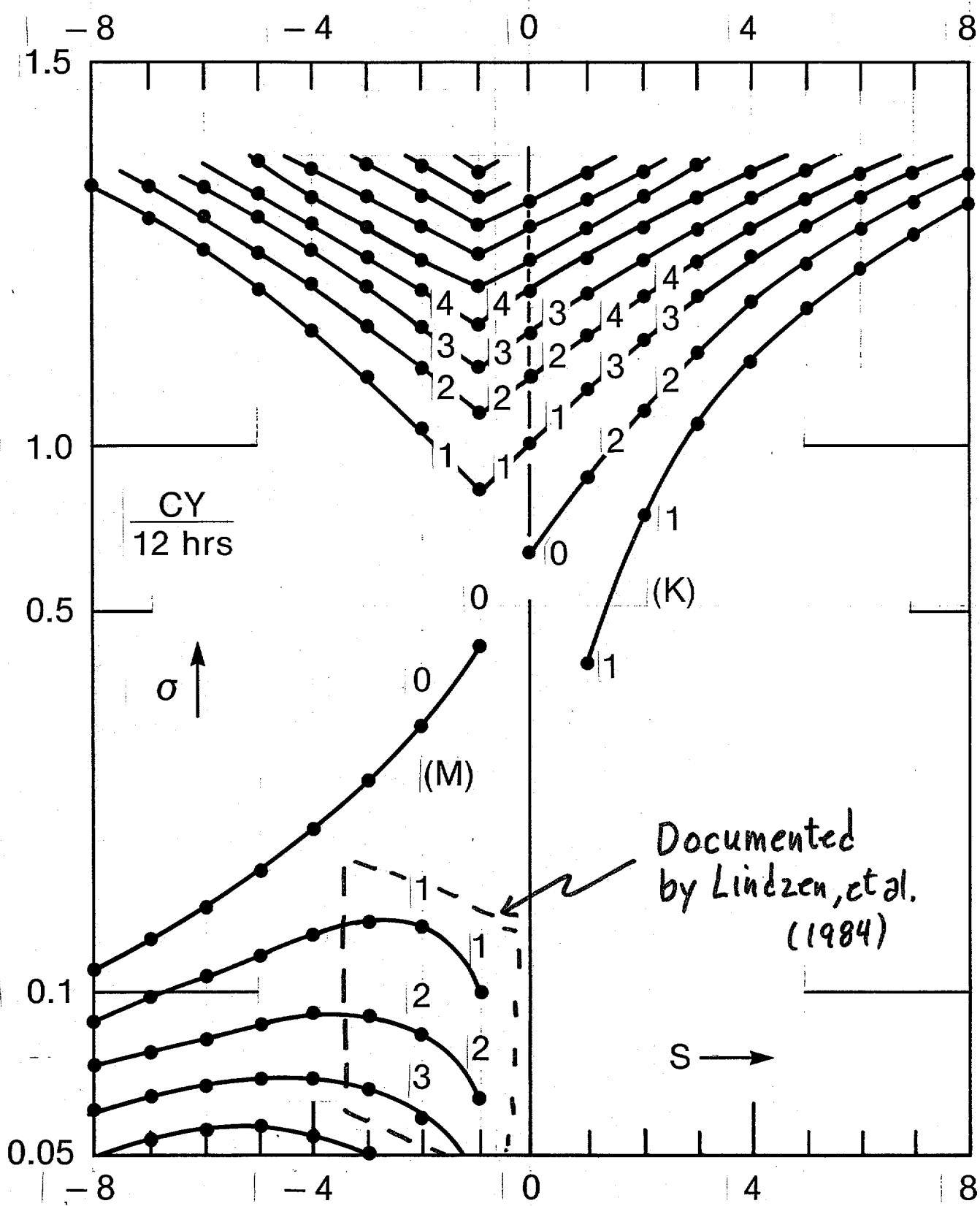

GROUP VELOCITIES COMPUTED  
FROM SOLUTIONS TO LAPLACE  
TIDAL EQUATION.

ZONAL, FROM BAROTROPIC MODES:

$\omega =$	1	2	3	4	6	8
	(degrees longitude per day)					
$l=0:$	<u>115</u>	65	41	27	14	9
$l=1:$	<u>-48</u>	-13	3	<u>7</u>	7.5	5
$l=2:$	-30	-11	-2	2	3.4	3

VERTICAL, FROM INTERNAL MODES:  
(kilometers per day)

$\omega =$	1	2	3
$l=0:$	<u>16.5</u>	9	5
$l=1:$	7	<u>8</u>	7
$l=2:$	4	5	4

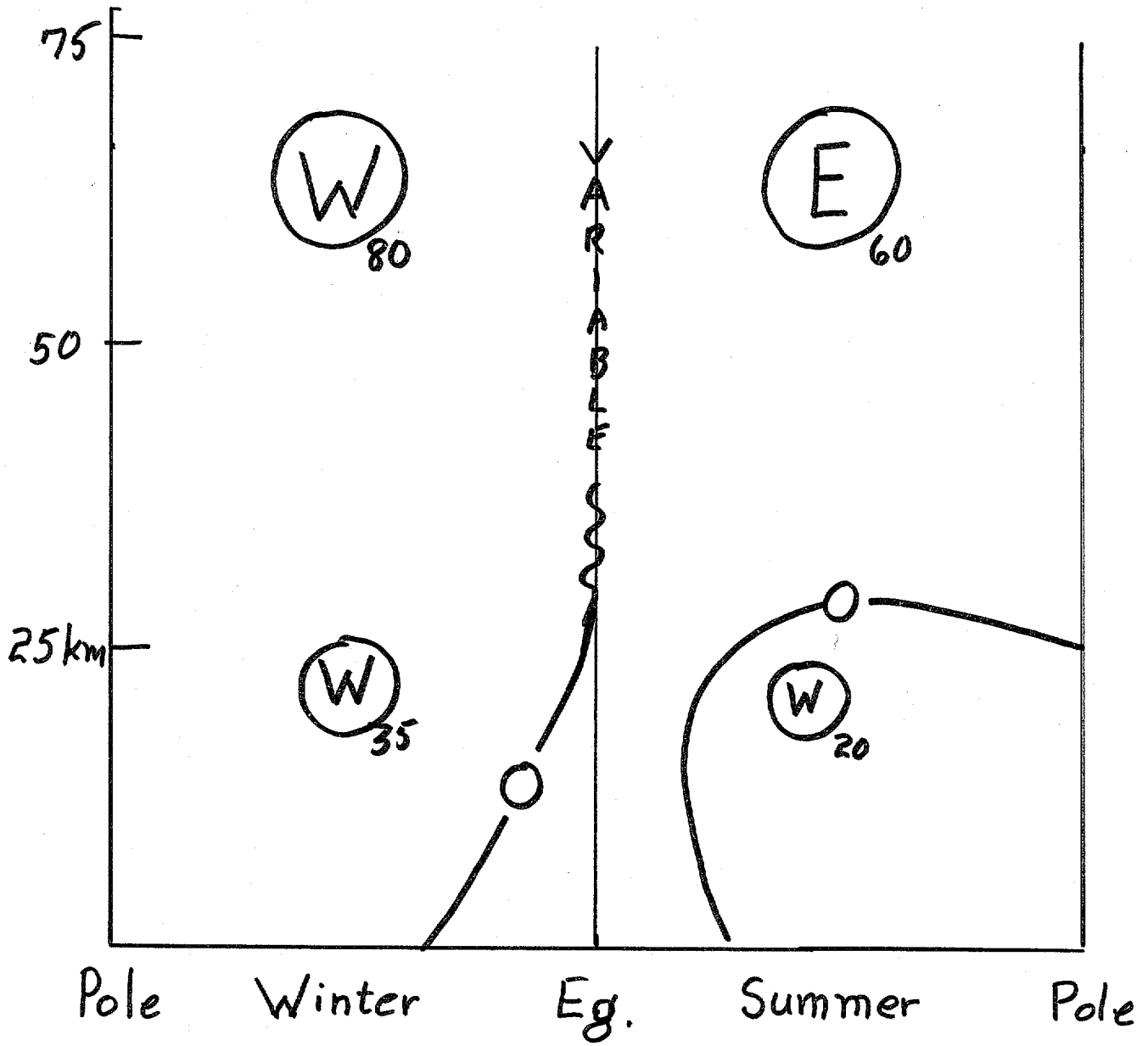



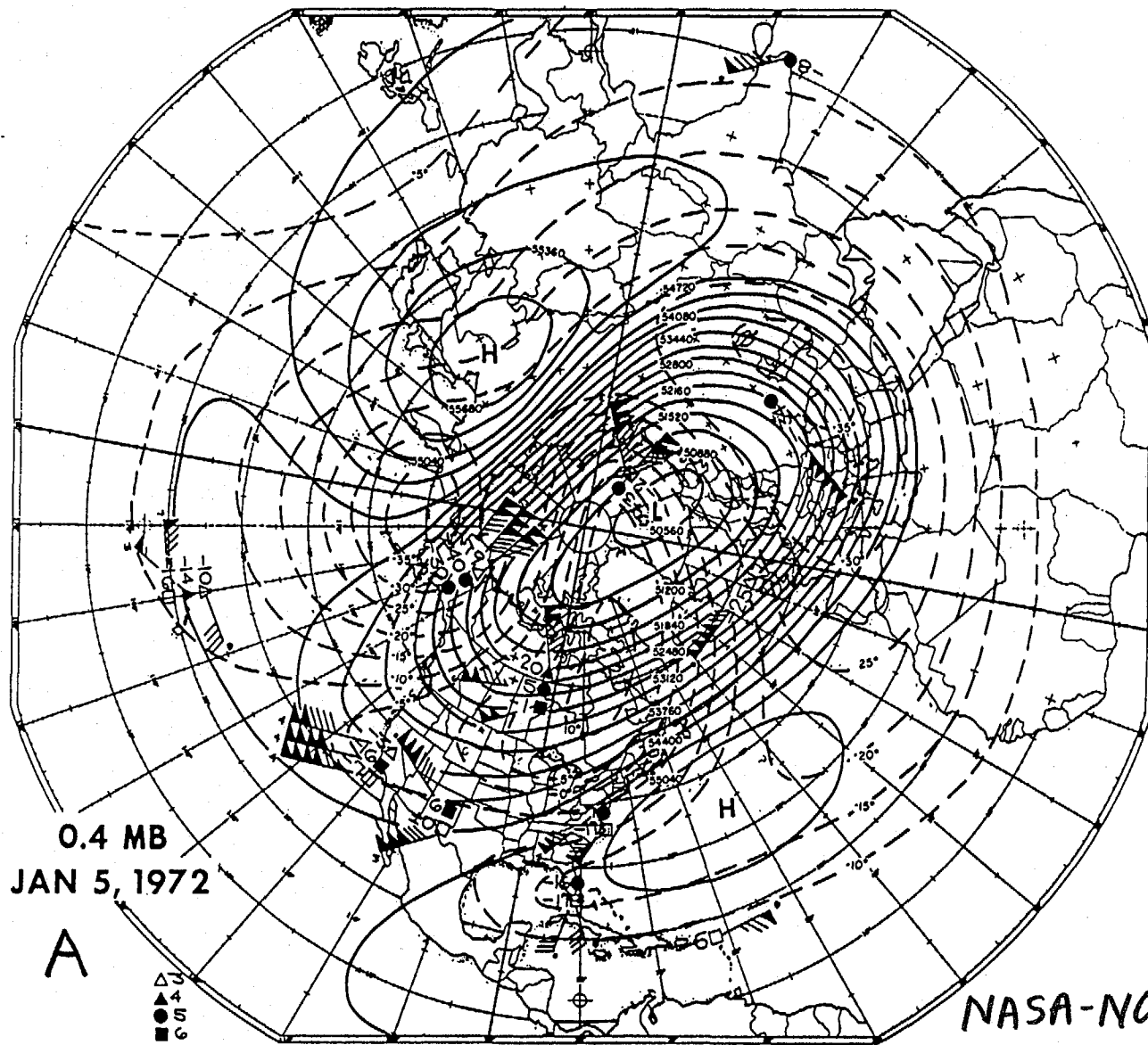

0.4 MB  
 JAN 5, 1972

A

- ▲ 7
- 5
- 3
- 1
- ⊗ 0

NASA-NOAA

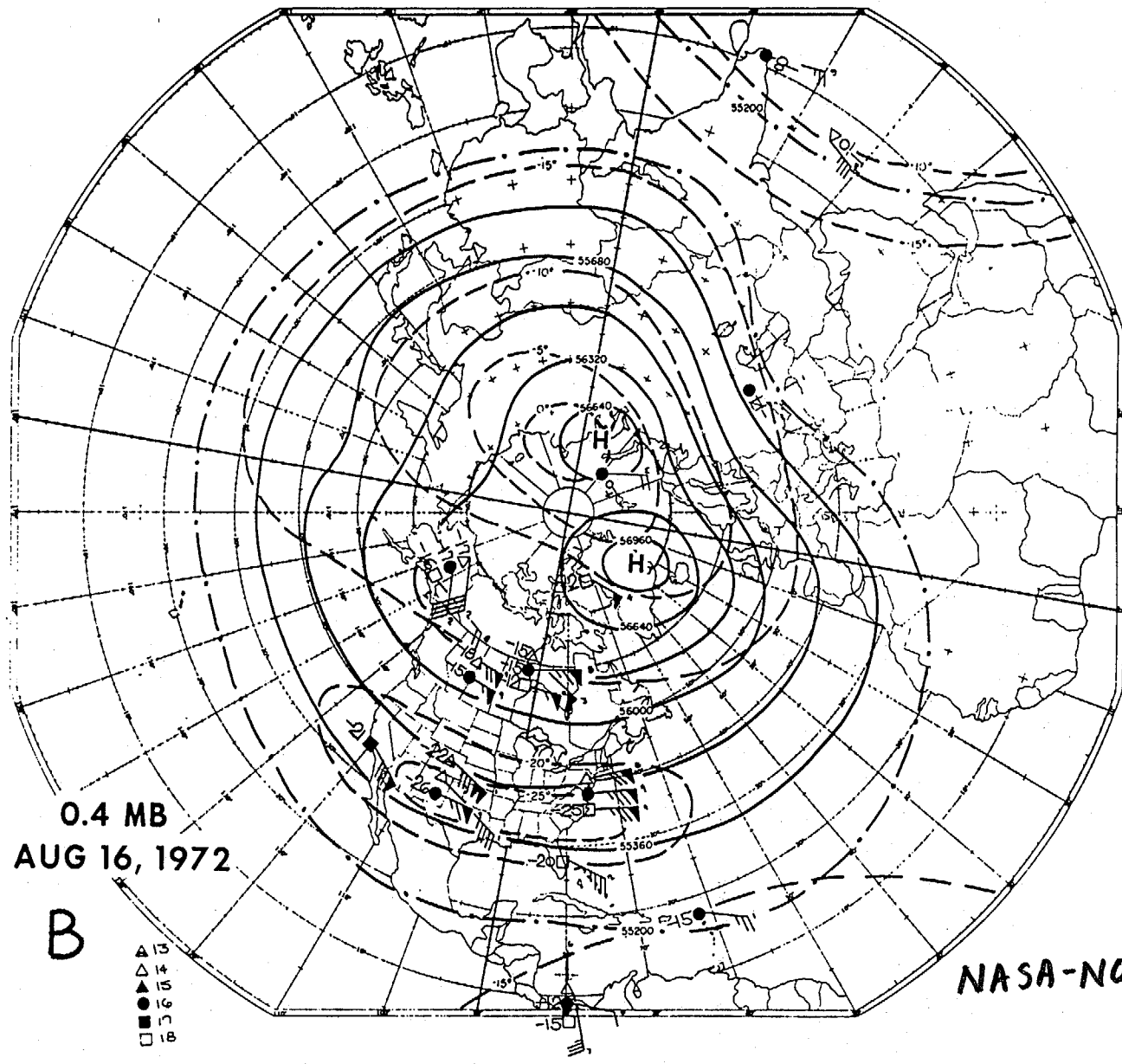

0.4 MB  
AUG 16, 1972

B

- ▲ 13
- ▲ 14
- ▲ 15
- 16
- 17
- 18

NASA-NOAA

Charney and Drazin, 1961

$(\frac{\partial}{\partial t} + \bar{u} \frac{\partial}{\partial x})$  Perturbation Potential Vorticity

$$= -\bar{v}' \frac{\partial}{\partial y} (\text{Basic state potential vorticity})$$

For  $\phi' = \Phi(y, z) e^{ik(x-ct)}$ ,

$$(\bar{u}-c) \left[ \frac{\partial^2 \Phi}{\partial y^2} + \left(\frac{f^2}{N^2}\right) \frac{\partial^2 \Phi}{\partial z^2} \right] = - \left[ \beta' - k^2(\bar{u}-c) \right] \Phi$$

$$\frac{\partial^2 \Phi}{\partial y^2} + \frac{f^2}{N^2} \frac{\partial^2 \Phi}{\partial z^2} = - \left[ \frac{\beta'}{\bar{u}-c} - k^2 \right] \Phi$$

Need  $[ ] > 0$  for wave-like solutions.

$$\beta' > 0$$

$$0 < \bar{u}-c < \frac{\beta'}{k^2} < 38 \text{ m sec}^{-1}$$

---

$$\text{For } c=0: \quad 0 < \bar{u} < \frac{\beta'}{k^2}$$

---

P. Queney (1948) Standing orographic Rossby waves.

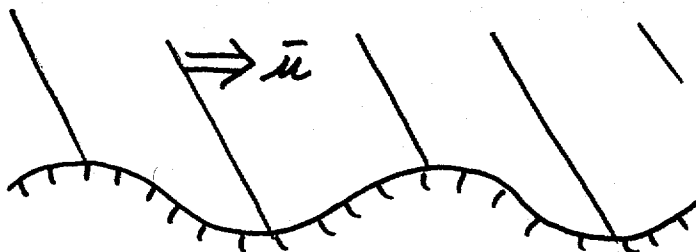

Matsuno  
(1970)

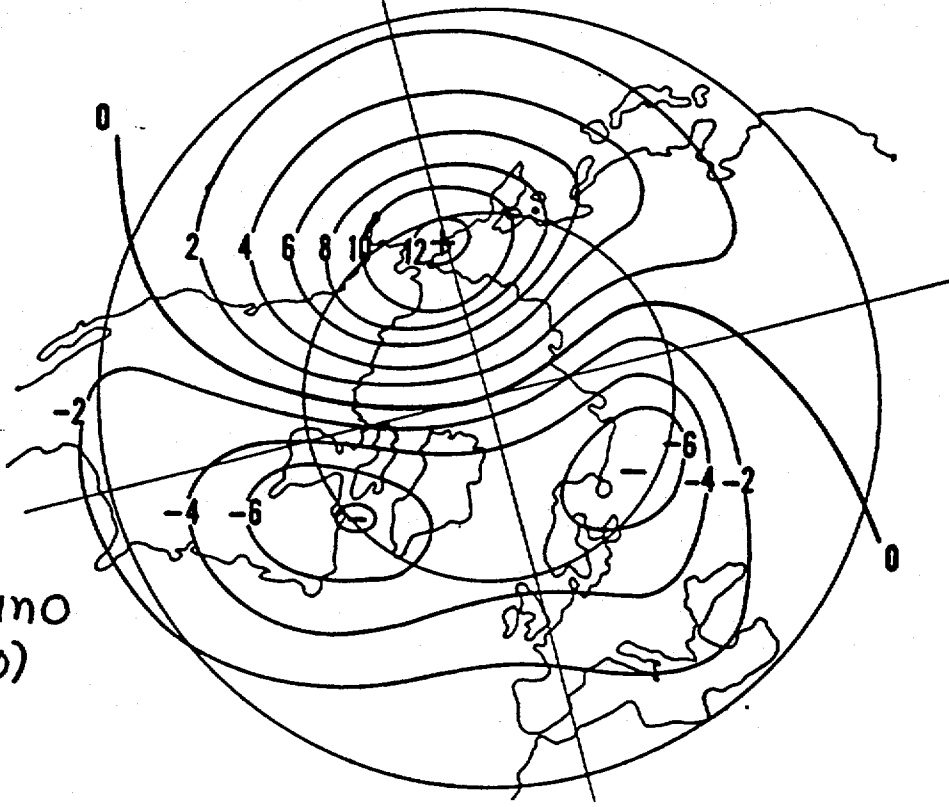

FIG. 10. Observed distribution of disturbed height of the 10-mb surface, in January 1967, at 200 m intervals.

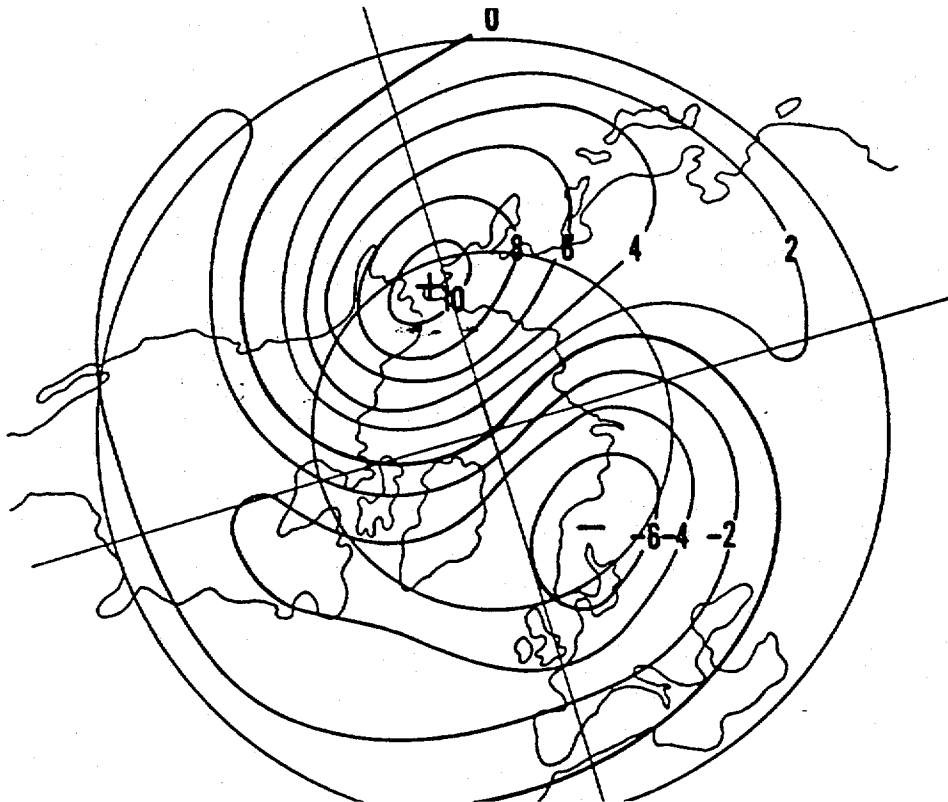

FIG. 9. Computed distribution of disturbed height of the  $-H_0 \ln(p/p_0) = 30$  km surface, in January 1967, at 200 m intervals.

Mercator:  $\kappa = a\lambda$ ,  $dy = a d\vartheta / \cos\vartheta$

$$\omega = k \bar{u}_M - \frac{\beta_M k}{k^2 + l^2}$$

$$\bar{u}_M = \bar{u} / \cos\vartheta = \bar{u}_M(y)$$

$$\beta_M = \frac{\cos\vartheta}{a} \frac{d}{d\vartheta} (f + \bar{S}) = \beta_M(y)$$

$\omega$  and  $k$  are constant along a ray.

Stationary wave length:  $K_s^2 = \beta_M / \bar{u}_M = K_s^2(y)$

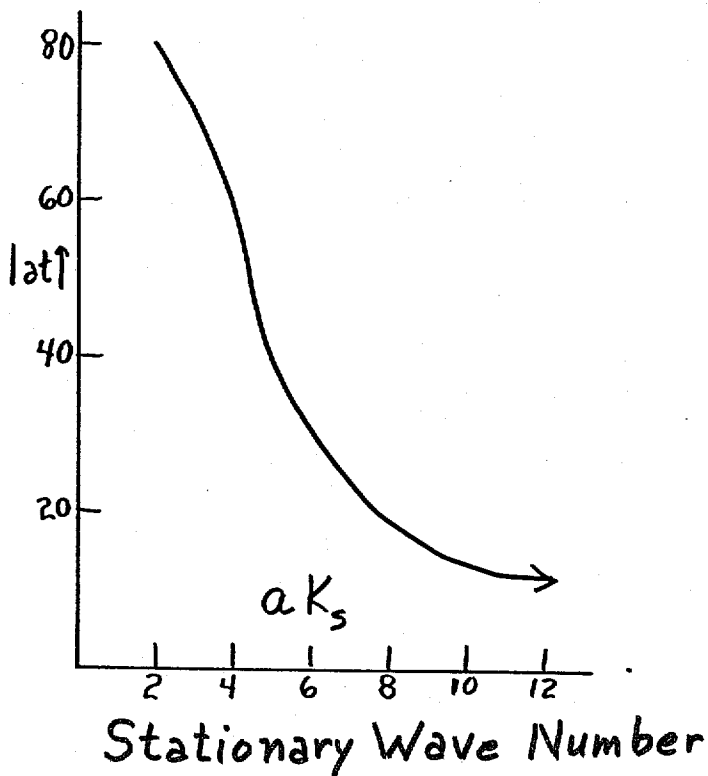

$$k', l' \equiv \frac{k, l}{K_s}$$

$$\omega' = \omega / \bar{u} K_s$$

$$= k' - \frac{k'}{k'^2 + l'^2}$$

(13)

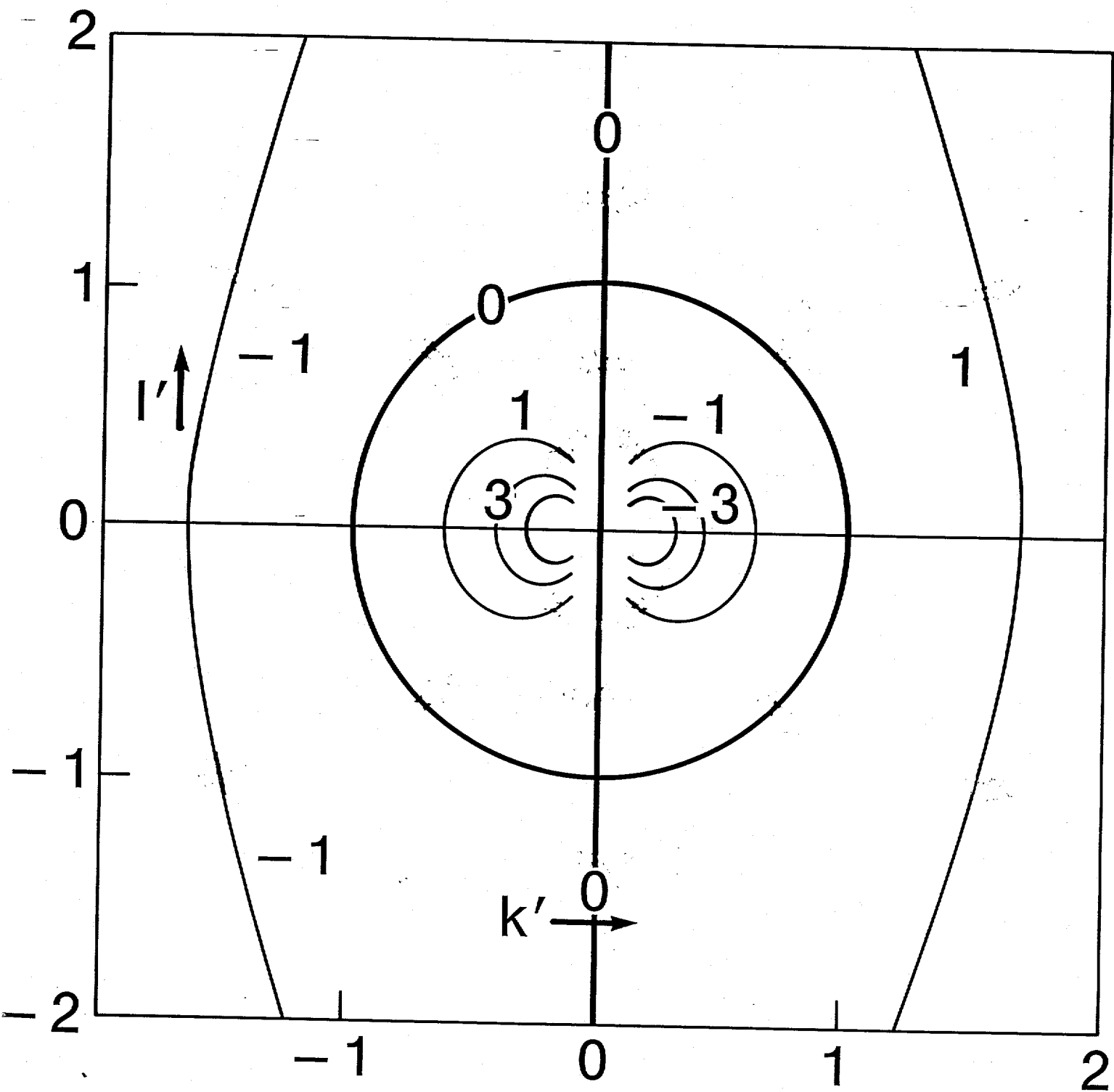

14a

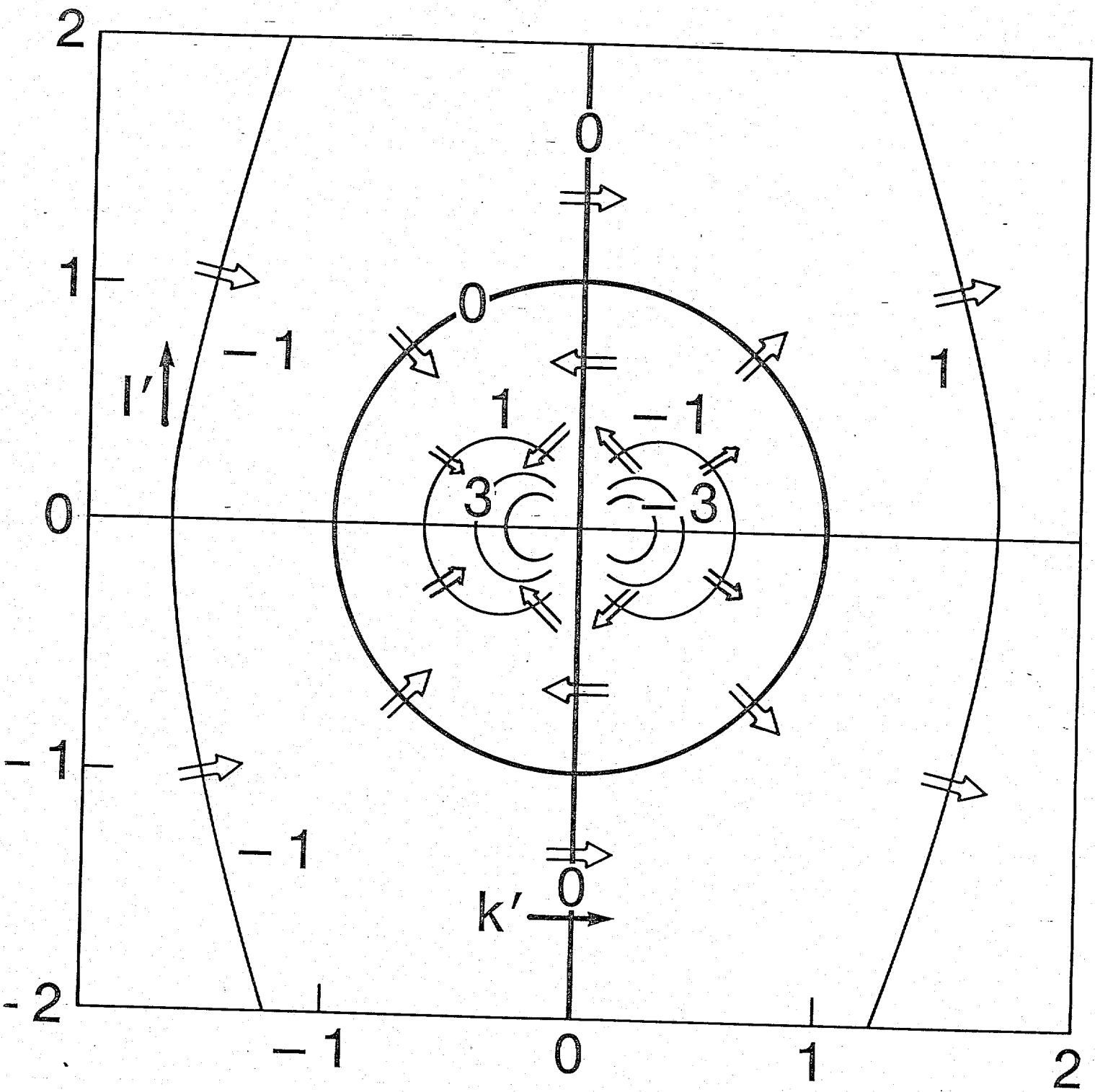

$$\omega' = k' - \frac{k'}{k'^2 + l'^2}$$

$$\omega' = 0: \left(\frac{l'}{k'}\right)^2 = \frac{1 - k'^2}{k'^2} = \frac{K_s^2}{k^2} - 1$$

14b

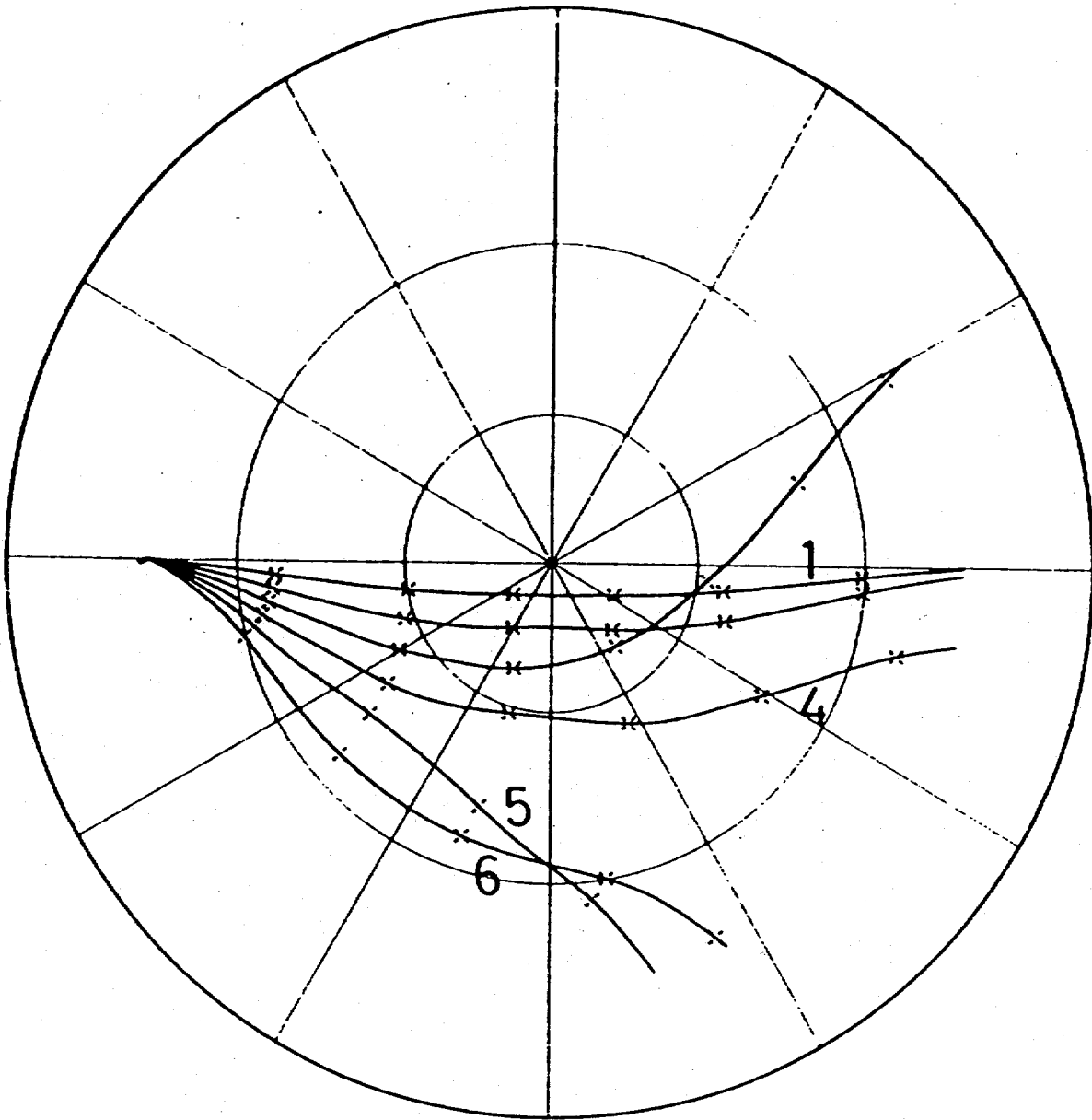
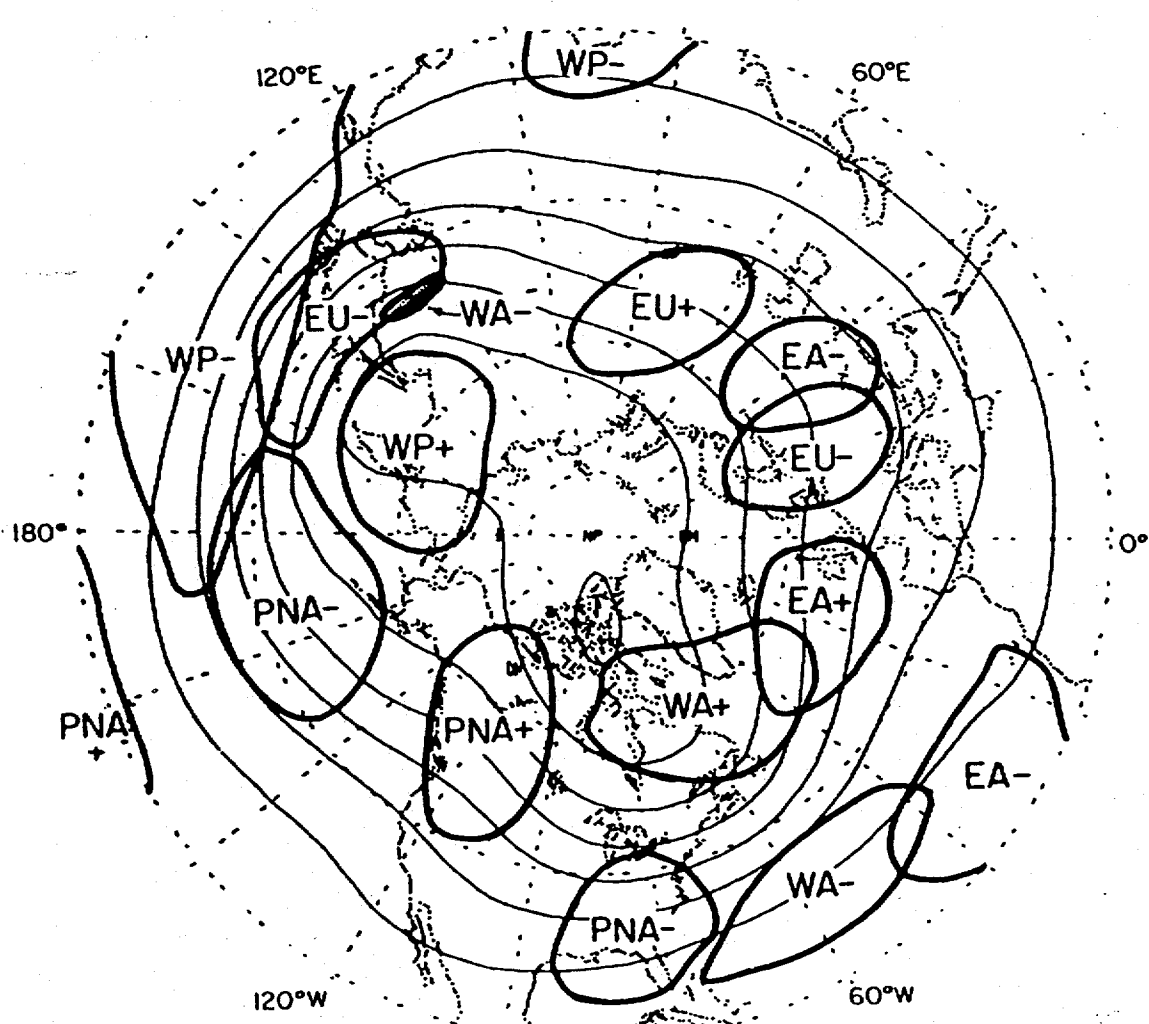

FIG. 17. Rays and phases every  $180^\circ$  for a  $15^\circ$  source in the NH 500 mb zonal flow. Rays for zonal wavenumbers  $> 6$  are omitted. (Hoskins and Karoly, 1981)





Wallace and Gutzler 1981

FIG. 26.  $\pm 0.6$  isopleths of correlation coefficient between each of the five pattern indices and local 500 mb height (heavy lines), superimposed on wintertime mean 500 mb height contours (lighter lines), contour interval 120 m. Based on the same 45-month data set as Fig. 7b. Regions of strong correlation are labeled in terms of the respective pattern indices with which local 500 mb height shows the strongest correlation, and the sign of that correlation is indicated. See text for further details.

$$\Psi_{\lambda}(\lambda; \kappa, t) = \text{Re } P_{\lambda}(\kappa, t) e^{i\omega t}$$

$$\kappa = \sin \vartheta, \quad -1 \leq \kappa \leq +1$$

$$\kappa_j = -1 + (j-1) \Delta \kappa$$

$j$  = output latitude

$j'$  = input latitude

$$P_{\lambda}(j, t) = \sum_{j'} I_{\lambda}(j', t; j) P_{\lambda}(j', t=0) \Delta \kappa$$

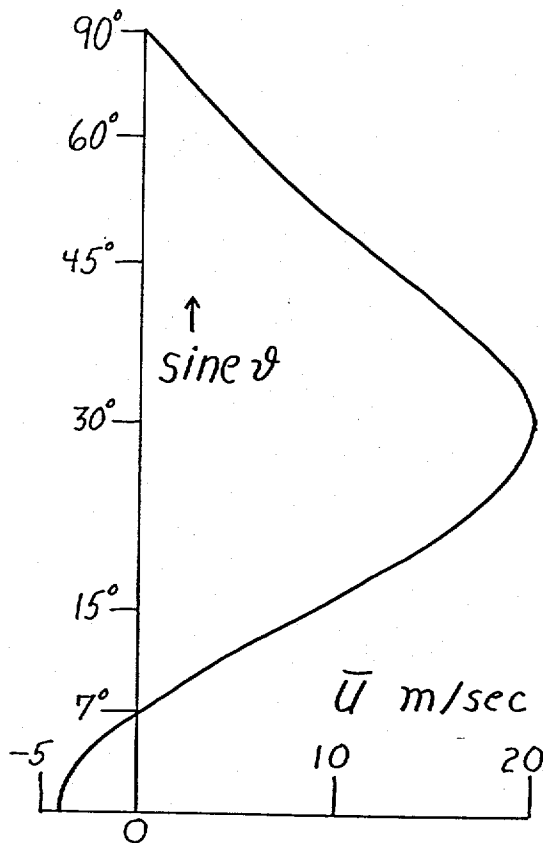

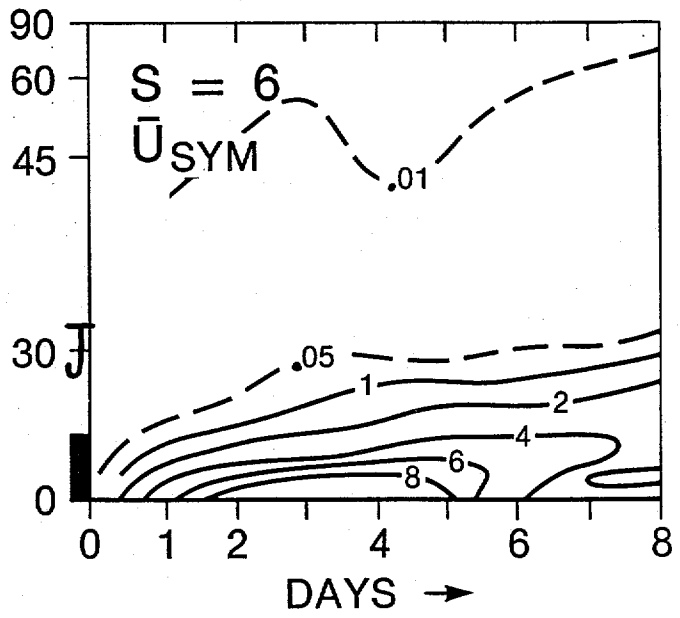
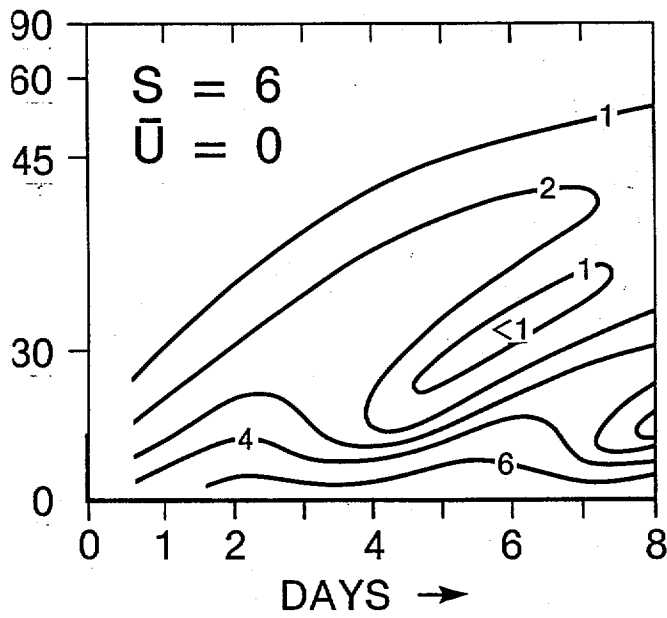
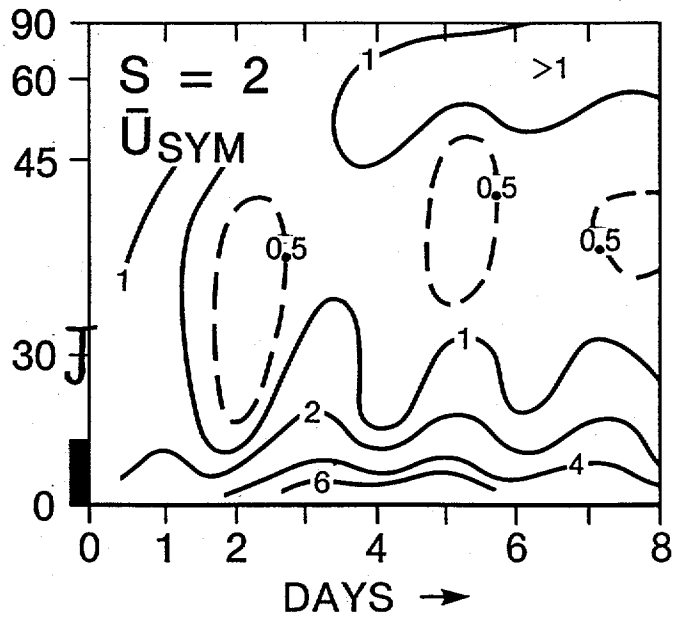
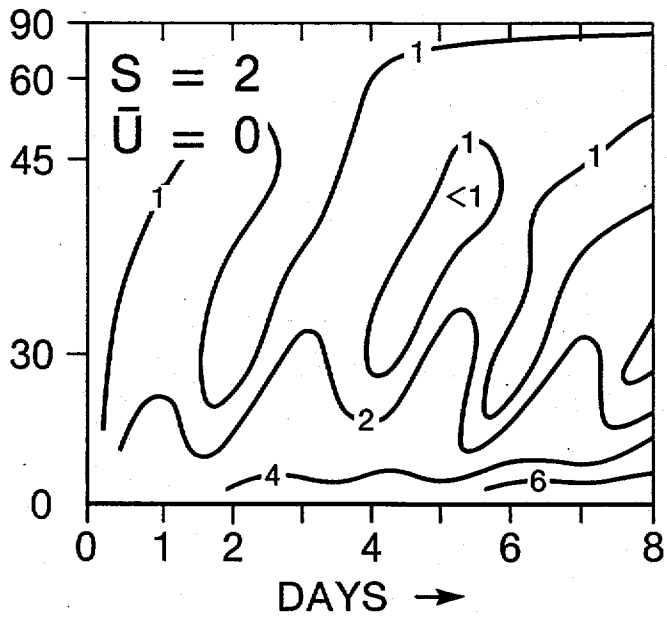

Dikii and  
Katayev (1971)

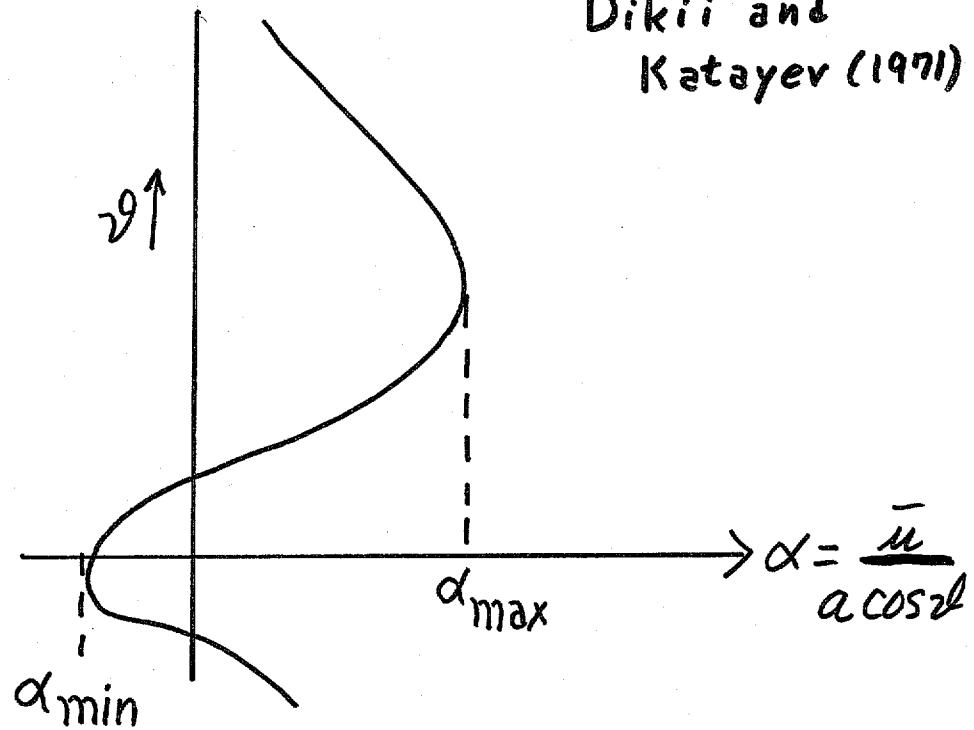

Discrete spectrum has  $\frac{\omega}{\Omega} < \alpha_{\min}$

Continuous spectrum has  $\frac{\omega}{\Omega} \alpha_{\min} < \frac{\omega}{\Omega} < \alpha_{\max}$

$\alpha_{\min}$  for  $\bar{u} = -4 \text{ m/sec} = -19.5 \text{ deg/day}$

$\omega/\Omega$  for Rossby waves in  
resting atmosphere (deg/day)

	$l=0$	$l=1$	$l=2$
$\Omega=2:$	-360	-120	-60
$\Omega=6:$	-17	-13	-10

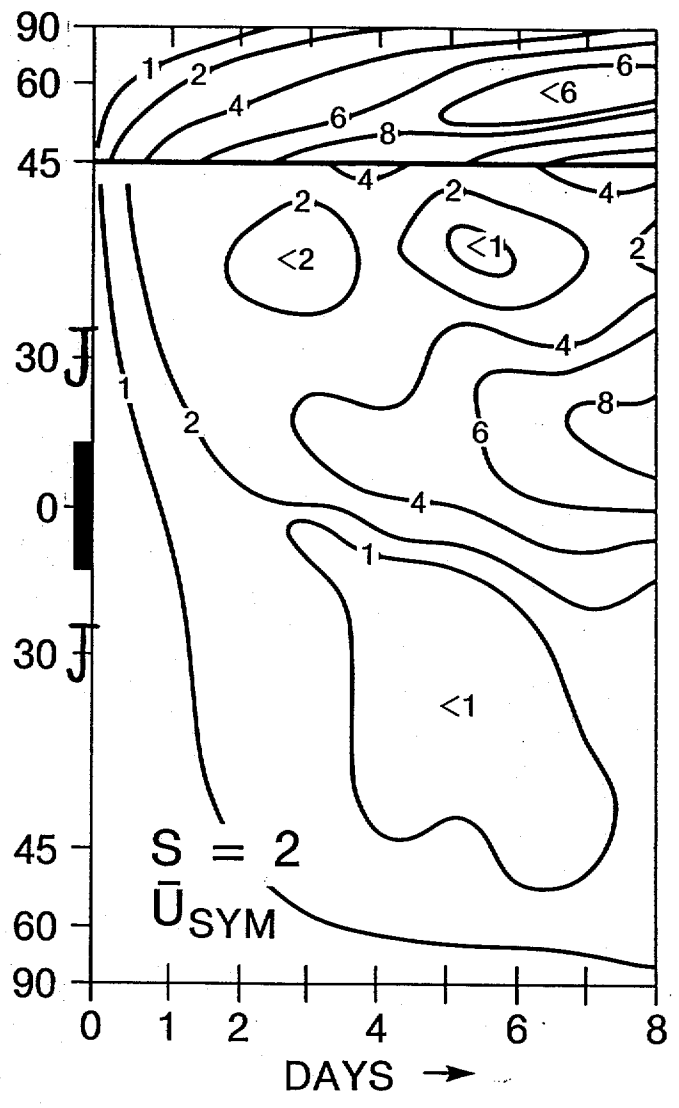
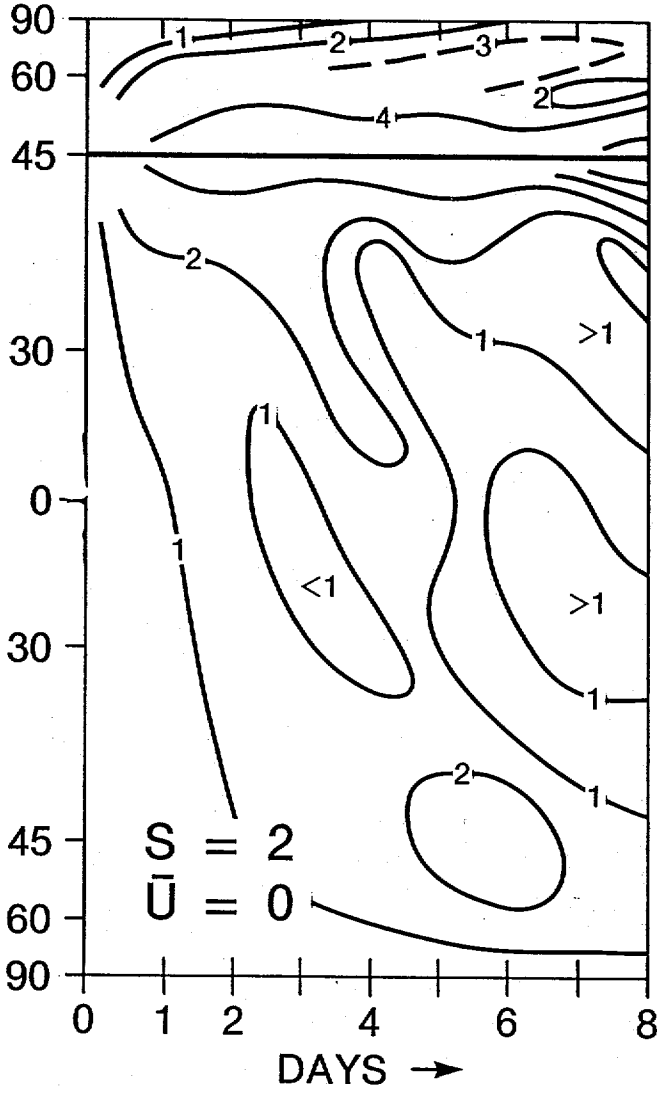

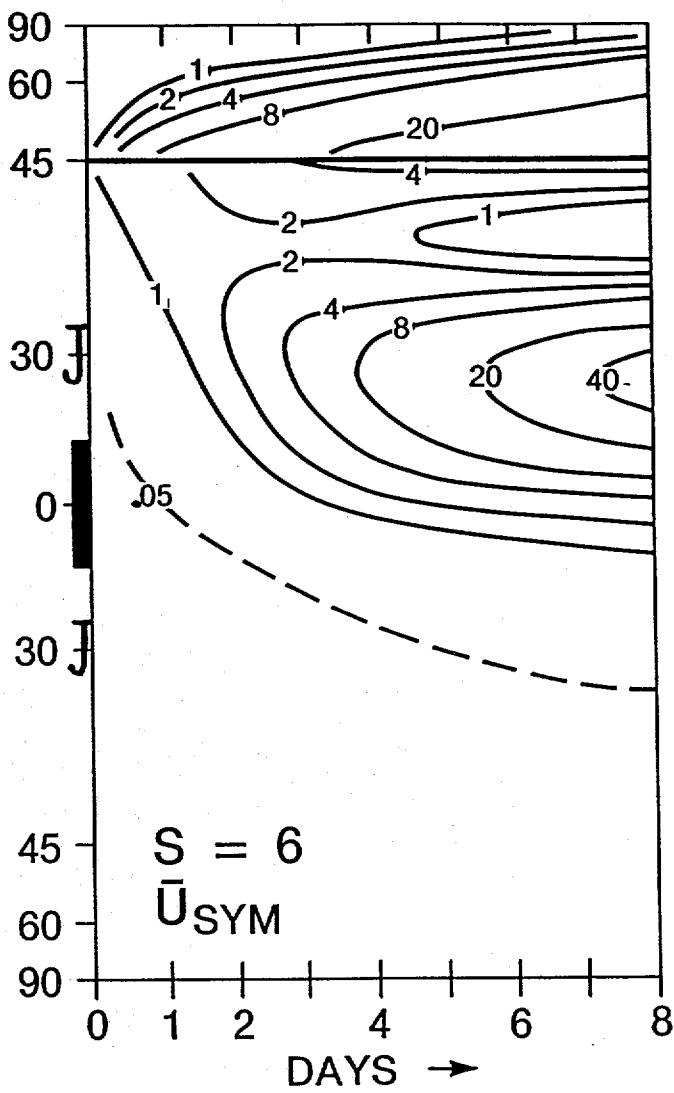
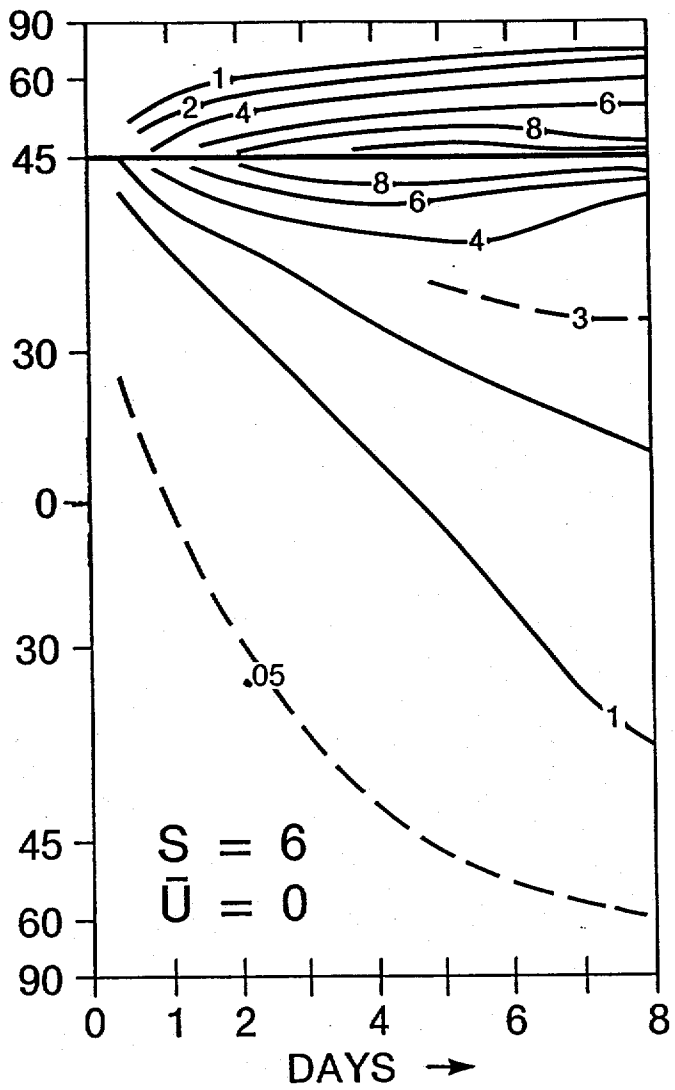

21

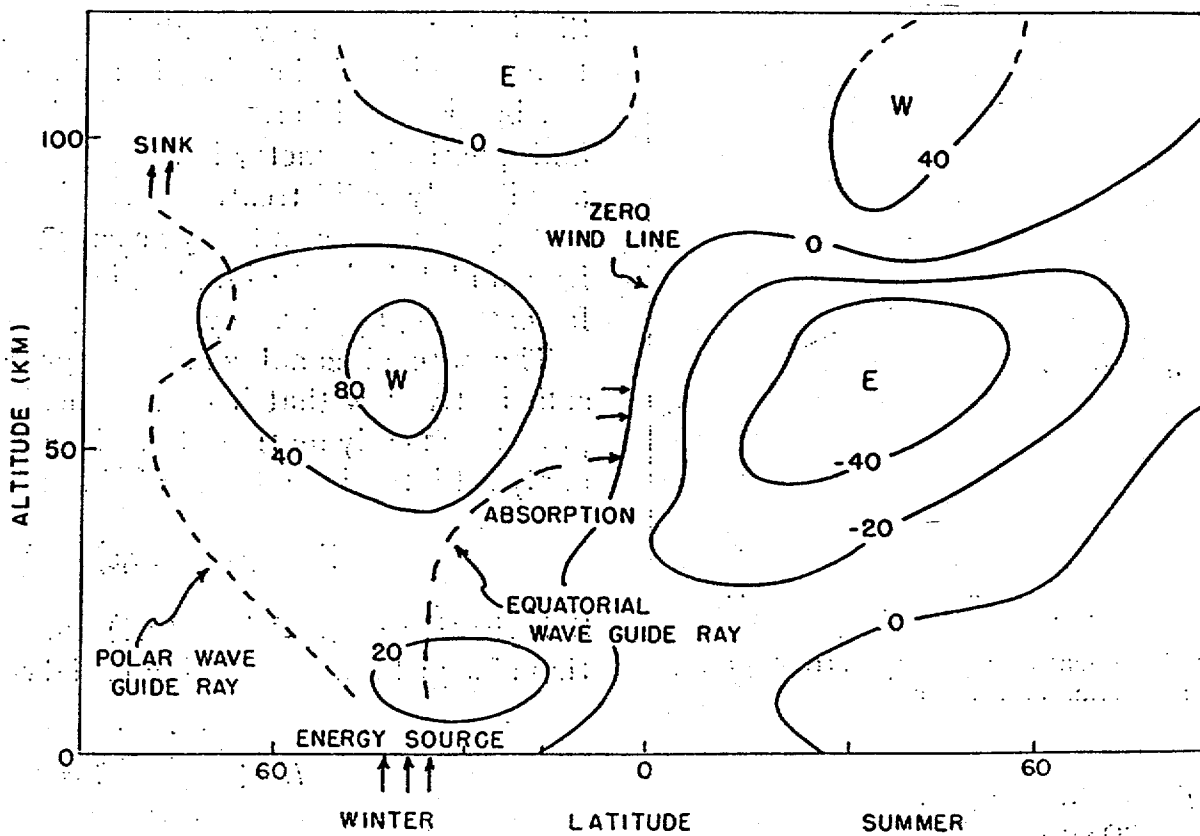

Dickenson, 1968

$$\text{K.E. density} \sim \bar{\rho} \bar{C}_s \overline{v'^2}$$

$$\frac{\sqrt{\bar{\rho} C_d}_{200 \text{ mb}}}{\sqrt{\bar{\rho} C_d}_{0.4 \text{ mb}}} \sim 14$$

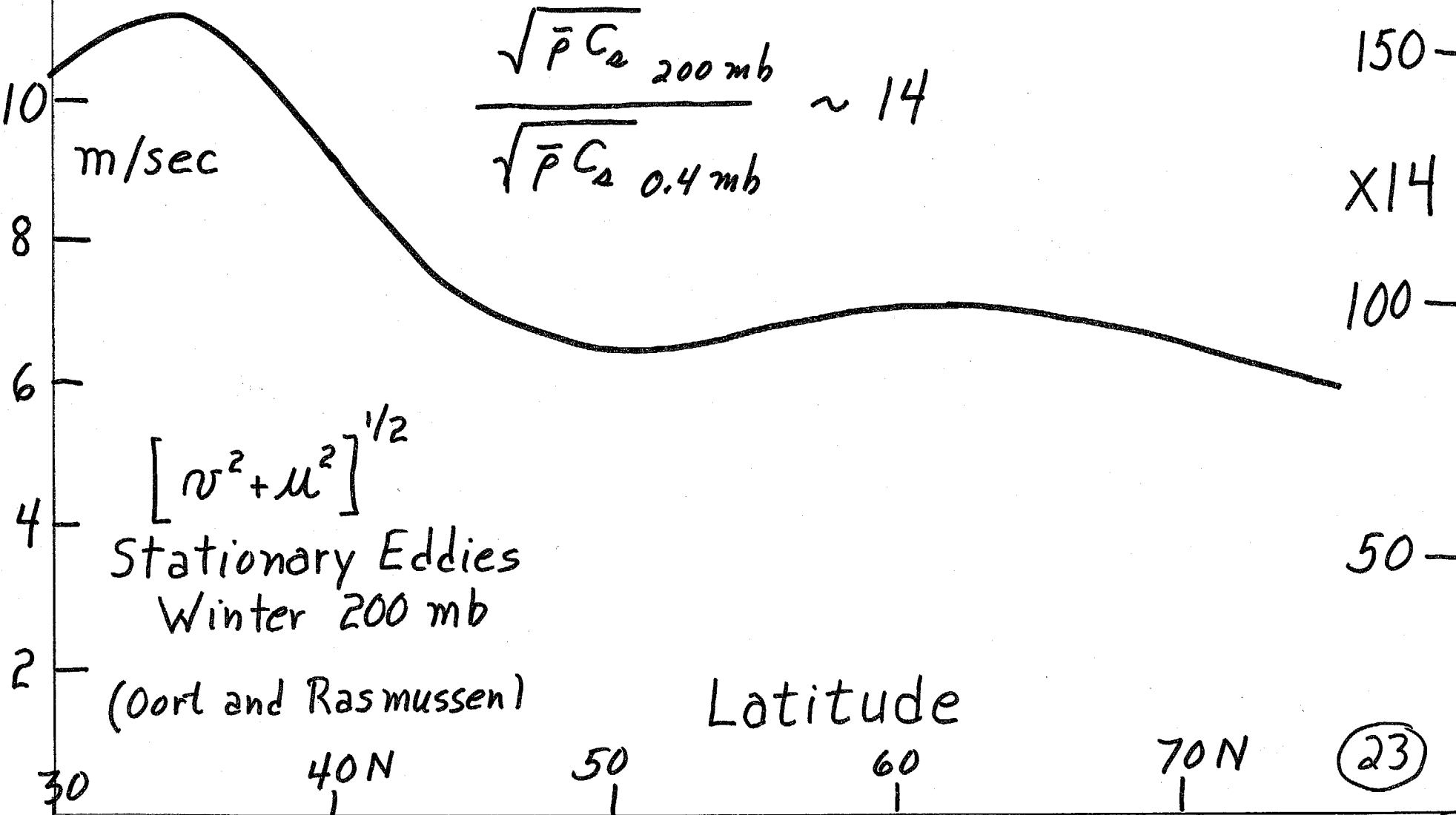

$$[v^2 + u^2]^{1/2}$$

Stationary Eddies  
 Winter 200 mb  
 (Oort and Rasmussen)

Latitude



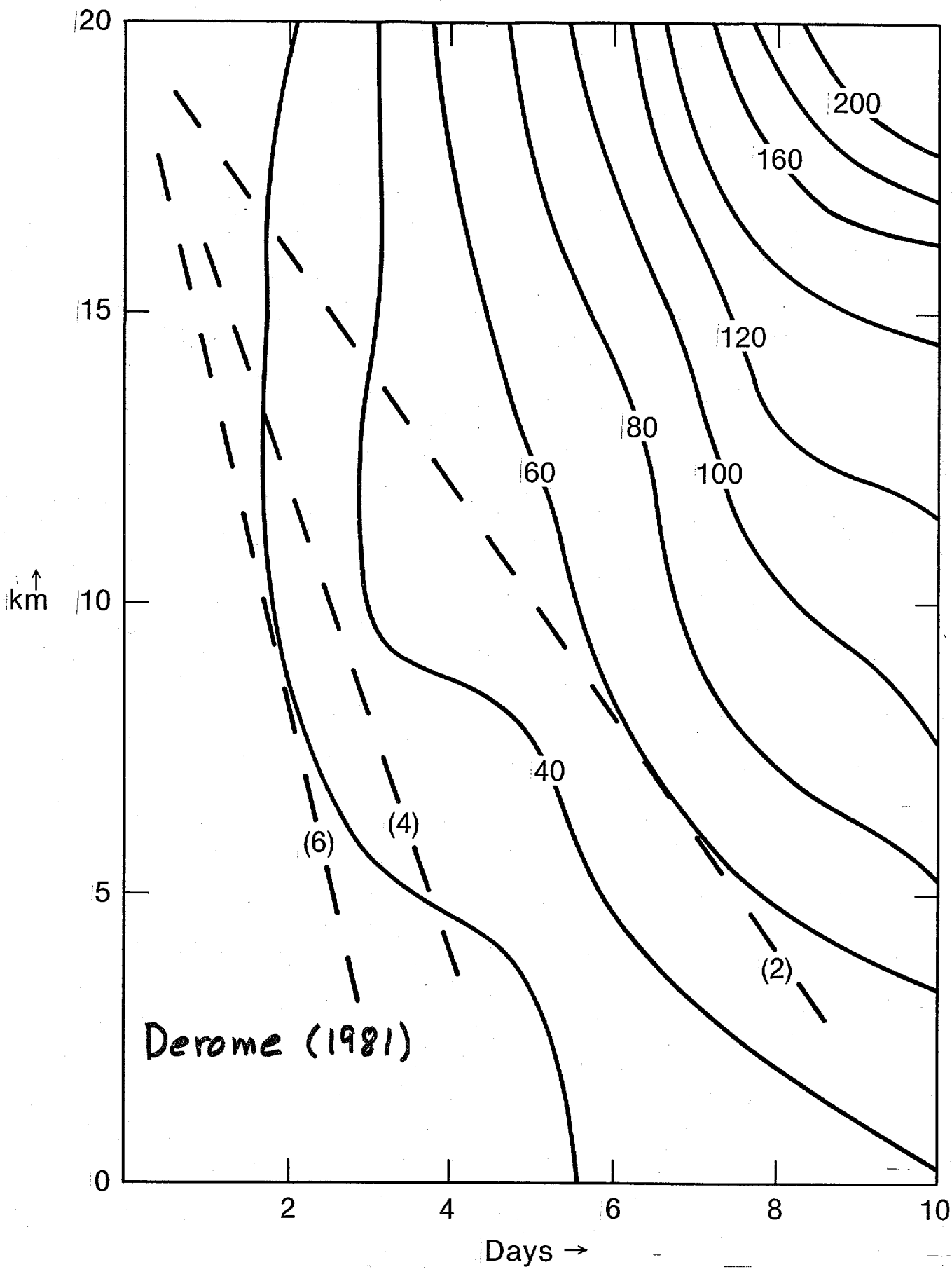

# Variations on Matsuno model of Aleutian Stratospheric Anticyclone

(Beaudoin and Derome, '76)

With vertical resolution of 2.5 kms:

RADIATION  
BOUNDARY  
CONDITION

ZERO VERTICAL  
VELOCITY BOUNDARY  
CONDITION

TOP at 65 kms:	OK	OK
" " 42.5 kms:	OK	NO
" " 37.5 kms:	OK	-
" " 22.5 kms:	NO	-

With Radiation Condition at 65 kms:

$\Delta z = 2.5$  kms: OK

$\Delta z = 5$  kms: OK

$\Delta z = 10$  kms: NO

# NORTH AMERICA

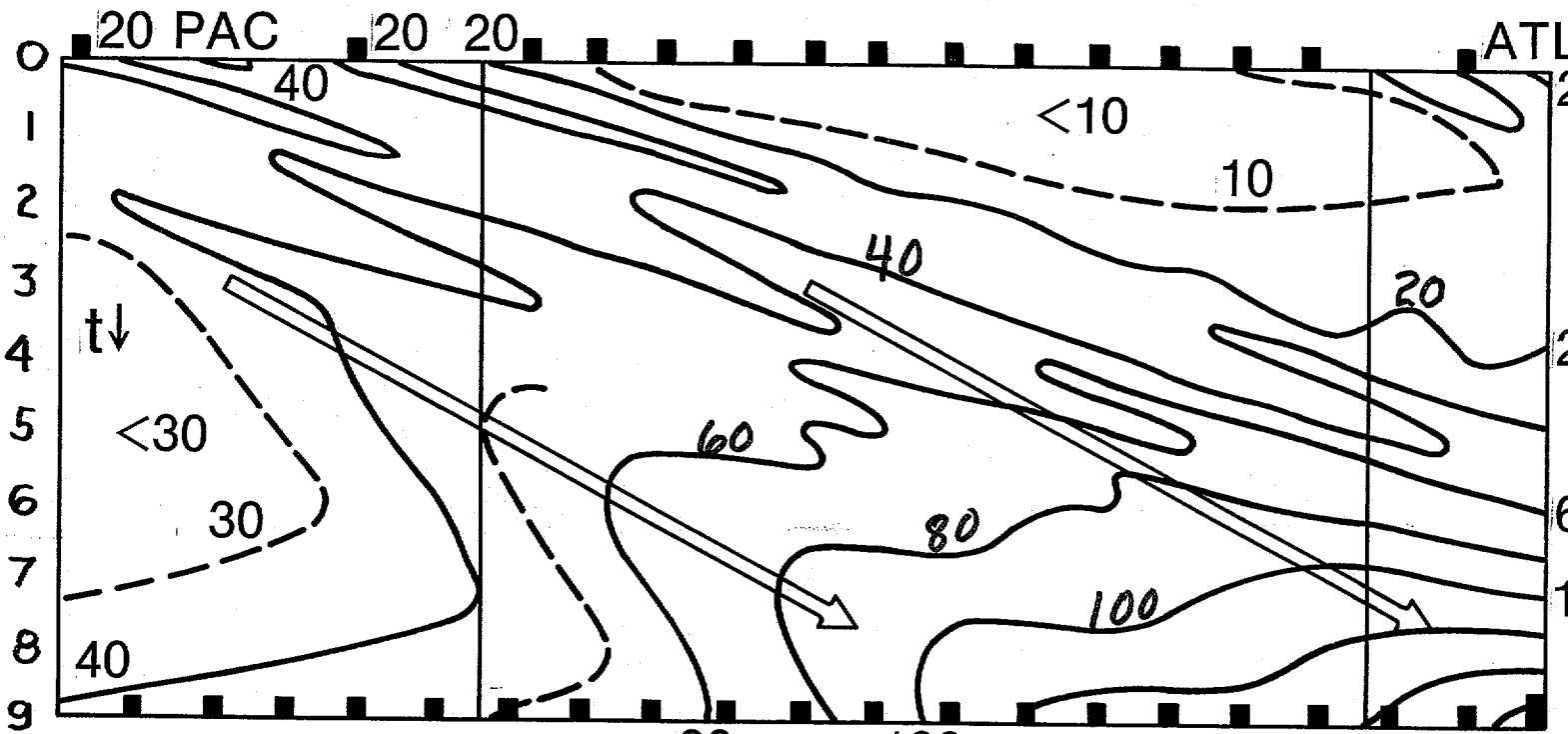

Phillips, 1976

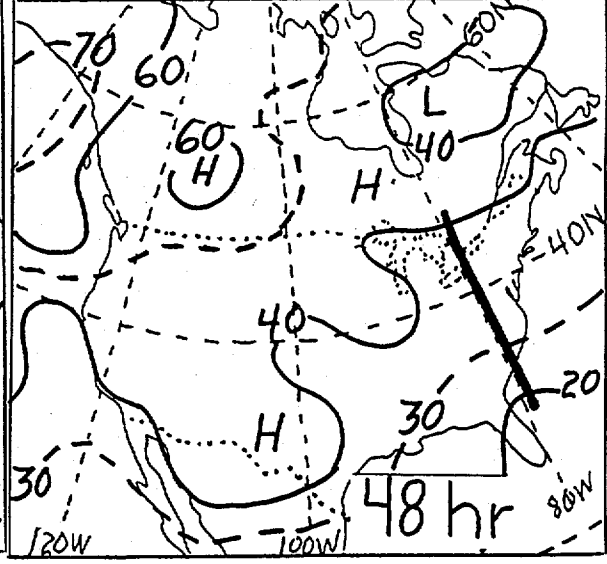
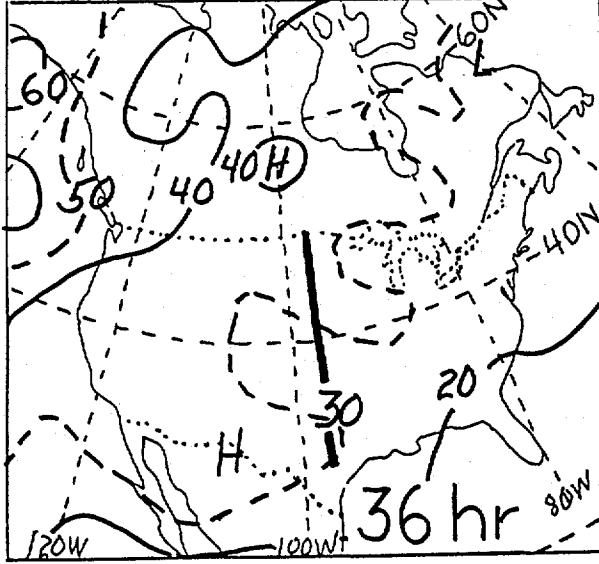
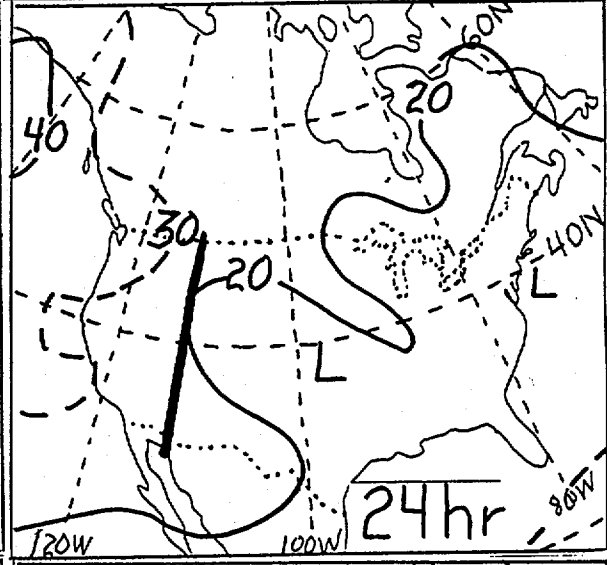
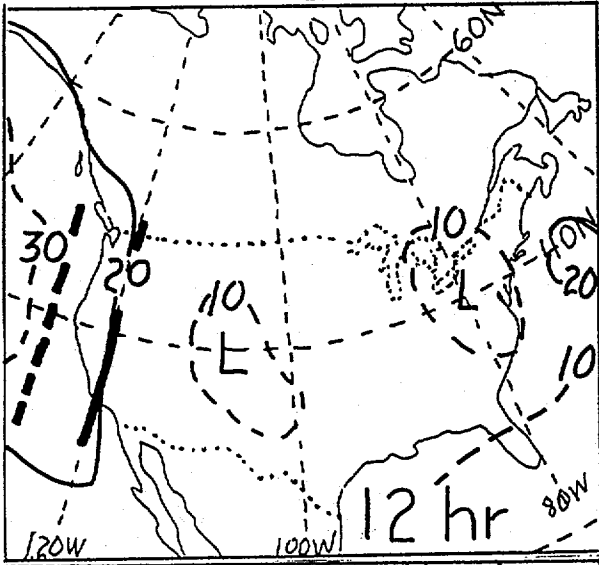
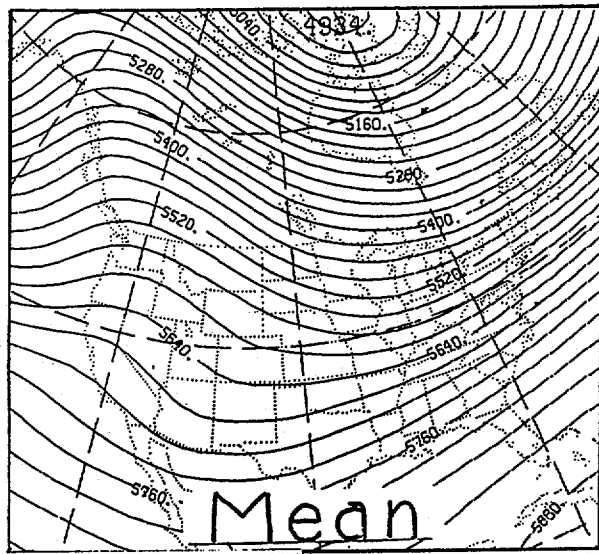

Regional model 500-mb errors (s.d.)  
December 1986

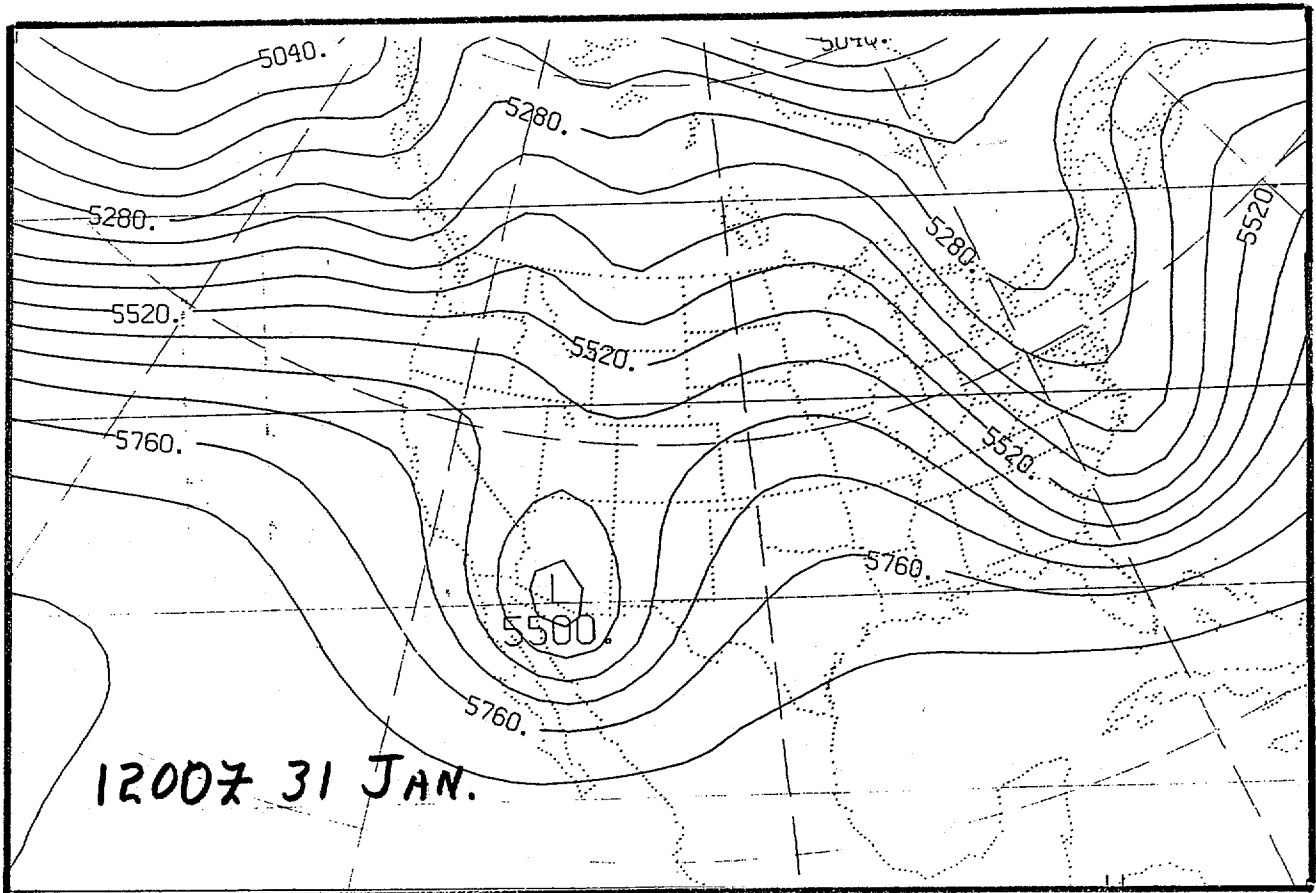
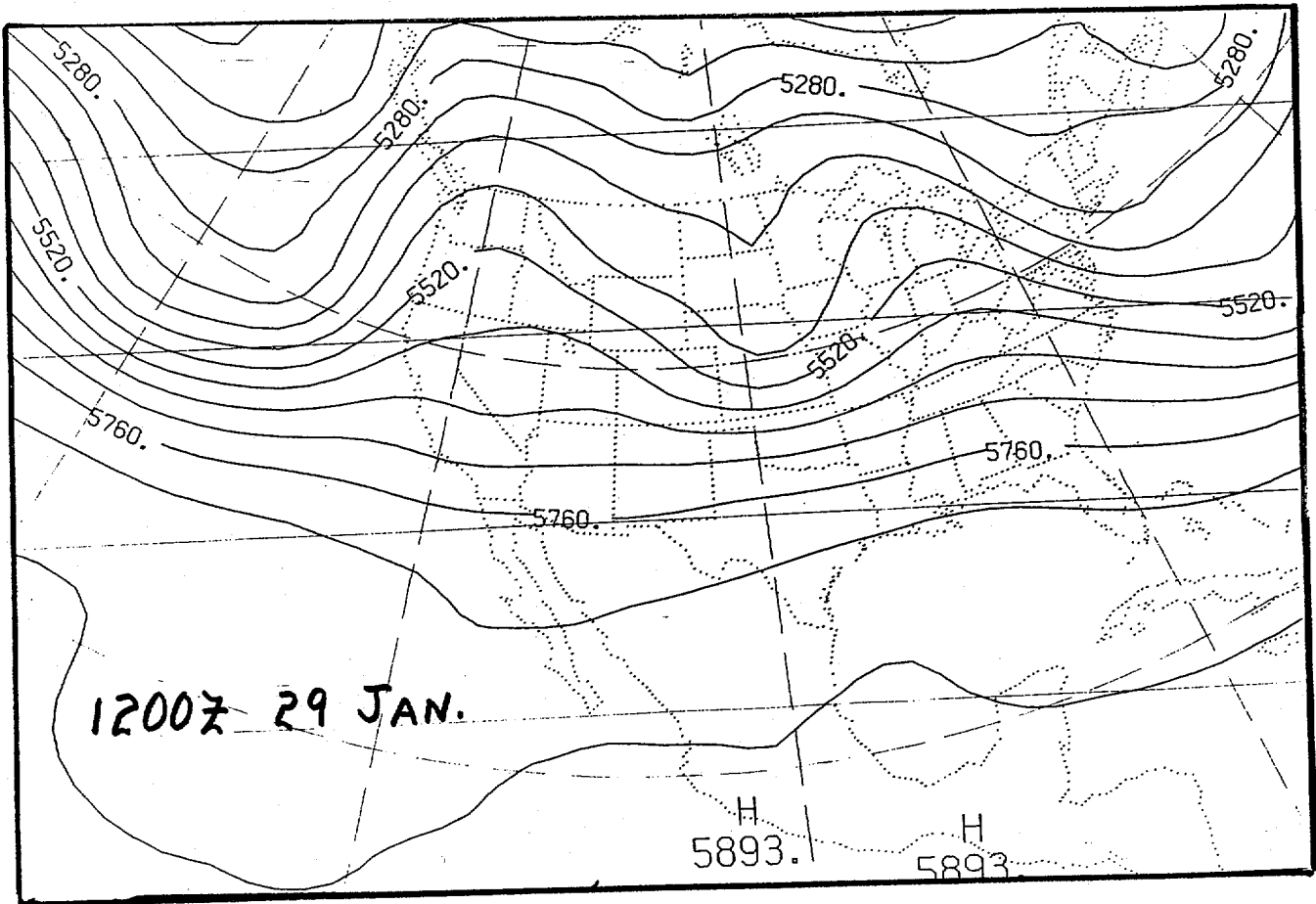

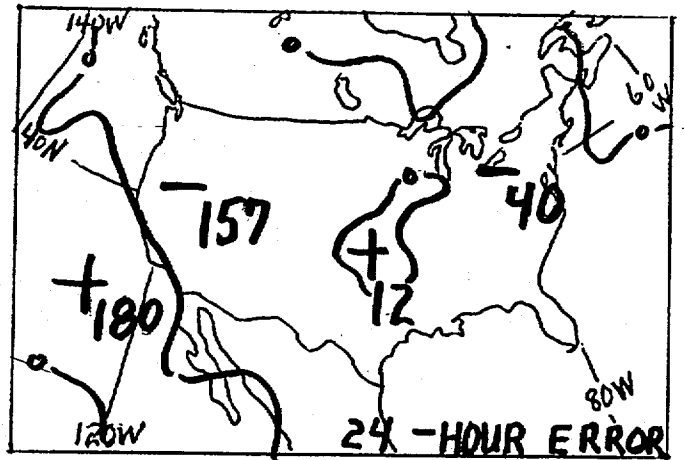
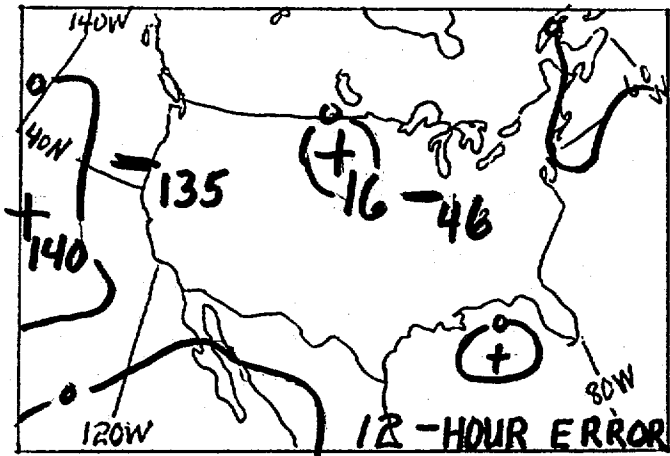

# NMC NEW REGIONAL

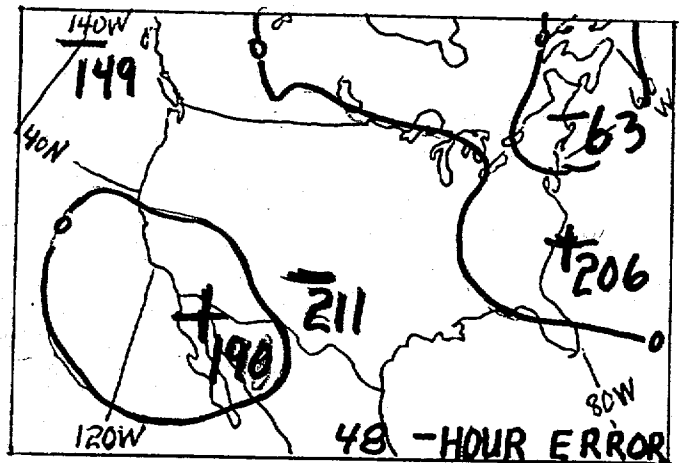
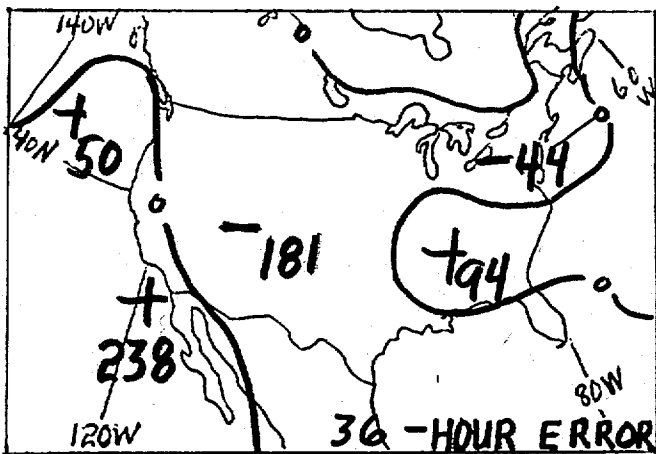

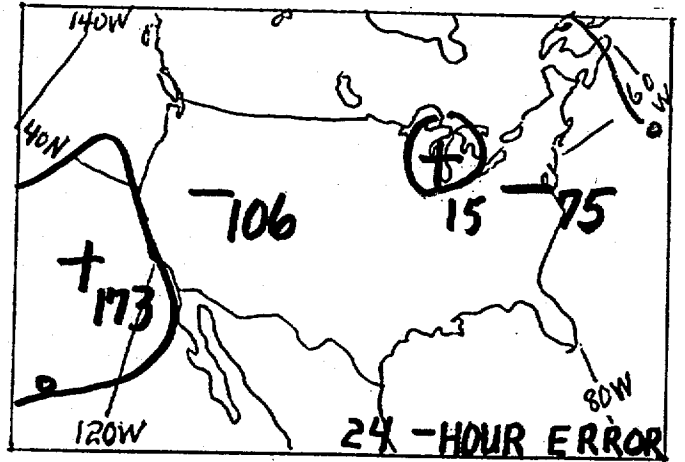
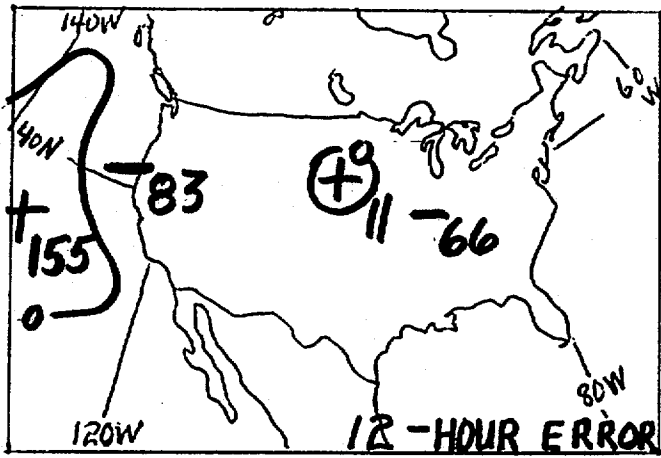

NMC OLD REGIONAL

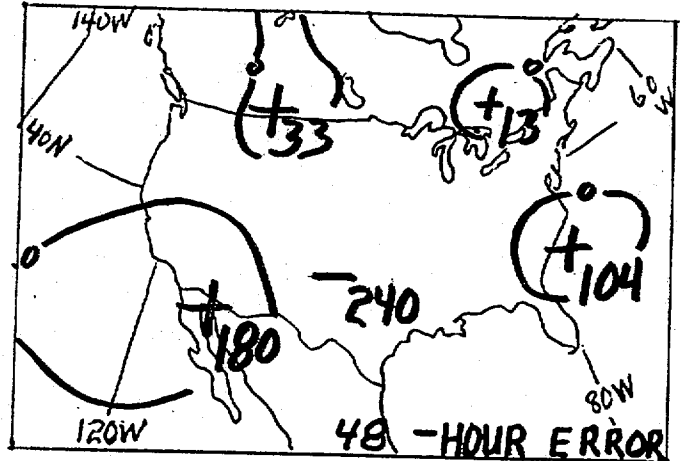
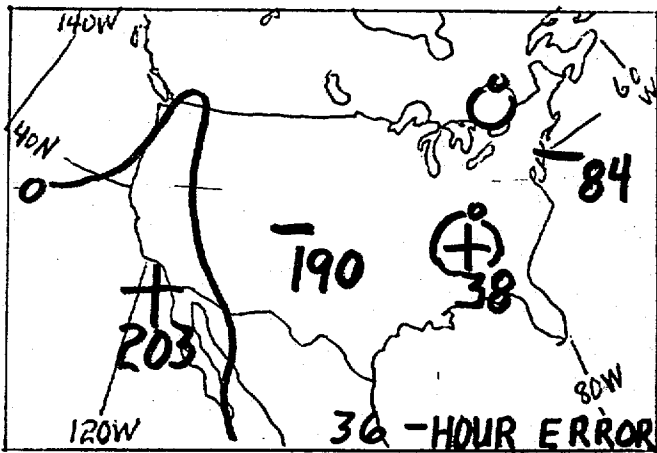

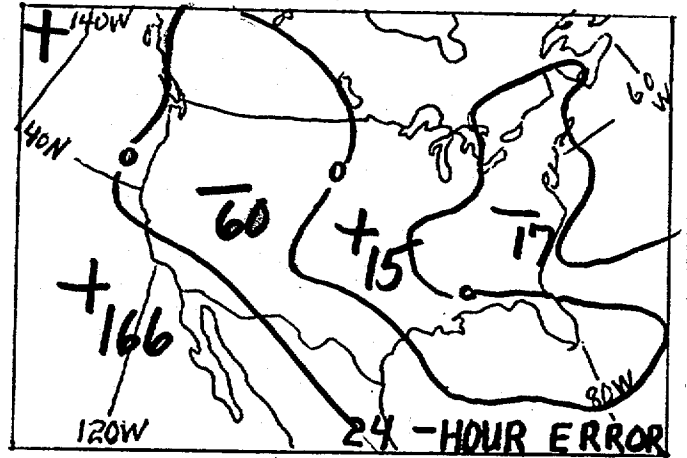
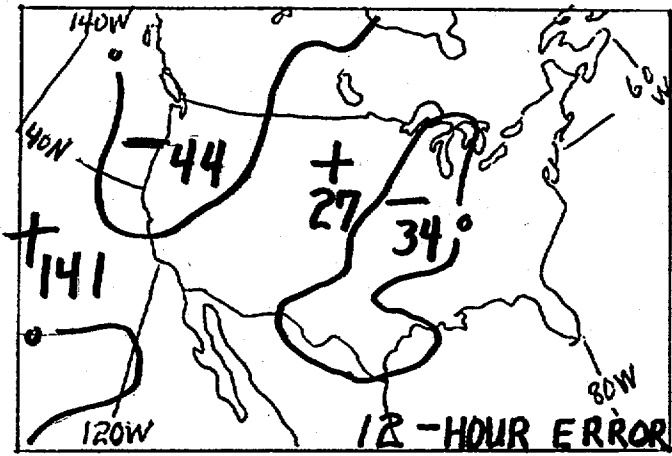

NMC

GLOBAL

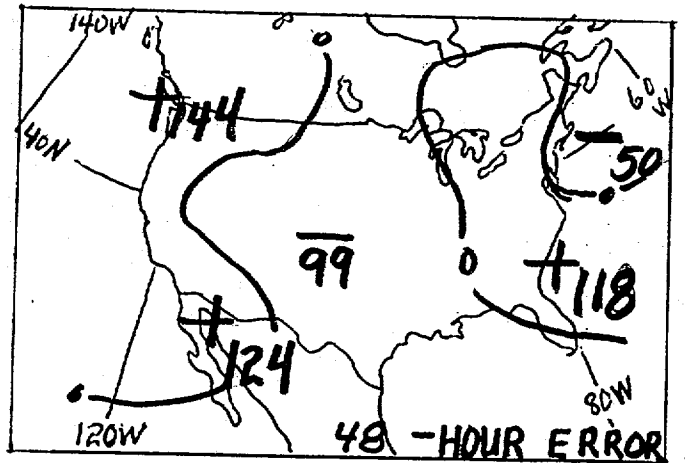
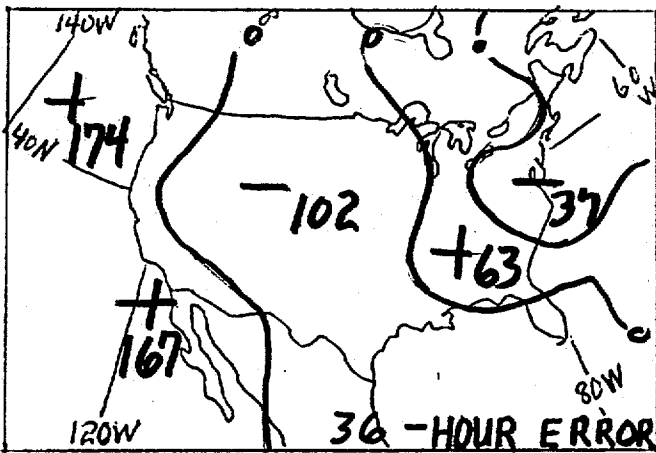



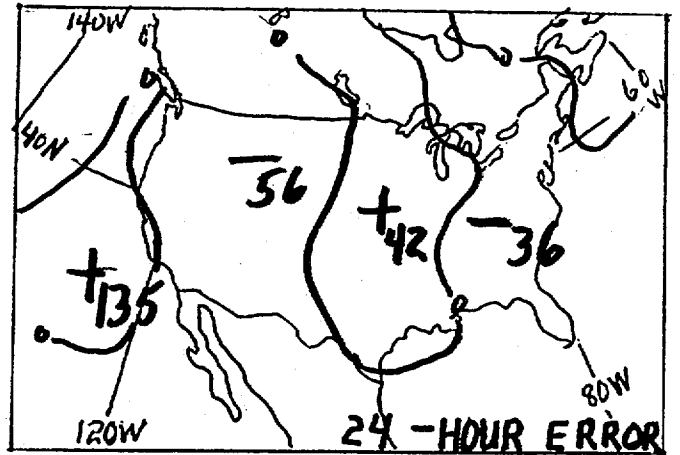
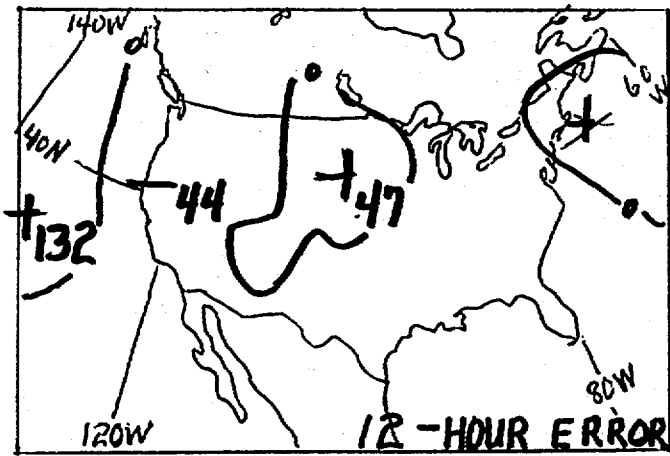

U.K. METEOR. OFF.

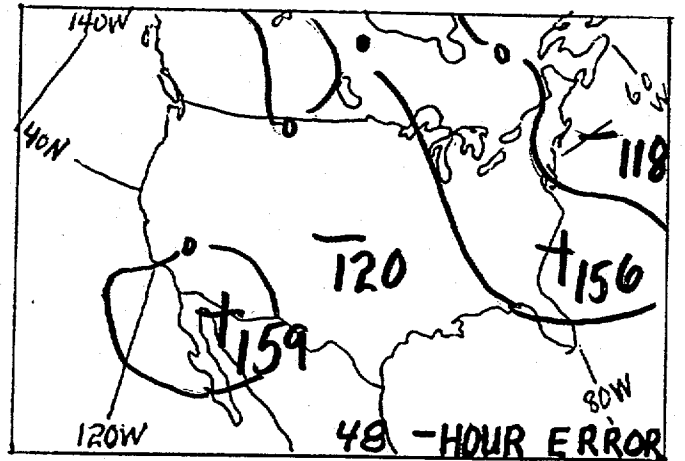
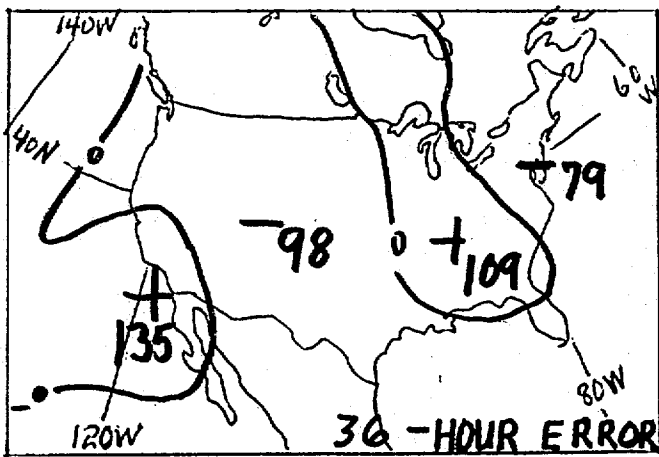

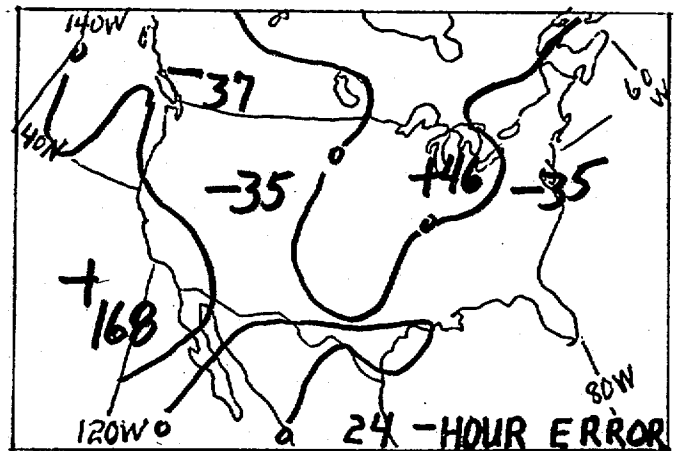

# ECMWF

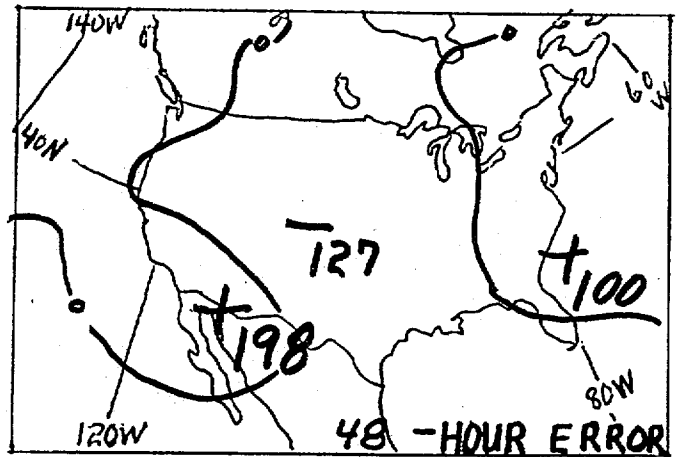
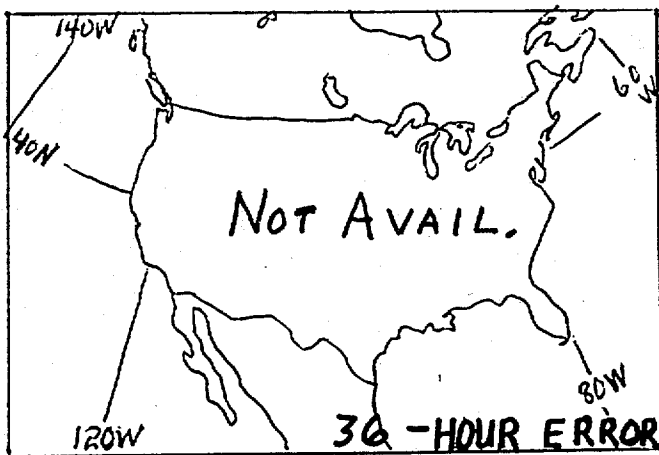

0300Z - 0900Z

06Z 29 JAN 87 -- SATELLITE THICKNESS REPORTS

