

WORLD DATA CENTER A
for
Solar-Terrestrial Physics

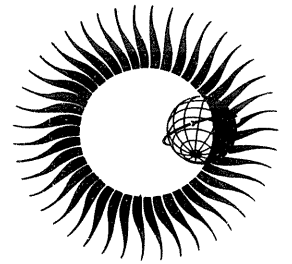

REVISION OF CHAPTERS 1 - 4

U.R.S.I. HANDBOOK OF IONOGRAM
INTERPRETATION AND REDUCTION
Second Edition November 1972



July 1978

WORLD DATA CENTER A
National Academy of Sciences
2101 Constitution Avenue, N.W.
Washington, D.C., U.S.A., 20418

World Data Center A consists of the Coordination Office

and seven Subcenters:

World Data Center A
Coordination Office
National Academy of Sciences
2101 Constitution Avenue, N.W.
Washington, D.C., U.S.A., 20418
[Telephone: (202) 389-6478]

Glaciology:

World Data Center A: Glaciology
[Snow and Ice]
Inst. of Arctic & Alpine Research
University of Colorado
Boulder, Colorado, U.S.A. 80309
[Telephone: (303) 492-5171]

Meteorology (and Nuclear Radiation):

World Data Center A: Meteorology
National Climatic Center
Federal Building
Asheville, North Carolina, U.S.A. 28801
[Telephone: (704) 258-2850]

Oceanography:

World Data Center A: Oceanography
National Oceanic and Atmospheric
Administration
Washington, D.C., U.S.A. 20235
[Telephone: (202) 634-7249]

Rockets and Satellites:

World Data Center A: Rockets and
Satellites
Goddard Space Flight Center
Code 601
Greenbelt, Maryland, U.S.A. 20771
[Telephone: (301) 982-6695]

Rotation of the Earth:

World Data Center A: Rotation
of the Earth
U.S. Naval Observatory
Washington, D.C., U.S.A. 20390
[Telephone: (202) 254-4023]

Solar-Terrestrial Physics (Solar and
Interplanetary Phenomena, Ionospheric
Phenomena, Flare-Associated Events,
Geomagnetic Variations, Magnetospheric
and Interplanetary Magnetic Phenomena,
Aurora, Cosmic Rays, Airglow):

World Data Center A
for Solar-Terrestrial Physics
Environmental Data Service, NOAA
Boulder, Colorado, U.S.A. 80303
[Telephone: (303) 499-1000, Ext. 6467]

Solid-Earth Geophysics (Seismology,
Tsunamis, Gravimetry, Earth Tides,
Recent Movements of the Earth's
Crust, Magnetic Measurements,
Paleomagnetism and Archeomagnetism,
Volcanology, Geothermics):

World Data Center A
for Solid-Earth Geophysics
Environmental Data Service, NOAA
Boulder, Colorado, U.S.A. 80303
[Telephone: (303) 499-1000, Ext. 6521]

NOTES:

1. World Data Centers conduct international exchange of geophysical observations in accordance with the principles set forth by the International Council of Scientific Unions. WDC-A is established in the United States under the auspices of the National Academy of Sciences.
2. Communications regarding data interchange matters in general and World Data Center A as a whole should be addressed to: World Data Center A, Coordination Office (see address above).
3. Inquiries and communications concerning data in specific disciplines should be addressed to the appropriate subcenter listed above.

WORLD DATA CENTER A
for
Solar-Terrestrial Physics



REPORT UAG-23A

REVISION OF CHAPTERS 1 - 4

U.R.S.I. HANDBOOK OF IONOGRAM
INTERPRETATION AND REDUCTION

Second Edition November 1972

edited by

W.R. Piggott

Radio and Space Research Station, Slough, U.K.

and

K. Rawer

Arbeitsgruppe für Physikalische Weltraumforschung
Freiburg, G.F.R.

Adopted by U.R.S.I. Commission III,
Warsaw, Poland, 1972

July 1978

Published by World Data Center A for
Solar-Terrestrial Physics, NOAA, Boulder, Colorado
and printed by

U.S. DEPARTMENT OF COMMERCE
NATIONAL OCEANIC AND ATMOSPHERIC ADMINISTRATION
ENVIRONMENTAL DATA SERVICE
Asheville, North Carolina, USA 28801

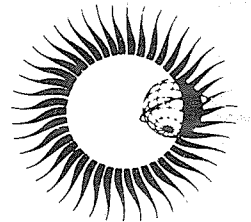

SUBSCRIPTION PRICE: \$25.20 a year; \$17.30 additional for foreign mailing; single copy price varies.*
Checks and money orders should be made payable to the Department of Commerce, NOAA/NGSDC.
Remittance and correspondence regarding subscriptions should be sent to the National Geophysical and
Solar-Terrestrial Data Center, NOAA, Boulder, CO 80303.

PRICE THIS ISSUE \$2.14

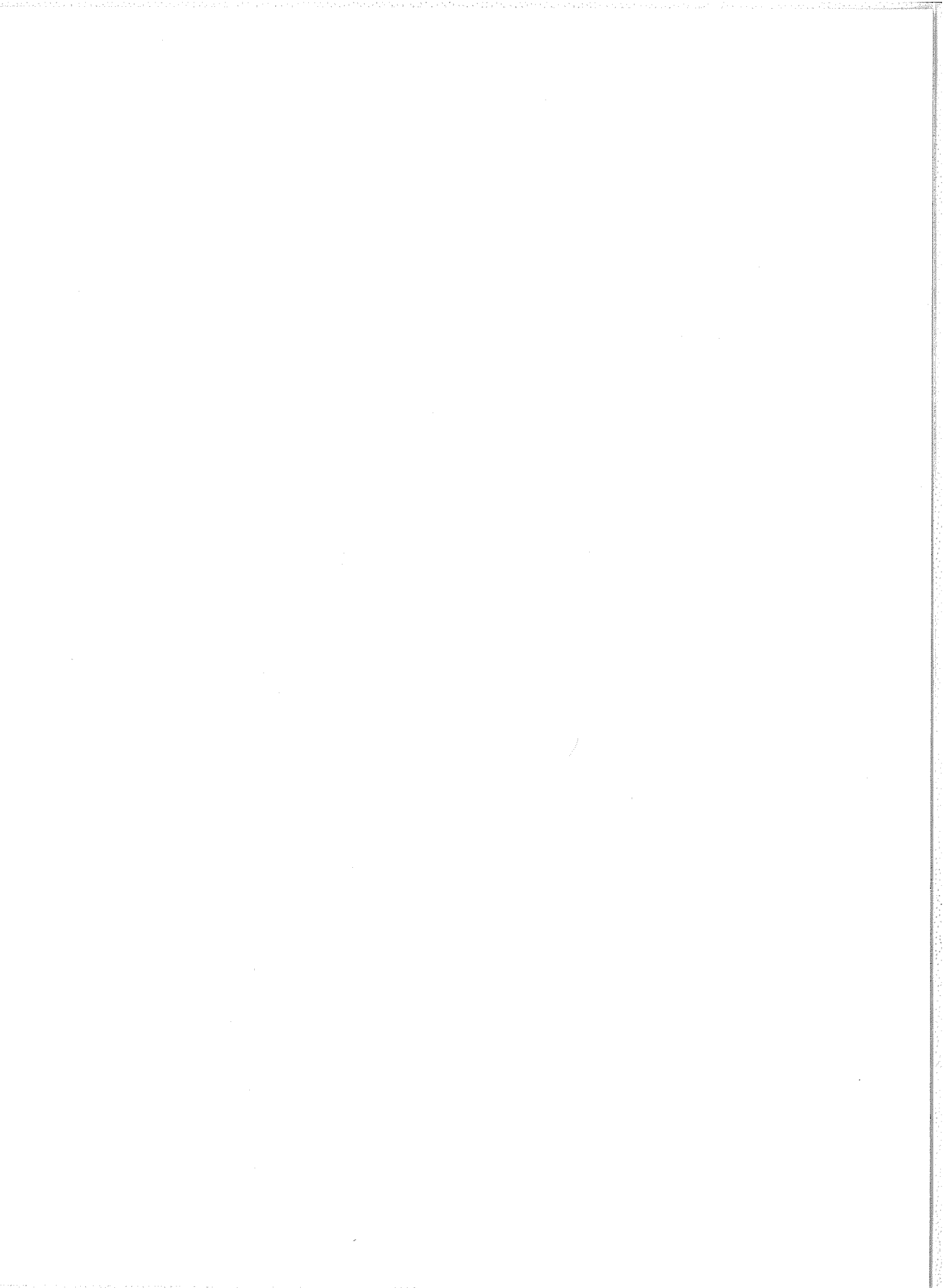

FOREWORD

The Second Edition of the URSI Handbook of Ionogram Interpretation and Reduction (WDC-A Report UAG-23, November 1972) differed greatly from the first edition. It included much additional material requested by operators with problems when conditions were difficult, also rules and descriptions of phenomena whose importance had not been realized when the first edition was written.

Inevitably mistakes and ambiguities were discovered, and some of the rules for parameters important for the International Magnetospheric Study (IMS) needed further refinement. Many of these corrections and amendments were collected and published in the INAG Bulletin (in particular 16, 17, 21, and 23, and in the High Latitude Supplement (W. R. Piggott Report UAG-50, WDC-A October 1975)). The work of amending the original Handbook is now very considerable, and the Ionospheric Network Advisory Group (INAG) and the Editors therefore decided to reprint the first four Chapters, which contain most of the changes. This book is the result.

It must be stressed that the value of the data for regional or worldwide studies depends on the maintenance of consistent reduction and tabulation methods at all stations, and proposals for changes in or clarifications of these rules should be forwarded to a member of INAG. Particular care is necessary that local "house-rules" are not in conflict with these principles.

Most sections of this book are written in the form of detailed instructions to the operators at ionospheric stations. However, the Introduction and the subsections marked .0 at the beginning of each section give the principles involved in more general form together with historical notes where these may help the operator or administrative staff to understand the detailed rules.

Section 0.2 in the Introduction, on "General Considerations and Principles", is included to show the important rules to be observed if, at any station, it is impossible to apply the standard rules and conventions fully.

When using the Manual for teaching purposes, it is advisable to teach the simple rules for the horizontally stratified ionosphere first, then to add special cases and the treatment of difficult ionograms. In the original planning of the rules, it was intended that a few simple principles should be applied to cover a wide range of phenomena. This was not entirely possible, and in a few cases some arbitrary rules must be learned. The accuracy rules are essential for the identification of accurate values, and for the systematic use of the letter symbols, when accurate data cannot be obtained. It is essential to stress this point since departures from these rules can cause great difficulty both to those reducing the ionograms and those using the data obtained.

Cross Reference to Ionograms

References in the text in the form A... give the pages on which corresponding or additional material can be found in the *IGY Instruction Manual for the Ionosphere, Annals of the IGY*, Volume III, Part I, English text. The reference shows whether the additional material is an ionogram (A (page) I, Fig....), a figure (A (page) F, Fig....) or is descriptive (A (page) D).

Since it was not possible to illustrate the Handbook with ionograms, INAG and the Editors decided to supplement the references to ionograms in the *Annals of the IGY*, Volume III, Part I by references to ionograms published in the *Atlas of Ionograms* prepared by A. H. Shapley, World Data Center A, Upper Atmosphere Geophysics Report UAG-10, May 1970. These references are denoted B (page) I Fig....

The High Latitude Supplement (Report UAG-50) was written primarily for those working at high latitudes, and gives many ionogram sequences showing typical high latitude phenomena. However, it also contains many hundreds of ionograms which can be used to clarify the interpretations at lower latitudes. Many of these have been annotated by the Editor (W. R. Piggott) thus giving examples of how the rules should be applied.

It must be stressed that this publication (UAG-23A) is not intended to be a complete guide to ionogram interpretation and reduction, and should be read in conjunction with the remaining chapters of UAG-23, and, where appropriate, UAG-50. In particular, the chapters on tabulations, medians and f plots have not been revised here, since they contain few amendments and the general interest chapters have been amended only where typing errors occurred or the text was obscure. As in all work of this type, the final document owes much to comments made by INAG members and consultants, and, in particular, to Ray Conkright, Alan Rodger and Richard Smith. It could not have been produced without the constant interest of Miss J. V. Lincoln, and the support of WDC-A. The accuracy of a document of this type depends greatly on the care taken both by the typists of WDC-A who prepared the master copies, the careful proofreading by WDC-A staff, and by those mentioned above. The Editor wishes to convey his thanks to all concerned and, as Chairman of INAG, to convey the thanks of the users of this Manual, who will be saved much work by its publication.

List of Abbreviations Used in this Publication

CCIR	International Radio Consultative Committee
CIG	Comite International de Geophysique (terminated 1967)
COSPAR	Committee on Space Research
COSTED	Committee on Science and Technology in Developing Countries
CSAGI	Comite Special de l'Annee Geophysique Internationale (terminated 1959)
FAGS	Federation of Astronomical and Geophysical Services
GARP	Global Atmospheric Research Programme
IAGA	International Association of Geomagnetism and Aeronomy
IAMAP	International Association of Meteorology and Atmospheric Physics
IASY	International Active Sun Years (1968-1970)
IAU	International Astronomical Union
ICSU	International Council of Scientific Unions
IGY	International Geophysical Year (1957-1958) (in French AGI)
IQSY	International Years of the Quiet Sun (1964-1965)
ITU	International Telecommunication Union
IUGG	International Union of Geodesy and Geophysics
IUPAP	International Union of Pure and Applied Physics
IUWDS	International Ursigram and World Days Service
SCAR	Scientific Committee on Antarctic Research
SCHL	Special Committee on High Latitudes
SCOPE	Special Committee on Problems of the Environment
SCOSTEP	Special Committee on Solar-Terrestrial Physics
UAG	Upper Atmosphere Geophysics
UNESCO	United National Education, Scientific and Cultural Organization
URSI	Union Radio-Scientifique Internationale (URSI/AGI and URSI/IGY)
WDC	World Data Center
WMO	World Meteorological Organization
WWSC	World Wide Soundings Committee

CONTENTS

	Page
FOREWORD	i
0 INTRODUCTION	1
0.0 Historical	1
0.1 Development of Systematic Vertical Incidence Soundings	1
0.2 General Considerations and Principles used to Establish the Operating Rules and Conventions	2
0.3 Writing Conventions	4
0.4 Acknowledgements	5
1 FUNDAMENTAL CONSIDERATIONS AND DEFINITIONS	7
1.0 General	7
1.1 Conventions for Identifying Critical and Characteristic Frequencies	19
1.2 New Parameters	21
1.3 Conventions for Identifying and Scaling Virtual Heights	22
1.4 Conventions for Determining Other Height Parameters	23
1.5 Conventions for Determining MUF Factors	23
1.6 Characteristics to be Scaled	25
1.7 Sounding Schedules	25
1.8 Station Operations	26
1.9 Computer Output	26
2 DETERMINATION OF HOURLY NUMERICAL VALUES	29
2.0 General Conventions	29
2.1 Accuracy Considerations	29
2.2 Accuracy Rules for Individual Measurements	31
2.3 Qualifying and Descriptive Letters	34
2.4 Extrapolation	35
2.5 Interpolation	39
2.6 Gain Runs	39
2.7 Scaling in Presence of Oblique or Spread Echo Traces	40
2.8 Spread F Types	58
3 QUALIFYING AND DESCRIPTIVE LETTERS	65
3.0 Use of Qualifying and Descriptive Letters	65
3.1 Qualifying Letters	65
3.2 Descriptive Letters	67
3.3 Rules for the Analysis of fxI	99
4 Es CHARACTERISTICS	105
4.0 General Considerations	105
4.1 Es Characteristics to be Tabulated	106
4.2 Es Scaling Conventions	106
4.3 Techniques for Distinguishing between the Magneto-electronic Components in Es Traces	109
4.4 Scaling of foEs	118
4.5 Scaling of fxEs	119
4.6 Scaling of fbEs	121
4.7 Scaling of h'Es	124
4.8 Classification of "Types of Es"	124
4.9 Provisional f plot Indication of fxEs	135

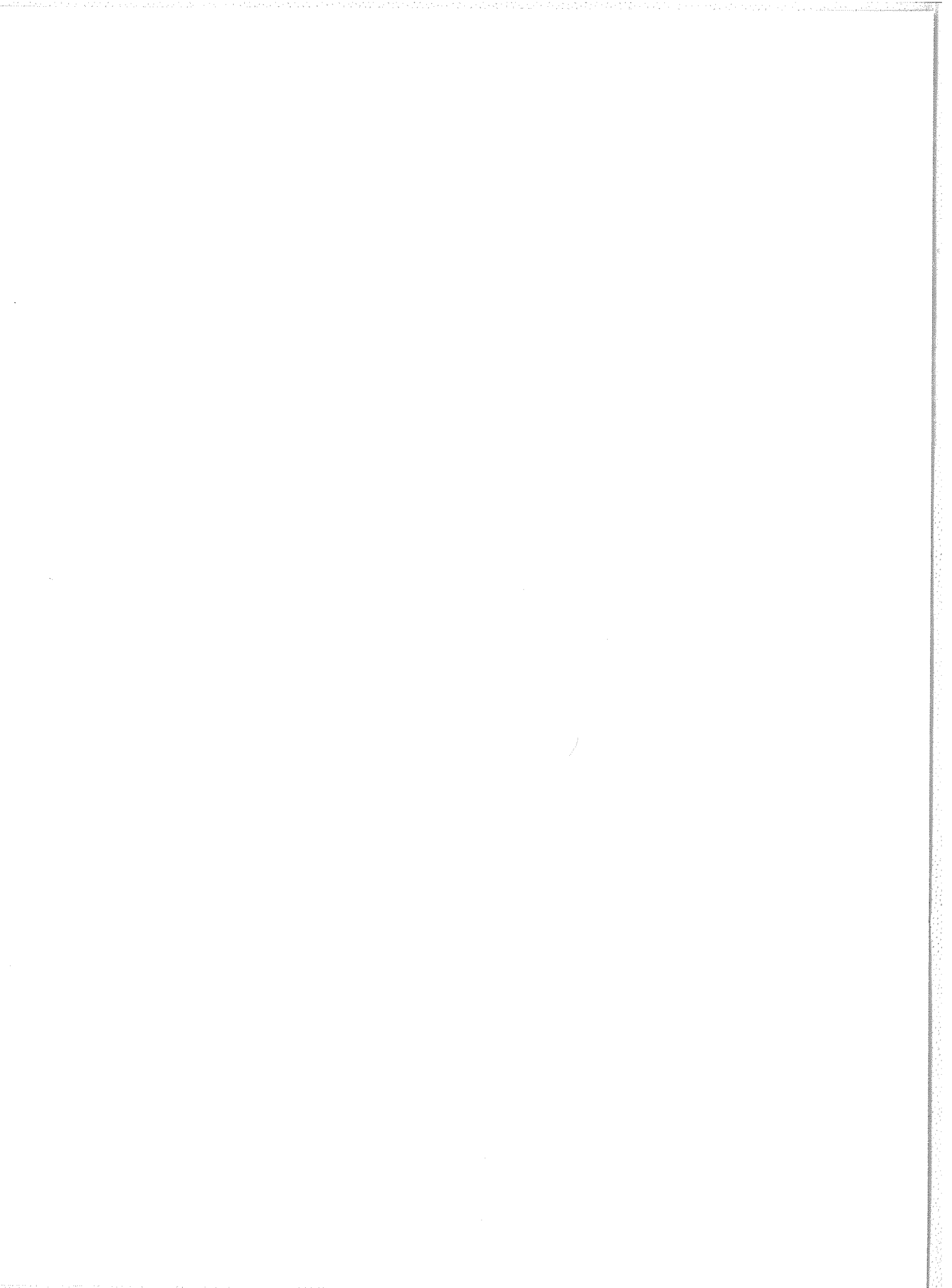

0.0 Historical

The earliest routine ionospheric stations were almost all placed in temperate latitudes where the echo traces on the ionograms could usually be classified as belonging to a few easily recognized patterns. These patterns could be interpreted in terms of simple models of the structure of the ionosphere. Naturally the main characteristics of the patterns were named and measured regularly and attempts were made to interpret nonstandard patterns in terms of the nearest simple model. Difficulties arose during periods of ionospheric storm and the establishment of a station on the magnetic equator, Huancayo, showed that wide departures from the conventional patterns could occur even in quiet periods. However, even greater deviations occurred at high-latitude stations, where the ionograms not only showed many abnormal traces but were also liable to change fundamentally in the space of a few minutes. Many workers felt that the range of interpretations possible in these circumstances was so great that it was not practical to make high latitude observations comparable with those at temperate latitudes. The first major international effort to solve this problem was made by the URSI Special Committee on High Latitudes (SCHL) in a report published in the URSI Information Bulletin, 1955, No. 96, p. 44. The work of the SCHL showed that rather few ionospheric phenomena are restricted entirely to high latitudes, though the incidence of complex or difficult ionograms varies considerably with latitude. Thus the techniques developed originally for clarifying phenomena at high latitudes could form a basis for improving ionospheric observations for the whole world. Furthermore, it became clear that ionograms obtained at low latitudes also often differed from the simple standard medium latitude models. Attempts to reduce such ionograms were greatly influenced by the experience and knowledge of the operators at individual stations, so that the numerical data produced were rather questionable and inhomogeneous. It was obviously desirable to attempt to minimize these difficulties before starting the intensive observational program of the IGY.

The Special Committee on World Wide Ionospheric Soundings (WWSC) was appointed in September, 1955, by the URSI/AGI Committee and directed to consider the revision of the procedures for the production, reduction and presentation of ionograms and ionosphere characteristics. The Committee has always attempted to maintain the closest possible contact with station networks and individual stations through its members and consultants.

The First (Brussels) Report of the Committee was published in the URSI Information Bulletin No. 99, pp. 48-90. Two annexes to the report appeared in the URSI Information Bulletin No. 100, pp. 82-89. This First Report, which is a basis of the Handbook, was clarified, expanded and slightly amended in the Second (Tokyo-Lindau) Report. This was widely circulated in May, 1957, as the well-known "Green Book". A third meeting of the Committee, together with almost all its principal consultants and a number of especially invited participants, was held in Brussels, August-September, 1959. This enabled the experience and views of almost all soundings networks and of typical isolated stations to be considered, and showed the need and desire for further collaboration to enable world and regional problems in the morphology of the ionospheric layers to be studied efficiently. In particular, the Committee recognized the need to collect the techniques found valuable in the IGY in the form of a handbook of ionogram interpretation and reduction suitable for use at the individual stations of the world network. The first edition of this volume was the result of the work done by the Committee and its Consultants at Brussels and subsequently elsewhere, and the second edition has been revised by the editors in the light of comments made by users.

0.1 Development of Systematic Vertical Incidence Soundings

While the first routine ionospheric soundings stations were set up primarily for scientific purposes - to discover the causes and characteristics of the reflecting and absorbing layers in the ionosphere - the great expansion of the network during the Second World War was brought about by the need to make predictions of radio propagation conditions over the world. The data obtained were used almost exclusively for practical purposes and remarkably few studies were made to discover their significance and meaning. It is probable that only a small percentage of the ionograms obtained were examined by qualified research workers and most serious research work was concentrated at a few stations where qualified staff were available. However, the researches made showed that the reliability and comparability of the data were scarcely adequate even for the simplest investigations. This situation was radically changed by the special procedures and studies developed for, or as a result of, the International Geophysical Year. For the first time stations all over the world used essentially the same detailed conventions and methods, giving an invaluable improvement in the uniformity of the data produced. The new researches made possible by the improvement in quality and the greatly increased quantity of data have suggested new ways of studying the ionosphere and provoked similar researches at other epochs in the solar activity cycle. Thus the special effort of the IGY started a new phase in ionospheric research which will be marked by much closer international collaboration than had been usual in the past.

INTRODUCTION

The literature of ionospheric studies shows the great value of having a wide geographic distribution of stations for the study of the morphology of the ionosphere, the analysis and understanding of great geophysical events, some of which are very infrequent, and the production of ionospheric maps for geophysical and radio propagation prediction projects. In general, space investigations give great detail of the variation of the ionosphere with position at a fixed time but cannot identify time development or separate time from space variations. Thus the data obtained are difficult to use unless monitored by ground based measurements. In the case of rockets these show whether the conditions during the firing were typical or abnormal. For satellites, ground based observations enable the dynamic behaviour to be studied, thus indicating the type of forces responsible for the observed spatial variations. They are also essential for separating changes in time from those in space - a short-lived worldwide disturbance can look localized when observed by satellite as it is only seen in the parts of the orbit covered while it is active. Both rocket and satellite data are much more valuable if the geophysical conditions on each day are known. This is easily done using synoptic ground based data.

0.2 General Considerations and Principles used to Establish the Operating Rules and Conventions

0.21. The maintenance of an adequate network of stations and the circulation of sufficient data for scientific and practical purposes depend on the voluntary cooperation of organizations whose primary interests fall into four different fields:

- (a) Those primarily concerned with earth environment studies.
- (b) Those interested in the exact form of the ionosphere at a specified time, e.g. for comparison with rocket or satellite data or for studying time variations in events.
- (c) Those primarily concerned with radio propagation problems, both surface and space.
- (d) Those involved in geophysical studies which involve the ionosphere or in which ionospheric sounding provides convenient monitoring techniques.

Practical experience shows that most ionospheric problems can only be completely studied by using data from groups of stations, and hence demand the cooperation of many organizations and individuals. It frequently happens that data produced by one station or group are mainly used by another, quite independent group having little or no direct contact with the original observations. This situation is, of course quite normal in geophysical studies. The value of comparable data obtained from a group of stations greatly exceeds the value of the data from each station considered separately. Thus, no matter what the primary objective of the station may be, the greatest return is obtained if the observations made at the station can be used for the four overlapping basic types of investigation:

- (a) To monitor the ionosphere above the station.
- (b) To obtain significant median data to evaluate long-term changes.
- (c) To study phenomena peculiar to the region.
- (d) To study the global morphology of the ionosphere.

While it is advantageous to use the same techniques and conventions for all four purposes whenever possible, types (a) and (c) may call for local procedures in addition to those necessary for (b) and (d). However, even in these cases, the interchange of data and theories is greatly simplified if the same conventions are used everywhere.

Studies using new techniques, e.g. rockets, satellites, incoherent scatter, etc., often demand

- (i) A knowledge of the median behaviour of the ionosphere.
- (ii) Whether or not particular days, for which particular measurements are available, were typical average days.
- (iii) The relations between geophysical conditions on particular days and average days.
- (iv) Detailed variations in time during particular events.

Thus there is a need for a set of standard techniques and conventions applicable to the majority of problems likely to be investigated in different parts of the world.

0.22. It is, in principle, possible to develop the reduction of ionograms using four different points of view, each of which would suggest a particular set of parameters for measurement and interchange. These are:

- (a) To make a phenomenological description of the ionogram.
- (b) To give a simplified parametric description of the ionosphere overhead.
- (c) To determine the electron density/height profile overhead.
- (d) To identify and measure parameters which determine or describe the physical characteristics of the ionosphere.

Historically, most early work on ionograms was influenced mainly by the first possibility. Certain investigations at individual stations are directed towards (c) and (d). For the worldwide network as a whole, the second possibility is most appropriate and the choice of parameters and rules is, therefore, consistent with this concept. A discussion of the third possibility can be found in Chapter 10 of Report UAG-23.

0.23. In considering what should be tabulated, it is well to bear in mind that the tabulations are primarily for use by people who will not see the records themselves and who are interested in problems solvable by tabulated data alone.

The selection of significant parameters is always a somewhat arbitrary process determined finally by the purpose for which the selection is made. In practice, it is also influenced by the ease of measurements; for example, a highly significant parameter which is very difficult to measure may be replaced by a less significant one which is easier to measure. This may increase the efficiency of the research as a whole.

There are several difficulties in applying these principles to worldwide investigations:

- (i) A decision must be made that certain phenomena are more important than others.
- (ii) Phenomena which are very important in some zones of the world can be almost or completely absent elsewhere.
- (iii) Parameters which are significant and easy to measure in some areas are very difficult to measure in others.

This suggests that it is very desirable that three levels of selection should be made:

- (a) Parameters required all over the world.
- (b) Parameters required for regional studies.
- (c) Parameters required for local studies at the station.

The principal international parameters fall mainly into class (a), though some are not measurable in all parts of the world. They include certain characteristics which are useful for investigating the incidence of particular phenomena, e.g., Es types. In general the local parameters, class (c), are seldom useful on a worldwide basis, mainly because the phenomena change with position and definitions and rules which give useful precision at one station become seriously misleading when applied in a different theater of operation.

0.24. The basic routine scalings at any station should delineate the essential features of the ionosphere overhead and should be used initially to produce representative data at relatively infrequent, hourly, intervals. It is important that these data be as complete as possible and controlled interpolation is therefore encouraged. (See Chapter 2).

The results tabulated should not be an exhaustive description of the record but represent the essential features of the first order vertical reflection rather than the characteristics of multiples, oblique echoes and transient phenomena. Multiple, as well as x- and z-traces, should be used as auxiliary guides in the interpretation of the first order ordinary pattern (see 1.03). Oblique traces should be ignored in the interpretation of f plots or in the tabulation of hourly values and should be omitted when recognized, unless they contribute to the understanding of the main trace.

While at temperate and low latitudes the intention is clearly to concentrate on vertical incidence traces in order to describe the "ionosphere overhead", the situation is sometimes more involved at high latitudes. There, it is often valuable to study the properties of ridges of ionization seen by oblique reflection, e.g., phenomena giving fxI greater than $fxF2$. These possibilities are discussed in the "High Latitude Supplement" (Report UAG-50).

It must be stressed that many ionospheric parameters, e.g., $h^{\circ}F$, $M(3000)F2$ which are invaluable for geophysical or prediction purposes, do not directly measure physical phenomena and may be misleading in particular circumstances unless their properties are clearly understood. It is clearly the user's responsibility to make himself conversant with the subject so as to understand these points, whereas it is the operator's responsibility to reduce a difficult ionogram adequately according to the established rules.

0.25. The hourly tabulated data should be self-explanatory, representative of ionospheric conditions for the period centered at the hour and, as far as possible, not misleading for those receiving these data alone. In particular, the use of the standard international designations, $foF2$, $foF1$, foE , $foEs$, $h'F$, $h'F2$, $fmin$, etc., implies that the data conform to the reduction rules.

0.26. The following points are often overlooked:

- (a) Where data are not published, adequate catalogues of the unpublished material, data or ionograms, need to be kept and published through the World Data Centers (WDCs).
- (b) Techniques which save some labor at a station at the cost of considerable inconvenience to the user are not really economical.
- (c) It is most economical to put data into a form suitable for computer handling at the earliest possible stage. At present most data are put into this form sooner or later and this is the preferred form for international interchange of data.
- (d) The f plot is a valuable tool for identifying variations in the ionosphere and the interpretation of complex records particularly at high latitudes.

0.27. The relative priorities of measuring different parameters will change with the development of the science and will depend on the existence of particular regional or worldwide studies. Guidance on these points will be found in the current URSI and INAG Information Bulletins.

However, it is particularly important to obtain representative numerical values whenever possible for the basic parameters of the most variable layers: f_oF_2 , $M(3000)F_2$, f_oE_s . It is also important to measure f_{min} , which is the sole index of absorption given by ionograms. For control purposes, it is also an important parameter for monitoring the behavior of the ionosonde.

Further research on the data, however, appears to be developing into two widely different directions:

- (a) Studies of the detailed structure of the ionosphere demanding detailed and accurate measurements of the instantaneous values of important ionospheric parameters.
- (b) Studies of the general structure of the ionosphere and its variation with other phenomena demanding statistically representative and, as far as possible, complete sequences of data.

Instrumental, operational and ionospheric factors combine to make it possible to obtain relatively small quantities of highly accurate data or alternatively to produce more complete sequences of lower grade data. The best compromise depends on the equipment and staff available, the position of the station in the world network, and the type of work regarded as most important. Provided that the international rules and conventions are observed, useful work can be done even if the most desirable accuracy is not obtainable or all the data on the ionograms cannot be circulated. However, it is essential that the relatively few stations capable of producing ionograms of the highest quality should make every effort to maintain the best accuracy practical.

A similar problem arises with electron density profile calculations where precise profiles demand first class ionograms, very elaborate computing procedures and the highest possible accuracy of measuring virtual height and frequency. This is usually uneconomical where statistical data are required and relatively simple techniques are then preferable. The former is a specialized problem not discussed in this volume and the procedures for the latter may be found in Chapter 10 of Report UAG-23.

0.3 Writing Conventions

By international agreement, all symbols which represent parameters which are or may be interchanged internationally are designated by on-the-line symbols for example f_oF_2 , or $M(3000)F_2$.

Frequency, f , height, h , the ordinary, extraordinary and z modes, $o x z$, and E_s types (see however, sections 1.9 and 4.8) are always written with small (lower case) letters except when produced by machines in which these are not available (Computer, Telex or Telegram outputs).

As is normal scientific practice, physical quantities are designated in suffix form unless they are actually measured.

In this edition we have modernized the symbol for magnetic field, substituting B for H throughout. Thus the electron gyrofrequency is now written f_B instead of f_H , the traditional but incorrect form. This is widespread but not universal practice at present. The corresponding correction term is $f_B/2$ instead of $f_H/2$.

Since the numerical factors in equations linking physical parameters depend on the system of units used, we have adopted the convention that the parameter is divided by the units in use. Thus, if the electron density N is measured in m^{-3} and the plasma frequency f_N in MHz, the relation between N and f_N ; $N = 1.24 \cdot 10^{10} (f_N)^2$, becomes $N/m^{-3} = 1.24 \cdot 10^{10} (f_N/\text{MHz})^2$ (equations 1.1 in section 1.04). This is read as N in $m^{-3} = 1.24 \cdot 10^{10} (f_N \text{ in MHz})^2$.

0.4 Acknowledgements

A Handbook of this type is the result of the efforts of many experts in different countries. The final form, the decisions on what to put in, leave out or modify, has been the responsibility of the Editors. Thus, the names of contributors are only included in the text where the Editors felt that users might wish to discuss particular points with them. These are mainly new techniques. Mr. A. H. Shapley was responsible for the original proposal to revise the Handbook.

The Editors wish to acknowledge the help they have received from members of INAG, experts in the fields of topside soundings, electron density profile analysis and high latitude phenomena. Most of the modifications to the text of the first edition have been made as a result of comments or requests for clarification made by numerous operators. They have also had much help from meetings arranged under the auspices of the URSI-STP Committee, INAG, and National groups involved in operating VI networks.

Many of the figures in this edition are new or redrawn and the Editors are grateful to the Directors and staff of the Science Research Council, Appleton Laboratory, Slough, U.K., and World Data Center A for Solar-Terrestrial Physics, Boulder, CO, U.S.A. for their help in preparing both figures and text. The aid given by Mr. Richard Smith and Mrs. E. Hurst to W. R. Piggott needs special mention. Figures Nos. 1.9, 1.10, 11.11, 11.12 are reproduced by the kind permission of Springer-Verlag Heidelberg and taken from Vol. 49/2 of the Encyclopedia of Physics (contribution by K. Rawer and K. Suchy, "Radio Observations of the Ionosphere", pp 1-546, 1967).

The Editors wish to acknowledge the critical comments provided by Mrs. L. Hayden and Mr. T. N. Gautier of WDC-A and Mr. R. Smith of Appleton Laboratory, on behalf of station operators. Mrs. L. Hayden has checked the manuscript, proof read the whole of the text--a major task in view of the large number of cross references, and made numerous detailed suggestions.

The publication would not have proved possible without the prolonged efforts of J. Virginia Lincoln, World Data Center A, who was in charge of publication. W. R. Piggott wishes to thank the Directors of the Appleton Laboratory, who have supported this work.

1.0 General

1.01. The ionosphere is that part of the atmosphere where free electrons occur in an appreciable density so as to influence considerably the propagation of radio waves. It is convenient to divide the ionosphere into three regions, called D, E and F.

D - The zone between about 75 km and about 95 km above the earth in which the ionization is found that is mainly responsible for absorption of those high frequency radio waves which are reflected by higher layers.

E - The zone between about 95 km and about 150 km above the earth in which the normal daytime E layer is usually found. Other layers in this zone are also described with the prefix E, e.g. the thick layer E2 or the highly variable thin layer Es.

F - The zone above about 150 km in which the most important reflecting layer, F2, is usually found. Other stratifications in this zone are also described with the prefix F, e.g. the temperate latitude regular stratification F1 and the low-latitude semiregular stratification F1.5.

1.02. The standard ionosonde [A70D] (see foreword p.i and p.iii) produces photographic records known as ionograms, which show the variations of the virtual height of reflection as a function of the radio frequency, $h'(f)$ [A25D, A31D]. The frequency band normally used is from about 1 MHz to about 20 MHz though some ionosondes can be operated down to about 0.20 MHz when interference allows. Short descriptions and copies of ionograms from most types of ionosonde will be found in the Atlas of Ionograms, B section, p. 1.1 - 1.11. The ionograms actually show the time of travel of the pulse signal from the transmitter to the cathode ray tube, reflection in the ionosphere normally occurring at vertical incidence. As this signal always travels more slowly in the ionosphere and in the receiver than in free space, the heights observed always exceed the true heights of reflection. If the frequency of a radio signal reflected from a single thick layer is increased the virtual height increases more rapidly than the true height. When the level of maximum electron density in the layer is reached, the virtual height becomes effectively infinite (Fig. 1.1). The frequency at which this occurs is called the critical frequency of the layer. If the reflecting layer is very thin, the increase in virtual height with frequency cannot be observed but the amplitude of the signal appears to decrease rapidly above a certain frequency [A40D] [B section III]. The highest frequency at which a clear, almost continuous trace is obtained is called the top frequency of the trace [A40I, Figs. 31, 33, 34].

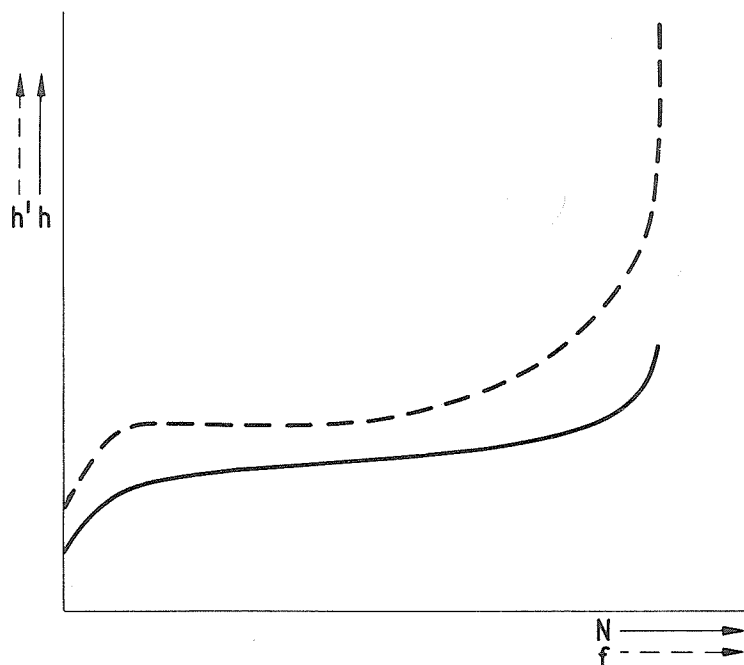

Fig. 1.1 Relations between virtual height and true height (no magnetic field).
 _____ ionization distribution, - - - - - $h'(f)$ pattern.

1.03. The Earth's magnetic field, in general causes a radio wave incident on the bottom of the ionosphere to be divided into two waves of different polarization which are reflected independently in the ionosphere [A26D]. These waves are known as magneto-ionic or, preferably, magneto-electronic component waves. They are due to the interaction of the electrons in the plasma with the magnetic field. Modern plasma theory shows that the presence of ions can introduce additional modes and waves which can be observed experimentally and are accurately described as magneto-ionic waves. By analogy with optical double refraction, one is called the ordinary wave and the other, the extraordinary wave.

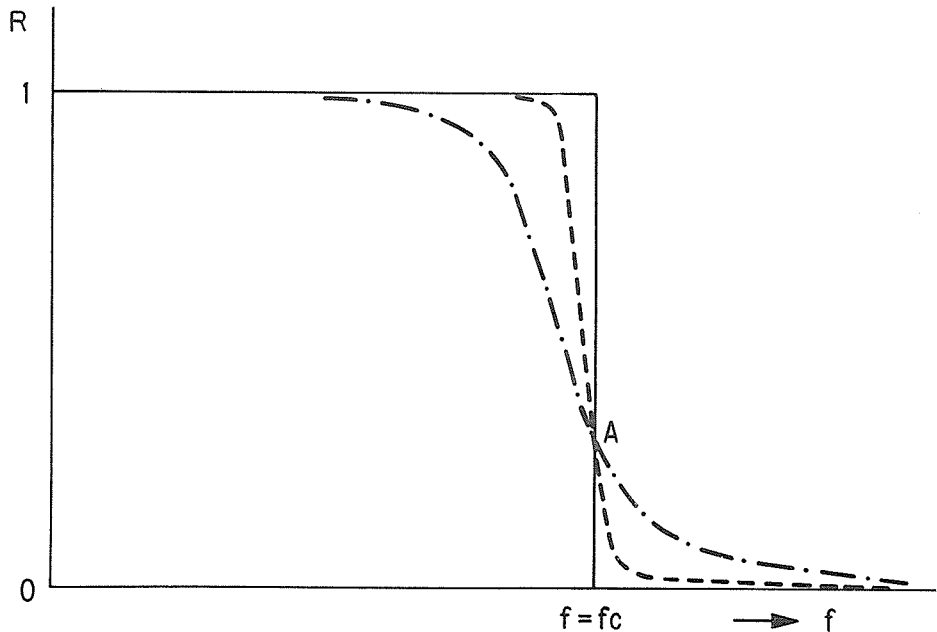

Fig. 1.2 Reflection coefficient, R , of a thin and thick layer as a function of frequency.

— thick
 --- thin
 -·-·- very thin

The value of R at A depends on the shape of the layer.

Since the conditions of reflection for the two components are different, each produces its own $h'(f)$ pattern. These are similar but displaced in frequency, the extraordinary ray having the higher critical frequency when above f_B (Fig. 1.3). The magneto-electronic theory shows that the reflection levels of the two modes (o and x) depend on the ratio of the exploring frequency f to the gyrofrequency f_B . These are given below, where $X = fN^2/f^2$ and $Y = f_B/f$

If $f < f_B$ ordinary mode : $X = 1$ extraordinary mode : $X = 1 + Y$
 If $f > f_B$ ordinary mode : $X = 1$ extraordinary mode : $X = 1 - Y$

For any set of circumstances, there can only be two characteristic modes but, because of coupling, there may be more than two characteristic traces.

For ionogram reduction it is more convenient to denote the traces according to the conditions of reflection:

Reflection at $X = 1$	o -trace
at $X = 1 - Y$	x -trace
at $X = 1 + Y$	z -trace (or third magneto-electronic component)

Near the gyrofrequency the x -mode trace shows a special type of retardation (Fig. 1.4(a) and Fig. 1.5) which does not correspond to a critical frequency. As the x mode is more strongly absorbed than the o mode, very rarely, a trace showing retardation at frequencies near but below f_B is found. This is a z trace. f_B is seen only when absorption is small. The patterns which would be expected as the ordinary wave critical frequency changes from $f_o \gg f_B$ to $f_o \doteq f_B$ and $f_o < f_B$ are shown schematically in Fig. 14.

1.04. Relations between the basic magneto-electronic parameters

The three basic parameters that affect radio sounding in a magneto-electronic medium are the electron number density N , the total magnetic induction B and the angle between the magnetic field direction and the direction of propagation. N and B are directly related to the electron plasma frequency, fN , and the electron gyrofrequency, f_B , respectively.

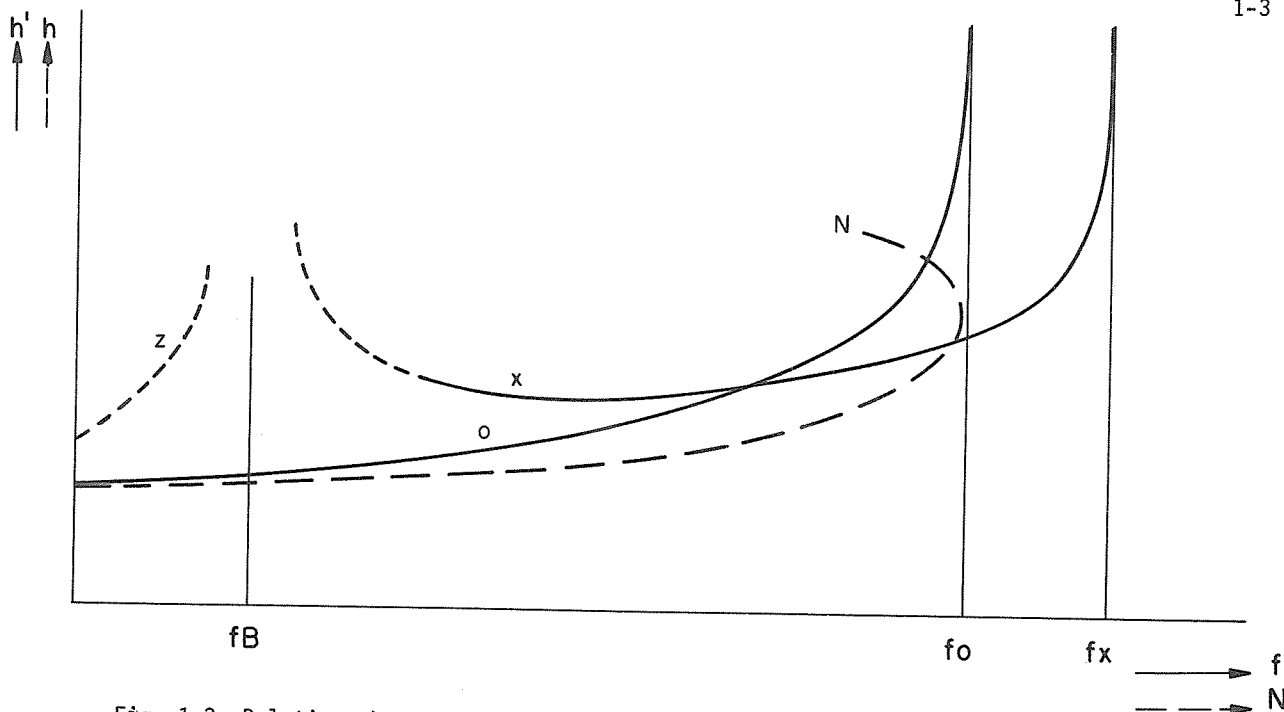

Fig. 1.3 Relations between virtual and true height with magnetic field.
 -- electron density distribution — h'f pattern.

$$N/m^{-3} = 1.24 \cdot 10^{10} (fN/MHz)^2 \tag{1.1}$$

or $fN/MHz = 8.98 \cdot 10^{-6} (N/m^{-3})^{1/2}$ (1.2)

and $B/Gs = 0.35723 fB/MHz$ (1.3)

or $fB/MHz = 2.7993 B/Gs = 2.8 B/Gs$. (1.4)

In these equations the unit of magnetic induction is the Gauss (Gs). The corresponding MKS unit is the Tesla (T). $1T = 10^4Gs$.

Note B and \$f_B\$ decrease with increase in height, \$h\$, above the surface. The gyrofrequency \$f_B\$ is the natural resonance frequency of the electrons about a magnetic field of strength B.

The value of \$f_B\$ can be calculated from the local ground value, \$f_{B0}\$, using the inverse cube variation with height

$$f_B = f_{B0} \left(\frac{r_0 + h}{r_0} \right)^{-3} \quad \doteq \quad f_{B0} \left(1 - \frac{3h}{r_0} \right)$$

where \$r_0\$ is the local radius of the earth.

If this is not available, use the dipole approximation (Section 14.32). By convention, \$h = 100\$ km is used for E layer, \$h = 300\$ km for F layer, \$h = 200\$ km when one value is used for both.

The relations between the critical frequencies \$f_o\$, \$f_x\$, \$f_z\$ of the ordinary, extraordinary and z-modes are:

$$f_x^2 - f_x f_B = f_o^2 \tag{1.5}$$

giving the well known rule

$$f_x - f_o \doteq f_B/2 \tag{1.6}$$

which holds provided \$f_o \gg f_B\$;

and $f_z^2 + f_z f_B = f_o^2$ (1.7)

or $f_x - f_z = f_B$ (1.8)

The expressions for $f_x - f_o$ and $f_o - f_z$ given by the magneto-electronic theory are

$$f_x - f_o = \frac{f_x f_B}{f_x + f_o}$$

$$f_o - f_z = \frac{f_z f_B}{f_z + f_o}$$

and which can differ significantly from the usual approximations

$$f_x - f_o = \frac{f_B}{2}, \quad f_o - f_z = \frac{f_B}{2}$$

when f_o is not large compared with f_B . For such cases $f_x - f_o$ is greater than $f_B/2$ and $f_o - f_z$ correspondingly smaller so that $f_x - f_z = f_B$. In practice, the separation $f_x - f_o$ does not increase as rapidly as would be expected from theory when f_o decreases below f_B . However, the full expression shown above should be used when scaling low critical frequencies. It is convenient to make a table or graph of values of f_o corresponding to given values of f_x, f_z , using the local value of f_B .

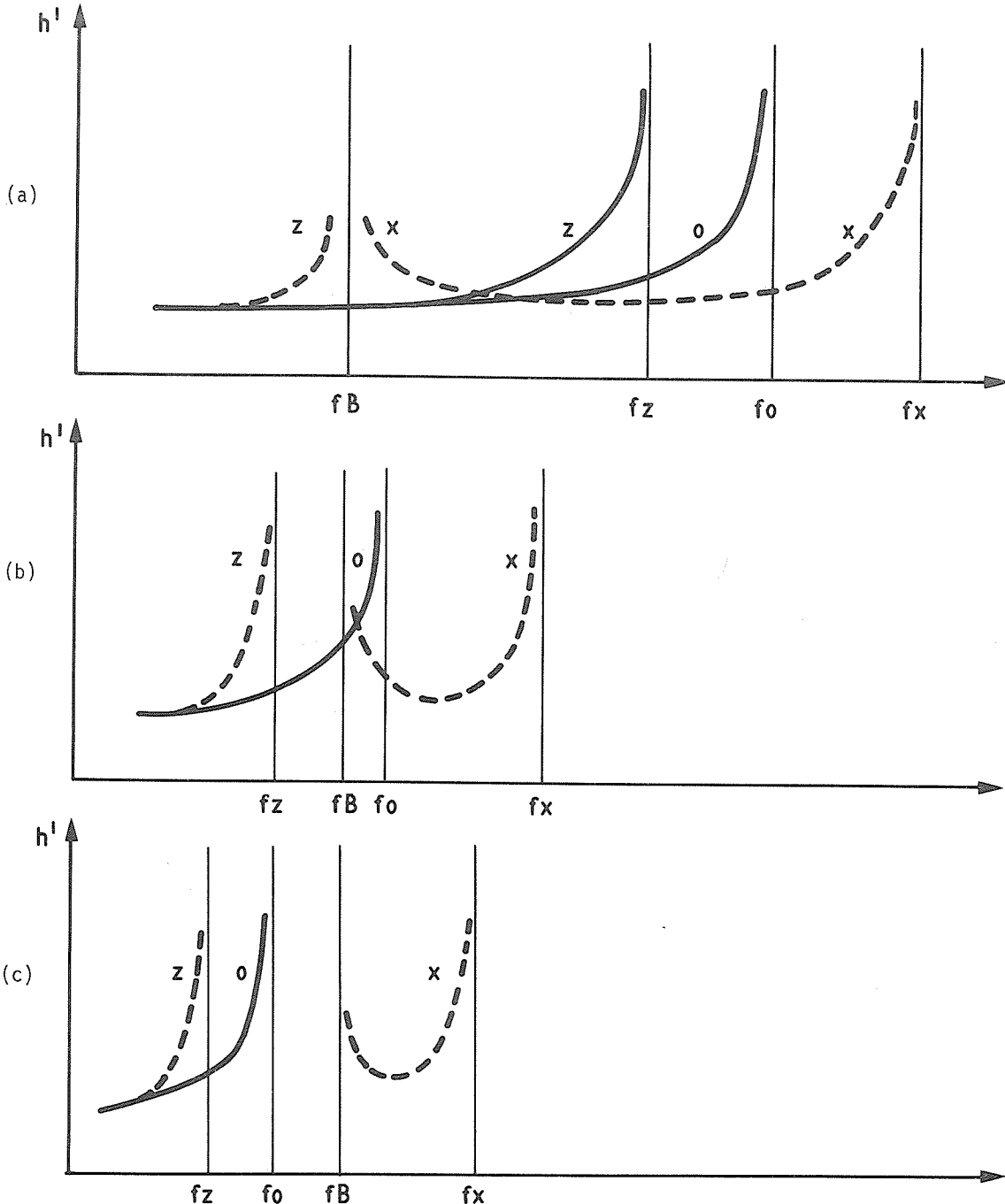

Fig. 1.4 Pattern of o- x- and z-mode traces as f_o changes
 (a) $f_o \gg f_B$. (b) $f_o \approx f_B$. (c) $f_o < f_B$.

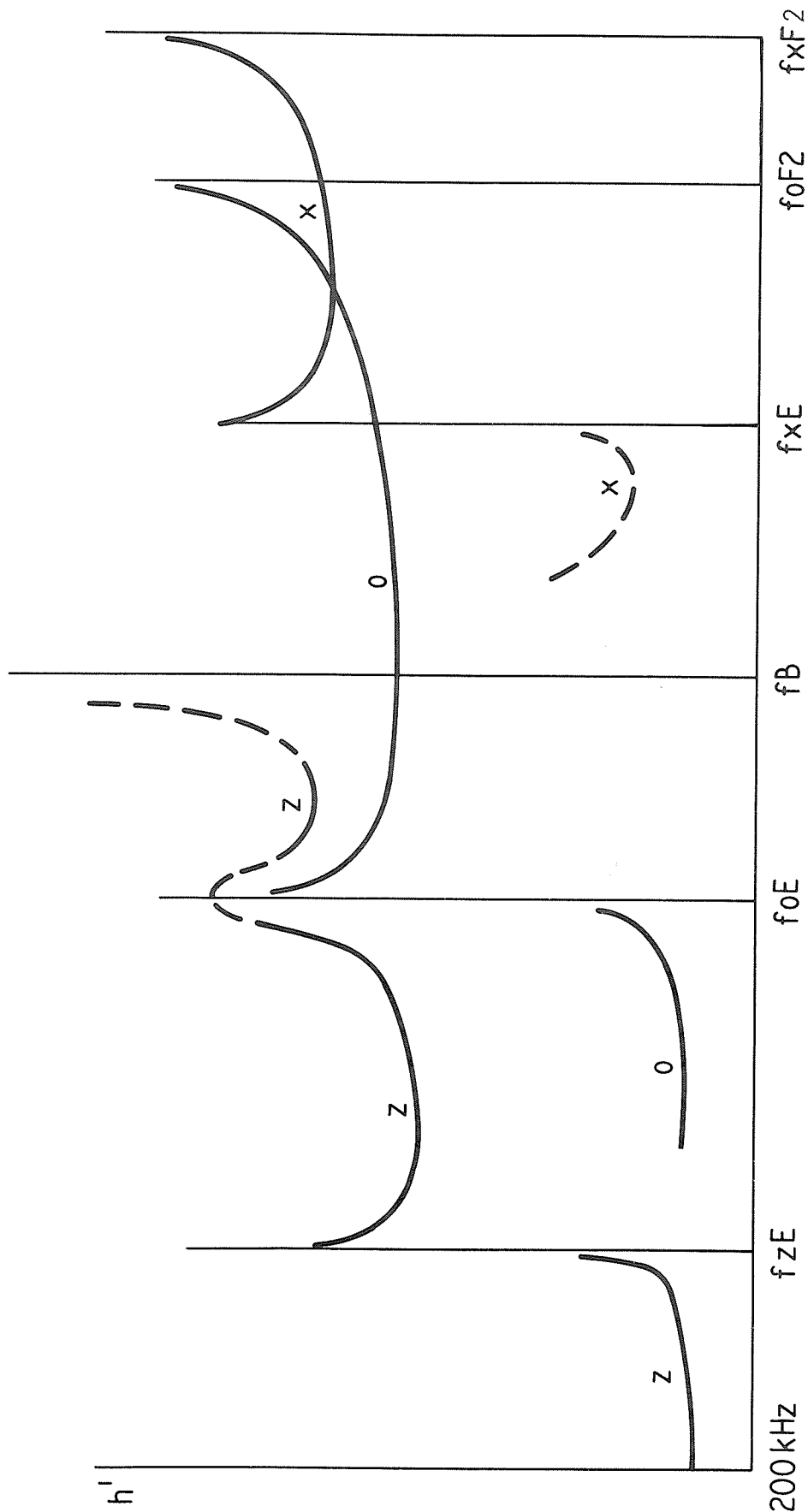

Fig. 1.5 Low frequency ionogram at night, normal E and F traces. No Es. Parts which are usually not seen shown dashed.

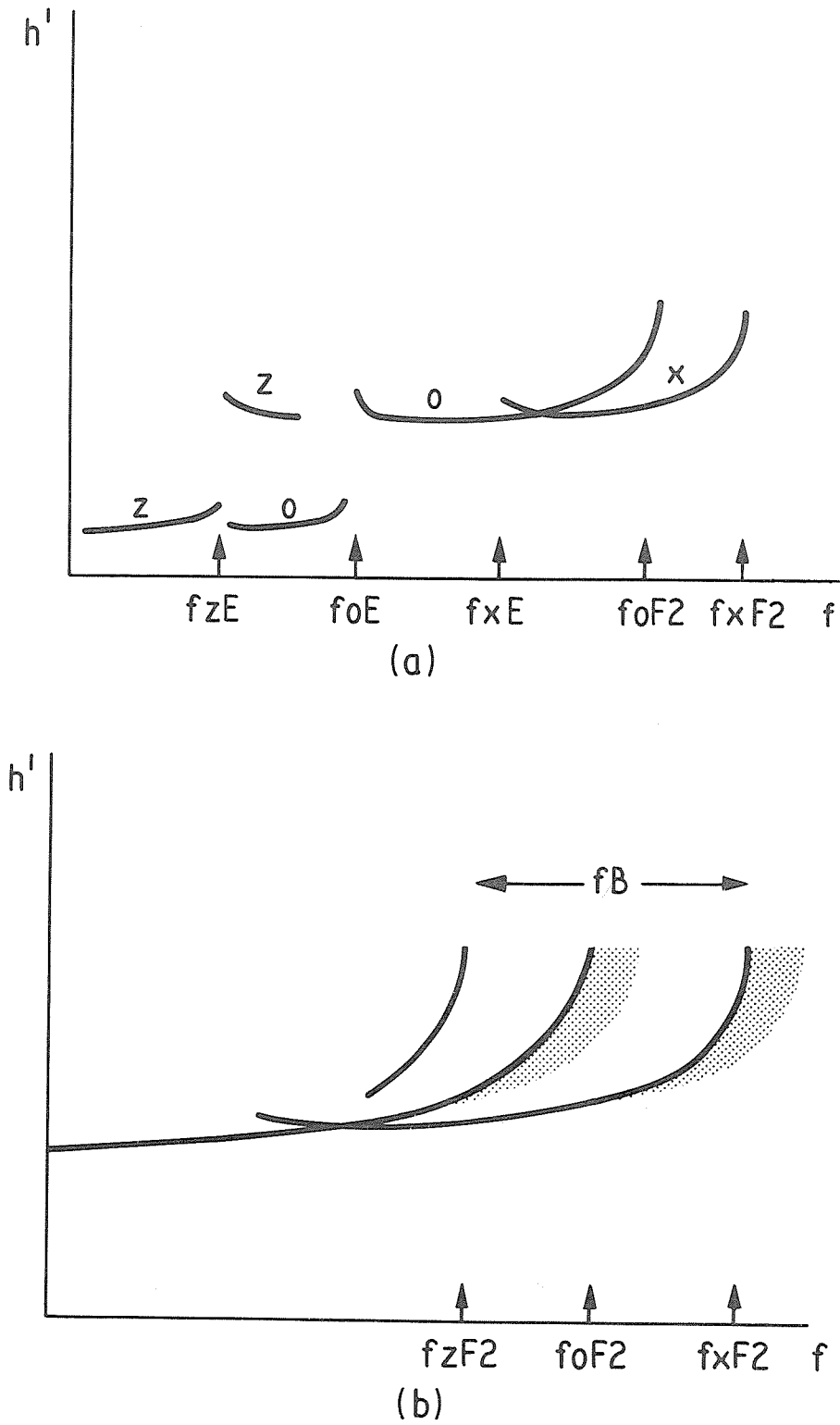

Fig. 1.6 z mode
 (a) due to coupling
 (b) due to scattering
 (Note z trace is not scattered in (b)).

1.05. The z mode: The z-mode traces are generated by waves which have been propagated along the magnetic field until they reach the z-mode reflection level, $fz^2 + fz fB = fo^2$. This can occur through coupling at levels where the collision frequency is high or by scattering by irregularities or by reflection in layers tilted so as to be perpendicular to the lines of magnetic field. The two types of ionogram are very dissimilar (Fig. 1.6). Coupling is important below the gyrofrequency and affects higher frequencies and higher levels as the dip approaches the vertical. Thus the z traces due to this cause are most complete on the lowest frequencies and are most frequently observed at high magnetic latitudes [A33I, Figs. 23, 24; A34F, Fig. 25], [IIB-3 June, IIB-15 Sept., IIB-17 Sept., III-30 1a]. The z mode is often observed on low frequency ionograms at night for frequencies below the gyrofrequency (Fig. 2.5) and the trace can be readily identified by the frequency separation from the o-and x-mode traces, by its smaller absorption which gives a stronger trace and by its retardation at both fzE and foE [B III 30 1a].

z-mode echoes are relatively common at observatories where the magnetic dip is greater than 65° . The difficulty of distinguishing a z-o mode pair from an o-x mode pair can be minimized using the following criteria:

- (a) Interpolation from the sequence of ionograms between times when the components can be identified positively.
- (b) The F layer z traces are better defined and show less spread than the corresponding o traces and are often weaker.
- (c) The x trace is usually missing or, at best, is significantly weakened for about 0.5MHz above the gyrofrequency and not received below the gyrofrequency. Thus, x-mode critical frequencies are seldom observed below $fB + 0.5\text{MHz}$.
- (d) When two critical frequencies occur below the gyrofrequency they must be a z-o pair.

At high magnetic latitudes or when the critical frequency is near fB , the z and o modes are relatively stronger than the x mode and care is needed to avoid confusing z and o traces with o and x traces. The x mode may be missing whenever the absorption is significant.

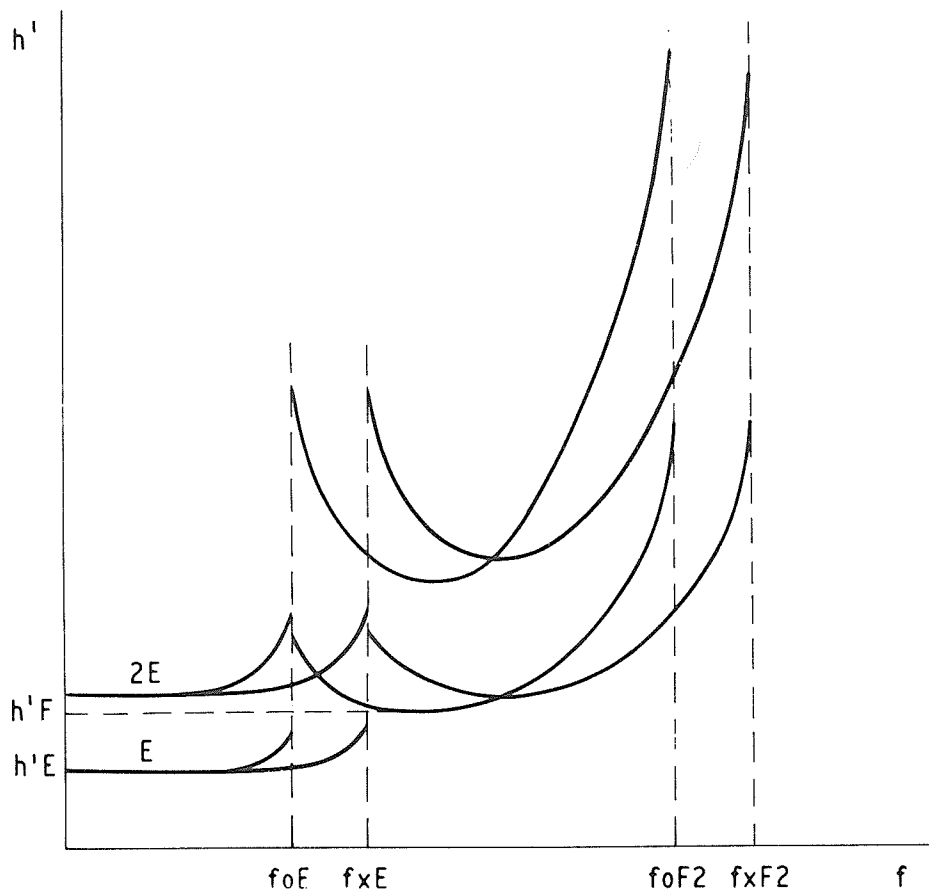

Fig. 1.7 Idealized ionogram when two layers are present.

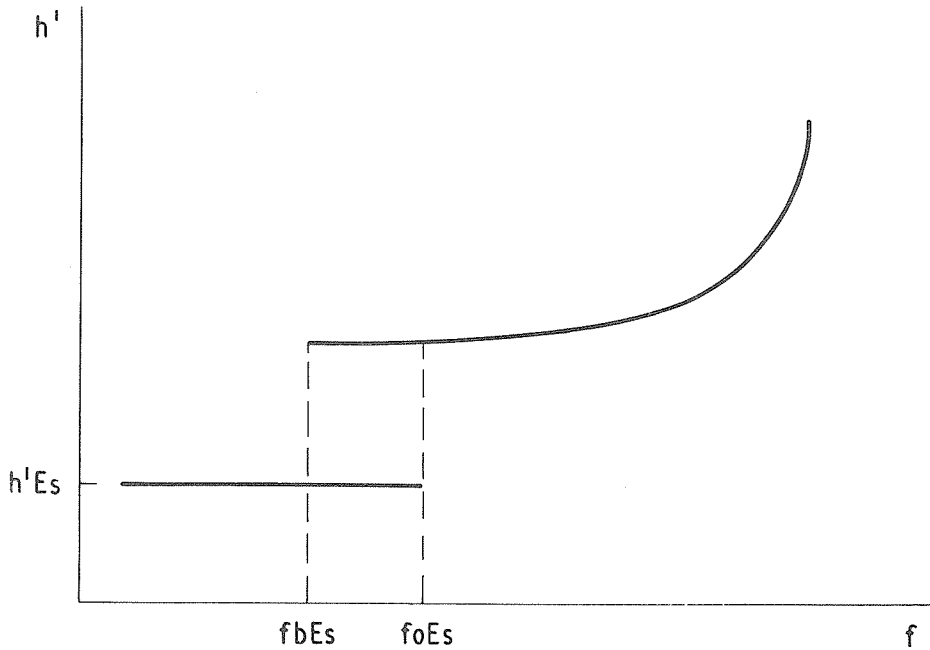

Fig. 1.8 Idealized ordinary ray pattern when a thin layer is present. Note that the quantity corresponding to the critical frequency of a thick layer always lies between $foEs$ and $fbEs$. (Section 1.07(c))

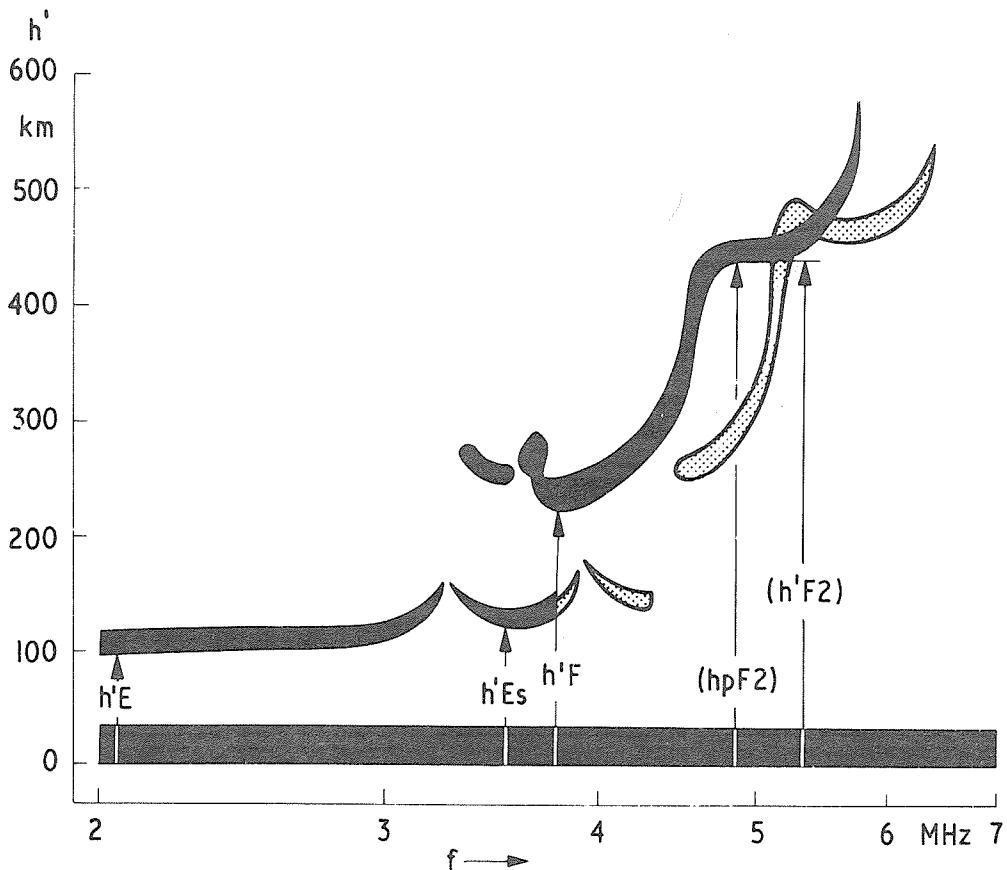

Fig. 1.9(a) Typical day time ionogram with minimum virtual heights $h'E$, $h'Es$, $h'F$, $h'F2$, and the "parabolic height" $hpF2$. These are all read from the o trace (black).

1.06. Most ionograms contain an immense amount of information about the conditions in the ionosphere, but this is in a form which is prohibitively inefficient for many important investigations. It is, therefore, necessary to select certain features of the ionogram which are particularly significant for scientific or operational studies and to develop techniques for evaluating their characteristics. This process is called 'scaling the ionogram'. Clearly there are two main steps in the scaling process: the selection of significant parameters and the formation of rules for recognizing and measuring the significant parameters.

Usually it is sufficient to assume that the ionosphere is concentric with the earth and simple scaling is based on this assumption. The ionograms can often show when this assumption is not true and advanced scaling enables significant parameters to be deduced in these cases. This is more fully explained in sections 2.70 - 2.73.

Ionograms frequently show multiple and mixed reflections.

A multiple reflection is the name given to a trace which has been reflected from the ionosphere more than once. An echo which results from two reflections from the same layer, with an intermediate reflection from the ground, is called a second order; three reflections give a third order, and so on. Orders as high as fifteen or more occasionally occur when absorption is extremely low. These very high orders are still being reflected between the ground and the ionosphere after a time greater than that of the time base period and consequently appear on the ionogram. Fig. 1.9(b) shows a typical example of these 'round-the-time-base' traces, orders 8 to 11 are visible.

It is possible for mixed reflections between the E and F layers to occur when sporadic E is present. The most common of these is a second order reflection from the top of a sporadic E layer - the M reflection at a height $(2h'F - h'Es)$. The mixed mode F reflection followed by Es reflection, or vice versa, are also common at a height $(h'F + h'Es)$. Both are shown in Fig. 1.9(c). The M reflection often gives a stronger trace than the 2F normal mode when absorption is present, as it has only passed through the absorbing D region twice instead of four times. Higher multiples also occur and can be easily identified by noting that the M and N traces are a constant distance $(h'Es)$ from the 2F and 1F traces, respectively. Higher modes $2F + E$, $3F - E$, etc., are identified similarly. A typical ionogram showing E, F and mixed mode multiple reflection is shown in Fig. 1.9(d) together with the mode identifications.

Under normal circumstances, M and N reflections are not scaled but can be used occasionally to give a numerical value of foF2 when the layer is tilted so that the normal F traces are missing.

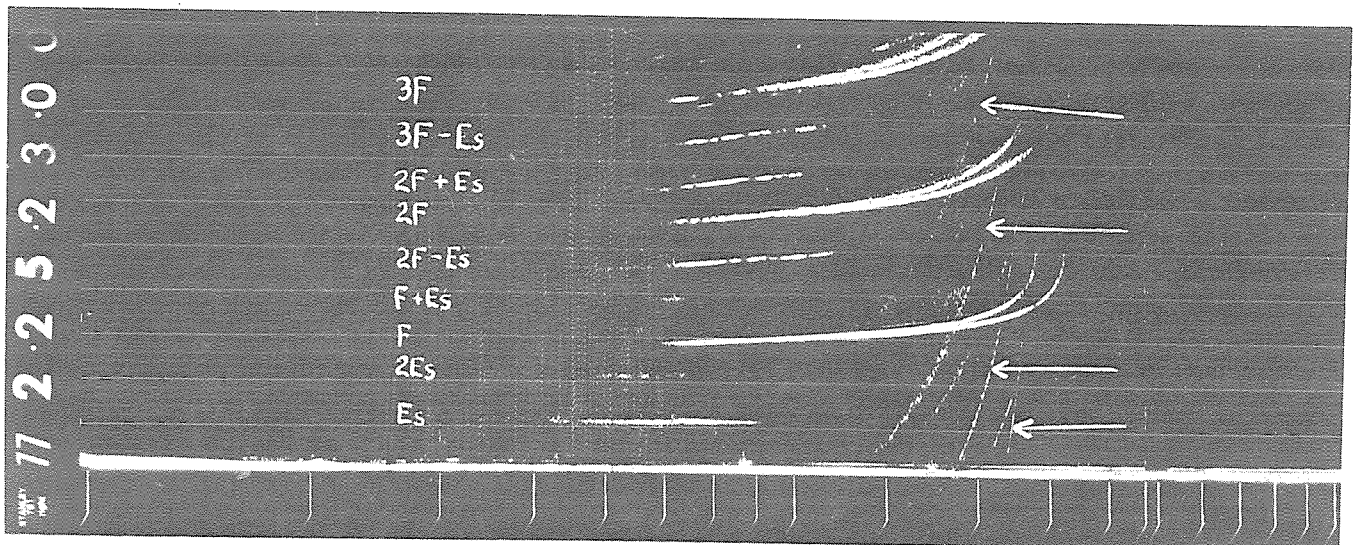

Fig. 1.9(b) Ionogram showing very high order F region reflections, also multiple reflections. Arrows indicate 'round-the-time-base' traces.

1.07. The selection of particular parameters as significant is determined by their value for further study. The main parameters are based on the features of the relatively simple ionograms often obtained at temperate latitudes. This has produced a number of simple, pictorial concepts - the critical frequency, the minimum virtual height, the top frequency of an Es trace* shown in idealized form in Figs. 1.7, 1.8 and on an ionogram in Fig. 1.9(a).

The following definitions, selection rules and measurement conventions can be applied to any magneto-electronic component:

(a) Top frequency of a layer: The highest frequency at which an echo trace is obtained from the layer at vertical incidence (weak discontinuous traces are ignored).

(b) Blanketing frequency of a layer: The lowest frequency at which the layer begins to become transparent. This is usually identified by the appearance of echoes from a layer at greater height.

(c) Critical frequency of a layer: The highest frequency at which the layer reflects and transmits equally. The definition shows that the critical frequency of a layer always lies between its top frequency and its blanketing frequency.

In the most common case of a horizontal thick layer, all three characteristic frequencies are identical, and are made clearly visible by the retardation at the critical frequency. In the case of a thin layer, the top and blanketing frequencies can be different. The critical frequency can, in principle, be determined from the amplitudes of the different echoes. As this is impracticable at most stations, both the top and blanketing frequency should be scaled for a thin layer. This concept determines the rules for scaling Es traces.

(d) Minimum virtual height is the height at which the trace is horizontal. For a thick layer this can only occur if there is a lower thick layer causing group retardation which balances the change of virtual height with frequency due to the reflecting layer. In all these cases the observed minimum virtual height is above the true height. By convention, if the change of virtual height with frequency is not detectable at the lowest frequencies reflected by the layer the observed value is considered to be exact (Figs. 1.4, 1.6, 1.7).

(e) Maximum Usable Frequency (MUF): This is a propagation concept which is defined as the highest frequency for ionospheric transmission over an oblique path, for a given system performance. To prevent confusion, the following definitions have been adopted by CCIR**.

- (i) Operational MUF is the highest frequency that permits acceptable operation between given points at a given time, and under specified working conditions.
- (ii) Classical MUF is the highest frequency that can be propagated by a particular mode between specified terminals by ionospheric refraction alone; it can be experimentally determined as the frequency at which the high- and low-angle rays merge into a single ray.
- (iii) Standard MUF is an approximation to the classical MUF, that is obtained by application of the conventional transmission curve (section 1.5) to vertical-incidence ionograms, together with the use of a distance factor.

Note: Note that the classical MUF and standard MUF are to be applied only to propagation involving the regular layers.

The Operational MUF may exceed the Classical MUF when ionospheric or ground scatter is present. The Operational MUF may, therefore, vary with transmitted power and receiver sensitivity whereas the Classical and Standard MUF are determined by the geometry of the mode of propagation. All MUF values refer to a given distance and this should always be stated. These definitions apply to the individual measurements of MUF. Where median or mean MUF is intended the qualifying words 'median' or 'mean' must be included.

* These have been generalized by Rawer *et al.*, *J. Atmo. Terr. Phys.*, 1955, 6, 69-87

** New Delhi, 1970 C.C.I.R., Rec 373-2, Vol. II part 2, p. 45-46, published by I.T.U. Geneva, 1971.

Paths of M and N reflections

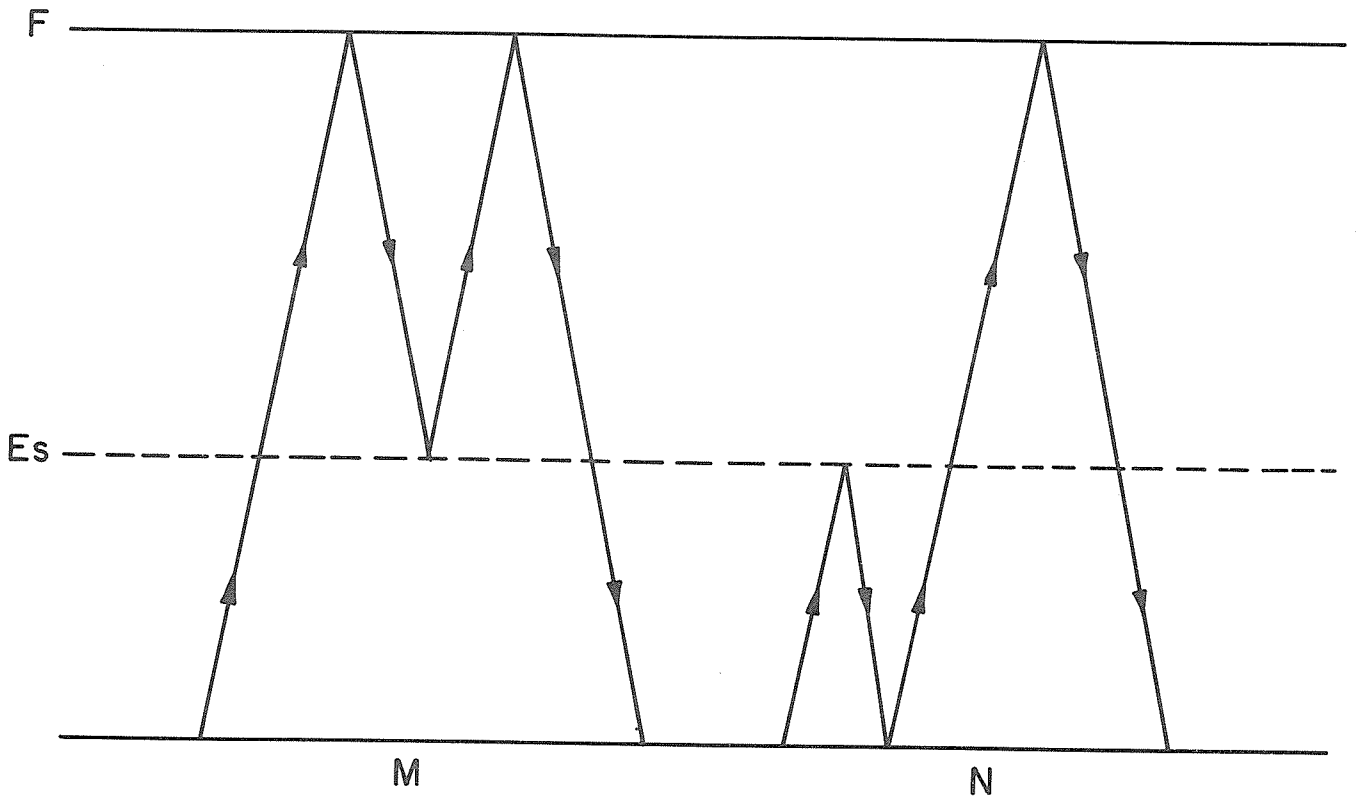

Fig. 1.9(c) Virtual height of M reflection $2F - E_s$, N reflection $F + E_s$.

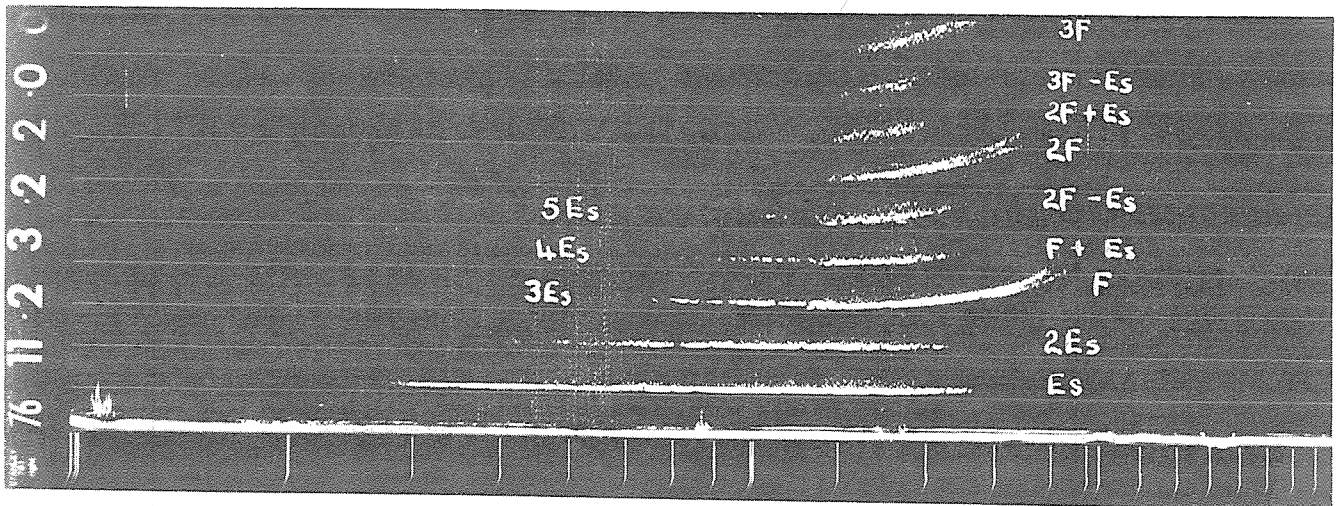

Fig. 1.9(d) Ionogram showing multiple reflections. Note $3E_s$ is superposed on $1F$ as is $4E_s$ on $(F + E_s)$.

1.08. Standard MUF(3000) as a vertical incidence parameter.

In principle, it should be possible to calculate the Standard MUF corresponding to a given ionospheric trace but the numerical value depends slightly on the exact method of calculation used. In 1953 the WWSO adopted the standard transmission curve due to N. Smith, noting that the other current methods gave essentially the same results. The procedure described in section 1.5, is really a graphical analysis to find the apparent height of the maximum electron density of the layer. This exceeds the real height by an amount dependent on the retardation at lower heights. The maximum usable frequency determined in this way depends on the shape of the electron density profile and is mainly determined by the real height of maximum electron density and the critical frequency of the layer. The standard distance, 3000 km, is fixed by convention. It should be noted that the MUF factor can have geophysical as well as practical applications through its close association with the height of maximum density.

While in the past the main importance of the MUF factor has been for propagation applications, its ease of measurement and close connection at any station with the height of maximum ionization of the reflecting layer makes it an important parameter for studying geophysical phenomena. Care must be taken when there is much retardation in the lower parts of the ionosphere since then the apparent height of maximum deduced from the factor can be much higher than the real height. The following semi-empirical relations have been established between the standard MUF factor, $M(3000)F_2$, and the apparent maximum height of the F2 layer, e.g. as deduced by the parameter $h_p F_2$ (section 1.41).

$$\text{CCIR}^* \quad h_p F_2 = -176 + 1490/M(3000)F_2 \quad (1.9)$$

$$40^\circ\text{N}-40^\circ\text{S}^{**} \quad h_p F_2 = -225 + 1650/M(3000)F_2 \quad (1.10)$$

The CCIR relation is widely used. Unfortunately it often gives too high a value for the height of maximum of the F2 layer particularly in summer periods. This is mainly due to the effects of retardation below the F2 layer. The formula should not be used at high latitudes.

The relation between $h_p F_2$, deduced from $M(3000)F_2$ equation (1.9), and some measured values of h_M , deduced by a full electron density analysis, is shown in Fig. 1.10. Measured values of $M(3000)F_2$ and h_M are plotted as points.***

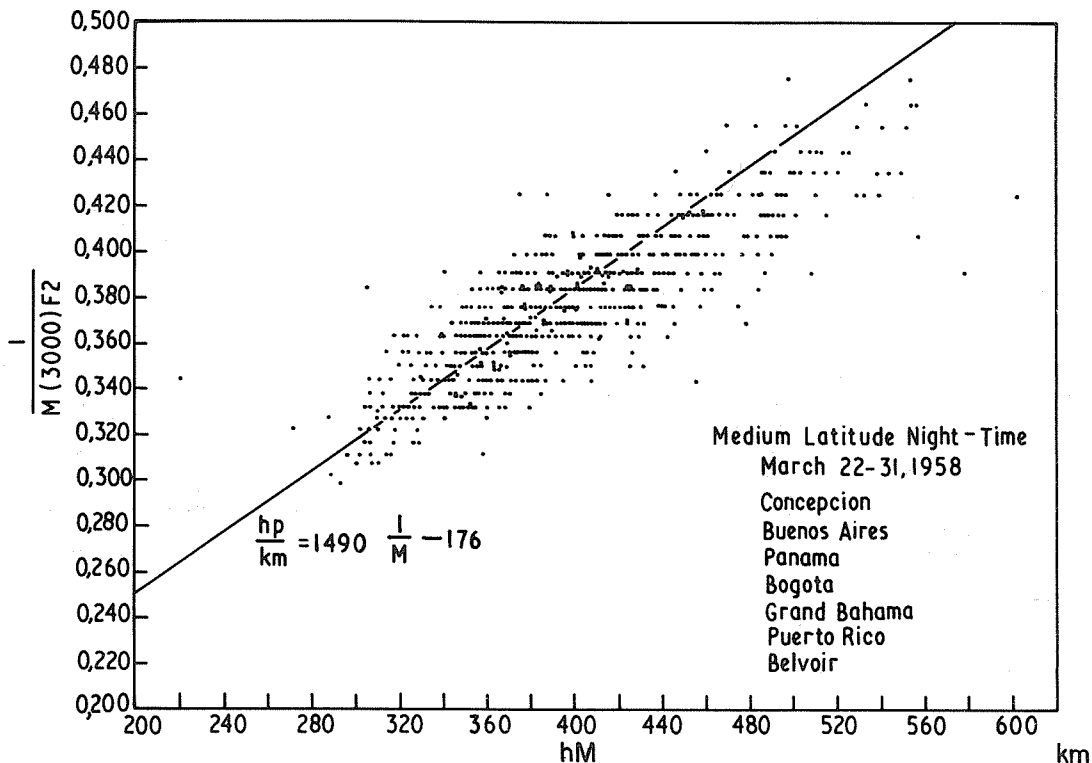

Fig. 1.10 Correlation between $1/M(3000)F_2$ and $h_M(\text{km})$ for night hours, medium latitude.

* Shimazaki, T., *J. Radio Res. Lab., Japan* 2, 85-97, 1955

** Lyon, A. J. and Thomas, L., *J. Atmos. Terr. Phys.*, 25, 373-386, 1963

*** Wright, J. W. and McDuffie, R. E., *J. Radio Res. Lab., Japan* 7, 409-420, 1960

1.09. For the purposes of evaluating oblique incidence ionograms, URSI recommends the term Junction Frequency (JF) for the Classical MUF, and the term Estimated Junction Frequency (EJF) for the Standard MUF which is, however, widened to include other methods of estimation. These distinctions are not important in vertical incidence analysis where all measurements refer to the Standard MUF as defined by CCIR.

Maximum Observed Frequency (MOF), is the highest frequency that can be detected on an oblique-incidence ionogram.

1.1 Conventions for Identifying Critical and Characteristic Frequencies

1.10. The main reflecting layers vary in height with time, and near sunrise and sunset, when the solar zenith angle is near 90°, traces due to normal E can be found at remarkably large heights. Apart from these times a useful general guide is that F-layer traces are mainly found above 200 km, or are continuous with traces above this height, whereas E-layer traces are found below 150 km, usually nearer 100 to 130 km.

With the exception of f_{X1} (section 1.22), international frequency parameters are defined by the ordinary wave component (Fig. 1.11). For each characteristic, there is a corresponding extraordinary wave frequency defined in the same way but with ordinary wave replaced by extraordinary wave in the definition.

1.11. f_oF2 : The ordinary wave critical frequency of the highest stratification in the F region is to be called the F2 critical frequency, f_oF2 . This convention applies when ambiguities are caused by the presence of F1.5 or other stratifications but not in the case where f_oF2 is known to be below f_oF1 . Particular care is necessary at high-latitude stations where f_oF2 can be less than f_oF1 for long periods.

1.12. $f_oF1.5$: The ordinary wave critical frequency of the intermediate stratification between F1 and F2 that is often observed at certain middle and low latitude stations (used for local or regional studies).

1.13. f_oF1 : The ordinary wave F1 critical frequency at low and high latitudes is to be identified by the conditions of continuity with F1 at temperate latitudes. At temperate latitudes this is usually mostly present in summer months, though the incidence varies with solar cycle. At low latitudes the general structure of the F layer is more complicated and it is often impossible to identify any regular layer continuous with the temperate latitude F1 layer. In this case no attempt to tabulate f_oF1 should be made. The ratio f_oF1/f_oE for a given station is usually remarkably constant, though it varies slightly with position. This can be used as a guide when the interpretation is doubtful.

1.14. f_oE : The ordinary wave critical frequency corresponding to the lowest thick layer stratification in the E region which causes a discontinuity in the height of the E trace. In the absence of blanketing low-type Es, the trace giving f_oE must be continuous in height with the whole E trace, otherwise it is E2. When the identification of the appropriate discontinuity is doubtful the critical frequency which is most nearly continuous with that found from the sequence of ionograms or at the corresponding time on other days, is adopted as the normal E-layer critical frequency. Particular care is necessary when an E2 trace may be present and the E trace is not visible because of blanketing (A)*, absorption (B), or because the true value of f_oE is below the lower limit of the ionosonde (E). In the presence of blanketing Es of the cusp type (section 4.83) the E trace may need to be extrapolated (section 4.24) in order to obtain the critical frequency. By convention entries of f_oE are omitted at hours when normal E is not normally observed, which is usually because f_oE is below the minimum frequency of the ionosonde.

1.15 Particle E: The ionogram shows the presence of a thick layer in the E region with a critical frequency significantly greater than that of normal E (1.14). In most cases particle E can be attributed to direct or indirect ionization by particle activity. Particle E always causes group retardation in any traces from higher layers, and this retardation near f_oE is sufficient to identify the critical frequency. Traditionally this trace was called night E as the critical frequency of the normal E was below the lowest recordable frequency at night. Fortunately, in almost all practical cases, the difference between the critical frequency of the particle E and of normal E is large -- much larger than the differences between f_oE and f_oE2 (1.16). Thus at night when f_oE for normal E is between 300 kHz and 500 kHz particle E usually gives f_oE above 1MHz -- often up to about 5 MHz. Particle E is often preceded or followed by retardation type Es (Es-r) or auroral type Es (Es-a); in such cases f_oE usually varies rapidly with time. When particle E is present, as indicated by retardation of the traces from higher layers or by the character of the E trace (see section 3.2 letter K and section 4.24) it is identified in the tabulations by descriptive letter K (f_oE , f_oEs , f_bEs , $h'E$, $h'Es$ and Es type tables). Note retardation of a higher trace is enough to identify particle E (f_oE)-K if it obeys the definition given above. Particle E normally blankets normal E but is sometimes seen at greater heights up to about 170 km.

* For explanation of letter symbols see Chapter 3.

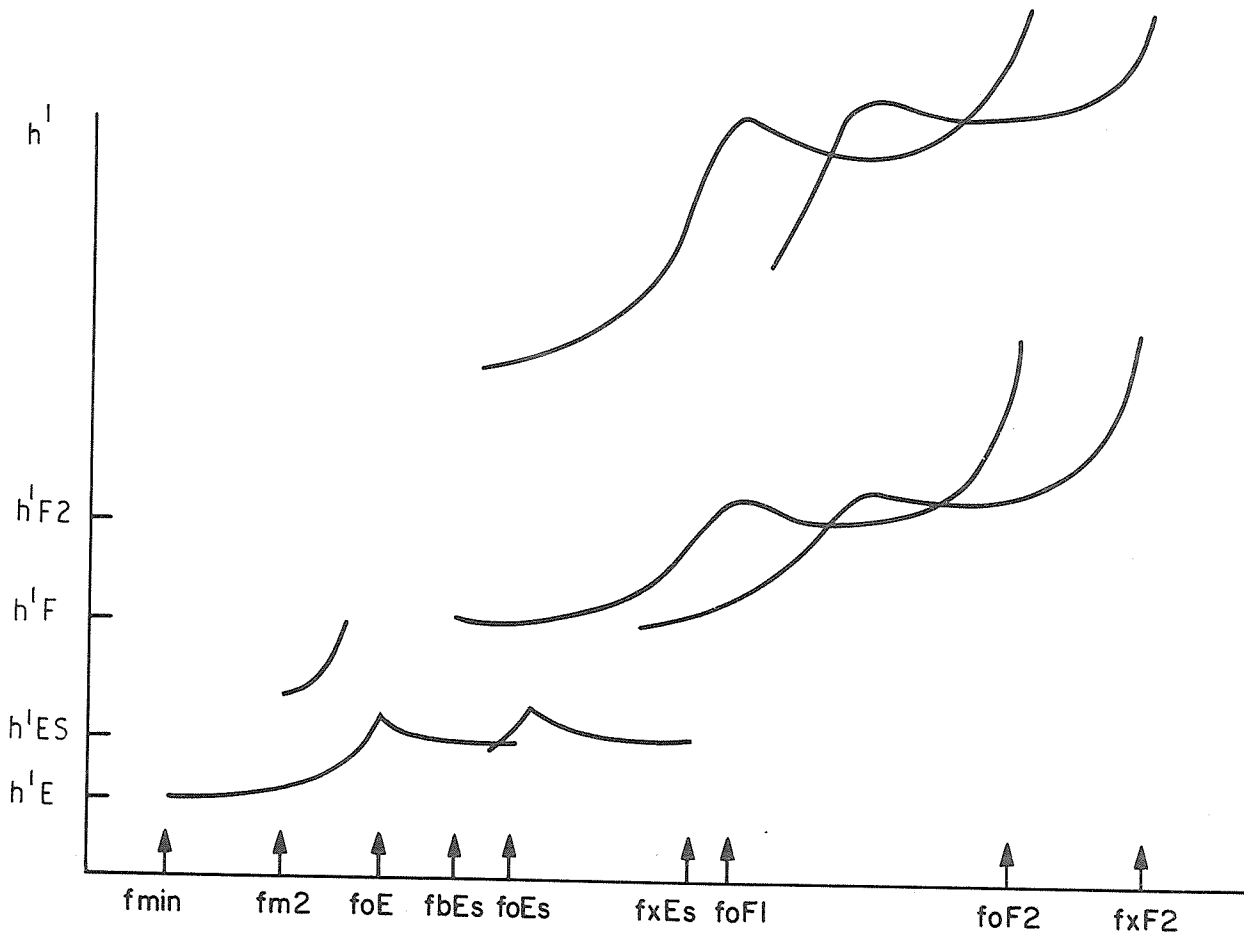

Fig. 1.11 Standard height and frequency parameters.

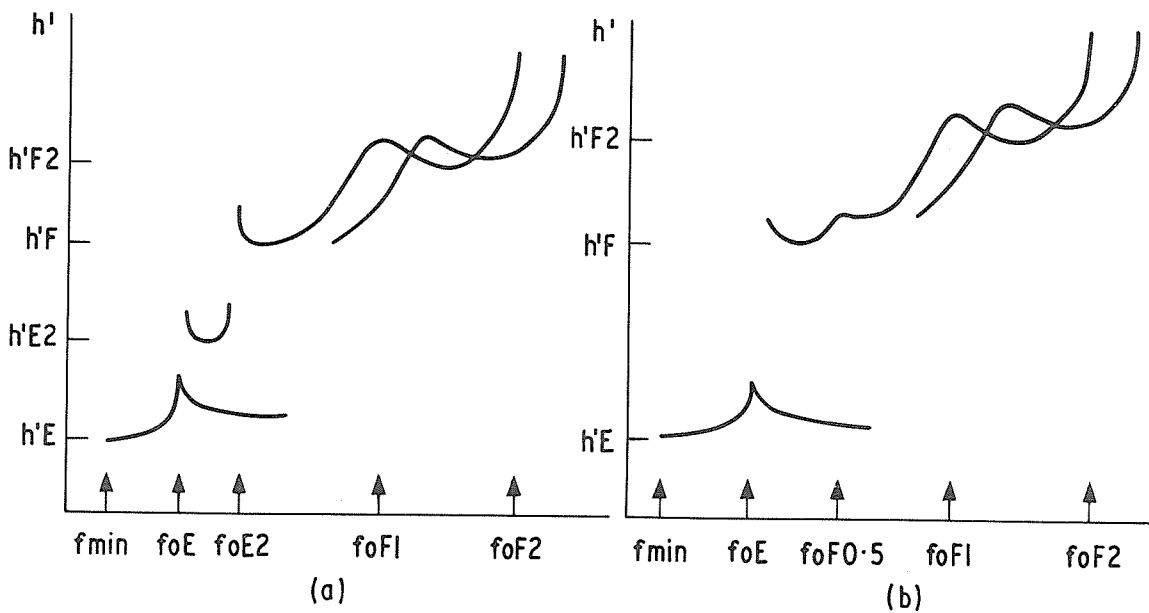

Fig. 1.12 Distinction between E2 and F0.5. In (b) $h'F$ should be written $(h'F)UH$

1.16. foE2: The critical frequency of an occulting thick layer which sometimes appears between the normal E and F1 layers. When the critical frequency shows a discontinuity (e.g. a true cusp) with the F trace it is tabulated as foE2; when the trace shows a maximum but no cusp tabulate as foF0.5 (Fig. 1.12). Since this is always transitory, the value of h'F (section 1.32) is not representative and is made doubtful. The characteristics foF0.5, foE2 are only reduced for local or regional studies and more restrictive conventions are allowable, if desired, for these purposes.

1.17. foEs: The ordinary wave top frequency corresponding to the highest frequency at which a mainly continuous Es trace is observed. It follows from the definition that foEs to some extent depends on the characteristics of the ionosonde (see detailed instructions in Chapter 4).

1.18. fbEs: The blanketing frequency of an Es layer, i.e. the lowest ordinary wave frequency at which the Es layer begins to become transparent. This is usually determined from the minimum frequency at which ordinary wave reflections of the first order are observed from a layer at greater heights (see detailed instructions in Chapter 4).

1.19. fmin: The lowest frequency at which echo traces are observed on the ionogram. Logically fmin should always refer to the o-mode trace. In practice, however, the distinction between o-mode and z-mode is often difficult to make accurately. The gain in information is small since fmin for the o-mode is not usually determined by absorption in these cases. Cases where there is evidence that fmin is given by a z-mode trace should be described by letter Z.* The convention is that oblique or multiple order traces are ignored and also any very weak reflections from the D region (see detailed instructions in Chapter 2).

1.2 New Parameters

1.20. The URSI/STP Committee at Ottawa September 1969 approved and recommended the use of certain new ionogram parameters not used in previous years. The definitions are given here and the detailed rules for evaluating and tabulating them are collected in Chapter 3. For completeness the definitions of certain parameters used mainly for local or regional studies are also included in this section.

1.21. Spread F index, fxI: The URSI/STP Committee**, noting that a measure of the top frequency of spread F is urgently required for CCIR purposes and also has scientific interest, and that a proposal to introduce such an index has been widely supported by those responsible for stations, recommends that a new ionospheric parameter denoted fxI (with computer symbol 51) be adopted for international analysis, tabulation and normal circulation through WDCs and other publication methods, defined and applied according to the instructions following. It is recommended that all stations at high latitudes or subject to equatorial spread F tabulate and circulate this parameter, and that stations at other latitudes be invited to volunteer to analyze the parameter as a trial. Tests are particularly important at stations where the spread of frequencies of spread F often exceeds fb/2 at certain hours. It is very important to measure fxI at stations where spread F causes the foF2 count to be small at certain hours. Spread F rules are given in Section 2-8.

The parameter fxI is defined as the highest frequency on which reflections from the F region are recorded independent of whether they are reflected overhead or at oblique incidence. Thus, fxI is the top frequency of spread F traces including polar or equatorial spurs, but not including ground back scatter traces. Since this parameter can be gain sensitive it should always be measured using the normal gain ionogram. Special care is needed when foI (foI = fxI - fb/2) is near or below fb since absorption can then hide fxI. Detailed rules are given in section 3.3.

1.22. Frequency spread dfS: For scientific work, the frequency spread of the scatter pattern has been measured at a number of stations and is recognized as an international parameter for interchange on a voluntary basis. The symbol dfS is adopted for this. There are as yet no recognized international conventions for this parameter (see section 7.34) which seems to have fallen out of use and may be ignored.

The parameter dfS is provisionally defined as the total width in frequency of frequency spread traces for the F layer. The lower boundary is defined by the z or o mode, the upper by the x mode. Since dfS is particularly useful for regional studies agreement should be sought with collaborating institutes. If and when international conventions are agreed, these will be published in the URSI and INAG Information Bulletins.

1.23. fmI: The lowest frequency at which frequency spread traces are observed for the F layer. This is often equal to foF2.

1.24. Monitoring of absorption by ionosondes: The variation of absorption with position and time appears to be more complicated than can be adequately monitored by existing absorption stations. The URSI/STP has therefore adopted a new additional parameter, fm2.

* For explanation of letter symbols see Chapter 3.

** URSI Bulletin No. 169 December 1968 p. 56.

Definition: f_m2 is defined as the minimum frequency of the second order trace. Since the absorption loss in dB is twice as great for the second order trace as for the first, f_m2 is more sensitive to absorption changes and less to equipment design than is f_{min} . It can only be used when two traces are usually available and is not valuable when $f_m2 = f_oE$.

The following actions will give an improved measure of absorption for synoptic purposes and should be adopted, as appropriate:

- (a) At stations where f_{min} is mainly determined by absorption, at least when it is appreciable, the operation of the ionosonde should be such as to make the f_{min} values consistent. In particular in any month, diurnal gain changes should be made at fixed times of day only and the gain at fixed time be kept as constant as possible. Where possible the times and gain changes in dB should be recorded and circulated with the f_{min} data.

At stations where the f_{min} for the second order trace, f_m2 , is mainly determined by absorption, measurements of f_m2 will usually show absorption changes more accurately than f_{min} and be less sensitive to interference and equipment characteristics.

- (b) With some high sensitivity types of ionosonde f_{min} seldom shows changes of absorption except during very large events. For such equipments, f_m2 should be reduced and circulated instead of or in addition to f_{min} . Note when f_{min} is not tabulated, the appropriate value of f_{min} should always be shown in tables of other parameters when the parameter is below f_{min} , i.e., . . . EB; . . . ES cases. (Chapter 3). The substitution of f_m2 for f_{min} at stations in group (a) is preferred when local experience shows that this gives a better description of absorption changes.

1.25. f_m3 : The parameter f_m3 is defined as the lowest frequency for the third order reflection (used only for local or regional studies). The measurement of absorption is more fully described in Chapter 12.

1.26. f_oI : f_oI is the o-mode characteristic corresponding to the x-mode characteristic, f_xI , (not in use at present except in explanations).

1.3 Conventions for Identifying and Scaling Virtual Heights

1.30. The minimum virtual height of reflection can only be determined at a point where the trace is essentially horizontal. In general, minimum virtual heights should only be scaled when this condition is met within the accuracy rules, section 2.2. See use of E (Chapter 3).

1.31. In certain cases useful information can be obtained even when the trace is not horizontal. These occur when the trace is blanketed by a lower layer or is still falling at the lowest frequency of the ionogram. In these cases the minimum height observed should be qualified by E and interpreted 'minimum virtual height less than ...'.

Note that when the trace shows an inflection point with a horizontal tangent $h'F2$ can be determined; if it shows an inflection point without a horizontal tangent, no measurement is possible and the symbol L alone is used. Transient stratifications are to be disregarded in routine scaling, except that their presence is indicated by the descriptive letters H or V.

1.32. $h'F$: The minimum virtual height of the ordinary wave F trace taken as a whole.

1.33. $h'F2$: The minimum virtual height of the ordinary wave trace for the highest stable stratification in the F region.

1.34. $h'E$: The minimum virtual height of the normal E layer taken as a whole.

1.35. $h'Es$: The minimum height of the trace used to give the f_oEs data.

1.36. $h'E2$: The minimum virtual height of the ordinary wave E2-layer trace (used for local or regional studies only).

1.37. $h'I$: The minimum virtual slant range of the traces which determine f_xI (in use on a voluntary basis).

1.38. $h'F1.5$: The minimum virtual height of the ordinary wave trace between f_oF1 and $f_oF1.5$ (used for local or regional studies only).

1.39. $h'Ox$: The virtual height of the x trace at f_oF2 (used for local or regional studies only).

1.4 Conventions for Determining Other Height Parameters

1.40. Certain indirect measures of the height of the maximum density of the F layer are in use and their definitions are given below. Note that these are not exact, the value obtained depends on the technique used and the parameter should only be tabulated using the international symbol if the international rules have been adopted.

1.41. h_pF_2 : The virtual height of the ordinary wave mode at the frequency given by $0.834 f_oF_2$. For a single parabolic layer with no underlying ionization this is equal to the actual height of the maximum of the layer. In practice this is usually higher than the true height of maximum. At stations at low dip latitudes, or when f_oF_2 is less than about $1.3 f_oF_1$, h_pF_2 is highly misleading. For this reason it is not recommended for general use. (Wright, J. W. and McDuffie, R. E., J. Radio Res. Lab., Japan, 7 409-420, 1960. See also Section 1.08).

1.42. h_c : The height of the maximum obtained by fitting a theoretical h'f curve for the parabola of best fit to the observed ordinary wave trace near f_oF_2 and correcting for underlying ionization (See Chapter 10, section 10.33, 10.4).

1.43. h_mF_2 : The height of maximum obtained by fitting a theoretical h'f curve for the parabola of best fit to the observed ordinary wave trace near f_oF_2 without correcting for underlying ionization. Note for h_c and h_mF_2 the curve fit is made for frequencies greater than $0.9 f_oF_2$.

1.44. Values of the height of maximum deduced using full computer methods applied to both o- and x-mode traces are usually denoted $h_{max}F_2$ or $h(Nm)$.

1.5 Conventions for Determining MUF Factors

1.50. MUF factors were originally introduced as conversion factors for oblique propagation computations. The Maximum Usable Frequency corresponding to a certain distance can be estimated by multiplying the critical frequency of the layer under consideration by the corresponding MUF factor. This definition corresponds to a rather simplified propagation model and it is now known that this Standard MUF is not necessarily identical with the Operational MUF of a radio circuit. Nevertheless, MUF factors are extremely useful as a basic parameter for practical predictions.

The standard transmission curve gives the ratio of the equivalent vertical and 3000 km oblique incidence frequencies which are reflected from a given virtual height assuming a standard simplified propagation model. Where 3000 km is adopted as a convenient conventional distance, the procedure provides a simple graphical solution of the calculation of the standard MUF (3000) and also of the corresponding MUF factor which is defined by

$$M(3000) = \frac{MUF(3000)}{f_o}$$

where f_o is the ordinary wave critical frequency.

The shape of the transmission curve is defined by the ratio at each virtual height given in the table below.

Virtual height (km)	200	250	300	350	400	500	600	700	800
Ratio	.220	.247	.274	.300	.325	.372	.417	.455	.490
MUF factor	4.55	4.05	3.65	3.33	3.08	2.69	2.40	2.20	2.04

If the ionogram has a logarithmic frequency scale, the standard transmission curve is made in the form of a transparent slider (Fig. 1.13). The abscissa scale of the slider is expressed as the MUF factor given above using the same scale units as the frequency scale of the ionogram but in opposite sense. When this curve is moved along the frequency axis until it just touches the ordinary ray trace (the height scales agreeing at the tangent point) the abscissa value given on the slider at the critical frequency of the layer is the factor $M(3000)$ for this layer (Fig. 1.14). If the ionogram has a frequency scale other than logarithmic a set of standard MUF curves is prepared from the standard transmission curve, each curve corresponding to a certain MUF value (Fig. 1.15). The curve which just touches the trace gives the MUF; the $M(3000)$ is obtained by division by the critical frequency of the corresponding layer.

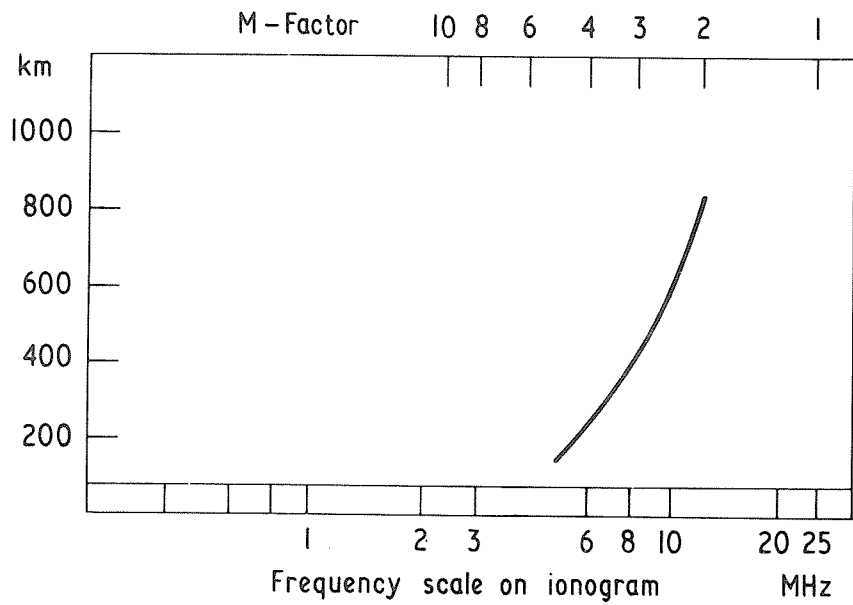

Fig. 1.13 MUF factor slider.

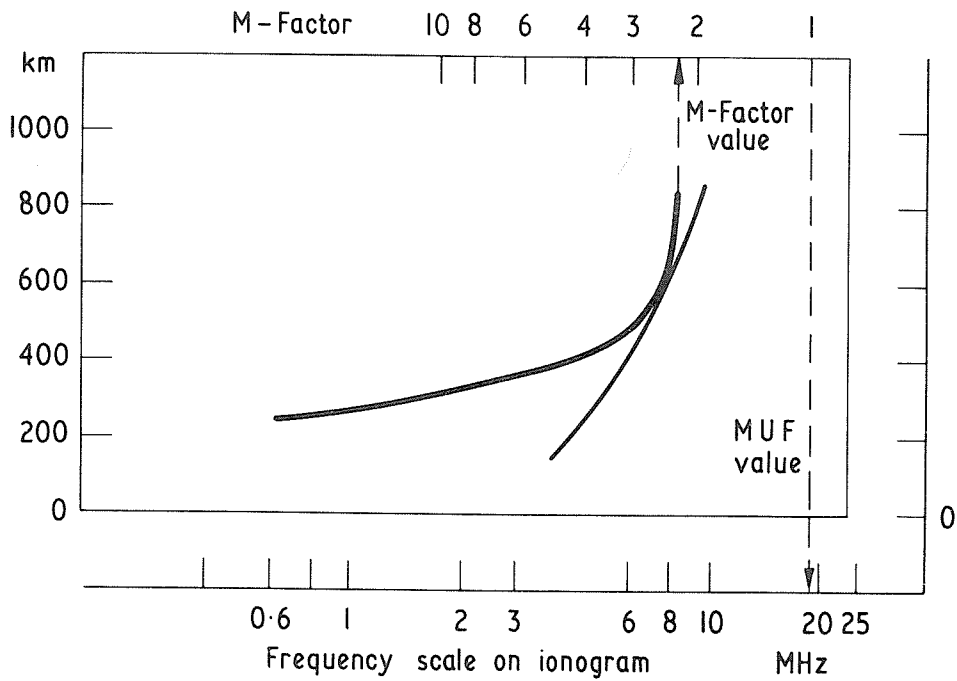

Fig. 1.14 Use of MUF factor slider.

M.U.F. 3000 KM U.R. 19

RANGES 1-4

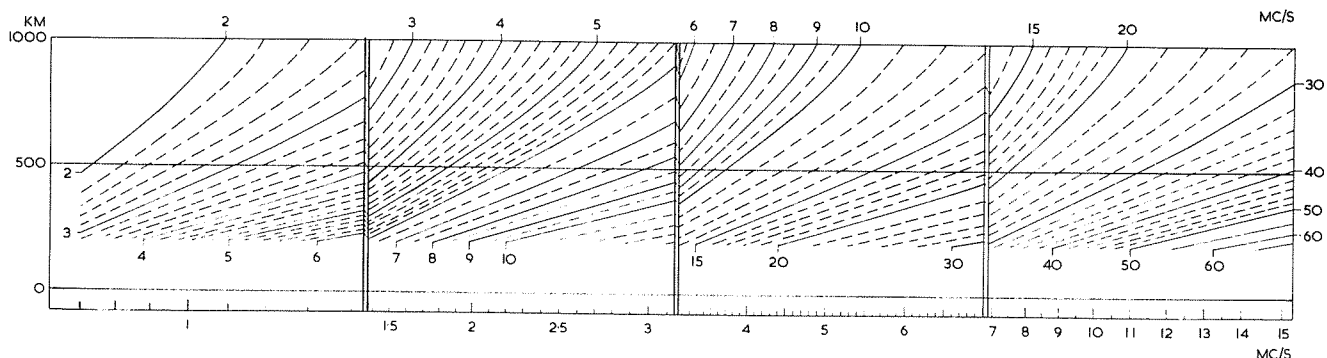

Fig. 1.15 Typical overlay for finding MUF's and MUF factors for ionograms with non-logarithmic frequency scales.

1.6 Characteristics to be Scaled

1.61. Monitoring the ionosphere demands that f_oF_2 , $M(3000)F_2$ and a reasonably significant value for f_oE_s , or parameters which can be converted into these, must be available from all stations. These are widely recognized as important parameters for scientific research also. The parameters f_{min} and f_{m2} (See Section 1.19 and 1.24) are also particularly significant both as an index of the behavior of the ionosonde and as an index of important changes in absorption. (See Chapter 12).

The four parameters, f_oF_2 , $M(3000)F_2$, f_oE_s and f_{min} are, therefore, the most important parameters and should be circulated by all stations in the form of monthly tables of hourly values arranged so as to be convenient for manual or machine manipulation.

1.62. There is general agreement that the important parameters for world-wide reduction and circulation are at present:

- (a) Frequencies: f_xI , f_oF_2 , f_oF_1 , f_oE , f_oE_s , f_bE_s , f_{min} or f_{m2}
- (b) Minimum virtual heights: $h'F_2$, $h'F$, $h'E$, $h'E_s$
- (c) MUF factors: $M(3000)F_2$, $M(3000)F_1$ or the equivalent $MUF(3000)F_2$ and $MUF(3000)F_1$
- (d) Es types: (see Chapter 4)

1.63. At many stations particular phenomena, which are not included in the world list of parameters, are important for local or regional research. Some typical characteristics of this type are given in Chapter 12. It is advantageous for these parameters to be reduced in a uniform manner in a given region and regional 'house-rules' are encouraged.

1.64. The f plot (see Chapter 6) is not only an efficient method of summarizing the data obtained on individual ionograms but is also an essential tool for those types of world-wide and regional studies in which the actual day-to-day variations in ionospheric phenomena are compared. f plots may be replaced by characteristic recordings (section 11.3) where these are available.

1.7 Soundings Schedules

The minimum useful schedule of routine soundings and reduction programs needed for scientific research and ionospheric prediction purposes is kept continuously under review as it changes with the development of the subject (see section 9.1 for details). Future recommendations will be found in the INAG Information Bulletins circulated to all known stations.

The minimum useful schedule of routine soundings is one sounding per hour taken so that the frequency 3 MHz occurs as near as possible to the hour for the nearest 15° meridian time, i.e. at U.T. $\pm x$ hours with x an integer. The adopted meridian should always be shown. The data may be expressed in U.T. with this also shown. The preferred schedule is quarter-hourly sounding, and this is the minimum which is useful at high latitudes or where layer tilt is common.

The minimum useful circulation of parameters is the four principal parameters given in section 1.61 above or their equivalent if notified internationally (e.g. f_{m2} instead of f_{min} , f_bE_s could be alternative for f_oE_s). Almost all stations circulate the standard parameters, section 1.62.

An International World Day Calendar is published yearly by the IUWDS and reproduced in the URSI Information Bulletin, INAG Bulletin, STP Notes and elsewhere. This gives the dates when special efforts should be made to obtain more complete monitoring of the Ionosphere, e.g. by replacing an hourly schedule by a quarter-hourly, quarter-hourly by shorter intervals. Events occurring on dates given in the Calendar are given preference for detailed world-wide study. There is also an International network for circulating alerts for special events which is operated by the International Ursigram and World Days Service through its Regional Warning Centers. Stations are encouraged to collaborate by taking special measurements in some or all of these programs.

1.8 Station Operations

Instructions for routine maintenance vary with the type of ionosonde in use and should be obtained from the manufacturers or organizations providing the ionosonde. It is valuable to keep a reference note book containing notes on voltages, currents and waveforms as shown by the local test gear which will be used. It is essential that all circuit changes are noted. In practice, changes of staff usually occur suddenly and do not allow proper teaching on the peculiarities of the ionosonde. The best indication of proper operation is the ionogram and a set of reference ionograms should be made to show typical day, night, summer and winter conditions. It is also valuable to have a reference set showing effects of changes of gain and of particular operating faults. It is easy to 'cure' a fault by modifying a circuit which is operating correctly so that it compensates for the faulty (undiagnosed) circuit. When this has happened several faults may occur simultaneously giving difficult diagnosis.

A full set of performance checks should be made at regular intervals and after any major adjustment, and the results recorded so that the standard operating conditions can be reestablished after any fault. Gain changes should be made on the first day of the month and recorded. It is advisable to examine the previous year's data so that the optimum changes are made. This is particularly important near the equinoxes when conditions change rapidly in time and there may have been several months in which only small gain changes were necessary.

Review each month's data and note whether the gain in use was satisfactory, too high or too low so that the same mistake is not made next year.

If the ionograms are not analyzed as obtained, it is strongly recommended that some extra ionograms be taken whenever the film is changed. These should be cut off and developed locally and inspected for quality.

It is important that the format of the ionogram is kept constant since otherwise overlays cannot be used. A convenient check, e.g. ink marks on the monitoring cathode ray tube to show the standard time base sizes, is essential. Marks showing the current gain adjustment settings are more easily checked rapidly than a table of values.

Always keep full notes on the causes of any failure.

The operation of the ionosonde should be checked as frequently as convenient since most failures occur without much warning. Incipient difficulties in reduction due to the operation of the ionosonde should be corrected as early as possible - it is usually not possible to reduce difficult ionograms unless the basic quality is good. Gradual deterioration is usually allowed to continue much too long and this causes the analysis to become crude and inaccurate.

1.9 Computer Output

Parameters reproduced in computer form are usually identified by the standard characteristic codes given in section 7.3. These may be supplemented or replaced if desired by the corresponding parameters in computer printout form, e.g., FOF2 for foF2, FMIN for fmin, etc. All lower case symbols are replaced by capitals for computer reproduction and are regarded as equivalent to the international conventions. Other use of the capital letter forms is permitted on a voluntary basis.

The use of capitals rather than lower case symbols for Es types was adopted in 1975 because in practice the lower case symbols are often difficult to read on worksheets. The original convention Es-a, Es-c etc. is preferred in texts. It is probable that, as more computers become available with lower case symbols, the parameters in computer form will also revert to the original form.

Originally lower case symbols were devised for Es types so as to avoid confusion with letter symbols which have quite different meanings. This is important to trainees but not important to fully trained operators who easily recognize the different context.

2.0 General Conventions

The primary purpose of describing and measuring the representative features of the ionosphere overhead is fulfilled by interchanging numerical values which are systematically determined from the ionograms taken at the hour in Universal Time. These are tabulated using a Local Standard Time referred to the nearest 15° standard meridian. At most stations this is identical with Local Civil Time. To avoid ambiguity the time used should always be shown on the tabulation sheets.

The following selection rules are adopted to make the data to be interchanged homogeneous:

- (a) All numerical tabulations except for f_xI refer to the ordinary-wave trace. The extraordinary-wave trace or the 'z' trace should be measured for a frequency characteristic when the ordinary-wave trace is not available or is doubtful, and the equivalent ordinary-wave parameter computed and tabulated with the appropriate qualifying letter (J or Z) and descriptive letter.

For f_xI the ordinary trace should be measured when the extraordinary trace is missing (usually through absorption, B) and the equivalent extraordinary-wave parameter computed and tabulated with qualifying letter O and the appropriate descriptive letter. (See section 3.2)

- (b) Multiple echoes should always be examined and scaled when necessary to confirm or assist the interpretation of the first order trace, but are not included in basic summary tables or graphs [A99I, Fig. 102], (except f_m2 where used). They are particularly valuable for showing whether the ionosphere is effectively horizontally stratified, the assumption implicitly made in the analysis of ionograms from most parts of the world. At high and low latitudes this assumption is often not true and it is essential to study any multiple reflections present to see whether the assumption is true or not or if it is likely to be changing with time. The analysis rules when tilts are present differ significantly from those normally used. (section 2.7).
- (c) Traces due to very weak reflections should be ignored. Many ionograms show weak traces in addition to the traces of the normal reflecting layers. These traces seldom represent phenomena which can be studied efficiently on a world-wide basis using standard ionosondes. Even when they appear regularly at the stations, they rarely represent normal reflection in the ionosphere. They should be studied as a special research.

Normal traces weakened by attenuation phenomena or equipment faults are always treated as significant. The deduced characteristics may be described by B, R or C when appropriate. Thus when f_{min} is high a normal trace may look very weak but should be treated as a strong trace.

Note: The weak partial reflection from a steep gradient in the D region, [B III.10] normally at virtual heights below 95 km, is a valuable indication of high absorption and is classified as Es type d, (see section 4.83). The presence of this trace is ignored when determining f_{min} , f_oE_s , f_bE_s or $h'E_s$. If no other trace is present, all tabulations except Es types show B and Es type shows d.

- (d) Traces due to oblique reflections and other transient phenomena should be ignored except as listed below. These traces are most readily recognized by comparisons with examples of the common standard types. Detailed examination of closely spaced sequences of records [A96I, Fig. 91] [B III pp. 18-26] and other special experiments are also useful. It is recommended that each station builds its own library of difficult records, confirming their interpretation with INAG and draws on the experience of other groups of workers.

Rule (d) does not apply to:

- (i) f plots where oblique F region reflections are always recorded;
- (ii) slant Es which is tabulated as an Es type but not used to determine f_oE_s , f_bE_s or $h'E_s$. (Section 4.83).
- (iii) f_xI which is normally generated by oblique reflections. (section 3.3).

2.1 Accuracy Considerations

The accuracy with which ionospheric heights and critical frequencies can be measured depends on the inherent accuracy of the equipment, the accuracy of the method of calibration and the reading accuracy used in reducing the ionograms. Since every reduction implies some simplification of the facts and the usable accuracy is often limited by the physical properties of the reflecting layers, a reasonable value for reading accuracy has been established internationally. Some research techniques, e.g. the accurate determination of the electron density height profile by the more

advanced methods demand a greater accuracy than this. Conversely, variability in the ionosphere may demand lower standards of accuracy in some areas so that a reasonable sample of numerical data can be obtained. In general, ionosondes should be capable of giving ionograms with the required accuracy.

For some geophysical applications it is the relative change which is of interest. For this reason it is worth-while to maintain a good relative accuracy even though the absolute accuracy may be less certain. The convention adopted is that the accuracy implied by the numerical values should be determined by the reading accuracy and not by the absolute accuracy of the measurements. In general, the absolute accuracy of virtual height measurements is very much less than the relative accuracy conveniently available. There is often a serious systematic error in all height measurements fixed by the particular technique employed. This can be important for comparison with rocket or incoherent scatter experiments.

2.11. Accuracy of calibration of ionograms: The accuracy of frequency markers and of the repetition frequency of the height markers can be easily checked with the aid of a suitable frequency standard. It is recommended that the accuracy of these scales should be maintained to $\pm 0.1\%$.

It is more difficult to establish the correct zero point of the height markers than to maintain the spacing accuracy. Even when automatic synchronization of the transmitted pulse and height markers is used, a systematic error up to 10 km may be present. This error can be eliminated by a suitable calibration procedure, e.g., by using multiple reflections. In addition, the position of the lower edge of the trace usually depends on the amplitude of the received signal. This phenomenon cannot be neglected when accurate height measurements (e.g., ± 2 km) are required and suitable calibration is then necessary.

2.12. Techniques for calibration of trace height: The appropriate technique depends on the design of the ionosonde and the extent to which the virtual height recorded depends on the amplitude of the reflected signal. There are two main classes:

- (a) ionosondes in which the height markers are rigidly locked with the ground pulse.
- (b) ionosondes in which they can be shifted relative to the ground pulse.

In case (a) it is essential to evaluate the average error, which is primarily due to the finite delay of the echo in passing through the receiver, but can also be generated in pulse shaping circuits, and can be equivalent to a height error of up to 10 km. This should be determined (see below) and either be subtracted from all values before publication or a note of its value included with all height data. In case (b) the height markers are adjusted so that the height of the first trace is consistent with the height difference between first and second (or higher order) traces. This is best done using the multiple traces from flat totally reflecting Es. Great care must be taken that the setting is correct and does not drift with time. The details of the phenomena have been discussed at length by A. J. Lyon and Moorat, J. Atmos. Terr. Phys. 8, 309-317, 1956.

A convenient procedure, usable when the ionosonde trace width is sensitive to amplitude changes, has been given by W. R. Piggott, J. Atmos. Terr. Phys. 14, 175-180, 1959.

The alternative approach is to use equipment with very severe differentiation, i.e., a very short time constant. This is sensitive to very small signal levels and can give more accurate heights when the trace is due to a single ray and there are no interfering signals. It can, however, be very misleading and difficult to interpret when multiple rays or scattered reflections are present.

For some stations proper calibration is not practical. The average correction should be determined by comparison between the virtual heights of different orders of reflection and indicated on all height tabulations. Note that errors in height automatically imply errors in the M(3000) factors.

Ideally the objective is to measure virtual heights to the nearest one km interval. This was attained as early as 1935 but is not always possible with current ionosondes, many of which can only attain the nearest 5 km.

2.13. Reading accuracy: The measurements should be made to at least the reading accuracy specified in the following table:

Characteristic	Reading accuracy	
	E region	F region
	E layer	Es layer
Height	2 km	5 km
Frequency	0.05 MHz	0.1 MHz
M(3000)		0.05

Note: If gain runs are made the heights should be obtained from the ionogram with the clearest trace. When expanded height ionograms are available every effort should be made to read the height characteristics as accurately as possible. Under these special conditions a reading accuracy of 1 km may be obtainable. When the reading accuracy of the equipment is better than ± 2 km, E-region heights should be given to the nearest odd km at least. When the reading accuracy is better than ± 5 km E-region heights should be given to the nearest 5 km. When the reading accuracy is worse than ± 5 km h'E should not be recorded, but h'Es is still valuable for classification purposes and should always be tabulated. When the characteristics of the ionosonde only enable heights to be measured to the nearest 10 km no attempt to tabulate in 5 km intervals should be made. Such ionosondes are now obsolete.

Where the height accuracy of an ionosonde is limited to ± 5 km, little scientific value can be obtained from the E-height values. These may, however, still be needed for evaluating F-layer electron density height profiles and the F-region reading accuracy then applies to all heights. The value of profiles when the height accuracy is worse than ± 10 km, is rather small and measurements should only be made to meet specific purposes.

It is not, in general, worth-while to apply the more elaborate computer methods, with correction for valleys and underlying ionization, unless the frequencies and heights can be measured to at least the accuracy given in the table. The correction terms vary rapidly with the difference in height between corresponding points in the o and x traces which must therefore be determined accurately, and serious errors can be incurred with frequency errors of 1% for the measurements near critical frequencies.

2.14. Timing: The nominal time for a slow sounding is defined as the time when the ionosonde records the standard frequency of 3 MHz. The nominal time of a group of multigain recordings is that of the medium gain ionogram. The nominal and scheduled time of the recordings should not differ by more than 0.5 minute.

If for any reason data are not available exactly on the hour, a record obtained within five minutes of the hour may be used to scale the hourly value of the characteristic without qualification, provided that the sequence of ionograms indicates that conditions are varying slowly. (See Chapter 7 for details of tabulation.)

2.2 Accuracy Rules for Individual Measurements

2.21. General: The accuracy rules give the desirable accuracy applicable when the structure of the ionosphere and characteristics of the ionosonde permit. They also indicate the extent of the uncertainty permitted for doubtful or extrapolated values and enable such values to be identified. The rules imply that, in general, the reliability of data is determined by the percentage inaccuracy allowed except when this percentage is less than the reading accuracy Δ . The general properties of the rules are illustrated in Fig. 2.1, which shows, in graphical form, the rules applicable to all critical frequencies with reading accuracies $\Delta = 0.1$ MHz and $\Delta = 0.05$ MHz.

It must be remembered that the accuracy rule limits apply to reasonable doubt, not to absolute certainty. Thus, if an F trace shows some scattered echoes beyond the limit range and is such that it is unlikely that foF2 is really above the limit range. A numerical value for foF2 should be scaled. The scattered traces are scaled in accordance with the rules of section 2.83.

2.22. Conventions for assigning the level of accuracy: The maximum reading unit Δ has been defined in the table of recommended reading values given above (section 2.13). Numerical values whose reliability is influenced by certain phenomena are qualified by symbols (section 2.3) according to the following rules.

- (a) If the estimated uncertainty of a value does not exceed $\pm 2\%$, or $\pm \Delta$, whichever is greater, then the numerical value is unqualified.
- (b) If the estimated uncertainty of a value exceeds $\pm 2\%$, or $\pm \Delta$, whichever is greater, but does not exceed $\pm 5\%$, or $\pm 2\Delta$, whichever is greater, the value is considered doubtful and the qualifying letter U is used with the number together with the descriptive letter which most nearly represents the reason for the uncertainty.
- (c) If one boundary is certain and the other possible boundary of uncertainty lies within $\pm 10\%$, or $\pm 3\Delta$, whichever is greater from it, the most probable value is taken as being midway between the observed limits, and the qualifying letter U is used with the number and appropriate descriptive letter.
- (d) When the possible error exceeds that in paragraph (b), but it is estimated that the true value lies within 20%, or 5 Δ , whichever is greater, of an observed boundary of

possible positions of the principal echo, then this observed limit is tabulated with the qualifying letter D or E, whichever is applicable, and with the appropriate descriptive letter.

- (e) When the extreme limit of the principal echo is judged to differ from the true value of the parameter by more than 20%, or 5Δ , whichever is greater, a descriptive letter only is tabulated without a numerical value. A descriptive letter used in this context is often termed a replacement letter (See Section 2.3).

The rules for frequencies are summarized in Fig.2.1a.

2.23. Accuracy rules in total range of uncertainty forms: Operators who prefer to consider the total range of uncertainty may use the following rules which are equivalent to those given above.

- (a) If the total range of uncertainty does not exceed 4% or 2Δ , whichever is greater, then the numerical value is unqualified.
- (b) If the total range of uncertainty exceeds 4% or 2Δ , whichever is greater, but does not exceed 10% or 4Δ , whichever is greater, the value is considered doubtful and the qualifying letter U is used with the most probable value together with the descriptive letter which most nearly represents the reason for the uncertainty.
- (c) If one boundary is certain and the other possible boundary lies within 10% or 3Δ , whichever is greater from it, the most probable value is taken as being midway between the observed limits, and the qualifying letter U is used with this value and the appropriate descriptive letter.
- (d) When the total range of uncertainty exceeds that in paragraph (b) but is less than 20% or 5Δ , whichever is greater, of an observed boundary of possible positions of the principal echo trace, then this observed limit is tabulated with the qualifying letter D or E, whichever is applicable, and the appropriate descriptive letter.
- (e) When the total range of uncertainty exceeds 20% or 5Δ , whichever is greater, a descriptive letter only is tabulated without a numerical value.

The application of these rules to F-region frequency parameters $\Delta = 0.1$ MHz and E-region parameters with $\Delta = 0.05$ MHz are shown graphically in Figs. 2.1 (a) and (b), respectively."

ACCURACY RULES

2-5

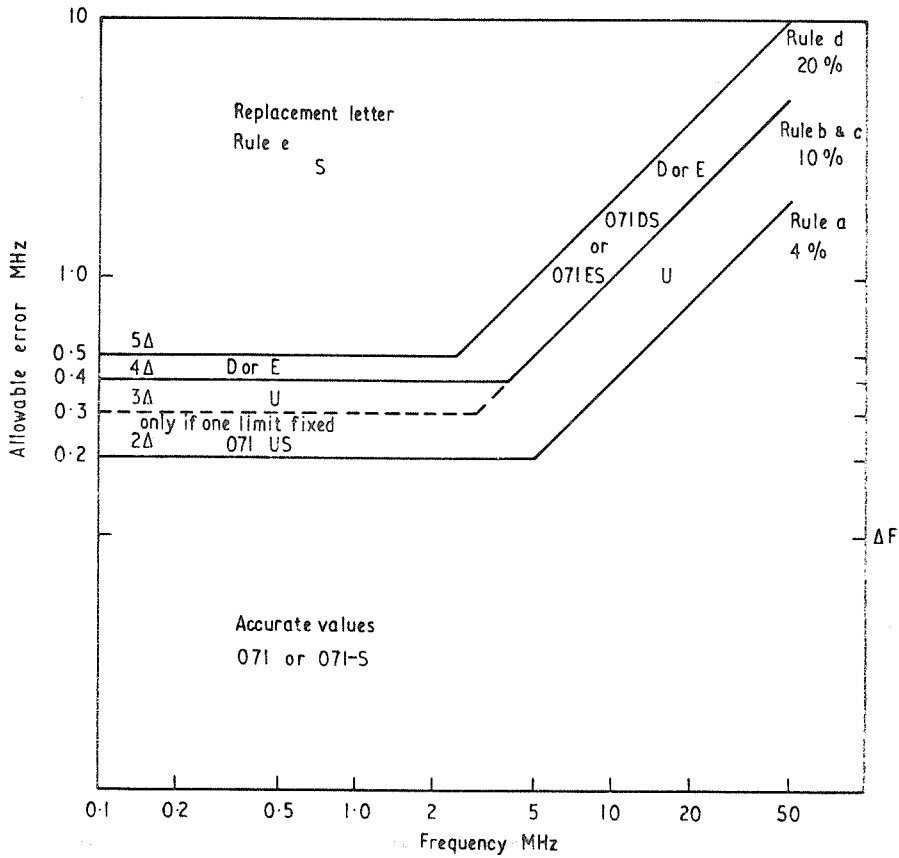

Fig. 2.1a Accuracy rules for F region frequencies $\Delta = 0.1$ MHz in terms of total range of error.

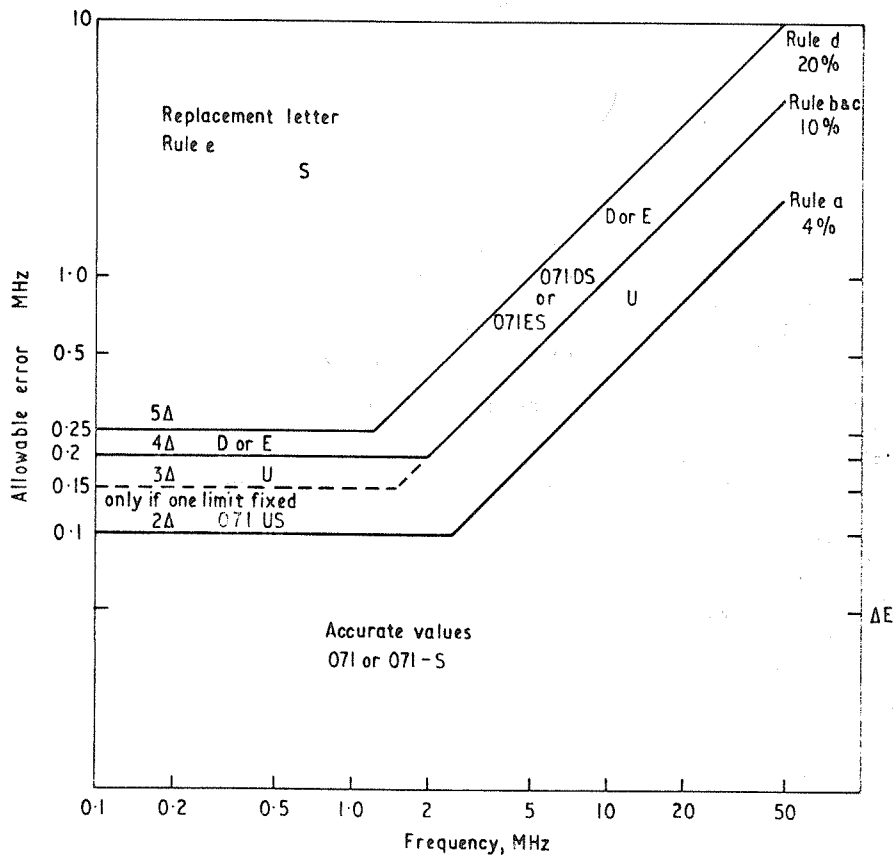

Fig. 2.1b Accuracy rules for E region frequencies $\Delta = 0.05$ MHz in terms of total range of error.

2.24. Miscellaneous Notes

Prior to 1970 the limits for use of D and E were 10%, or 3 Δ , and descriptive letters were used when the extreme limits exceeded these values. The need for numerical values for the study of particular events and to increase the value of the medians when the limits were often recorded has prompted this change.

A numerical value obtained by extrapolation (section 2.4) and not qualified by D or E should never differ by more than 5%, or 2 Δ , whichever is greater, from the extreme limit of the actually observed principal echo.

In many cases inspection of the second order traces can provide information on the reliability of the measurements. In particular, the presence of tilted layers may be established by comparing the virtual heights and critical frequencies deduced from the first and second order traces. The accuracy of the operations denoted by the qualifying letters J, O, Z is inherently not measurable and may be small or large compared with the limits imposed by the accuracy rules. The accuracy rules should not be applied when these letters are used.

It is particularly important that the accuracy rules are consistently applied when spread F is present since many researchers depend on counting the incidence of different levels as shown by the letter symbols (Section 2.8).

When the normal accuracy of the recorder is inadequate to enable the recommended intervals to be used, the $\pm 2\%$, $\pm 5\%$ and $\pm 10\%$, + 20% or -20% may be changed proportionally so that the normal ionogram is unqualified. A note to this effect should be circulated with the data. Every attempt should be made to improve the equipment so that this is not necessary, as the value of the data depends largely on the accuracy rules being obeyed.

2.3 Qualifying and Descriptive Letters

Certain ionospheric, equipmental, or interference effects can be observed on ionograms and may make it difficult or impossible to obtain numerical values to the accuracy given in the table above. The qualifying and descriptive letter symbols listed below are used along with, or in place of, the numerical values to indicate these effects (all letters are descriptive if not otherwise designated). Qualifying letters indicate the nature of the uncertainty as explained below, and are always accompanied by a descriptive letter indicating the reason for the uncertainty. Descriptive letters may be used without qualifying letters in two ways:

(a) to denote the presence of a phenomenon which does not affect the scaling accuracy.

(b) to replace a numerical value when no measurement within the accuracy limits is impossible.

In case (b) the descriptive letter is called a replacement letter.

- A - Qualifying letter: less than. Used only with fbEs. (See section 3.1.)
Descriptive letter: Measurement influenced by, or impossible because of, the presence of a lower thin layer, for example, Es.
- B - Measurement influenced by, or impossible because of, absorption in the vicinity of f_{min} .
- C - Measurement influenced by, or impossible because of, any non-ionospheric reason.
- D - Qualifying letter: greater than.
Descriptive letter: Measurement influenced by, or impossible because of, the upper limit of the frequency range in use.
- E - Qualifying letter: less than.
Descriptive letter: Measurement influenced by, or impossible because of, the lower limit of the frequency range in use.
- F - Measurement influenced by, or impossible because of, the presence of frequency spread.
- G - Measurement influenced or impossible because the ionization density of the layer is too small to enable it to be made accurately.
- H - Measurement influenced by, or impossible because of, the presence of stratification.
- I - Qualifying letter only: Missing value has been replaced by an interpolated value.
- J - Qualifying letter only: Ordinary component characteristic deduced from the extraordinary component.
- K - Particle E layer present.
- L - Measurement influenced or impossible because the trace has no sufficiently definite cusp between layers. Mixed spread F present (see section 2.8.)

- M - Interpretation of measurement questionable because ordinary and extraordinary components are not distinguishable.
 Qualifying letter: Used with descriptive letter which shows why components not distinguishable.
 Descriptive letter: Used when interpretation is doubtful and a qualifying letter needed for other reasons (e.g., U, D, E).
- N - Conditions are such that the measurement cannot be interpreted.
- O - Qualifying letter: Extraordinary-component characteristic deduced from the ordinary component. (Used for x characteristics only.)
 Descriptive letter: Measurement refers to the ordinary component.
- P - Man-made perturbations of the observed parameter; or spur type spread F present (see section 2.8).
- Q - Range spread present. (See also Section 2.8)
- R - Measurement influenced by, or impossible because of, attenuation in the vicinity of a critical frequency.
- S - Measurement influenced by, or impossible because of, interference or atmospherics.
- T - Qualifying and descriptive letter: Value determined by a sequence of observations, the actual observation being inconsistent or doubtful. (See section 6.9.).
- U - Qualifying letter only: Uncertain or doubtful numerical value.
- V - Forked trace which may influence the measurement.
- W - Measurement influenced or impossible because the echo lies outside the height range recorded.
- X - Measurement refers to the extraordinary component.
- Y - Lacuna phenomena (also Section 2.75) or severe F-layer tilt present.
- Z - Qualifying letter: Measurement deduced from the third magneto-electronic component.
 Descriptive letter: Third magneto-electronic component present.

In Chapter 3 the use of each letter is discussed in detail.

The following descriptive letters are used to show spread F types where spread F types are tabulated in the Standard F tables. They then take precedence over all other letters. (See section 3.2, p. 74).

- F - Frequency spread present. foF2 and fxI tables only.
- L - Mixed spread present. foF2 and fxI tables only.
- P - Polar spur. fxI table only.
- Q - Range spread present. h'F, h'F2 tables. Rarely in foF2 or fxI tables.

2.4 Extrapolation

A trace may be extrapolated in height or frequency both when a characteristic is not clearly visible on the ionogram for instrumental or operational reasons and when the complexity of the ionospheric phenomena changes the meaning of the apparent value of the characteristic. Extrapolation is used to give the most probable value of the characteristic in these cases.

Extrapolation has been allowed in order to avoid systematic error, for instance, the presence of transitory deformations, blanketing, or deviative absorption. Limits are prescribed so that the extrapolation is 'controlled'. These limits are determined by the general accuracy requirements (section 2.1, 2.2) and the permitted range of extrapolation is always limited by the accuracy rules given above. Within the limits it is important to obtain numerical values whenever possible as the usefulness of the tabulated data depends on the number of numerical values obtained.

The most common extrapolation is the vertical extension of a trace near the critical frequency. This should be controlled by examining ionograms where the trace is more complete and the significant common parts are similar in shape. This applies also when the retardation at foE is decreased by the presence of sporadic E, Fig. 2.2(a). Extrapolation in height is also allowed, Figs. 2.3, 2.4.

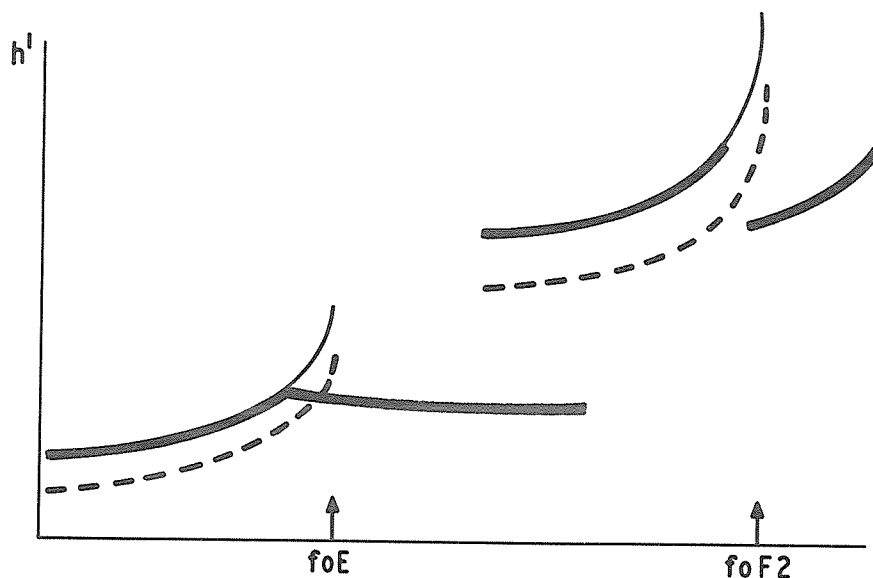

Fig. 2.2a Extrapolation to a critical frequency.

The shape of the normal trace (---) for similar conditions is traced and moved to fit the observed trace (thin line in Fig. 2.2a. By this means the ionogram traces (shown thick) are extrapolated to give the critical frequency.

Use accuracy rules to decide if qualifying letter needed. (section 2.2)

foE is (foE)-A or (foE)UA

foF2 is (foF2)-R or (foF2)UR

Extrapolation is not usually justified over greater frequency ranges, instead use limit value and D or replacement letter A or R. Similar rules apply for extrapolation due to C, S, etc.

The range of uncertainty due to extrapolation extends from the end of the observed trace to the deduced value of the critical frequency. This has the merits of simplicity and long use. However, this rule restricts the number of numerical values allowed by the accuracy rules. The convention shown in Fig. 2.2b is also permitted. This can be stated: The ranges of uncertainty allowed by the accuracy rules are to be compared with the ranges between the least and largest value of critical frequency permitted by the extrapolation process.

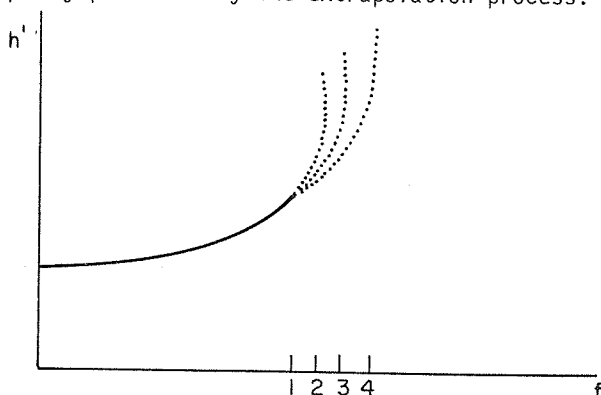

Fig. 2.2b Range of uncertainty when extrapolating to a critical frequency

The observed trace ends at frequency 1.

The most probable trace gives a critical frequency at frequency 3.

The least possible value of the critical frequency is 2.

The greatest possible value of the critical frequency is 4. The observed uncertainties, 2-3 and 3-4, or 2-3 are compared with the allowable uncertainties given in section 2.22 or 2.23 respectively, e.g., if 2-3 is less than Δ , no qualification is needed (rule a).

Note that the range of uncertainty is usually less than the range of extrapolation given by the difference 1-3.

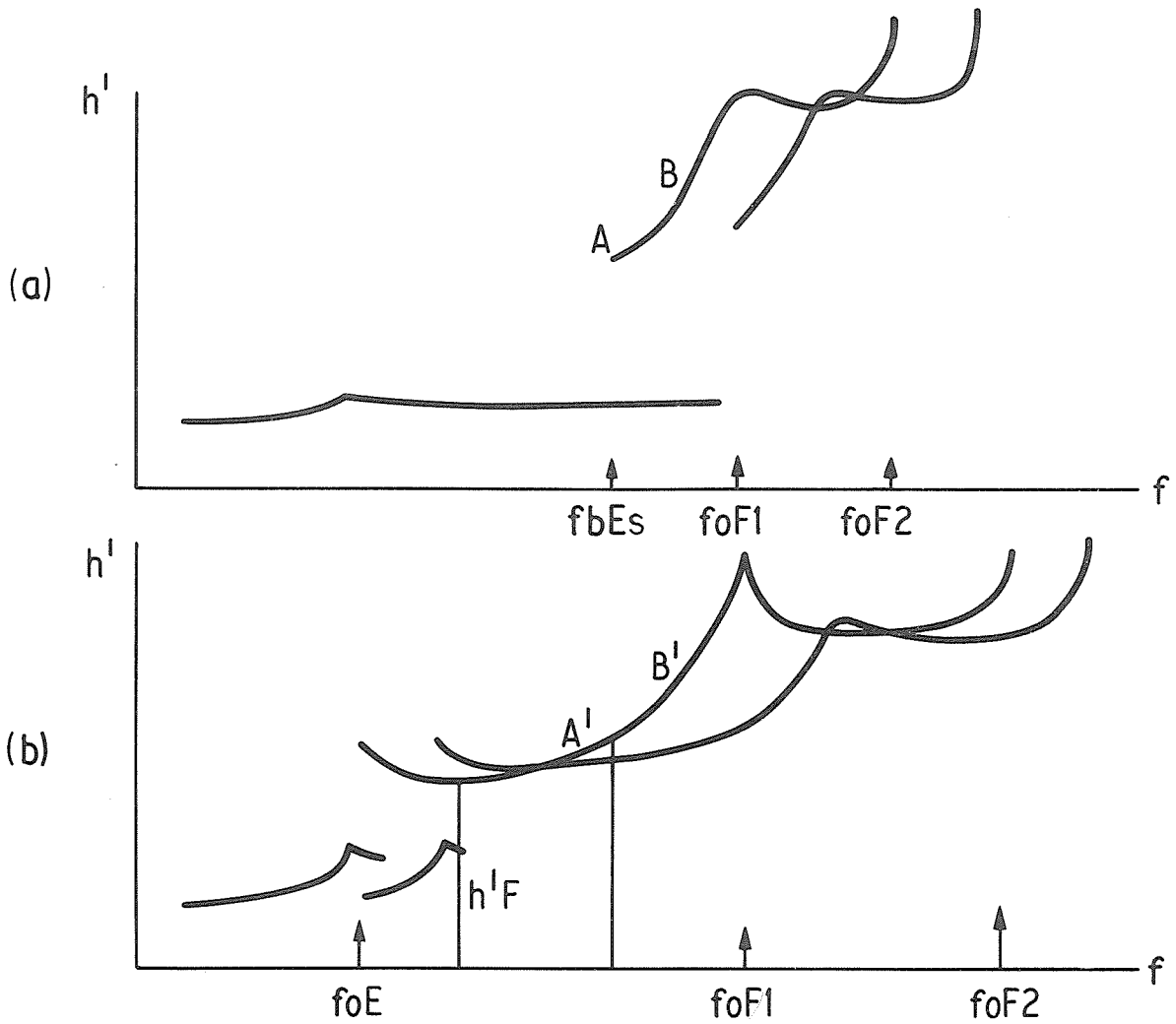

Fig. 2.3 Extrapolation in height

Estimation of error for use of E.

(a) $h'F$ blanketed by Es.

(b) Ionogram taken at same time of day so $foF1$ and foE approximately the same.

AB matched to A' B' near A and A' so that difference between $h'F$ at $fbEs$ in (a) and correct value of (b) can be estimated.

Note: Error in foE can be determined similarly.

This is used to show when a limit value is likely to be useful (see section 3.2 letter G).

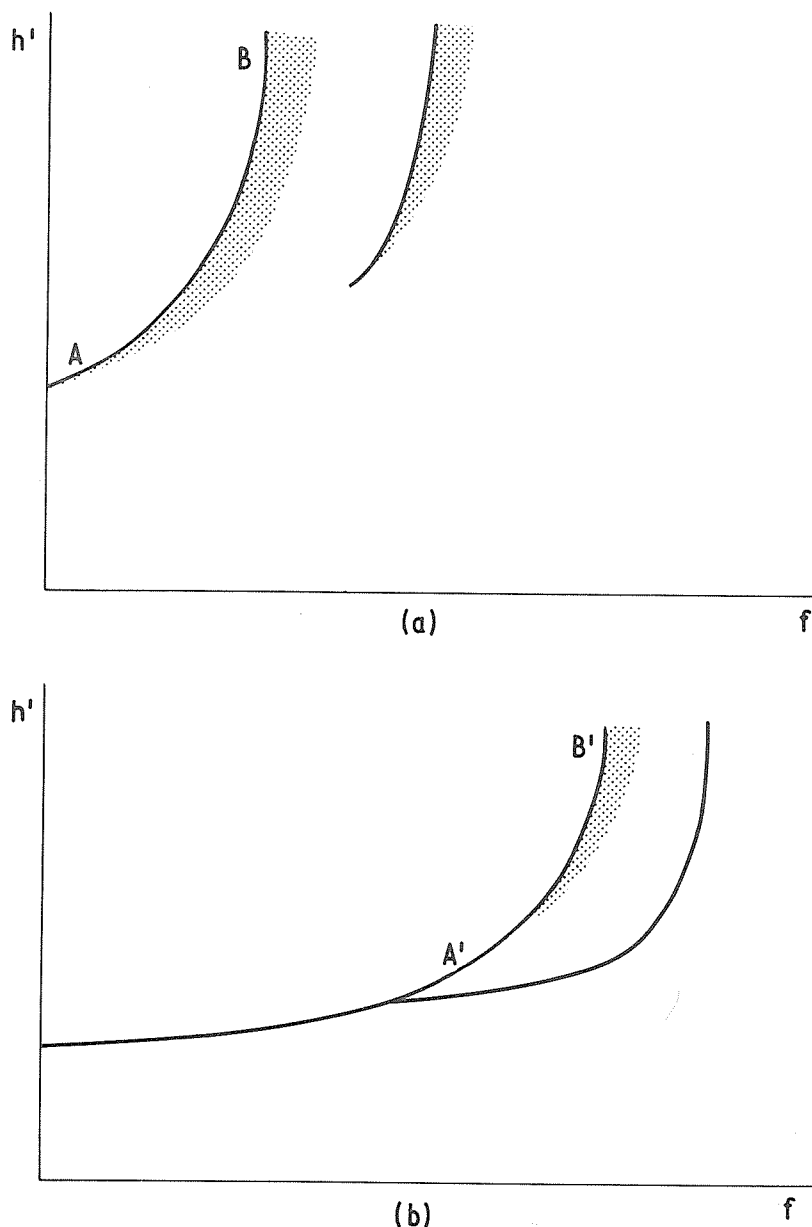

Fig. 2.4 (a)(b). Estimating error in minimum virtual height at night.

- (a) $h'F$ falling at lowest frequency seen.
 (b) Ionogram taken when $foF2$ much greater than in (a) but curvature of trace similar AB, A'B'.

Estimate difference between true $h'F$ in (b) and value at A. (This can be done by an overlaid tracing if the frequency scale of the ionogram is logarithmic. Otherwise compare heights at A and A' where A' is chosen so that the frequency ratio B/A is equal to that for B'/A' .)

Extrapolation is particularly important when it is desired to compute electron density with height profiles. Detailed rules are given in section 10.22. These procedures can be applied to improve the accuracy of standard parameters, e.g., $h'F$ at night by providing standard reference patterns. (Fig. 2.4 (a), (b)). Values deduced in this way should always be qualified with U and the descriptive letter which shows why extrapolation was needed. The work involved is appreciable and therefore such procedures are only used for training or when there is a local need for greater accuracy.

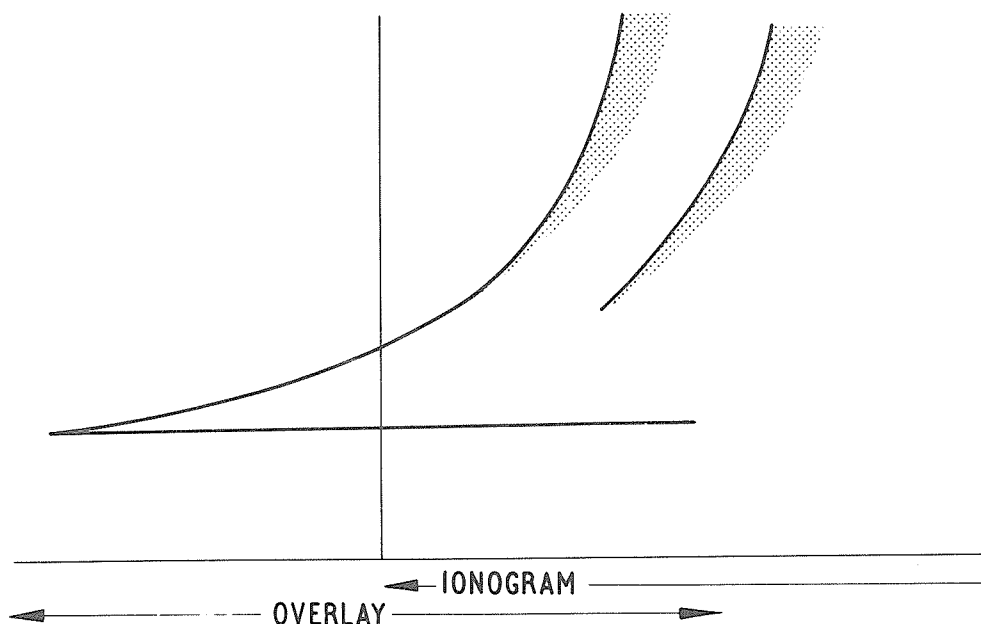

Fig. 2.4 (c). Estimating error in minimum virtual height at night or use of overlay based on Table 10.2

Alternatively Table 10.2 can be used to compute the expected shape (see section 10.22 for details).

For logarithmic frequency, card overlays are prepared for different thicknesses of layer and matched to the o trace. The vertical line shows the bottom edge of the ionogram and the horizontal line the extrapolated value of $h'F$.

2.5 Interpolation

Interpolation in time is allowed in order to make the tables of hourly values as complete and representative as possible. It is very important that these procedures be strictly controlled. Isolated missing hourly values can usually be replaced by an interpolated value using the rules given in detail in section 3.1 under the letter I.

2.6 Gain Runs

Frequently the receiver gain setting which is best for scaling one characteristic is not suitable for another. Thus, a gain run (a sequence of three soundings at low, normal and high receiver gain) taken at each hour provides more accurate information [A100I, Figs. 105, 106]. The steps in gain should always be kept the same and, whenever possible, the differences in gain measured and specified in the station operation log books. For many stations changes of gain of about ± 15 dB appear to be adequate but the best value must be found by experiment.

In high noise areas smaller changes, e.g., + 5 dB, - 10 dB, may be needed whereas in very quiet zones, e.g., the Arctic and Antarctic, much larger changes are advantageous.

Each characteristic is scaled from the sounding on which it is best displayed, except that:

- (a) Gain sensitive characteristics f_xI , $foEs$, $fbEs$ and $fm2$ or $fmin$ must be scaled from the normal gain sounding.
- (b) When transient phenomena are present the most consistent value is tabulated. Gain runs are particularly valuable for interpreting ionograms when spread echoes (scatter) are present.

2.7 Scaling of Tilted Layers and Oblique or Spread Traces

2.70. Principles: The greatest difficulties in interpreting ionograms arise when the ionosphere is not horizontally stratified. This may be due to either localized or large scale phenomena. The ionosphere can be curved so that reflections from several directions are possible at the same time giving several traces. Field aligned irregularities can also give strong reflections and add to the complexity of the ionogram. These phenomena are particularly important at high and low magnetic latitudes. $f_x I_1$, which refers to oblique traces except when it is equal to $f_x F_2$, is discussed in section 3.3.

The perturbations due to tilts are often used to study travelling disturbances and many examples will be found in the literature. For synoptic analysis purposes these cause perturbations in the values of standard parameters which are transient and the objective is to obtain the most probable value of the unperturbed parameter.

For most hours at temperate latitudes, except possibly near sunrise and sunset, and at some hours elsewhere large scale tilts are rare, so that it is justified to use interpretations which assume that the main reflecting structures are near horizontally stratified, any tilts being less than 5° . When this is not true, completely different rules are needed to identify the most nearly overhead trace. Thus, the first problem in analyzing complex ionograms is to find whether large tilts are likely to be present or not. In this context we use tilt to describe the form of the surfaces of constant ionization density, Fig. 2.5, responsible for reflecting the signals and giving the observed traces. These surfaces may be tilted as a result of a variation in electron density longitudinally, the height and thickness of the layer staying constant; to changes in height or thickness, the maximum electron density staying constant or to any combination of these effects. When two layers are present which vary differently with distance the surfaces can even be tilted in different directions at different heights, giving very complex ionograms. For most interpretation purposes it is adequate to assume that a given frequency is reflected by the same electron density whether the layer is horizontal or not. This is slightly incorrect for the second order reflections where the effective frequency, $f \cos i$ (i is the angle of incidence), is slightly less than the working frequency f . (For a layer tilted at 45° , $\cos i = 0.92$). At high latitudes a tilt in the magnetic meridian approximately complementary to the angle of dip can cause the o-mode reflection to be transformed into a z mode of reflection.

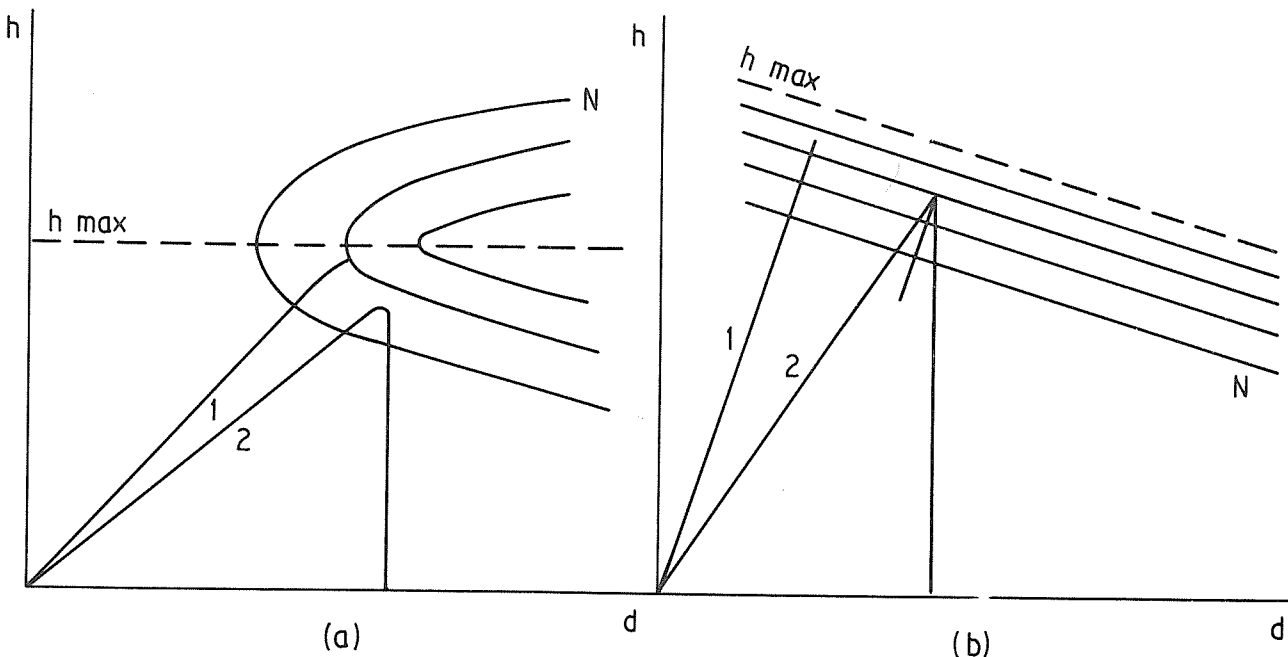

Fig. 2.5 Reflection from tilted layers.

- (a) electron density increasing with distance
 (b) tilted layer-height changing, electron densities constant
 — surfaces of constant electron density, N .
 1. First order reflection
 2. Second order reflection

When multiple traces are present the critical test is the consistency between the heights deduced from different order traces, Fig. 2.6. The family of traces showing the greatest consistency is nearest overhead. If the height values are consistent (after allowing for amplitude effects, section 2.1), the interpretation can be regarded as adequate.

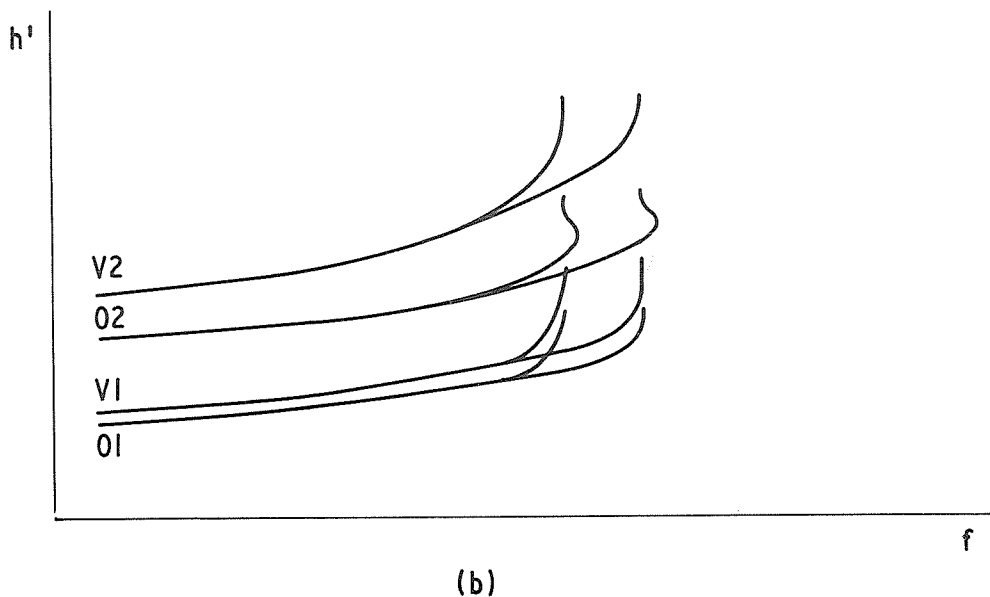
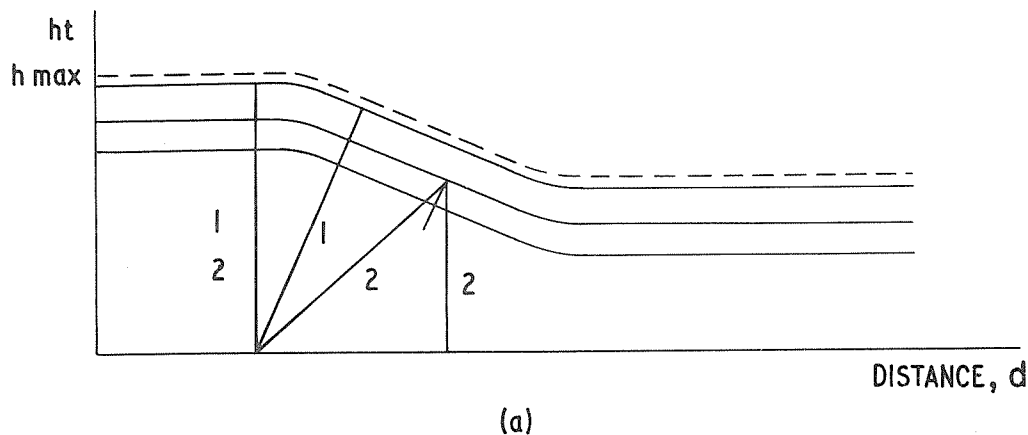

Fig. 2.6 Simultaneous vertical and oblique reflection

- (a) A case where h_m is varying, N_{max} constant, showing modes present
- (b) Corresponding ionogram

$$h'(V2) = 2 h'(V1); \quad h'(O2) \neq 2h'(O1)$$

- Note:
- (i) Relative positions of V1, V2 (vertical first- and second-order traces), O1, O2 for corresponding oblique traces, depend on tilt present.
 - (ii) If N_{max} varies also the critical frequencies of V traces will differ from those of O.
 - (iii) MUF nose on O2 trace. The presence of this type of pattern (or this reversed in frequency) always means tilt is present.

The effects of irregularities giving rise to spread F traces also depend on whether large tilts are present or not and the optimum analysis rules change accordingly. Historically, the great pre-dominance of almost horizontal stratified conditions has given rise to a set of 'normal' rules applicable to this case. In this edition we attempt to make the distinction clearer.

It is convenient to distinguish between the two main types of spread F traces though in some cases both may be present simultaneously and one can turn into the other. These are:

- (a) Frequency spread
- (b) Range spread (See also section 2.74)

The former shows spread near the critical frequency, the pattern often showing frequency structure as though a number of normal traces were displaced in frequency and present simultaneously, (see Fig. 2.11 for details). [B. IIA 4 Sept; IIB 4 all; IIA 18 June; IIA 19 June; IIA 22 Dec; IIA 34 Sept; IIA 35 Sept; IIA 40 Sept; IIA 53 June; IIB 6 all; IIB 14 Dec. First and last 3 ionograms of III 20]. The latter shows little or no height variation with frequency, but often structure in height; in extreme cases it may look like a horizontal band across the ionogram, (see Fig. 2.14 for details). [B. Sequence III 19; IIA 41 Sept. Syowa; IIB 41. June Syowa; IIA 10 Sept; IIA 17 Dec; IIA 59 June; IIA 72 Dec; IIA 74 Dec; IIA 82 Sept; IIA 83 June; IIA 85 Dec]. Some examples of combined frequency and range spread are shown in the Atlas. [B. IIA 3 Sept; IIA 4 Dec; IIA 7 June Sept; IIA 8 June; IIB 3 Dec].

Classification of spread F types is considered in section 12.3. See also spread F scaling rules in section 2.8.

2.71. Identification of large scale tilt: Usually large scale tilts take an hour or more to build up at a given station so that a study of the sequence of ionograms is the best way of identifying that these are likely to be present. In practice the time interval between ionograms should not exceed 15 minutes. Large scale tilts usually generate significant changes in the ionograms before and after the tilted section was overhead. When these are seen, the interpretation of the ionograms should be based on the probable presence of large tilts.

The first clear signs of the approach of a tilted structure are:

- (a) The height intervals between higher order traces are altered relative to the interval between ground pulse and first order trace, and the shape of the traces can alter, Fig. 2.7.
- (b) The sudden appearance of satellite traces. If these are seen first on a high order trace and later on the first order large tilts are probable.
- (c) The sudden appearance of range spread traces.

Note: It is possible for a tilted structure to be present near a station but not move overhead. In these cases the pattern shows tilt but does not change greatly with time.

- (d) A rapid change of $h'F$ with time, when accompanied by additional traces or spread F, is also a good indication that significant tilts are present.

The most reliable test for overhead tilt is to compare the virtual heights $h_1, h_2, h_3 \dots$ of the multiple traces. The height intervals $(h_3 - 3h_1), (h_2 - 2h_1)$, etc. show measurable differences when the tilt exceeds about 5° .

The rule is:

If the virtual height interval ground pulse, G, to first order is different from that between the first and second order by more than expected from normal ionograms (see section 2.11) the reflection is not vertical. The pairs of traces for which the error is least identify the mode most nearly vertical and this trace should be analyzed, e.g., Fig. 2.6(b). The interpretation is based on the assumption that large tilts are present, and the rules in this section are used. Unless there is positive evidence of the existence of large tilts, they are assumed absent giving the normal analysis rules.

When multiple reflections are present for either vertical or oblique traces, they should always be used to show whether the trace is oblique or not. It may happen that one of the traces not showing multiples is the vertical trace and it is then useful to know which traces were oblique in the

sequence. In the situation when a trough and a ridge of ionization cross the station, reflections from the sides of the trough are often prominent until the ridge is overhead, when the multiple traces reflected from the ridge suddenly show vertical reflection, $h_2 - 2h_1 = 0$.

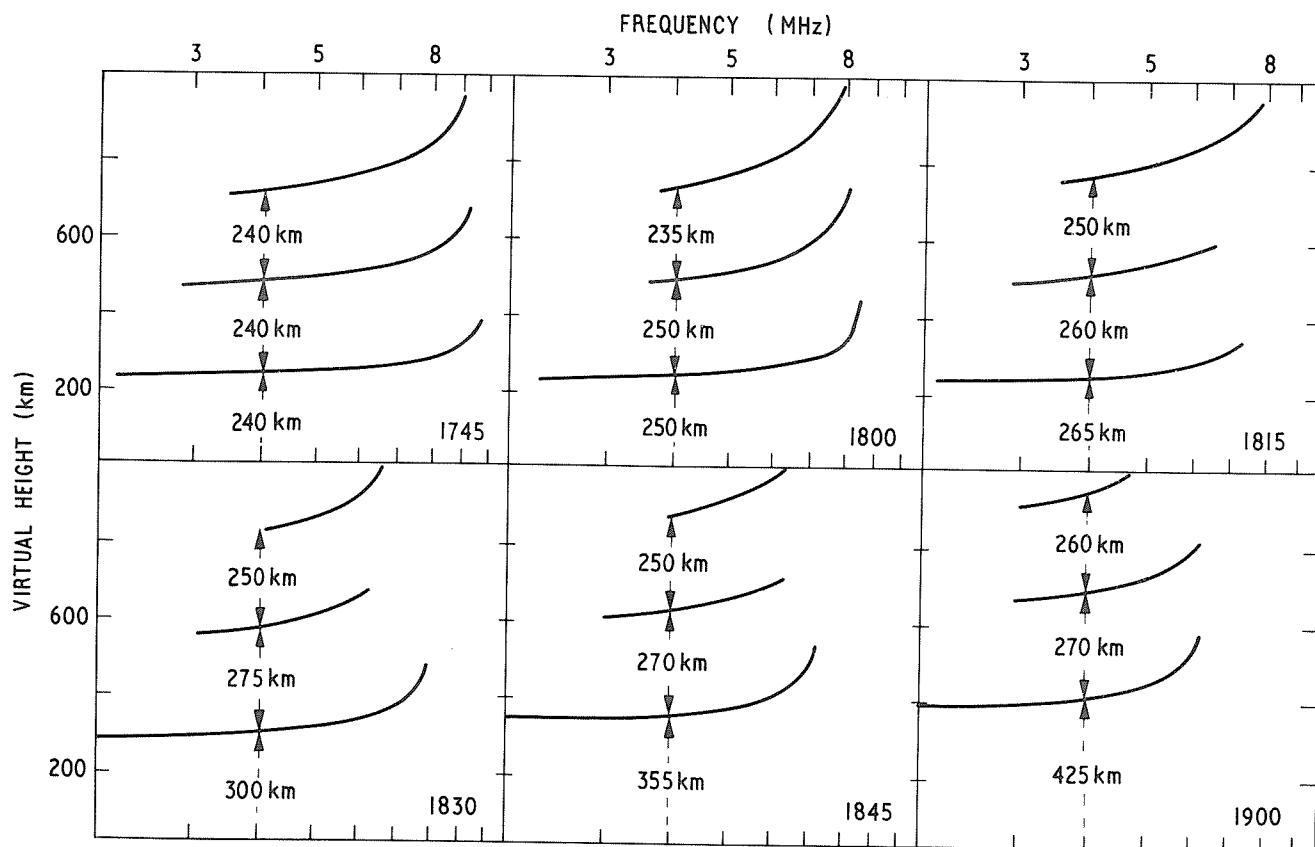

Fig. 2.7 Changes in pattern when large perturbation approaches station.

For this case $hmF2$ is increasing.

1745 Normal

1800 3F trace reflected at oblique incidence, note change of shape near $foF2$.

1815 All traces oblique, note characteristic decrease in curvature near $foF2$ and defocussing near $foF2$ (letter Y preferred but R acceptable).

1830 - 1900 All traces oblique but first order reflected from plane stratified tilted layer similar to Fig. 2.5(b) as is shown by shape becoming near normal.

Note: Only o-mode traces have been reproduced in this figure.

The sequence of events during severe tilt at a given station often tends to repeat from day to day, though not necessarily at the same speed or at the same time. Complex patterns can often be interpreted uniquely using several sequences.

When the critical frequency values given by the second order trace differ significantly (accuracy limits for U or more) from those given by the first order trace, large scale tilt is present (the converse of this rule is not always true).

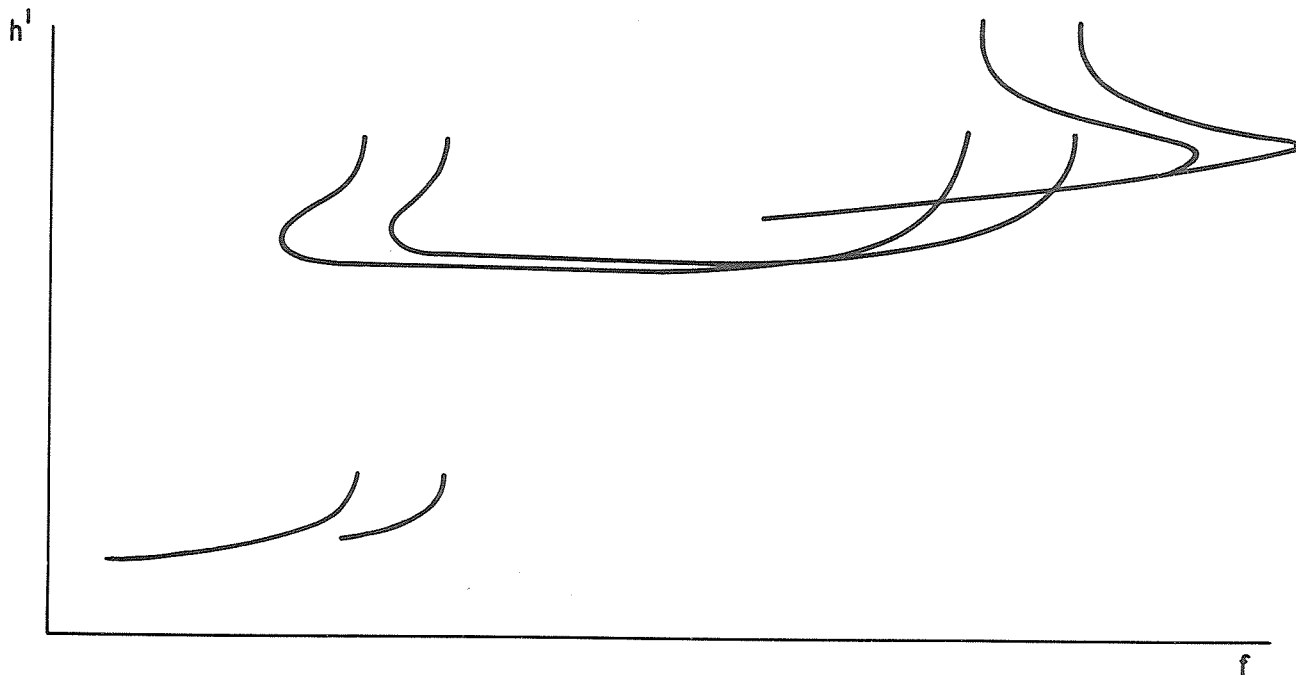

Fig. 2.8 Characteristic traces when tilts are large.

Patterns of the types shown indicate large tilts in the lower parts of the ionosphere. They can occur on any normal trace or on polar spurs.

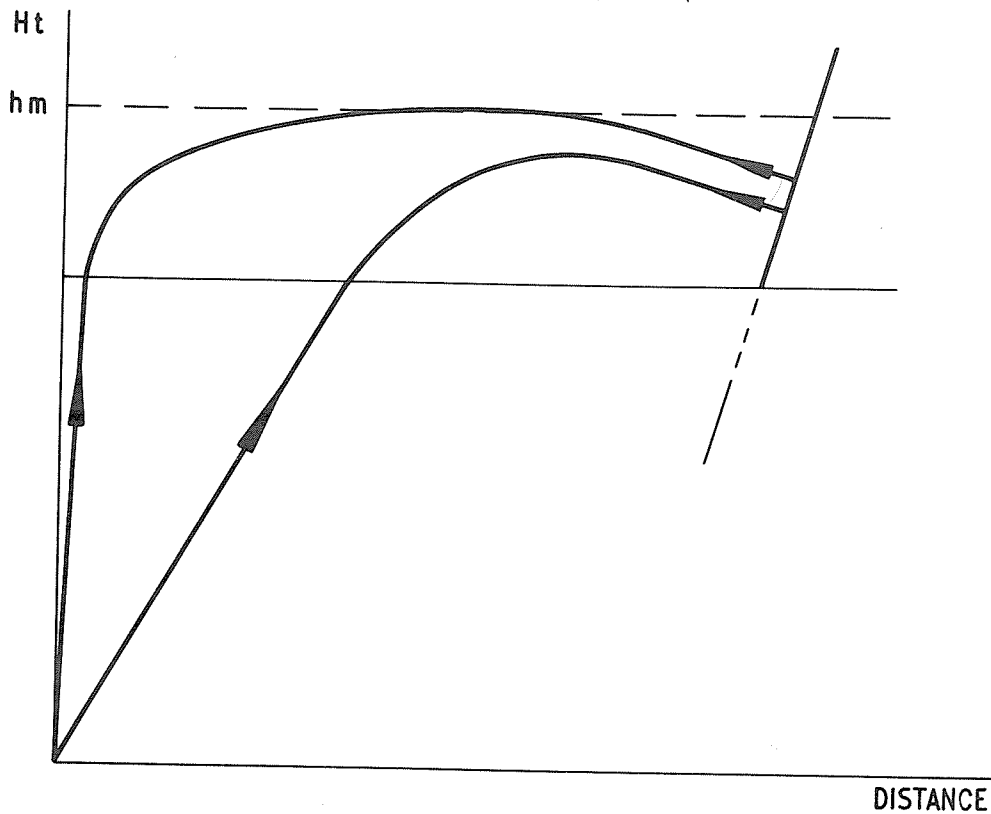

Fig. 2.9 Ray paths reflected from a field aligned irregularity showing high and low angle modes.

Always test that the development of the critical frequency in time, and the changes in virtual height with time, are consistent with the interpretation adopted. Thus, an abnormally large and rapid change in height would be inconsistent with no tilt even if the criteria given above were not seen.

Tilts in the lower ionosphere often show as oblique type traces (Fig. 2.8) for the upper layers. Field aligned reflection can give the same type of pattern when the rays are bent in a normal layer to be perpendicular to the irregularities (Fig. 2.9).

2.72. Normal interpretation - tilts small: The normal rules apply to the interpretation when travelling disturbances, diurnal changes, or similar phenomena cause only slight tilt effects, and to spread F patterns seen when tilt of the main layer is probably small.

Tilts and irregularities can modify the interpretation of the traces for any layer but are most common and most important when modifying F-layer characteristics. The rules are given for the determination of foF_2 , $M(3000)F_2$ and $h'F_2$; analogous rules apply to the parameters for other thick layers. For the interpretation of letter symbols see Chapter 3, for f plot symbols see Chapter 6. Tilts and irregularities modifying Es characteristics are considered in Chapter 4. They are important in generating Es types a, r and s.

When tilts are small, oblique reflections will give traces at greater virtual heights than those for the near vertical reflection. Also denser clouds of ionization which are not overhead can give reflections on frequencies above the critical frequency. Analysis shows that such reflections give traces which have a different shape from normal reflections, Fig. 2.10.

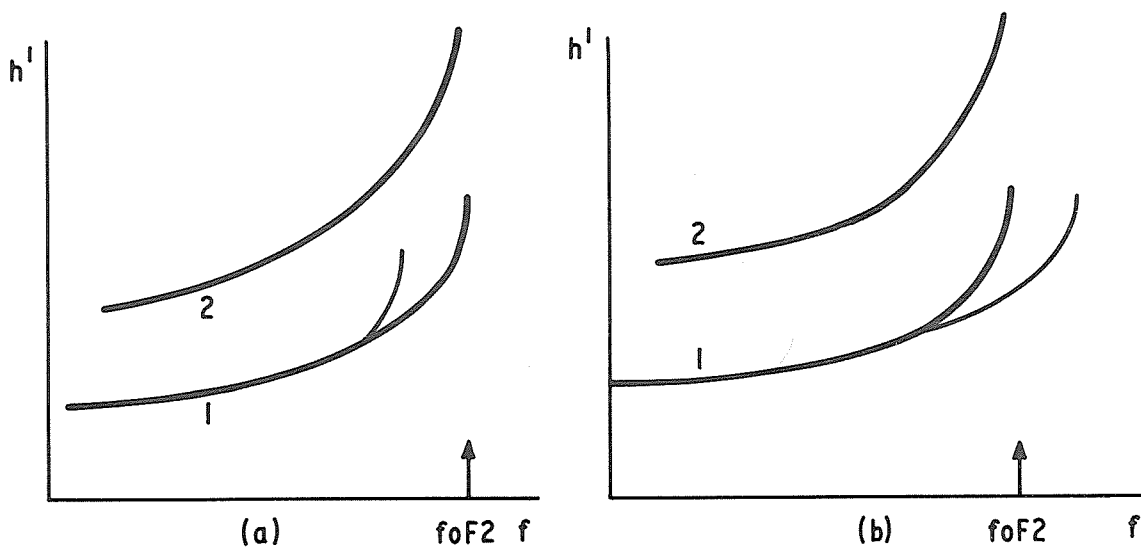

Fig. 2.10 Reflection from a cloud, o mode only

- (a) Electron density (N) in cloud less than N in layer.
 (b) Electron density (N) in cloud greater than N in layer.

1 - First order trace, 2 - second order trace.

o mode only shown in this figure. x trace often helps distinguish principal trace using $fxF_2 - foF_2 = fB/2$. Principal traces are normally more solid than those from clouds.

Any small gradients causing the average ionization density to be greater at oblique incidence will tend to give traces similar to the normal trace but displaced towards higher frequencies. For these conditions:

- (a) The trace with the lowest virtual height is most likely to be overhead.
 (b) The strongest trace is most likely to be overhead.
 (c) The inner edge of the spread F pattern (Fig. 2.11) is most likely to give the best value of foF_2 and $M(3000)F_2$ in the presence of spread, provided allowance is made for pulse width as in Fig. 3.14.

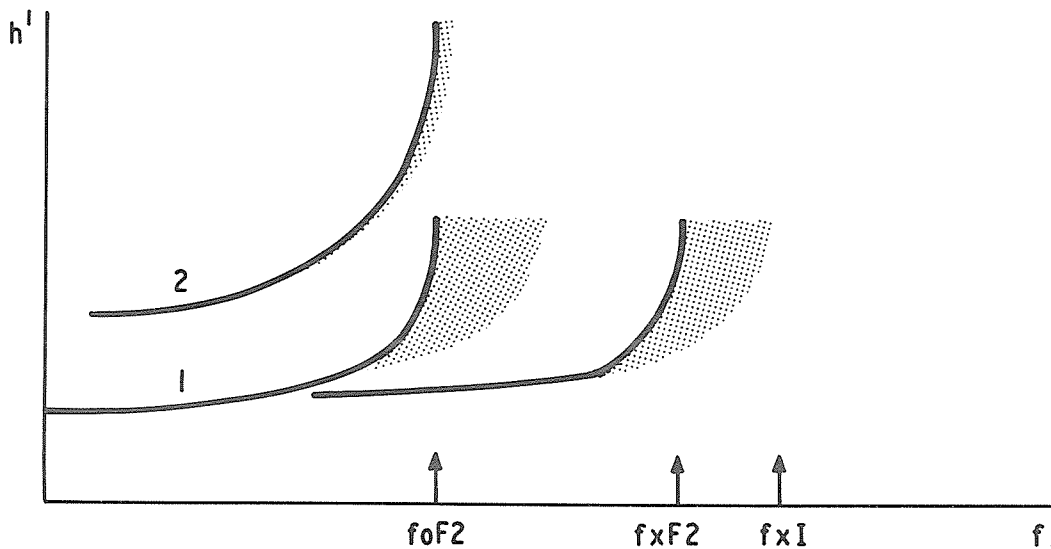

Fig. 2.11 Frequency spread

- Note: (I) Second order trace twice height of first order
 (II) Main trace clearer on second order
 (III) Inner edge strong and clear
 $fxF2 - foF2 = fB/2$
 $foF2$ given by inner edge of trace

(d) The strongest traces in the multiple reflections are most likely to be overhead (check height intervals).

When range spread is present (a) takes precedence over (b) unless the lowest trace is weak or scattered.

(e) The critical frequency can be deduced from the second order trace.

These criteria should be used to confirm each other whenever possible. Note that parameters deduced using (c), the inner edge, should always be regarded as uncertain (qualifying letter U) for interpretation reasons. However, when two multiples are present in spread F conditions and give consistent values of $foF2$ within the accuracy rule limits, the value can be regarded as certain although not measurable on the first order trace.

A common cause of small tilts is the presence of travelling ionospheric disturbances. A travelling ionospheric disturbance (TID) is the name attributed to a pressure wave which propagates in the ionosphere. These can occur at any latitude at any time, but their effects on the ionogram are most obvious during daylight particularly when F1 is present.

Figure 2.12 illustrates the sequence of events produced by a TID. This first perturbs the upper F region, then F1 and finally E region. Not all the patterns in the sequence are observed as much depends on the vertical velocity component of the pressure wave and the interval between ionograms. For the sake of clarity, only the o-component is shown.

Although the descriptive letter H is most frequently used to denote the presence of a TID, the preferred scaling of each parameter is given in Table 1. Examples arise in which the o and x traces differ greatly and in such cases the appropriate letter is Y. Thus these sequences of ionograms show in time sequence some or all of the following [BIII, 11, 12, 13]:

- (a) a perturbation of $foF2$ and $fxF2$
- (b) a forked trace, V
- (c) a perturbation of $h'F2$
- (d) a perturbation in $foF1$

- (e) formation of a F0.5 transient layer with perturbation in $h'F$
 - (f) high type Es or E2 layer
 - (g) often an increase in f_oE_s and fall in $h'E_s$. Es type changing from h to c or in extreme cases to λ
- (a) and (b) are usually accompanied by significant sideways movement of the wave causing the layer to look thicker. $M(3000)$ and the height of the maximum are altered and are therefore not reliable; use UV or UH.

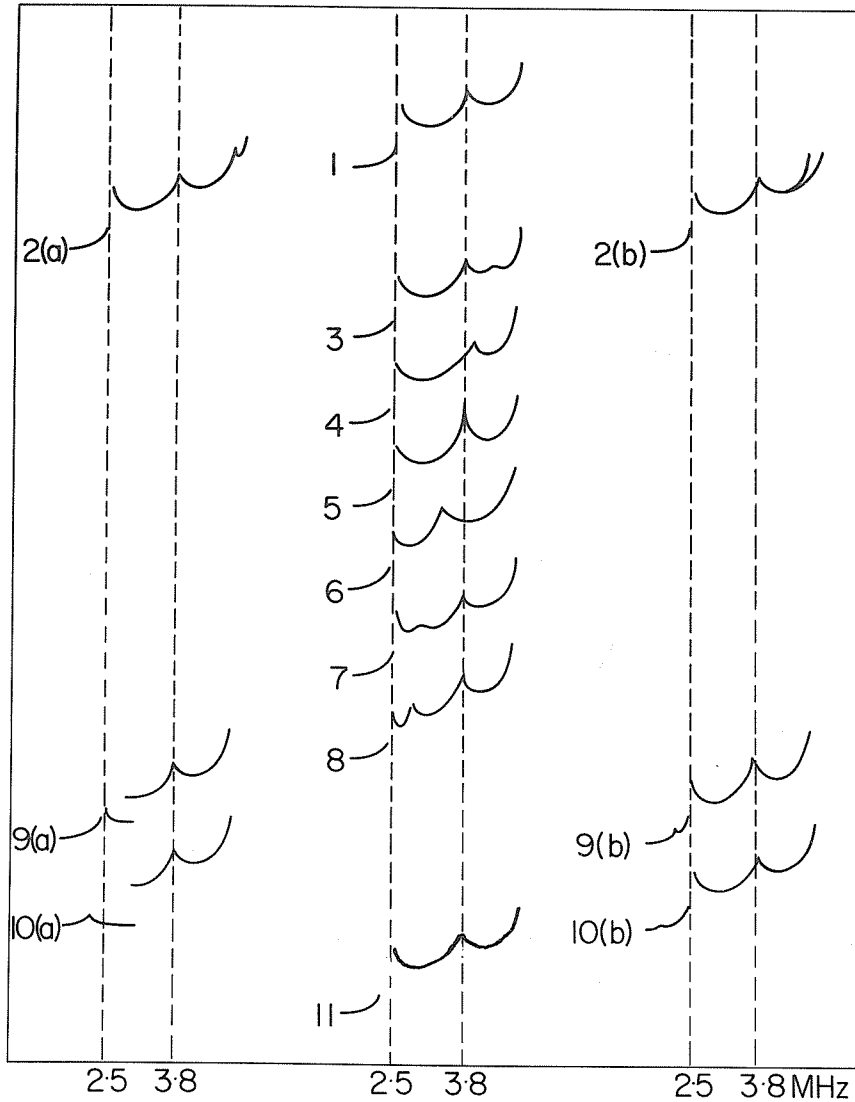

Progression of Travelling Ionospheric Disturbance

Fig. 2.12 Sequence of ionograms showing the progression of a Travelling Ionospheric Disturbance. Columns A and B show possible alternative patterns.

HOURLY NUMERICAL VALUES

Table 1

Preferred Scaling of Ionograms shown in Fig. 2-12

	<u>foF2</u>	<u>h'F2</u>	<u>foF1</u>	<u>h'F</u>	<u>foE</u>	<u>h'E</u>
1	052	350	380	220	250	100
2A	056*H	350	380	220	250	100
2B	056*V	350	380	220	250	100
3	052	350*H	380	220	250	100
4	052	350-H	400*H	220	250	100
5	052	350	380-H	220	250	100
6	052	350	350*H	220	250	100
7	052	350	380	220*H	250	100
8	052	350	380	260*H	250	100
9A	052	350	380	220*A	250-A	100
9B	052	350	380	220	250-A	100
10A	052	350	380	220*A	250*A	100
10B	052	350	380	220	250	100*H
11	052	350	380	220	250	100

* Indicates that use of qualifying letter may be necessary.

When the tilt is mainly East-West the o- and x-mode traces are modified in a similar way; when mainly North-South the shapes of the traces are dissimilar or displaced in frequency relative to their normal separation. Some typical examples are shown in Fig. 2.13. It should be remembered that mixed and intermediate cases also occur. The separation of critical frequencies $f_{xF2} - f_{oF2}$, $f_{xF1} - f_{oF1}$, or $f_{xE} - f_{oE}$ is a very sensitive index for changes in critical frequency along the magnetic meridian. Tilts in the region near h_mE can give patterns which can be confused with the effects of stratification in the same zone. The characteristic differences are contrasted in Fig. 2.14 (a)(b)(c)(d) tilt effects and (e) stratification effects.

At any frequency the oblique incidence reflections may appear either above or below the vertical incidence trace. The former is more common as the apparent virtual height for a constant real height of reflection will increase with the secant of the angle of incidence.

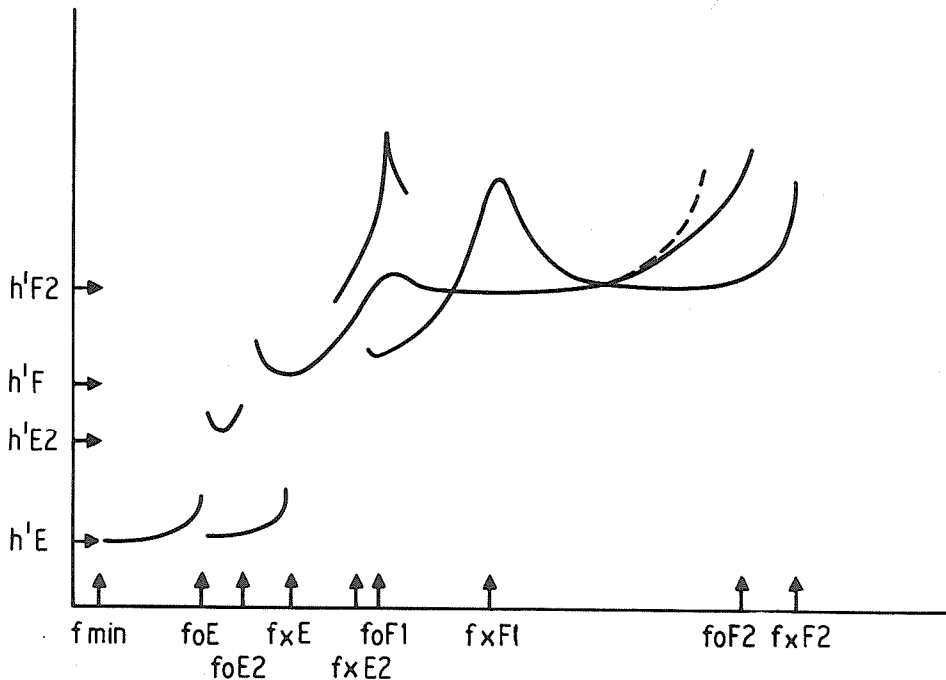

Fig. 2.13 North-South tilts showing distortion of traces

Caption Fig. 2.13.

Typical effects at different levels have been combine--usually only one or two will be seen on any given ionogram. E trace normal.

$f_x E2 - f_o E2 = fB/2$.

F1 o and x traces dissimilar

F2 satellite trace present

F2 o and x traces dissimilar

F2 o trace showing strong tilt distortion (normal trace shown on dashed line)

Interpretation: (see Chapter 3, characteristic enclosed in parentheses means apparent value of the parameter.)

f_{min} , $f_o E$ normal

For $f_o F1$. Measure ($f_o F1$, $(f_x F1 - fB/2)$ and satellite trace and tabulate (average value) UH

For $f_o F2$. As x trace apparently not badly distorted tabulate $(f_x F2 - fB/2)$

JH (if x trace badly distorted tabulate $(f_o F2)$ EY).

$h'E$ normal

$h'E2$ tabulated if needed for local or regional purposes ($h'E2$) UH

$h'F$ tabulated ($h'F$) UH

$h'F2$. Check second order, if this agrees use ($h'F2$), if not or if satellite present and no second order tabulate ($h'F2$) UH

2.73. Interpretation when large tilts are present: At high and low latitudes large tilts sometimes exceeding 45° can be quite common at certain times of day. For these conditions the normal rules, section 2.72, can be highly misleading. For example rapid changes in $hmF2$ with position can cause oblique traces to have lower virtual heights than the vertical incidence trace, and curvature of the reflecting surfaces can cause these traces to be much stronger than the most nearly vertical trace. Such conditions are often accompanied by field-aligned irregularities which can give range and frequency spread which also do not obey the normal rules. Thus, the main problem is to identify the near vertical trace in the presence of other, often stronger and lower traces with or without the aid of multiple reflections. Many examples have been given by G. G. Bowman and G. A. M. King (Planet Space Sci., 1969, 71, 777-796; Aust. J. of Physics, 1968, 21, 695-714). These and other examples were collected in a High Latitude Supplement to this Handbook published as UAG-50.

The most useful tool is usually the sequence of ionograms, the significant properties of the most nearly vertical reflection trace being:

- (a) that the height is varying regularly with time over periods of the order of an hour.
- (b) that the critical frequency is varying regularly with time.

Note: Changes in height or critical frequency of the near vertical trace can often be used to predict the most probable position of this trace on the next ionogram whereas the oblique traces tend to show more irregular appearance and disappearance.

Special difficulties can arise at sunrise when rules (a) (b) can break down. The new F layer can be formed at a different height from that of the residual night layer, and the E and F1 layers are first formed at great heights and rapidly move down to their normal positions. An F-layer sequence near sunrise will be found in the Atlas [BIII p23]. The best way to learn to interpret sunrise ionograms is to make some sample sequences at short intervals, preferably every five minutes. The phenomena change with season and with the latitude and longitude of the station. For these periods, f plots can be very helpful in deciding on the correct interpretation.

When $hmF2$ is not varying much with position, the critical frequencies for the higher order traces usually show systematic shifts relative to those for the first order trace. This is often accompanied by excess range spread for these traces (the normal range spread for an nth order trace is n times or less the spread for the first order trace). [BIII 23 first 6 frames; BIII 24].

The interpretation of some of these patterns by the use of aircraft is discussed, with examples in section 11.6 p 260-270. These patterns should correspond with those given in the Handbook Supplement on High Latitude Ionograms, Report UAG-50.

2.74. Range spreading: Range spreading, Fig. 2.15, is often associated with the presence of field-aligned structures. When these are present the surfaces of constant ionization are corrugated approximately along and perpendicular to the field, Fig. 2.16. The type of pattern produced depends on whether the difference in electron density in the field-aligned structures is large or small compared with the ambient electron density. In the former case the structures act as reflectors, often to frequencies high compared with the local critical frequency. Some typical computed traces, (after Bowman, Aust. J. of Physics, 1968, 21, 695-714) are shown in Fig. 2.17.

HOURLY NUMERICAL VALUES

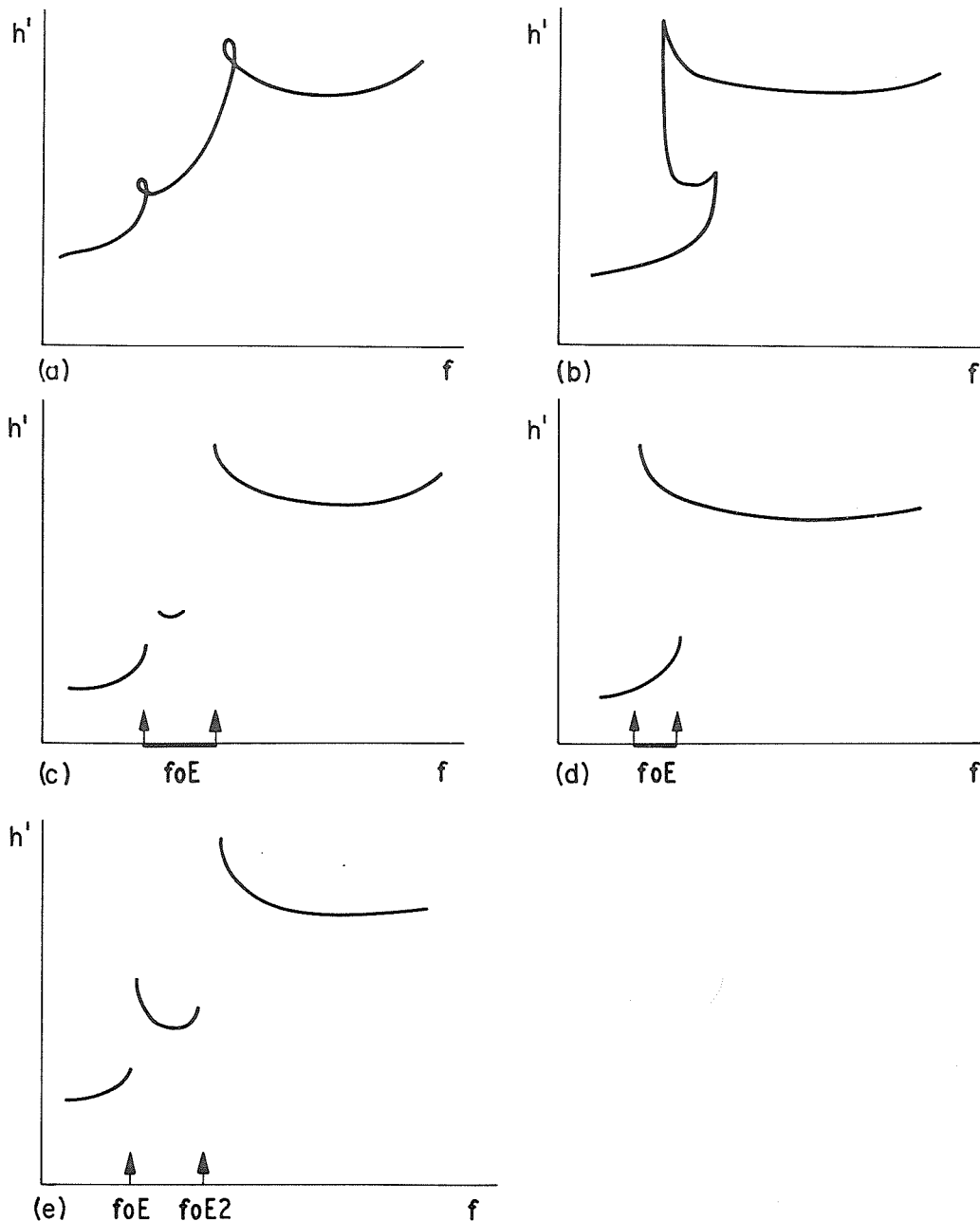

Fig. 2.14 Distinction between effects of layer tilt and intermediate thick E layer
 (a)(b) The critical forms of o- or x-mode traces when tilts are present near hmE .
 (c)(d) Traces after allowing for focus phenomena.
 (e) Thick E2 layer.

Note: Strong trace due to positive focusing at frequencies just above foE in case (e),
 weak trace due to negative focusing in cases (c) (d).

The interpretation of foE in (c) (d) depends on the uncertainty shown by the bar relative to the limits given by the accuracy rules. As this increases we have

- (i) (mean value of foE)
- (ii) (mean value of foE) UH
- (iii) case (c) (lowest value of foE) DH
- (iv) case (d) (highest value of foE) EH
- (v) replacement letter H

The intermediate trace in case (c) may be missing.

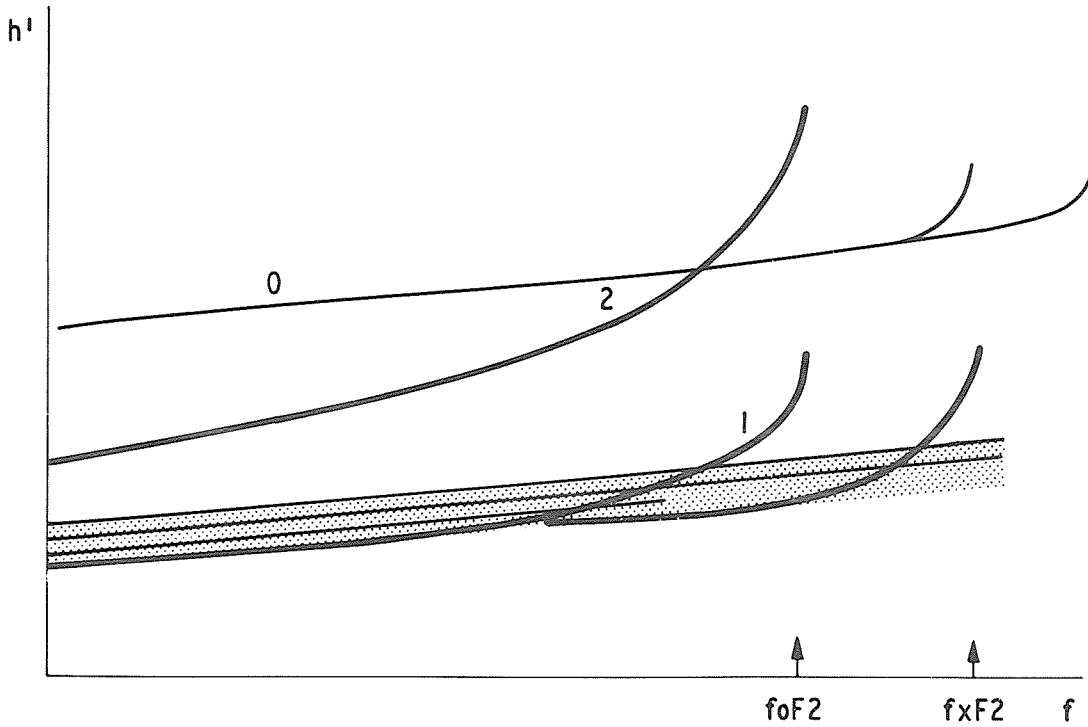

Fig. 2.15 Range spreading

- Note:
- (i) Second order at twice height of first order except possibly near foF2.
 - (ii) When trace similar to 0 present, strong tilt likely to develop. (0 can be above or below 2F trace).
 - (iii) Range spread indicated by dotted structure and satellite traces. The latter may be absent.

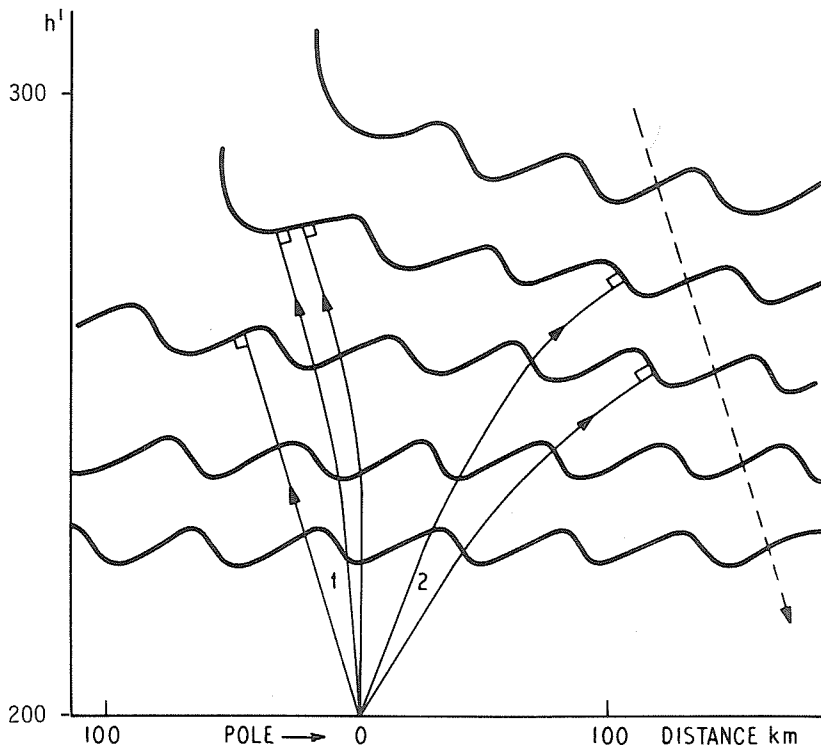

Fig. 2.16 Reflection from irregular ionosphere

Note: Electron density increasing towards pole.

HOURLY NUMERICAL VALUES

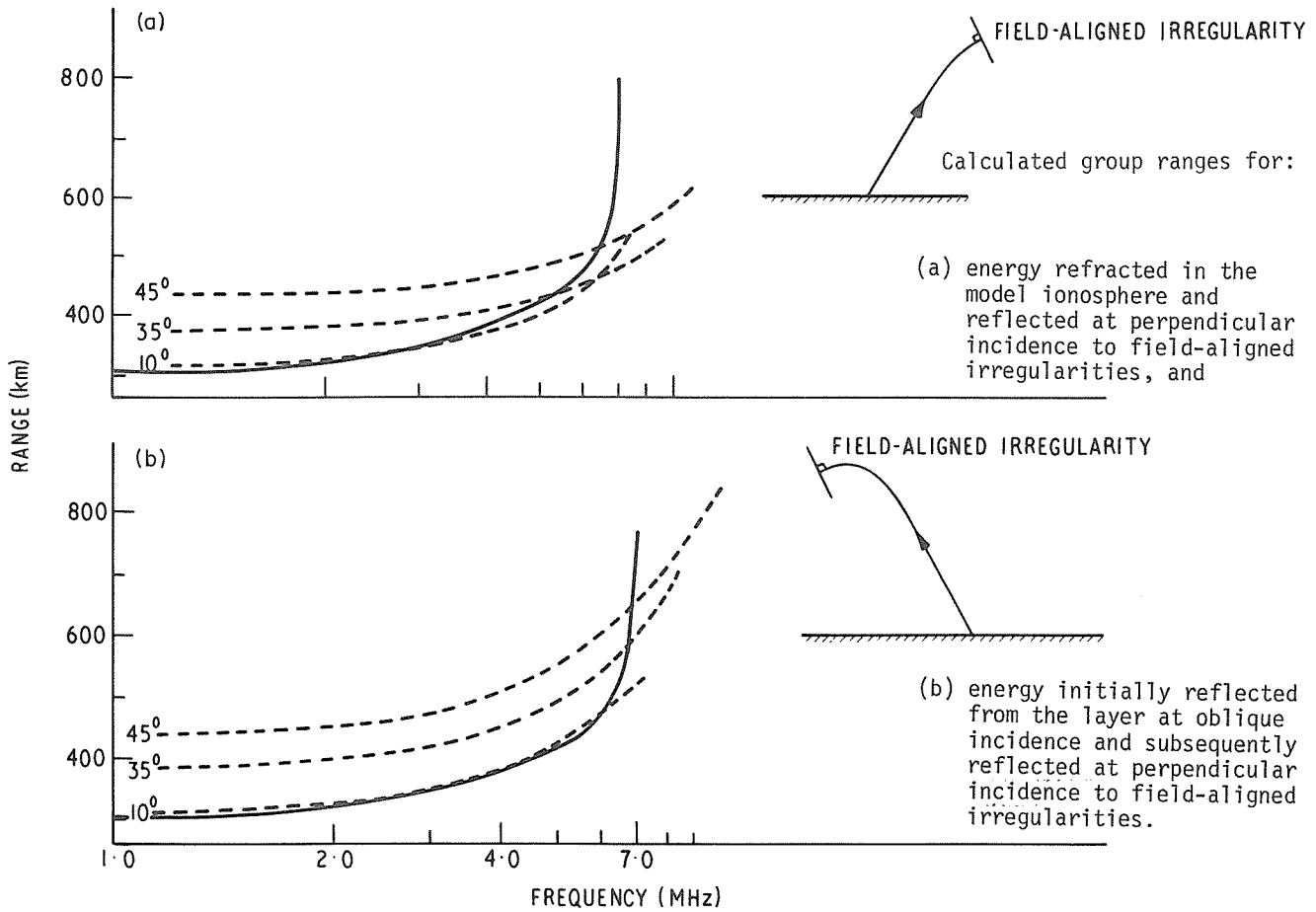

Fig. 2.17

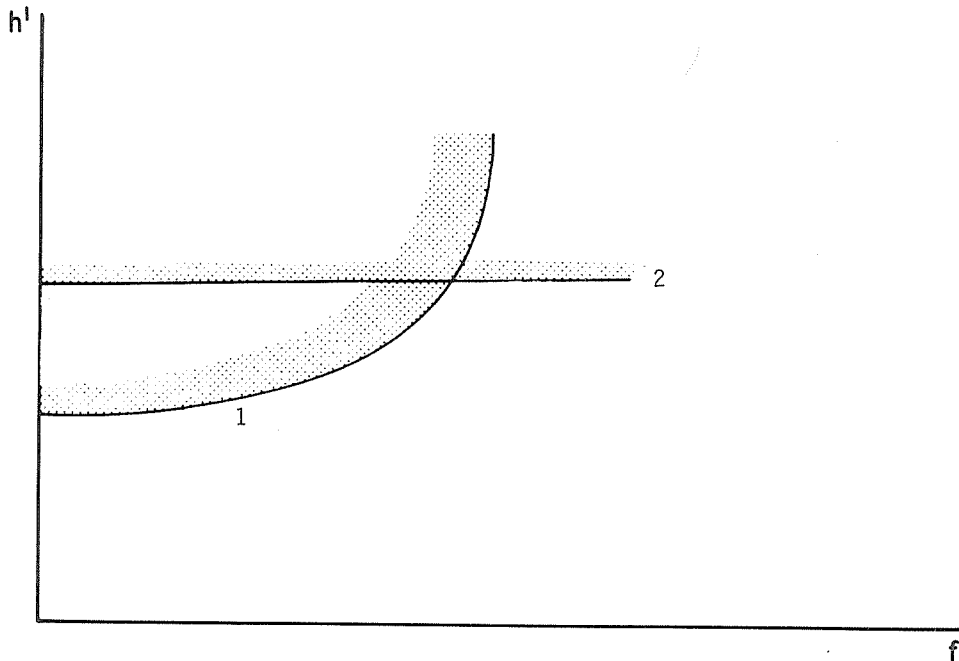

Fig. 2.18 Traces reflected in mode 1 (parallel to field) and mode 2 (perpendicular to field) in Fig. 2.15.

When the perturbations due to the field-aligned structure are small as in Fig. 2.16, the layer approximates to two tilted layers present simultaneously. Usually the electron density is varying with distance in the magnetic meridian in these cases and two families of traces are generated.

- Group 1. Traces reflected from the direction along the field. This gives a family of traces similar to the normal trace but with the critical frequency decreasing when the electron density decreases towards the magnetic pole, increasing when it increases in this direction.
- Group 2. Traces reflected from the direction transverse to the field (often from field-aligned irregularities dense compared with the ambient density).

The former show simultaneous range and frequency spread, the most nearly vertical trace often showing the largest critical frequency (the opposite to the normal small tilt condition), Fig. 2.18. The latter show range spread, usually with little or no retardation at the higher frequencies.

It should be noted that the relative strengths of the o and x traces are often abnormal in these cases and one or other may be missing.

Particle generated layers at high latitudes often show widely different critical frequencies from normal and are usually first seen as a range spread trace superimposed on the normal ionogram. To facilitate study of these phenomena their presence should be indicated by descriptive letter Q.

2.75. Lacuna phenomena. Under certain circumstances, the traces on ionograms which are reflected from a certain range of true height disappear although the remaining traces show that the absorption is either normal or only slightly increased. The name Lacuna (lacune in French) has been proposed for this phenomenon, Lacuna being the Latin word for "gap". When the equipment sensitivity is high or the phenomenon weak, it is possible to see weak reflections spread in frequency and height over part or all of the range where the normal traces have disappeared. Lacuna are most often seen during daytime in summer months.

The immediate cause of the loss of trace is a change in the mechanism of reflection so that the normal strong reflected wave is replaced by an extremely weak incoherent reflection from the same height. This is believed to be due to the presence of strong plasma instabilities in the layer, probably associated with the local ion-acoustic waves. The trace disappears suddenly when the height of reflection first reaches the anomalous zone and normal reflections appear suddenly when the height of reflection reaches the top of the zone. Thus when Lacuna starts a portion of the ionogram traces suddenly disappears. The zone affected most frequently starts in the normal E layer and extends to the height of maximum of the F1 layer--the F1 Lacuna. Sometimes the whole F1 layer is affected--total Lacuna, and it is clear that the phenomena can sometimes effect the F2 layer alone--F2 Lacuna. The immediate cause is the same in all three cases but it is likely that the generating physical forces are different for F2 and F1 Lacuna.

At stations where Lacuna phenomena are common, experts have little difficulty in recognizing F2 Lacuna and distinguishing it from the G condition (f_oF2 less than f_oF1), the main criterion being that the time variation of f_oF2 is normal, the trace suddenly disappearing without change in f_oF2 , whereas for a G condition, f_oF2 decreases to below f_oF1 and eventually reappears and increases relative to it. Where F2 Lacuna is uncommon, e.g., only seen in exceptionally active magnetic storms, unskilled staff should ignore the possibility that it can occur. The original INAG rules did not allow for F2 Lacuna as the distinction is difficult where Lacuna are rare.

Lacuna appears to be closely associated with activity along the auroral oval and is also found at the magnetic poles. It may therefore prove to be a useful tool for studying activity in these zones. It is also closely associated with slant Es seen at high latitudes and has been discussed under the title Slant E condition (J. K. Olesen, AGARD CP97, 1972, pp. 22.1-27.19, NATO Paris; INAG 12, p. 14-19).

The distinguishing feature of Lacuna is that the amplitude of signals reflected from a certain range of heights is abnormally small, whereas outside this range the traces are consistent with the presence of normal or slightly enhanced absorption. In contrast an increase in absorption would cause f_{min} to increase, the x-mode traces to weaken relative to the o-mode traces and the multiple traces to weaken or disappear, these effects being greatest at the lowest frequencies and least at the highest. Lacuna often extends too close to f_oE and f_oF1 . In these cases the trace suddenly disappears or reappears as the frequency changes. If the phenomenon were due to absorption, it would gradually weaken or reappear over a band of frequencies. The detailed rules for analyzing Lacuna are given in Chapter 3, letter Y. Some examples of all the cases of Lacuna seen at Terre Adelie are shown in Figs. A-F below. The phenomenon is very common at this station and the distinctions Y, G, i.e., whether parameters ought to be present, are solved by comparison with ionograms taken before and after the event. These figures show the preferred interpretation to be used by experts, the rules for nonexperts are given in Chapter 3. For example, there is little difficulty in distinguishing between the very weak Lacuna scatter, Y, and spread F, F, when many examples of both have been compared but the distinction cannot be made reliably at stations where the phenomena are rare.

HOURLY NUMERICAL VALUES

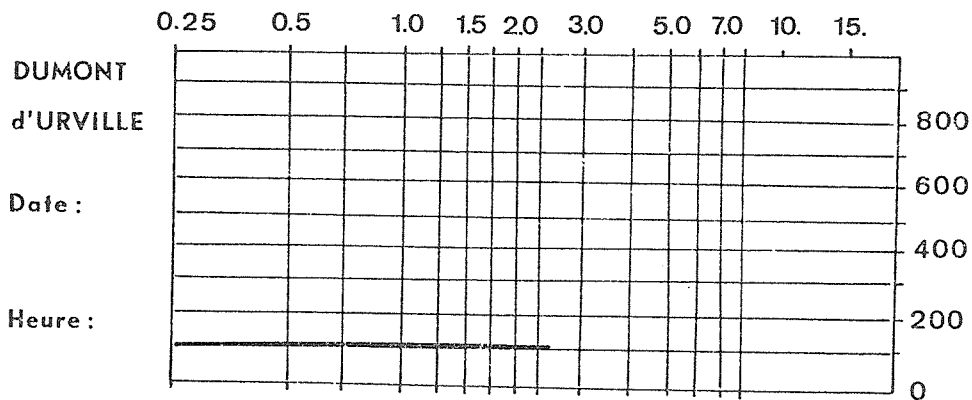

f min	h'E	foE	h'Es	foEs	fb Es	type Es
E		Y	G	G	G	
h'F	foF ₁	M3000F ₁	h'F ₂	foF ₂	M3000F ₂	f _x l
Y	Y	Y	Y	Y	Y	

Fig. A. "Total F Lacuna"

Observations: All F region parameters and foE are replaced by Y.

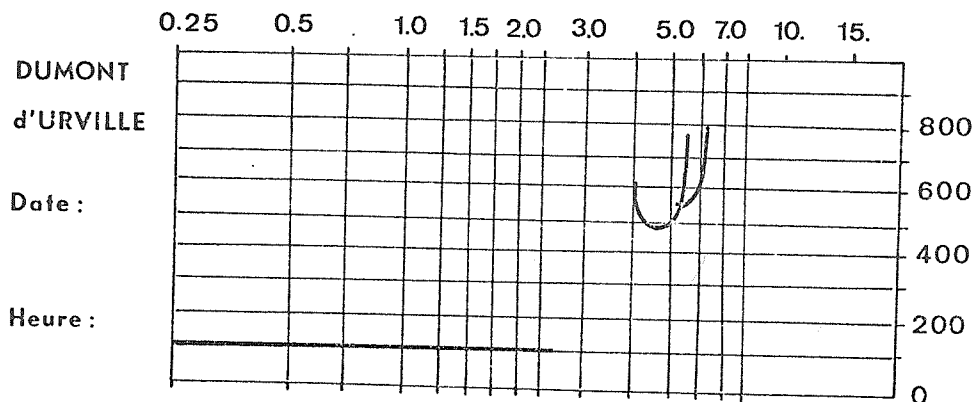

f min	h'E	foE	h'Es	foEs	fb Es	type Es
E	100	Y	G	G	G	
h'F	foF ₁	M3000F ₁	h'F ₂	foF ₂	M3000F ₂	f _x l
Y	U ₄₀ Y	Y	485	56	245	

Fig. B. "F1 Lacuna"

Observations: foE, h'F and M3000F₂ are replaced by Y. foF₁ can be deduced from the retardation of the F₂ trace but is doubtful, hence qualify by U and describe by Y.

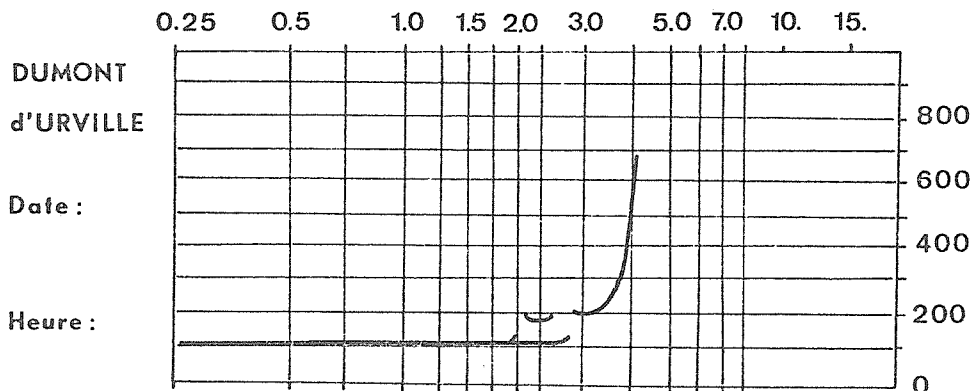

f min	h'E	foE	h'Es	foEs	fb Es	type Es
E	100 ^Z	280	G	G	G	
h'F	foF ₁	M3000F ₁	h'F ₂	foF ₂	M3000F ₂	f _x l
195 ^Z	40 ^Y	350	Y	Y	Y	

Fig. C. "F2 Lacuna"

Observations: All F2 parameters are replaced by Y. It is important to distinguish between the proper use of Y and that of G in this type of pattern. The value of foF1 is described by Y and qualified or not by U depending on the doubt in the reliability of foF1. (Apply accuracy rules and compare with normal patterns for similar time.) If in doubt, use U. Note F1 x trace may be present or absent, as shown here.

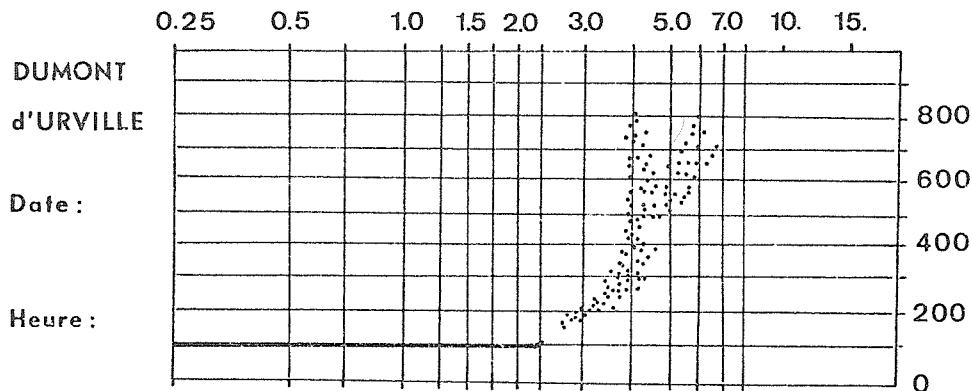

f min	h'E	foE	h'Es	foEs	fb Es	type Es
E		D 225 ^Y	G	G	G	
h'F	foF ₁	M3000F ₁	h'F ₂	foF ₂	M3000F ₂	f _x l
	U40 ^F	Y	Y	U60 ^F	Y	68

Fig. D. "Quasi-total F Lacuna"

Observations: Use of Y and F to indicate weakening (Y) and spread (F) of the traces.

HOURLY NUMERICAL VALUES

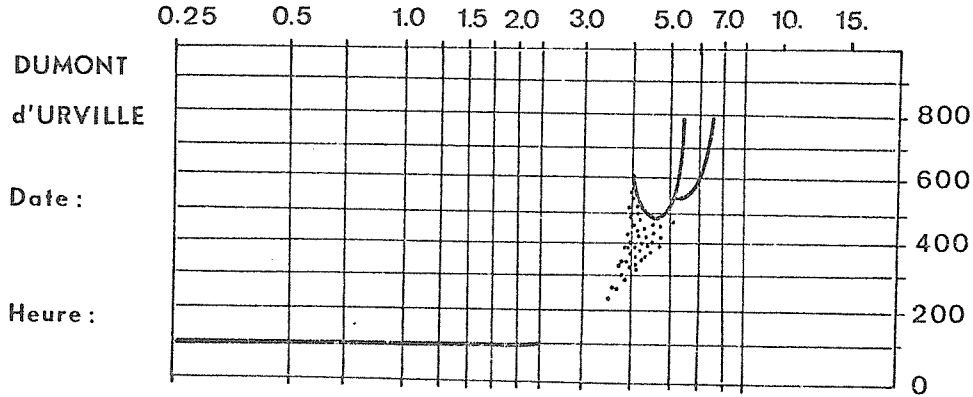

f min	h'E	foE	h'Es	foEs	fb Es	type Es
E	100	Y	G	G	G	
h'F	foF ₁	M3000F ₁	h'F ₂	foF ₂	M3000F ₂	f _x l
Y	u 40 y	F	485	55	240	

Fig. E. "Quasi-F1 Lacuna"

Observations: Note the presence of clean F2 traces makes the identification of partial Lacuna F1 certain. M3000F1 could be replaced by F or by Y, the former is slightly preferable as the immediate cause is the spread, Y could imply no trace present.

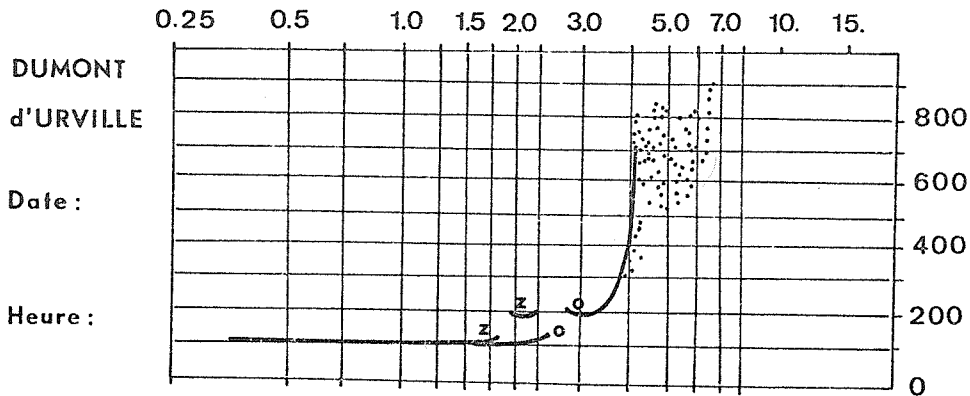

f min	h'E	foE	h'Es	foEs	fb Es	type Es
E	100 ^Z	260	G	G	G	
h'F	foF ₁	M3000F ₁	h'F ₂	foF ₂	M3000F ₂	f _x l
195 ^Z	40 Y	350	Y	Y	F	65

Fig. F. 'Quasi-F2 Lacuna"

Many examples of ionograms showing Lacuna and Slant Es condition will be found in the High Latitude Supplement (e.g., Fig. 2.45, 2.46, 2.51, 3.5, 5.26 and section 12).

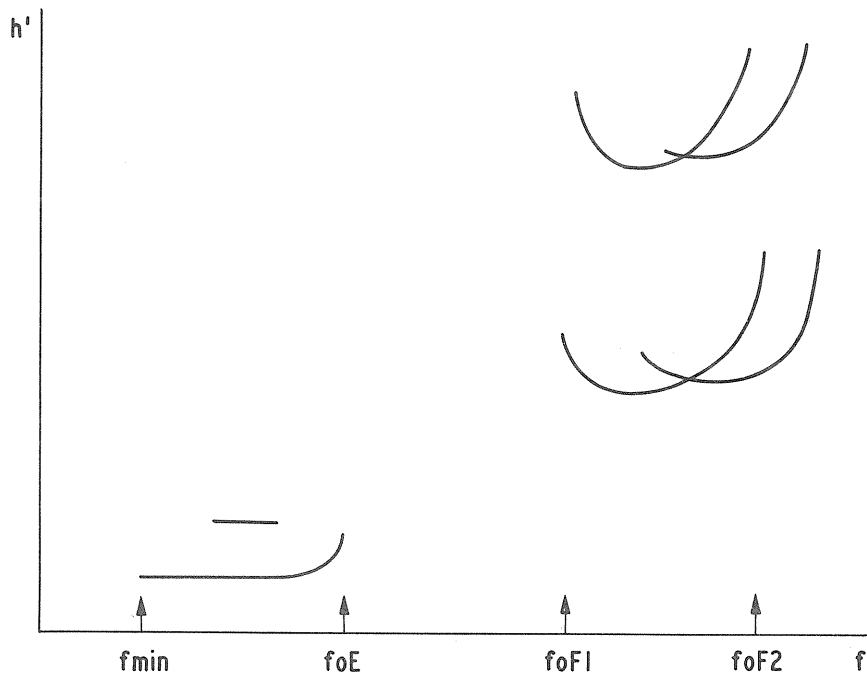

Fig. 2.19(a) F1 Lacuna

- Note:
- (a) f_{min} and multiple traces normal. Therefore not due to abnormal absorption.
 - (b) Sudden appearance of F2 trace. Therefore not due to retardation absorption.
 - (c) Retarded part of E trace usually missing but E trace height normal. This is not Es.
 - (d) A weak diffuse o-mode trace may also be visible over part of the missing F1 trace when sensitivity is high or the lacuna is weak. It is usually strongest near $foF1$.
 - (e) At some stations the second order trace is not seen during Lacuna conditions.

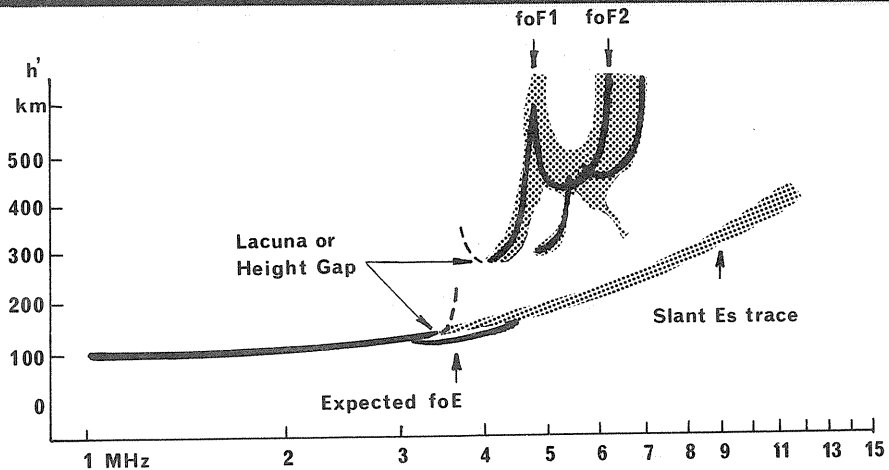
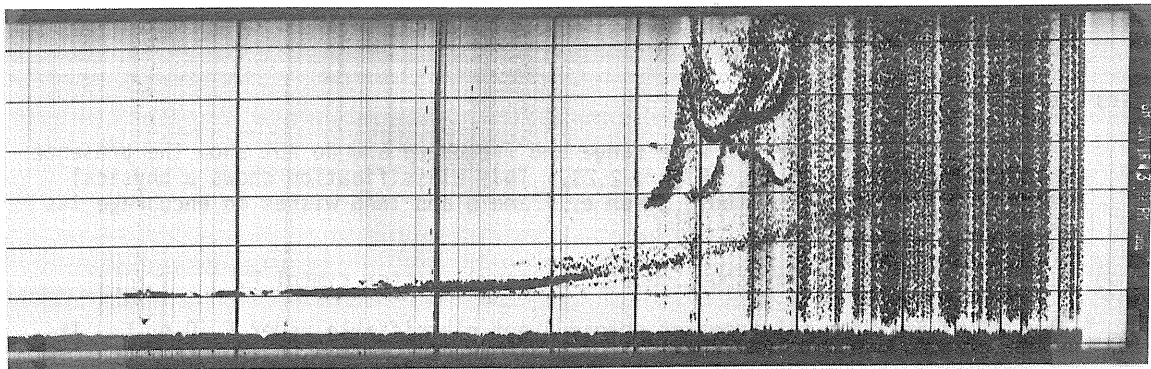

Fig. 2.19(b) Typical daytime ionogram with Slant Es phenomenon at an auroral zone station illustrating the main characteristics: Slant Es trace, Lacuna or Height Gap, F-spreadiness even in low part of F1-trace, and obliques. Narssarssuaq, June 15, 1969 at 1559 hr. LT.

2.8. Spread F types

2.80. Historical: After considerable discussion INAG decided at Lima 1975 to adopt a simplified form of spread F typing and to recommend it for general use. The original proposals in section 12.34 were used as a basis. Many examples of spread F typing are given in the High Latitude Supplement (Report UAG-50).

While all agreed that the ideal solution would be to provide a spread F-type table similar to the Es-type table section 4.8, it was felt that this would cause too much work at stations for general use. INAG recommends that a separate spread F-type table be produced where possible, section 2.82.

In order to obtain widespread use and avoid additional work at the stations a compromise scheme was developed, see sections 2.83, 2.84.

2.81. Definition of spread F types:

- (a) Frequency spread; letter symbol F.

The traces near the critical frequencies are broadened in frequency and may show additional traces similar to a normal critical frequency trace. This is the most common type of spread F at most latitudes, Figure 2.20. Other examples are shown in Figures 2.11, 2.18 trace z, 2.19, 3.8, 3.11, 3.12, 3.14, 3.28, 3.35, 3.39 a,b, 3.40 a,c,d; and for f-plot presentation 6.4, 6.5, 6.6, 6.7, 6.8. Frequency spread from a tilted F layer, Fig. 2.21 is also included in this classification. (See also 6.10e). Letter F should be used whenever the frequency range of the spread exceeds 0.3 MHz.

- (b) Range spread; letter symbol Q.

The traces away from the critical frequency show broadening in range or the presence of satellite traces or both Figure 2.22. Other examples are shown in Figures 2.13, 2.17, 2.18 trace 1, 3.13, 6.10. For uniformity Q is used when the range spread exceeds 30 km in virtual height. When broad pulses are used so that the normal trace is wider than this limit use Q when the additional broadening of the trace exceeds 15 km.

- (c) Mixed spread; letter symbol L.

The traces are broadened in both range and frequency and do not show the presence of distinct F and Q types. Figure 2.23. This classification shows a physical phenomenon distinct from those given by F and Q and INAG wishes to encourage its use on a voluntary basis.

- (d) Spur (historically polar spur, equatorial spur); letter symbol P.

This class includes all types of spread F not classifiable under F, Q or L. It indicates the presence of traces from an oblique reflecting region which usually reflects to a considerably higher frequency than the F layer nearest overhead. When as the structure moves in time it may move overhead in which case the classification changes to F or Q as appropriate. Figure 2.24. Other examples are shown in Figures 3.39 c, 6.10 c,d.

2.82. Rules for use with a spread F type table.

When a spread F type table is made the following rules should be used.

- (a) First entry Spread F type used to give fxI .
 (b) Second entry Spread F type present at expected value of $foF2$.
 (c) Third entry Range spread if present.

Note in most cases fxI is given by a frequency spread trace type F or by a range spread trace from near overhead, type Q, and only one entry is needed.

(d) When L is not used mixed type should be shown by entries of F, Q.

(e) Some possible entries are:

Single entry	F; Q; L.
Double entry	F, Q; P, F; P, L.
Treble entry	P, F, Q; P, L, Q.

(f)* X may be used to show the absence of spread F at times when it would normally be expected in the spread F type table.

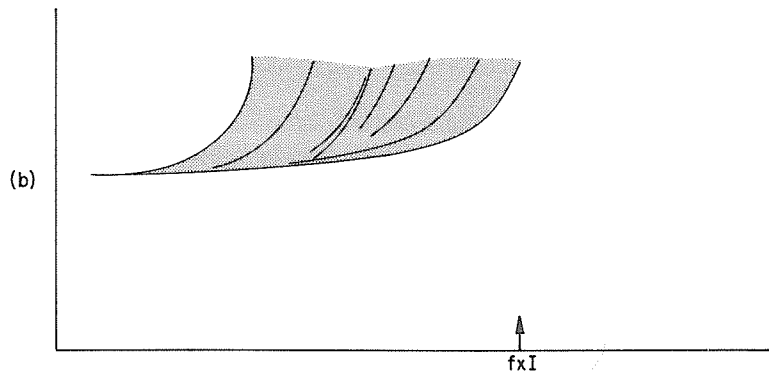
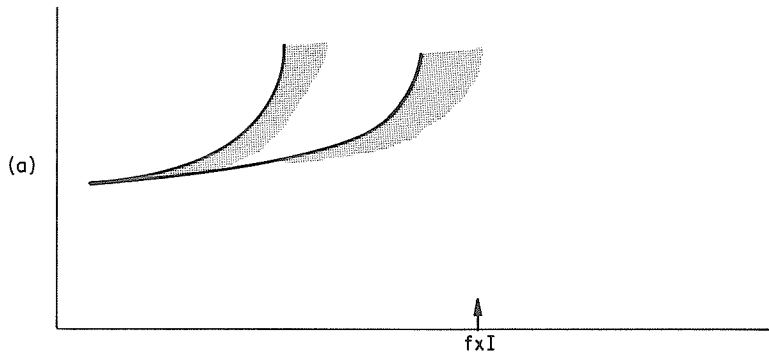

Fig. 2.20 Frequency spread. Type F

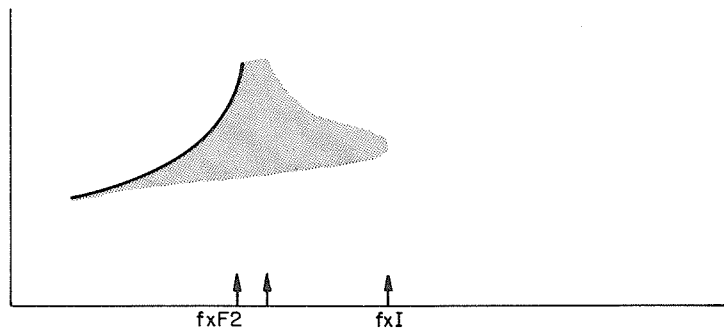

Fig. 2.21. Frequency spread. Type F

Note: In logic fxI should be read at the middle arrow but the standard fxI rule (read the highest frequency of spread visible) is easier and more useful.

HOURLY NUMERICAL VALUES

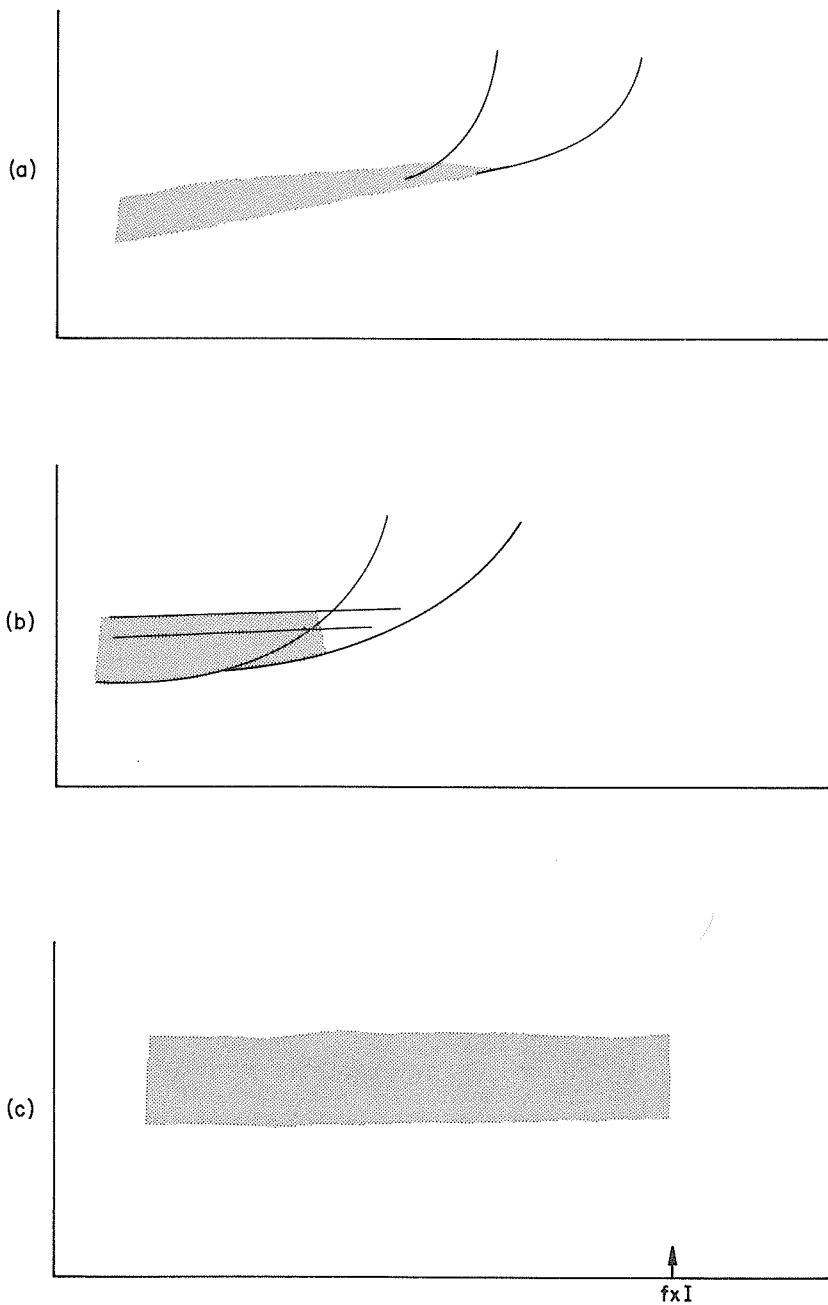

Fig. 2.22 Range spread. Type Q

- (a) Shows an unresolved range spread Q in h'F table.
- (b) Shows resolved range spread Q in h'F table.
- (c) Shows fxI determined by a range spread pattern Q in h'F and fxI (or foF2 table).

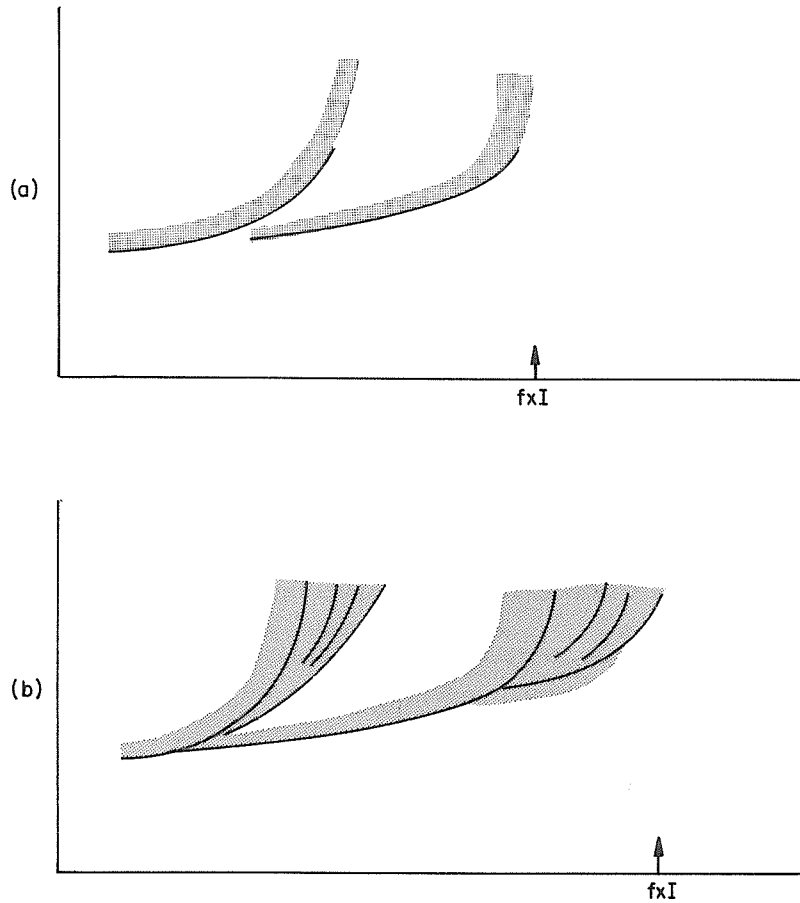

Fig. 2.23 Typical mixed. Type L

Note no structure in horizontal parts of trace. Usually no structure in frequency spread as in (a).

Structured frequency spread (b) superposed on pattern (a): Use F in fxI , L in $h'F$ to give exact description. (Voluntary.)

HOURLY NUMERICAL VALUES

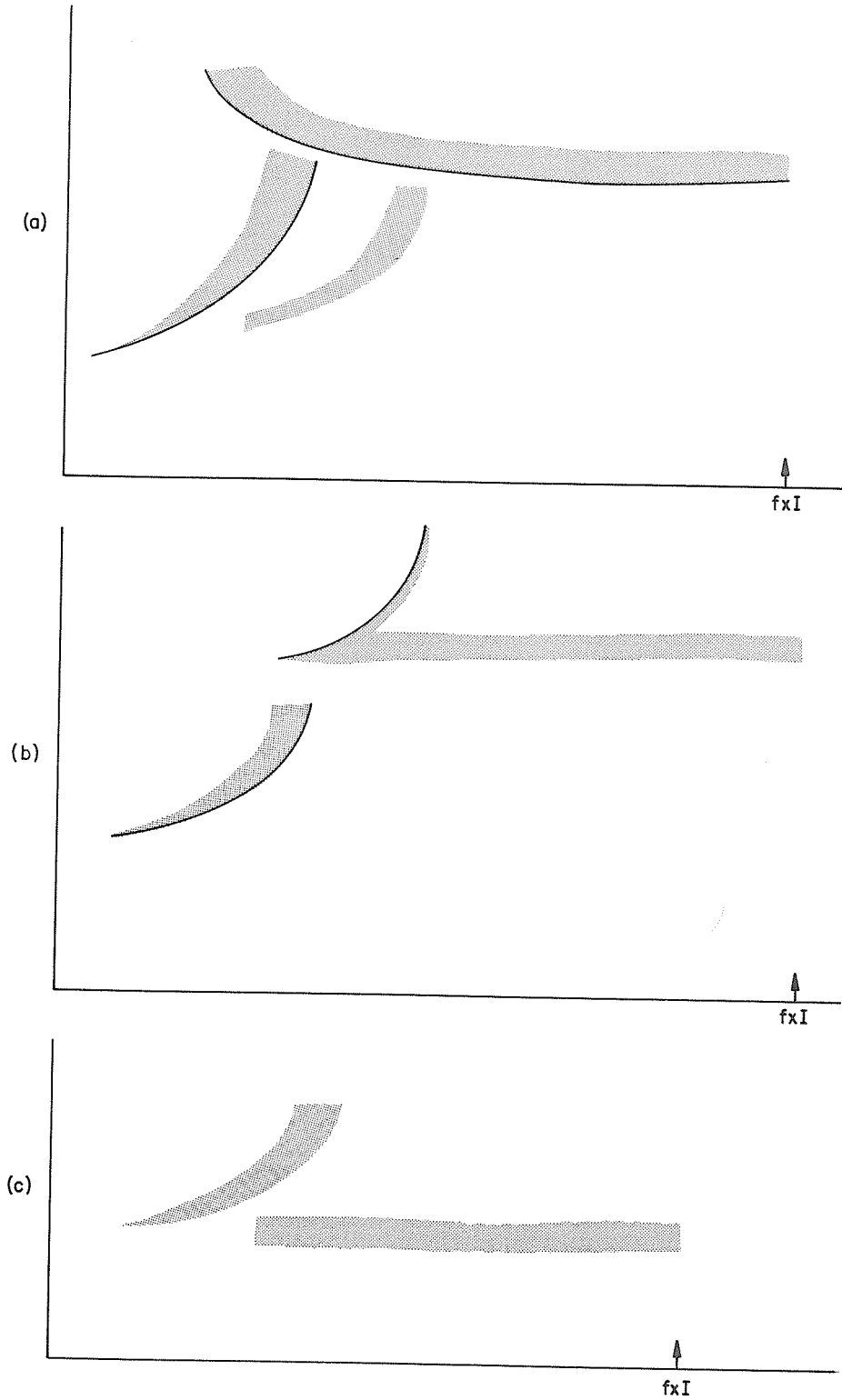

Fig. 2.24 Spur. Type P

Note the P traces may be above or below the main traces and may start at lower or higher frequencies than shown.

2.83. Rules for typing spread F in standard parameter tables.

Where a separate spread F table is not used, spread F types should be shown in the numerical tables using the following rules:

- (a) Descriptive letters representing spread F types F, L, P, Q take priority over other descriptive letters in the tables to which they apply. (See table below.) In the remaining tables, the appropriate descriptive letter is determined by the usual rules (Section 3.2).
- (b) The type of spread F used to evaluate fxI is shown in the fxI table. Absence of spread is shown by descriptive letter X (see fxI rules section 3.3).
- (c) Frequency spread, F, is shown in the foF2 table. If fxI is also given by F and has been tabulated in the fxI table, letter symbols denoting reason for doubt may be used in preference to F in the foF2 table.
- (d) Range spread, Q, is shown in the h'F table.
- (e) When frequency spread or spur are absent and fxI is determined by a range spread trace, Q is used in the fxI table.
- (f) Mixed spread, L, is shown in both h'F and foF2 tables unless structured traces Q or F are also present in which case these take priority in their appropriate tables.
- (g) When L is not used, mixed type traces are shown by F in the foF2 table, Q in the h'F table.

Typical Cases

Present	fxI	foF2	h'F
No spread	X	-	-
Spur, F	P	F	-
F Q	F	(F)	Q
L	L	(L)	L
P F Q	P	F	Q

() without priority.

2.84. Rules when fxI tables are not available.

- (a) Descriptive letters representing spread F types take priority over other descriptive letters in the tables to which they apply only. In the remaining tables, the appropriate descriptive letter is determined by the usual rules (Section 3.2).
- (b) The type of spread F which would be used to evaluate fxI (see fxI rules section 3.3) is denoted by its descriptive letter symbol in the foF2 table (possible symbols F, P, Q or L).
- (c) The presence of range spread is shown in the h'F table (possible symbols Q, L). Note in this case it is impossible to describe fully the ionogram and a priority system has to be used. In this fxI greater than fxF2 is more important than denoting frequency spread.
- (d) Structured traces of types F or Q are always shown in preference to L when superposed.

2.85. Difficulties.

The main difficulty in practice is to distinguish between spur traces and Es-a traces seen at very oblique incidence. When a close sequence is available, e.g. three gain ionograms at the hour, it will be seen that the Es traces vary considerably in a space of a minute whereas spurs change more slowly. Spurs and high Es-a traces tend to occur together so possibly a unique solution is not essential. Spur patterns tend to recur on different nights at similar levels of magnetic activity, showing similar patterns whereas Es-a is less regular.

Certain types of spur appear to identify the movement of the auroral oval over the station (see High Latitude Supplement, Report UAG-50).

3.0 Use of Qualifying and Descriptive Letters

Letters are written exclusively in capital (block) letters. They are grouped into two classes, qualifying and descriptive. The distinction between these classes must always be kept clear and letters must be entered only in the appropriate position on the daily tabulation sheet (qualifying letters in the first letter column, descriptive letters in the second).

The old WWS convention, with qualifying letter before the number and descriptive letter after it, was dropped for general use as it was found to cause trouble when the data were punched for computer use. This convention is convenient for manual work and is allowed where the data also exist in computer form. When letter symbols are printed above the number the convention is that the qualifying letter, if any, is placed above the first figure of the number and the descriptive letter above the third figure.

The letters A, D, E, M, O, T, Z are defined both as qualifying and descriptive letters and the meaning is made clear by the conventional position of the letter on the tabulation sheets.

Wherever doubt arises, the international definitions given under the appropriate letters in sections 3.1, 3.2, or 3.3 should be consulted.

When the data are tabulated by computer methods it is possible to compute the desired characteristic from a measured value for another mode. The International conventions for descriptive letters O and X have been modified to permit this. Thus, a tabulated value (fxEs)-X can then be read by the computer to give (fxEs-fB/2)JA. Similarly for fxI when no scatter is present, a tabulated value (foF2)-0 can be read to give (foF2+fB/2)OX (no scatter but value deduced from 0 trace). It is very undesirable to use these conventions when tabulation is done by hand.

3.1 Qualifying Letters

The qualifying letters give an indication of the reliability of the measurement of a tabulated value. These letters cannot be used to replace a numerical value and must always be accompanied by a numerical value and by a descriptive letter.

Qualifying letters are used for two purposes: as algebraic symbols, and to show that the tabulated value has not been deduced directly from the trace which is normally considered.

When no qualifying letter is used, it is implied that there was no serious difficulty due to interference, noise or instrumental defects in making the measurement; that the interpretation of the ionogram is clear and unambiguous; and that the values tabulated are within the limits of accuracy required for the characteristic.

If no qualifying letter applies, the space provided on the tabulation sheet is filled with a dash (—) or left blank, as may be appropriate to avoid ambiguity and according to the format of the table.

The qualifying letters are: A, D, E, I, J, M, O, T, U, Z. They have the following meanings:

- A - Less than. Used only when fbEs is deduced from foEs because total blanketing of higher layers is present. This must be ignored when computing medians - xxx AA is treated as xxx, i.e. fbEs = foEs. (see section 4.6, p. 119).
- D - Greater than.
- E - Less than.

Letters D, E give maximum or minimum limit values. Such values must be moved to the top (D) or bottom (E) of the distribution when forming the second median (Section 8).

Letter A also implies a less than limit value but this value is expected to be abnormally large and hence should not be moved to the bottom of the distribution when forming the second median. The connotation "less than" is thus ignored in forming the medians.

D and E are used as qualifying letters when only limiting values are observed. Accuracy rules for the use of D and E are given in sections 2.2 and 2.7.

When D and E are used in conjunction with ionosonde limits (descriptive letters D, E, W) or limits due to f_{min} , foE, foF1, descriptive letters B, G, it is essential that the numerical limits should be readily available. Since data are often handled by computer, notes in station booklets can be lost. It is therefore recommended that limit values be written out in full, e.g. xxxEE, unless it is certain that the missing values are easily available. Since median tables are often separated from other data all median values should be written in full whenever a numerical value is available.

QUALIFYING AND DESCRIPTIVE LETTERS

I - Missing value has been replaced by an interpolated value.

Interpolations may be performed over a period not exceeding two hours provided that the sequence of records indicates that conditions are varying slowly. Interpolations should be done from an f plot or a diurnal curve since the characteristic need not vary linearly with time. If the gap in the observations is more than 2 hours, or if the characteristic is not believed to be smoothly and slowly varying, no interpolation is permitted.

Interpolation may not be used to provide a numerical value in the following cases: (1) when the observed value is replaced by D, E, F, G, L, N or W, (2) for any Es parameter, f_{min} for f_{xI} .

Interpolation should be used whenever possible to provide a numerical value when the observed value is replaced by C, R or S. The same is true for B in the case of a SID but not in the case of polar black-out.

J - Ordinary component characteristic deduced from the extraordinary component.

This letter applies only to measurements involving critical frequencies and assumes $f_o = f_x - f_B/2$ or when f_o is near or below f_B the appropriate value of $f_x - f_o$ (section 1.04) [A1121, fig. 138, A114D]. Whenever the letter J is used, the reason for not scaling the ordinary trace must be indicated by the appropriate descriptive letter.

M(3000) may be obtained even when the ordinary critical frequency is deduced from the extraordinary, provided that the point of tangency of the transmission curve and the ordinary trace can be located. M(3000) is scaled using the deduced ordinary critical frequency, but is not qualified by J. The possible error in deducing f_o is normally very small.

M - Mode interpretation uncertain.

This letter is used when there is not enough evidence from the ionogram or sequence of ionograms to show whether the mode was ordinary or extraordinary. It is mainly (but rarely) used with parameters f_{xI} , f_{oF2} , f_{oEs} or f_{xEs} (where tabulated). The reason for the difficulty is given by the most appropriate descriptive letter. The observed value is treated as if the interpretation was correct but M implies a possible error of $f_B/2$ for frequency characteristics and an undefined error in height and factor characteristics.

O - Extraordinary component characteristic deduced from the ordinary component.

This letter applies whenever it is necessary to deduce the extraordinary characteristic from the ordinary wave trace. It can only be used with characteristic frequencies defined for the x trace, in particular f_{xI} and f_{xEs} . f_x is deduced by assuming $f_x = f_o + f_B/2$ or when f_o is near or below f_B the appropriate value of $f_x - f_o$ (section 1.03, p 9).

When the qualifying letter O is used the reason is given by:

- (a) The descriptive letter which best shows why the extraordinary characteristic could not be measured.
- (b) The descriptive letter M, when there is doubt about whether the ordinary or extraordinary characteristic was measured. The characteristic is treated as O.
- (c) The descriptive letter O, when there is no doubt that the ordinary wave characteristic was measured but the reason for the absence of the extraordinary characteristic is complex, doubtful, is near f_B , or the x mode could be seen but was not used (see O under descriptive letters, 3.2).

T - Value determined by a sequence of observations, the actual observation being inconsistent or doubtful.

The letter T is applied only to numerical values obtained by 'smoothing' from the f plot and always shows that the actual ionospheric conditions differ from the representative value given in the table. Its use is mainly confined to high-latitude stations where the actual value may be found from the f plot. T is never used to replace a missing value. In such cases interpolations should be performed if possible. See section 6.9.

U - Uncertain or doubtful numerical value.

A tabulated value may be uncertain because the trace is obscured by interference, noise, instrumental defects, spread echoes, deviative absorption, etc., which make the ionogram difficult to interpret. See section 2.2 for the criteria for use of the letter U.

Z - Measurement deduced from the third magneto-electronic component.

The letter Z, used as a qualifying letter, is analogous to the letter J. It applies only to critical frequencies. Whenever Z is used the reason for not scaling the ordinary trace must be indicated by a descriptive letter. Letter Z is used also as a qualifying letter when the o-mode parameter is deduced from the z trace, e.g., $foF2 = (fzF2 + fB/2)ZF$. This is valuable when there is no main trace or a series of main traces (Fig. 3.35). Note $h'z < h'o < h'x$ so it is not possible to use qualifying Z for height parameters. When fz is near or below fB the appropriate value of fo-fz (p 9) must be used.

Since the z component is reflected obliquely, except at the magnetic dip pole, there is always doubt whether or not conditions have changed with the position, and values based on deductions using this component are regarded as doubtful and are therefore qualified by qualifying letter Z.

M(3000) may be obtained even when the ordinary critical frequency is deduced from the third magneto-electronic component, provided that the point of tangency of the transmission curve and the ordinary trace can be located: M(3000) is scaled using the deduced ordinary critical frequency and is qualified by Z. The qualification is necessary because the z trace is always oblique except at the magnetic dip pole and therefore the deduced ordinary critical frequency is uncertain.

Additional qualifying letters are used in topside soundings and are given in section 5.65.

3.2 Descriptive Letters

Descriptive letters give the main reason for uncertainty in, or absence of, a numerical value or indicate the presence of certain phenomena. Although two descriptive letters may be used when the form provides space for three letter symbols, mechanical methods of analysis can handle only one descriptive letter. Therefore only the first descriptive letter can be recognized as an international parameter and it is most important that this letter be consistent with the rules.

The descriptive letters are: A,B,C,D,E,F,G,H,K,L,M,N,O,P,Q,R,S,T,V,W,X,Y,Z. The following selection rules should be invoked when two letters seem equally applicable:

- (a) Always use the letter which most nearly represents the cause of the difficulty.
- (b) Always use a letter with a restricted meaning in preference to one with a more general meaning. (This particularly applies to the ambiguity between C and S, or between E and G.)

The descriptive letters have the following meanings:

A - Measurement influenced by, or impossible because of, the presence of a lower thin layer, for example, Es. When an Es trace is such that foEs cannot be distinguished and must be deduced from fxEs letter A is used. $foEs = (fxEs - fB/2)JA$.

Historically, this case was treated using letters JX but this is misleading and obsolete. A is not used when foEs cannot be evaluated directly because of interference (use JS) or instrumental trouble (use JC).

This letter is used when a higher layer (such as the F layer) is 'blanketed' by a thin layer (such as Es). Blanketing occurs when an Es layer prevents the observation of echoes from a higher layer (Figs. 3.1, 3.2, 3.3).

Es can blanket the normal E trace also in which case foE, h'E are replaced by A (Fig.3.2).

When complete blanketing occurs (i.e. no reflections from higher layers appear at all), it is not possible to evaluate fbEs with certainty. However the statistics of fbEs lose much value if these high values are not numerical. The solution is to use fbEs = (foEs)AA in these cases. This can be misleading if foEs is deduced from a weak trace. When the Es does not vary with position, the top frequencies of the multiple order traces decrease slowly with order and the top frequency of the second order trace corresponds approximately with the frequency at which an F trace could have been seen. The first order Es trace is also often stronger below than above this frequency. When the Es is varying with position, the second order trace (or more seldom higher order traces) can be seen at frequencies higher than the top frequency of the first order trace. In practice when total blanketing is found, the difference between foEs deduced from the solid trace and fbEs is negligible compared with the variability of fbEs in space and time. Thus rule (a) below is usually applicable.

QUALIFYING AND DESCRIPTIVE LETTERS

- (a) If the trace is solid to foEs, tabulate foEs AA (Fig. 3.1).
- (b) If the trace is not solid to foEs, or if two or more multiple traces are present with the value of the top frequency of the second order trace much smaller than foEs (Fig. 3.2) tabulate the top frequency of the second order trace qualification AA respectively. (Note: If these values have to be deduced from the x-mode trace, AA should be used in preference to JA in cases (a) (b).). Values of fbEs deduced using foEs deduced from the solid part of the trace and rule (a) should usually agree with the value deduced from rule (b) within the accuracy rules for limit values.

Es traces may blanket over the lower part of their frequency range and not over the higher part, Fig. 3.3, [A88I, Fig. 77; A96I, Fig. 87], [B IIB 54 Johannesburg noon, IIB 55 Dec., IIB 57 June, IIB 66 June]. This is called partial blanketing.

Blanketing differs from the occultation of a normal layer (e.g. F1) by a lower thick layer (e.g. E) in that the traces of the higher layer will not show any additional group retardation near the blanketing frequency [A88I, Figs. 76, 77, 78; A96I, Fig. 90]. Compare Fig. 3.3 and Fig. 3.4.

Normally a blanketing Es trace is strong but when the non-deviative absorption is great - f_{min} large - the trace may appear to be weak. Comparison of the Es trace with that of the higher layer shows clearly when blanketing is present, Fig. 3.5.

When the minimum frequency reflected from higher layers is greater than foEs, descriptive letters C, R, S or Y should be used to describe fbEs as appropriate. The use of A should be restricted to cases where blanketing is clearly indicated. Y is most commonly the most appropriate, Fig. 3.6. (see also section 2.75, Fig. 2.19).

A difficult situation to handle is when the only trace appearing on the ionogram is a weak Es echo over a rather small frequency range with a comparatively high value of f_{min} (Fig. 3.5). In such cases one should study the series of preceding and following ionograms to determine where the F-layer critical frequencies are likely to be, to decide whether the F-region characteristics should be scaled as missing because of blanketing (A) or absorption (B). Another helpful guide in this situation is a knowledge of the expected range of frequencies of the F-region echoes, obtained from the previous day's scaling or from monthly median values. If the Es echo first appears in a range of frequencies well above the expected range of F-region echoes, the letter B should be used. If the virtual height is below 95 km, the weak trace is Es type d, the absorption is great and letter B should be used for all parameters except Es type.

Frequently in equatorial regions and sometimes at higher latitudes, Es echoes overlap the normal E-layer trace so that h'E is obscured. This frequently occurs with q type Es and with the common weak forms of l type Es. Though blanketing is not taking place the use of the letter A to describe this obscuration is permitted [A96I, Fig. 98].

Letter A is also used when a multiple order Es trace prevents accurate measurement of h'F or h'F2.

A special case occurs when particle E, Es-k, completely blankets the F trace. Logically this would imply the use of G but such use would cause difficulties with the F-layer medians. Also the distinction Es-r, Es-k is often difficult in this case. For simplicity particle E is regarded as an Es type for this purpose and the value of foF2 should be replaced by letter A. It is impossible to know whether foF2 was normal or not, so the accuracy rules do not allow E to be used. Thus total blanketing by Es or particle E are treated alike, use replacement letter A.

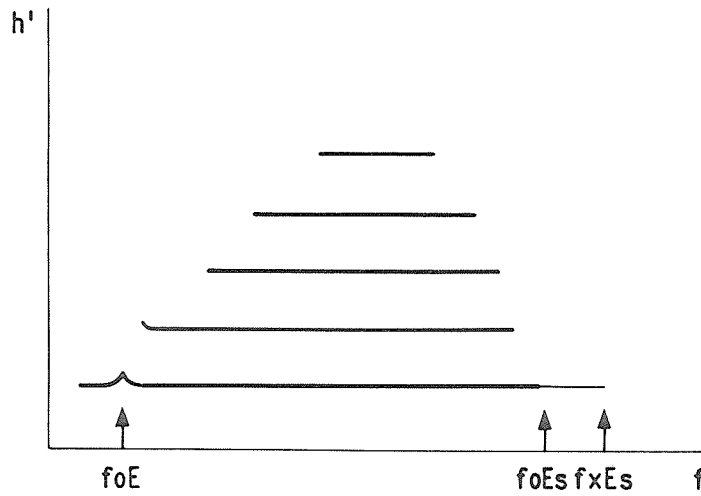

Fig. 3.1 Complete blanketing

- (i) All F-layer parameters replaced by A.
- (ii) If x trace distinct as shown here $foEs$ can be read directly, $fbEs = (foEs)AA$.
- (iii) If x trace not distinguished, $foEs = (fxEs - fB/2)JA$.
 $fbEs = (foEs)AA$ because of small difference in top frequency between first and second orders.
- (iv) foE should be extrapolated if possible to give $(foE)-A$, otherwise use cusp value and UA , $(foE)UA$. (see section 2.4, p. 36, Fig. 2.2a).

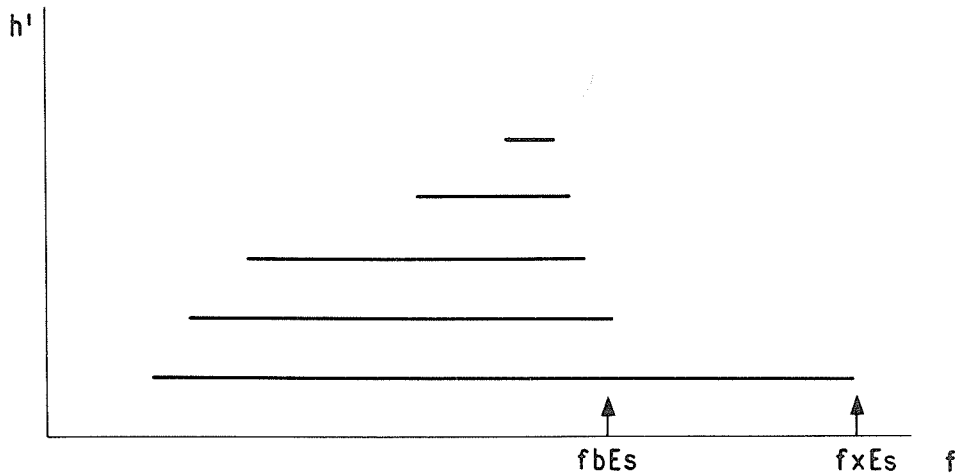

Fig. 3.2 Complete blanketing with consistent multiple traces

- (i) All F-layer and normal E-layer parameters replaced by A.
- (ii) Deduce $foEs$ from $fxEs$, $foEs = (fxEs - fB/2)JA$.
- (iii) Deduce $fbEs$ from multiples, $fbEs = xxxAA$.

QUALIFYING AND DESCRIPTIVE LETTERS

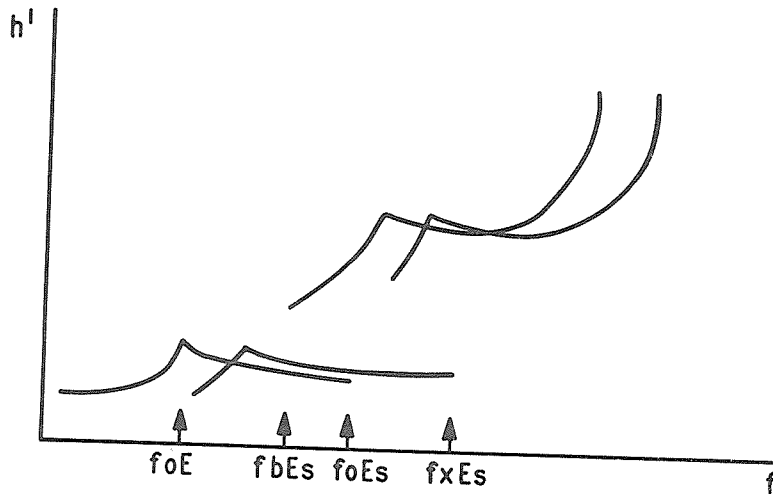

Fig. 3.3 Partial Blanketing

Note: If F trace nearly horizontal (see extrapolation, Section 2.4), use lowest value of $h'F$ with EA, $(h'F)EA$. When extrapolation is not allowed, $h'F$ is replaced by A.

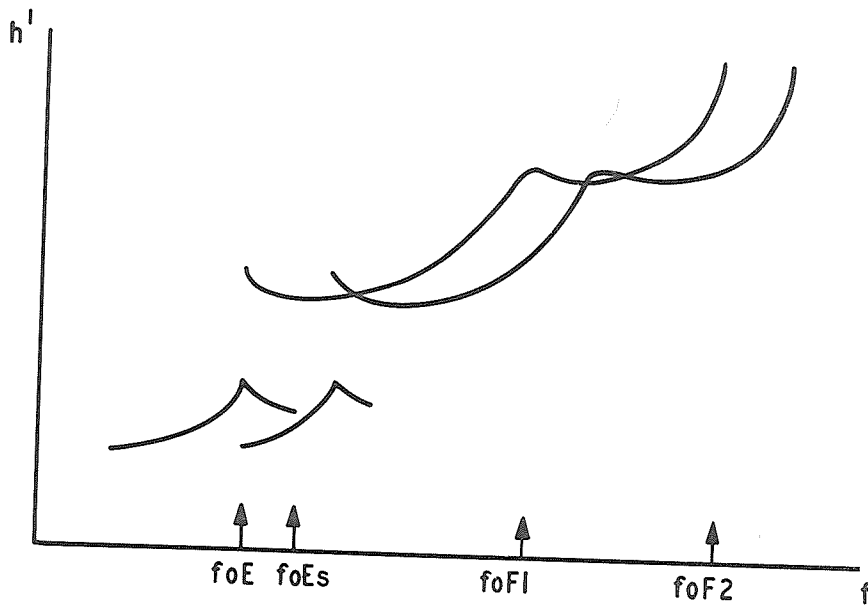

Fig. 3.4 Occultation of F by a thick E Layer

$fbEs = (foE)EG$

Note: In this case $h'E$ is given as $(h'E)EB$
 $h'Es$ is given as $(h'Es)EG$

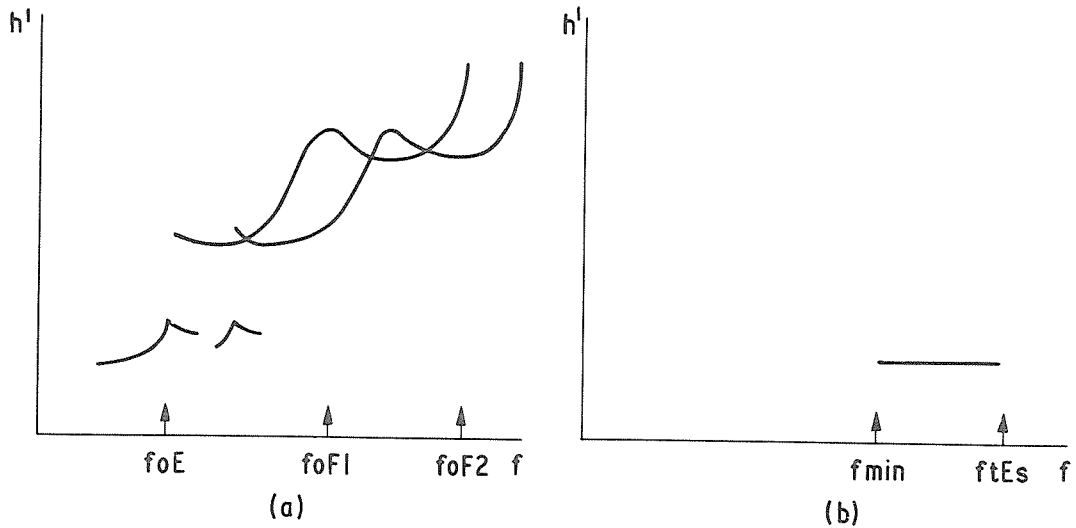

Fig. 3.5 Distinction between A and B

- (a) absorption normal, corresponding time of day to (b)
 (b) absorption high
- (i) If in (b) $f_{min} > f_{oE}$ in (a), $h'E$ and f_{oE} replaced by B
 $< f_{oE}$ in (a), $h'E$ and f_{oE} replaced by A
 - (ii) If in (b) $f_{min} > f_{oF1}$ in (a), $h'F$ and f_{oF1} replaced by B
 $< f_{oF1}$ in (a), $h'F$ and f_{oF1} replaced by A
 - (iii) If in (b) $f_{min} > f_{oF2}$ in (a), $h'F2$ and f_{oF2} replaced by B
 $< f_{oF2}$ in (a), $h'F2$ and f_{oF2} replaced by A
 - (iv) If there is little doubt that f_{tEs} is f_{oEs} , i.e. that the x mode is absorbed
 $f_{oEs} = (f_{tEs})-B$
 If doubt exists, for example if $f_{tEs} - f_{min}$ is large
 $f_{oEs} = (f_{tEs})MB$
- See section 4.3 for details.

In both cases $f_{bEs} = (f_{tEs})AA$.

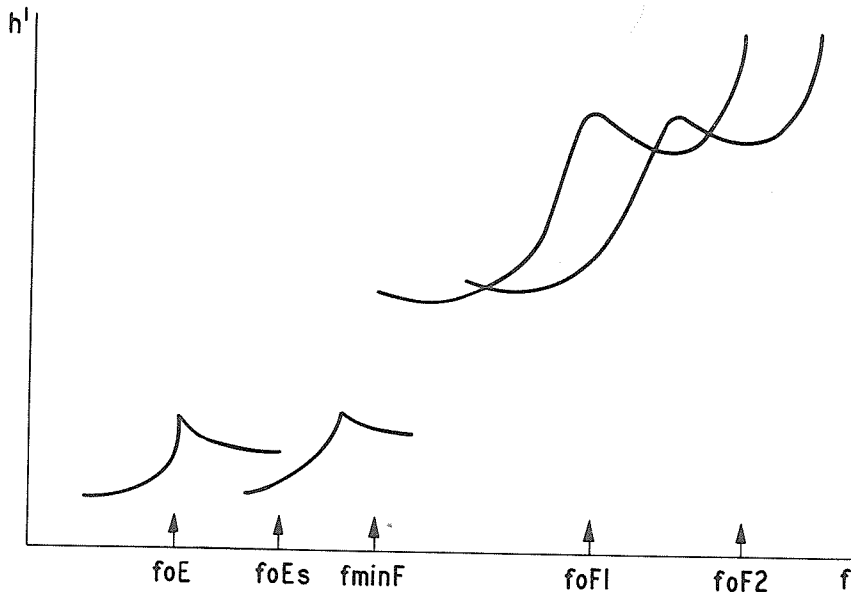

Fig. 3.6 Lacuna Case

$$f_{minF} > f_{oEs}$$

$$f_{bEs} = (f_{oEs})EY$$

Note: Same convention applies if x trace is missing or if the F trace shows no retardation at lowest frequency.

QUALIFYING AND DESCRIPTIVE LETTERS

B - Measurement influenced by, or impossible because of, absorption in the vicinity of f_{min} .

This letter applies only to the effects of non-deviative absorption. Absorption of this type is roughly measured by f_{min} (Figs. 3.5, 3.7, 3.8, 3.9) [A101I, Fig. 111; A112I, Figs. 128, 129, 144].

If the trace is well defined at lower frequencies and missing at a higher frequency, the letter B must not be used. In such cases the letters R or Y may be applicable (Fig. 3.9) [A112I, Fig. 137; A88I, Fig. 81].

When neither Es nor E echoes are observed but f_{min} is above the lower limit of the ionosonde and absorption is clearly indicated, foEs and fbEs are tabulated as less than the numerical value of f_{min} with descriptive letter B [A88I, Fig. 67]. h'Es is replaced by B (Fig. 3.7).

During total black-out or SID, use B for all characteristics including f_{min} . This is the only instance when letter B can be applied to f_{min} .

At stations using gain runs, it may happen that the medium-gain ionogram is blank because of absorption, so that f_{min} must be recorded as B. If traces appear on the high-gain record they should be scaled for all characteristics except foEs, fbEs and fxI despite the entry B in the f_{min} table.

When f_{min} is within about $\pm 10\%$ of a critical frequency, the numerical value is perturbed by the relatively large retardation (deviative) absorption present. The fact that f_{min} is no longer a reliable measure of non-deviative absorption can be indicated using the convention (f_{min})UR for these cases. This rule is used at stations where special care is taken to make f_{min} a quantitative measure of absorption.

Care should be taken to distinguish between high absorption at night (letter B) and absence of traces due to foF2 being below the lowest recorded frequency (letter E). The interference and noise level on the ionogram is usually detectably less than on normal ionograms in the former case but is unchanged in the latter. The time variation of foF2 also usually suggests when an E condition is likely to occur, Fig. 3.10.

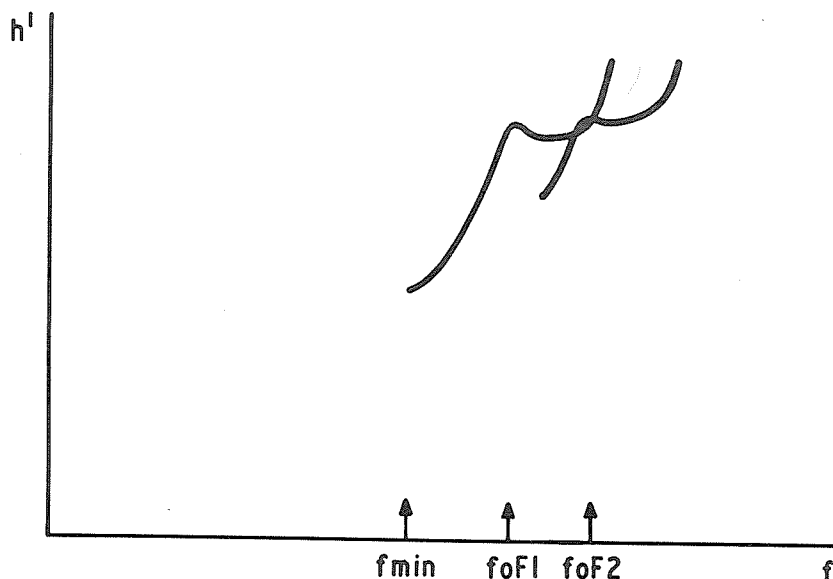

Fig. 3.7 High absorption in daytime

Use of B, foE, foEs, fbEs tabulated as (f_{min})EB
 h'E, h'Es replaced by B
 h'F replaced by B unless within accuracy
 limit of normal value, then use ($h'F$)EB

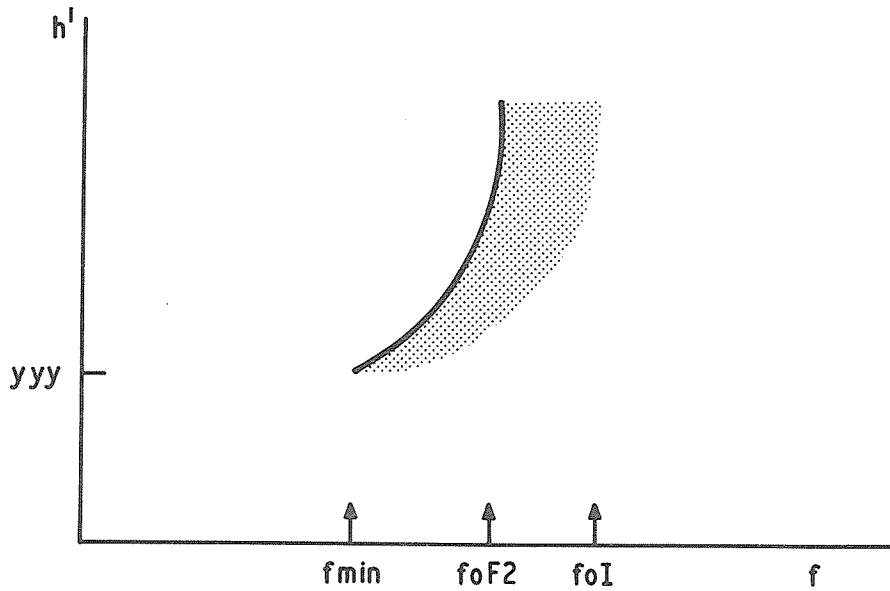

Fig. 3.8 High absorption at night

Use of B, f_{oE} s, f_{bE} s tabulated as $(f_{min})EB$
 $h'E$ s replaced by B
 $h'F$ tabulated as $(yyy)EB$
 f_{xI} tabulated as $(f_{oI} + f_B/2)OB$

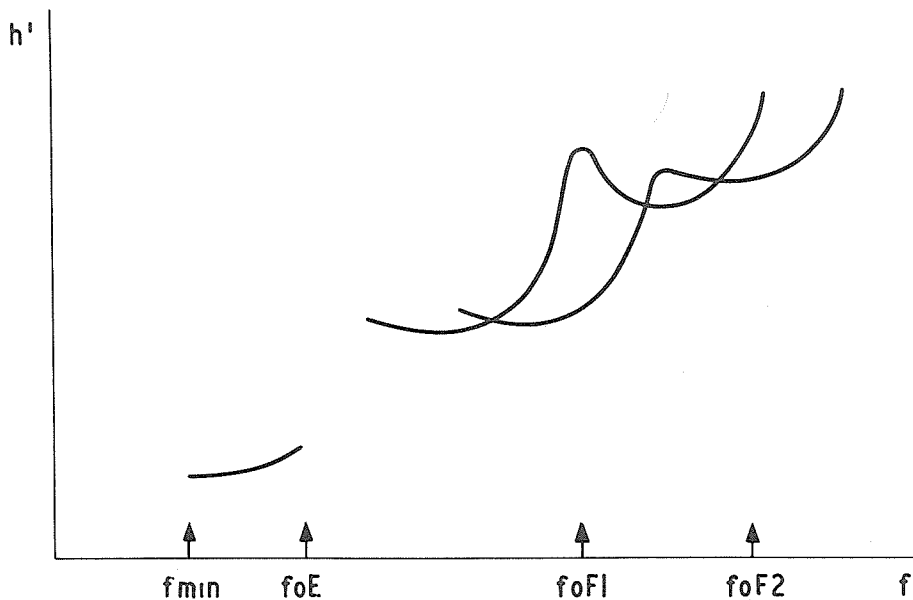

Fig. 3.9 Distinction B and R

f_{oE} is $(f_{oE})-R$ or $(f_{oE})UR$ depending on gap width (see accuracy rules).
 Note: f_{min} determined by E not F trace.

C - Measurement influenced by, or impossible because of, any non-ionospheric reason.

C is used to explain missing records due to equipment or power failure, interference due to other local equipments (e.g. transmitters), or when it becomes necessary to take the ionosonde off the air to prevent interference with other installations. It is used to explain a doubtful measurement where there is uncertainty regarding the frequency or height scale (unusual expansion or compression of the record, poor identification of frequency markers, etc.) such that the measurement is in doubt by more than the nominal accuracy required of the measurement.

C is used to explain a doubtful measurement when there is uncertainty regarding the time of observation (poor legibility or absence of print-time, clock errors) such that the time of the record is uncertain by not more than 5 minutes. It may be used to explain a doubtful measurement due to poor equipment response in part of the frequency range. C is used to explain doubtful or missing values because of some failure or omission on the part of the operator (fogged or streaked film, out of film, etc.). Finally, C is used when interference is caused by rain or snow static (See letter S).

When part of the ionogram is unusable because of an instrumental fault, C, the rules for extrapolation or interpolation are the same as for letter, S.

D - Measurement influenced by, or impossible because of, the upper limit of the normal frequency range.

Care should be taken in the daily and monthly tabulations to distinguish the descriptive letter D from the qualifying letter D. When the upper limit is adjustable and is less than the published upper limit of the normal frequency range, the actual upper limit frequency, xxx, should be recorded, xxxDD.

E - Measurement influenced by, or impossible because of, the lower limit of the normal frequency range.

If foF2 is presumed to be at a frequency below the lower limit of the ionosonde, the replacement letter E is used in place of values foF2 and h'F. (Figs. 3.10 (a), (b), where no principal F trace was present and the f plot suggests foF2 is below the lower limit. The absence of the F trace is not in itself enough justification to use the descriptive letter E. Always judge from a sequence of records and from the noise and interference present on the ionogram; the letter A, B, or S is frequently the appropriate one [A112I, Fig. 135].

If foF2 is so close to the lower frequency limit of the ionosonde that the trace does not become horizontal, then the height of the echo at the lower frequency limit of the recorder is tabulated for h'F with the qualifying letter E (less than) and the descriptive letter E (Fig. 3.11). [A112I, Fig. 143].

During night hours when no Es echoes appear on the ionogram and fmin is below the lower frequency limit of the ionogram, the descriptive letter E alone is tabulated for foEs, fbEs, h'Es and fxEs where tabulated (Figs. 3.10 (b), 3.11). The descriptive letter E is not used in this way when a trace from a thick E layer is present on the ionogram (e.g. during daylight hours) (see letter G). The descriptive letter E may not be used if fmin is greater than the lower limit of the ionosonde.

When the lowest frequency of the ionosonde is changed at different times of day (as is usual for ionosondes employing switched bands), it is important that the actual lowest frequency in use be tabulated at least in the fmin tables whenever a limit value, (fmin)EE, is present; preferably this should be done for all parameters qualified EE.

When the critical frequency is lower than the lowest frequency of the ionosonde the appropriate symbol is E not G.

Care should be taken in the daily and monthly tabulations to distinguish the descriptive letter E from the qualifying letter E.

Where the ordinary characteristic is below the lower limit of the ionosonde but the corresponding extraordinary characteristic is present, this should be measured and the corresponding ordinary characteristic deduced and qualified by J and described by E.

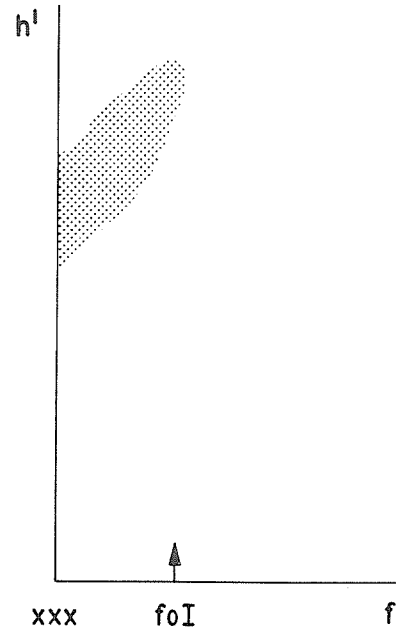
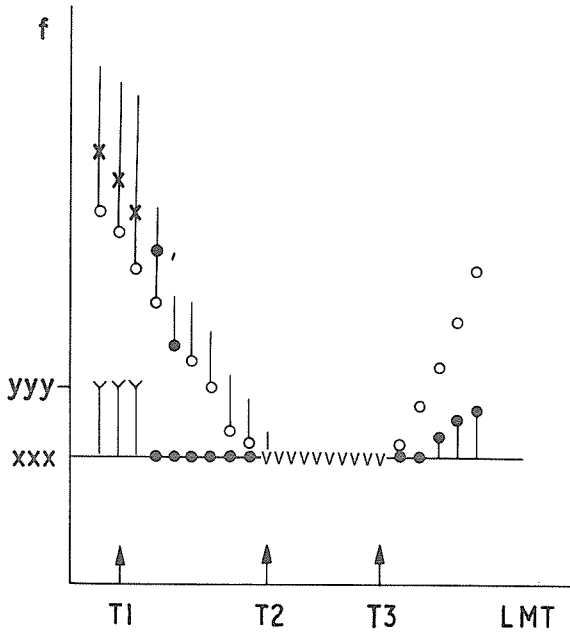

Fig. 3.10(a) Section of f plot showing use of EE

Fig. 3.10(b) Ionogram at time T2, Fig.3.10(a)

Lower limit frequency of ionogram xxx

Near T1 f_{min} is yyyES

f_{oEs} yyyES

f_{bEs} yyyES

Between T2 and T3 all parameters replaced by E
(more accurately xxxEE)

$$f_{xI} = (f_{oI} + f_B/2)OB.$$

All other parameters replaced by E

(more accurately xxxEE)

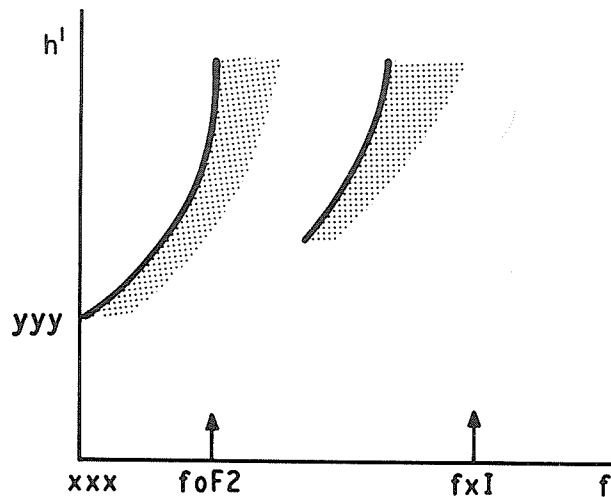

Fig. 3.11 Use of EE

Lowest frequency on ionogram is xxx

f_{min} (xxx)EE or less accurately E

$h'F$ (yyy)EE

f_{oEs} , f_{bEs} , f_{xEs} and $h'Es$ ---E

F - Measurement influenced by, or impossible because of, the presence of spread echoes.

The critical frequency of a layer is usually modified by the presence of spread echoes, even when the reading accuracy of the characteristic is unaffected, and the descriptive letter F should be used in these cases. Whenever possible, a numerical value for the critical frequency should be tabulated, but caution should be used not to scale traces which are likely to be oblique (see section 2.7).

The procedures have been fully discussed in sections 2.7 and 2.8 and are therefore only summarized here.

The first step is to decide whether the main traces are due to a horizontal or a tilted layer, section 2.7, Figs. 2.6, 2.7, 2.8, 2.10. If the former, as is most usual except at high latitudes or during storms:

- (a) the first choice is the principal trace (Figs. 3.12(a) and 2.10) [A98I, Fig. 101; A100I, Fig. 105; A104I, Fig. 122; A112I, Fig. 136].
- (b) the second choice is guidance from the multiples (Figs. 3.12(b) and 2.11) [A104I, Figs. 123, 124].
- (c) the third choice is a well-defined 'inside edge' of the spread (Fig. 3.12(c) [A40I, Fig. 29; A88I, Figs. 68-70].
- (d) the fourth choice is a limiting value used with the qualifying letters D or E (see section 2.22, paragraph (d)).
- (e) the fifth choice is the descriptive letter F without any numerical value (Fig. 3.13) [A104I, Figs. 124 and 125]. For tilt cases see section 2.7.

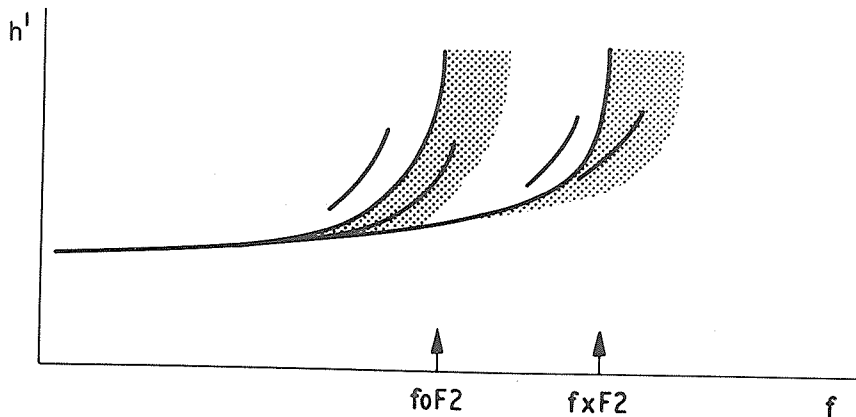

Fig. 3.12(a) Principal trace

- (i) The principal trace is usually more solid than other traces.
- (ii) For the principal trace $fxF2 - foF2 = fB/2$. This is not always true for subsidiary traces.

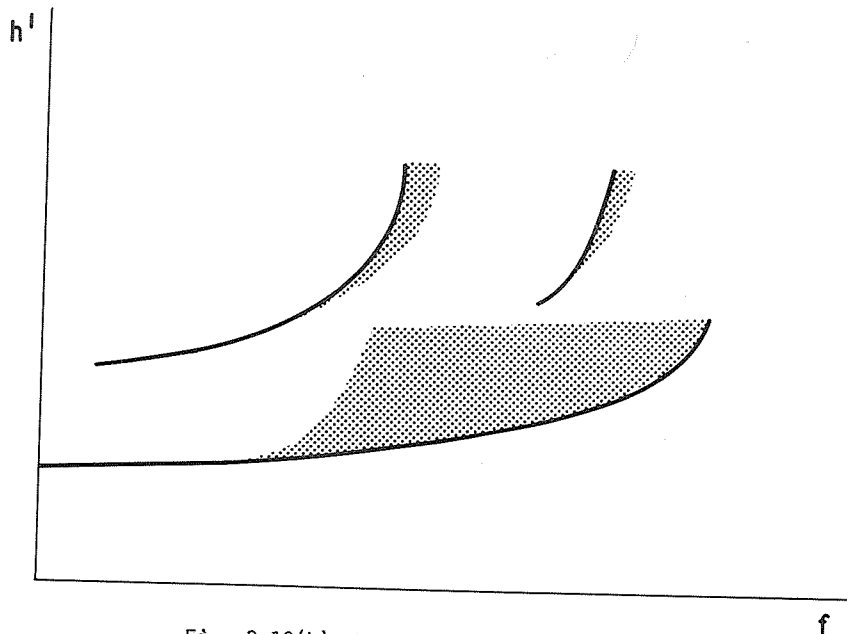

Fig. 3.12(b) Use of multiple orders

A principal trace can often be seen in the second or higher order when not visible on the first order. Again it is usually relatively solid and $fxF2 - foF2$ is often close to $fB/2$. The latter, when true, confirms the interpretation but is not essential.

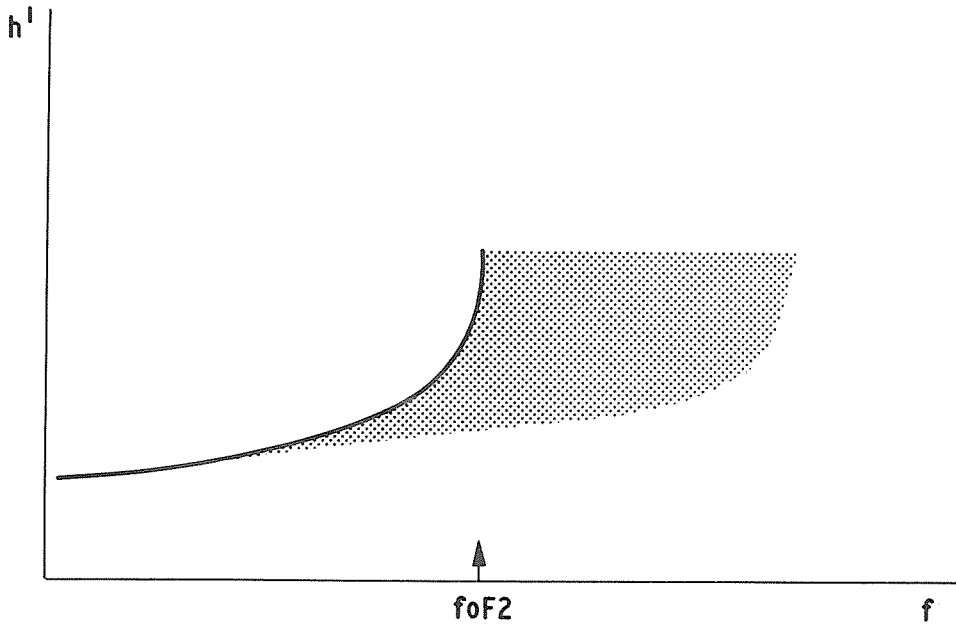

Fig. 3.12(c) Use of limit edge

When the main trace is due to a horizontally stratified layer, the lower frequency edge of the spread gives $foF2$. Very often a principal trace can be seen to define this edge. (see also Figs. 2.4, 2.11).

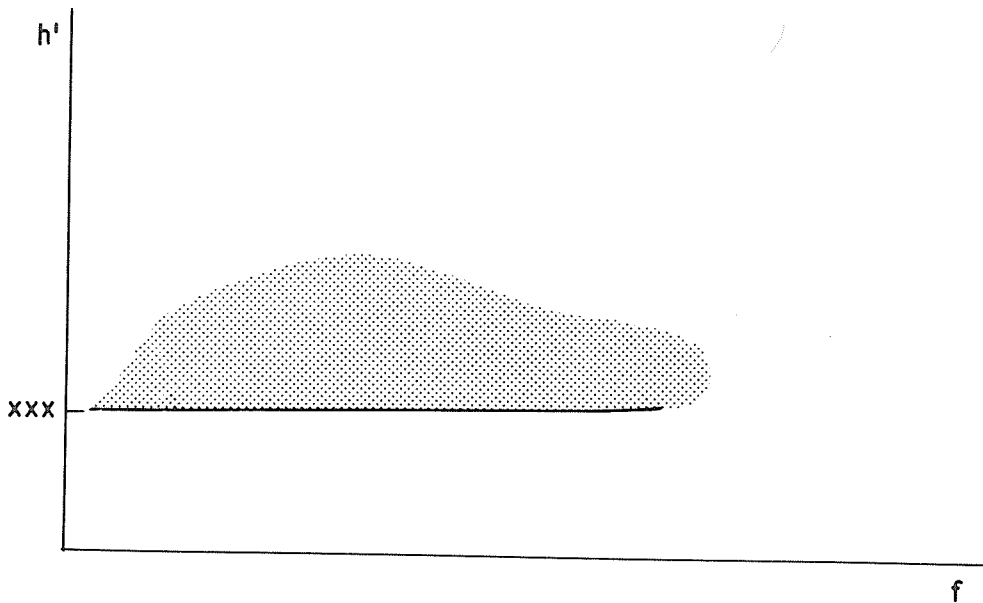

Fig. 3.13 No principal trace

Use of Q $foF2$ replaced by Q
 $h'F$ $xxx-Q$ or $xxxUQ$ depending on
 whether or not lower edge clear.

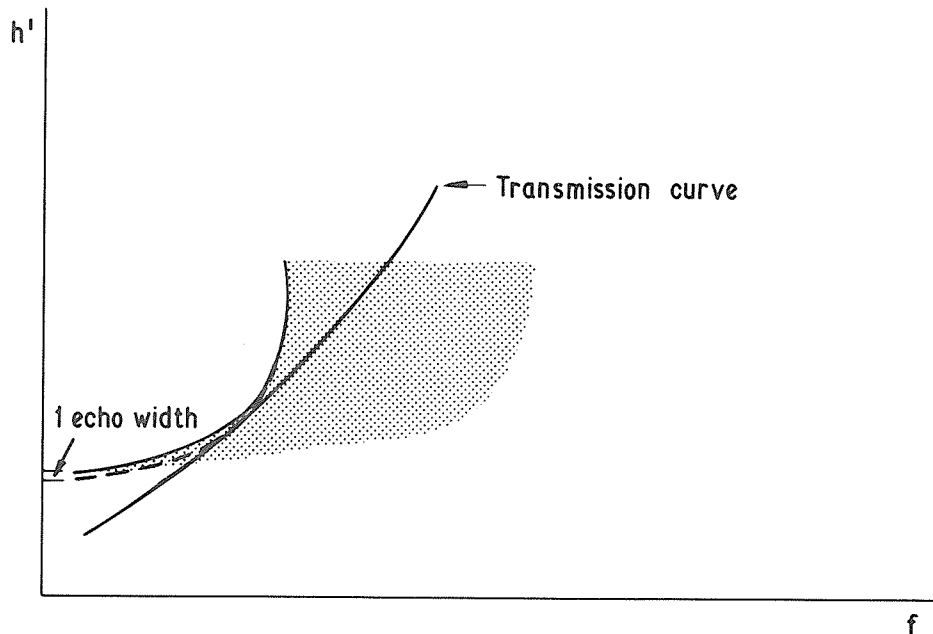

Fig. 3.14 Scaling of M(3000)

from Ionogram with well defined inner edge to scatter pattern

— observed inner edge
 - - -constructed trace edge

Procedures to be followed in scaling M(3000) when spread echoes are present are as follows:

- (a) The first multiple echo may be used as a guide to help determine the location of the main echo.
- (b) If there is a well-defined 'inside edge' to the trace, proceed as follows: construct a curve, each point of which is one echo width below the corresponding point of the inside edge. Scale the factor from the reconstructed trace, Fig. 3.14.
- (c) If these methods fail, the descriptive letter F without any numerical value is tabulated.

Letter symbol F can never be used with parameters $h'F$, dfS , as these characteristics are used only when spread F is present. When F is used to denote spread F typing in $foF2$ or fxI tables, it takes precedence over all other descriptive letters (see section 2.8).

Letter F must be used whenever the frequency spread is equal to or exceeds 0.3 MHz and should not be used when it is less than this value. This rule enables the presence of spread F to be compared at different stations.

G - Measurement influenced or impossible because the ionization density of the reflecting layer is too small to enable it to be made accurately.

This letter is used when $foF2$ is equal to or less than $foF1$. In this case tabulate the numerical value of $foF1$ for $foF2$ and use the qualifying letter E (less than) and the descriptive letter G [A88I, Fig. 84; A100I, Fig. 108]. For M(3000) $F2$ and $h'F2$ tabulate the letter G with no numerical value (Fig. 3.15).

The letter G is used for Es characteristics in all cases when no Es traces are observed although normal E-layer traces are present (Fig. 3.16).

A numerical limit should always be given with EG and is helpful to the user when foE varies greatly in a month. Usually, however, the variability of foEs is so much greater than that of foE that a median foE is adequate and this minimizes work.

As all median and quartile values of foEs or fbEs should be numerical, the value of median foE is inserted if these would otherwise be G (Section 8).

If, because of interference, it is not possible to obtain numerical values for foE, yet the presence of the E trace is observable, it is proper to use G for the missing Es characteristics (Fig. 3.17).

G is used to explain a doubtful or limiting value of h'Es when the low frequency end of the Es trace is affected by group retardation and the trace does not become horizontal (Fig. 3.18) [A1121, Fig. 134]. This applies in the case of Es type c and Es type h.

For Es types λ and c, when foEs is less than foE, the numerical value of foEs and fbEs must be described by the letter G (Figs. 3.19 and 3.20). This is necessary for median determination.

Note: Two common difficulties concern the proper use of G or B and of G or E. For G to be used there must be positive evidence of the presence of a reflecting lower thick layer, i.e., any group retardation due to its critical frequency is visible on the ionogram. If the trace is missing because of high absorption the appropriate letter is B; if the critical frequency falls below the lowest limit of the ionosonde the associated characteristics are replaced by E. Stations making gain runs should use the high-gain sounding to determine whether the letter G applies.

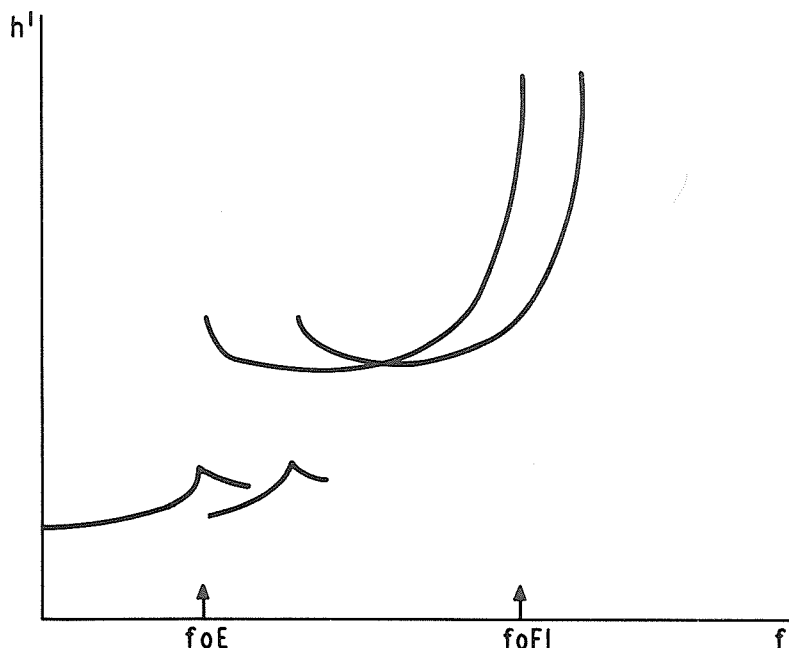

Fig. 3.15 G condition. No F2 trace visible

foF2 is given by (foF1)EG (less accurately by G)

h'F2 is given by G

M(3000)F2 is given by G

Note foF1/foE will be approximately given by the normal ratio when foF2 is present (Section 1.13).

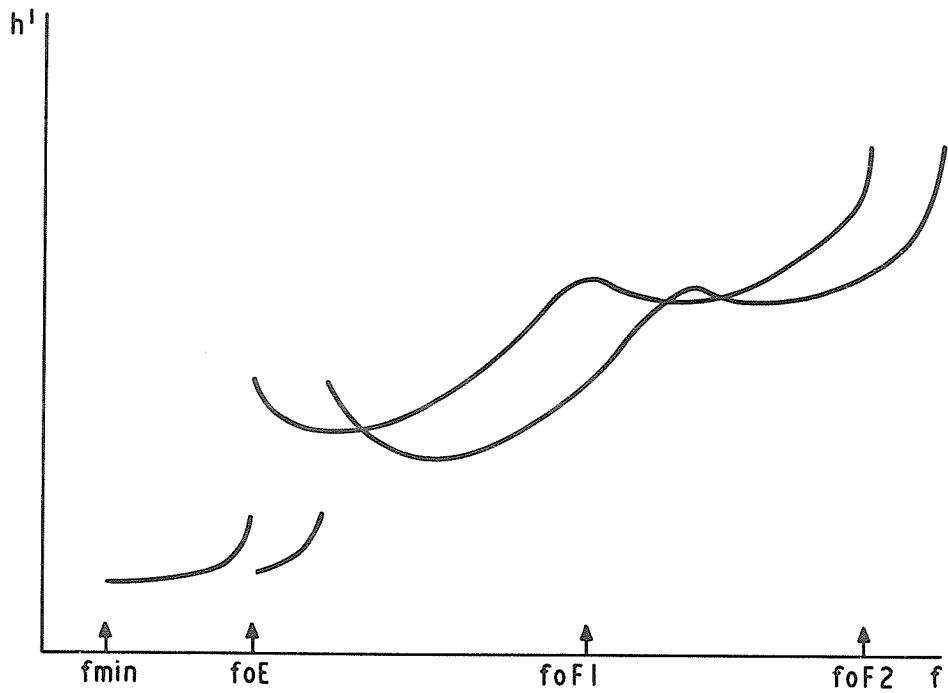

Fig. 3.16 G condition. No Es trace visible

foEs given by (foE)EG
 fbEs given by (foE)EG
 h'Es replaced by G

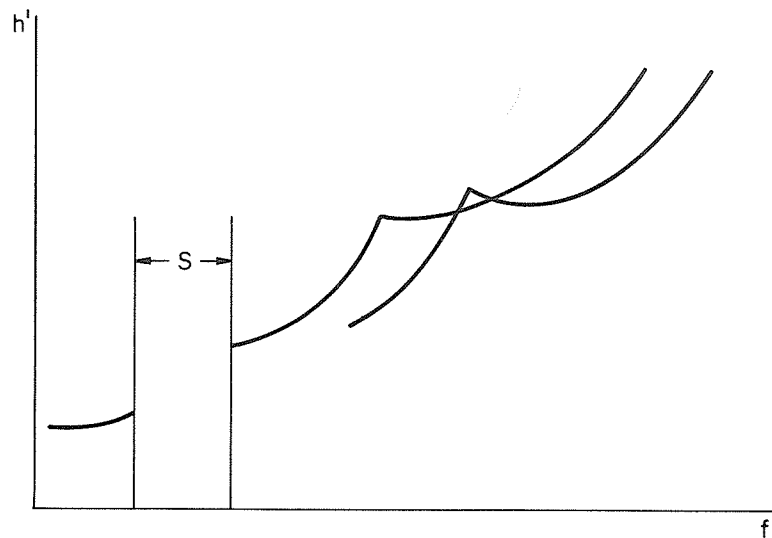

Fig. 3.17 Use of G,S when interference is present

foE = S, foEs = G, fbEs = G, h'Es = G

More accurately use median values of foE to give
 foEs = (foE)EG, fbEs = (foE)EG.

A similar pattern due to instrumental fault would show C instead of S.

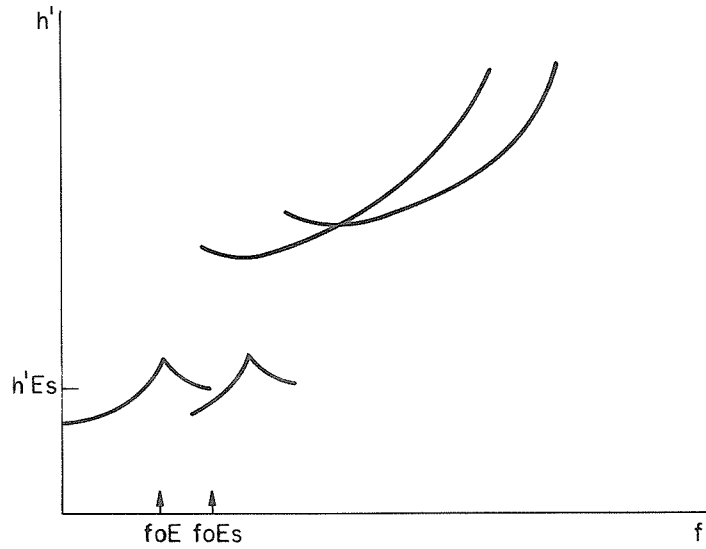

Fig. 3.18 Use of G with $h'Es$
 $h'Es = (h'Es)EG$

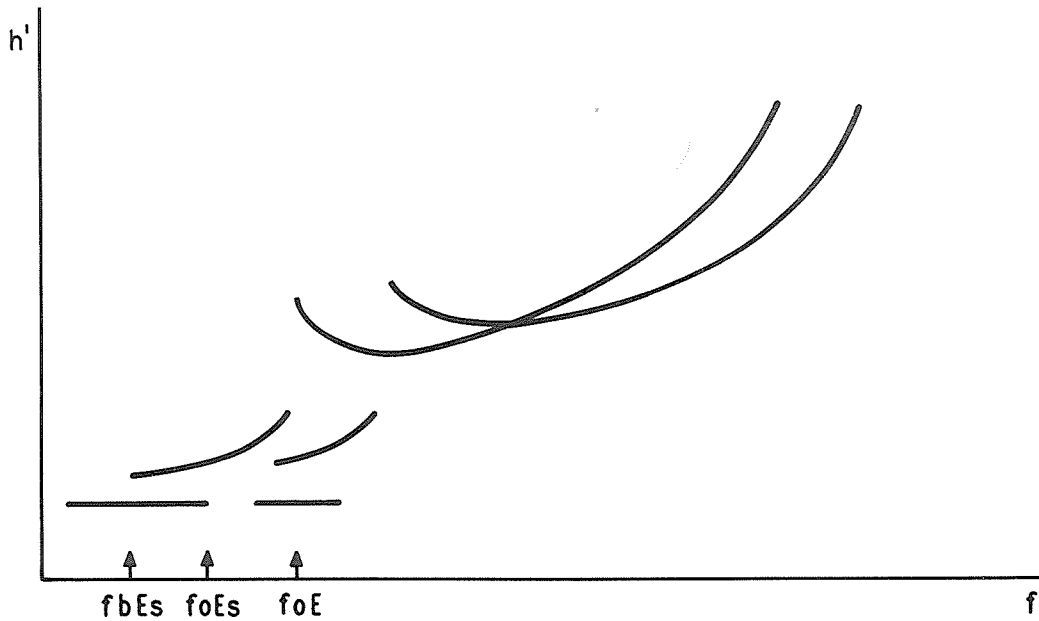

Fig. 3.19 Use of G to show $foEs$ less than foE
 $foEs$ is written $(foEs)-G$
 $fbEs$ is written $(fbEs)-G$

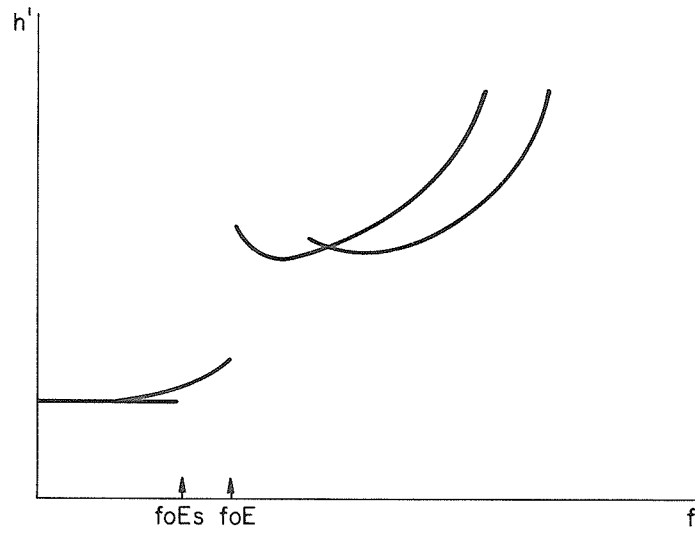

Fig. 3.20 Use of G to show fbEs less than foE
foEs is written (foEs)-G

In this figure fbEs is less than the lowest frequency recorded xxx.
fbEs is written (xxx)EG or, in approximate form, G

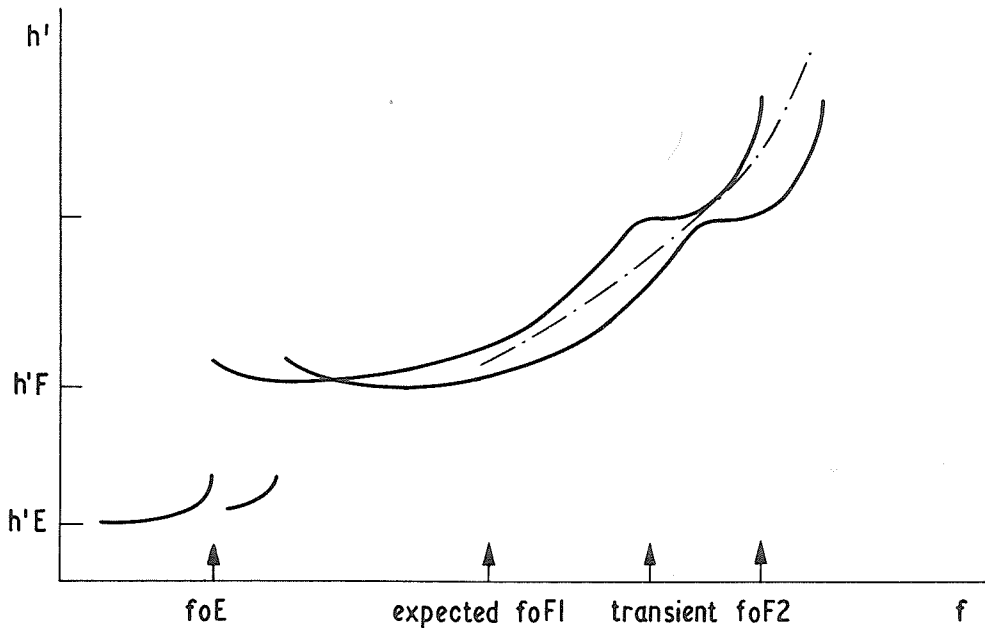

Fig. 3.21 Stratification H influencing foF2 and M(3000)F2

- · - · - transmission curve touches abnormal trace
foF2 given by (foF2)-H
M(3000)F2 given by (M(3000)F2)UH
h'F2 is transient and not recorded

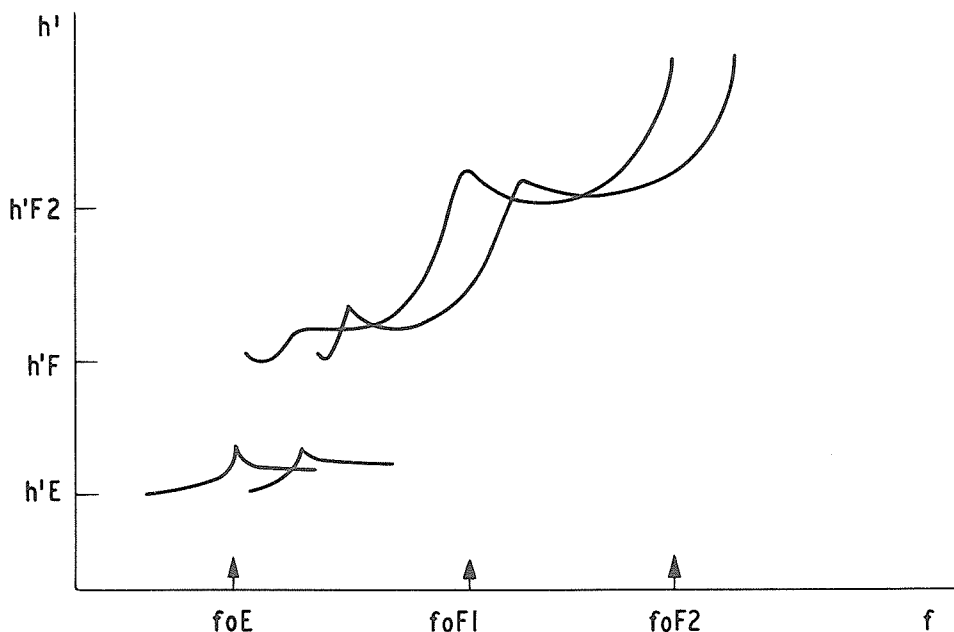

Fig. 3.22 Stratification influencing $h'F$
 $h'F$ given by $(h'F)UH$.
 (when the transient can be easily seen U is needed.)

H - Measurement influenced by, or impossible because of, the presence of stratification.

This letter may refer to the traces of any regular layer. It is used when the trace shows a retardation cusp or point of inflection not normally scaled at the station (Fig. 3.21). In most cases the phenomena are transient [A88I, Figs. 81, 83; A98I, Fig. 91; A128I, Fig. 148]. In Fig. 3.21 the expected value of $foF1$ is at a much lower frequency than the stratification shown.

The presence of abnormal stratification usually modifies the critical frequency or virtual height of the layer, as can be seen from the f plots or h' plots respectively. The descriptive letter H is therefore necessary in these cases, even when the reading accuracy of the characteristic is unaffected, Fig. 3.22.

The qualifying letter U should be used when comparison of different components, orders of reflection or a sequence of ionograms shows that the uncertainty of interpretation exceeds the allowed limit. The definitions of the normal characteristics should be used to identify the appropriate value in doubtful cases. Thus, for the F2 trace, the highest critical frequency and lowest virtual height should be tabulated.

$M(3000)$ should always be determined using the trace of the regular layer as a whole (e.g., F2, F1 or F1.5 when scaled systematically) (Fig. 3.21; point-dash line: transmission curve).

K - Presence of a particle E layer

This letter is used to distinguish cases where foE is determined by a particle E layer-- a thick layer in the E region generated by particle precipitation and having a critical frequency significantly higher than the normal solar controlled E layer. This letter has been devised primarily to draw attention to particle-generated thick E layers found at hours when foE due to the normal E layer is also present; e.g., for low frequency ionograms and for stations at high latitude in summer months. The primary indication that particle E is present is the presence of group retardation at the low frequency end of the trace from the higher layer. (Fig. 4.2, p. 105). A possible physical definition of particle E is that it is a thick layer formed below the F layer directly or indirectly by the action of ionizing particles and having a critical frequency greater than that of the normal E layer. For scaling purposes the descriptive definition is quite adequate. Letter k is inserted in the Es-type table when particle E, Es-k, is present. Es-k takes precedence over all other Es traces present other than that giving $foEs$.

QUALIFYING AND DESCRIPTIVE LETTERS

When the E trace is totally blanketing the distinction between a thick layer particle E or a thin layer with apparent retardation at the top frequency (E_s type r) cannot be certain. In cases of complete doubt classify as E_s type r. The following criteria should be used:

- (a) When absorption is small, particle E gives both o and x modes and one or more multiple traces extending to near foE ; whereas E_s type r either shows no multiple traces or multiples which stop at a frequency appreciably lower than foE_s . When any of the multiple traces are within the accuracy rule limits for use of U with foE_s , the distinction type r or particle E is not significant; scale as particle E, $foE_s = fbE_s = foE$, entry $(foE)-K$.
- (b) When absorption is high a solid trace is more likely to be due to particle E than to E_s type r, and a weak trace or trace showing spread is more likely to be E_s type r than particle E.

L - Measurement influenced by or impossible because the trace has no sufficiently definite cusp between layers.

The letter L is used for F-region characteristics (Fig. 3.24). The criterion for deciding the use of L is the relative slope of the F1 and F2 traces. (See also section 6.4 for detailed rules).

The conventions given below are intended to give a quantitative guide as to when L should be used by comparing the slope of the F1 trace with the slope of the transmission curve. If the latter always cuts the former L must be used. If a tangent point can be found (equal or greater slope of F1 trace relative to transmission curve) a numerical value is possible.

(a) The conventions for using L when scaling $foF1$ are:

- (i) When the shape of the F trace shows that no F1 stratification is present no entry is made. (F traces never concave downwards) (Fig. 3.23).
- (ii) When the transition from the F1 trace to the F2 trace is smooth and ill-defined, the probable error in estimating the true value of $foF1$ will exceed 20% and the numerical value is replaced by the letter L (Fig. 3.24). The M(3000) transmission curve will not give a point of tangency with the F1 trace in these cases, cutting the F1 trace at an angle, [A100I, Fig. 110], (Fig. 3.24).

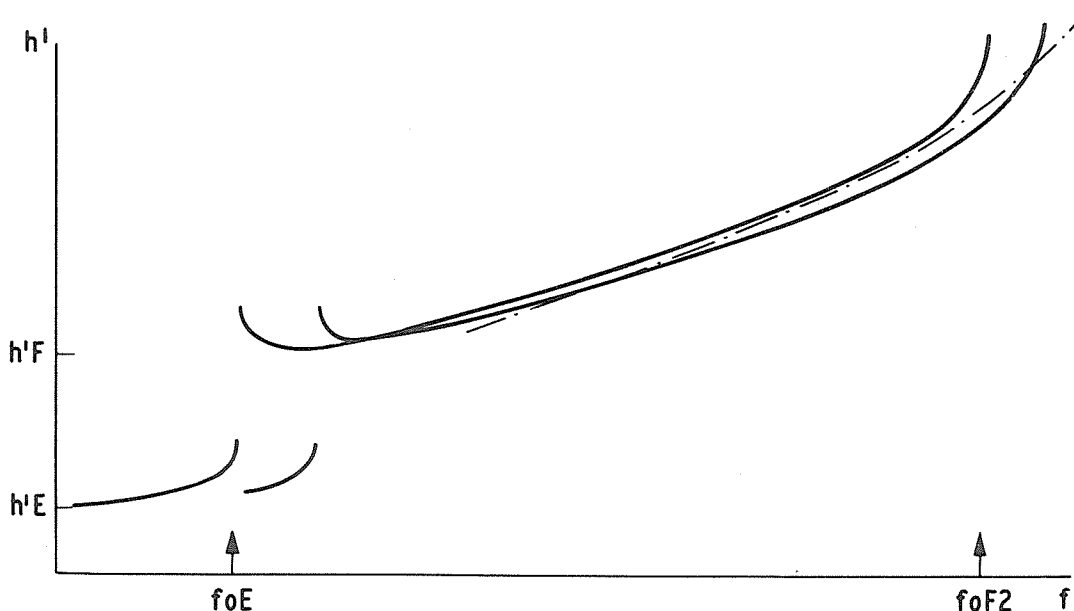

Fig. 3.23 Use of L

- · - · - · transmission curve touches o trace at one point only.
 $foF1$, M(3000)F1, $h'F2$ no entry in tables. $foF1$ no entry on f plot.

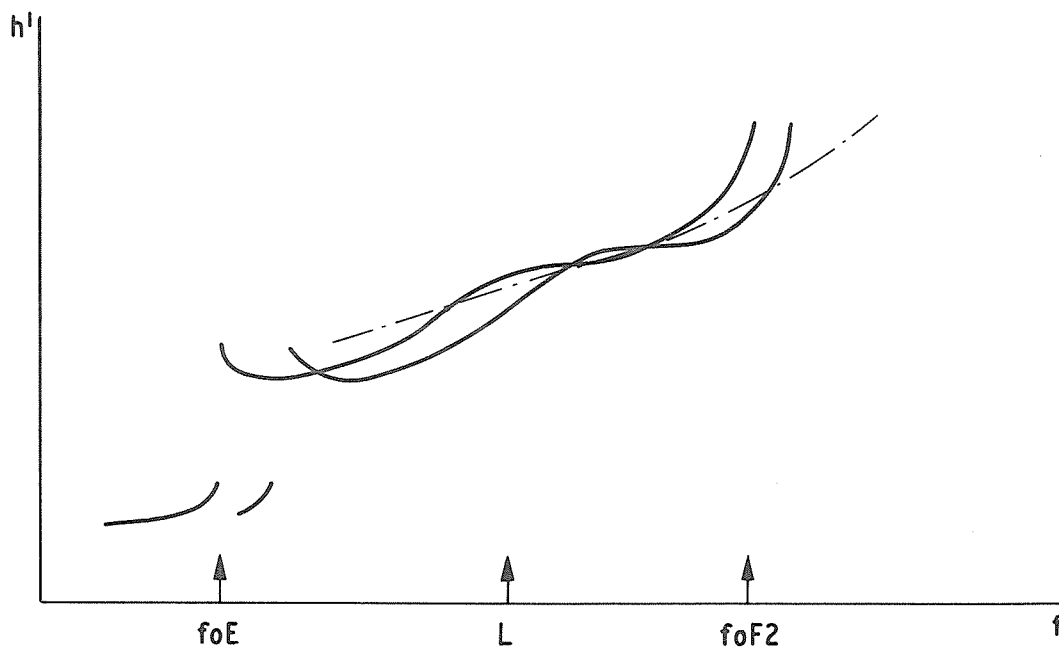

Fig. 3.24 Use of L

F2 trace not horizontal
 $foF1$, $M(3000)F1$, $h'F2$ replaced by L
 L is placed on f plot at frequency shown

- (iii) When the $M(3000)$ transmission curve gives a point of tangency with the F1 trace but the F2 trace does not become horizontal, scale with qualifying letter D and descriptive letter L [A100I, Fig. 109]. (Fig. 3.25a).
- (iv) When the $M(3000)$ transmission curve gives a point of tangency on the F1 trace and the trace shows an ill-defined maximum or one which is only clear on a multiple reflection, scale with the qualifying letter U and the descriptive letter L (Fig. 3.25(b)).
- (v) When the cusp is sufficiently well defined for $foF1$ to obey the criteria for an accurate measurement do not use L.

QUALIFYING AND DESCRIPTIVE LETTERS

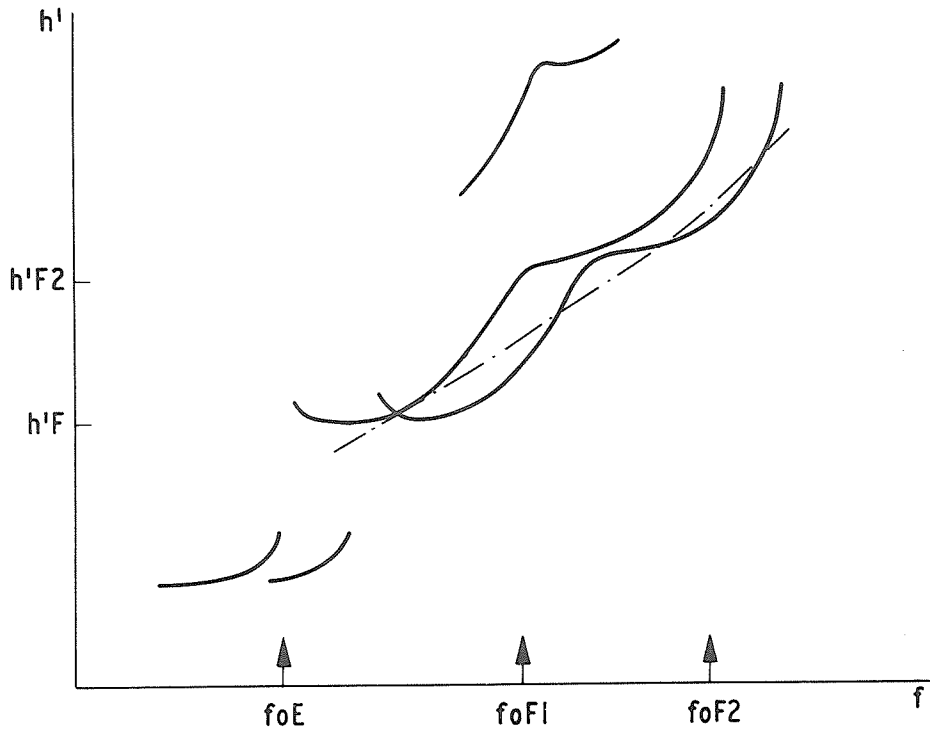

Fig. 3.25(a) Use of DL

F2 trace is not horizontal.
 $foF1$ given by $(foF1)DL$ measured at frequency at which F1 trace slope most rapidly decreasing (see section 6.4 for f-plot representation).
 $h'F2$ given by $(h'F2)EL$, $(h'F2)UL$ or by L depending on minimum slope of F2 trace.

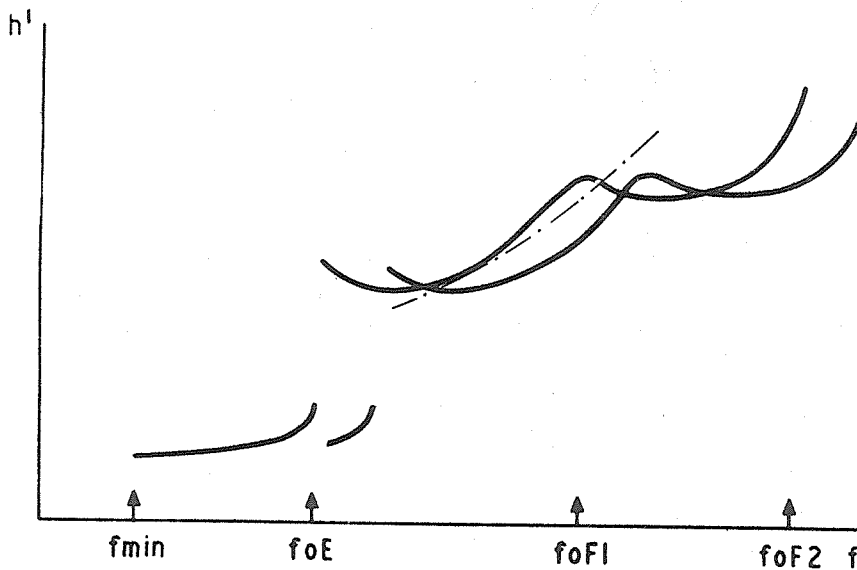

Fig. 3.25(b) Use of UL

For $foF1$ cusp equal to or less than that shown and transmission curve can be made to touch F1 trace use $(foF1)UL$.
 Note when o- and x-mode traces less similar than that shown, $(foF1)UH$ would be preferable.

- (b) The conventions for determining $M(3000)F1$ are based on the fact that the main source of error is usually the determination of foF1. For this case, the five foF1 cases given above give:
- (i) $M(3000)F1$ left blank
 - (ii) $M(3000)F1$ replaced by L
 - (iii) $M(3000)F1$ deduced at the numerical value of foF1 and qualified EL
 - (iv) $M(3000)F1$ deduced from the numerical value of foF1 and qualified UL
 - (v) $M(3000)F1$ unqualified. Do not use L.
- (c) The conventions for using L when scaling $h'F2$ are:
- (i) When the shape of the F trace shows that no F1 stratification is present, no entry is made (Fig. 3.23).
 - (ii) When the F2 trace does not show an almost horizontal section the numerical value is replaced by the descriptive letter L (Fig. 3.24) [A96I, Fig. 88; A100I, Fig. 109].
 - (iii) When the F2 trace is almost horizontal $h'F2$ may be tabulated with qualifying letter U and descriptive letter L [A96I, Fig. 86].
 - (iv) L is not used when the F2 trace has a horizontal tangent [A96I, Fig. 87].

Similar conventions may be used when additional characteristics are tabulated for local purposes, e.g., the intermediate layer F1.5 (Chapter 12).

It should be noted that there can be occasions when the appropriate letter symbols can be different for all four F1 parameters, e.g., $h'F$ below f_{min} , entry V; $M(3000)F1$ tangent point blanketed by Es, entry A; foF1 a good cusp, unqualified entry; $h'F2$ hidden by interference, entry S. The appropriate letter symbols take precedence over L whenever they represent the more important source of inaccuracy or ignorance.

In most cases, $M(3000)F1$ and foF1 will show the same usage of L. In borderline cases, $h'F2$ will usually be more exact than foF1 or $M(3000)F1$ and the conventions are therefore given separately.

Letter L is used to denote the presence of spread F type mixed and is used in spread F type, foF2 or fxI tables only (section 2.8). The identification of spread F type L is voluntary but recommended by INAG as being valuable scientifically. When L is used in the foF2 or fxI tables for this purpose it takes precedence over all other descriptive letters.

M - Interpretation of measurement uncertain because ordinary and extraordinary components are not distinguishable.

Descriptive letter M is used to show that it was not possible to distinguish which component was present. It is mainly used when the presumption is that the required characteristic was not seen and the numerical value has been deduced. It is preferable to use M as a qualifying letter wherever possible giving the descriptive letter showing why interpretation was not possible.

This letter is used primarily for the characteristics foEs and fxEs. Its use for these is discussed fully in sections 4.4 and 4.5 (Es characteristics).

The letter can also apply to foF2 and fxI when there is real doubt of whether the o or x mode is observed. It should not be used if the doubt can be resolved by using a sequence of ionograms or by comparison with other ionograms. The most common case occurs when foF2 is varying irregularly in time and is close to or below the lowest frequency of the ionogram.

M should be used as a descriptive letter when a qualifying letter such as D, E, U is appropriate and the interpretation is also doubtful and may be used when there is no main reason for the doubt, e.g., ()MM or ()-M implies several causes with equal weight.

Letter M always implies an uncertainty of $fB/2$ in frequency characteristics, an uncontrolled uncertainty in height parameters, and $M(3000)$ factors should not be computed for data described or qualified by it. It should be used as sparingly as possible.

- N - Conditions are such that the measurements cannot be interpreted.

Use this letter as sparingly as possible. Be certain no other letter describes the difficulty. Usually a careful examination of a sequence of records will provide a logical interpretation [A88I, Figs. 66, 67; A96I, Figs. 91, 92; A104I, Fig. 115]. The most common use of this letter is when oblique echoes prevent unambiguous interpretation of the ionogram.

N is used when traces of different orders are superimposed so as to prevent an unambiguous interpretation of the traces. In general the reason for using N should be shown in the remarks column.

- O - Measurement refers to the ordinary component.
(See section 4.5 for use when $f_x E_s$ is tabulated.)

Descriptive letter O shows that an o-trace characteristic has been tabulated in an x-mode table without correction. Where suitable programs exist, the computation $f_o X + f_B/2 = f_x X$ can be more accurately done than by hand. This should only be used when it is known that the final tabulation will include the correction. The most common application is when $f_x I = f_x F_2$ and only $f_o F_2$ is evaluated, use $(f_o F_2)-O$. Note: O must take precedence over all other descriptive letters in this case and the procedure is therefore less useful than the direct measurement of $f_x I$ or its calculation from $f_o I$. Also this cannot be done when $f_o I$ is not equal to $f_o F_2$, i.e., spread is present; it is then necessary to calculate $f_x I$ manually using qualifying letter O and the appropriate descriptive letter. For example, with $f_o I$ near the gyrofrequency f_B , calculate $f_x I = (f_o I + f_B/2)$ and tabulate $(f_o I + f_B/2)OB$.

Similar rules apply for descriptive letter X. The qualifying letter corresponding to X has always been J. Section 1.04 gives more exact rules which should be used where necessary.

- P - Man-made perturbation of parameters - Presence of polar spur traces.

P is used to show that the ionosphere has been modified by man-made phenomena, e.g. heating experiment, injection of foreign substances.

Spread F types. P shows the presence of spur type spread F. When used for this purpose in $f_x I$ tables P takes precedence over all other descriptive letters. Many examples are shown in the High Latitude Supplement (UAG-50).

- Q - Range spread present.

Q is used to show the presence of a range spread trace, see sections 2.74 and 2.8, Figs. 2.14, 2.17, 3.13 and see section 2.3. It is tabulated with the value of $h'F$ and takes precedence over F when a distinct range spread structure is present. The main objective of this letter is to identify cases where a range spread structure is observed at oblique incidence and cases where no main trace or frequency spread is present. It is mainly used at high and low latitudes, but may be important anywhere during major ionospheric storms. Many examples are shown in the High Latitude Supplement (UAG-50).

- R - Measurement influenced by, or impossible because of, attenuation in the vicinity of a critical frequency [A88I, Fig. 81; A112I, Fig. 129].

The letter R may be used to replace or describe a numerical value of any characteristic (example: see Fig. 3.26). The attenuation must be associated with retardation, the trace starts to move up towards the critical frequency and then disappears. Wide gaps in the trace which cover frequencies where retardation would be expected to be small are due to layer tilt, letter Y; to instrumental causes, letter C; or interference, letter S. When R is applicable the trace weakens gradually, when Y is applicable the trace is strong and stops suddenly (see Y).

R can only be used when there is evidence for the existence of a principal ray trace. The top frequency for a scattering layer cannot be a true critical frequency even when the scatter pattern rises in height near the top frequency; the proper letter to use in this case is F.

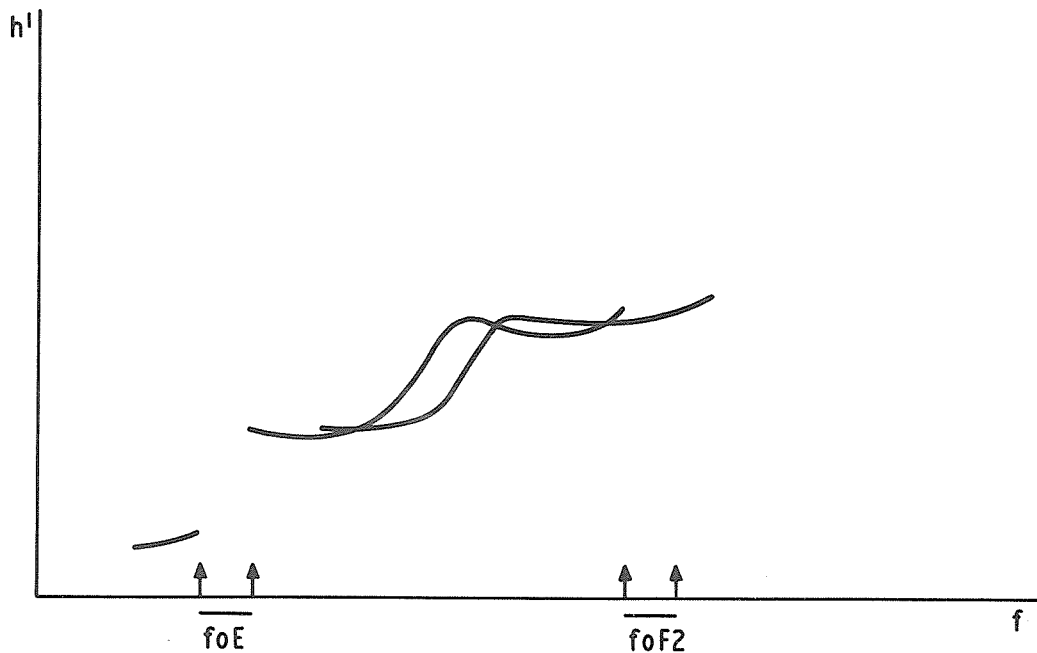

Fig. 3.26 Use of R

Traces show beginning of retardation near critical frequencies and then disappear. If no retardation is seen, Y is likely to be more appropriate (see letter Y).

The accuracy rules determine whether entry should be $(foE)---$, $(foE)-R$, $(f\ddot{o}E)UR$, $(foE)DR$, $(foE)ER$ or R , and $(foF2)---$, $(foF2)-R$, $(foF2)UR$, $(foF2)DR$ or R .

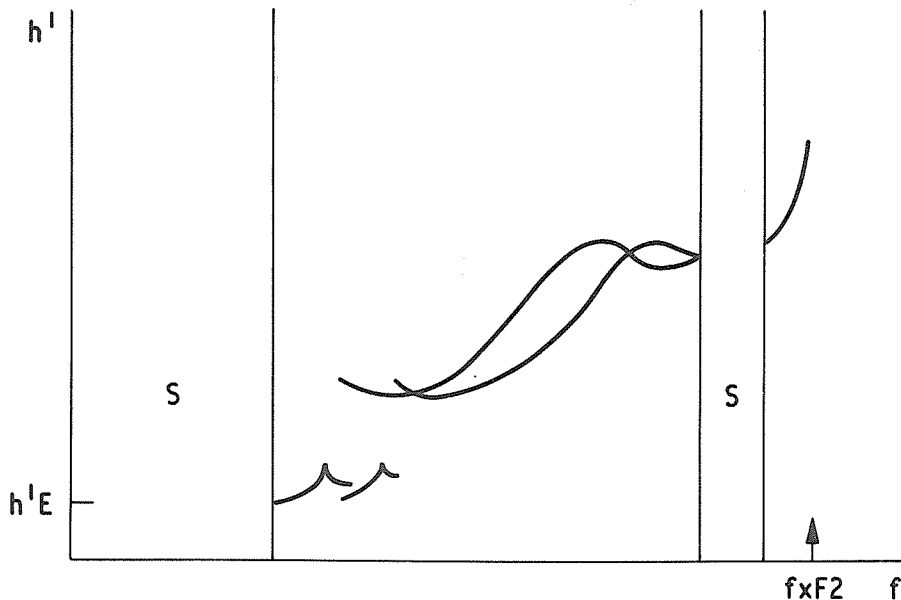

Fig. 3.27(a) Use of S

$foF2$ given by $(fxF2 - fB/2)JS$
 $h'E$ given by $(h'E)ES$

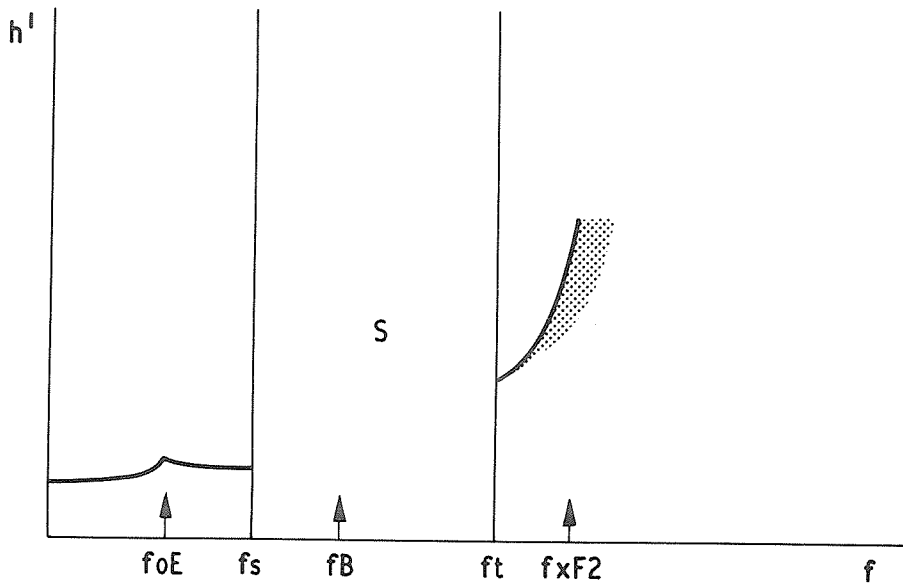

Fig. 3.27(b) Use of S on low frequency ionogram

f_oF2 given by $(f_{xF2} - f_B/2)JS$

f_oE_s and $f_B E_s$ given by $(f_s)DS$

$h'F$ replaced by S as no ordinary ray trace is visible

Note: This should not be used if f_oE_s is usually above f_t at this time of day. Then $(f_t)ES$ is more useful. This is occasionally found in summer months.

If an F trace is seen below f_s and no F traces above f_t , f_oF2 is best given by $(f_t)ES$.

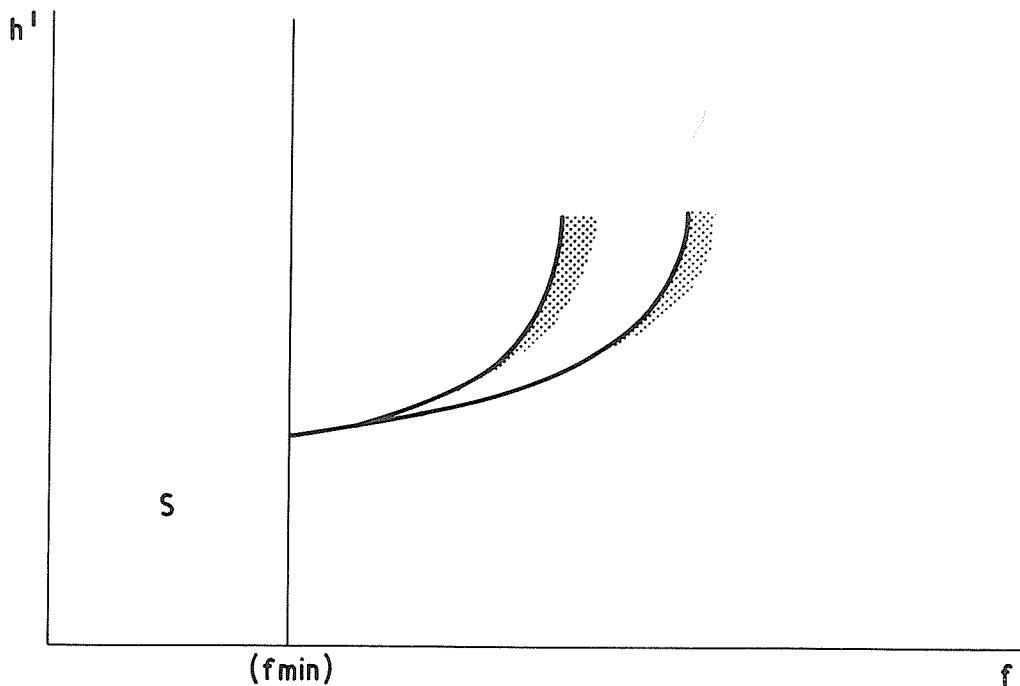

Fig. 3.28 Use of S at night

$h'F$ is given by $(h'F)ES$

f_oE_s , $f_B E_s$ and f_{min} given by $(f_{min})ES$

$h'E_s$ replaced by S

S - Measurement influenced by, or impossible because of, interference or atmospheric.

This letter should be used only when considerable difficulty from either of these causes affects the reading of the characteristic in question; i.e., only to explain a missing, doubtful, interpolated, or 'J' value (Figs. 3.17 and 3.27) [A88I, Fig. 81; A112I, Fig. 138; A113I, Fig. 145].

When the low frequency portions of the traces are obscured by broadcast band interference, the value of f_{min} should be tabulated, qualified by letter E (less than) and described by letter S (Fig. 3.28). Accuracy rules do not apply in this case.

A special difficulty arises with low frequency ionograms where there is often a wide band of broadcast interference present for many hours. As the limits of this are usually rather constant and clearly recognizable in the data, the accuracy rule can be relaxed without danger of confusion. When an E or Es trace disappears into this interference band and does not appear at the upper frequency limit, it is allowed to use (limit value) DS without applying an accuracy rule. In the case of F-layer traces, the corresponding rule is to take the upper limit of the missing band with ES. These values are usually abnormally small relative to the median for f_oF_2 and abnormally high for Es, so that they add to the median count without greatly increasing the difference between first and second medians (Chapter 8).

During night-time hours when f_{min} is tabulated with the qualifying letter E and the descriptive letter S, and no Es is present, f_oE_s and f_bE_s are tabulated in the same way as f_{min} , and $h'E_s$ is replaced by S (Fig. 3.28).

In general, interference known to be due to local causes, e.g., faulty generators, motors or lamps, snow or rain static, should be regarded as an instrumental fault (letter C rather than S).

T - Value determined by a sequence of observations, the actual observation being inconsistent or doubtful.

The descriptive letter T should only be used in those rare cases where an isolated numerical value is so unrepresentative that it has been replaced by an interpolated value from the smoothed f plot. Such values are qualified by the letter T also. This procedure is not allowed for f_{min} , f_xI or for Es characteristics. Most stations ignore T.

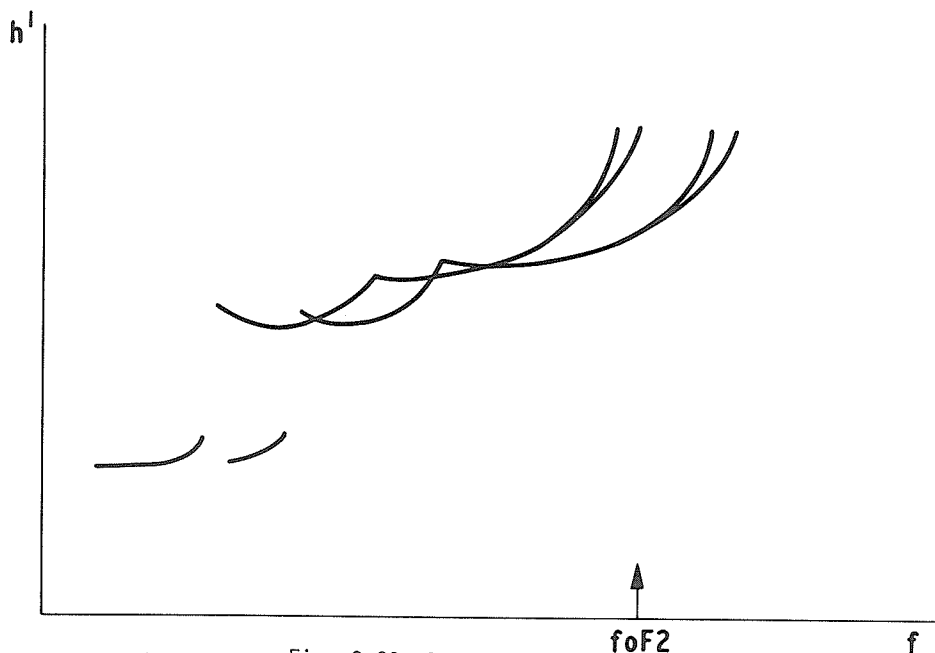

Fig. 3.29 Forked Trace

QUALIFYING AND DESCRIPTIVE LETTERS

V - Forked trace, which may influence the measurement.

Scale the high frequency branch of the ordinary wave component (Fig. 3.29) [A128I, Fig. 149]. Do not confuse obvious oblique echoes, spread echoes or stratifications with forked trace [A88I, Figs. 66, 67, 70, 71; A96I, Fig. 91b; A100I, Fig. 105; A104I, Figs. 115, 122, 124].

W - Measurement influenced or impossible because the echo lies outside the height range recorded [A128I, Fig. 150].

With a normal height range (about 1000 km) cases where the letter W applies to any ionospheric characteristic are extremely rare. Care is needed to avoid using W for F2 characteristics when G is more appropriate. This can be best decided by examining a sequence of ionograms or from the f plot. In general if $foF2$ is close to $foF1$, G applies, whereas if the F2 trace moves bodily with little change of shape, W applies.

When W is used as a descriptive letter the numerical value may be qualified by D or U. W may also be used as a replacement letter when extrapolation is not allowed (Fig. 3.30).

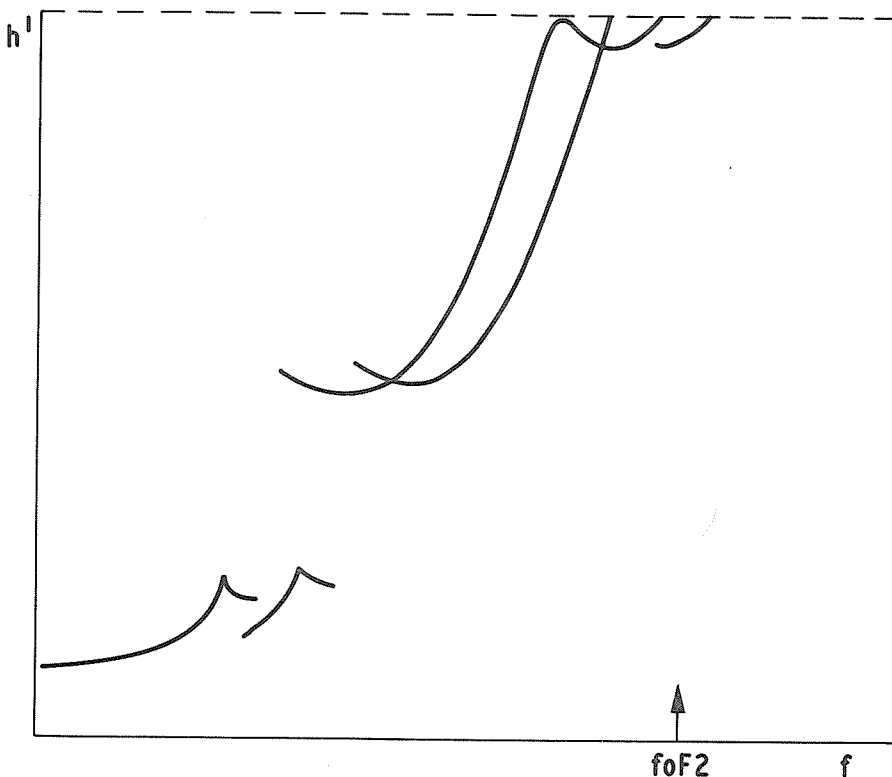

Fig. 3.30 Use of W

If $h'F2$ as shown but $foF2$ cannot be extrapolated, $foF2$ replaced by W.
 If extrapolation possible, use $(foF2)UW$ or $(foF2)DW$ as given by accuracy values.
 If $h'F2$ trace not seen and F1 trace goes above upper height limit, $foF1$ may need to be described by W, $foF2$ replaced by W, $h'F2$ replaced by W.

X - Measurement refers to the extraordinary component.

Letter X shows that the measurement was made using the x trace. It is mainly used to show the presence of an x-mode characteristic in an o-mode table and is analogous to descriptive letter O in an x-mode table.

Letter X is used in fxI tables to show that no spread was present, i.e. $fxI = fxF2$. (When more than half of the values are described by X the median of fxI must be described by X.)

Y - Lacuna phenomena-severe layer tilt.

Letter Y is used to show the presence of wide gaps in the trace pattern due to the Lacuna phenomenon (see section 2.75). When the parameter is missing, Y is used as a replacement letter. Examples of the use of Y when Lacuna is present are shown in Figs. 3.31, 3.32 which represent total F Lacuna and F1 or partial Lacuna, respectively. It is necessary to distinguish the proper use of Y from that of A, B, F, G and H.

The accuracy rules are, as usual, followed; use replacement letter Y, DY, UY, or -Y as given by the rules. This holds for all cases where Y is used, both Lacuna and severe layer tilt cases.

The rules are:

- A - When blanketing sporadic E appears to be present always use A.
- B - The distinction between the presence of high absorption (B) and Lacuna (Y) is based on the fact that absorption causes greater weakening on the low frequencies than on the high and affects the x trace to a greater extent than the o trace, whereas Lacuna causes an abnormal weakening of traces reflected from a given range of heights only.
 - (a) If f_{min} is given by an E trace and there is a wide gap in the traces at higher frequencies or they are missing, Lacuna is present, use letter Y (see H below).
 - (b) If f_{min} is approximately equal to f_{oF1} and any of the following conditions are obeyed, Lacuna is present.
 - (i) The x-mode trace is visible.
 - (ii) The second order o-mode trace is visible.
 - (iii) f_{m2} , the value of f_{min} for the second order F trace is the same as f_{min} within the accuracy rule for an unqualified reading, (strong confirmation).

In this case -

All E parameters are replaced by B
 $h'F$ and $M(3000)F1$ are replaced by Y
 f_{min} is given by $(f_{min})EY$
 f_{oF1} is given by $(f_{oF1})UY$.

- (c) If no traces are seen use letter B even when sequence suggests Y may be present.
- F - When weak scattered F layer traces are seen but there is evidence that Lacuna is present Y should be preferred to F:
 - (a) If the upper end of the E trace is suddenly cut off below the normal value of f_{oE} and the F traces simultaneously become weak and scattered use Y not F.
 - (b) If the F2 trace is normal but the F1 trace is weak and scattered use Y not F. The E trace is most likely to be cut off but may be nearly complete.
 - (c) If part of the F1 trace is missing, f_{min} being given by an E trace, and the remainder is weak and scattered use Y not F.
 - (d) The presence of slant Es with any of above conditions confirms that Y should be used.
- G - (a) When the ionograms before and after the Lacuna event show G conditions for the F2 layer, G should be used in preference to Y.
- (b) When the ionogram sequence shows F2 before and after the Lacuna event and this trace disappears in the event, F2 parameters are replaced by Y.
- H - When there is a gap between the normal E trace and the F trace, Fig. 2.13(c), the lower part of the F trace showing retardation, use H not Y. (This restricts the use of Y to cases where large tilts are present and may be reconsidered later by INAG).

QUALIFYING AND DESCRIPTIVE LETTERS

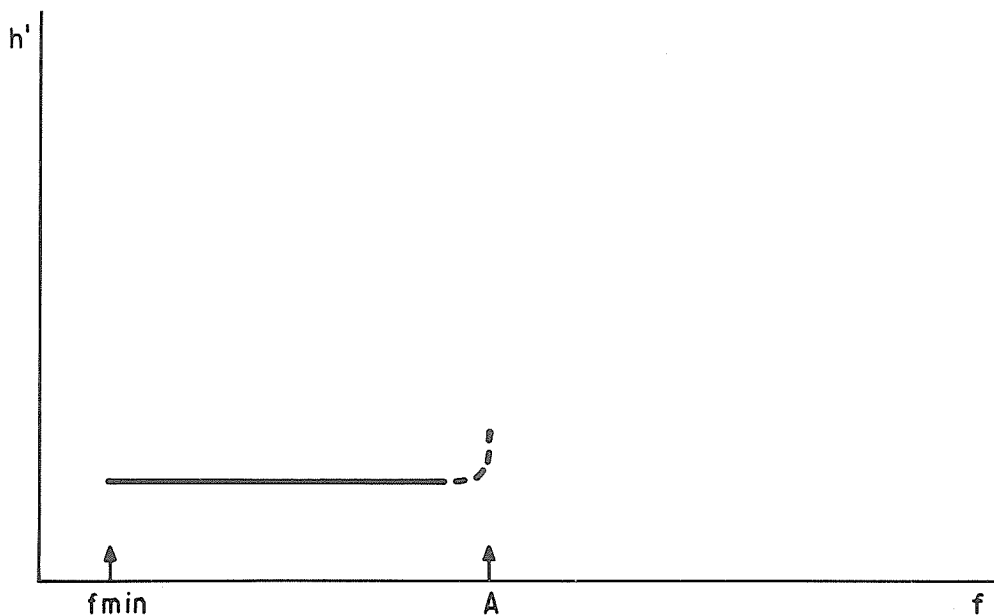

Fig. 3.31 Total F Lacuna

The F1 and F2 traces are missing.

f_{min} is given by an E trace

f_{oE} would be expected at A

$h'E_s$: G. f_{oE_s} , f_{bE_s} : G (preferable $(f_{oE})EG$)

All F parameters replaced by Y. f_{oE} replaced by Y

Note similar pattern can occur with group retardation on

E trace as shown by dots in which case f_{oE} is tabulated as $(f_{oE})UY$.

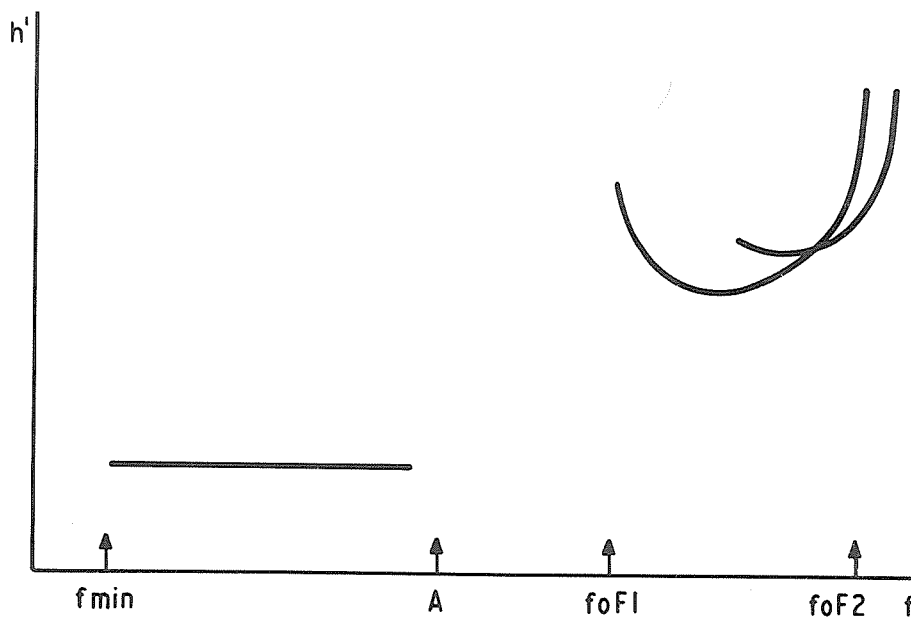

Fig. 3.32 F1 or partial Lacuna

F1 trace is missing

f_{min} given by E trace

f_{oE} would be expected at A

(if f_{oE} is observed use $(f_{oE})UY$).

f_{oE} replaced by Y (unless observed)

$h'F$ replaced by Y

f_{oF1} given by $(f_{oF1})UY$

$M(3000)F1$ replaced by Y

Note: F2 trace appears suddenly at approximately f_{oF1} .

Note Lacuna is often accompanied by Es-s, and this is also often seen when the Lacuna is about to develop or is dying away. The presence of slant Es is a clear distinction between layer tilt and plasma instability which causes Lacuna phenomena.

When Lacuna is present with Es-s the two phenomena are treated independently for scaling (see section 4). Es-s can arise from a normal E trace, a particle E trace (Es-k), or from a blanketing Es trace (usually f, but h, c, & also possible). For convenience the rules are summarized below:

- (a) foEs is deduced from the top frequency of the Es pattern from which the slant Es rises, foE is deduced ignoring the slant trace.
- (b) Slant Es cannot blanket.
- (c) If the Es trace is of a blanketing type, characteristics below the estimated value of fbEs should be replaced by A.
- (d) For experts, the distinction between G and Y (Section 2.75) when no F2 traces are visible is easy and should be made. Where Lacuna phenomena are rare, missing F2 traces are treated as G condition.
- (e) If parts of the F1 trace are missing, the missing F1 parameters are replaced by Y. (See accuracy rule note.)
- (f) If both F1 and F2 traces are missing use G rules given above.
- (g) If the E region trace is Es, the problem of whether Y should be used depends on whether foEs is likely to be influenced by the Lacuna phenomenon. For low, flat or auroral types of Es this is improbable. For particle E or retardation Es the appearance of the ionogram sequence will suggest when Y is needed, i.e., when the nose of the trace is missing. If there is no evidence suggesting that foEs is affected by the Lacuna, it would appear best not to use Y - we know Lacuna is present from the F-layer tables.
- (h) Although slant Es frequently accompanies Lacuna and is usually present at some stage in a Lacuna sequence, its presence is not essential on a particular ionogram. If the F traces are missing, Y should be used for the missing parameters except where G above applies. It is accepted that slant Es is highly gain sensitive, and, therefore, its presence depends on the ionosonde sensitivity.

Severe layer tilts present

There are two important cases:

- (a) Large tilts affecting apparent value of fbEs: If fbEs is greater than foEs, as in Fig. 4.22 use accuracy rule to give appropriate use of Y. When in doubt use replacement letter Y.
- (b) Abnormal pattern near foF2: When the F2 layer is very tilted, the trace rises in the normal manner to a frequency near the expected value of foF2 (as shown by sequence) and then turns over so as to run horizontally, Fig. 3.34. When the signal-to-noise ratio is good it stops suddenly. In this case the wave has been reflected at oblique incidence and the value of foF2 overhead is certainly less than the limit frequency observed. This is probably true in all cases when the trace is concave downwards: the residual doubt is less important than obtaining a numerical limit. Use the top frequency observed qualified by E and described by Y. These conditions may last several hours but are usually short lived. This procedure can only be used when there is independent evidence of tilt or curvature (section 2.7). Convex or linear traces are more likely to be normal traces which are absorbed, UR, DR or R, when tilt is not present. A similar effect can be caused by inadequate antennas or ionosonde, letter symbol C, and this possibility should be considered if the condition is seen regularly. Note the use of Y to identify severe layer tilts is restricted to tilts in the F2 layer for physical reasons. Tilts near F1 are better described by H. Only tilts giving the type of ionogram illustrated in Fig. 3.34 should be identified by Y. H is more appropriate in other cases.

QUALIFYING AND DESCRIPTIVE LETTERS

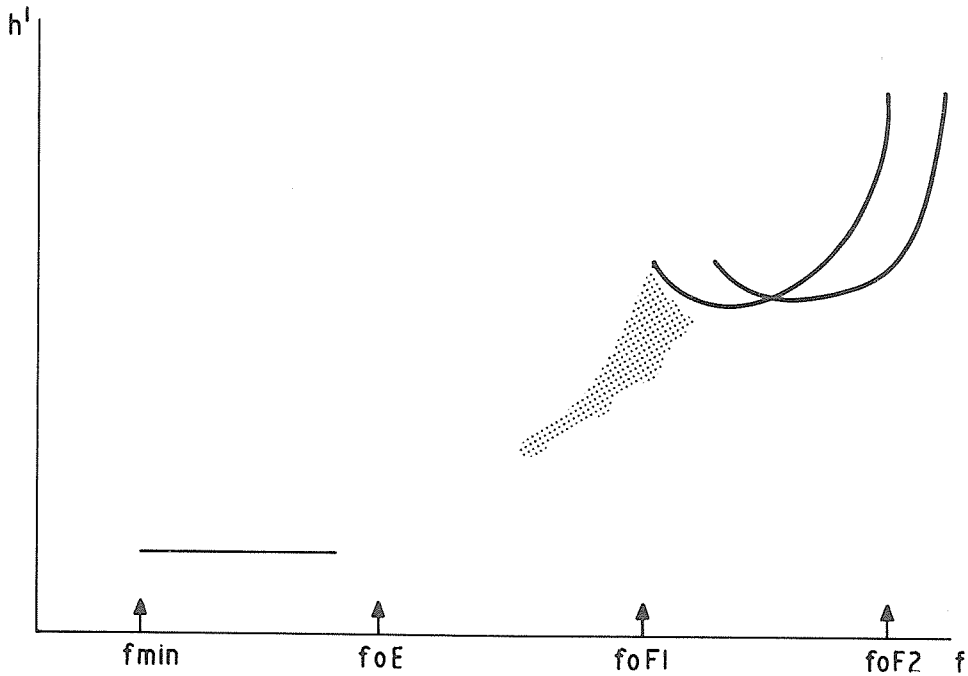

Fig. 3.33 Weak F1 Lacuna

The F1 trace becomes weak and scattered but is still visible.
 fmin given by E trace
 foE cusp not seen foE replaced by Y
 foE seen foE given by (foE)UY
 h'F replaced by Y
 foF1 given by (foF1)UY
 M(3000)F1 replaced by Y
 Note: F1 trace often shows spurs in these conditions.

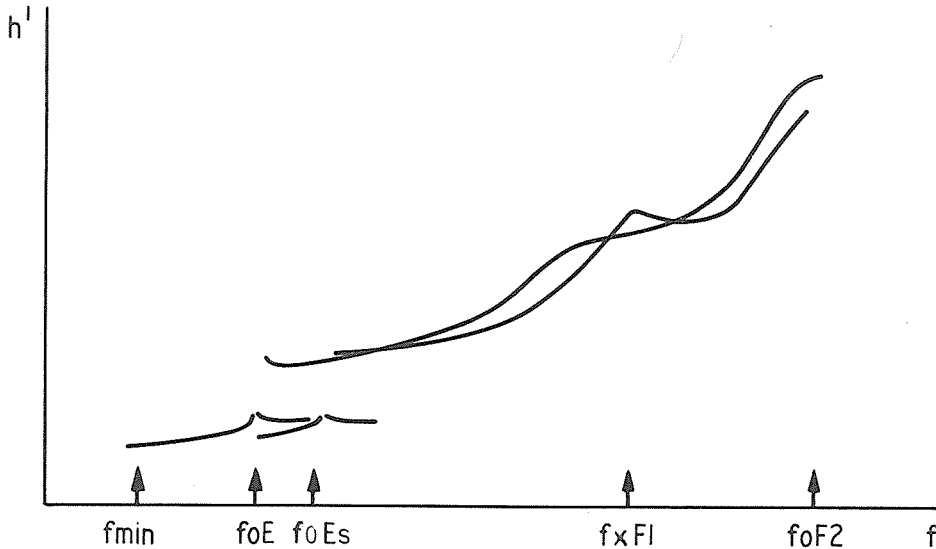

Fig. 3.34 Tilted layer, critical frequency increasing rapidly with distance. Use of Y.

foF2 is (foF2)EY foF1 is (fxF1 - fB/2)JL
 fxF2 is (foF2 + fB/2)OY h'F2 is L; fbEs = (foE)EG

Note: x-mode trace can be similar to o mode or not, depending on whether tilt is E-W or N-S.

Z - Third magneto-electronic component present.

The critical frequency or height parameter is described by Z or a note made in the remarks column of the daily worksheet (Chapter 7), Fig. 3.35, 3.36. Descriptive letter Z is preferred to F when either are appropriate, since Z is usually seen only when spread is present. This is not appropriate if spread-F scaling is being used.

When a z-mode trace extends to or below f_{min} , the value of f_{min} should be described by Z. This applies to all coupling cases (Section 1.05).

Letter Z is used also as a qualifying letter when the o-mode parameter is deduced from the z trace, e.g., $f_oF2 = (f_zF2 + f_B/2)ZF$. This is valuable when there is no main trace or a series of main traces (Fig. 3.35). Note $h'z < h'o < h'x$ so it is not possible to use qualifying Z for height parameters. When f_z is near or below f_B the appropriate value of $f_o - f_z$ (p.9) must be used.

$M(3000)F2$ can be deduced if, with the aid of the z-mode trace, an o-mode trace can be identified at the point of tangency of the transmission curve.

The z- and x-critical frequencies differ by the gyro-frequency and the o-critical frequency is approximately half-way between them (Fig. 3.35). In general, the z trace is less spread than the other components (Fig. 3.35) [A381, Figs. 23, 24; A104I, Fig. 118a,b,c]. It is most commonly observed at high-latitude stations, and may appear in all layers showing magneto-electronic splitting -- F2, F1, E. (Fig. 3.36) and certain types of Es.

The letter Z should be recorded as a descriptive letter with the frequency characteristic of the appropriate layer. At high latitudes, the critical frequency f_zF2 should be plotted on the f plot whenever observed.

The low frequency end of the F region z trace is often mistaken for stratification in F1, resulting in erroneous scaling of $h'F$ (Fig. 3.37) [A104I, Fig. 118a,b]. Sometimes it is also confused with multiples of the E or Es layers.

Since the z component is reflected obliquely, except at the magnetic dip pole, there is always doubt whether or not conditions have changed with the position, and values based on deductions using this component are regarded as doubtful and are therefore qualified by qualifying letter Z (section 3.1).

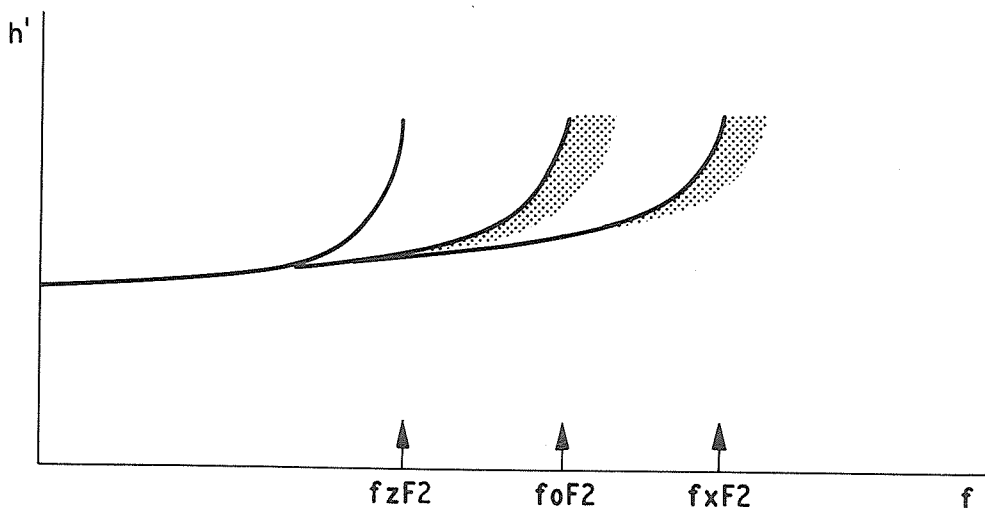

Fig. 3.35 z mode in F region

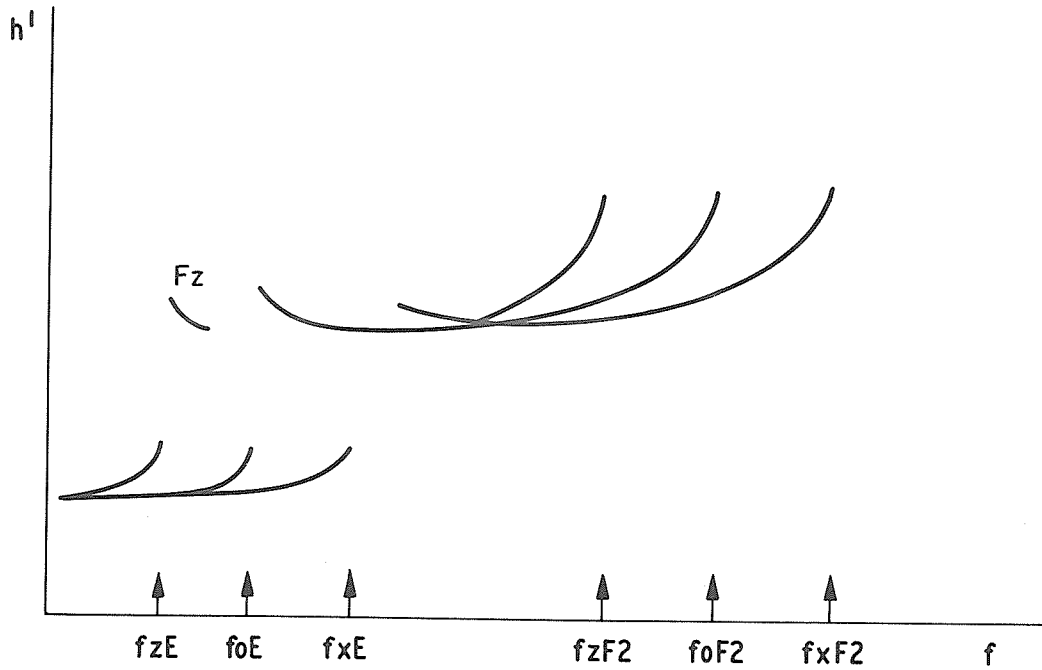

Fig. 3.36 z, o, and x modes in E and F regions

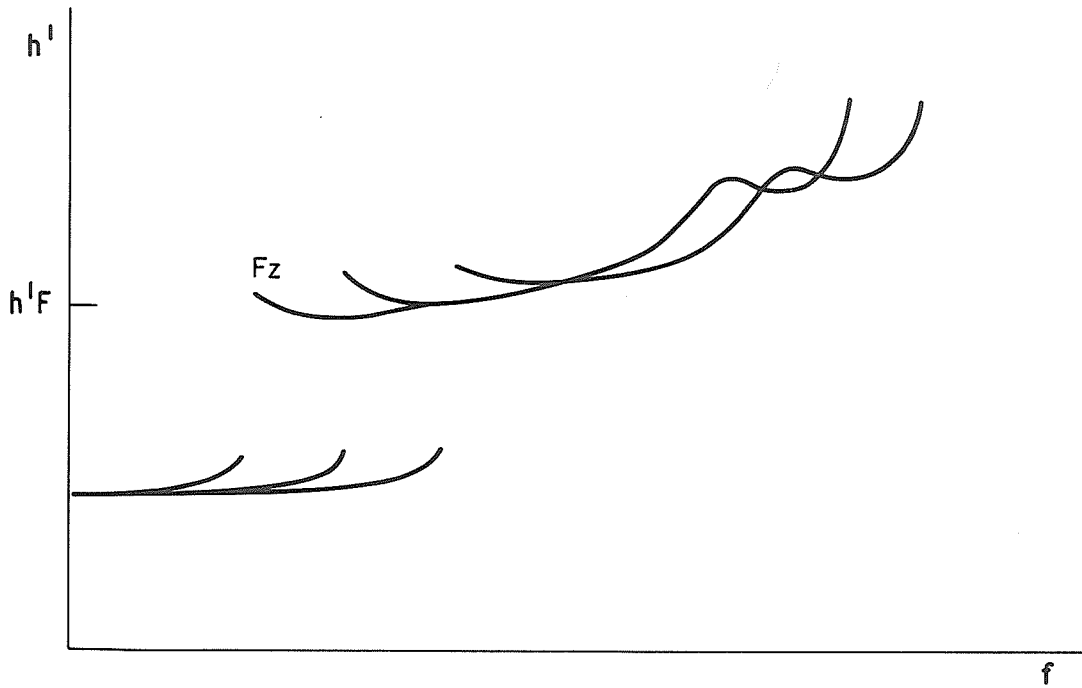

Fig. 3.37 z mode on low frequency end of F trace

3.3 Rules for the Analysis of fxI

3.30. Definition: The parameter fxI is defined as the highest frequency on which reflections from the F region are recorded, independent of whether they are reflected overhead or at oblique incidence. Thus, fxI is the top frequency of spread F traces including polar or equatorial spurs, but not including ground backscatter traces.

In practice it is given by the highest frequency at which F traces are seen on the ionogram with two exceptions:

- (a) Traces due to ground or sporadic-E backscatter are ignored, Fig. 3.38.
- (b) When the top frequency is likely to be due to an o-mode reflection.

Typical examples of fxI measurement are shown in Fig. 3.39. In general the shapes of the patterns can change rapidly and considerably, e.g., in some cases there is no apparent retardation at fxI or near foF2 and h'I can be either greater or less than h'F2.

fxI should be scaled from the normal gain ionogram. When this shows total blackout, (fmin replaced by B); then replacement letter B should be used for fxI.

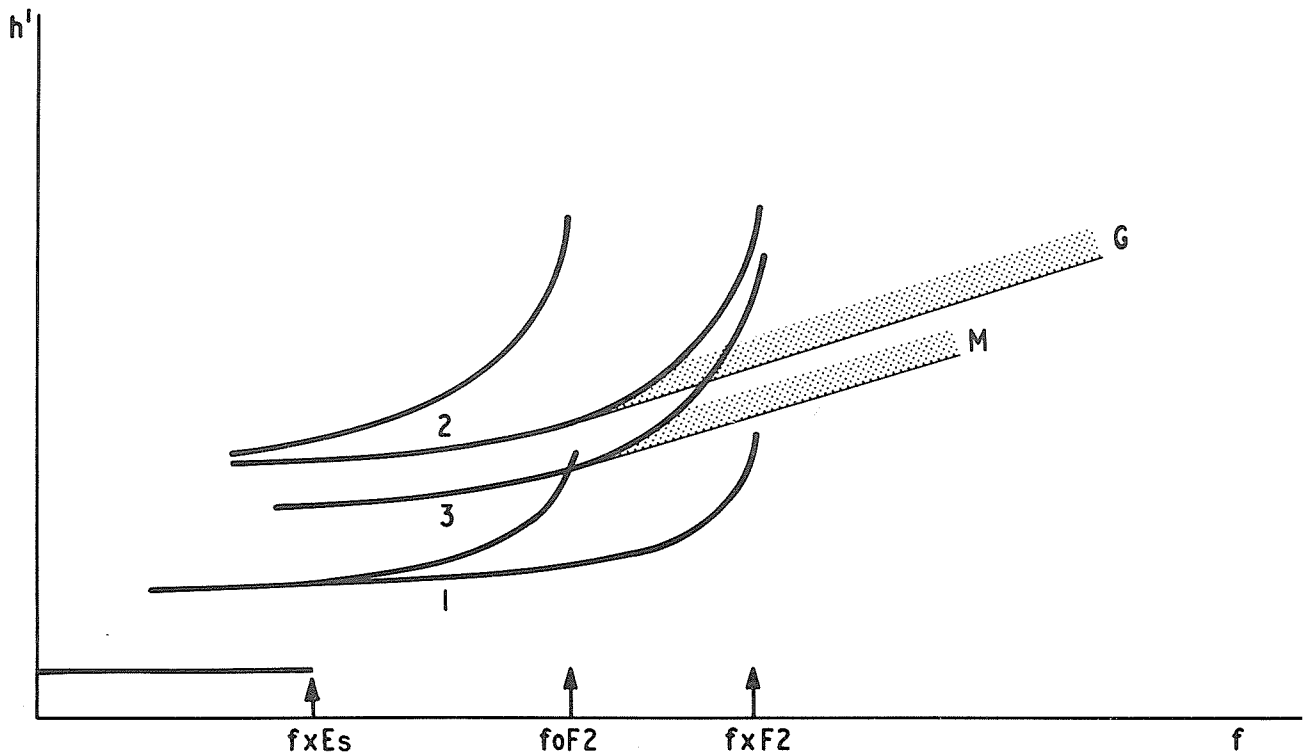

Fig. 3.38 Ground backscatter

The ground backscatter trace G is tangential to the second order x-wave trace (2). Es backscatter is tangential to the M (2F-Es) trace (3). In this case fxI is written (fxF2)-X.

3.31. Accuracy rules: Accuracy rules only apply to fxI for distinguishing between cases when D or E should be used instead of replacement letters C or S. If the possible error is less than 20% or 5Δ whichever is the greater use D or E as appropriate (see D, E) together with the descriptive letter. If the possible error is greater than this, use the descriptive letter as a replacement letter.

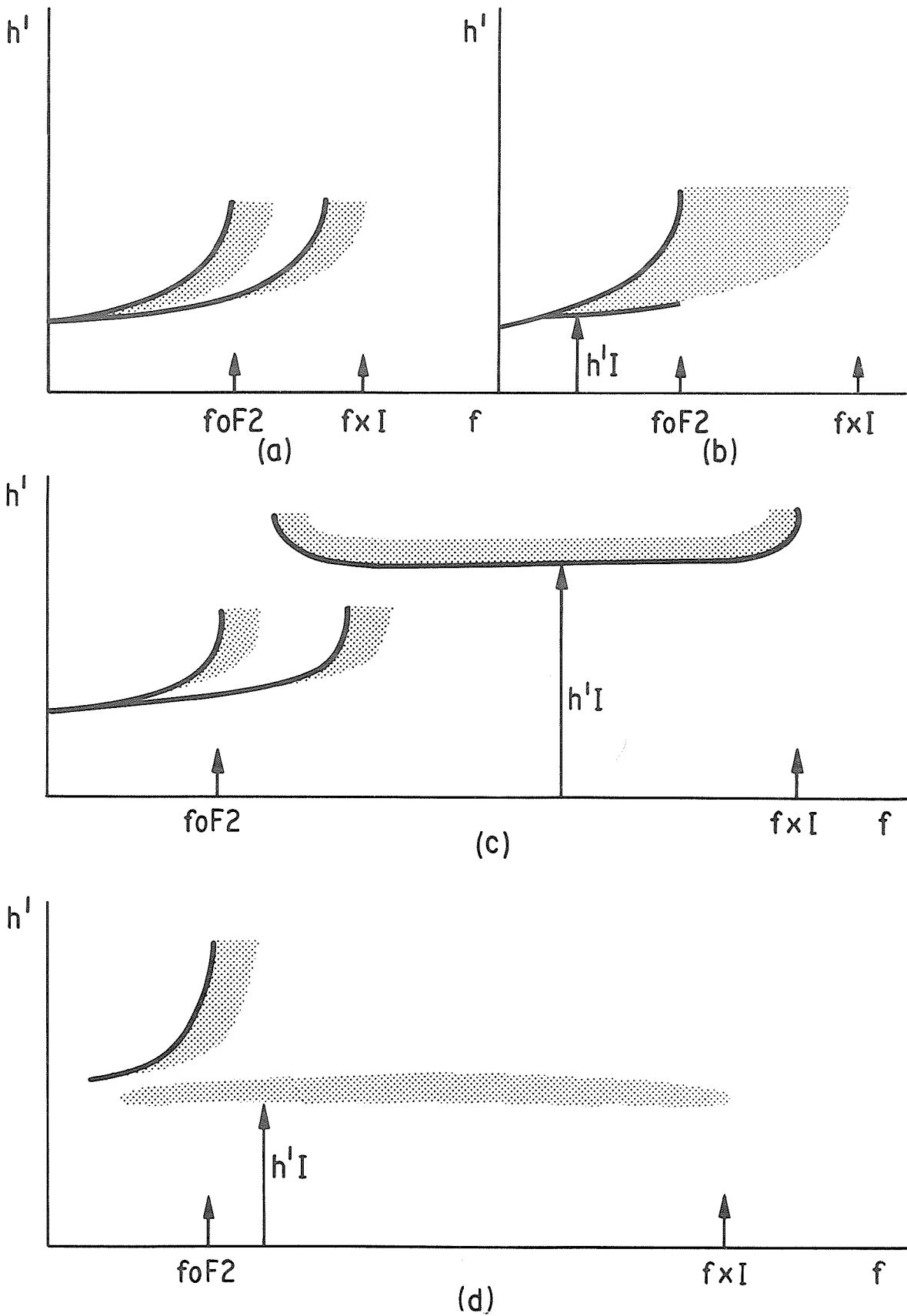

Fig. 3.39 Typical examples of f_xI

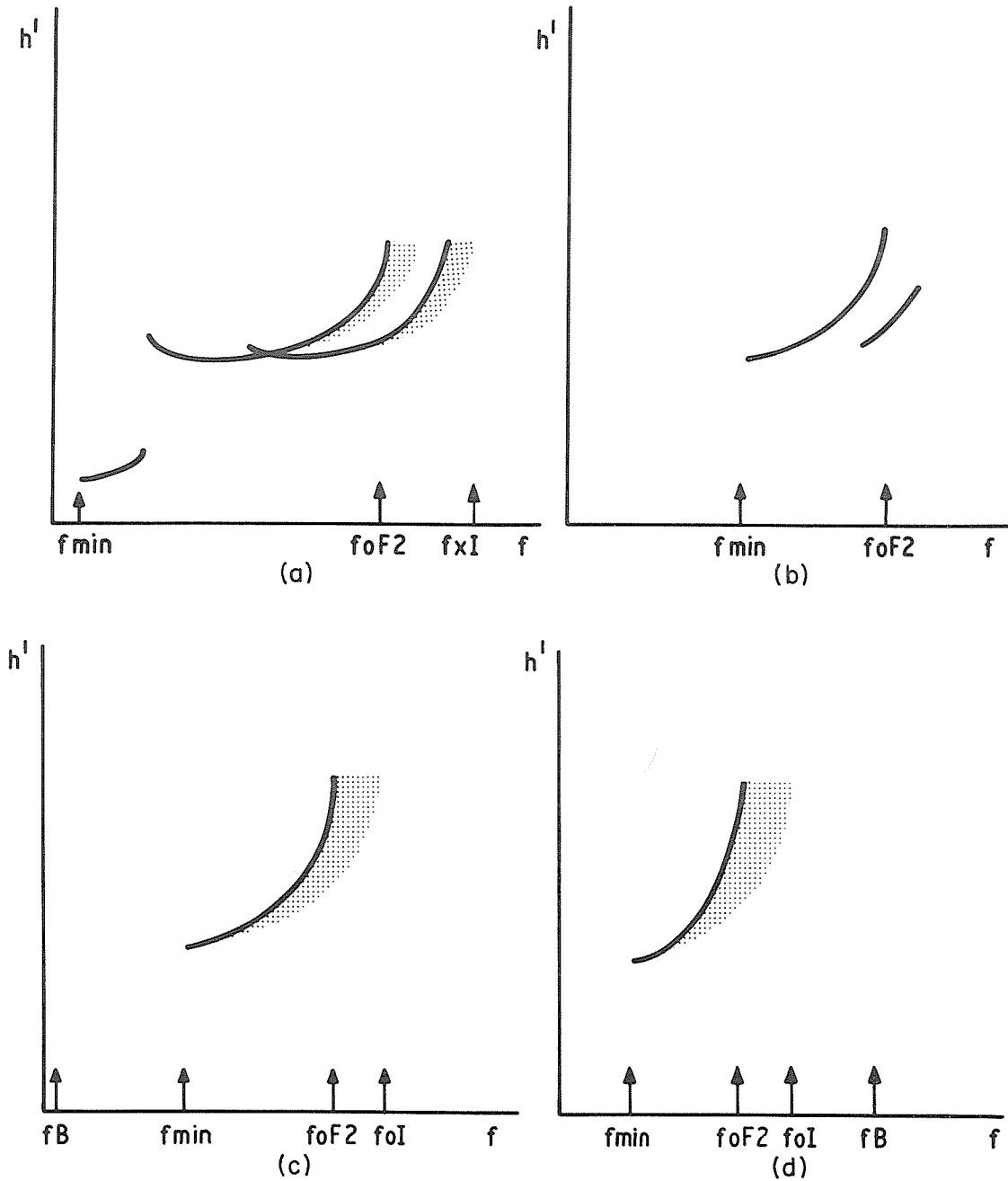

Fig. 3.40 High Absorption Conventions for $f_x I$

- (a) Normal $f_x I = (f_x I)$
- (b) High f_{min} , only main traces visible
 $f_x I = (f_{oF2} + f_B/2)DB$
- (c) High f_{min} , x traces missing
 $f_x I = (f_{oI} + f_B/2)OB$
- (d) f_{oF2} near or below f_B
 $f_x I = (f_{oI} + f_B/2)OB$

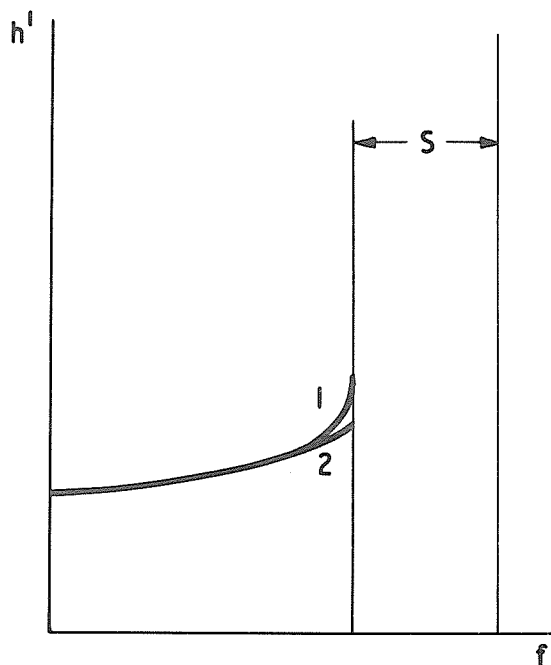

Fig. 3.41 Use of C and S with $f_x I$

For $f_o F_2$ more accurate than 10% and missing band less than 20% or 5Δ :
Use $(f_o F_2 + f_B/2)DS$.

For $f_o F_2$ more accurate than 10% and missing band wider than 20% or 5Δ : Use S.

For $f_o F_2$ more accurate than 20%, $(f_o F_2)DS$ entry; and missing band less than 20% or 5Δ : Use $(\text{top frequency of missing band})ES$.

All other less accurate cases: Use S.

The rules for missing bands due to C are identical except that S is replaced by C.

Note: If the missing band is less than 10% or 3Δ wide, the characteristic is given by the middle value for the missing band with US (see accuracy rules).

3.32. Scaling rules:

- Measure the highest observed frequency of the traces directly reflected from the F layer, e.g., of spread F or polar spurs as shown on the medium gain ionogram. If closely spaced ionograms show the presence of a spread structure which is relatively gain stable, the top frequency of this structure is preferred. Use the ionogram which shows it most clearly.
- The normal descriptive letter symbols should be used to show the reasons for absent entries.
- Monthly tabulation sheets may be left blank for columns at hours for which spread F traces are seldom or never seen, as is the practice for E and F1 parameters. Most groups find it more efficient to ignore this point and tabulate $f_x I$ at all hours.
- When spread is absent, the numerical value of $f_x F_2$ ($f_x F_2$) is used with descriptive letter X: $(f_x F_2)-X$.
- When the spread F structure is not gain stable the value of $f_x I$ from the normal gain ionogram is recorded.

At some stations spread is found on the o trace but not on the x trace even when absorption is low. This is due to the fact that the two traces are reflected at different points separated by typically about 50 km in the magnetic meridian plane. A small movement of the station would, therefore, cause this situation to change. As $f_x I$ is intended primarily to show the existence of spread F near the station it is preferable to deduce the value from $f_o I$, $f_x I = (f_o I + f_B/2)OF$ (F, if spread F typing is in use, otherwise B). This also makes the analysis simple -- always look at the o trace if the x trace is clean and deduce $f_x I$ from it.

ANALYSIS OF fxI

3.33. Use of descriptive letters: Apart from the modified accuracy rule given above, the use of the following descriptive letters is the same as for other parameters: C, D, E, G, S, Y.

For letters A and B the following special rules apply:

- A - The value of fxI is replaced by letter A when the presence of lower thin layers, such as Es, prevent observation of all F-layer traces.
- B - There are a number of cases where descriptive letter B is appropriate. The principal rules are given first and then the particular cases.
 - (a) If all traces disappear as a result of absorption use replacement letter B. If traces can be seen on the high gain ionogram only, use rules (b) or (c), as appropriate.
 - (b) If the spread traces disappear as a result of absorption but the normal traces can still be seen, use (fxF2)DB. The numerical value (fxF2) can be deduced from foF2, Fig. 3.40(b).
 - (c) If the x-mode scatter traces are missing because of absorption, use the top frequency of the o-mode scatter trace, foI, plus fB/2 together with qualifying letter O and descriptive letter B : (foI + fB/2)OB, (Fig. 3.40(c)).
 - (d) If fmin is high, showing large absorption, and the value of fminx cannot be determined, use qualifying letter M (interpretation doubtful: reading may be foI instead of fxI) and descriptive letter B.

Note: When the signal/noise ratio is low, fxI is power sensitive; when high, it is usually independent of power as far as is known at present.

- (e) If fmin is normal and foI is near or below fB, fminx will be greater than fB and fxI is given by (foI + fB/2)OB, Fig. 3.40(d). The probable value of fminx for this case can be deduced from ionograms having the same value of fmin but larger values of foF2.

3.34 Use of z-mode trace: At night in sunspot minimum years foF2 can fall into the medium wave broadcasting band and be hidden by interference. A missing value of fxI in these cases can be deduced from the z-mode trace using the relation:

$$fxI = fzI + fB$$

The value of fxI is given by (fzI+fB)ZS.

If the z trace is not spread in these circumstances this is most likely to be due to absorption. Use (fzF2+fB)DB.

This rule is only useful when an ionosonde operating to low frequencies is available (e.g., down to 0.2 MHz). In other cases this section should be ignored.

4.0 General Considerations

The scaling conventions for the Es parameters to be circulated on a world-wide basis are based on a compromise. It is clear that a wide variety of phenomena are included under the name sporadic E, and the study of these phenomena is not yet sufficiently developed to permit them to be considered separately on a world-wide basis [A40I, Figs. 31, 33, 34; A88I, Figs. 64, 77-79; A96I, Figs. 87-91, 93-99; A112I, Figs. 130, 131, 141, 142]. Diagrams illustrating Es have been given in Figs. 1.2, 1.8, 1.9, 1.11, 2.19, 3.1, 3.2, 3.3, 3.4, 3.5, 3.6. The distinction between types of Es facilitates the study of this problem (section 4.8). An additional difficulty arises because a given type of trace may arise from different causes, particularly in widely spaced parts of the world. It is always tempting to regard the current local interpretation as general and to simplify the rules accordingly. This is advantageous for local studies but can cause serious discontinuities in the compatibility of data from different regions or epochs.

The basic rule is that all traces from E region height except normal E (and E2), should be treated as sporadic E traces.

The distinction between blanketing and non-blanketing traces is very important both scientifically and operationally, and tabulations of the blanketing frequency fbEs can be at least as useful as those for foEs. It should be noted that fbEs is determined at a well defined place where the ray path of the first higher echo goes through the Es layer. In contrast, foEs corresponds to the highest ordinary-wave frequency returned from Es in the sounding cone (which usually has an aperture of about $\pm 10^\circ$) by a reflection or scattering mechanism. In most cases at high latitudes the Es traces found during disturbed conditions are blanketing when overhead and non-blanketing when seen at oblique incidence. Both parameters are highly variable in time so that it is particularly important that the number of values which contribute to the medians should be kept as large as possible.

The Es characteristics to be scaled (Fig. 4.1) fall into two groups: (1) numerical measurements, e.g., foEs, fbEs, h'Es, which must be made sufficiently homogeneous to be useful for geophysical studies and the prediction of radio frequency propagation phenomena; and (2) type indices showing the incidence of different types of Es traces with time and position on the world.

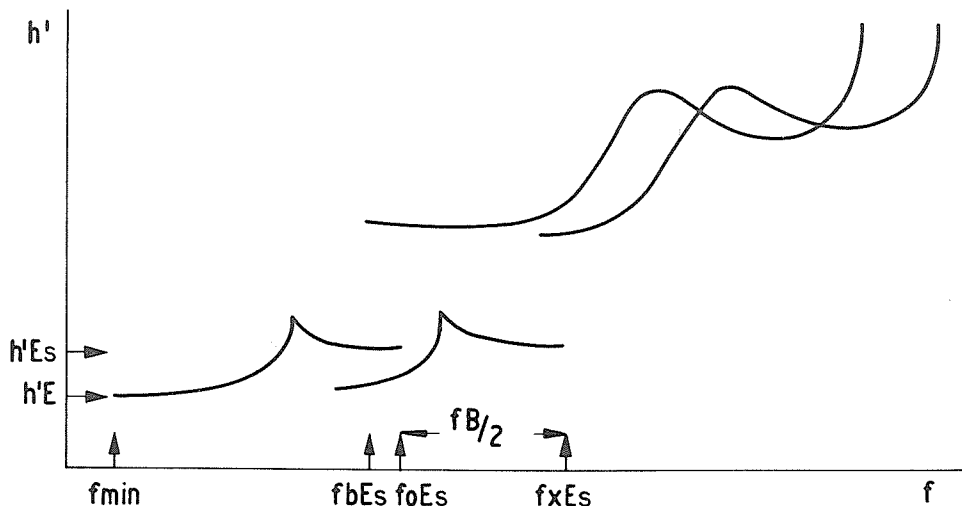

In the use of data foEs has considerable advantages over fxEs and the provision of homogeneous tables of either parameter is more valuable than a table containing a mixture of both, even when individual values are clearly marked as due to o or x components. The international standard parameters are, therefore, based on the ordinary-wave component though departures from this convention are permitted where really necessary. The rules given for identifying the ordinary-wave component can, of course, be used to identify the extraordinary-wave component also. It is always implied that values tabulated as foEs have been obtained using the standard rules given below. Rules are also given to enable fxEs to be scaled if this is found to be desirable (see section 4.5).

At stations where the advantage of scaling fxEs rather than foEs is great, tables of fxEs may be substituted for those of foEs. For practical reasons the blanketing frequency fbEs and the virtual height h'Es must always refer to the ordinary-wave component. The following rules have been arranged using the assumption that the characteristics scaled are foEs, fbEs and h'Es. They apply with appro-

appropriate changes (indicated in section 4.5) if $f_x E_s$, $f_b E_s$ and $h' E_s$ are the characteristics scaled. The selection rules for $f_o E_s$ and $f_x E_s$ are summarized in a table in section 4.32.

Where the data from a station are processed mechanically it is not essential to make the original reductions homogeneous, provided the different components are clearly identified by one or other of the descriptive letters O and X, or, in really doubtful cases, M. The process of adding or subtracting $f_b/2$ can be done mechanically so as to produce homogeneous tabulations for interchange. This relaxation of the rules is allowed only when the operator knows that the corrections will be made by computer and that he has taken precautions to use symbols O, X, M accurately.

Storm types of Es trace (Es types a and r) often change into the trace of a thick E layer, particle E or vice versa. $f_o E_s$ and $f_b E_s$ then become equal to the critical frequency of the particle E ($f_o E$)-K. As discussed in detail in section 4.2 the characteristics $f_o E_s$ and $f_b E_s$ are shown in both Es and E tables when particle E determines $f_o E_s$.

4.1 Es Characteristics to be Tabulated

4.11. The following characteristics are normally tabulated for Es:

- $f_o E_s$: The ordinary-wave top frequency corresponding to the highest frequency at which a mainly continuous Es trace is observed.
- $h' E_s$: The lowest virtual height of the trace used to give $f_o E_s$.
- $f_b E_s$: The blanketing frequency of an Es layer, i.e., the lowest ordinary-wave frequency at which the Es layer begins to become transparent. This is usually determined from the minimum frequency at which ordinary-wave reflections of the first order are observed from a layer at greater heights.

Note: $f_o E_s$, $f_b E_s$ and $h' E_s$ must all be scaled using the same Es trace.

A numerical value for $f_o E_s$, $f_b E_s$ and $h' E_s$ (with qualifying and descriptive letters, where appropriate) or a descriptive letter replacing a value, is entered on the daily tabulation sheet for all of the 24 hours.

4.12. Es types: There are eleven specified categories into which Es traces are classified (section 4.8). The number seen at one station is usually smaller.

4.13. Units for tabulation:

$f_o E_s$ and $f_b E_s$: 0.1 MHz

$h' E_s$:

- (a) with expanded height scale ionograms, 1 km;
- (b) when scaling accuracy is better than ± 2 km tabulate to nearest odd km at least;
- (c) when scaling accuracy is better than ± 5 km tabulate to nearest 5 km.

4.2 Es Scaling Conventions

4.21. Since the values of $f_o E_s$ and $f_b E_s$ observed can change with the sensitivity of the ionosonde, these parameters should be deduced using the ionogram obtained at normal (medium) gain.

4.22. $h' E_s$ should be scaled using the ionogram on which it can be measured most accurately.

4.23. Traces due to thick occulting layers, such as 'E2' or other 'intermediate layers' in the day should not be included in Es tabulations (this does not apply to particle E), (see below).

4.24. Rules when particle E is present: When $f_o E$ at night is greater than the value appropriate for normal E (K condition, section 3.2), particle E is present. This is usually preceded by Es type r. The critical frequency of particle E is usually much greater than for normal E at this time. Typical stages in the development from retardation Es (type r) to particle E are shown in Fig. 4.2. Occasionally the sequence of Fig. 4.2 is found with Es type a traces instead of Es type r traces. In particular, the F traces show the same sequence, and with the same interpretation. (See High Latitude Supplement).

Case (i) No retardation at low frequency end of F trace, Fig. 4.2(a), Es type r; $h' E_s$, $f_o E_s$, $f_b E_s$ as shown.

If $f_o E$ below f_{min} , $f_o E$ is $(f_{min})E_b$, $h' E$ is B^*

If $f_o E$ above f_{min} , $f_o E$ is $(f_b E_s)E_a$, $h' E$ given by E trace (very uncommon except on low frequency ionograms).

* Footnote: For hours when $f_o E$, $h' E$ are not usually recorded the entry should be left blank unless particle E is seen to be present. $h' E$ and $h' E_s$ entries must be made when numerical values of $f_o E$ and $f_o E_s$ are available. These may be numerical or replacement letters.

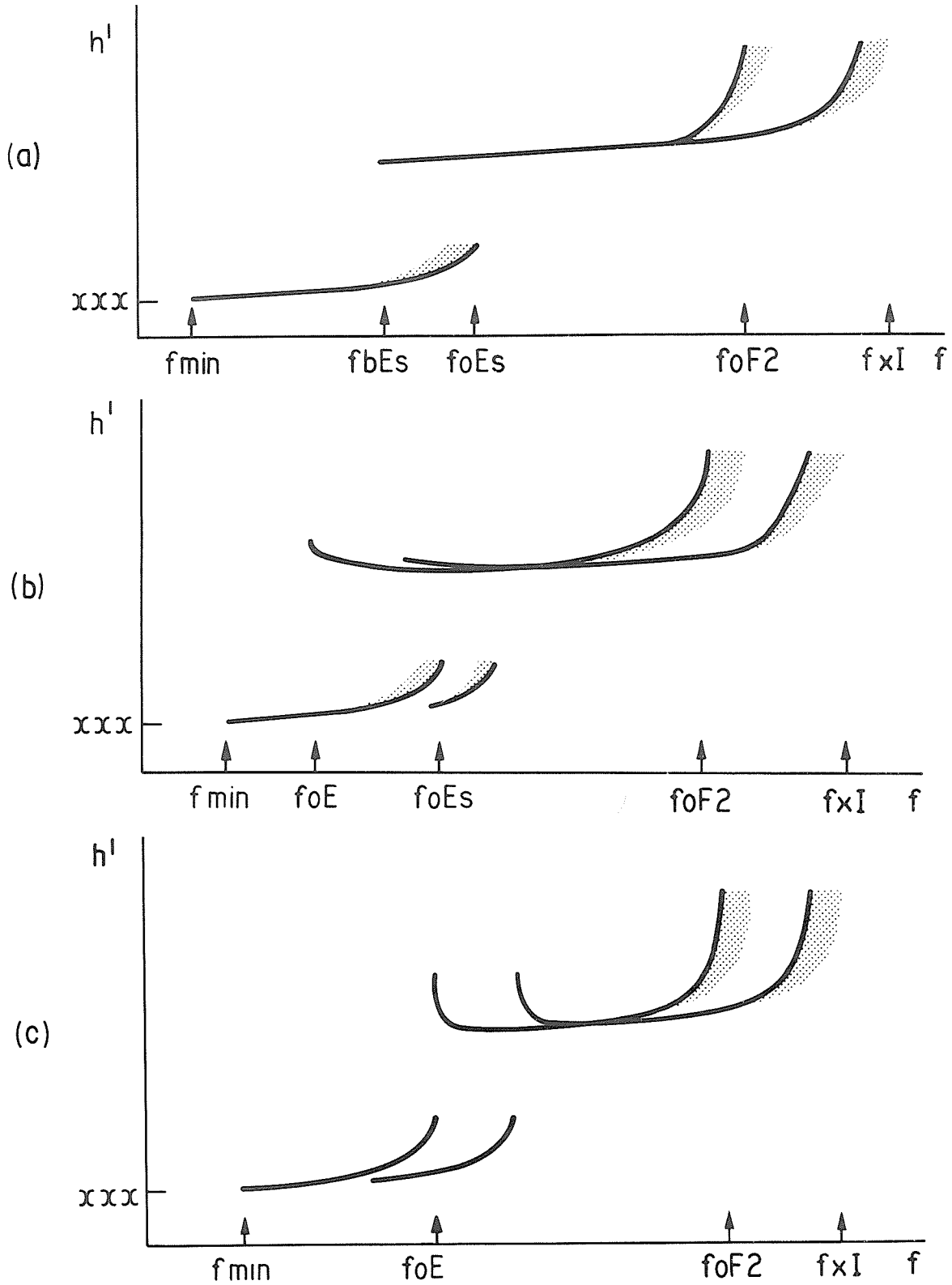

Fig. 4.2 Conventions for Es type r and particle E

(a) (b) show Es type r (c) particle E
 In (b) f_{oE} for night can be seen by retardation of F trace; (f_{oE})UK but $h'E$ is A
 In (c) f_{oEs} and $f_{bEs} = (f_{oE}) - K$ $h'Es = (h'E) - K$

Case (ii) Retardation at low frequency end of F traces, Fig. 4.2(b), Es type r, foEs as shown.

fbEs is (foE)UK h'Es is xxx
foE is (foE)UK h'E is A

(There is always some doubt when only half a cusp is visible; hence, U preferable. Also E layer could be above Es-r.)

Case (iii) Particle E, Fig. 4.2(c).

Es type k (particle E)
foEs is (foE)-K h'Es is (h'E)-K
fbEs is (foE)-K
foE is (foE)-K h'E is xxx-K

Note, unless fmin is high, both o and x traces will normally be seen when particle E is present.

Whenever fbEs is given by a particle E trace, fbEs = (foE)-K. The entry (foE)-K must be put in both the foE and the appropriate Es tables (foEs and fbEs).

Case (iv). Particle E with another Es type present (example not shown). Es types h, c, l and a occasionally occur superposed on a particle E trace. In these cases foEs, fbEs, h'Es are given by the trace with the highest critical frequency. The presence of particle E is shown in the normal E tables under foE, h'E with descriptive letter K and in the Es types table. When the Es type is not blanketing the normal G rule applies, fbEs = (foE)EG.

4.25. When no Es echoes are observed the following conventions are adopted:

If a trace corresponding to a thick layer in the E region, e.g., normal E, or retardation is present at the low frequency end of the ordinary-wave F-region trace, the descriptive letter G must be used; appropriate rules are found in section 3.2 (G), (Fig. 4.3).

If fmin is greater than the lower limit of the ionosonde and absorption is clearly indicated, foEs = fbEs = (fmin)EB and h'Es = B, except when letter G applies.

In all other cases the descriptive letter used for fmin should also be used to describe the absence of the Es trace (e.g., C, E, S).

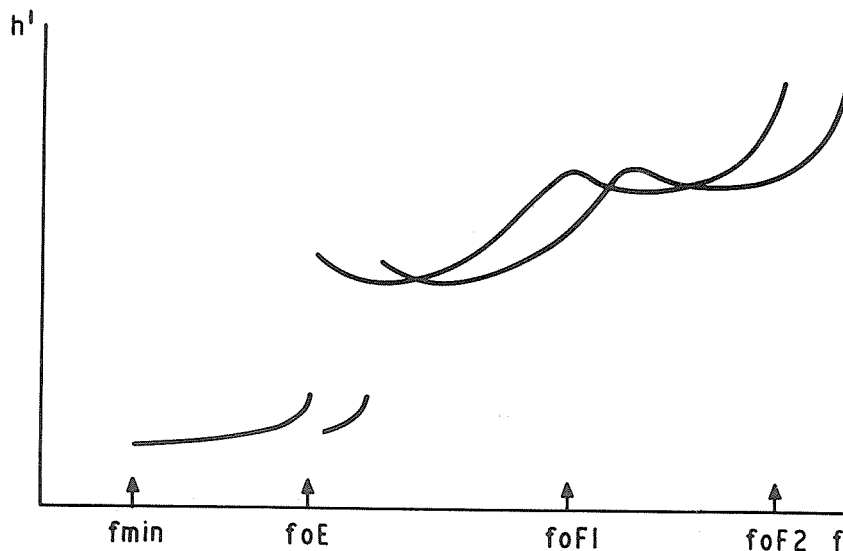

Fig. 4.3 No Es present. Use of G.

foEs is (foE)EG
fbEs is (foE)EG
h'Es is replaced by G

4.3 Techniques for Distinguishing between the Magneto-electronic Components in Es Traces

4.30. The evaluation of foEs depends on distinguishing whether the top frequency, ftEs, observed is due to an ordinary, foEs, or extraordinary, fxEs, wave reflection. There are a large number of possible cases which are discussed in detail in section 4.31, paragraphs (a) to (g) and summarized in section 4.32. These enable any difficult case to be evaluated. For most ionograms there is little difficulty since there are ample indications (e.g., 4.31(a), (b)) of whether ftEs is fxEs or foEs. In most practical cases it is fxEs. The simplest criterion is to see if F region x traces are present at or below ftEs; if so, it is fxEs, if not foEs. When absorption is not present, e.g., at night for most latitudes, ftEs equals fxEs if it is more than about 250 kHz above the gyrofrequency fB and foEs if it is below this frequency. Near fB it is foEs. Borderline cases should show easily recognized, separate o and x traces. During daytime hours, observe the relation between the minimum frequency of the x traces, the number of multiple traces present and their minimum frequencies. Usually absorption conditions are similar from day to day and hour to hour so that if ftEs is seen at a frequency where x traces are usually seen it will be fxEs. Always try to use several tests in doubtful cases, and refer to the paragraphs below to make sure the correct interpretation has been made. As fmin increases due to absorption, the lower frequency part of the x trace disappears and it becomes more likely that ftEs equals foEs. Always check that no F-layer x trace is visible at or below ftEs.

If the ionosonde is faulty, a logical approach may not be successful. Direct comparison of the difficult case with ionograms with identifiable Es traces, or with no Es and similar absorption, will usually show clearly whether ftEs is fxEs or foEs.

4.31. Detailed rules for distinguishing foEs:

- (a) For normal thick reflecting layers, differences in the virtual height of reflection of the two magneto-electronic components generally enable the two traces to be identified easily. The daytime 'c' and 'h' types of Es give traces which can often be identified by the changes in height of the trace due to retardation in the normal E layer (Fig. 4.1). However, for most types of Es trace the two components are superposed at essentially the same height and other criteria are necessary.
- (b) When absorption is present, a clear distinction is often possible because the absorption of the x component is normally greater than that of the o component at the same frequency. The x component is also greatly weakened at frequencies near the gyrofrequency, even when the normal absorption is very small.
- (c) At night, when the absorption is usually negligible, comparison of the top frequency of the Es trace, ftEs, and the gyrofrequency, fB, gives the following rules:

$$\begin{array}{ll} \text{If } ftEs < fB & \underline{ftEs} = \underline{foEs} \quad (\text{Fig. 4.4}) \\ \text{If } ftEs > fB & \underline{ftEs} = \underline{fxEs} \quad (\text{Figs. 4.5 and 4.6}) \end{array}$$

- (d) Systematic inspection of the ionogram can very often determine which component is present at the high frequency end of the trace, even in cases where both traces are superposed and show no obvious distinguishing features. The first method depends, in essence, on comparing ftEs with the minimum frequency of the x-component trace for the ionogram as a whole, fminx. This is necessarily above the gyrofrequency. If Es traces occur at frequencies above fminx, the extraordinary component must be present. Hence the top frequency, ftEs, must correspond to the extraordinary component. If the Es trace stops at a frequency below fminx the extraordinary component cannot be present.

$$\begin{array}{ll} \text{Thus if } ftEs \geq fminx & \underline{ftEs} = \underline{fxEs} \\ \text{and if } ftEs < fminx & \underline{ftEs} = \underline{foEs} \end{array}$$

The rule can only break down if there is a sudden change in the sensitivity of the ionosonde with frequency. This should not occur with properly maintained modern equipment, but is readily recognized when present. Clearly it is not necessary to measure fminx, it is sufficient to know that fminx is greater or smaller than ftEs.

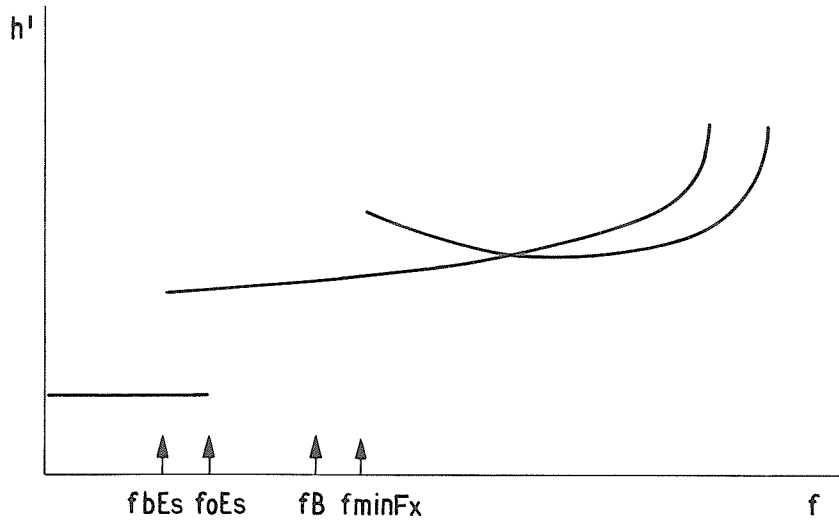

Fig. 4.4 f_{tEs} below f_B at night, f_{tEs} is f_{oEs} .

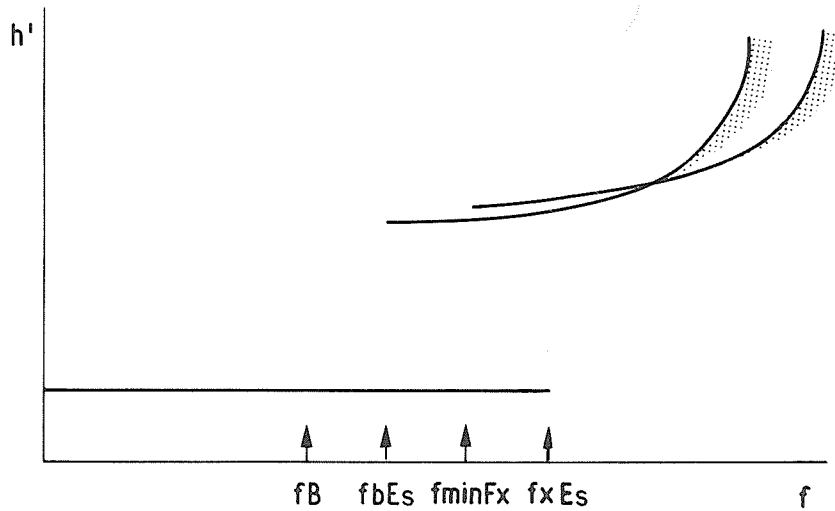

Fig. 4.5 f_{tEs} above f_B at night
 f_{tEs} above f_{minFx} so f_{tEs} is f_{xEs}
 Note f_{min} low so absorption small.

(e) The high frequency end of the record should be inspected first. In most cases there is no difficulty in recognizing the two components in the F traces and the low frequency end of the F-layer x trace is easily found. This is called f_{minFx} and provides a useful practical criterion. Three cases can arise in practice:

(i) $f_{tEs} > f_{minFx}$ (Fig. 4.7)

The Es trace must contain an x component and hence $f_{tEs} = f_{xEs}$.

(ii) $f_{tEs} = f_{minFx}$ (Fig. 4.8)

When the difference δ between f_{tEs} and f_{minFx} is less than half the gyrofrequency, $f_B/2$, the top frequency cannot be f_{oEs} without an x trace appearing at higher frequencies. Therefore $f_{tEs} = f_{xEs}$. This is shown by an indirect argument: Suppose the Es trace visible up to $f_{minFx} - \delta$ is an ordinary trace ($\delta \leq f_B/2$). Then the corresponding x trace should stop at $(f_{minFx} - \delta + f_B/2)$ and this is higher than f_{minFx} . Thus this trace cannot be absorbed and should be visible on the ionogram. As this is not true in the case we consider, the hypothesis that we have an ordinary trace must be wrong, so that $f_{tEs} = f_{xEs}$.

(iii) $f_{tEs} < f_{minFx}$

Two subcases are possible:

(1) No E-region trace (neither E nor Es) appears within half the gyrofrequency below f_{minFx} (Fig. 4.9). This shows that, taking the ionogram as a whole, the x trace stops at f_{minFx} so that $f_{minFx} = f_{minx}$. Hence the observed Es trace cannot be an x trace and $f_{tEs} = f_{oEs}$.

(2) An x trace from a thick layer in the E region is present (E or E2). In this case the arguments used above are repeated for f_{minEx} instead of f_{minFx} giving the three cases illustrated in Figs. 4.10, 4.11, 4.12.

These rules can fail if the equipment limitation mentioned in (d) above is present.

(f) There remain the cases where f_{minFx} cannot be determined. If this is due to total blanketing (Fig. 4.13), in conditions for which we would normally expect to see the F traces we should presume that the missing F-layer x trace is replaced by an Es-layer x trace and therefore $f_{tEs} = f_{xEs}$.

Sometimes, but rarely, ionograms are obtained which apparently differ from the cases discussed above. These differences are most commonly due to layer tilts causing oblique sounding reflections. For example see the discussion on f_{bEs} (Fig. 4.22(a) (b)). The remaining case where f_{minFx} cannot be determined although an Fx trace is present is the only difficult one. This condition is found when both components are superposed (Fig. 4.14) or when scatter is present (Fig. 4.15). This is discussed in (g) below.

(g) It is only necessary to attempt to identify the Es traces directly when the frequency rules cannot be applied. When no absorption is present rule (c) always applies. When absorption is present we may use our experience of the usual behavior of the ionosphere, at most stations, to provide a basis for informed reasoning of the probable interpretation.

If f_{tEs} is comparable with f_{oE} it is probable that the x component of the Es trace is absorbed and $f_{tEs} = f_{oEs}$ (Fig. 4.16). This class is extremely rare as almost all cases can be solved by normal rules.

If f_{tEs} is considerably higher than f_{oE} , assume that the x trace is present and $f_{tEs} = f_{xEs}$ (Fig. 4.17).

If absorption is present at night but no particle E is visible the value of f_{min} may be used to estimate whether $f_{tEs} = f_{oEs}$ or $f_{tEs} = f_{xEs}$, high values of f_{min} suggesting the former. In particular if f_{tEs} is near f_{min} , $f_{tEs} = f_{oEs}$ (Fig. 4.18).

Summarizing these considerations it can be stated that in almost every really doubtful case it may be assumed that $f_{tEs} = f_{xEs}$.

Es CHARACTERISTICS

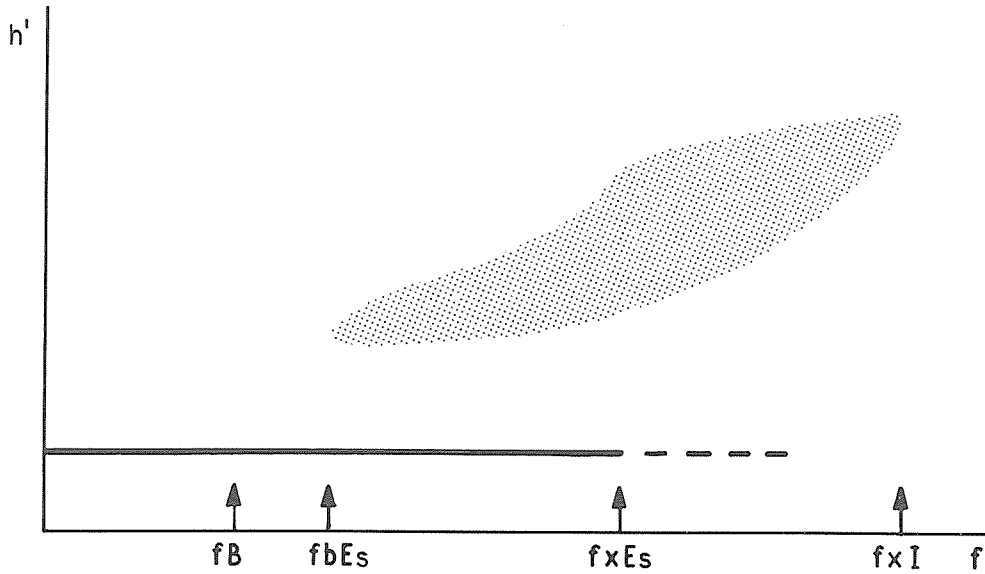

Fig. 4.6 foEs at night

Note f_{min} low so absorption small (---weak trace).

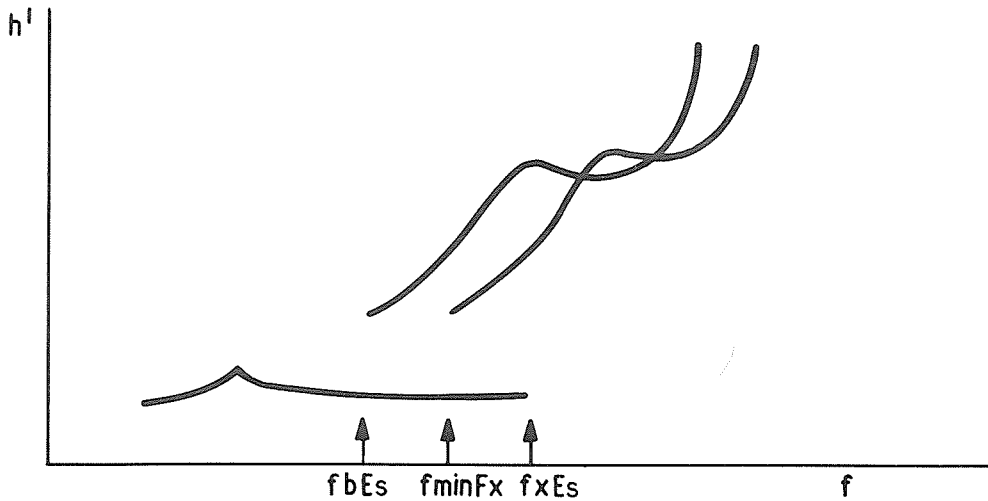

Fig. 4.7 $f_{tEs} > f_{minFx}$

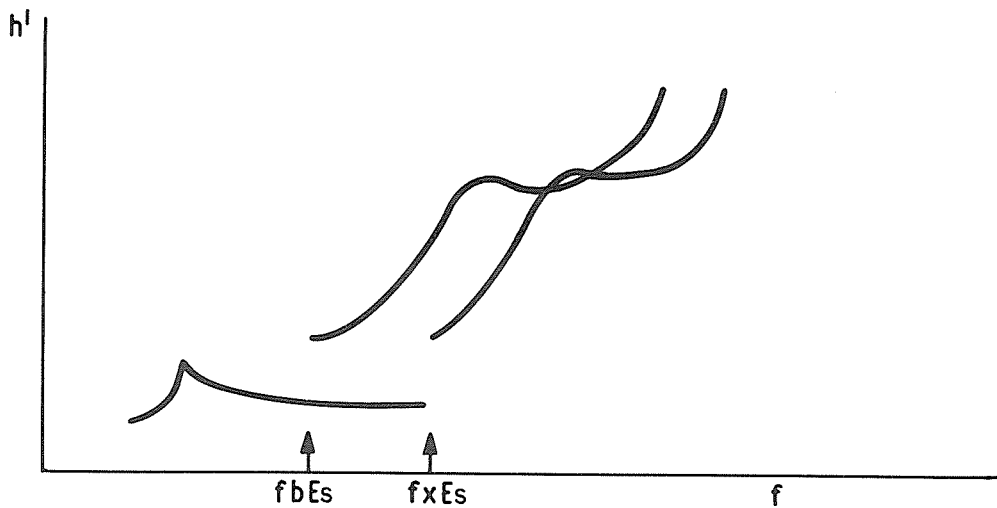

Fig. 4.8 $f_{tEs} = f_{minFx}$

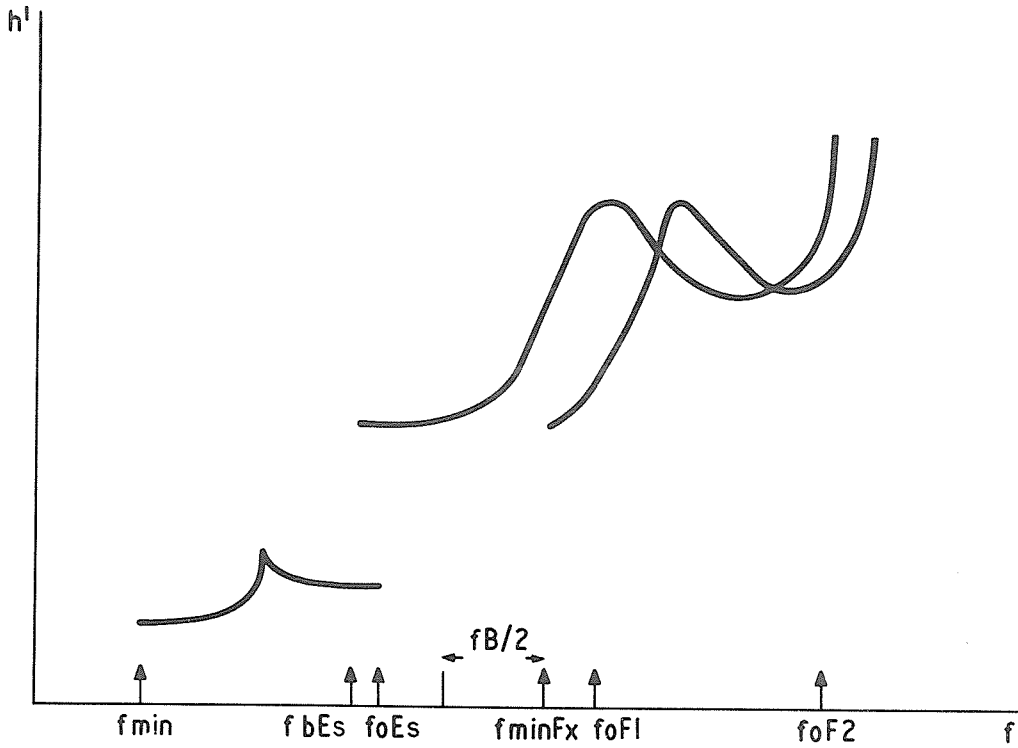

Fig. 4.9 f_{minx} given by f_{minFx} . Daytime.

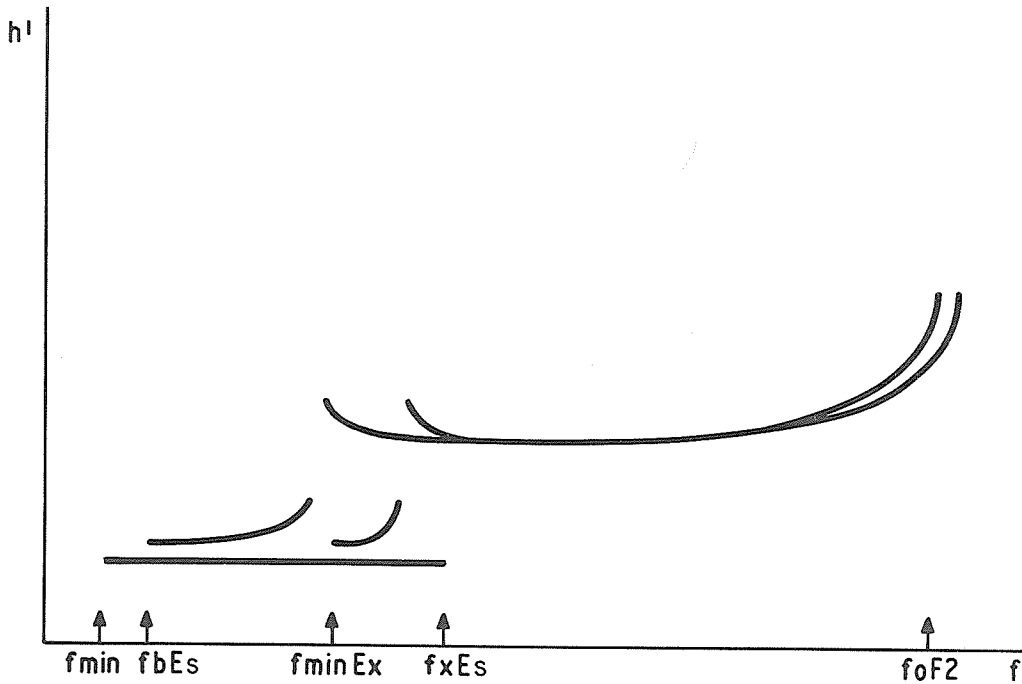

Fig. 4.10 f_{minx} given by f_{minEx}

$f_{oEs} = (f_{xEs} - fB/2)JA$ if f_{oEs} greater than f_{oE}
 $f_{oEs} = (f_{xEs} - fB/2)JG$ if f_{oEs} less than f_{oE}
 $f_{bEs} = (f_{bEs}) - G$
 E_s type low.
 If E trace not horizontal $h'E = (h'E)EA$.

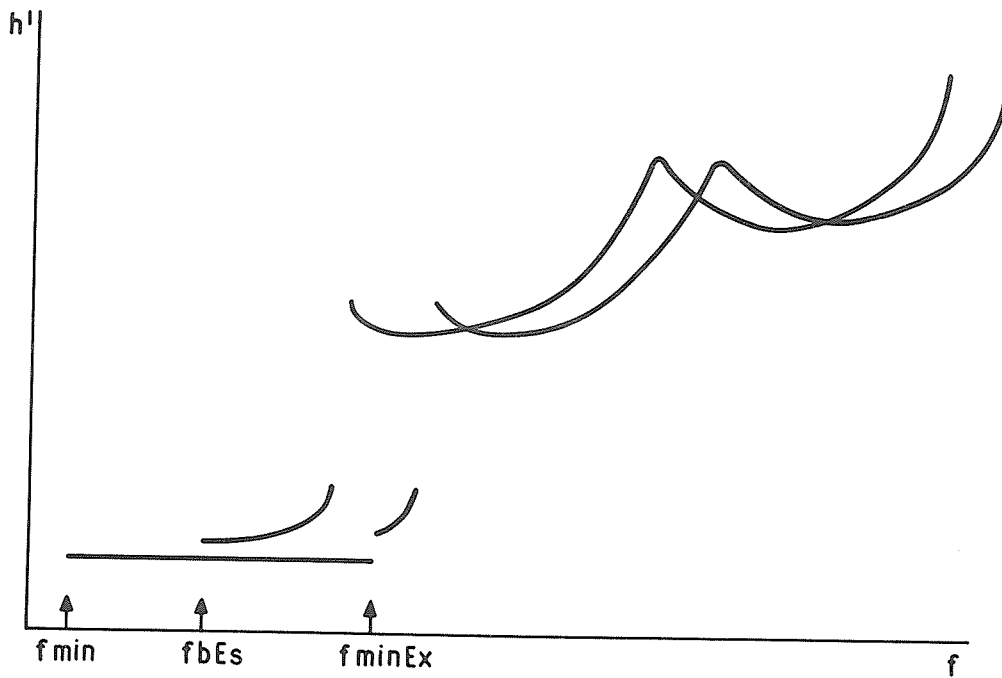

Fig. 4.11 $ftEs$ determined by f_{minEx}
 $ftEs$ is $fxEs$

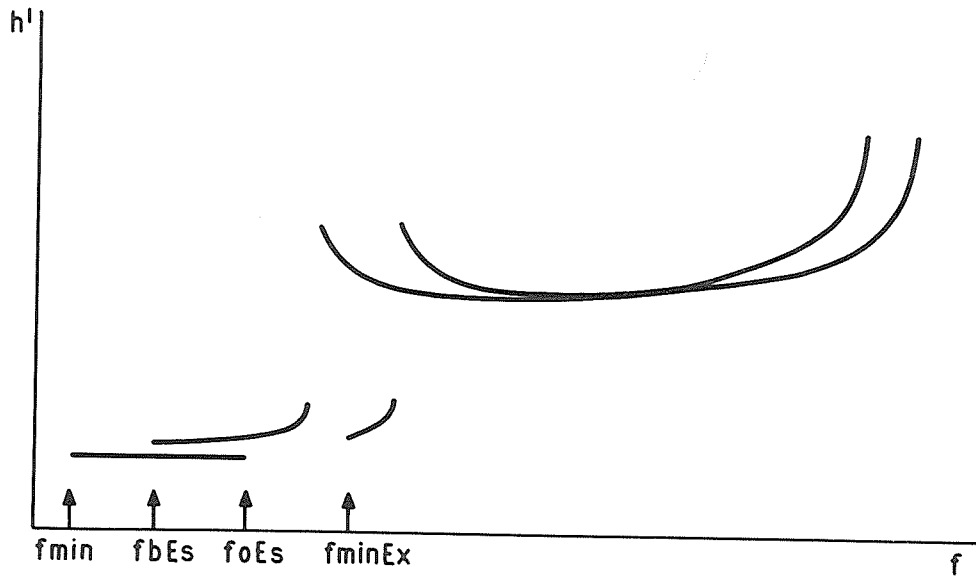

Fig. 4.12 $ftEs$ determined by f_{minEx}
 $ftEs$ is $foEs$

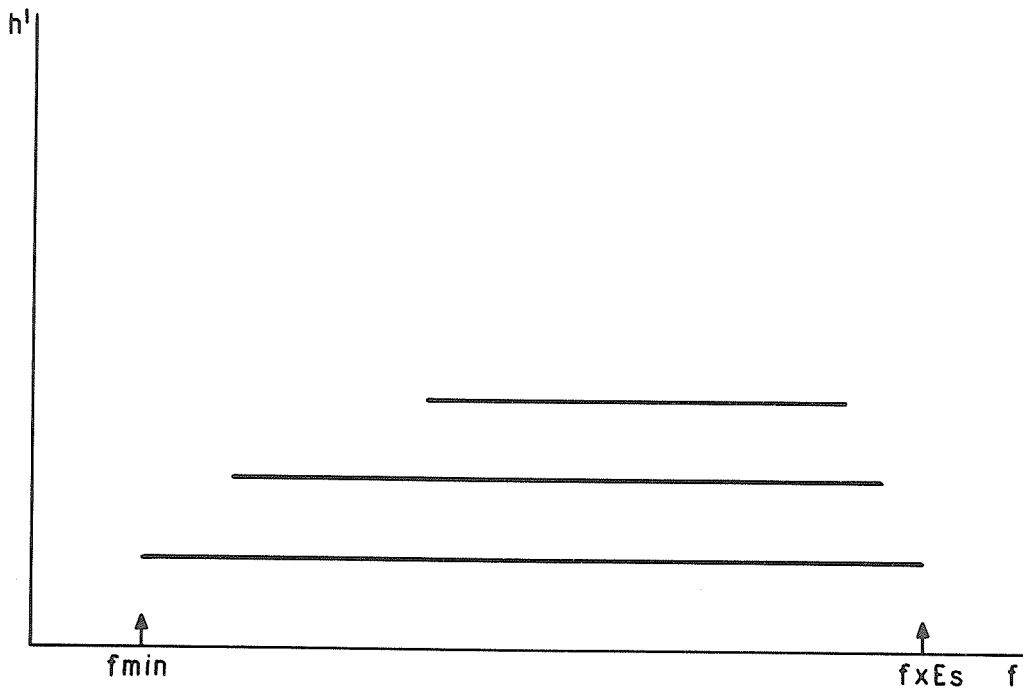

Fig. 4.13 Total blanketing. Normal absorption
 f_{tEs} is most likely to be f_{xEs}

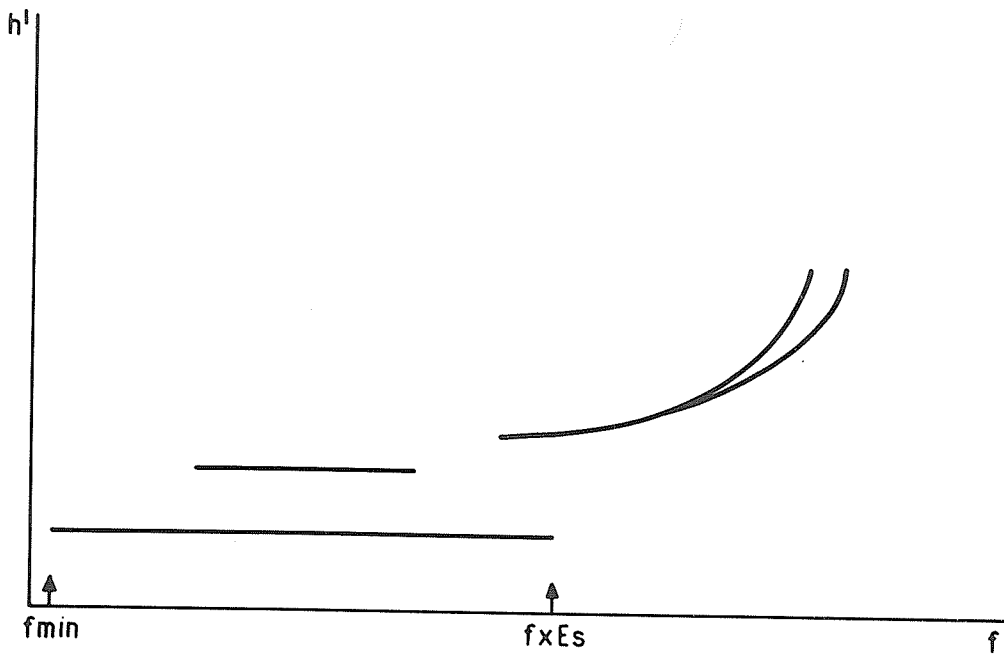

Fig. 4.14 Superposed components
 f_{tEs} is most likely to be f_{xEs} in this case as absorption small.

Es CHARACTERISTICS

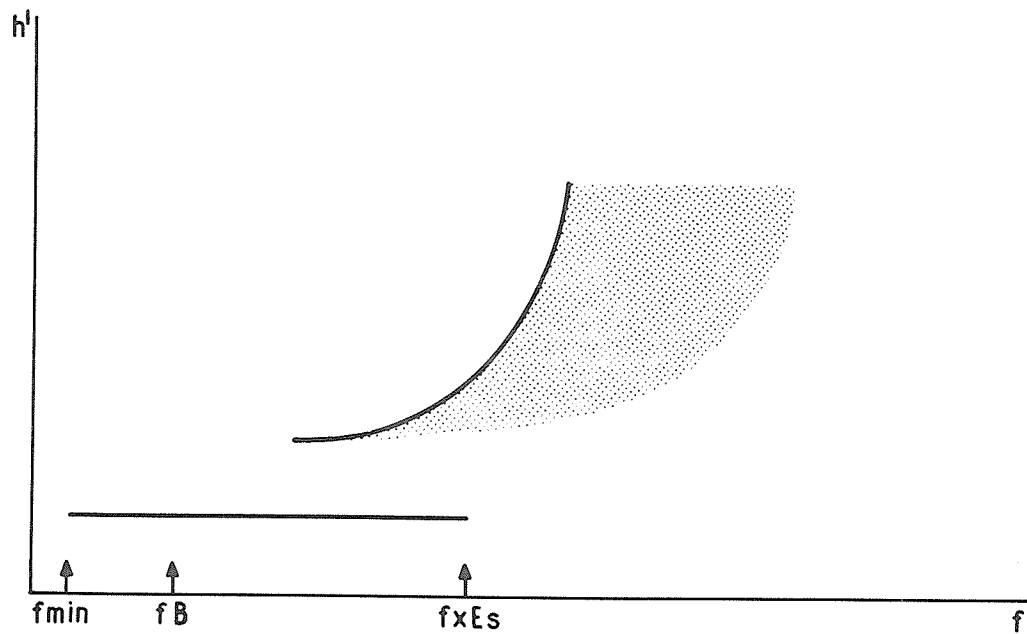

Fig. 4.15 Scatter present

If f_{min} normal, f_{tEs} is likely to be f_{xEs} .

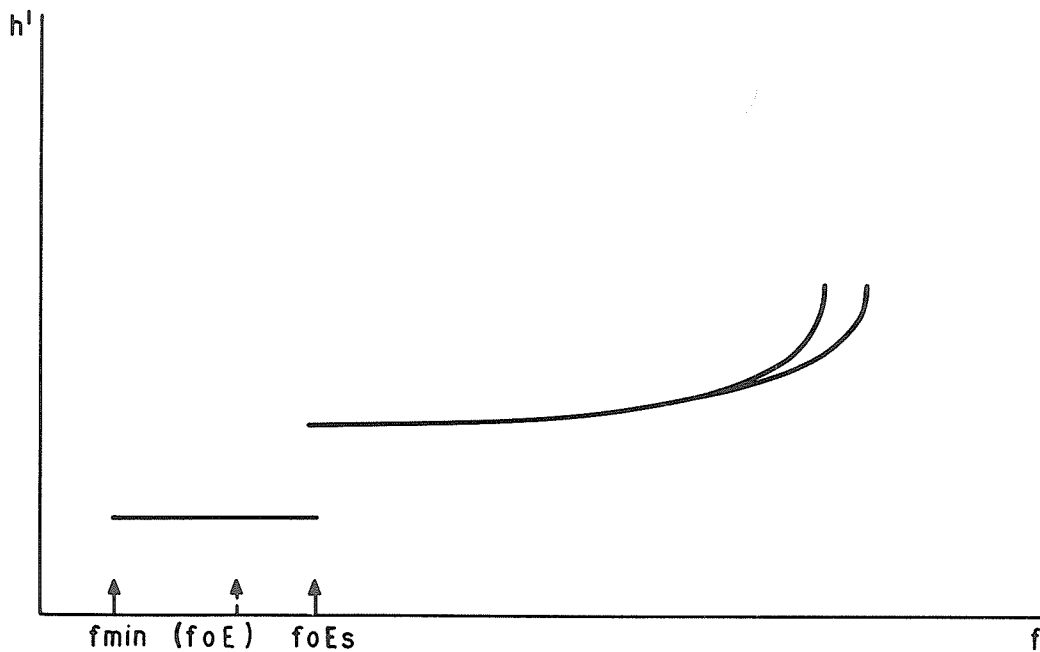

Fig. 4.16 f_{oEs} near expected value of f_{oE}

f_{tEs} is most likely to be f_{oEs} (very rare case).

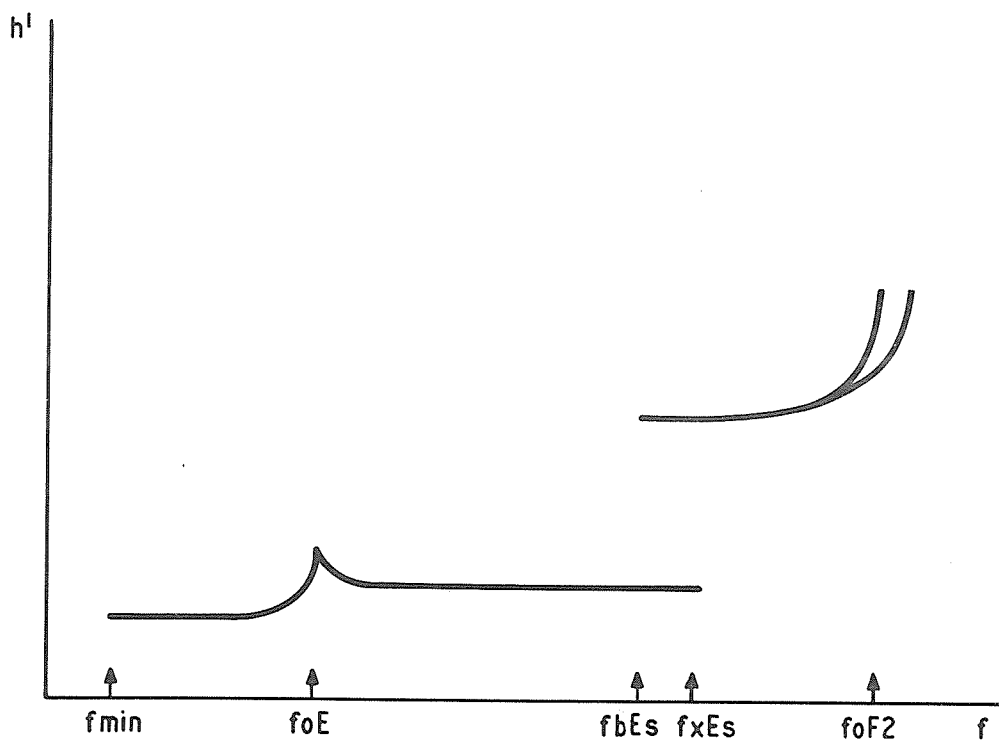

Fig. 4.17 $f_{min}f_x$ not visible, absorption normal

f_{min} normal
 f_{tEs} occurs at frequency where x trace
 would be expected to occur
 $f_{oEs} = (f_{xEs} - f_B/2)JA$

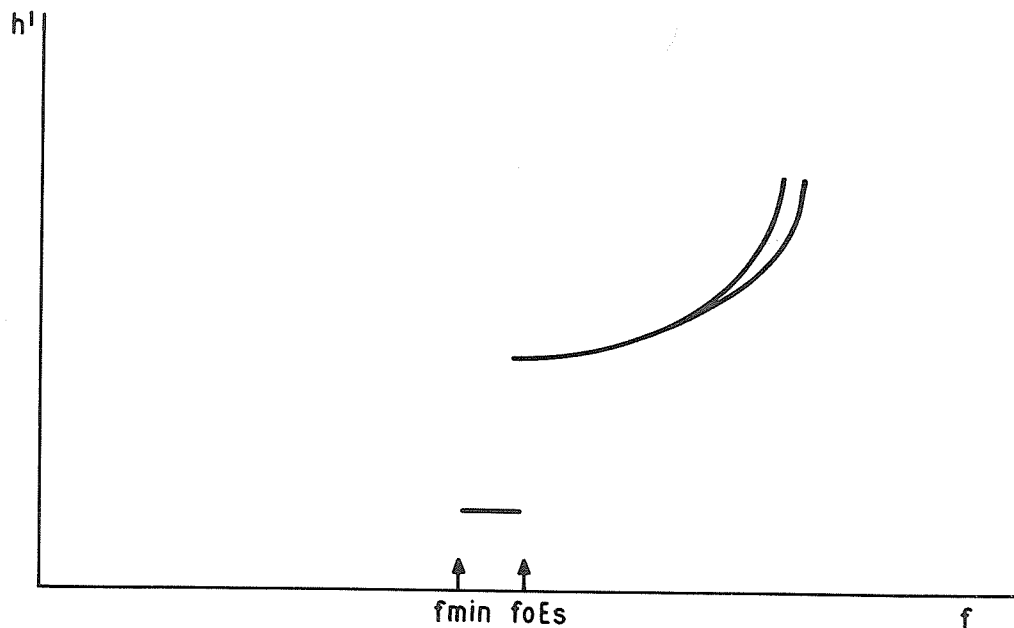

Fig. 4.18 $f_{min}f_x$ not visible, absorption large

f_{min} larger than normal, multiple reflections missing.
 f_{tEs} probably f_{oEs} as x trace usually much more absorbed
 than o trace.

Es CHARACTERISTICS

4.32 Instructions for distinguishing Es components

Table 4.1

	Para. No.	Conclusion that $ftEs = fxEs$	Conclusion that $ftEs = foEs$	Figure
General rules	a,b	Separation by absorption or by group retardation		4.1
	c	No absorption $ftEs > fB$		4.5, 4.6
	c		No absorption $ftEs < fB$	4.4
	d	$ftEs \geq fminx$	$ftEs < fminx$	
When $fminFx$ known	e	$ftEs > fminFx$		4.7
	e	$ftEs = fminFx$		4.8
	e		$ftEs < fminFx$ (no E trace present within $fB/2$ of $fminFx$)	4.9
	e	$ftEs > fminEx$		4.10
	e	$ftEs = fminEx$		4.11
	e		$ftEs < fminEx$	4.12
When $fminFx$ not known	(i)	Estimate when absorption is absent		
	f	Total blanketing		4.13
	f	Superposed o and x traces		4.14
	f	F layer scattered		4.15
	(ii)	Estimate when absorption is present		
	g		$ftEs \sim foE$	4.16
	g	$ftEs \gg foE$		4.17
g		$ftEs \sim fmin$	4.18	
g	At night $ftEs \gg fmin \gg fB$			

4.4 Scaling of foEs

4.41. The selection rules for identifying the Es trace which should be scaled are as follows:

- Ignore all traces which indicate oblique reflections from evidence on the ionogram or the sequence of ionograms.
- Ignore all very weak intermittent reflections, e.g., Fig. 4.6.
- Ignore all rapidly varying or transient phenomena. For fast recorders, meteor traces which would otherwise resemble an Es trace can often be identified by the occurrence of fairly regularly spaced fading. These traces should be ignored.
- Select from the remaining traces the one which is mainly continuous to the highest frequency. This trace should be used for scaling foEs, fbEs and h'Es. The highest frequency to which the trace is mainly continuous is called its top frequency. The current meaning of 'mainly continuous' is that a break in the trace which can be ascribed to an occasional fade or change in the sensitivity of the ionosonde is ignored if the trace continues regularly beyond the break. Rules (a), (c) do not apply to Es type a and r.

4.42. The rules for measuring and tabulating foEs are:

- When the ordinary and extraordinary Es traces are separated in virtual height or frequency (see section 4.3) or the ordinary component alone is present and identifiable, the top frequency of the ordinary-wave trace is the required value of foEs.
- When the ordinary and extraordinary traces are not separated but evidence exists from the rules in section 4.31 (d to g; especially e, iii) that $ftEs = foEs$, this value is scaled as foEs.
- When the rules for distinguishing between the components show that $ftEs = fxEs$, the preferred method is to subtract $fB/2$ from the observed value of $ftEs$ and tabulate the resultant value qualified by J and described by A.

- (d) When the distinction between the components cannot be made but it is most likely that $ftEs = fxEs$, the preferred method is to subtract $fB/2$ from the observed value of $ftEs$ and tabulate the resultant value qualified by J and described by M.
- (e) When the distinction between the components cannot be made but it is most likely that $ftEs = foEs$ (an extremely rare case in practice), scale $ftEs$ described by M.
- (f) When no Es trace is present on the ionogram the detailed rules given in section 3.2 for descriptive letters B, C, E, G and S are applied. The main points may be summarized as follows:
 - B - $fmin$ is high; $foEs$ equal to the numerical value of $fmin$ qualified by E and described by B.
 - C - Instrumental fault; $foEs$ replaced by descriptive letter C.
 - E - $fmin$ equal to lower frequency limit of ionogram; $foEs$ replaced by descriptive letter E. (In determination of medians always use minimum frequency of ionosonde EE).
 - G - Normal E echo traces present. $foEs$ replaced by descriptive letter G, preferably (foE)EG.
 - S - Night conditions; $fmin$ tabulated with qualifying letter E and descriptive letter S. $foEs$ tabulated in same way as $fmin$.
- (g) For stations with low frequency ionograms that have a wide interference band, see letter S in section 3.2 for use of letters DS with $foEs$.

4.43. At stations where most values of $foEs$ must be deduced from $fxEs$, it is permissible to omit the use of JA in rule (c) above. Es is too variable for the probable additional error to be significant unless the majority of values are direct observations of $foEs$. Rules (d), (e) should be observed in this case.

4.44. The international rules allow two simplifications to be made to the scaling rules (c), (d), (e) (section 4.42) at stations where conditions do not justify the work involved in calculating $foEs$. When the rules for distinguishing between the components show that $ftEs = fxEs$, tabulate $ftEs$ with the descriptive letter X. When the distinction between the components cannot be made tabulate $ftEs$ with the descriptive letter M. The use of these simplifications must be clearly indicated on $foEs$ tables for interchange.

4.5 Scaling of fxEs

Tables of values of $fxEs$ circulated in place of tables of $foEs$ must always be clearly titled as follows:

$fxEs$ ($\sim foEs$ + appropriate mean value of the correction term $fB/2$).

The selection rules and instructions for distinguishing between the two components are identical to those for $foEs$.

- (a) When the ordinary and extraordinary Es traces are separated in virtual height or frequency (see section 4.42 (a), (b)) the top frequency of the extraordinary Es trace is the required value of $fxEs$.
- (b) When the ordinary and extraordinary Es traces are not separated but the identification rules show that $ftEs = fxEs$, the top frequency of the extraordinary Es trace is the required value of $fxEs$.
- (c) When the top frequency of the Es trace is known to be $foEs$ add $fB/2$ and tabulate the resultant value qualified by O and described by the letter showing why $fxEs$ was not present, usually B, R or S.
- (d) When the distinction between the components cannot be made but it is most likely that $ftEs = fxEs$, tabulate the observed value of $ftEs$ described by M.
- (e) When the distinction between the components cannot be made but it is most likely that $ftEs = foEs$ (an extremely rare case in practice), add $fB/2$ and tabulate the resultant value qualified by O and described by M.

Es CHARACTERISTICS

- (f) When no Es trace is present on the ionogram, the detailed rules given in section 3.2 for the descriptive letters B, C, E, G and S are applied (see also section 4.42).
- (g) For stations with low frequency ionograms that have a wide interference band, see letter S in section 3.2 for use of letters DS with fbEs.

4.51. The use of J, O, M and X for foEs or fxEs is summarized in the following table:

Table 4.2

	foEs		fxEs
	preferable	simplified	
ordinary	... - -	... - -	xxx O B
extraordinary	ooo J A	(ftEs) - X	... - -
unknown, estimate o	... - M	(ftEs) - M	xxx O M
unknown, estimate x	ooo J M	(ftEs) - M	... - M
Numerical example (1/2 fB assumed to be 0.6).			
	foEs		fxEs
	preferable	simplified	
ordinary	<u>039</u> - -	<u>039</u> - -	045 O B
extraordinary	067 J A	<u>073</u> - X	<u>073</u> - -
unknown, estimate o	<u>041</u> - M	<u>041</u> - M	047 O M
unknown, estimate x	089 J M	<u>095</u> - M	<u>095</u> - M

Underlined values indicate that the numerical value has been directly obtained from the ionogram.

4.6 Scaling of fbEs

fbEs is always determined using the ordinary-wave trace for the layer first seen through the Es.

If several Es traces giving blanketing are present on the same ionogram, the value of fbEs to be tabulated is the value of blanketing frequency due to the trace which gave foEs (Fig. 4.19 (a) and (b)). All observed values of fbEs should be plotted on the f plot.

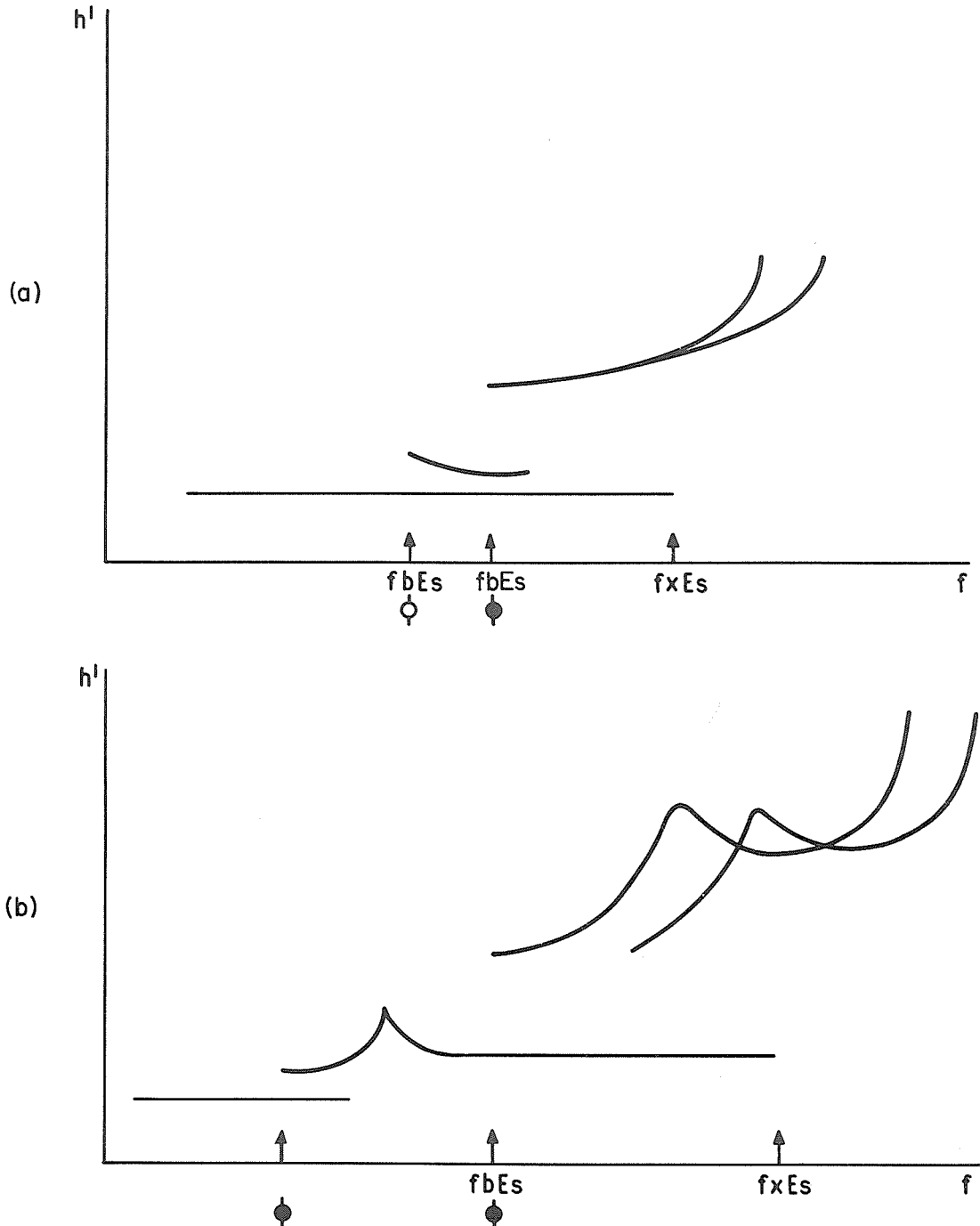

Fig. 4.19 Scaling of fbEs

The f plot symbols (Chapter 6) are also shown.
 Note: (i) The tabulated value of fbEs is always given by trace with highest value of foEs.
 (ii) All values of fbEs are shown on the f plot.

When the Es trace giving foEs is partially reflecting at all frequencies and a thick layer is present, fbEs is given by the critical frequency of the thick E layer trace associated with its lowest frequency qualified by E and described by G, Fig. 4.20.

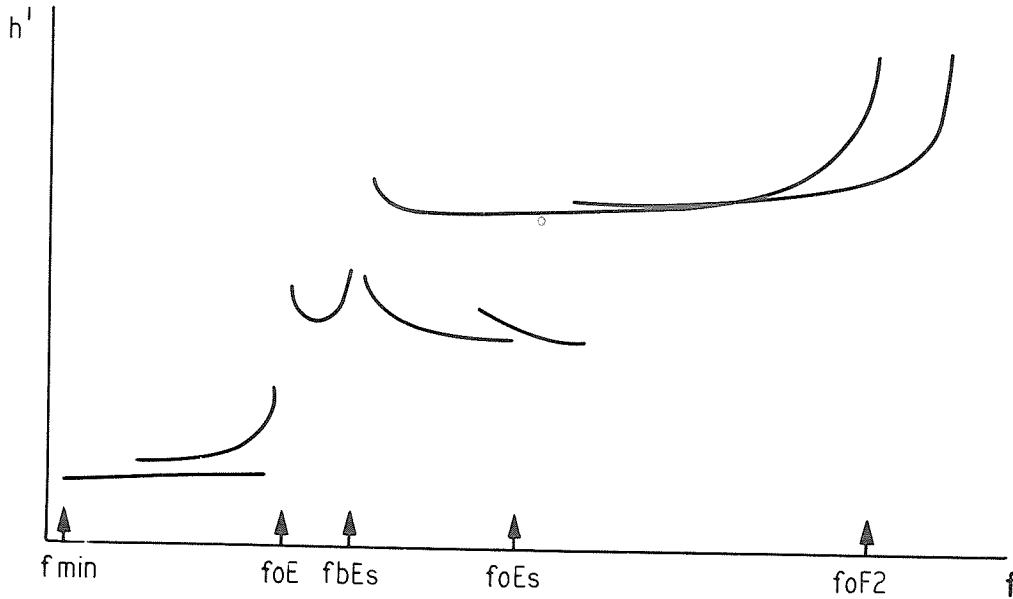

Fig. 4.20 Non-blanketing Es.

This figure shows both Es type h and Es type l
foEs as shown
fbEs is tabulated as (fbEs)EG. (fbEs) is equal to foEs,
the critical frequency of the intermediate layer.

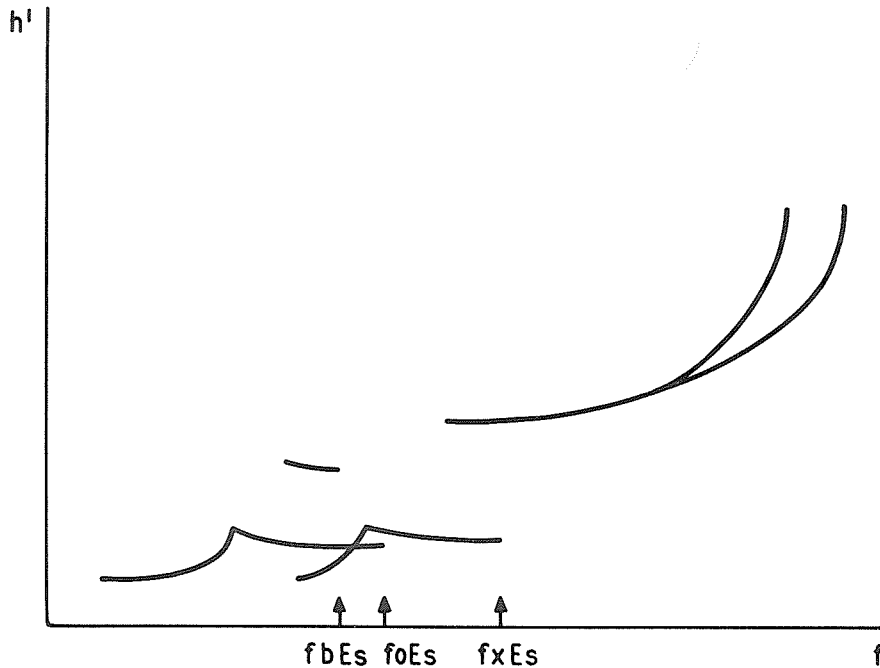

Fig. 4.21 Blanketing indicated by strong second order Es
fbEs given by second order (fbEs)UY, see Fig. 4.22.

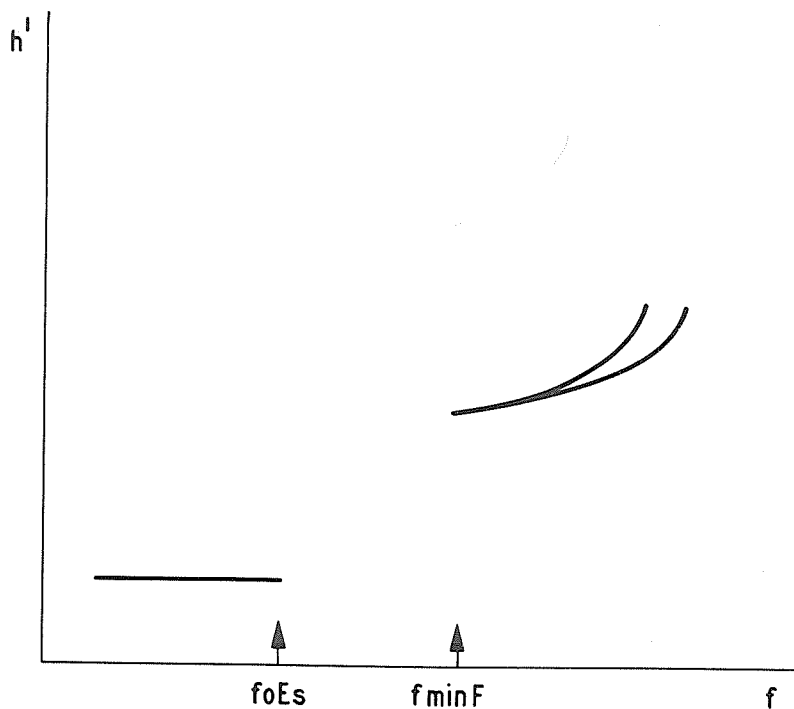
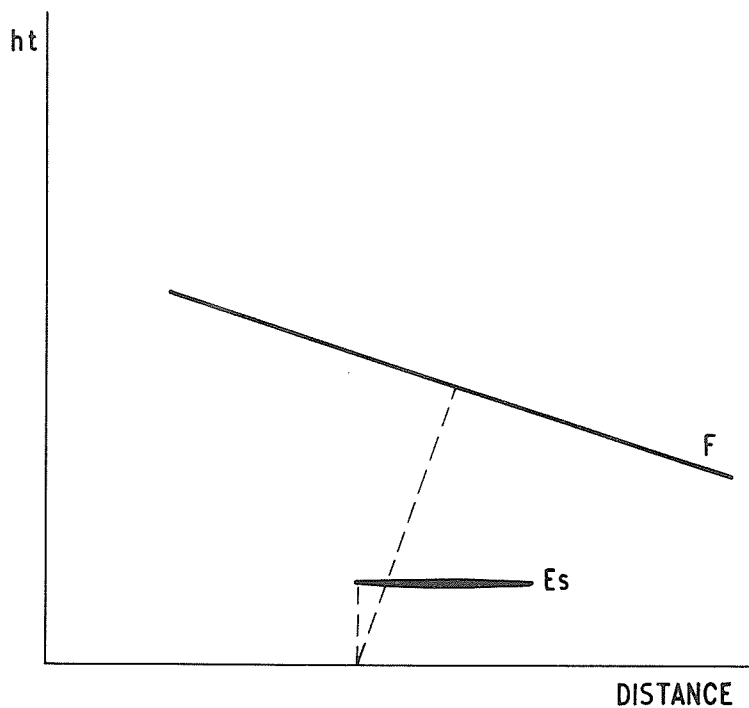

Fig. 4.22 Trace missing due to a severely tilted layer
 $f_{bE_s} = Y$ unless accuracy rules allow an estimated value to be made.
 If in doubt use Y .

Note: The presence of the tilt will usually be detected by height differences between the first and second order F traces, (see section 2.7).

The value of fbEs cannot exceed foEs within the usual accuracy rules. When the minimum frequency reflected from higher layers is greater than foEs, fbEs can only be scaled if the ionogram (Fig. 4.21) or sequence of ionograms indicates that blanketing is present. The usual accuracy rules apply. Retardation at fminF indicates the presence of deviative absorption. If the multiple F - trace heights are consistent use R in preference to Y. A gap in frequency between the Es and F trace is most often produced by a tilt of the F layer, which is then sounded in an oblique direction (Fig. 4.22 (a) and (b)). The observed lower frequency limit of the F trace does not correspond to overhead conditions. The numerical value of foEs, qualified by U and described by Y, is tabulated for fbEs. This case can often be identified by comparing the first and second order F-region traces. A descriptive letter alone (e.g., S, C, R, Y) is used in these cases where blanketing is not clearly indicated.

When Es is not observed the letter used to replace the numerical value of foEs is also used to replace that for fbEs (section 4.42).

When complete blanketing occurs (i.e., no reflections from higher layers appear at all), it is not possible to evaluate fbEs with certainty. However, the statistics of fbEs lose much value if these high values are not numerical. Therefore, a new convention has been adopted as stated in section 3.2, letter A using fbEs = (foEs)AA unless this is clearly misleading.

- (a) If the trace is solid to foEs, tabulate (foEs)AA (Fig. 3.1).
- (b) If the trace is not solid to foEs, or if two or more multiple traces are present with the value of the top frequency of the second order trace much smaller than foEs (Fig. 3.2) tabulate the value of fbEs deduced from the top frequency of the second order trace with qualification AA respectively. (Note: If these values have to be deduced from the x-mode trace, AA should be used in preference to JA in cases (a) (b)). Values of fbEs deduced from the solid part of the trace and rule (a) should usually agree within the accuracy rules for limit values with the value deduced from (b).

The rules for interpreting foEs and fbEs have been summarized (R. Smith, INAG 10, p 5-6) for training purposes and are reproduced in Figures 4.32 and 4.33. The diagrams omit the x-mode traces and should be used as a guide only. Detailed rules are given in the text above.

4.7 Scaling of h'Es

h'Es is the lowest virtual height of the trace used to give foEs. If the ionosonde is on gain runs, the height should be scaled from the ionogram on which it can be measured most accurately.

When the low frequency end of the Es trace is affected by group retardation in a thick E layer and the Es trace does not become horizontal, tabulate the value of the lowest virtual height observed. The tabulated value is qualified by letter U or E as required by the accuracy rules, and described by the letter G.

When Es is not observed, the letter used to replace the numerical value of foEs is used to replace that for h'Es also.

4.8 Classification of "Types of Es"

4.81. Classification procedures: Whenever possible all Es traces appearing on the ionogram should be listed in the column on the tabulation sheet provided for Es types. The classification is independent of the scaling rules for the characteristics foEs, h'Es and fbEs. Thus types of Es corresponding to weak or oblique reflections can be recorded even though they are not scaled for numerical values. All observations available in the hourly sequence, including the high gain sounding, should be used in judging the types of Es present. [B section III pp. 1-10].

4.82. Tabulation of Es types and multiple echoes: When more than one type of Es trace is present on the ionogram, the type for the trace used to determine foEs must be written first. The other Es traces are arranged in sequence of descending order of multiples except when Es-k is present. In this case Es-k takes precedence over all other Es traces except that giving foEs.

The first two types tabulated must each be followed by a number indicating the number of traces seen up to 9. If only the fundamental is present, however, number 1 must be tabulated. The number of reflections of a given type should be determined from the normal gain sounding.

4.83. Description of standard types: The nine standard types of Es are identified by lower case letters: f, ℓ , c, h, q, r, a, s, d. These letters suggest the corresponding names: flat, low, cusp, high, equatorial, retardation, auroral, slant and D region, respectively. It is strongly emphasized that these names are not restrictive. The other two types are k and n, where k denotes the presence of particle E and n is used to designate any Es type which does not correspond to any other of the ten types [A94D].

The standard types are:

- f: An Es trace which shows no appreciable increase of height with frequency, Fig. 4.23. The trace is usually relatively solid at most latitudes [A96I, Figs. 93 (b)(c)(e)]. This classification may only be used at hours when a thick E layer is not usually observable (the hours for which a numerical value of foE cannot be obtained). At other hours, apparently flat Es traces are classified according to their virtual height: h, c, or ℓ . [B III, 3, 9; IIA 59 Dec., 62 Dec., 63 June, 65 June, 70 June, 71 Raratonga June and Dec., 74 Dec., 82 June, 83 Dec.]. Low frequency ionograms show that most cases of night time f type Es would have been classified as ℓ type though occasionally c or h type would be appropriate.
- ℓ : A flat Es trace at or below the normal E layer minimum virtual height or below the particle E layer minimum virtual height [A96I, Fig. 93(d)]. [B III, 3, 5, 9; IIB 36 Sept., 42 Dec.]. (Fig. 4.24 (a)(b)).
- c: An Es trace showing a relatively symmetrical cusp at or below foE. This is usually continuous with the normal E trace, although when the deviative absorption is large, part or all of the cusp may be missing. (Usually a daytime type.) [A96I, Figs. 93 (d), 94, 95]. [B III, 4, 9. Many other cases]. (Fig. 4.25 (a)(b)).
- h: An Es trace showing a discontinuity in height with the normal E-layer trace at or above foE. The cusp is not symmetrical, the height of the low frequency and of the Es trace being clearly higher than that of the high frequency end of the normal E trace. (Usually a daytime type.) [A96I, Fig. 97]. [B III, 4, 5; IIB 42 (a11), 46 Sept. Freiburg, 51 Sept., 52 Dec., 55 June, Sept., 57 Dec., 61 June, 62 June Tsumeb, 64 June, 83 Dec.]. (Fig. 4.26 (a) (b)).
- q: An Es trace which is diffuse and non-blanketing; commonly found during daytime in the vicinity of the magnetic dip equator. The lower edge is usually relatively well defined (Fig. 4.27). Often Es types can be superposed on this pattern, in particular Es- ℓ can cause blanketing at the low frequency end. [A96I, Figs. 93(a), 98]. [B III, 8, IIB 84 Ibadan, Kunasi June; 85 Dec., 86 a11; 87 a11].
- r: An Es trace showing an increase in virtual height at the high frequency end, similar to group retardation. The trace is blanketing over part or nearly all of its frequency range. This is distinguished from the usual group retardation (as in the case of an occulting thick E layer) by the lack of group retardation in the F-layer traces at foEs and the presence of an F layer trace below foEs. [A96I, Figs. 93 to 96, A1041, 120]. (see Figs. 4.2, 4.28).
- a: All types of very diffuse (spread) traces are combined in auroral type Es. These can extend over several hundred kilometers of virtual height. Typical patterns show a flat or slowly rising bottom edge to the pattern, with stratified traces in it which vary rapidly in time. The width of the trace is usually greatest well below foEs or fxEs, often at frequencies near fminF, Fig. 4.29. The pattern usually alters rapidly in time. Es type a traces are due to oblique reflections and patterns at different virtual heights often varying independently (usually because they come from different directions). Multiple reflections are not seen until the reflecting structures move overhead, when the overhead traces usually correspond to Es type f or Es type k are blanketing. Temperate latitude types Es h, c, ℓ can be superposed on Es type a pattern though this is rare.
- s: A diffuse Es trace which rises steadily with frequency and usually emerges from a normal E, particle E or Es trace [A96I, 93h, 98]. The rising trace alone is classified as "s"; the horizontal trace is classified separately. Es trace "s" can arise from foE, fxEs; foEs, fxEs; or from an intermediate point in the Es trace. The preferred starting point varies with magnetic coordinates. Es type s traces must not be used to determine foEs, fbEs or h'Es, but should be included in the Es types table (see Lacuna section 2.75). [BIII, 7, 8, 9] (Fig. 4.30 (a)(b)).

Es CHARACTERISTICS

- d: A weak diffuse trace at heights normally below 95 km associated with high absorption and large f_{min} . This is not strictly an Es trace though it appears similar to one, and should never be used to give values of f_{min} , f_oE_s , $h'E_s$. It is never blanketing but the associated absorption may prevent reflections from higher layers. In practice, most often seen at heights near 80 km, [B III 10] (Fig. 4.31).
- n: The designation 'n' is used to denote an Es trace which cannot be classified into one of the standard types. When a trace appears to be intermediate between any two classes a choice should be made whenever possible even if it is uncertain. 'n' should be used sparingly.

Note: If a form of Es not included in the standard types given above occurs frequently at a station, it is permissible to devise a new type and designate it with an appropriate letter. It should be clearly distinguishable from the other types and completely described in the scaling notes. Type d originated in this way but is now recognized internationally. Such proposals should be submitted to INAG for comment.

- k: The designation k is used to show the presence of particle E [B III, 7]. When $f_oE_s > f_oE$ (particle E) the Es type precedes k; e.g., r1, k2, h1. A typical pattern is shown in Fig. 4.2(c).

- Note: (i) Es-r and Es-a type traces can be present with normal E or particle E, Es-k. In these cases the retardation at the low frequency end of the Es trace is ignored in deciding the type.
- (ii) It is common for Es-f, Es-h, Es-c to be superposed on Es-a, occasionally on Es-r also. In these cases f, h or c is given priority over a, r for the second entry. Since these structures are likely to be overhead, they are more important than showing two or more oblique structures.

4.84. Missing data: By convention, Es types are only entered when seen and the appropriate spaces are left blank whenever no Es trace is present. No attempt is made to show the reason, i.e., do not use letter symbols B, C, G, S, etc., in this table.

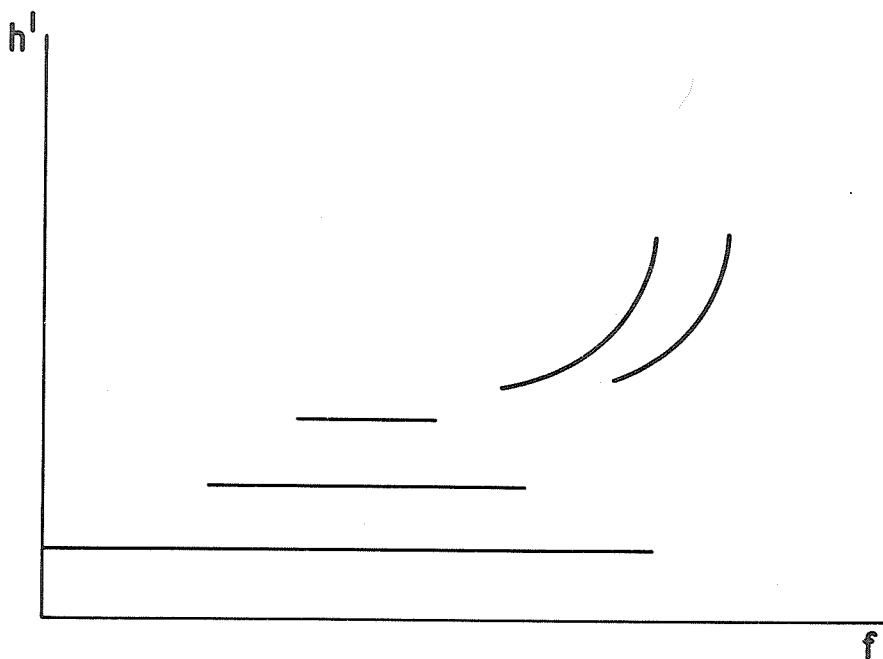

Fig. 4.23 Es type f, flat

Use only when a thick E layer is not usually observable at the time of the ionogram. Otherwise use 'l'.

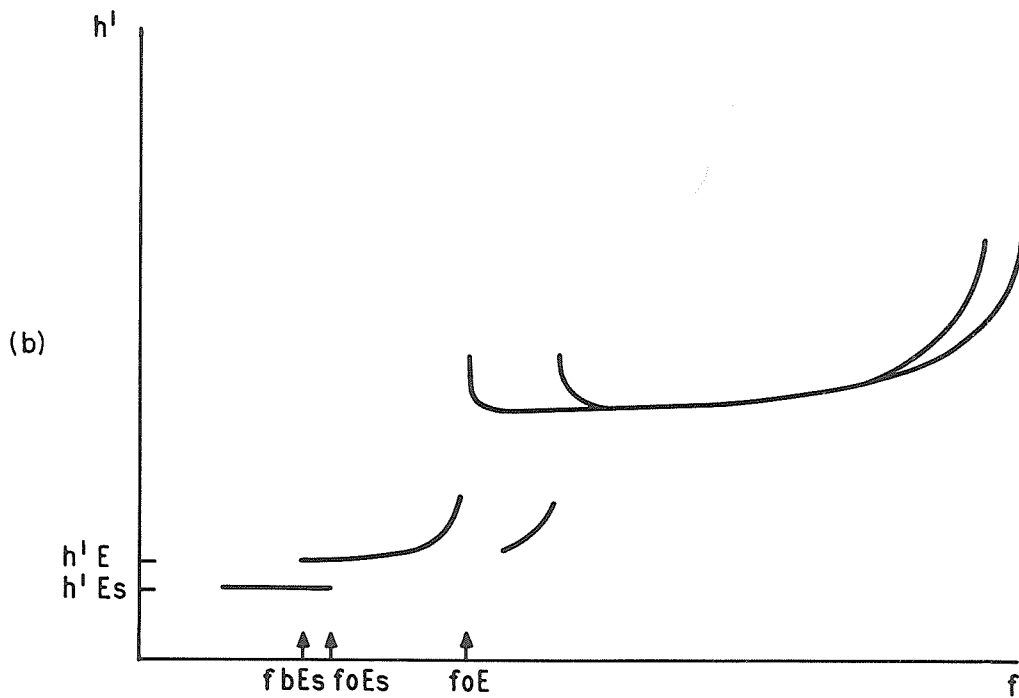
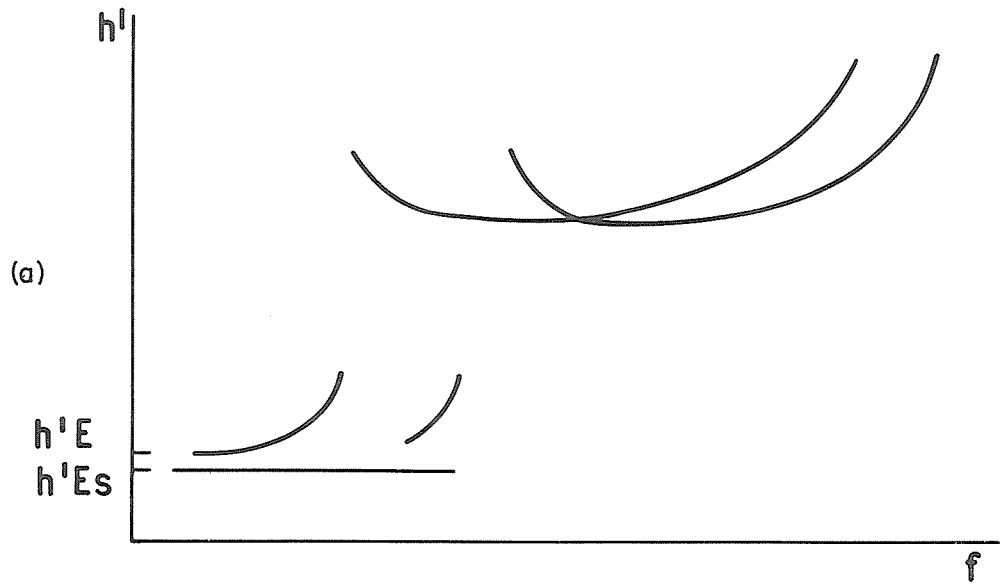

Fig. 4.24 (a)(b) Es type l , low

Note a pattern similar to Fig. 4.23 with $h'Es$ less than the normal value of $h'E$ for the hour should also be classified as type l .

Es CHARACTERISTICS

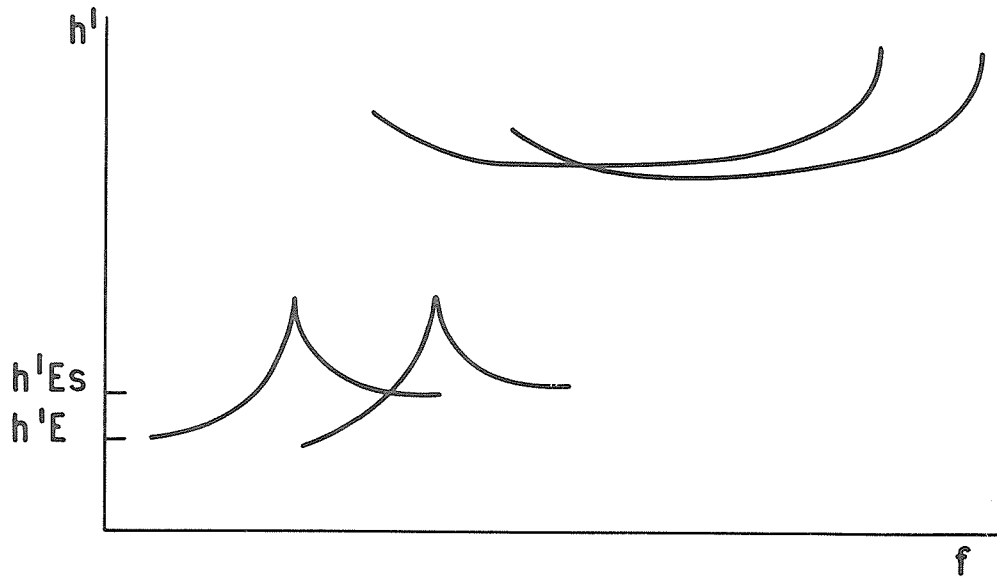
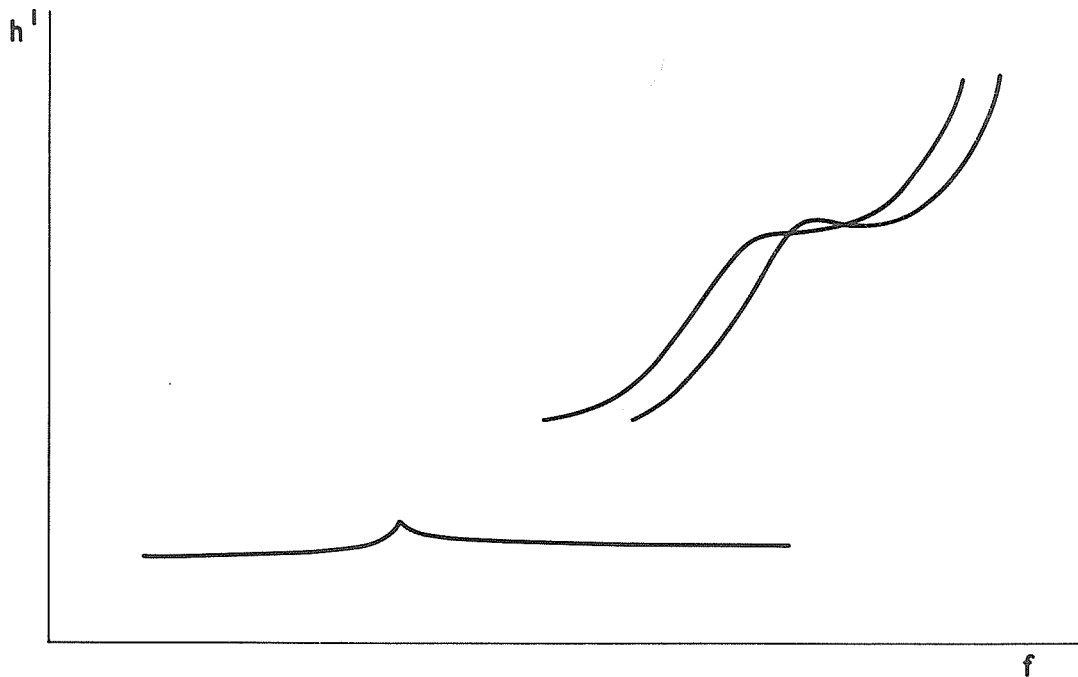

Fig. 4.25 (a) Es type c, cusp

Fig. 4.25 (b) Es type c, cusp
 foE blanketed by c type Es.

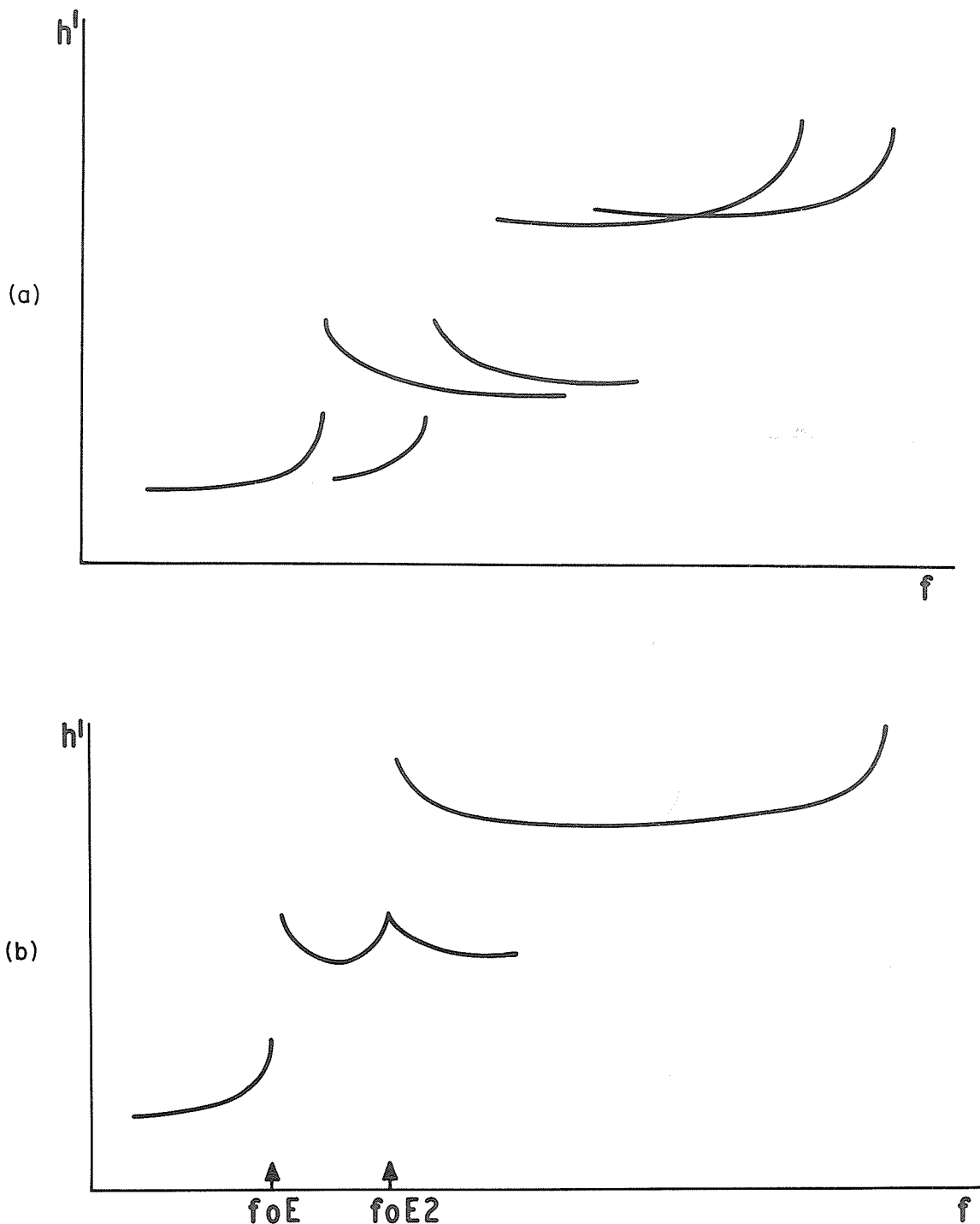

Fig. 4.26 Es type h, high

- (a) The Es trace lies slightly above the E trace. The traces would not extrapolate to a common point except at a great height.
- (b) A cusp like pattern from an intermediate stratification is also high - it is clearly above the normal E layer.

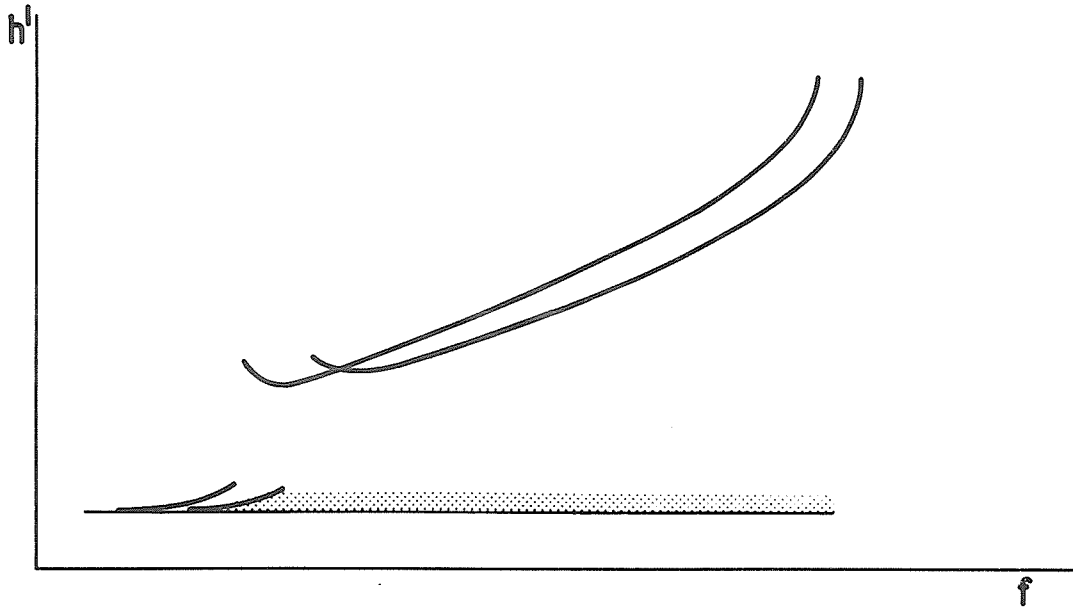

Fig. 4.27 Es type q, equatorial

A weak scattered trace extends to very high frequencies and does not blanket. Note Es type β can be superposed in the low frequency end of this trace and is then blanketing.

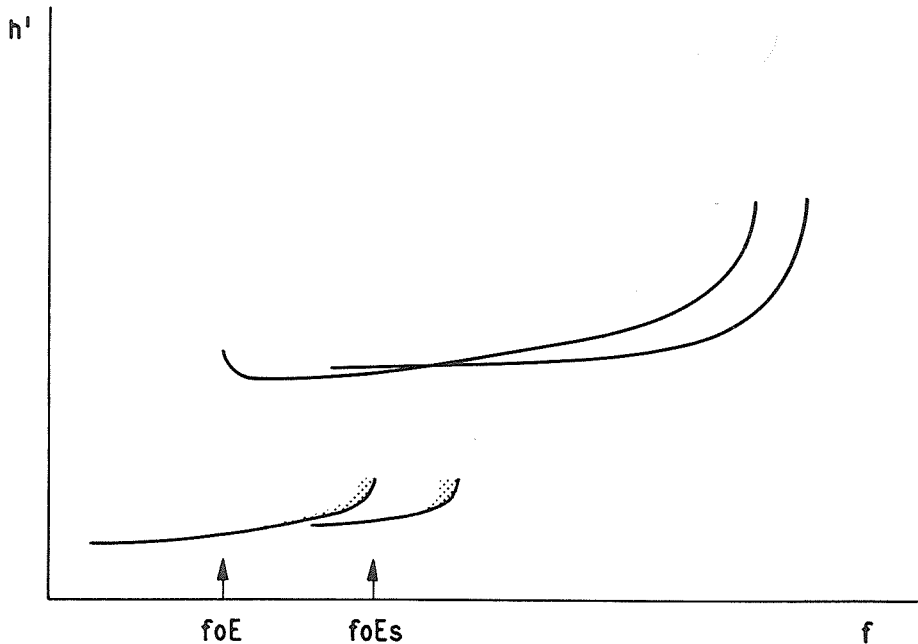

Fig. 4.28 Es type r, retardation

The trace is normally blanketing over part of its length. In this figure $fbEs = foE$, but the F trace can also show no retardation at $fminF$, see Fig. 4.2(a),(b).

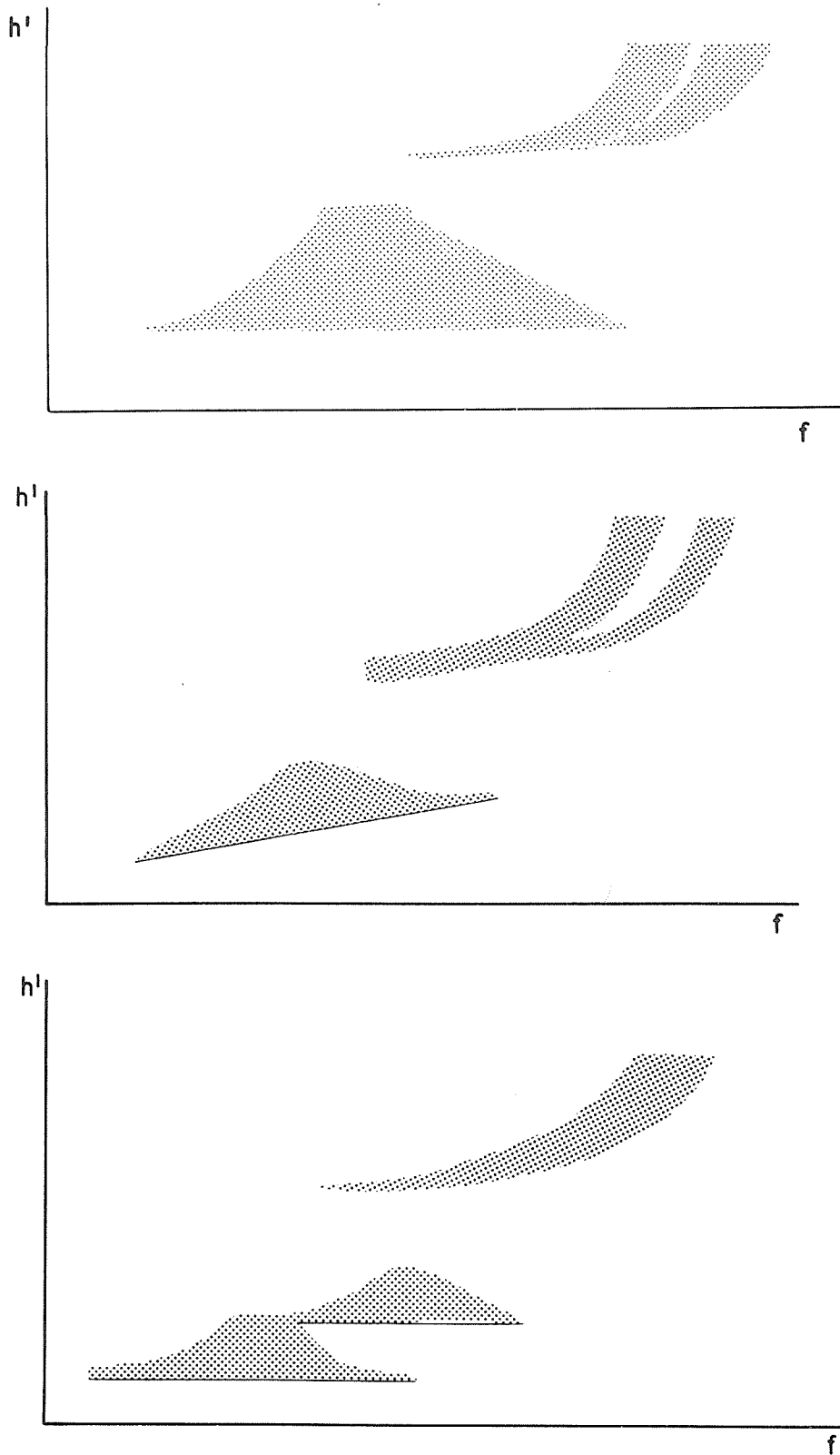

Fig. 4.29 Es type a, auroral

A wide range of diffuse spread traces are classified as Es type a. Some common patterns are shown above. The F traces are usually, but not always, spread.

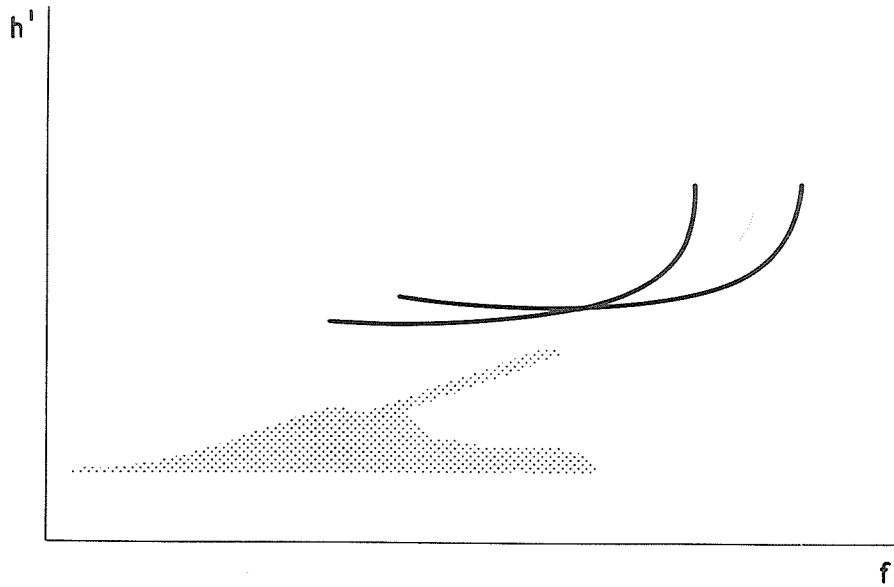
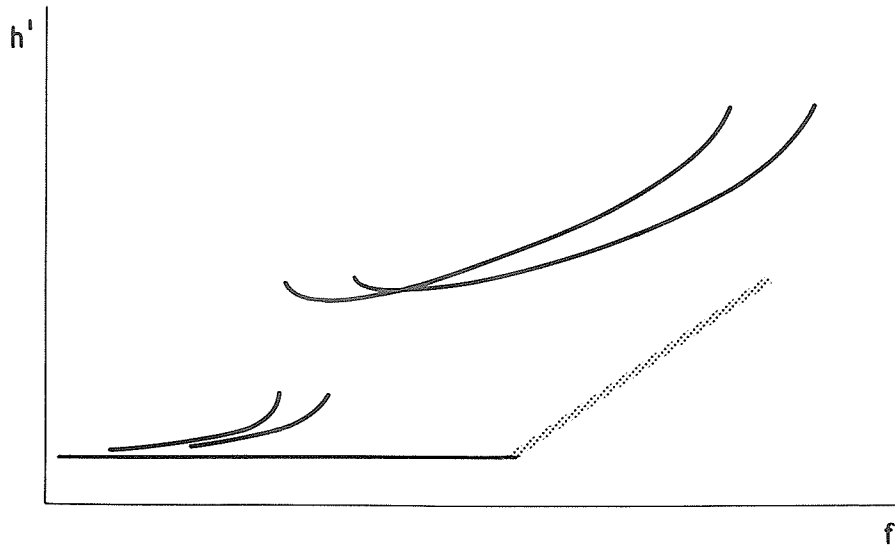

Fig. 4.30 Es type s, slant

Es type s can arise from any type of Es trace or from foE or fxE. It is most commonly seen with types f, *l*, a, and occasionally q, r. Incidence varies with station location. In the upper diagram, the slant Es is denoted by the dotted line and arises from an Es type *l*.

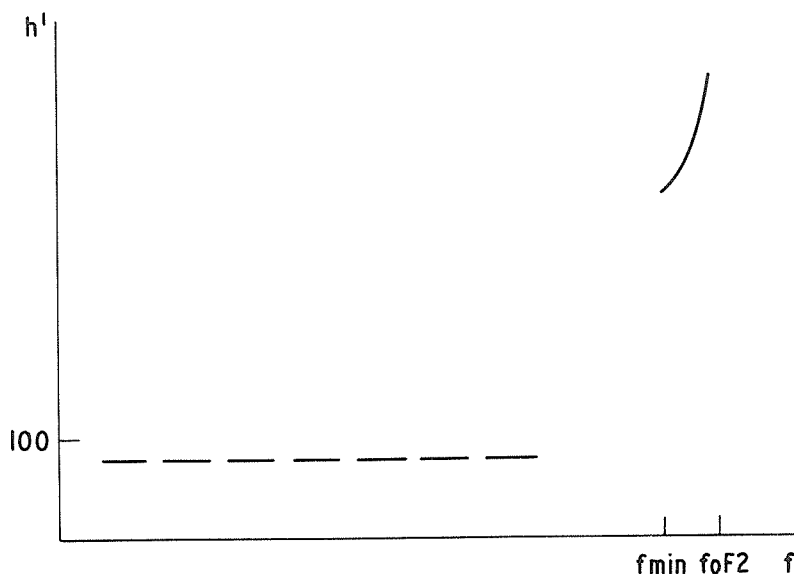

Fig. 4.31 Es type d. Partial reflection from absorbing layer.

A weak trace normally seen below 95 km and extending between 1 and 3 MHz, sometimes higher in frequency. All other traces show high absorption or are missing because of it (B condition).

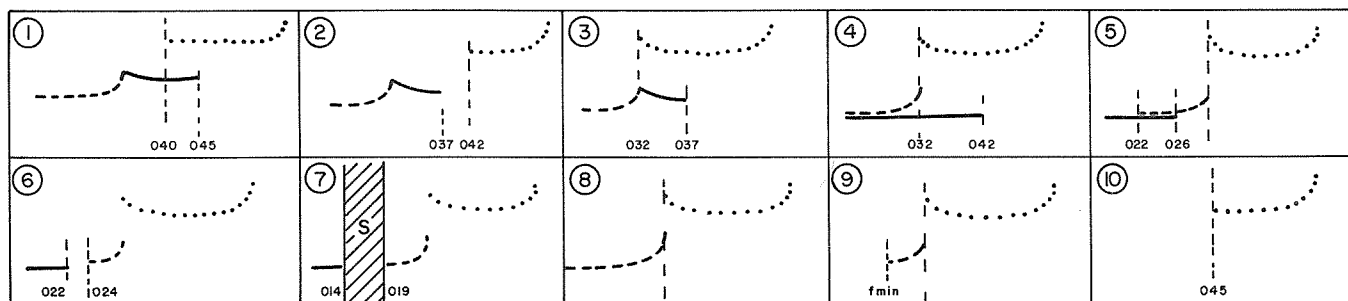
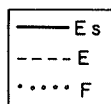

Fig. 4.32 Rules for interpreting foEs and fbEs in daytime

No.	foEs	fbEs
1	045	040
2	037	037UY
3	037	032EG
4	042	032EG
5	026-G	022-G
6	022-G	022-G
7	014DG	014DG
8	G	G
9	G	G
10	045EB	045EB

- Note: (a) Diagrams show only the ordinary trace.
 (b) For median determination, all values described by G or replaced by G are changed to (foE)EG.
 (c) If gap exceeds limit for use of U, use DY or replacement letter Y according to accuracy rules.



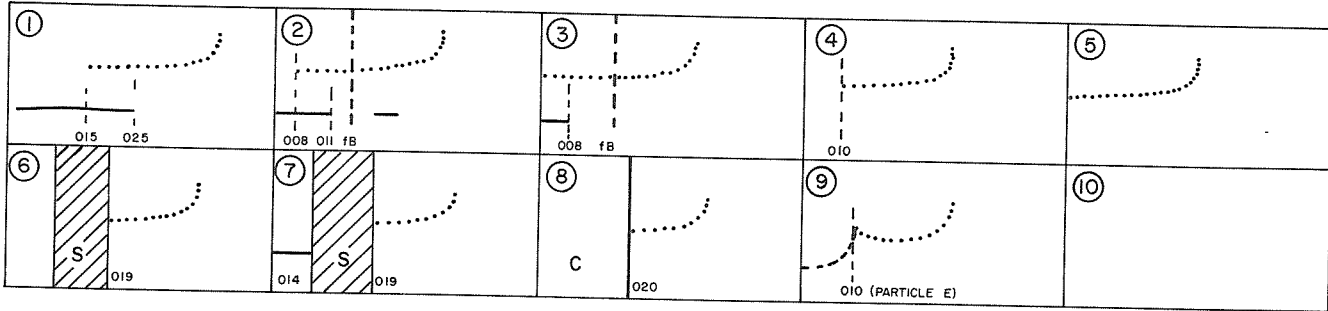
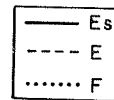

Fig. 4.33 Rules for interpreting foEs and fbEs at night

No.	foEs	fbEs
1	019JA	015
2	011	008
3	008	007EE
4	010EB	010EB
5	007EE	007EE
6	019ES	019ES
7	014DS	014DS
8	020EC	020EC
9	010-K	010-K
10	B	B

- Note:
- (a) Diagrams show only the ordinary F trace.
 - (b) For particle E, foEs = fbEs = (foE)-K
 - (c) No. 10 correct provided sequence shows foF2 above the minimum frequency of the ionosonde (in this case 007).
 - (d) fb = 1.2 MHz



4.85. Notes on distinguishing between Es types: The following notes are intended to help distinguish the correct type where pairs of types (e.g., f, a) may be confused. When in doubt the final decision is always to be based on the International Rules, section 4.83. Common but not essential features are stressed where these aid the identification.

f,a: Except when high absorption is present or foEs is below fb, flat Es type f usually shows multiple traces and is blanketing over at least part of the frequency range. In contrast Es type a seldom shows multiple traces. A little spread may be seen above Es-f on the first order when absorption is low whereas Es-a will show great spread for the same conditions.

When high absorption is present it can be difficult to distinguish between types a and f. A high gain ionogram can be used to help in this case. For Es-a there will be a significant increase in spread with gain, for Es-f little or no change. If spread is seen under high absorption conditions (fmin high), this by itself indicates type a rather than f, since the weak scatter often seen with type f under low absorption conditions is quickly removed by a small increase in absorption.

r,a: r traces usually show blanketing over part of the range and show a curved upper limit closely similar in shape to the retarded part of the normal E curve, with greatest heights near foEs. In contrast, Es-a traces usually cover a greater range of heights and often show maximum spread at a frequency well below foEs. Quite often the F trace shows retardation at a frequency appreciably lower than foEs suggesting the presence of particle E, and the r trace is blanketing to near this frequency.

l,d: A weak l trace can sometimes resemble a high d trace, but is only seen when the absorption is low as denoted by a low value of fmin and multiple reflections from higher layers. The d type would be associated with high absorption. Frequently a weak l trace is seen only very near to foE, whereas the d trace usually extends to the lowest recorded frequencies. Very dense type l Es can occur at low heights, but then usually shows multiple traces. Type d never shows multiple traces.

q,l: When both are weak traces, q extends over a wide frequency range, l over a narrow, e.g., q might extend over 1-20 MHz, l over 1 to 3 MHz. When l extends over a wider frequency range it is blanketing over at least part of the range.

Where q is very common, combined q, ℓ traces (ℓ slightly higher than q) can be seen occasionally and distinguished by the blanketing effect of ℓ at low frequencies, and the normal value of $foEs$ is associated with the q . Classify as q_1, ℓ_1 . q is extremely rare except within about $\pm 15^\circ$ from the magnetic equator.

h, c : When absorption is high near foE , letter symbol R, compare relative heights of $h'E$, $h'Es$ with similar values for clear cases of h, c . $h'Es$ for h usually lies at least 10 km above $h'E$.

ℓ, z : At high latitudes, the z -mode reflection from E is often lower than the o mode and can look similar to a low Es trace. Similar features separated by about $fB/2$ suggest Ez -mode rather than ℓ . The z -mode trace usually blankets the lower part of the E trace, the blanketing frequency varying very slowly with time. Low type Es traces do not always blanket when $foEs$ is less than foE , and their blanketing frequency usually varies rapidly with time.

4.9 Provisional f plot Indication of fxEs

A number of stations are experimenting with the addition of the top frequency of Es ($ftEs$) to the f plot. To encourage conformity the following conventions are recommended:

- (a) The standard f plot rule that the f plot shows what was actually observed should be strictly obeyed.
- (b) An open triangle Δ is recommended when $ftEs$ is equal to $fxEs$.
- (c) A closed triangle \blacktriangle is recommended
 - (i) if the value is doubtful
 - (ii) if the interpretation, $fxEs$, is doubtful
 - (iii) if the observed value of $ftEs$ is $foEs$.
- (d) Limit values are indicated by adding the appropriate descriptive letter above the solid triangle if the true value is greater than that given, below if less.

The additional information appears valuable provided it is restricted to the Es trace used to give $foEs$.

Note: When no Es traces are present during the daytime, the symbol for foE takes precedence over the symbol for Es, i.e., use an open or closed circle, not a triangle, in these cases. The plotting of $ftEs$ or $fxEs$ on f plots is purely voluntary and is not at present recommended internationally.

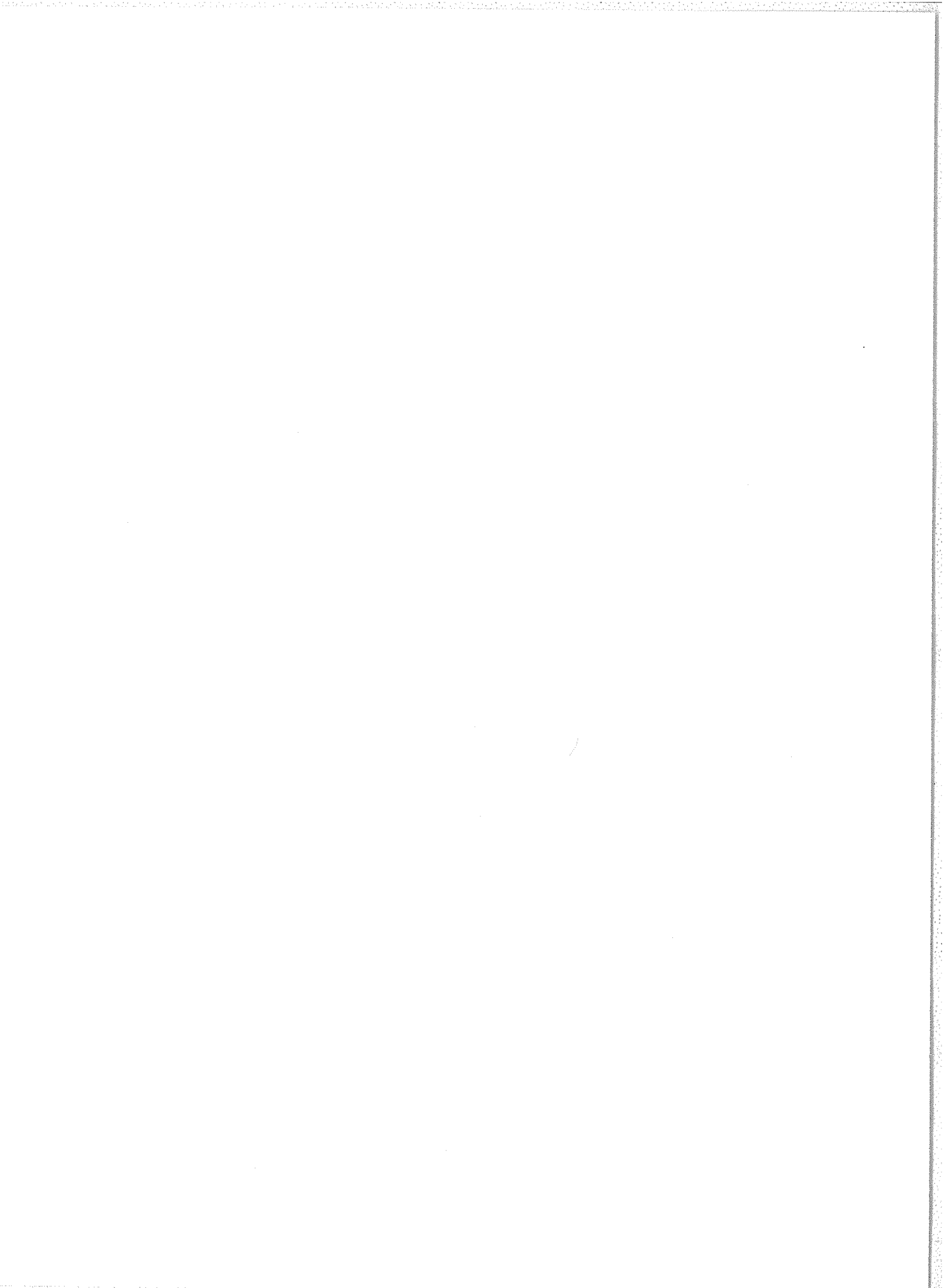

UAG Series of Reports

Prepared by World Data Center A for Solar-Terrestrial Physics, NOAA, Boulder, Colorado, U.S.A.

These reports are for sale through the National Climatic Center, Federal Building, Asheville, NC 28801, Attn: Publications. Subscription price: \$25.20 a year; \$12.00 additional for foreign mailing; single copy price varies. These reports are issued on an irregular basis with 6 to 12 reports being issued each year. Therefore, in some years the single copy rate will be less than the subscription price, and in some years the single copy rate will be more than the subscription price. Make check or money order payable to: Department of Commerce, NOAA.

Some issues are now out of print and are available only on microfiche as indicated. Requests for microfiche should be sent to World Data Center A for Solar-Terrestrial Physics, NOAA, Boulder, CO 80302, with check or money order made payable to Department of Commerce, NOAA.

- UAG-1 "IQSY Night Airglow Data", price \$1.75.
- UAG-2 "A Reevaluation of Solar Flares, 1964-1966", price 30 cents.
- UAG-3 "Observations of Jupiter's Sporadic Radio Emission in the Range 7.6-41 MHz, 6 July 1966 through 8 September 1968", microfiche only, price 45 cents.
- UAG-4 "Abbreviated Calendar Record 1966-1967", price \$1.25.
- UAG-5 "Data on Solar Event of May 23, 1967 and its Geophysical Effects", price 65 cents.
- UAG-6 "International Geophysical Calendars 1957-1969", price 30 cents.
- UAG-7 "Observations of the Solar Electron Corona: February 1964-January 1968", price 15 cents.
- UAG-8 "Data on Solar-Geophysical Activity October 24-November 6, 1968", price (includes Parts 1 & 2) \$1.75.
- UAG-9 "Data on Cosmic Ray Event of November 18, 1968 and Associated Phenomena", price 55 cents.
- UAG-10 "Atlas of Ionograms", price \$1.50.
- UAG-11 "Catalogue of Data on Solar-Terrestrial Physics" (now obsolete).
- UAG-12 "Solar-Geophysical Activity Associated with the Major Geomagnetic Storm of March 8, 1970", price (includes Parts 1-3) \$3.00.
- UAG-13 "Data on the Solar Proton Event of November 2, 1969 through the Geomagnetic Storm of November 8-10, 1969, price 50 cents.
- UAG-14 "An Experimental, Comprehensive Flare Index and Its Derivation for 'Major' Flares, 1955-1969", price 30 cents.
- UAG-15 "Catalogue of Data on Solar-Terrestrial Physics" (now obsolete).
- UAG-16 "Temporal Development of the Geographical Distribution of Auroral Absorption for 30 Substorm Events in each of IQSY (1964-65) and IASY (1969)", price 70 cents.
- UAG-17 "Ionospheric Drift Velocity Measurements at Jicamarca, Peru (July 1967-March 1970)", microfiche only, price 45 cents.
- UAG-18 "A Study of Polar Cap and Auroral Zone Magnetic Variations", price 20 cents.
- UAG-19 "Reevaluation of Solar Flares 1967", price 15 cents.
- UAG-20 "Catalogue of Data on Solar-Terrestrial Physics" (now obsolete).
- UAG-21 "Preliminary Compilation of Data for Retrospective World Interval July 26 - August 14, 1972", price 70 cents.
- UAG-22 "Auroral Electrojet Magnetic Activity Indices (AE) for 1970", price 75 cents.
- UAG-23 "U.R.S.I. Handbook of Ionogram Interpretation and Reduction", price \$1.75.
- UAG-24 "Data on Solar-Geophysical Activity Associated with the Major Ground Level Cosmic Ray Events of 24 January and 1 September 1971", price (includes Parts 1 and 2) \$2.00.
- UAG-25 "Observations of Jupiter's Sporadic Radio Emission in the Range 7.6-41 MHz, 9 September 1968 through 9 December 1971", price 35 cents.
- UAG-26 "Data Compilation for the Magnetospherically Quiet Periods: February 19-23 and November 29 - December 3, 1970", price 70 cents.
- UAG-27 "High Speed Streams in the Solar Wind", price 15 cents.
- UAG-28 "Collected Data Reports on August 1972 Solar-Terrestrial Events", price (includes Parts 1-3) \$4.50.
- UAG-29 "Auroral Electrojet Magnetic Activity Indices AE (11) for 1968", price 75 cents.
- UAG-30 "Catalogue of Data on Solar-Terrestrial Physics", price \$1.75.
- UAG-31 "Auroral Electrojet Magnetic Activity Indices AE (11) for 1969", price 75 cents.
- UAG-32 "Synoptic Radio Maps of the Sun at 3.3 mm for the Years 1967-1969", price 35 cents.
- UAG-33 "Auroral Electrojet Magnetic Activity Indices AE (10) for 1967", price 75 cents.
- UAG-34 "Absorption Data for the IGY/IGC and IQSY", price \$2.00.
- UAG-35 "Catalogue of Digital Geomagnetic Variation Data at World Data Center A for Solar-Terrestrial Physics", price 20 cents.
- UAG-36 "An Atlas of Extreme Ultraviolet Flashes of Solar Flares Observed Via Sudden Frequency Deviations During the ATM-SKYLAB Missions", price 55 cents.
- UAG-37 "Auroral Electrojet Magnetic Activity Indices AE (10) for 1966", price 75 cents.
- UAG-38 "Master Station List for Solar-Terrestrial Physics Data at WDC-A for Solar-Terrestrial Physics", price \$1.60.
- UAG-39 "Auroral Electrojet Magnetic Activity Indices AE (11) for 1971", by Joe Haskell Allen, Carl C. Abston and Leslie D. Morris, National Geophysical and Solar-Terrestrial Data Center, Environmental Data Service, February 1975, 144 pages, price \$2.05.
- UAG-40 "H-Alpha Synoptic Charts of Solar Activity For the Period of Skylab Observations, May, 1973-March, 1974", by Patrick S. McIntosh, NOAA Environmental Research Laboratories, February 1975, 32 pages, price 56 cents.
- UAG-41 "H-Alpha Synoptic Charts of Solar Activity During the First Year of Solar Cycle 20, October, 1964 - August, 1965", by Patrick S. McIntosh, NOAA Environmental Research Laboratories, and Jerome T. Nolte, American Science and Engineering, Cambridge, Massachusetts, March 1975, 25 pages, price 48 cents.
- UAG-42 "Observations of Jupiter's Sporadic Radio Emission in the Range 7.6-80 MHz 10 December 1971 through 21 March 1975", by James W. Warwick, George A. Dulk, and Anthony C. Riddle, Department of Astro-Geophysics, University of Colorado, Boulder, Colorado 80302, April 1975, 49 pages, price \$1.15.
- UAG-43 "Catalog of Observation Times of Ground-Based Skylab-Coordinated Solar Observing Programs", compiled by Helen E. Coffey, World Data Center A for Solar-Terrestrial Physics, May 1975, 159 pages, price \$3.00.
- UAG-44 "Synoptic Maps of Solar 9.1 cm Microwave Emission from June 1962 to August 1973", by Werner Graf and Ronald N. Bracewell, Radio Astronomy Institute, Stanford University, Stanford, California 94305, May 1975, 183 pages, price \$2.55.
- UAG-45 "Auroral Electrojet Magnetic Activity Indices AE (11) for 1972", by Joe Haskell Allen, Carl C. Abston and Leslie D. Morris, National Geophysical and Solar-Terrestrial Data Center, Environmental Data Service, May 1975, 144 pages, price \$2.10.
- UAG-46 "Interplanetary Magnetic Field Data 1963-1974", by Joseph H. King, National Space Science Data Center, NASA Goddard Space Flight Center, Greenbelt, Maryland 20771, June 1975, 382 pages, price \$2.95.
- UAG-47 "Auroral Electrojet Magnetic Activity Indices AE (11) for 1973", by Joe Haskell Allen, Carl C. Abston and Leslie D. Morris, National Geophysical and Solar-Terrestrial Data Center, Environmental Data Service, June 1975, 144 pages, price \$2.10.

- UAG-48A "Synoptic Observations of the Solar Corona during Carrington Rotations 1580-1596 (11 October 1971 - 15 January 1973)", [Reissue with quality images] by R. A. Howard, M. J. Koomen, D. J. Michels, R. Tousey, C. R. Detwiler, D. E. Roberts, R. T. Seal and J. D. Whitney, E. O. Hulbert Center for Space Research, NRL, Washington, D. C. 20375 and R. T. and S. F. Hansen, C. J. Garcia and E. Yasukawa, High Altitude Observatory, NCAR, Boulder, Colorado 80303, February 1976, 200 pages, price \$4.27.
- UAG-49 "Catalog of Standard Geomagnetic Variation Data", prepared by Environmental Data Service, NOAA, Boulder, Colorado, August 1975, 125 pages, price \$1.85.
- UAG-50 "High-Latitude Supplement to the URSI Handbook on Ionogram Interpretation and Reduction", by W. R. Piggott, British Antarctic Survey, c/o SRC, Appleton Laboratory, Ditton Park, Slough, England, October 1975, 292 pages, price \$4.00.
- UAG-51 "Synoptic Maps of Solar Coronal Hole Boundaries Derived from He II 304Å Spectroheliograms from the Manned Skylab Missions", by J. D. Bohlin and D. M. Rubenstein, E. O. Hulbert Center for Space Research, Naval Research Laboratory, Washington, D. C. 20375 U.S.A., November 1975, 30 pages, price 54 cents.
- UAG-52 "Experimental Comprehensive Solar Flare Indices for Certain Flares, 1970-1974", compiled by Helen W. Dodson and E. Ruth Hedeman, McMath-Hulbert Observatory, The University of Michigan, 895 Lake Angelus Road North, Pontiac, Michigan 48055 U.S.A., November 1975, 27 pages, price 60 cents.
- UAG-53 "Description and Catalog of Ionospheric F-Region Data, Jicamarca Radar Observatory (November 1966 - April 1969)", by W. L. Clark and T. E. Van Zandt, Aeronomy Laboratory, NOAA, Boulder, Colorado 80302 and J. P. McClure, University of Texas at Dallas, Dallas, Texas 75230, April 1976, 10 pages, price 33 cents.
- UAG-54 "Catalog of Ionosphere Vertical Soundings Data", prepared by Environmental Data Service, NOAA, Boulder, Colorado 80302, April 1976, 130 pages, price \$2.10.
- UAG-55 "Equivalent Ionospheric Current Representations by a New Method, Illustrated for 8-9 November 1969 Magnetic Disturbances", by Y. Kamide, Cooperative Institute for Research in Environmental Sciences, University of Colorado, Boulder, Colorado 80302 and Geophysical Institute, University of Alaska, Fairbanks, Alaska 99701, H. W. Kroehl, Data Studies Division, NOAA/EDS/NGSDC, Boulder, Colorado 80302, M. Kanamitsu, Advanced Study Program, National Center for Atmospheric Research, Boulder, Colorado 80303, J. H. Allen, Data Studies Division, NOAA/EDS/NGSDC, Boulder, Colorado 80302, and S.-I. Akasofu, Geophysical Institute, University of Alaska, Fairbanks, Alaska 99701, April 1976, 91 pages, price \$1.60.
- UAG-56 "Iso-intensity Contours of Ground Magnetic H Perturbations for the December 16-18, 1971 Geomagnetic Storm", by Y. Kamide, Cooperative Institute for Research in Environmental Sciences, University of Colorado, Boulder, Colorado 80302 and Geophysical Institute, University of Alaska, Fairbanks, Alaska 99701 (currently Guest worker at Data Studies Division, NOAA/EDS/NGSDC, Boulder, Colorado 80302), April 1976, 37 pages, price \$1.39.
- UAG-57 "Manual on Ionospheric Absorption Measurements", edited by K. Rawer, Institut für Physikalische Weltraumforschung, Freiburg, G.F.R., June 1976, 202 pages, price \$4.27.
- UAG-58 "ATS6 Radio Beacon Electron Content Measurements at Boulder, July 1974 - May 1975", by R. B. Fritz, Space Environment Laboratory (currently with Wave Propagation Laboratory), NOAA, Boulder, Colorado 80302 USA, September 1976, 61 pages, price \$1.04.
- UAG-59 "Auroral Electrojet Magnetic Activity Indices AE(11) for 1974", by Joe Haske11 Allen, Carl C. Abston and Leslie D. Morris, National Geophysical and Solar-Terrestrial Data Center, Environmental Data Service, December 1976, 144 pages, price \$2.16.
- UAG-60 "Geomagnetic Data for January 1976 (AE(7) Indices and Stacked Magnetograms)" by J. H. Allen, C. C. Abston and L. D. Morris, NGSDC/EDS/NOAA, July 1977, 57 pages, price \$1.07.
- UAG-61 "Collected Data Reports for STIP Interval II 20 March - 5 May 1976", edited by Helen E. Coffey and John A. McKinnon, National Geophysical and Solar-Terrestrial Data Center, Environmental Data Service, August 1977, 313 pages, price \$2.95.
- UAG-62 "Geomagnetic Data For February 1976 (AE(7) Indices and Stacked Magnetograms)" by J. H. Allen, C. C. Abston and L. D. Morris, NGSDC/EDS/NOAA, September 1977, 55 pages, price \$1.11.
- UAG-63 "Geomagnetic Data for March 1976 (AE(7) Indices and Stacked Magnetograms)" by J. H. Allen, C. C. Abston and L. D. Morris, NGSDC/EDS/NOAA, September 1977, 57 pages, price \$1.11.
- UAG-64 "Geomagnetic Data for April 1976 (AE(8) Indices and Stacked Magnetograms)" by J. H. Allen, C. C. Abston and L. D. Morris, NGSDC/EDS/NOAA, February 1978, 55 pages, price \$1.00.
- UAG-65 "The Information Explosion and Its Consequences for Data Acquisition, Documentation, and Processing" by G. K. Hartmann, Max-Planck-Institut für Aeronomie, D-3411 Katlenburg-Lindau 3, GFR, May 1978, 36 pages, price 75 cents.
- UAG-66 "Synoptic Radio Maps of the Sun at 3.3mm 1970-1973" by Earle B. Mayfield, Space Science Lab., and Fred I. Shimabukuro Electronics Res. Lab., The Ivan A. Getting Laboratories, The Aerospace Corp., El Segundo, California 90245, May 1978, 30 pages, price 75 cents.