

**WORLD DATA CENTER A
for
Solar-Terrestrial Physics**

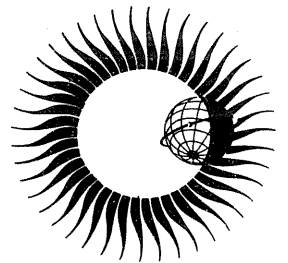

**CATALOG OF OBSERVATION TIMES OF
GROUND-BASED SKYLAB-COORDINATED
SOLAR OBSERVING PROGRAMS**

May 1975



WORLD DATA CENTER A

National Academy of Sciences

2101 Constitution Avenue, N.W. Washington, D.C. U.S.A., 20418

World Data Center A consists of the Coordination Office

and seven subcenters:

World Data Center A
Coordination Office
National Academy of Sciences
2101 Constitution Avenue, N.W.
Washington, D.C., U.S.A. 20418
Telephone (202) 389-6478

Glaciology:

World Data Center A:
Glaciology
U.S. Geological Survey
1305 Tacoma Avenue South
Tacoma, Washington, U.S.A. 98402
Telephone (206) 593-6506

Rockets and Satellites:

World Data Center A:
Rockets and Satellites
Goddard Space Flight Center
Code 601
Greenbelt, Maryland, U.S.A. 20771
Telephone (301) 982-6695

Longitude and Latitude

World Data Center A:
Longitude and Latitude
U.S. Naval Observatory
Washington, D.C., U.S.A. 20390
Telephone (202) 254-4023

Seismology, Tsunamis, Gravimetry, Earth
Tides, Recent Movements of the Earth's
Crust, Magnetic Measurements, Paleo-
magnetism and Archeomagnetism, Volcanology,
Geothermics:

World Data Center A:
Solid-Earth Geophysics
Environmental Data Service, NOAA
Boulder, Colorado, U.S.A. 80302
Telephone (303) 499-1000 Ext. 6311

Meteorology (and Nuclear Radiation):

World Data Center A:
Meteorology
National Climatic Center
Federal Building
Asheville, North Carolina, U.S.A. 28801
Telephone (704) 258-2850

Solar-Terrestrial Physics (Solar and Inter-
planetary Phenomena, Ionospheric Phenomena,
Geomagnetic Variations, Magnetospheric and
Interplanetary Magnetic Phenomena, Flare-
Associated Events, Aurora, Cosmic Rays,
Airglow):

World Data Center A
for Solar-Terrestrial Physics
Environmental Data Service, NOAA
Boulder, Colorado, U.S.A. 80302
Telephone (303) 499-1000 Ext. 6467

Oceanography:

World Data Center A:
Oceanography
National Oceanic and
Atmospheric Administration
Washington, D.C., U.S.A. 20235
Telephone (202) 634-7249

Notes:

- (1) World Data Centers conduct international exchange of geophysical observations in accordance with the principles set forth by the International Council of Scientific Unions. WDC-A is established in the United States under the auspices of the National Academy of Sciences.
- (2) Communications regarding data interchange matters in general and World Data Center A as a whole should be addressed to: World Data Center A, Coordination Office (see address above).
- (3) Inquiries and communications concerning data in specific disciplines should be addressed to the appropriate subcenter listed above.

WORLD DATA CENTER A for Solar-Terrestrial Physics



REPORT UAG - 43

CATALOG OF OBSERVATION TIMES OF GROUND-BASED SKYLAB-COORDINATED SOLAR OBSERVING PROGRAMS

compiled by

Helen E. Coffey
World Data Center A for
Solar-Terrestrial Physics
NOAA, Boulder, Colorado 80302 USA

May 1975

Published by World Data Center A for
Solar-Terrestrial Physics, NOAA, Boulder, Colorado
and printed by

U.S. DEPARTMENT OF COMMERCE
NATIONAL OCEANIC AND ATMOSPHERIC ADMINISTRATION
ENVIRONMENTAL DATA SERVICE
Asheville, North Carolina, USA 28801

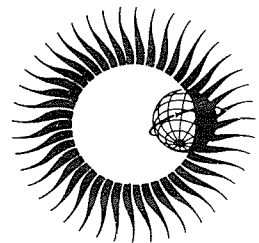

SUBSCRIPTION PRICE: \$25.20 a year; \$12.00 additional for foreign mailing; single copy price varies.* Checks and money orders should be made payable to the Department of Commerce, NOAA. Remittance and correspondence regarding subscriptions should be sent to the National Climatic Center, Federal Building, Asheville, NC 28801, Attn: Publications.

*PRICE THIS ISSUE \$3.00

TABLE OF CONTENTS

	Page
SECTION I. Introduction	1
Report on the Ground-Based Programs	1
Brief Synopsis of Data in Sections II and III	2
Apollo Telescope Mount Joint Observing Programs (JOPs) on board SKYLAB	3
Summary of Suggested JOP Interfacing from some Observatories	4
Acknowledgements	5
SECTION II. Program Details with Tables of Variables	6
Category 1.1) Full Disk Solar Observations	6
Table 1.1	
1.2) Full Disk Solar Observations (continued)	20
Table 1.2	
2.1) Localized Small-Scale Observations	32
Table 2.1	
2.2) Localized Small-Scale Observations (continued)	44
Table 2.2	
3.1) Magnetograms	53
Table 3.1	
4.1) Coronagraphs	65
Table 4.1	
5.1) Prominences	82
Table 5.1	
6.1) Solar Radio Observations	93
Table 6.1	
7.1) X-ray and SFD Measurements	101
III. Descriptive Program Information Submitted without Observing Time Data	101
IV. Other Sources of SKYLAB Period Data	103
V. Some SKYLAB Period Data:	
Charts of flare observations for July 29 and September 7, 1973	106
Nançay East-West Solar Scans (169 MHz, 408 MHz and 9400 MHz)	109
Johns Hopkins University Applied Physics Lab Solar Radio Emission Spectral Observations (565-1000 MHz)	151
APPENDIX: ATM Investigating Teams and Collaborators	155
SKYLAB/ATM Coordinated Ground-Based Observations DAILY FORM	159

CATALOG OF OBSERVATION TIMES OF GROUND-BASED
SKYLAB-COORDINATED SOLAR OBSERVING PROGRAMS

compiled by

Helen E. Coffey
World Data Center A for
Solar-Terrestrial Physics
NOAA, Boulder, Colorado 80302 U.S.A.

I. INTRODUCTION

Solar physicists around the world collaborated in an international effort to provide extensive ground-based coverage of solar activity during the SKYLAB Apollo Telescope Mount (ATM) program. This ground-based coverage provided invaluable assistance to the SKYLAB experimenters by alerting them to possible interesting observing intervals. It is also proving useful in reducing the myriad amount of SKYLAB/ATM data, to fill in times when SKYLAB was not observing, to supplement the SKYLAB data in order to optimize the interpretation of solar phenomena, and to aid in determining interesting periods for study.

This international collaboration has brought together the expertise of many scientists to deal with an unprecedented collection of excellent solar observations. We attempt here to provide a useful reference guide for this extraordinary research effort.

This catalog of observations of ground-based SKYLAB-coordinated programs has been compiled from the SKYLAB/ATM COORDINATED GROUND-BASED OBSERVATIONS DAILY FORMS (see Appendix) sent in to the World Data Center A (WDC-A) for Solar-Terrestrial Physics by the observatories and from descriptions of programs received from the ground-based experimenters. It includes the complete program information provided by the experimenters. In separate tables all variables of the programs are listed, such as the times of the observations made each day by these experimenters, both during SKYLAB manned mission dates as well as during the intervening periods. It covers the period May 28, 1973 to February 3, 1974. In some cases periods before and after the SKYLAB mission are included for a comprehensive coverage of solar activity evolution during the entire SKYLAB period.

The aim has been towards being precise in the type and duration of the observations. Information on the availability and format of the data is also included. This is not a data compilation of events, but rather of types of observations and observing periods for which data can be made available.

Due to the amount of detail received, no attempt has been made to contact experimenters about discrepancies or missing data information, such as listing field of view estimates with no solar coordinates. We trust enough information on each program was submitted to give a working knowledge or at least a starting point for obtaining data in the different categories.

For data which can be easily copied, we strongly encourage that experimenters send copies to WDC-A for Solar-Terrestrial Physics. This will facilitate their maximum usage in conjunction with the analysis of the SKYLAB spacecraft data. Such data, along with other pertinent data which are received routinely and are held in the WDC-A for Solar-Terrestrial Physics archives, are referenced in this catalog. Appropriate data which have already been published in *Solar-Geophysical Data* or other publications, when known, are also referenced. Some data, not regularly available, taken during the SKYLAB mission and forwarded to WDC-A for Solar-Terrestrial Physics appear in Section V of this Report.

Report on the Ground-Based Programs

The period of this report begins on May 28, 1973, when the astronauts of the first SKYLAB manned mission commenced check-out procedures on the Apollo Telescope Mount (ATM) experiments, and extends to February 3, 1974, the end of the third ATM manned program on SKYLAB. Several automatic experiments were run on SKYLAB during the unmanned periods June 22 to July 27, 1973 and September 26 to November 15, 1973. Actual SKYLAB manned mission dates are: May 28 to June 21, 1973; July 28 to September 25, 1973; and November 16, 1973 to February 8, 1974. ATM manned operations cover the periods May 29 to June 18, 1973, August 7 to September 21, 1973 and November 26, 1973 to February 3, 1974.

Detailed information on the ground-based programs and tables of observing times and other variables such as seeing, positions of measurements, wavelength changes, etc., for the different kinds of observations are presented in Section II. Following, in Section III, is the information received on those programs for which descriptive texts only are available. In Section IV other sources of data for the SKYLAB period are listed. Section V includes some data, not regularly available, taken during the SKYLAB mission and forwarded to WDC-A for Solar-Terrestrial Physics. In the Appendix a list of the ATM investigating teams is given, along with their collaborators, reproduced from the NASA publication *SKYLAB and the Sun*.

Brief Synopsis of Data in Sections II and III

Due to the amount of information received, Full Disk Solar Observations were separated into two categories, Category 1.1 and 1.2. Stations appear to be placed arbitrarily in either of these two categories. This is the result of a decision to reuse the Table 1 which appeared in the "Preliminary Catalog of Ground-Based Skylab-Coordinated Solar Observing Programs for the period May 28 to July 26, 1973", a special booklet circulated in September 1973, to participants in the SKYLAB program. Stations are listed by longitude in each category. Users are asked to consider both categories when interested in Full Disk Observations. A similar situation occurs in the Localized Small-Scale Observations, Categories 2.1 and 2.2.

The following lists the station and type of data which appear in Sections II and III of this Report:

- SECTION II Category 1.1) Full Disk Solar Observations (stations listed by longitude)
- 1.1.1 Tel Aviv H-alpha (1/3 solar disk) photoheliograms
 - 1.1.2 Lockheed Ca II (8542 Å) filtergrams
 - 1.1.3 Big Bear H-alpha filtergrams
 - 1.1.4 Kitt Peak Ca⁺K (3933 Å), H-alpha (6562 Å) and CN (3883 Å) spectroheliograms
 - 1.1.5 Kitt Peak Fe I (5233 Å) magnetograms
 - 1.1.6 Kitt Peak He I (10830 Å) spectroheliograms
- Category 1.2) continuation of Full Disk Solar Observations
(stations listed by longitude)
- 1.2.1 Lockheed H-alpha disk measurements
 - 1.2.2 Sacramento Peak { He I D₃ (5875 Å) spectroheliograms
 { H-alpha (6563 Å) "
 { Ca K (3934 Å) "
- Category 2.1) Localized Small-Scale Observations (stations listed by longitude)
- 2.1.1 Crimea H-alpha cinematograms
 - 2.1.2 Big Bear H-alpha - 0.5 Å, H-alpha, and Ca K cinematograms
 - 2.1.3 Big Bear H-alpha and Ca K (1/6 solar disk) cinematograms
 - 2.1.4 Mt. Lemmon infrared photometry
- Category 2.2) continuation of Localized Small-Scale Observations
(stations listed by longitude)
- 2.2.1 Culgoora H-alpha filtergrams
 - 2.2.2 Lockheed H-alpha filtergrams and H-alpha ± 8 Å spectra
 - 2.2.3 Lockheed H-alpha Doppler measurements
 - 2.2.4 Lockheed He I D₃ (5876 Å) large scale
 - 2.2.5 Sacramento Peak universal birefringent filter observations
(43 wavelengths)
 - 2.2.6 Sacramento Peak D₃ (5875 Å), H-alpha (6563 Å), and Ca K +
0.38 Å (3934 + 0.38 Å) spectroheliograms
- Category 3.1) Magnetograms (stations listed by longitude)
- 3.1.1 Crimea small scale magnetograms
 - 3.1.2 Sayan Mountain sunspot group magnetograms
 - 3.1.3 " " solar center magnetograms
 - 3.1.4 Big Bear small scale magnetograms
 - 3.1.5 Kitt Peak polar scans
 - 3.1.6 " " area scan reports
 - 3.1.7 Sacramento Peak sunspot group magnetograms

Brief Synopsis of Section II continued

Category 4.1) Coronagraphs (stations listed by longitude)

- 4.1.1. Mauna Loa 6200 Å white light coronagraphs
- 4.1.2. Sacramento Peak $\lambda\lambda 3550-9000$ Å coronal active regions
- 4.1.3. " " coronagraphs: 6" at 5303 Å
4" at 5303 and 6374 Å
- 4.1.4. Sacramento Peak 5303 Å coronagraph
- 4.1.5. " " {SJC-1 filtergram $\lambda 6563$ Å
SJC-2 filtergram $\lambda\lambda 6563, 6375, 6374, 5303$ Å
Spectra: $\lambda\lambda 8024, 7892, 7059, 6703, 6563, 6374, 5875,$
5694, 5445, 5411, 5303, 4686, 4412 Å

Category 5.1) Prominences (stations listed by longitude)

- 5.1.1. Oslo $\lambda\lambda 3967, 6563$ Å filtergram / spectra
- 5.1.2. Mauna Loa 6563 Å filtergram / coronagraph
- 5.1.3. Kitt Peak spectra of bright quiescent prominences
- 5.1.4. Kitt Peak 10830 Å spectra
- 5.1.5. Sacramento Peak 16" coronagraph / photographic spectra

Category 6.1) Solar Radio Observations (stations listed by longitude)

- 6.1.1. Nançay Solar Radio Observatory (3 cm, 408 MHz, 169 MHz)
- 6.1.2. Dwingeloo (200-213 MHz, 234-246 MHz and 282-315 MHz)
- 6.1.3. Crimea (1.9, 2.5, 3.5 and 10 cm)
- 6.1.4. Toyokawa (3.2, 8, 15, and 30 cm)
- 6.1.5. Clark Lake (15-2.5 m)
- 6.1.6. University of Colorado (37.5-3.75 m (8-80 MHz))
- 6.1.7. Harvard Radio Astronomy Station, Ft. Davis (10-4000 MHz)
- 6.1.8. Johns Hopkins Applied Physics Lab. (565-1000 MHz)

Category 7.1) X-Ray and SFD Measurements

- 7.1.1. SOLRAD 9 and 10 solar X-rays
- 7.1.2. Sacramento Peak SFD measurements of impulsive 10-1030 Å flux enhancements from flares

SECTION III Descriptive Program Information Submitted without Observing Time Data
(stations listed by longitude)

- Big Bear Full disk white light pictures
- " " 10830 Å filtergrams
- Related Program: Pasadena H-alpha cinematograms (2/3 solar disk)
- Sacramento Peak He I and Ca II spectra for chromospheric plage data
- The University of Chicago . . . Rocket X-ray spectra
- Loiyengalani, Kenya Near infrared photography of the outer corona during 1973 solar eclipse

Apollo Telescope Mount Joint Observing Programs (JOPs) on board SKYLAB

A list of the ATM Joint Observing Programs (JOPs) on board SKYLAB and the suggested JOP interfacing we received with some of the ground-based observing program inputs is given below. The JOP list is extracted from the NASA SL-3 Second Skylab Mission ATM JOP Summary Sheets prepared by EVA and Experiments Branch, Crew Procedures Division, NASA, Lyndon B. Johnson Space Center, Houston, Texas, July 9, 1973. The ATM Missions Operation Log will be available from the National Space Science Data Center (NSSDC) in late 1975. To list all JOP observing times here is beyond the scope of this report. For example, 205 hours of observing time were scheduled for the second SKYLAB manned mission alone. WWV broadcasted every hour (at 22 minutes after the hour), as did WWVH (at 25 and 27 minutes after the hour), the scheduled SKYLAB observing times for the previous four hours and the following eight hours. This message was updated every four hours and was also transmitted through the International Ursigram and World Days Service (IUWDS) Regional Warning Centers.

- JOP1Chromospheric Network: A. Near Solar Center
B. Within 2 Arc-Min of Limb
C. At Limb
D. Short Term Evolution
E. Spicules at Limb
- JOP2Active Regions: A. Rapidly Developing E. Sunspots
B. Long Term Evolution - Disk F. Chromospheric Velocities
C. Long Term Evolution - Limb G. Ellerman Bombs
D. Structure
- JOP3Flares
- JOP4A. Prominences
B. Filaments
- JOP5Limb Profile Studies
- JOP6Synoptic Observations
- JOP7Atmospheric Extinction
- JOP8Coronal Transients
- JOP9Solar Wind
- JOP10Lunar Libration Clouds
- JOP11Chromospheric Oscillations and Heating
- JOP12Calibrations
- JOP13Night Sky Objects
- JOP14Solar Eclipse (First manned mission)
- JOP15A. Coronal Holes on the Disk
B. Coronal Holes on the Limb
C. Evolution of Coronal Hole
D. Coronal Hole Velocities
- JOP16Disk Transients
- JOP17A. Structure of XUV and X-Ray Bright Spot
B. Short and Long Term Evolution of Bright Spot

An additional JOP for the third manned SKYLAB mission was Comet Observations.

Summary of Suggested JOP Interfacing From Some Observatories

For aid in locating program details in this catalog, the category reference in Section II is listed here also.

<u>JOP</u>	<u>STATION AND PROGRAM</u>	<u>CATEGORY</u>
JOP1 . . .	Sac Peak full disk spectroheliograms - He D ₃ , H-alpha, Ca K	1.2.2
	Culgoora H-alpha filtergrams	2.2.1
	Lockheed Multi-slit spectrograph - H-alpha	2.2.2
	H-alpha Doppler filtergrams	2.2.3
	D ₃ He I large scale filtergrams	2.2.4
	Sac Peak UBF	2.2.5
JOP2 . . .	Lockheed H-alpha full disk	1.2.1
	Multi-slit spectrograph - H-alpha	2.2.2
	H-alpha Doppler filtergrams	2.2.3
	He I D ₃ large scale filtergrams	2.2.4
	Sac Peak UBF	2.2.5
	D ₃ , H-alpha and Ca K+0.38Å spectroheliograms	2.2.6
JOP2C. . .	Sac Peak λλ3550-9000 Å coronal active regions	4.1.2
	coronographs	4.1.3
	filtergrams / spectra	4.1.5
JOP2E. . .	Sac Peak magnetic fields in sunspots	3.1.7

Summary of JOP interfacing continued

<u>JOP</u>	<u>STATION AND PROGRAM</u>	<u>CATEGORY</u>
JOP3 . . .	Lockheed H-alpha full disk and He I D ₃ limb	1.2.1
	Multi-slit spectrograph - H-alpha	2.2.2
	H-alpha Doppler filtergrams	2.2.3
	He I D ₃ large scale filtergrams	2.2.4
	Clark Lake Radio observations.	6.1.5
JOP4 . . .	Lockheed H-alpha full disk	1.2.1
	Multi-slit spectrograph - H-alpha	2.2.2
	H-alpha Doppler filtergrams	2.2.3
	He I D ₃ large scale filtergrams	2.2.4
	Sac Peak coronographs, prominence spectra and filtergrams	5.1.5
JOP5 . . .	Lockheed H-alpha full disk	1.2.1
	Multi-slit spectrograph - H-alpha	2.2.2
	H-alpha Doppler filtergrams	2.2.3
	He I D ₃ large scale filtergrams	2.2.4
	Sac Peak UBF	2.2.5
JOP6 . . .	Lockheed H-alpha full disk	1.2.1
	Sac Peak full disk spectroheliograms - He D ₃ , H-alpha, Ca K	1.2.2
	UBF	2.2.5
	coronographs.	4.1.3
	5303Å coronagraph	4.1.4
	Clark Lake Radio observations.	6.1.5
JOP8. . .	Sac Peak coronographs.	4.1.3
	Clark Lake Radio Observations.	6.1.5
JOP9 . . .	Clark Lake Radio observations.	6.1.5
JOP10. . .	Sac Peak UBF	2.2.5
JOP11. . .	Sac Peak full disk spectroheliograms - He D ₃ , H-alpha, Ca K.	1.2.2
	Lockheed Multi-slit spectrograph - H-alpha	2.2.2
	H-alpha Doppler filtergrams	2.2.3
	He I D ₃ large scale filtergrams	2.2.4
	Sac Peak UBF.	2.2.5
JOP15. . .	Sac Peak UBF	2.2.5
JOP16. . .	Sac Peak full disk spectroheliograms - He D ₃ , H-alpha, Ca K.	1.2.2
	D ₃ , H-alpha, Ca K +0.38Å spectroheliograms.	2.2.6
JOP17. . .	Sac Peak full disk spectroheliograms - He D ₃ , H-alpha, Ca K.	1.2.2

Acknowledgements

We particularly would like to thank all the participating observatories for making this compilation possible. We especially recognize the usefulness of the ATM/alert message code transmitted through the WWV Time and Frequency Broadcasts and the IUWDS Regional Warning Centers which enabled this international effort to take place.

We would also like to thank Dr. Robert O. Doyle of Harvard College Observatory who headed the Coordinated Observing Program, and Patrick S. McIntosh and J. Virginia Lincoln of NOAA for their efforts in drafting a SKYLAB/ATM Coordinated Ground-based Observation Daily Form. Also, we thank May Starr, Alice McRae and Carol Weathers for typing the manuscript, Chuck Shanks for the drafting involved, and the various NOAA personnel who reviewed the manuscript.

II. PROGRAM DETAILS with Tables of Variables

Program variables are given in the Tables, e.g., times of observations, seeing conditions, position measurements, etc. Symbols are used in the tables to flag additional information about individual observations. The symbol codes are found in the footnotes at the end of each table.

CATEGORY 1.1) FULL DISK SOLAR OBSERVATIONS Stations Listed by Longitude

1.1.1 STATION: Tel Aviv Solar Observatory N32 E34
PROGRAM: Ground-based 5-inch photoheliograph in H-alpha of 1/3 solar disk

OBSERVING TIMES OF H-ALPHA CINEMATOGRAMS: see Table
DATA FORMAT AVAILABLE: Direct scientist-to-scientist

INVESTIGATOR: Harold Zirin
California Institute of Technology
354-33
Pasadena, California USA 91109

1.1.2 STATION: Lockheed Solar Observatory N34 E242
PROGRAM: Ground-based filtergram; full disk Ca II (8542 Å) measurements

OBSERVING TIMES AND RATES: see Table
WAVELENGTHS: Ca II (8542 Å)
MEASUREMENTS: Full disk
FILM TYPE: SO 392
IMAGE SCALE OF ORIGINAL: Image diameter ~ 16 mm
QUALITY: see Table
DATA FORMAT AVAILABLE: Duplicate negatives / Prints
Direct scientist-to-scientist

INVESTIGATOR: H. Ramsey
Lockheed-California Company
Solar Physics, Bldg. 243, P1. 2
Burbank, California USA 91503

1.1.3 STATION: Big Bear Solar Observatory N34 E243
PROGRAM: Ground-based full disk H-alpha pictures taken with Fabry-Perot filter using the Singer-Link telescope

OBSERVING TIMES AND RATES: every 10 seconds; for times see Table
DATA FORMAT AVAILABLE: Direct scientist-to-scientist

INVESTIGATOR: Harold Zirin
California Institute of Technology
354-33
Pasadena, California USA 91109

1.1.4 STATION: Kitt Peak Observatory N32 E249
PROGRAM: Ground-based full disk spectroheliograms (After August 11, 1973, a 900x1200 arcsec area is scanned).

OBSERVING TIMES AND RATES: Scan rates are approximately 2 minutes; see Table for observing times
WAVELENGTHS: Ca⁺K (3933 Å) ($\Delta\lambda = .10 \text{ \AA}$); H-alpha (6562 Å) ($\Delta\lambda = .10 \text{ \AA}$); CN (3883 Å) ($\Delta\lambda = .12 \text{ \AA}$)
FILM TYPE: II O, II F
IMAGE SCALE OF ORIGINAL: 11.2 cm; after August 11, 1973, 37.3 cm
QUALITY: see Table
DATA FORMAT AVAILABLE: Prints
to World Data Centers

INVESTIGATORS: Bruce Gillespie, J. Harvey, and W. C. Livingston
Kitt Peak National Observatory
P.O. Box 26732
950 North Cherry Avenue
Tucson, Arizona USA 85726

CATEGORY 1.1 continued

1.1.5 STATION: Kitt Peak Observatory N32 E249
PROGRAM: Ground-based full disk magnetograms using vacuum telescope unless otherwise noted in Table

OBSERVING TIMES: see Table (UT = MST + 7 hours)
WAVELENGTHS: Fe I (5233 Å) unless otherwise noted in Table
QUALITY: Generally fine, unless otherwise noted in Table
EQUIPMENT FAILURES: see Table
OTHER PERTINENT INFORMATION: see Table
DATA FORMAT AVAILABLE: Prints / Digitized (tape)

INVESTIGATORS: Bruce Gillespie, J. Harvey, and W. C. Livingston
Kitt Peak National Observatory
P.O. Box 26732
950 North Cherry Avenue
Tucson, Arizona USA 85726

1.1.6 STATION: Kitt Peak Observatory N32 E249
PROGRAM: Ground-based Helium spectroheliogram; 512 channel magnetograph, vacuum telescope

OBSERVING TIMES AND RATES: one observation/day; for times see Table (UT = MST + 7 hours)
WAVELENGTHS: He I 10830 Å
MEASUREMENTS: Full disk
QUALITY: generally good
DATA FORMAT AVAILABLE: Prints / Digitized (tape)
to World Data Centers

INVESTIGATORS: Bruce Gillespie, J. Harvey, and W. C. Livingston
Kitt Peak National Observatory
P.O. Box 26732
950 North Cherry Avenue
Tucson, Arizona USA 85726

TABLE 1.1

FULL DISK SOLAR OBSERVATIONS

Date	1.1.1	1.1.2	1.1.3	1.1.4			1.1.5	1.1.6
	TEL AVIV H α 1/3 Disk UT	LOCKHEED Ca II 8542Å UT	BIG BEAR H α UT	H α UT	Ca ⁺ K UT	CN UT	KITT PEAK Magnetograms Fe I 5233Å MST (115° WMT)	KITT PEAK He 10830Å MST (115° WMT)
1973								
Mar 28							0840 #	
29							1149 #	
30								
Apr 1							1030 W #	
2							1126 W #	
3							1013 W #	
4							1104 W #	
5							0833 W \$ #	
6							1021	
7								
8								
9							??	C
10								
11								
12								
13								
14								
15								
16								
17								
18								
19								
20								
21							1423 P	
22							0936 G ##	
23							0845 B %	
24				?? P			0848	
25								
26							1201	
27					?? P		0846	
28					1630F			
29								
30								
May 1							1413	
2					2110FP		0911	

See page 19 for Footnotes.

TABLE 1.1 (Continued)

FULL DISK SOLAR OBSERVATIONS

Date	1.1.1	1.1.2	1.1.3	1.1.4			1.1.5	1.1.6
	TEL AVIV H α 1/3 Disk UT	LOCKHEED Ca II 8542 \AA UT	BIG BEAR H α UT	KITT PEAK			KITT PEAK Magnetograms	KITT PEAK He 10830 \AA MST (115 $^\circ$ WMT)
				H α	Ca $^+$ K	CN		
				UT	UT	UT		
1973								
May								
3				?? P	2230P	?? P	1012 C	
4							1300 W	
5								
6				?? P	?? P	?? P	0815	
7				1630P	~1900P	~2100P	0910	
8				2230FP	~1600PF	~1600FP	1047	
9				1551P	?? P	?? P	1042	
10				1640FP	1625FP	1610FP	1131	
				1708FP			1612	
11				1450F	1541F	1635F	0918	
12					1640FP	1625FP	1434	
13				?? F			0745	
14				1601FP	1613FP	~1630FP	0916	
15				~1630FP	~1600FP	~1705FP	1045	
16				1550P	1645P		0839	
17				1750F	1730F	1705F	0811	
18				~1600FG	1550FG	1556FG	0716	
19				1705F	1730F		??	
20				2147FV	2123FV	2133FV	1018	
							0954	
							1014 \$	
							1121	
21				1703FG	1625FG	1550FG	0940	
22					1645FG			
23					1548G	1515G	0915	
24					1459F	1523F		
25					1631G	1616G	1310	
					1542FG	1526FG	1038 C	
26								
27				1531F	1602F	1614F	0835	
					1330FP	1950FP	1021	
28					1513F	?? FP		
29				1449P	1842P	1501F	0941	
30				0720-1340	1553FP	1914P	1148 \$	
				0655-1310		1531FP	1045	
31				0700-1525		1004	1004	
June								
1				1400-0126	1403FP	2010FP	0848 *	
2				1338-0105	1732F	1643F	0745	
3				1318-0231			1430	

See page 19 for Footnotes.

TABLE 1.1 (Continued)

FULL DISK SOLAR OBSERVATIONS

Date	1.1.1.1 TEL AVIV H α 1/3 Disk UT		1.1.2 LOCKHEED Ca II 8542Å UT		1.1.3 BIG BEAR H α UT		1.1.4 KITTE PEAK			1.1.5 KITTE PEAK Magnetograms Fe I 5233Å MST (115° WMT)		1.1.6 KITTE PEAK He 10830Å MST (115 WMT)	
	UT		UT		UT		H α UT	Ca+ K UT	CN UT	MST (115° WMT)		MST (115 WMT)	
1973													
June 4	0620-1520				1313-0140		1459P	1427P	1444P	1254 1217 C			
5	0605-1560				1334-1900								
6	0545-1520				1514-2102		1433F	1457F	1508F	1515 C			
7	0645-1300				1437-0245		1705P	1625P	1645P	0932 \$			
8	0810-1530				1319-1908		2138FP	2111FP	2126FP	1200			
9	0613-1500				1351-0230					1240			
10	0645-1505				1318-0159					1145			
11	0558-1226				1816-0215		1727FP	2145FP	1847FP	0954 PC			
12	0650-0925				1339-2100				2127FP	1503 G			
13	0640-1340				1525-2225								
14	0645-1500				1400-2042		1506FG	1426FG	1442FG	0723			
15	0705-1330						1435PV	1626PV	1550PV	0807			
16	0525-1515				1325-1912					0919			
17	0520-1515				1315-0230					1031			
18	0640-0800				1315-0240					0855			
19	0705-1505				1332-0247					0845			
20	0727-1345				1335-0248				2110FPV	0849			
21	0700-1500				1301-0229		2145P	1820P		1013			
22	0641-1500				1315-0047		1620FPV 1630FPV	2030FPV 1820FPV		0936 W			
23					1423-0203					0959 W			
24	0719-1500				1333-0226			1752F		0815 W			
25	0644-1503				1316-0230			1800F 1615FP	1645FP	0908			
26	0730-1410				1410-0230			1630G	1645G	0936			
27	0713-1525				1308-0218					1131			
28	0709-1445				1303-0220		1655P	1630P		0904			
29	0615-1145				1344-0250			1630P	1700P	0947			
30					1307-0223					0820			
July 1	0710-1433				1330-0235					1558			
2	0737-1445				1311-0215					0956C			
3	0707-1407				1315-0218					1101			
4					1610-0140		1705FP	1630FP 1600FP	1710FP 1650FP	0724 0940		0724 0940 1029 BC 0954 1053	

See page 19 for Footnotes.

TABLE 1.1 (Continued)
FULL DISK SOLAR OBSERVATIONS

Date	1.1.1	1.1.2	1.1.3	1.1.4			1.1.5	1.1.6
	TEL AVIV H α 1/3 Disk UT	LOCKHEED Ca II 8542 \AA UT	BIG BEAR H α UT	H α UT	Ca ⁺ K UT	CN UT	KITT PEAK Magnetograms Fe I 5233 \AA MST (115 $^{\circ}$ WMT)	KITT PEAK He 10830 \AA MST (115 $^{\circ}$ WMT)
1973								
July 5	0808-1504		1426-0222		1610PV	1639PV	0926	
6	0704-1158		1402-0223		1615FP	1600FP	0828 \$ 0919 C	
7					?? P		0732 \$	
8	0805-1343		1330-0050				0752 \$ 0849 P	
9	0741-1445		1312-0200	1630F	1545F	1600F	0839 \$ 1047 \$	
10	0711-1455		1324-0217				1534	
11	0713-1520		1334-0218				1328 C 1429 C	
12	0725-1508		1309-0215		?? PC ?? PC		0926 PC	
13	0746-1202		1347-0100		?? PCV		0757 C	
14			1330-0141		?? PCV ?? VPC		1301 VP \$	
15	0709-1443		1327-0212					
16	0710-1340		1410-0101				0756 0856	
17	0719-1444		1352-0235				0646	
18	0711-1451		1331-0230				0744	
19	0631-1453		1606-0234				0655	
20	0647-0800		1321-0032				0749	
21			1325-0212				0803	
22	0713-1418		1340-0034		?? FP ?? FP		0804	
23	0755-1316		1329-0047		1630P	1645P	0935	
24	0748-1345		1345-0204	1745P	1645P	1550P	0728	
25	0722-1500		1343-0215	1555F	1635F	1600P 1640F	0828	
26	0756-1452		1312-0057	?? FP	1600FP	1615FP	0811	
27	0749-1145		1345-0144				1339	
28			1512-2101				1247 C 1423 \$	
29	0710-1343		1321-0212				0920 C	
30	0729-1309		1322-0130				0808	
31	0809-1430				1720P-			
Aug 1	0734-1334				1645F 1650F		1027 C \$	

See page 19 for Footnotes.

TABLE 1.1 (Continued)

FULL DISK SOLAR OBSERVATIONS

Date	1.1.1 TEL AVIV H α		1.1.2 LOCKHEED Ca II 8542Å		1.1.3 BIG BEAR H α		1.1.4 KITTS PEAK (Note: From Aug. 11, 1973 on, 900 x 1200 arc sec area.)			1.1.5 KITTS PEAK Magnetograms		1.1.6 KITTS PEAK	
	UT	H α	UT	Ca II 8542Å	UT	H α	H α	Ca ⁺ K	UT	Fe I 5233Å	MST (115° WMT)	He 10830Å	MST (115° WMT)
1973													
Aug 2	0736-1240				1315-2038		1625FP	1530FP	1540FP	0723			
3	0735-1113						1630F	1735F		0715 C			
4								1800F		0820			
5	0746-1439							1610FG		0755 C			
6	0701-1555							1645FP	2115FP	0854			
7	0814-1412							1600FG	1620FG	0732			
8	0744-1500		2025 -2421+G✓					1640F	1620F	0732			
9	0733-1323		1830±-2230 G				1655FG	1550FG	1610FG	0732			
10	0731-1213		1632±-1950±F					1655F	1610F	0906			
11			1710±-2155±F					~2300GE(E)		0810			
12	0737-1416		1701±-2013±PF					~2300GE(W)		1140 \$			
13	0741-1448									0830 C			
14	0741-1405							1500GE(W)		0853			
15	0749-1338		2026 -2257 G					1615FG(W)		1014			
16	0721-1445									0735 ##			
17	0740-1106		1814 -1910 F							0852			
18			1640 -1830 F					1740PF(E)		~0800 ##			
19	0755-1328		2102 -2200 F					1715PF(E)		0852			
20	0745-1334		1642 -1845±G					1503VP(E)		0853			
21	0748-1328									0955			
22	0745-1503						2110FG(C)	1715FG(C)		0720			
23	0717-1515		1755 -2150 F				?? FG(C)	1745FG(C)		0739			
24	0741-1133		1742 -2005 G					1745P(E)		1047 \$ %			
25			1642 -1900 FG					1745P(E)		1510 C			
26	0746-1103							1720FG(E)		0731			
27	0742-1455									0802 \$			
28	0736-1435		1631 -1750 F				1426FG(W)	1542FG(E)		1430 W			
29	0747-1432		2125 -2401 F					1715P(E)	2035P(E)	0900			
30	0730-1359		1549 -1940 F					1655FP(C)	1610FP(C)	0832			
			2035 -2137 P					1605F(E)	1640F(E)	0821			
			1709 -2350 G					1620F(E)		0901 ##			
			1607 -2418 G					1635F(E)		0850			

See page 19 for Footnotes.

TABLE 1.1 (Continued)

FULL DISK SOLAR OBSERVATIONS

Date	1.1.1 TEL AVIV H α 1/3 Disk UT		1.1.2 LOCKHEED Ca II 8542 \AA UT		1.1.3 BIG BEAR H α UT		1.1.4 KITT PEAK (Note: From Aug. 11, 1973 on, 900 x 1200 arc sec area.) H α CN UT Ca ⁺ K UT			1.1.5 KITT PEAK Magnetograms Fe I 5233 \AA MST (115° WMT)		1.1.6 KITT PEAK He 10830 \AA MST (115° WMT)	
	UT	UT	UT	UT	UT	UT	UT	UT	UT	UT	UT	UT	UT
1973													
Aug 31	0738-1139	1950 -2342 F						\sim 1655FP(3W) \sim 1655FP(2E)	\sim 1540FP(3E)		0739		
Sept 1													
2	0804-1401	1700 -1950 F 2124 -2200 F									0749		
3	0759-1317	1620 -1710 F									0700		
4	0746-1315	1731 -2210 F									0902		
5	0752-1415	2101 -2437 F 1808 -2332 G							1615FV(c)		0819		
6	0819-1345	1610 -1841 F									0924		
7	0747-1020	1920 -2307 F											
8		1645 -2145±F											
9	0820-1310	1709 -2100 F											
10	0801-1515	1737 -2151 F 1840 -2210 F											
11	0659-1507												
12	0716-1304	1550 -2257 F✓											
13		2035 -2224 F											
14	0756-1118	1850 -2145 F											
15		2138 -2220 F											
16	0831-1500	1945 -2145 F											
17	0805-1202	1648 -1840 F											
18	0746-1448	1857 -2130 F											
19	0723-1249												
20	0808-1447												
21	0742-1123	1642 -1834 F											
22		1557-2230											
23	0753-1440	1435-2017											
24	0736-1453	1606-2333											
25	0714-1450	1430-1646											
26													
27													
28													
29													
30													

See page 19 for Footnotes.

TABLE 1.1 (Continued)

FULL DISK SOLAR OBSERVATIONS

Date	1.1.1 TEL AVIV H α 1/3 Disk UT		1.1.2 LOCKHEED Ca II 8542 \AA UT		1.1.3 BIG BEAR H α UT		1.1.4 KITT PEAK (Note: From Aug. 11, 1973 on, 900 x 1200 arc sec area.) H α UT Ca+K UT CN UT			1.1.5 KITT PEAK Magnetograms Fe I 5233 \AA MST (115 $^{\circ}$ WMT)		1.1.6 KITT PEAK He 10830 \AA MST (115 $^{\circ}$ WMT)	
	1973												
Oct 1							1625FG(c)	1605FG(c)	1655FG(c)	0841 \$ m			
2										1156 m			
3										1647 \$ m			
4								2118F(c)	2200F(c)	1145 C m			
5										0741 m			
										1102 G W m			
6										1106 W			
7										1028 \$ W			
8										1130 P \$			
9													
10										0809VP m			
11													
12										1430 ** #			
13										1030 ** #			
14										0955 ** #			
15										0759 ** #			
16													
17								1625FP(W)	1645FP(W)	0826 ** #			
18								1620FP(W)	1600FP(W)	1415 ** #			
19								1655P (W)		1445 ** #			
20								1730P (W)	1550FP(E)	0930 ** #			
								~1645FP		0904 #			
21													
22										0917 ** #			
23								1610G (E)	2215F (E)	0858 ** #			
24								1600FG(E)	1625FG(E)	1005 **			
25								2040P (E)	2055P (E)	0930 ##			
								1830F (c)	1800F (c)	1540			
26										1310 **			
27								1610FV(c)	1625FV(c)	1655 ** \$			
28										1533 **			
										0815 ** \$ %			
29										0940 ** \$ %			
30										1008 **			
31								1855P (W)	1610FV(W)	1015 W **			
								1625FV(W)					
Nov 1													
2													
3													
4										1059 ## m			

See page 19 for Footnotes.

TABLE 1.1 (Continued)

FULL DISK SOLAR OBSERVATIONS

Date	1.1.1.1	1.1.1.2	1.1.1.3	1.1.1.4		1.1.5	1.1.6
	TEL AVIV H α 1/3 Disk UT	LOCKHEED Ca II 8542 \AA UT	BIG BEAR H α UT	(Note: From Aug. 11, 1973 on, 900 x 1200 arc sec area.) H α UT	Ca ⁺ K UT	KITT PEAK Magnetograms Fe I 5233 \AA MST (115° WMT)	KITT PEAK He 10830 \AA MST (115° WMT)
1973							
Nov	5					0719 m	
6							
7							
8							
9							
10				1830VP(E)	1625FP(E)	1258 **	
11						0952 **	
12							
13							
14				~1630F (E) 1715FP(E)	1810FP(E)	1629 ** VP \$ ~1000G **	
15							
16							
17						0920 m	
18	0718-1300					0926 m	
19	1110-1300					1010 m	
20	0701-1045			~1845VP(E)	~1800VP(W)	1013 P m	
21			1919-2111			0824 m	
22						1001 NP	
23			2219-0000			1106 SP \$	
24							
25	0737-1307		1615-2044			1132 m	
26							
27			2137-0006			0916	
28			1641-0010			0842 P	
29	1100-1300		1610-0008	1845F (W) 1645FG(W)	~1800FG(c) 1630F (W) 1835FG(W)	0903	
30	0739-1052				1805F (W)	0814 \$ 0915 C	
Dec							
1						1144	
2			1539-0010			1048 P	
3	0748-1318		1627-2158	2025VP(W)	1725VP(W)	1407 NP \$	
4	0850-1410			1735P (W)	1815P (W) 1810F (E)	0841	
5	0749-1314		1549-2355			1546 PC \$ 1011 SP	
6			1545-2007			1116 NP 0822 % 0906 C	
						0856	
						1024 NP	
						1131 SP \$	

See page 19 for Footnotes.

TABLE 1.1 (Continued)

FULL DISK SOLAR OBSERVATIONS

Date	1.1.1 TEL AVIV H α 1/3 Disk UT	1.1.2 LOCKHEED Ca II 8542 \AA UT	1.1.3 BIG BEAR H α UT	1.1.4 KITT PEAK (Note: From Aug. 11, 1973 on, 900 x 1200 arc sec area.)		1.1.5 KITT PEAK Magnetograms Fe I 5233 \AA MST (115 $^{\circ}$ WMT)	1.1.6 KITT PEAK He 10830 \AA MST (115 $^{\circ}$ WMT)
				H α UT	Ca + K UT		
1973							
Dec 7			1938-0015	\sim 1730F (E)	\sim 1625P (E)	0910	
8			1549-0004			0837 C m	
9			1540-0017			1155 m	
10	0758-1140		1547-0017	2130FP(E)	1640FP(E)	0948 \$ m	
11			1630-1801			1130 m	
12			1545-2158			1054 C m	
13	0716-0851		1545-2339	1830FP(E)	1605FP(c)	1257 C m	
14	0716-1101		1605-0025	1845FP(W)		1600 \$	
15			1555-2220	?? P (c)		1630 \$	
16			1533-0010				
17			1558-1747			0935 GC m	
18			1600-2343	1750F (E)	2130P (E)	0835 MG W m	
19	0740-1255		1627-2328	\sim 1600P (E)	1655F (E)	1035 G m	
20	0853-1309		1610-2305			0835 G m	
21	0747-1143		1530-2146			0907 VG m	
22			1541-2300			1332 W m	
23	0828-1226		1540-2251			1106 P m	
24			1540-2115			1255 m	
25							
26			1551-0002			0939 C m	
27			1924-2047			0902 W m	
28						0902 VG C m	
29						0901 C m	
30			1600-0013			0950 C m	
31						0857 C \$ m	
1974						?? %	
Jan 1						0924 W m	
2			1630-0028			1428 FC \$ m	
3						1328 FC m	
4							
5							
6						1304 C m	
7							
8							

See page 19 for Footnotes.

TABLE 1.1 (Continued)

FULL DISK SOLAR OBSERVATIONS

Date	1.1.1 TEL AVIV H α 1/3 Disk UT		1.1.2 LOCKHEED Ca II 8542 \AA UT		1.1.3 BIG BEAR H α UT		1.1.4 KITT PEAK (Note: From Aug. 11, 1973 on, 900 x 1200 arc sec area.) H α Ca ⁺ K CN UT UT			1.1.5 KITT PEAK Magnetograms Fe I 5233 \AA MST (115 $^{\circ}$ WMT)		1.1.6 KITT PEAK He 10830 \AA MST (115 $^{\circ}$ WMT)	
	1974												
Jan 9													
10													
11													
12													
13													
14													
15													
16													
17													
18													
19													
20													
21													
22													
23													
24													
25													
26													
27													
28													
29													
30													
31													
Feb 1													
2													
3													
4													

See page 19 for Footnotes.

TABLE 1.1 (Continued)

FULL DISK SOLAR OBSERVATIONS

Date	1.1.1	1.1.2	1.1.3	1.1.4		1.1.5	1.1.6
	TEL AVIV H α 1/3 Disk UT	LOCKHEED Ca II 8542 \AA UT	BIG BEAR H α UT	(Note: From Aug. 11, 1973 on, 900 x 1200 arc sec area.) H α UT	KITT PEAK Ca ⁺ K UT	KITT PEAK Magnetograms Fe I 5233 \AA MST (115 $^{\circ}$ WMT)	KITT PEAK He 10830 \AA MST (115 $^{\circ}$ WMT)
1974							
Feb 5			1541-0011			0935 \$ m 1510 %%	1350
6			1550-2350			1130 %% 1310 %%	1425 1015 1100 1257
7			1541-0030			1015 %% 1121 PC m 1141 m	
8						1424 \$ m 0926 m 1033 m	
9					1605P (C) 1605F (W) 1615F (E)		
10							
11							
12							
13							
14							
15							
16							
17							
18							
19							
20							
21							
22							
23							
24							
25					1615F (W) 1625F (E)		
26							
27					1818FP(E) 1555FG(C) 1610FG(E) 1610F(E) 1625F(W)	0942G m	
28							
Mar 1							
2							
3							
4							
5						1645 %%	
6							
7						1159PC # 0838 W m	

See page 19 for Footnotes.

TABLE 1.1 (Continued)
FULL DISK SOLAR OBSERVATIONS

Date	1.1.1.1 TEL AVIV H α 1/3 Disk UT		1.1.1.2 LOCKHEED Ca II 8542 \AA UT		1.1.1.3 BIG BEAR H α UT		1.1.1.4 KITT PEAK (Note: From Aug. 11, 1973 on, 900 x 1200 arc sec. area.) H α Ca ⁺ K CN UT UT		1.1.1.5 KITT PEAK Magnetograms Fe I 5233 \AA MST (115° WMT)		1.1.1.6 KITT PEAK He 10830 \AA MST (115° WMT)	
	1974											
Mar 8												
9												
10									1409 P m			
11										0726 P m		
12												
13												
14												
15												

Footnotes:

1.1.1.2 $\sqrt{\quad}$ = 30 sec rate.

1.1.1.4

- (C) = Center of the sun.
- (E) = East scan.
- (W) = West scan.
- (N) = North scan.
- (S) = South scan.

1.1.1.5

- * = New scale on original film used hereafter. (June 1, 1973)
- ** = Mg 5173 \AA .
- \$ = Equipment failure, some problems in data.
- # = Polarity reversed.
- ## = Tape only.
- % = Negative only.
- %% = Fe I 8688 \AA , 512 channel vacuum telescope.
- m = 40 channel main telescope.
- ∞ = Best full disk magnetogram ever taken. (Feb. 2, 1974)
- NP = North Pole.
- SP = South Pole.

- Seeing:
- B = Rad image.
 - C = Clouds.
 - F = Fair.
 - FG = Fair to Good.
 - FP = Fair to Poor.
 - FV = Fair, Variable.
 - G = Good.
 - GE = Good to Excellent.
 - M = Mediocre.
 - MG = Mediocre to Good.
 - P = Poor.
 - PF = Poor to Fair.
 - PV = Poor, Variable.
 - V = Variable.
 - VP = Very Poor.
 - W = Wind shake.

CATEGORY 1.2) FULL DISK SOLAR OBSERVATIONS (Cont'd.)
Stations listed by Longitude

1.2.1 STATION: Lockheed Solar Observatory N34 E242
PROGRAM: Ground-based H-alpha full disk filtergrams (6563 Å)

OBSERVING TIMES AND RATES: 15 sec photos unless otherwise noted in Table 1 (see Table 1 for observing times)

FILM TYPE: SO 392

IMAGE SCALE OF ORIGINAL: Image diameter about 16 mm

QUALITY: See Table 1

DATA FORMAT AVAILABLE: Duplicate negatives / Prints
Direct scientist-to-scientist

JOPs: 2, 3, 4, 5, 6

INVESTIGATOR: Mr. H. Ramsey
Lockheed-California Company
Solar Physics, Bldg. 243, Pl. 2
Burbank, California USA 91503

1.2.2 STATION: Sacramento Peak Observatory N33 E254
PROGRAM: Ground-based full disk spectroheliograms at He I D₃ (5875 Å) ± 0 Å;
H-alpha (6563 Å) - 4.31 Å, ± 0 Å, + 0.5 Å; Ca K (3934 Å) ± 0 Å, + 0.38 Å

OBSERVING TIMES AND RATES: see Table 1

MEASUREMENTS: Scan 1.2 solar diameters

SPECTRAL BANDPASS IN Å: H-alpha - 4.31 Å (0.025 Å)

H-alpha ± 0 Å (0.098 Å)

H-alpha + 0.5 Å (0.068 Å)

Ca K ± 0 Å (0.514 Å)

Ca K + 0.38 Å (0.214 Å)

He I D₃ ± 0 Å (0.18 Å in the D₃, H-alpha - 4.31 Å,

Ca K and D₃, H-alpha, Ca K runs;

0.314 Å in the D₃, H-alpha, Ca K + 0.38 Å runs)

FILM TYPE: SO 392, 2568, Linograph shellburst = all in D19 68°F

IMAGE SCALE OF ORIGINAL: 4" solar image

QUALITY: see Table 1

DATA FORMAT AVAILABLE: Duplicate negatives / Prints

JOPs: 6, occasionally 1, 11

INVESTIGATOR: Dr. George Simon, Dr. Jacques Beckers
Sacramento Peak Observatory
Air Force Cambridge Research Laboratories
Sunspot, New Mexico USA 88349

TABLE 1.2
FULL DISK SOLAR OBSERVATIONS

1.2.1

1.2.2

LOCKHEED Full Disk Filtergrams H α (6563 Å) Date 1973 Time (UT) Rate			SAC PEAK Full Disk Spectroheliograms 1.2 solar diameters at He I D $_3$ (5875 Å), H α (6563 Å) and Ca K (3934 Å)							
			D $_3$, H α -4.31 Å and Ca K		H α , D $_3$ and Ca K + 0.38 Å		H α + 0.5 Å		D $_3$, H α and Ca K	
			Scan No.	Time (UT)	Scan No.	Time (UT)	Scan No.	Time (UT)	Scan No.	Time (UT)
May 29			8684	1329 F	8685	1333 F	8686	1338 F		
30			8687	1442 P	8688	1446 P	8689	1451 P		
31			8693	1445 G	8694	1452 G	8695	1518 G		
			8699	2037 VP	8700	2052 VP				
June 1										
2			8710	1337 F	8711	1341 F	8712	1347 F	8719-8721	1639-1651 FP β
									8722-8724	1700-1708 FP β
									8725-8727	1719-1728 FP β
3			8734	1421 F	8735	1430 F	8736	1435 F		
4			8746	1344 F	8747	1349 F	8748	1354 F	8749-8751	1901-1907 FP \checkmark
									8752-8754	2008-2014 FP \checkmark
									8755-8760	2144-2207 FP \checkmark
5			8771	1438 P	8772	1441 P	8773	1449 P		
			8774	1913 FP	8777	1931 FP	8776	1925 FP		
			8778	1937 FP	8779	1941 FP	8780	1948 FP		
6			8791	1418 F	8792	1422 F	8793	1428 F		
7			8794	2011	8795	2014	8796	2018		
8			8811	1405 P	8812	1411 P	8813	1454 P		
9			8817	1348 G	8818	1353 G	8819	1359 G		
10			8827	1313	8828	1317	8829	1335		
			8830	1339	8835	1607 F	8836	1614 F		
			8834	1604 F	8839	2101 F*	8840	2104 F		
			8838	2057 F	8842	2205 P*	8843	2213 P		
			8841	2202 P						
11			8851	1417 G	8852	1421 G	8853	1427 G		
			8854	1809 P	8855	1812 P	8856	1818 P		
			8857	2113 P	8858	2115 P	8859	2121 P		
12			8860	0022	8861	0024	8862	0028		
13			8872	1413 VP	8873	1931 VP	8876	2028 VP		
			8874	2016 VP	8875	2020 VP				
14			8880	1330 FG	8881	1337 FG	8882	1343 FG**		
15			8889	1341 F	8890	1346 F	8891	1353 F		
			8892	1419 VP	8893	1422 VP	8894	1427 VP		
16	1654-2425 F		8899	1334	8900	1337	8901	1343		
			8905	1425	8906	1430	8907	1453		
			8908	1557 FP	8909	1559 FP	8910	1604 FP		
			8911	1802 P	8912	1804 P	8913	1810 P		
			8914	2115 FP	8915	2118 FP	8916	2124 FP		
17	1505-1820 F		8925	1401 G	8926	1405 G	8927	1411 G		
			8928	1615 P	8929	1618 P	8930	1624 P \dagger		
			8931	2045 P	8932	2049 P	8933	2055 P		
18	1525-1615		8941	1412 FG	8942	1417 FG	8943	1422 FG		
			8944	1426 FG						
19	1539-1630-30s									
20	1450-2531 PF-60s		8957	1349 P	8958	1355 P	8959	1403 P**		
			8963	2202 P	8964	2209P	8965	2215 P		
21	1522-2248 G-30s		8966	1303 F	8967	1308 F	8968	1314 F		
	2249-2527 G									
22	1546-2215 FG-30s		8982	1403 G	8983	1407 G	8984	1414 G \dagger		
							8985	1418 G \dagger		
23	1528-2255 FP-30s		8990	1325	8991	1329	8992	1335		
	2335-2627 B		8996	1950 P	8997	1954 P	8998	1959 P		
24	1512-2547 IP-30s		9006	1421 GF	9007	1425 GF	9008	1430 GF		
			9009	2327 P	9010	2329 P	9011	2335 P		
25	Random		9015	1347 G	9016	1354 G	9017	1401 G		

See page 31 for Footnotes.

TABLE 1.2 (continued)

FULL DISK SOLAR OBSERVATORIES

1.2.1

1.2.2

LOCKHEED Full Disk Filtergrams Date 1973 H α (6563 Å) Time (UT) Rate			SAC PEAK Full Disk Spectroheliograms 1.2 solar diameters at He I D $_3$ (5875 Å), H α (6563 Å) and Ca K (3934 Å)							
			D $_3$, H α -4.31 Å and Ca K		H α , D $_3$ and Ca K + 0.38 Å		H α + 0.5 Å		D $_3$, H α and Ca K	
			Scan No.	Time (UT)	Scan No.	Time (UT)	Scan No.	Time (UT)	Scan No.	Time (UT)
June 26	Random	9021	1324 G	9022	1330 G	9023	1337 G			
27	"	9033 A	1414 F	9034	1422 F	9035	1435 F			
		9033 B	1430 F	9040	2341 FP	9041	2347 FP			
28	"	9039	2302 FP							
		9049	1642 P	9050	1652 P	9051	1703 P			
29	"	9052	2127 P	9053	2131 P	9054	2137 P			
		9062	1411	9063	1415	9064	1421			
30	"	9069	2053 P	9070	2057 P					
		9075	1427 F	9076	1430 F	9077	1437 F			
		9078	1441 F	9080	1642 F	9081	1649 F			
		9079	1639 F							
July 1	"									
2		9094	1435 G	9095	1440 G	9096	1447 G			
3		9103	1333 G	9104	1338 G	9105	1345 G			
4		9113	1323	9115	1331	9116	1337			
		9114	1327							
5		9124	1327	9125	1331	9126	1339			
6		9137	1348 FP	9138	1352 FP	9139	1358 FP			
7		9140	2059							
8		9144	1400 F	9145	1406 F	9146	1415 F			
9										
10										
11		9159	1607	9160	1610	9161	1618			
		9162	2322	9163	2327	9164	2331			
12		9171	1358 F	9172	1402 F	9173	1408 F			
13		9177	1944 P	9178	1956 P	9176	2002 P			
		9177	2002 P							

No data July 14 through August 1, 1973. Table continued on next page.

See page 31 for Footnotes.

TABLE 1.2 (continued)

FULL DISK SOLAR OBSERVATORIES

1.2.1			1.2.2							
LOCKHEED Full Disk Filtergrams Date 1973 H α (6563 Å) Time (UT) Rate			SAC PEAK Full Disk Spectroheliograms 1.2 solar diameters at He I D $_3$ (5875 Å), H α (6563 Å) and Ca K (3934 Å)							
			D $_3$, H α -4.31 Å and Ca K		H α , D $_3$ and Ca K + 0.38 Å		H α + 0.5 Å		D $_3$, H α and Ca K	
			Scan No.	Time (UT)	Scan No.	Time (UT)	Scan No.	Time (UT)	Scan No.	Time (UT)
Aug 2			9278	1509 P✓	9282	2308 *F✓	9277	1355 F+	9275	1341 F+
			9281	2305 F✓			9280	1518 P✓	9276	1348 F+
3			9288	1409 F	9289	1353 F	9283	2311 F✓		
			9291	1623 P✓	9293	2030 *G✓	9290	1359 F		
			9292	2019 G✓	9296	2317 *F+✓	9294	2039 G✓		
			9295	2315 F+✓			9297	2320 F+✓		
4			9301	1352 G	9302	1358 G	9303	1405 G		
5			9308	1326 G✓	9309	1330 G✓	9310	1336 G✓		
			9311	1847 F	9312	1850 F	9313	1857 F		
6			9314	0027 F	9315	0031 F	9316	0037 F		
			9321	1331 F	9322	1335 F	9323	1340 F		
7			9329	1336 P	9330	1340 P	9331	1345 P		
8			9337	1337 FG	9338	1340 FG	9339	1347 FG		
9			9340	0034 F	9341	0037 F	9342	0043 F		
			9346	1359 G	9347	1403 G	9348	1408 G		
10			9353	0034 G	9354	0039 G	9355	0045 G		
			9359	1442 F	9360	1607 F	9361	1645 F		
			9362	2151 FP#	9363	2157 FP#	9364	2202 FP#		
11			9368	1353 G	9369	1359 G	9370	1406 G		
			9374	2215 P#	9375	2322 P#	9376	2400 P#		
12				1324		1324		1324		
				1337 #		1337 #		1337 #		
			9387	1437 F	9388	1441 F	9389	1446 F		
				1707 P#		1707 P#		1707 P#		
			9393	2014 P	9394	2019 P		2240 P		
				2240 P		2240 P				
13			9401	1401 G	9402	1407 G	9403	1414 G		
			9404	1533 GF✓✓	9405	1537 *GF✓✓	9406	1540 GF✓✓		
			9407	1550 F✓✓	9408	1550 *F✓✓	9409	1550 F✓✓		
			9410	1611 F✓✓	9411	1611 *F✓✓	9412	1611 F✓✓		
			9413	1630 F✓✓	9414	1630 *F✓✓	9415	1630 F✓✓		
			9416	1807 P✓✓	9417	1807 *P✓✓	9418	1807 P✓✓		
			9419	1842 VP✓✓	9420	1842 *VP✓✓	9421	1842 VP✓✓		
			9423	1930 VP✓✓	9424	1930 *VP✓✓	9425	1930 VP✓✓		
			9425	2010 VP✓✓	9427	2040 *VP\$✓✓	9428	2040 VP✓✓		
			9426	2040 VP\$✓✓						
14			9432	1336 F	9433	1340 F	9434	1345 F		
15			9435	1713 P β	9436	1717 P β	9441	1737 P✓✓		
			9438	1726 P✓✓	9439	1729 *P✓✓	9444	1745 P✓✓		
			9442	1745 P✓✓	9443	1745 *P✓✓	9447	2015 P✓✓		
			9445	2015 P✓✓	9446	2015 *P✓✓	9450	2045 P✓✓		
			9448	2045 P✓✓	9449	2045 *P✓✓	9455	2115 P✓✓		
			9453	2115 P✓✓	9454	2115 *P✓✓				
16			9459	1331 F#	9460	1331 F#	9461	1331 F#		
			9462	1348 G	9463	1352 G	9464	1357 G		
17			9465	1315 P✓	9466	1319 *P✓	9467	1322 P✓		
			9468	1330 FP✓	9469	1330 *FP✓	9470	1330 FP✓		
			9474	1420 FP✓	9475	1420 *FP✓	9476	1420 FP✓		
			9477	1430 F	9478	1433 F	9479	1439 F		
			9480	1445 F✓	9481	1445 *F✓	9482	1445 F✓		
18			9483	1825 F	9484	1825 F	9485	1825 F		
			9488	1402 F	9489	1405 F	9490	1412 F		
			9492	1832 κ	9493	1834 * κ	9494	1837 κ		
			9495	1915 FP κ	9496	1915 *FP κ	9497	1915 FP κ		
			9498	2015 FP κ	9499	2015 *FP κ	9500	2015 FP κ		
			9501	2100 FP κ	9502	2100 *FP κ	9503	2100 FP κ		
			9504	2340 FP	9505	2340 FP	9506	2340 FP		
19			9510	1337	9511	1341	9512	1347		
			9513	1610 F β	9514	1613 *F β	9515	1617 F β		
			9516	1630 F β	9517	1630 *F β	9518	1630 F β		

See page 31 for Footnotes.

TABLE 1.2 (continued)
FULL DISK SOLAR OBSERVATORIES

1.2.1			1.2.2							
LOCKHEED Full Disk Filtergrams			SAC PEAK Full Disk Spectroheliograms 1.2 solar diameters at He I D ₃ (5875 Å), H α (6563 Å) and Ca K (3934 Å)							
Date	H α (6563 Å)	Rate	D ₃ , H α -4.31 Å and Ca K		H α , D ₃ and Ca K + 0.38 Å		H α + 0.5 Å		D ₃ , H α and Ca K	
1973	Time (UT)		Scan No.	Time (UT)	Scan No.	Time (UT)	Scan No.	Time (UT)	Scan No.	Time (UT)
Aug	20									
	21		9522	1457 F	9523	1507 F	9524	1514 F		
			9525	1526 FP✓	9526	1531 *FP✓	9527	1539 FP✓		
	22		9530	1351 FP	9531	1356 FP	9532	1403 FP		
			9533	1415 P✓	9534	1418 *P✓	9535	1422 P✓		
			9536	1435 F✓	9537	1435 *F✓	9538	1435 F✓		
			9539	1540 F✓	9540	1540 *F✓	9541	1540 F✓		
			9542	1610 F✓	9543	1610 *F✓	9544	1610 F✓		
			9545	1715 F-✓	9546	1715 *F-✓	9547	1715 F-✓		
			9548	1740 F-✓	9549	1740 F-✓	9550	1740 F-✓		
	23		9554	1340 G	9555	1344 G	9556	1350 G		
			9557	1815 P	9558	1815 P	9559	1815 P		
	24									
	25		9571	1350 P	9572	1354 P	9573	1359 P		
	26			0015 P		0015 P		0015 P		
			9580	1341	9581	1344	9582	1351		
			5883	1945 P	5884	1945 P	5885	1945 P		
			5888	2310 F-	5889	2310 F-	5890	2310 F-		
			9591	2355 F	9592	2355 F	9593	2355 F		
	27		9597	1404 FG	9598	1408 FG	9599	1413 FG		
	28									
	29									
	30		9604	2334 PC	9605	2339 P	9606	2344 P		
			9607	2349 P						
	31		9611	1921 PCB	9612	1925 PCB	9613	1932 PCB		
Sept	1		9617	1527 F	9618	1531 F	9619	1536 F		
	2		9620	0025 P	9621	0030 P	9622	0035 P		
			9626	1345 F	9627	1345 F	9628	1345 F		
			9629	1601 P	9630	1601 P	9631	1601 P		
	3		9632	2231 P	9633	2231 P	9634	2231 P		
			9635	0017 P	9636	0020 P	9637	0027 P		
			9640	1341 F	9641	1341 F	9642	1341 F		
	4		9643	1844 P	9644	1844 P	9645	1844 P		
			9646	0018 P	9647	0022 P	9648	0027 P		
			9652	1355 F	9653	1355 F	9654	1355 F		
			9655	2330 P	9656	2330 P	9657	2330 P		
	5		9658	2330 P						
			9662	1357 P	9663	1403 P	9664	1410 P		
			9665	1519 PF β	9666	1522 *PF β	9667	1527 PF β		
			9668	1540 P β	9669	1540 *P β	9670	1540 P β		
			9671	1610 P β	9672	1610 *P β	9673	1610 P β		
			9674	2000 F	9675	2000 F	9676	2000 F		
			9677	2200 F	9678	2200 F	9679	2200 F		
	6		9684	1413 P	9685	1418 P	9686	1424 P		
			9687	1520 P	9688	1520 P	9689	1520 P		
	7		9696	2315 F	9697	2319 F	9698	2324 F		
	8		9699	1344 G	9700	1349 G	9701	1357 G		
			9706	1450 G	9707	1450 G	9708	1450 G		
			9709	1935 F-	9710	1935 F-	9711	1935 F-		
	9		9714	1358 G	9715	1402 G	9716	1407 G		
	10		9717	1550 F	9718	1550 F	9719	1550 F		
	11		9720	1727 P β	9721	1740 *P β	9722	1748 P β		
			9725	1910 P β	9726	1910 *P β	9727	1910 P β		
			9728	2000 P	9729	2000 P	9730	2000 P		
			9731	2211 FP	9732	2215 FP	9733	2220 FP		

See page 31 for Footnotes.

TABLE 1.2 (continued)

FULL DISK SOLAR OBSERVATORIES

1.2.1

1.2.2

LOCKHEED Full Disk Filtergrams H α (6563 Å)			SAC PEAK Full Disk Spectroheliograms 1.2 solar diameters at He I D $_3$ (5875 Å), H α (6563 Å) and Ca K (3934 Å)										
			D $_3$, H α -4.31 Å and Ca K			H α , D $_3$ and Ca K + 0.38 Å		H α + 0.5 Å		D $_3$, H α and Ca K			
			Scan No.	Time (UT)		Scan No.	Time (UT)	Scan No.	Time (UT)	Scan No.	Time (UT)		
1973	Time (UT)	Rate											
Sept	12		9737	1347 F			9738	1350 F			9739	1356 F	
			9740	1815 P			9741	1815 P			9742	1815 P	
	13		9743	2136 P			9744	2136 P			9745	2136 P	
			9749	1354 F			9750	1401 F			9751	1407 F	
			9752	2040 FP			9753	2040 FP			9754	2040 FP	
			9755	2215 F			9756	2215 F			9757	2215 F	
	14	1908-2233 F-30s	9761	1357 F			9762	1400 F			9763	1407 F	
	15	2042-2428 F-30s	9768	1435 G			9769	1439 G			9770	1447 G	
			9771	1930 P			9772	1930 P			9773	1930 P	
			9774	2100 P			9775	2100 P			9776	2100 P	
	16	1705-2240*F-30s	9778	1729 P			9779	1747 P			9780	1755 P	
			9781	2140 P			9782	2140 P			9783	2140 P	
	17	1528-1730 F-30s	9784	1354 G			9785	1359 G			9786	1407 G	
			9790	1607 F β			9791	1610*F β			9792	1614 F β	
			9793	1635 F β			9794	1635*F β			9795	1635 F β	
			9796	1700 F β			9797	1700*F β			9798	1700 F β	
			9799	1750 P β			9800	1750*P β			9801	1750 P β	
			9802	1815 P β			9803	1815*P β			9804	1815 P β	
			9805	1840 P β			9806	1840*P β			9807	1840 P β	
			9808	2200 P			9809	2200 P			9810	2200 P	
	18	1549- ?? F-30s	9811	1721 P β			9812	1724*P β			9813	1727 P β	
			9816	1800 P β			9817	1800*P β			9818	1800 P β	
			9819	1840 P β			9820	1840*P β			9821	1840 P β	
			9822	1905 P β			9823	1905*P β			9824	1905 P β	
			9825	1930 P β			9826	1930*P β			9827	1930 P β	
	19	1608-2316 F-60s	9831	1503 F			9832	1507 F			9833	1515 F	
			9834	1810 F			9835	1810 F			9836	1810 F	
			9837	2100 P			9838	2100 P			9839	2100 P	
			9840	2245 P			9841	2245 P			9842	2245 P	
	20	1621-2308 F-60s	9846	1359 F			9847	1403 F			9848	1409 F	
			9849	1730 FG			9850	1730 FG			9851	1730 FG	
			9852	2205 F			9853	2205 F			9854	2205 F	
	21	1638-2334 F-60s	9858	1540 G β			9859	1542*G β			9860	1547 G β	
			9861	1555 P β			9862	1555*P β			9863	1555 P β	
			9864	1608 P			9865	1612 P			9869	1655 P β	
			9867	1655 P β			9868	1655*P β			9872	1710 P β	
			9870	1710 P β			9871	1710*P β			9875	1825 P	
			9873	1825 P			9874	1825 P			9878	2200 P	
			9876	2200 P			9877	2200 P					
	22		9881	1353 F			9882	1357 F			9883	1402 F	
			9884	1755 P			9885	1755 P			9886	1755 P	
	23	1602-1752 F-60s	9890	1412 F			9891	1417 F			9892	1422 F	
		1752-1836 P-15s											
		1836-2330VB-30s											
	24		9896	1359 F			9897	1403 F			9898	1408 F	
	25		9902	1532 PF			9904	1545 PF			9905	1551 PF	
			9903	1535 PF									
	26		9909	1600 F			9910	1603 F			9911	1608 F	
	27		9915	2315 P			9916	2321 P					
	28		9921	1359 GF			9922	1404 GF			9923	1409 GF	
	29	1558-0027 30s	9927	1353 F			9928	1357 F			9929	1402 F	
	30	1522-2240 30s	9933	1414 FP			9934	1418 FP			9935	1423 FP	
			9936	2330 P			9937	2330 P			9938	2330 P	
Oct	1	1726-0048 30s	9942	1351 F			9943	1355 F			9944	1400 F	
	2	2012-0039 60s	9948	1413 F			9949	1417 F			9950	1422 F	
	3	1534-0130 30s	9954	2052 VP			9955	2055 VP			9956	2101 VP	
	4	1453-2200 30s	9961	1421 P			9962	1425 P			9963	1431 P	
	5	1556-0016 30s											

See page 31 for Footnotes.

TABLE 1.2 (continued)

FULL DISK SOLAR OBSERVATIONS

1.2.1			1.2.2									
Date 1973	LOCKHEED Full Disk Filtergrams H α (6563 Å) Time (UT)	Rate	SAC PEAK Full Disk Spectroheliograms 1.2 solar diameters at He I D $_3$ (5875 Å), H α (6563 Å) and Ca K (3934 Å)									
			D $_3$, H α -4.31 Å and Ca K		H α , D $_3$ and Ca K + 0.38 Å		H α + 0.5 Å		D $_3$, H α and Ca K			
			Scan No.	Time (UT)	Scan No.	Time (UT)	Scan No.	Time (UT)	Scan No.	Time (UT)		
Oct 6												
7			9977	1521 FPN	9975	1512 FP	9976	1518 FP	9974	1509 FP**		
8			9981	1421 F	9982	1425 F	9983	1431 F				
			9992	2100	9993	2100	9994	2100				
9	1529-2345	30s	9998	1418 FP	9999	1422 FP	10000	1430 FP				
			10001	1650 ✓	10002	1653*✓	10003	1657				
			10006	1730 P✓	10007	1730*P✓	10008	1730 P				
			10009	1824 P✓	10010	1824*P✓	10011	1824 P✓				
			10012	1906 P✓	10013	1906*P✓	10014	1906 P✓				
			10015	1955 ✓	10016	1955*✓	10017	1955 ✓				
			10019	2034 FP✓	10020	2034*FP✓	10021	2034 FP✓				
			10022	2125 FP✓	10023	2125*FP✓	10024	2125 FP✓				
			10025	2206 ✓	10026	2206*✓	10027	2206 ✓				
			10028	2254 ✓	10029	2254*✓	10030	2254 ✓				
			10031	2334 F✓	10032	2334*F✓	10033	2334 F✓				
10	1606-2408	30s	10037	1424 P✓	10038	1427*P✓	10039	1434 P✓				
			10040	1516 P✓	10041	1516*P✓	10042	1516 P✓				
			10043	1600 P✓	10044	1600*P✓	10045	1600 P✓				
11	1526-2352	30s	10049	1359 F	10050	1403 F	10051	1408 F				
12	1533-0100	60s	10055	1425 F	10056	1429 F	10057	1435 F				
			10058	1744 P✓	10059	1747*P✓	10060	1750 P✓				
			10061	1830 P✓	10062	1830*P✓	10063	1830 P✓				
			10064	1913 P✓	10065	1913*P✓	10066	1913 P✓				
			10067	1959 P✓	10068	1959*P✓	10069	1959 P✓				
			10070	2130 P✓	10071	2130*P✓	10072	2130 P✓				
			10073	2220 P✓	10074	2220*P✓	10075	2220 P✓				
13	1618-2000	60s	10079	1437 F	10080	1441 F	10081	1448 F				
			10082	1552 F✓	10083	1557*F✓	10084	1601 F✓				
			10085	1719 FP✓	10086	1719*FP✓	10087	1719 FP✓				
			10088	1836 P✓	10089	1836*P✓	10090	1836 P✓				
			10091	2048 P✓	10092	2048*P✓	10093	2048 P✓				
			10094	2144 P✓	10095	2144*P✓	10096	2144 P✓				
			10097	2314 P✓	10098	2314*P✓	10099	2314 P✓				
14	1645-2320	60s	10103	1448 F✓	10104	1453 F✓	10105	1500 F✓				
			10106	1617 P✓	10107	1617 P✓	10108	1617 P✓				
15	1545-2340	30s	10109	1431 G	10110	1419 G	10111	1427 G				
			10115	2340 P	10116	2340 P	10117	2340 P				
16	1547-2243	60s	10123	1459 P	10124	1501P	10125	1508 P				
17	1525-2348	30s	10130	1436 G	10131	1440 G	10132	1445 G				
18	1829-0120	30s	10137	1425 F	10138	1429 F	10139	1434 F				
19	1610-0000	30s	10142	1541 F	10143	1546 F	10144	1552 F				
			10145	2320 P	10146	2320 P	10147	2320 P				
20	1630-2300	60s	10151	1453 FG	10152	1458 FG	10153	1505 FG				
			10154	2319 F	10155	2319 F	10156	2319 F				
21	1909-2242	30s	10160	1458	10161	1504	10162	1510				
			10163	1614 P✓	10164	1618*P✓	10164	1627 P✓				
			10165	1650 P✓	10166	1650*P✓	10167	1650 P✓				
			10168	1800 PF✓	10169	1800*PF✓	10170	1800 PF✓				
			10171	1830 PF✓	10172	1830*PF✓	10173	1830 PF✓				
			10174	1957 P✓	10175	1957*P✓	10176	1957 P✓				
			10177	2100 P✓	10178	2100*P✓	10179	2100 P✓				
			10180	2135 F-✓	10181	2135*F-✓	10182	2135 F-✓				
			10183	2227 F-✓	10184	2227*F-✓	10185	2227 F-✓				
			10186	2323 P	10187	2323 P	10188	2323 P				
			10192	1458 F	10193	1501 F	10194	1507 F				
			10195	1547 F✓	10196	1550*F✓	10197	1553 F✓				
			10198	1728 P✓	10199	1728*P✓	10200	1728 P✓				
			10201	1835 P✓	10202	1835*P✓	10203	1835 P✓				
			10204	1912 P✓	10205	1912*P✓	10206	1912 P✓				
22			10207	2014 P✓	10208	2014*P✓	10209	2014 P✓				

See page 31 for Footnotes.

TABLE 1.2 (continued)

FULL DISK SOLAR OBSERVATIONS

1.2.1

1.2.2

LOCKHEED Full Disk Filtergrams H α (6563 Å)			SAC PEAK Full Disk Spectroheliograms 1.2 solar diameters at He I D $_3$ (5875 Å), H α (6563 Å) and Ca K (3934 Å)							
			D $_3$, H α -4.31 Å and Ca K		H α , D $_3$ and Ca K + 0.38 Å		H α + 0.5 Å		D $_3$, H α and Ca K	
Date	H α (6563 Å) Time (UT)	Rate	Scan No.	Time (UT)	Scan No.	Time (UT)	Scan No.	Time (UT)	Scan No.	Time (UT)
Oct 22			10210	2044 P✓	10211	2044*P✓	10212	2044 P✓		
			10213	2142 P✓	10214	2142*P✓	10215	2142 P✓		
			10216	2217 P✓	10217	2217*P✓	10218	2217 P✓		
23			10222	1443 F	10223	1447 F	10224	1452 F		
			10225	1502 F✓	10226	1505*F✓	10227	1508 F✓		
			10228	1624 P✓	10229	1624*P✓	10230	1624 P✓		
			10231	1658 P✓	10232	1658*P✓	10233	1658 P✓		
			10234	1758 P✓	10235	1758*P✓	10236	1758 P✓		
			10237	1830 P✓	10238	1830*P✓	10239	1830 P✓		
			10240	1930 P✓	10241	1930*P✓	10242	1930 P✓		
			10243	2006 P✓	10244	2006*P✓	10245	2006 P✓		
			10246	2100 P✓	10247	2100*P✓	10248	2100 P✓		
			10249	2137 P✓	10250	2137*P✓	10251	2137 P✓		
			10252	2233 P✓	10253	2233*P✓	10254	2233 P✓		
24	1524-0025	30s	10257	1430 F	10258	1434 F	10259	1439 F		
25	1535-2225	30s	10260	1435 F	10261	1443 F	10262	1450 F		
26	1752-0331	30s	10267	1415 F	10268	1422 F	10269	1429 F		
27	1558-2328	30s	10273	1457 F	10274	1503 F	10275	1515 F		
			10277	1603 F ϕ	10278	1605 F ϕ	10283	1635 F ϕ		
			10281	1631 F ϕ	10282	1633 F ϕ				
28	1658-2403	G-30s	10287	1451 G	10288	1456 G	10289	1502 G		
29	1551-??	F-30s	10290R	1503 FG	10291	1450 FG	10292	1457 FG	10290	1444 FG**
			10295	1528 F✓	10296	1531*F✓	10297	1537 F✓		
			10298	1610 F✓	10299	1610*F✓	10300	1610 F✓		
			10301	1650 FP✓	10302	1650*FP✓	10303	1650 FP✓		
			10304	1743 P✓	10305	1743*P✓	10306	1743 P✓		
			10307	1910 P✓	10308	1910*P✓				
			10309	1939 P✓	10310	1939*P✓				
			10311	2020 P✓	10312	2020*P✓				
			10313	2203 P✓	10314	2203*P✓				
30	1716-2445	F-30s	10318	1451 F-	10319	1457 F-	10320	1506 F-		
31	1612-2408	F-30s	10324	1430 G	10325	1434 G	10326	1439 G		
Nov 1	1628-2218	VB-30s	10330	1436 FG	10331	1440 FG	10332	1445 FG		
2										
3			10336	2119 P	10337	2123 P	10338	2129 P		
4	1719-2331	F-60s								
5	1648-2440	F-60s	10346	1440 P	10347	1444 P	10348	1450 P		
6	1623-2355	F-60s	10352	1514' G	10353	1520 G	10354	1527 G		
7	1604-2252	F-60s	10358	1605 FG	10359	1610 FG	10360	1617 FG		
8	2059-2307	F-60s	10378	1616 FP	10379	1622 FP	10380	1628 FP		
9	1655-~2210	FB-60s	10396	1425 F+ β	10397	1429 F+ β	10398	1438 F+ β		
					10400	1523*F β			10399	1519 F \$\$ β
					10402	1610*F+ β			10401	1610 F+\$\$ β
					10404	1706*F- β			10403	1706 F-\$\$ β
					10406	1801*P β			10405	1801 P \$\$ β
					10408	1910*P β			10407	1910 P \$\$ β
					10410	2002*P β			10409	2002 P \$\$ β
					10412	2105*P β			10411	2105 P \$\$ β
					10414	2218*P β			10413	2218 P \$\$ β
					10416	2255*P β			10415	2255 P \$\$ β
10	1659-2355	FP-30s			10424	1501*F β			10423	1458 F \$\$ β
					10426	1601*F β			10425	1601 F \$\$ β
					10428	1657*F β			10427	1657 F \$\$ β
11	1805-2057	VB-30s	10432	1438 G	10433	1446 G	10434	1451 G	10435	1500 P \$\$ β
					10436	1503*P β			10437	1644 F \$\$ β
					10438	1644*F β			10439	1707 P \$\$ β
					10440	1707*P β			10441	1803 P \$\$ β
					10442	1803*P β			10443	1858 P \$\$ β
					10444	1858*P β			10445	1956 P \$\$ β

See page 31 for Footnotes.

TABLE 1.2 (continued)

FULL DISK SOLAR OBSERVATIONS

1.2.1

1.2.2

LOCKHEED Full Disk Filtergrams H α (6563 Å)			SAC PEAK Full Disk Spectroheliograms 1.2 solar diameters at He I D $_3$ (5875 Å), H α (6563 Å) and Ca K (3934 Å)							
Date 1973	Time (UT)	Rate	D $_3$, H α -4.31 Å and Ca K		H α , D $_3$ and Ca K + 0.38 Å		H α + 0.5 Å		D $_3$, H α and Ca K	
			Scan No.	Time (UT)	Scan No.	Time (UT)	Scan No.	Time (UT)	Scan No.	Time (UT)
Nov	11				10446	1956*P β			10447	2104 P \$\$\$ β
					10448	2104*P β			10449	2200 P \$\$\$ β
					10450	2200*P β			10451	2309 P \$\$\$ β
					10452	2309*P β				
	12	1922-2004 FB-60s	10456	1441 F	10457	1445 F	10458	1450 F		
	13		10462	1555 P	10463	1600 P	10464	1606 P		
	14									
	15	2231- ??	10465	1442 P	10466	1447 P	10467	1453 P		
			10472	1535 G	10473	1535 G	10474	1535 G		
	16		10478	1457 G	10479	1501 G	10480	1506 G		
	17		10484	1522 G	10485	1529 G	10486	1536 G		
	18									
	19	1648-2355 P-60s								
	20	1653-2400+F-60s								
	21	1640-1953 FP-60s	10499	1532 F	10500	1537 F	10501	1550 F		
	22		10513	1537 G	10514	1543 G	10515	1549 G		
	23									
	24	1642-1810 F-30s	10531	1539 G	10532	1547 G	10533	1558 G		
		1810-2026 FP-15s	10534	2011 P ϕ	10535	2013 P ϕ	10536	2017 P % δ ϕ		
	25	1639-2232 P-60s								
	26	1917-2354 F-30s								
	27	1624-2400 F-30s	10540	1512 P	10541	1516 P	10542	1522 P		
	28	1641-2400+F-30s	10546	1440 F+	10547	1444 F+	10548	1449 F+	10549	1752 P β
					10550	1755*P β			10551	1825 P β
					10552	1825*P β				
	29	1628-2223 P-60s	10556	1447 FP	10557	1438 FP	10558	1444 FP		
	30	1727-2355 F-60s	10562	1553 P	10563	1557 P	10564	1604 P		
Dec	1		10571	1542 G	10572	1549 G	10573	1556 G		
	2	1644-2345 F-15s	10576	1504 G	10577	1510 G	10578	1517 G		
	3	1703-1802 FB-30s								
		2101-2230 FB-30s								
	4		10582	1550 P	10583	1555 P	10584	1604 P		
	5	1704-2351 F-30s	10585	1446 G	10586	1451 G	10587	1457 G		
			10591	1655 P	10592	1655 P	10593	1655 P		
			10594	1750 F	10595	1750 F	10596	1750 F		
	6	1614-2345 F-30s	10600	1509 F	10601	1512 F	10602	1520 F		
			10603	1900 P	10604	1900 P	10605	1900 P		
	7	2150-2355 FP-30s	10609	1504 F	10610	1508 F	10611	1513 F	10612	2228 P β \checkmark
					10613	2232*P \checkmark			10614	2303 P β \checkmark
					10615	2307*P \checkmark				
	8	1623-2000±F-30s	10616	1923 FG	10617	1927 FG	10618	1932 FG		
		2155-2344 F-30s	10625	1537 F	10626	1541 F	10627	1549 F		
	9	1635-2340 F-30s	10628	1800 P	10629	1800 P	10630	1800 P		
			10631	1940 P	10632	1940 P	10633	1940 P		
			10634	2140 P	10635	2140 P	10636	2140 P		
			10637	2240 P	10638	2240 P	10639	2240 P		
	10	1623-1912 F-30s	10643	1507 F	10644	1509 F	10645	1514 F		
		1925-2345 F-30s	10646	1544 F	10647	1544 F	10648	1544 F		
			10649	1851 P	10650	1851 P	10651	1851 P		
	11		10655	1629 P	10656	1635 P	10657	1644 P		
			10658	2255 P \checkmark	10659	2255 P \checkmark	10660	2255 P \checkmark		
	12	1849-2054 F-30s	10664	1611 F	10665	1615 F	10666	1623 F		
		2140-2330 F-60s	10667	2220 FP	10668	2220 FP	10669	2220 FP		
	13		10673	1724 P	10674	1728 P	10675	1732 P		
	14	1643-2325 F-30s	10679	1618 P	10680	1623 P	10681	1632 P		
			10682	1734 P	10683	1734 P	10684	1734 P		
			10685	2010 VP	10686	2010 VP	10690	2220 P+		
			10687	2220 P+	10688	2220 P+				

TABLE 1.2 (continued)

FULL DISK SOLAR OBSERVATIONS

1.2.1			1.2.2							
LOCKHEED Full Disk Filtergrams H α (6563Å)			SAC PEAK Full Disk Spectroheliograms 1.2 solar diameters at He I D $_3$ (5875Å), H α (6563Å) and Ca K (3934Å)							
Date 1973	Time (UT)	Rate	D $_3$, H α -4.31 Å and Ca K		H α , D $_3$ and Ca K + 0.38 Å		H α + 0.5 Å		D $_3$, H α and Ca K	
			Scan No.	Time (UT)	Scan No.	Time (UT)	Scan No.	Time (UT)	Scan No.	Time (UT)
Dec 15	1629-2338	F-30s	10693	1503 F	10694	1506 F	10695	1511 F	10696	1708 F ξ κ
			10700	2008 FP	10697	1711*F κ	10702	2008 FP	10698	1737 F ξ κ
					10699	1740*F κ				
					10701	2008 FP				
16	1807-2327	F-30s	10706	1543 F	10707	1546 F	10708	1551 F		
			10709	2000 P	10710	2000 P	10711	2000 P		
17	1620-2355	F-15s	10715	1954 P	10716	1958 P	10717	2007 P		
18	1632-2350	B-30s	10721	1557 P	10722	1601 P	10723	1609 P		
19			10724	2107 F	10725	2055 F	10726	2102 F		
20	1624-2030	VB-15s	10734	1539 F	10735	1543 F	10736	1548 F		
	2114-1400	VB-15s	10737	2204 F	10738	2204 F				
21	1653-1701	VB-30s	10742	1518 F	10743	1522 F	10744	1528 F		
	1738-1850	VB-30s	10746	2250 P	10747	2250 P	10748	2250 P		
22	2016-2110	VB-30s	10752	1540 G	10753	1544 G	10754	1552 G		
23										
24	1618-2235	VB-30s								
25			10758	1537 F	10759	1541 F	10760	1547 F		
26	1657-2235	F-30s	10764	1955 P	10765	1959 P	10766	2004 P		
27			10770	2119 P	10771	2122 P	10772	2128 P		
28			10775	1544 P	10776	1549 P	10777	1554 P		
			10778	2250 F	20780	2250 F	10781	2250 F		
29	1642-2043	VB-30s	10784	1652 FG	10785	1658 FG	10786	1704 FG		
	2113-2127	VB-30s	10787	2257 P	10788	2257 P	10789	2257 P		
30			10793	1547 F	10794	1551 F	10795	1600 F		
31	1640-2006	VB-30s	10799	1811 P	10800	1817 P	10801	1822 P		
	2029-2235	VB-30s								
1974										
Jan 1			10805	1610 P	10806	1614 P	10807	1621 P		
2	1728-2415+F-60s									
3										
4			10808	1914 P	10809	1918 P	10810	1923 P		
5										
6										
7			10817	2154 P	10818	2157 P	10819	2203 P		
8										
9	1935-2025	FB-30s								
10	1713-2042	FB-30s	10827	2210 F+	10828	2214 F+	10829	2221 F+		
11			10832	1606 P	10833	1610 P	10834	1615 P		
12	1756-1902	FB-15,30s	10838	1539 F	10839	1542 F	10840	1548 F		
	1952-2107	FB-15s								
13	1625-2208	PF-30s	10843	2024 F	20844	2029 F	10845	2035 F		
14	1630-2400	F-30s	10849	1509 F	10850	1513 F	10851	1518 F		
			10852	1819 F κ	10853	1822*F κ	10854	1827 F κ		
			10855	2112 F-	10856	2117 F-	10857	2124 F-		
15	1646-2045	F-30s	10861(R)	1710 G	10862	1659 G	10863	1705 G		
	2045-2410	F-10,15s	10864	1918 F	10865	1923 F	10866	1929 F		
16			10870	1549 F	10871	1553 F	10872	1559 F		
			10873	1707 F	10874	1707 F	10875	1707 F		
			10876	1820 G	10877	1820 G	10878	1820 G		
			10879	2000 G	10880	2000 G	10881	2000 G		
			10882	2130 FP	10883	2130 FP	10884	2130 FP		
			10885	2312 P	10886	2312 P				
17			10890	1600 G	10891	1606 G	10892	1613 G		
			10893	1802 F	10894	1802 F	10895	1802 F		
			10896	1933 F	10897	1933 F	10898	1933 F		
			10899	2100 F-	10900	2100 F-	10901	2100 F-		
18	1914-2226	FP-30s								

See page 31 for Footnotes.

TABLE 1.2 (continued)

FULL DISK SOLAR OBSERVATIONS

1.2.1

1.2.2

LOCKHEED Full Disk Filtergrams H α (6563 Å)			SAC PEAK Full Disk Spectroheliograms 1.2 solar diameters at He I D $_3$ (5875 Å), H α (6563 Å) and Ca K (3934 Å)							
Date 1974	Time (UT)	Rate	D $_3$, H α -4.31 Å and Ca K		H α , D $_3$ and Ca K + 0.38 Å		H α + 0.5 Å		D $_3$, H α and Ca K	
			Scan No.	Time (UT)	Scan No.	Time (UT)	Scan No.	Time (UT)	Scan No.	Time (UT)
Jan 19	1935 + (Visual)	B	10905	1730 P	10906	1735 P	10907	1742 P		
			10908	1930 GN	10909	1930*G	10910	1930 G		
			10911	2013 FP	10912	2013 FP	10913	2013 FP		
			10914	2240 P	10915	2240 P	10916	2240 P		
20			10920	1627 F	10921	1630 F	10922	1637 F		
			10923	1750 F	10924	1750 F	10925	1750 F		
21	1636-2200+F-30s		10929	1506 G	10930	1510 G	10931	1515 G		
22	1638-2354 P-30s		10935	1720 P	10939	1740*VP β	10937	1729 P	10936	1724 P
			10942	1922 P ϕ	10942	1813*VP β			10938	1737 VP $\$ \beta$
					10943	1924 P ϕ			10941	1809 VP $\$ \beta$
23	1717-2400+F-30s		10944	1501 F β	10945	1507 F β	10946	1512 F β		
			10950	1608 β	10951	1608 β	10952	1608 β		
24	1637-2400+F-30s									
25	1635-2400+F-30s		10959	1508 P	10960	1511 P	10962	1522 P		
			10964	1921 P	10965	1921 P	10966	1921 P		
			10967	2315 VP	10968	2315 VP				
26			10972	1612 FG	10973	1617 FG	10974	1624 FG		
			10977	2312 P	10978	2312 P	10979	2312 P		
27	1627-2246F-30s									
28	1626-2219VBF-30s		10983	1545 F+ χ	10984	1549 F+ χ	10985	1554 F+ χ		
	2256-2316VBF-30s		10988	1633 P χ	10989	1633 P χ	10990	1633 P χ		
			10993	1723 F χ	10994	1723 F χ	10995	1723 F χ		
			11000	1937 F- χ	11001	1937 F- χ	11002	1937 F- χ		
			11005	2020 P χ	11006	2020 P χ	11007	2020 P χ		
			11010	2113 P+ χ	11011	2113 P+ χ	11012	2113 P+ χ		
			11015	2246 P χ	11016	2246 P χ	11017	2246 P χ		
29	1727-1817 FB-60s		11023	1510 P			11025	1519 P	11024	1514 P
			11026	2300 P			11028	2300 P	11027	2300 P
30	1850-2415 F-60s		11032	1459	11033	1503	11034	1509		
31	1635-2254 FP-30s		11038	1527 G $\$ \beta$	11039	1531 G	11040	1536 G	11041	1908 F $\$ \beta$
					11042	1911*F β				
Feb 1			11046	1607 F			11048	1618 F	11047	1612 F
			11051	1841 F			11053	1841 F	11052	1841 F
			11054	2019 F			11056	2019 F	11055	2019 F
			11057	2223 F			11059	2223 F	11058	2223 F
			11060	2319 P			11062	2319 P	11061	2319 P
2	1628-2425F-30s		11066	1606 F	11067	1610 F	11068	1617 F		
			11071	1755 P	11072	1755 P	11073	1755 P		
			11074	2302 VP	11075	2302 VP	11076	2302 VP		
3	1624-2248 F-30s		11080	1517 F	11081	1520 F	11082	1525 F		
4	1533-1555 F-30s		11092	1537 F+ \checkmark	11091	1525*P \checkmark	11094	1537 F+ \checkmark	11090	1520 P $\$ \checkmark$
	1625-2445 \pm F-30s				11093	1537 F+ \checkmark			11095	1608 G $\$ \checkmark$
					11096	1608*G \checkmark			11097	1702 F $\$ \checkmark$
					11098	1702*F \checkmark			11099	1845 F $\$ \checkmark$
					11100	1845*F \checkmark			11101	2208 P+ $\$ \checkmark$
					11102	2008*P+ \checkmark			11103	2058 P $\$ \checkmark$
					11104	2058*P \checkmark			11105	2205 F $\$ \checkmark$
					11106	2205*F \checkmark			11107	2257 F $\$ \checkmark$
					11108	2257*F \checkmark				
5	1636-2400 \pm F-60s		11112	1518 G \checkmark	11113	1525 G \checkmark	11114	1531 G \checkmark	11115	1540 GF $\$ \checkmark$
					11116	1544*GF \checkmark			11117	1654 GF $\$ \checkmark$
					11118	1658*GF \checkmark			11119	1808 F $\$ \checkmark$
					11120	1808*F \checkmark			11121	1909 F $\$ \checkmark$
					11122	1909*F \checkmark			11123	2000 F- $\$ \checkmark$
					11124	2000*F- \checkmark			11125	2058 F- $\$ \checkmark$
					11126	2058*F- \checkmark			11127	2208 F $\$ \checkmark$
					11128	2208*F \checkmark			11129	2258 F $\$ \checkmark$
					11130	2258*F \checkmark				

See page 31 for Footnotes.

TABLE 1.2 (continued)

FULL DISK SOLAR OBSERVATIONS

1.2.1			1.2.2							
LOCKHEED			SAC PEAK Full Disk Spectroheliograms 1.2 solar diameters							
Full Disk			at He I D ₃ (5875 Å), H α (6563 Å) and Ca K (3934 Å)							
Date	H α (6563 Å)	Rate	D ₃ , H α -4.31 Å and Ca K		H α , D ₃ and Ca K + 0.38Å		H α + 0.5 Å		D ₃ , H α and Ca K	
			Scan No.	Time (UT)	Scan	Time (UT)	Scan No.	Time (UT)	Scan No.	Time (UT)
Feb 6	1700-2445	P-60s	11134	1949 P	11135	1957 P				
7	1529-2430	F-30s	11139	2053 X	11143	2107*P ✓✓	11141	2100 X	11140	2056 X
					11144	2153*P ✓✓			11142	2105 P § ✓✓
									11145	2156 P § ✓✓

Notes:

- June 15 - Flare at 1419 UT.
 June 16 - Flare RV=.31 PA=40° at 1425 UT, D₃ absorption, possible emission.
 Aug. 17 - Subflare on center of disk at ~1433 UT.
 Aug. 23 - Subflare at ~1815 UT.
 Sept. 5 - Small subflare RV=.6 PA=255° at ~2000 UT.
 Oct. 9 - Small flare at ~2034 UT.
 Imp I flare at ~2334 UT.
 Oct. 27 - Flare RV=.8 PA=100° at ~1600 UT.
 Nov. 24 - Imp I flare maximum at 2008 UT RV=.7 PA=125°.
 Jan. 22,
 1974 - Subflare RV=.9 PA=275° at ~1922 UT.

Footnotes:

- ✓ = JOP 1
 ✓✓ = JOP 1 and 11
 β = JOP 11
 κ = JOP 17
 φ = JOP 16
 X = JOP 25
 † = H α also.
 ** = No H α .
 * = H α only.
 \$ = No Ca K.
 \$\$ = No D₃.
 N = No Ca K or D₃.
 # = Rocket shot support.
 % = Ca K also.
 δ = D₃ also.
 § = H α + 0.625Å

Seeing Conditions:

- B = Bad.
 C = Clouds.
 F = Fair.
 F- = Fair (-).
 FG = Fair to Good.
 FP = Fair to Poor.
 G = Good.
 GF = Good to Fair.
 IP = Intermittent, Poor.
 P = Poor.
 PF = Poor to Fair.
 VP = Very Poor.

EXAMPLE: IP-30s means intermittent operation, poor seeing conditions, 30 second rate for observations.

CATEGORY 2.1) LOCALIZED SMALL-SCALE OBSERVATIONS
Stations listed by Longitude

2.1.1 STATION: Crimean Astrophysical Observatory N44 E34
PROGRAM: Ground-based small-scale H-alpha cinematographic observations

OBSERVING TIMES: see Table
MEASUREMENTS: see Table

INVESTIGATOR: Professor A. B. Severny
Crimean Astrophysical Observatory
P/O Nauchny, Crimea, 334413 USSR

2.1.2 STATION: Big Bear Solar Observatory N34 E243
PROGRAM: Simultaneous cinematograms in three wavelengths

OBSERVING TIMES AND RATES: Pictures normally taken every ten seconds, but less often during poor seeing; for times see Table.

WAVELENGTHS: H-alpha - 0.5 Å, H-alpha + 0.0 Å, Ca K

MEASUREMENTS: 4.2x5.6 arcmin

DATA FORMAT AVAILABLE: Direct scientist-to-scientist

INVESTIGATOR: Harold Zirin
California Institute of Technology
354-33
Pasadena, California USA 91109

2.1.3 STATION: Big Bear Solar Observatory N34 E243
PROGRAM: Cinematograms in two wavelengths

OBSERVING TIMES AND RATES: Pictures normally taken every ten seconds, but less often during poor seeing; for times see Table.

WAVELENGTHS: H-alpha + 0.0 Å, Ca K

MEASUREMENTS: 1/6 solar disk; some H-alpha observations of 1/10 solar disk

DATA FORMAT AVAILABLE: Direct scientist-to-scientist

INVESTIGATOR: Harold Zirin
California Institute of Technology
354-33
Pasadena, California USA 91109

2.1.4 STATION: Mt. Lemmon, Tucson, Arizona N32 E249
PROGRAM: Ground-based infrared photometry

OBSERVING TIMES AND RATES: see Table
WAVELENGTHS: see Table
MEASUREMENTS: see Table
DATA FORMAT AVAILABLE: Strip charts

INVESTIGATOR: H. Hudson
University of California at San Diego
Department of Physics
La Jolla, California USA 92037

TABLE 2.1

LOCALIZED SMALL-SCALE OBSERVATIONS

Date 1973	2.1.1 Crimea		2.1.2 Big Bear				2.1.3			2.1.4 Mt. Lemmon		
	UT	H α Position	H α -0.5 λ 4.2x5.6 arc min UT	H α 4.2x5.6 arc min UT	Ca K 4.2x5.6 arc min UT	H α 1/6 disk UT	Ca K 1/6 disk UT	Infrared Photometry		Field of View		
								UT	Position	λ		
May 28 29 30 31			1302-0030 1444-0103 1313-0024 1450-0158	1302-2105	1302-0030 1443-1808 1350-0024 1450-0214				Submillimeter Tests			
			1330-0126 1334-0105 1328-0231 1327-0130 1305-1909	1330-0126 1310-0105 1328-0231 1327-0146 1305-2140	1330-0126 1310-0105 1328-0203 1327-0000 1305-1900			Submillimeter Tests		3' 3' 23" 20 μ		
									Submillimeter Tests			
									Submillimeter Tests			
									Submillimeter Tests			
June 1 2 3 4 5			1315-2129	1315-2102					Submillimeter Tests		3'	
			1431-0215	1431-0245	1939-0215				Submillimeter Tests		23" 23" 23"	
			1424-0207	1623-0207	1622-0207				Submillimeter Tests		8 μ also 12, 18 and 22 μ 8 μ also 12, 18 and 22 μ	
			1338-0230	1338-0230	1330-0230				Submillimeter Tests		23" 23" 23"	
			1327-0154	1327-0154	1327-0154				Submillimeter Tests		10" 10" 10"	
6									Submillimeter Tests			
									Submillimeter Tests			
									Submillimeter Tests			
									Submillimeter Tests			
									Submillimeter Tests			
7									Submillimeter Tests			
									Submillimeter Tests			
									Submillimeter Tests			
									Submillimeter Tests			
									Submillimeter Tests			
8									Submillimeter Tests			
									Submillimeter Tests			
									Submillimeter Tests			
									Submillimeter Tests			
									Submillimeter Tests			
9									Submillimeter Tests			
									Submillimeter Tests			
									Submillimeter Tests			
									Submillimeter Tests			
									Submillimeter Tests			
10									Submillimeter Tests			
									Submillimeter Tests			
									Submillimeter Tests			
									Submillimeter Tests			
									Submillimeter Tests			

See page 43 for Footnotes.

TABLE 2.1 (Continued)

LOCALIZED SMALL-SCALE OBSERVATIONS

Date 1973	2.1.1 Crimea		2.1.2 Big Bear				2.1.3		2.1.4	
	UT	H α Position	H α -0.5 \AA 4.2x5.6 arc min UT	H α 4.2x5.6 arc min UT	Ca K 4.2x5.6 arc min UT	H α 1/6 disk UT	Ca K 1/6 disk UT	Mt. Lemmon		
								UT	Position	λ
June 10 (cont.)	0921-0925 0944-0949 1105-1112 1122-1132 1244-1252 1539-1550	S12 W90 S12 W90 S12 W90 S12 SW90 CS CS						2200-0100M also 12, 18 and 22 μ	8 μ 10"	
June 11	0409-0418 0440-0443 0542-0551 0620-0623 0718-0758 0850-0855 0916-0921 1022-1058 0356-0359 0516-0519 0653-0659 0806-0807 1549-1550	N20 E89 N20 E89 CS CS CS N15 E24 N15 E24 N15 E23 CS CS CS CS CS	1812-0205	1812-0205	1812-0205			1450-1650M also 10.8, 12.2, 18, and 22 μ	8.6 μ 10"	
12			1339-2100	1339-2100	1339-2100					
13 14			1355-0200 1308-0010	1355-0200 1308-0010	1335-2225 1308-0100			1550-1730M 1800M 2200-2300M also 10.8, 12.2, 18 and 22 μ 1620-1800M 1900-2440M also 10.8, 12.2, 18 and 22 μ	N16 W18 N12 E35 N16 W18 8.6 μ 10" 10" 10" 10" 10"	
15			1400-0237	1914-0108	1400-2025					
16			1325-0154	1325-0053	1325-2144			1515-1750M also 10.8, 12.2, 18 and 22 μ 1830-0100M 1500-1900 2000-0030 1445-0100	N17 W37 8.6 μ 10" 23" 20 μ 100" 180" submm 3'	
17	0440-0447 0754-0756 0918-0923 1317-1322 1542-1546 1546-1553 0402-0409 0530-0539 0614-0628 0710-0740 1016-1020 1141-1157 1205-1231 1624-1631	S15 W90 S15 W90 S15 W90 N12 E28 CS N12 W06 CS CS N12 W14 N12 W14 CS CS N22 W14 N20 E17 N08 E08	1321-0230	1321-0230						
18			1325-0243	1325-0243						

See page 43 for Footnotes.

TABLE 2.1 (Continued)

LOCALIZED SMALL-SCALE OBSERVATIONS

Date 1973	2.1.1 Crimea		2.1.2 Big Bear				2.1.3		2.1.4 Mt. Lemmon		
	UT	H α Position	H α -0.5 \AA 4.2x5.6 arc min UT	H α 4.2x5.6 arc min UT	Ca K 4.2x5.6 arc min UT	H α 1/6 disk UT	Ca K 1/6 disk UT	UT	Infrared Photometry Position λ	Field of View	
June 19	0453-0456 0633-0636 0759-0811	N12 W23 N12 W24 N12 W25	1332-0239	1332-0240	1951-0227			1545-1633M 1850-0130M	S02 E77 S09 E61	20 μ 22 μ	8" 10"
20			1333-0240	1333-0244	1334-0227			1530-0018M	S02 E60	22 μ	10"
21			1310-2240	1310-0229	1328-0229			1526-2253M	S07 E31	22 μ	10"
22	1204-1243 1204-1243	CS S05 E26	1315-0047	1315-0202	1315-2300						
23	1504-1525 1503-1507 1620-1627	S06 E25 N15 W83 N15 W83	1423-0226	1423-0203	1423-0226						
24	1403-1433	CS	1348-0214	1348-0120	1348-0222						
25	1335-1341	CS	1327-0213	1327-0234	1327-0222			1555-2320	S08 W20	20 μ	8"
26			1348-0214	1328-0230	1340-0214						
27	0446-0448	CS	1329-0045	1329-0218	1329-0218						
28			1449-0221	1309-0224	1332-0224						
29	1535-1546	S07 W70	1335-0118	1335-0108	1335-0108						
30			1307-0221	1307-0223	1327-0223						
July 1	1421-1425 1425-1429	N30 E90 N13 E67	1329-0235	1329-0129	1327-0235						
2			1320-0215	1320-0215	1320-0215						
3			1326-0216	1326-0214	1326-0212						
4	1350-1356 1511-1529 1537-1545	N12 E13 N12 E12 N12 E12	1331-0220	1331-0220	1415-0220						
5	0417-0445 0543-0546 1005-1008 1434-1435 1519-1523	N12 E05 CS CS N12 E01 N12 E01	1415-0222	1415-0222	1415-0222						
6	0257-0301 0416-0450 0416-0450	N12 W07 N12 W08 CS	1332-0220	1332-0215	1332-0215						
7	0401-0405 0407-0411	CS CS	1316-0223	1316-0223	1315-0223						
8	1352-1430	CS	1325-0218	1325-2304	1325-0180						
9			1318-0007	1318-0215	1318-2339						
10			1324-0120	1324-0218	1314-0050						
11	1034-1040	CS	1330-2300	1330-0218	1330-0148						

See page 43 for Footnotes.

TABLE 2.1 (Continued)

LOCALIZED SMALL-SCALE OBSERVATIONS

Date 1973	2.1.1 Crimea		2.1.2 Big Bear				2.1.3			2.1.4 Mt. Lemmon	
	UT	H α Position	H α -0.5 \AA 4.2x5.6 arc min UT	H α 4.2x5.6 arc min UT	Ca K 4.2x5.6 arc min UT	H α 1/6 disk UT	Ca K 1/6 disk UT	UT	Infrared Photometry λ	Field of View	
July 12	1304-1306 1444-1453 1500-1511 1313-1318 1336-1340	CS N12 W90 N12 W90 CS CS	1445-0140	1410-0217	1523-0214						
13			1337-0016	1337-0100	1337-2311						
14			1331-0120	1331-0120	1331-0120						
15			1345-0005	1339-0212	1408-0005						
16			1419-0101	1419-0103	1419-0217						
17			1357-0225	1359-0230	1359-0122						
18			1324-0115	1324-0200	1324-0200						
19			1325-0213	1325-0230	1325-0230						
20			1324-0127	1330-0048	1324-0032						
21			1340-0212	1340-0212	1345-0212						
22			1340-0034	1340-0034	1340-2317						
23			1338-0203	1338-0203	1348-0047						
24			1435-0141	1450-0204	1422-2231						
25			1355-0145	1355-0214	1400-0147						
26			1345-0110	1345-0057	1405-0145						
27			1335-0128	1335-0128	1335-2258						
28			1416-0200	1335-0210	1431-0137						
29			1333-0150	1333-0212	1340-0150						
30			1334-0130	1334-0130	1334-0130						
31			1347-1857	1347-1857	1347-1857						
Aug. 1			1740-2038	1500-2038	1510-2038						
2											
3											
4											
5	0704-0713 0803-0817	CS CS									
6	0643-0707 0643-0707 0804-0808 0627-0634 0825-0831 1209-1212 1327-1343	N14 W61 CS N06 W15 CS N23 W70 CS CS									
7											
8											
9											
10	0636-0659	N09 W62							2225-0024 1420-0017 1415-2350		

See page 43 for Footnotes.

TABLE 2.1 (Continued)

LOCALIZED SMALL-SCALE OBSERVATIONS

Date 1973	2.1.1 Crimea		2.1.2 Big Bear				2.1.3		2.1.4 Mt. Lemmon	
	UT	H α Position	H α -0.5 \AA 4.2x5.6 arc min UT	H α 4.2x5.6 arc min UT	Ca K 4.2x5.6 arc min UT	H α 1/6 disk UT	Ca K 1/6 disk UT	UT	Infrared Photometry Position λ	Field of View
Aug. 11										
12										
13										
14										
15	1454-1459	N27 E12				1415-0020 1535-1845				
16	0620-0709 0713-0742 0800-0806 0849-0852 1400-1419 CS CS N27 E02 N27 E02 CS					1418-0017				
17	0516-0527 0653-0658 CS	N00 E07				1400-0026 1436-2055				
18	0722-0724 CS					1437-0021				
19	0843-0845 CS									
20	1357-1401 1404-1409 1427-1440 CS CS CS									
21	0655-0710 0812-0821 0903-0910 1002-1004 1326-1334 1450-1601 1339-1407 N14 E28 CS CS CS CS CS CS					1521-2343				
22	0532-0540 0619-0621 0657-0659 0823-0825 S30 E42 CS CS CS CS					1435-0010				
23	0634-0638 0642-0659 0705-0711 CS	N50 W09 N50 W09				1427-0020 1428-2400				
24	0712-0720 0820-0830 N52 E22 0846-0855 N50 W09 1222-1233f CS					1400-0002				
25										
26	0630-0639 CS					1432-0018 1438-1952				
27	0640-0739 0708-0719 0907-0911 1102-1112 N30 W74 N30 W74 N30 W74 N30 W75									

See page 43 for Footnotes.

TABLE 2.1 (Continued)

LOCALIZED SMALL-SCALE OBSERVATIONS

Date 1973	2.1.1 Crimea		2.1.2 Big Bear				2.1.3		2.1.4 Mt. Lemmon	
	UT	H α Position	H α -0.5 \AA 4.2x5.6 arc min UT	H α 4.2x5.6 arc min UT	Ca K 4.2x5.6 arc min UT	H α 1/6 disk UT	Ca K 1/6 disk UT	UT	Infrared Photometry Position λ Field of View	
Aug. 27 (cont.)		CS								
		1344-1348	CS							
		1354-1358	N13 W57							
		1417-1423	N13 E41							
		1425-1430	N15 E31							
	28		1229-1232	S31 W48						
			1413-1420	CS						
			1445-1446	N15 E09						
			1522-1526	N15 E09						
	29		0639-0644	CS						
		0650-0718	CS							
		0812-0912	CS							
		1306-1311	S30 W58							
		1352-1410	CS							
		1412-1415	S12 E75							
		1416-1440	S12 E75							
		1444-1447	S12 E75							
		1501-1508	S12 E75							
30			0606-0615	CS						
		0621-0628	CS							
		0631-0740	CS							
		0742-0745	N13 W90							
		0803-0808	N13 W90							
31					2246-2416					
					1545-2411					
					1617-2111					
					1616-2035					
					1728-2238					
Sept. 1										
	2									
	3									
	4									
	5									
6		1232-1236	CS							
		1448-1451	N14 E07							
		1135-1142	S17 W34							
		1213-1243	S17 W34							
		1428-1449	N14 W05							
7		1455-1501	N14 W05							
		1508-1515	CS							
		1410-1423f	N14 W20							
		1425-1436	N14 W20							
		1436-1509	N14 W20							
8		1315-1326	CS							
		1329-1334	CS							
		1343-1346	CS							
		1409-1419	CS							
		1420-1423	CS							

See page 43 for Footnotes.

TABLE 2.1 (Continued)

LOCALIZED SMALL-SCALE OBSERVATIONS

Date 1973	2.1.1.1 Crimea		2.1.1.2 Big Bear				2.1.1.3		2.1.4 Mt. Lemmon					
	UT	H α Position	H α -0.5 \AA 4.2x5.6 arc min UT	H α 4.2x5.6 arc min UT	Ca K 4.2x5.6 arc min UT	H α 1/6 disk UT	Ca K 1/6 disk UT	UT	Infrared Photometry Position λ Field of View					
Sept.	9	1118-1137	S15 W73	1614-0108		1640-2355								
		1147-1203	S15 W72											
		1228-1304	CS											
		1327-1411	S13 W18											
		1417-1515	S13 W16											
		0845-0851	CS											
		1054-1059	S12 W33											
		1111-1128	S11 W44											
		1324-1330	N02 W26											
		1332-1339	S13 W27											
1341-1347	S16 W47	1522-1858			1651-2200									
1349-1405	N01 W45													
1406-1411	S20 W90													
1420-1423	S12 W35													
1425-1430	S12 W35													
1431-1434	S12 W35													
1443-1448	S12 W35													
1457-1459	S16 W90													
0902-0954	S16 W90							1359-2120			1733-2356			
1124-1139	S38 W00													
0749-0753	CS													
1026-1055	S12 W80													
1251-1300	S14 W85													
0617-0618	S15 W65													
0716-0742	CS	1642-2154 1452-0044			1700-2353 1635-0000									
1156-1159	S10 E31													
1204-1213	S10 E30													
1326-1332	β													
1336-1341	β													
1358	β													
0847-0900	CS							1443-2325 1456-0116			1610-2300 1730-2355			
0917-0921	S03 W28													
0933-0939	S03 W28													
1032-1038	S03 W28													
1046-1059	S03 W28													
1151-1153	CS													
1214-1220	N16 W25													
18	19													
20														

See page 43 for Footnotes.

TABLE 2.1 (Continued)

LOCALIZED SMALL-SCALE OBSERVATIONS

Date 1973	2.1.1 Crimea		2.1.2 Big Bear				2.1.3		2.1.4 Mt. Lemmon	
	UT	Position	H α -0.5Å 4.2x5.6 arc min UT	H α 4.2x5.6 arc min UT	Ca K 4.2x5.6 arc min UT	H α 1/6 disk UT	Ca K 1/6 disk UT	UT	Position	λ Field of View
Sept. 21	0728-0730	CS	1517-1923	1426-2230	1710-2352	1655-1837				
	0731-0732	CS								
	0741-0743	CS								
	0746-0749	CS								
	0921-0925	N19 W03								
22	0718-0724	N14 E66	1426-2230	1710-2352	1655-1837					
23	0726-0727	N14 E66								
24	0659-0712	E 11mb								
24	0656-0706	N10 E32								
25	1358-1413	N13 E23								
25	0655-0657	CS	1702-2204							
25	0756-0813	CS								
26	1325-1337	CS								
26	1342-1345	CS								
27	1338-1340	CS								
27	1409-1418	CS	1710-2322	1758-2400						
28	1433-1439	N00 E90								
28	1335-1338	CS								
28	1348-1355	N10 W25								
29	1725-1731	N10 W25								
30										
1	1307-1316	CS								
2	1318-1321	CS								
3	1415-1417	CS								
4	0540-0543	CS								
5	0545-0547	CS								
6										
7										
8										
9										
10			1353-1358	CS						
11										
12										
13										
14										
15										

No data October 16 to November 20.

See page 43 for Footnotes.

TABLE 2.1 (Continued)

LOCALIZED SMALL-SCALE OBSERVATIONS

Date 1973	2.1.1.1 Crimea		2.1.1.2 Big Bear				2.1.1.3			2.1.1.4 Mt. Lemmon	
	UT	H α Position	H α -0.5 λ 4.2x5.6 arc min UT	H α 4.2x5.6 arc min UT	Ca K 4.2x5.6 arc min UT	H α 1/6 disk UT	Ca K 1/6 disk UT	Infrared Photometry UT	Position	λ	Field of View
Nov. 21				1918-2100							
22				2210-2350							
23				1710-1947							
24				1620-2044							
25				2125-0006							
26				1649-0010							
27				1623-0008							
28											
29											
30											
Dec. 1				1530-0010							
2				1626-2326							
3				1546-2355							
4											
5											
6				1545-2007							
7				1938-0015					1710-0050		
8				1550-0003					1907-2210		
9				1540-0017					1812-2325		
10				1548-0017				2022-0017*	1715-2215		
11				1640-1807							
12				1555-2158							
13				1547-2339							
14				1605-0025							
15				1613-2220							
16				1533-0010							
17				1557-0015					1800-2200		
18				1600-0000					1700-2318		
19				1627-2328					1750-2240		
20				1610-2305					1630-2135		
21				1530-2146							
22				1544-0002					1725-2107		
23				1540-2251					1947-2303		
24				1540-2115					1810-2100		
25											
26				1551-0002							
27				1536-1645							
28				1933-2047					1755-2240		

See page 43 for Footnotes.

TABLE 2.1 (Continued)

LOCALIZED SMALL-SCALE OBSERVATIONS

Date 1973	2.1.1.1 Crimea H α Position		2.1.1.2 Big Bear				2.1.1.3		2.1.1.4 Mt. Lemmon Infrared Photometry Field of View	
	UT	H α Position	H α -0.5 λ 4.2x5.6 arc min UT	H α 4.2x5.6 arc min UT	Ca K 4.2x5.6 arc min UT	H α 1/6 disk UT	Ca K 1/6 disk UT	UT	Position	λ
Dec. 29				1755-0013						
30								2015-2200		
31										
1974										
Jan. 1				1630-0028			2020-0028*	1750-2147		
2										
3										
4										
5										
6										
7										
8										
9										
10							1733-0034*	1659-2048		
11										
12							2115-2315*	1630-1930		
13				2000-2210						
14				1830-0030						
15				1754-0018						
16				1602-0001						
17				1556-2308						
18				2225-0023						
19				1639-1922						
20				1544-1930						
21							1954-0011*			
22							1911-2130*			
23										
24										
25				1604-1641			1918-2230*	1645-2310		
26								1745-1911		
27				1839-2005				1825-2300		
28				1643-0005				1648-2322		
29				1618-2227				1600-2100		
30				1916-0044						
31				1718-0015						
Feb. 1				1631-0029						
2				2122-2252						
3				1600-0001						

See page 43 for Footnotes.

TABLE 2.1 (Continued)

LOCAL SMALL-SCALE OBSERVATIONS

Date 1974	2.1.1 Crimea		2.1.2 Big Bear				2.1.3		2.1.4 Mt. Lemmon	
	H α Position UT	H α -0.5 \AA 4.2x5.6 arc min UT	H α 4.2x5.6 arc min UT	H α 4.2x5.6 arc min UT	Ca K 4.2x5.6 arc min UT	H α 1/6 disk UT	Ca K 1/6 disk UT	Infrared Photometry Position λ UT	Field of View	
Feb. 4			1552-0036 1617-0011				1845-2350			
5			1549-2350 1547-0030							
6										
7										
8										
9										
10										

FOOTNOTES:

2.1.1

CS = Center of Sun
f = flare occurred
 β = spicule at North Pole

2.1.3

* = 1/10 disk measurement

2.1.4

CS = Center of Sun
M = Mapping

CATEGORY 2.2) LOCALIZED SMALL-SCALE OBSERVATIONS (Cont'd.)
Stations listed by Longitude

2.2.1 STATION: Culgoora S30 E150
PROGRAM: Ground-based high-resolution H-alpha filtergrams obtained at H-alpha line center by means of computer controlled 1/8 Å filter and a 30 cm chromospheric telescope. Normal intention is to make λ -sequences at seven wavelengths in the H-alpha line, not just H-alpha + 0 Å. For equipment capabilities, see Loughhead et al., Solar Phys., 4, 185 (1968) and Bray and Winter, Solar Phys., 15, 309 (1970).

OBSERVING TIMES AND RATES: 1 frame per minute (see Table 2 for observing times)
MEASUREMENTS: 3.6 x 4.6 arc minutes
FILM TYPE: Kodalith Pan
IMAGE SCALE OF ORIGINAL: 1 mm = 11.4 arc sec
QUALITY: Spatial resolution, 1 arc sec; spectrally pure photographs free from parasitic light.
DATA FORMAT AVAILABLE: Prints
Direct scientist-to-scientist
JOPs: These observations are designed to complement XUV observations of the quiet chromospheric network obtained from SKYLAB.

INVESTIGATOR: Dr. R. J. Bray
National Standards Laboratory, CSIRO
University Grounds, City Road
Chippendale, New South Wales 2008 Australia

2.2.2 STATION: Lockheed Solar Observatory N34 E242
PROGRAM: Ground-based Filtergram / Spectra - about 30 parallel H-alpha spectra separated by 20 arc sec; Spectral range per slit: H-alpha \pm 8 Å;
Filtergram: H-alpha slit jaw photograph, 1 Å passband

OBSERVING TIMES AND RATES: 15 sec photo (see Table 2 for observing times)
MEASUREMENTS: about 10 x 7.5 arc min
SLIT: about 1 arc sec each, always oriented N-S in plane of sky
SPECTRAL DISPERSION: 9 Å/mm
FILM TYPE: SO 392
IMAGE SCALE OF ORIGINAL: Image diameter about 7.5 cm
QUALITY: see Table 2
DATA FORMAT AVAILABLE: Duplicate negatives / Prints
Direct scientist-to-scientist
JOPs: 1, 2, 3, 4, 5, 11

INVESTIGATOR: S. Martin
Lockheed-California Company
Solar Physics, Bldg. 243, Pl. 2
Burbank, California USA 91503

2.2.3 STATION: Lockheed Solar Observatory N34 E242
PROGRAM: Ground-based filtergram H-alpha Doppler - H-alpha - 0.6 Å and H-alpha + 0.6 Å simultaneously

OBSERVING TIMES AND RATES: 15 sec photo (see Table 2 for observing times)
MEASUREMENTS: about 10 x 7.5 arc min
FILM TYPE: SO 392
IMAGE SCALE OF ORIGINAL: Image diameter about 7.5 cm
QUALITY: see Table 2
DATA FORMAT AVAILABLE: Duplicate negatives / Prints
Direct scientist-to-scientist
JOPs: 1, 2, 3, 4, 5, 11

INVESTIGATOR: Mr. H. E. Ramsey
Lockheed-California Company
Solar Physics, Bldg. 243, Pl. 2
Burbank, California USA 91503

CATEGORY 2.2 continued

2.2.4 STATION: Lockheed Solar Observatory N34 E242
PROGRAM: Ground-based filtergram He I D₃ (5876 Å)

OBSERVING TIMES AND RATES: 15 sec photo unless otherwise noted in Table 2 (see Table 2 for observing times)
MEASUREMENTS: about 8 x 6 arc min
FILM TYPE: SO 392
IMAGE SCALE OF ORIGINAL: Image diameter about 10 cm
QUALITY: see Table 2
DATA FORMAT AVAILABLE: Duplicate negatives / Prints
Direct scientist-to-scientist
JOPs: 1, 2, 3, 4, 5, 11

INVESTIGATOR: Mr. H. E. Ramsey
Lockheed-California Company
Solar Physics, Bldg. 243, Pl. 2
Burbank, California USA 91503

2.2.5 STATION: Sacramento Peak Observatory N33 E254
PROGRAM: Ground-based filtergrams; 43 wavelength universal birefringent filter (H-alpha ±, H-beta ±, etc.), occasional H-alpha ± 1 5/8 Å measurements.

OBSERVING TIMES AND RATES: 2.5 minutes unless otherwise noted in Table; for times see Table
MEASUREMENTS: 150x200π field of view
FILM TYPE: Kodak 2568 or SO 392 -- 35 mm film
IMAGE SCALE OF ORIGINAL: 8", 10", or 22"
QUALITY: see Table
DATA FORMAT AVAILABLE: Original film
Direct scientist-to-scientist
JOPs: 1, 2, 5, 6, 10, 11, 15

INVESTIGATORS: J. Beckers, W. J. Wagner, G. Simon, and
D. Rust
Sacramento Peak Observatory
Air Force Cambridge Research Laboratories
Sunspot, New Mexico USA 88349

2.2.6 STATION: Sacramento Peak Observatory N33 E254
PROGRAM: Ground-based spectroheliogram; active region spectroheliograms at 5875 Å (D₃), 6563 Å (H-alpha), and 3934 Å + 0.38 Å (Ca K + 0.38 Å)

OBSERVING TIMES AND RATES: 10 minute rate normal, continuous during flares; for times see Table
WAVELENGTHS: D₃ ± 0.0 (5875 Å), H-alpha ± 0.0 (6563 Å), and Ca K + 0.38 Å (3934 Å)
MEASUREMENTS: 18x24 arcmin
SPECTRAL BAND PASS: D₃ = 0.161 Å; H-alpha = 0.135 Å; Ca K = 0.214 Å
FILM TYPE: 2568 developed in D-19 at 68°
S0392 and Linagraph Shellburst developed in Processor
GAF 71/M at 76°
IMAGE SCALE OF ORIGINAL: 4" solar image
QUALITY: see Table
DATA FORMAT AVAILABLE: Prints of flares
Direct scientist-to-scientist
JOPs: 2 usually, 16 during flares

INVESTIGATOR: David Rust
Sacramento Peak Observatory
Air Force Cambridge Research Laboratories
Sunspot, New Mexico USA 88349
currently at American Science and Engineering
955 Massachusetts Ave
Cambridge, Massachusetts USA 02139

TABLE 2.2
LOCALIZED SMALL-SCALE FILTERGRAM OBSERVATIONS

Date 1973	2.2.1 CULGOORA Filtergrams H α line center 3.6x4.6 arc min TIME UT	2.2.2 2.2.3 2.2.4 LOCKHEED FILTERGRAMS			2.2.5 SAC PEAK FILTERGRAMS		
		H α Multi-slit Spectrograph 10x7.5 arc min UT	H α Doppler (H α \pm 0.6 Å) 10x7.5 arc min UT	Large Scale He I D $_3$ (5876 Å) 8x6 arc min UT Rate	H α \pm , H β \pm , D $_2$ \pm , B $_1$ \pm , D $_3$, 4384 \pm , 4227 \pm		
					150 x 200 π UT	Position Angle or Coordinates	Radius vector
May 28 29 30 31		1559-1855 P 2040-2446 P	1559-1855 P 2040-2446 P	1523-1626 P			
June 1 2 3 4 5	0059-0200 @ S05 W31	1611-2036 IP	1611-2036 IVP	1511-2116 IVP-30s 1520-1740 F-30s	1832:30-1902:20 2015:30-2037:55 2146:00-2225:54 0045:00-0114:54	345.1° 343.0 346.0 N10 E00	0.151 P/ 0.152 P/ 0.150 P P//
6 7 8 9 10		1604-2259 FG 1621-2155 G 1635-2110 FG	1604-2259 FG 1621-1825 G 1900-2155 G 1635-2110 FG	1722-1833 G-15-30s 1528-2542 G 1500-2520 FG-15-30s 1551-2150 IPB-30s 1514-2230 PG-30s	2000:00-2029:53 1933:00-1945:23 2025:00-2124:57 2158:00-2220:25	 N28 E67 N28 E67 N28 E67	PB P P P
11 12 13 14 15		1738-2201 F 1613-2059 F 2119-2430 F 1549-1900 V 1943-2254 V 1730-2313 F	1738-2201 F 1612-2059 F 2120-2430 F 1549-2254 F 1730-2313 F	1826-1841 F- 5s 1841-2500 F-30s 1544-1900 F-30s 2051-2422 F-30s 1534-? PF 1940-2311 PF 1432-2450 F	2101:30-2158:00 2352:04-0042:08 1613:00-1756:00	N10 E90	P § P § F**
16 17 18 19 20		1620-2355 F 1548-2400 * 1525-2415	1620-1940 F 1956-2355 F 1548-2400 1525-2415 *	1509-2425 F 1505-1820 F-30s 2115-2337 1501-1620 F 1715-1845 F 1905-2225 F 1536-2238 F 1450-1824 PG-30s 1824-2412 PG 2412-2532 PG-30s	1658:30-1756:00 2240:30-2335:00 0027:00-0122:00 2023:45-2110:30	N15 W90 N15 W90 N15 W90 N14 W02	P** P** P** F §
21 22 23 24 25		1559-2300 2141-2220 1715-2210 1604-2300 F	1559-1630 2135-2507 1608-1730 2141-2220 1715-2210 1604-<1900 F	1521-2527 FG 1544-2035 PB 2130-2237 PB-30s 1520-2240 F 2240-2246 F-30s 1504-2547 I 1511-2620 F	1435:30-1516:00	S06 E35	F § §
26 27 28 29 30		1517-2512 G 1600-2432 F 1610-2215 F 1540-2032 F+ 1758-2052 F+	1545-2512 G 1600-2432 F ~1610-<1650 F ~ - ~ 1900 F 1540-2032 F+ 1758-2052 F+	1551-1636 G 1636-2508 G-30s 1511-2602 F-30s 1444-1907 15s 30s 1907-2532 G-30s 1445-1526 F-30s 1526-2146 F 2146-2436 F-30s 1519-2350 F-30s			

See page 47 for Footnotes.

TABLE 2.2 (continued)

Date 1973	2.2.1 CULGOORA	2.2.2	2.2.3 LOCKHEED FILTERGRAMS	2.2.4	2.2.5 SAC PEAK FILTERGRAMS		
	Filtergrams H α line center 3.6x4.6 arc min TIME UT	H α Multi-slit Spectrograph 10x7.5 arc min UT	H α Doppler (H α \pm 0.6 Å) 10x7.5 arc min UT	Large Scale He I D $_3$ (5876 Å) 8x6 arc min UT Rate	H α \pm , H β \pm , D $_2$ \pm , B $_1$ \pm , D $_3$, 4384 \pm , 4227 \pm 150 x 200 π UT	Position Angle	Radius vector
July 1		1610-1810 F+	1610-1810 F	1505-2500			
2		1755-2040 G	1755-2040 G	1528-2558 G-30s			
3		1523-1950 G	1523-2054 G	1453-2438 G-30s			
4			2137-2243 G				
5		1615-2030 F	1615-2030 F	1505-2002 F-30s 2027-2604 F-30s			
6		1710-2231 F	1710-2231 F	1654-2505 F-30s			
7		1716-2005 F	1716-2005 F	1551-2417 F-30s			
8		1558-1725 F	2055-2113 F 1558-1700 F 1727-2135 F	1534-2500 F-30s			
9		1607-2005 G	2350-2402 F 1609-2247 G	1501-2011 PG 2011-2425 PG-30s			
10		1552-2204 G	1552-2204 G	1519-2325 FG-30s			
11		2037-2125 F	2037-2125 F	1442-2405 F-30s			
12				1500-2145 F-30s			
13				1725-2302 PF-30s			
14				1710-2250 PF-60s			
15				1527-2420 F-60s			
16				1518-1928 FP-60s			
17				2056-2254 FP-60s			
18				1521-2315 F-60s			
19				1458-2347 F-60s			
20				1535-2240 F-60s			
21				1514-2415 PF-60s			
22				1510-2400 PF-60s			

No observations these programs July 23-31.

Footnotes:

- * = Unknown short period outage
- ✓ = STDS on Film
- ✓✓ = exposures did not remain constant
- § = H α \pm , B $_1$ \pm only
- ** = λ scan through H α
30 sec rate/cycle
Film type SO 392
- §§ = 3933 Å 4 densities/8 sec rate
(plage to umbra)
Film type 5375
~ 8" sun

Seeing:

- B = Bad
- F = Fair
- F+ = Fair +
- FG = Fair to Good
- G = Good
- I = Intermittent Operation
- P = Poor
- PB = Poor to Bad
- V = Variable

EXAMPLE: PG-30s means poor to good seeing conditions, 30 second rate for observations.

TABLE 2.2 (Continued)

LOCALIZED SMALL-SCALE FILTERGRAM OBSERVATIONS

Date 1973	2.2.2	2.2.3	2.2.4	2.2.5			2.2.6		
	H α Multi-Slit Spectrograph 10x7.5 arc min UT	LOCKHEED FILTERGRAMS H α Doppler (H α \pm 0.6 \AA) 10x7.5 arc min UT	Large Scale He I D $_3$ (5876 \AA) 8x6 arc min UT	SAC PEAK FILTERGRAMS Universal Filter 43 λ UBF (H α \pm , H β \pm , etc.)			D $_3$, H α , Ca K+0.38 \AA		
			Rate	UT	Rate	Position	SO#	UT	
Aug. 1			1535-2457	F-60S					
2			1455-2507	F-60S					
3			1518-2532	F-60S					
4			1513-2250	VB-60S			463	1430-1600P	
5			1704-2415 \pm	F -15S			464	1430-1650P	
							465	1350-1840P	
							466	1910-2320P	
6			1634+-2500 \pm	FV-15S					
7			1634+-2457	FV-15,30S					
8			1558 -1728	FG-30S			467	1400-2420F	
			1728 -2305	FG-15S			468	1410-2400F	
			2305 -2437	FG-30S					
9			1502 -1735	FG-30S					
			1735 -2235	FG-15S					
10	1632-1950F		2235 -2446	FG-30S					
			1502 -2415	F -30S			470	1655-1740P	
11	1707-2155F	1707-2155F	1513 -2332	PF-15S					
12	1700-2013F	1700-2013F	2332 -2500	PF-60S					
13			1504 -2237	PF-30S					
14	1936-2410F	1936-2410F	2237 -2303	PF-60S					
15	2025-2257G	2026-2257G	1959 -2300	F -30S	1730:30-1815	P -30S			
			2019 -2255	G -15S	2024 -2040				
16			1459 -2500+	F -30S	1837 -1843#	PC-30S	N09 W90		
					1948 -2000#	PC-30S	N09 W90		
17	1814-1910F	1814-1910F	1502 -2413	F -30S	2004 -2019#	PC-30S	N09 W90		
18	1640-1850G	1640-1850G	1517 -2306	G -30S					
	2102-2200G	2102-2200G	2306 -2500	P -60S					
19	1642-1903G	1642-1903G	1504 -2502	G -30S					
20									
21	1824-2113G	1824-2113G	1811 -2108	G -30S	1458 -1532:50	F	CS		
22	1709-2150F	1709-2150F	1720 -2210+	FG-60S					
23	1742-2005G	1742-2005G							
24	1642-1906FG	1642-1906FG							
25									
26									
27	1631-2100F	1631-1745F	2346 -2405	F					
	2135-2401F	1949-2401F							
28	1549-2352G	1549-2352G	1518 -1756	F -30S					
			1756 -2004	G -15S					
			2004 -2358	F -30S					
29	1550-2220G	1550-2435GI	1533 -2445	G -15S					
	2250-2435G								
30	1607-2328G	1607-2328GI	1514 -2328	G -15S					
31	2060-2342F	2000-2342FI	1640 -2240	F -15S	1553:30-1654:17*PC-30S		Pr.SW limb		
Sept. 1	1700-1950F	1700-1950F	1620 -2148	FP-15S	1345:30-1347:40*FPC-30S		Pr.SW limb	471	1659-2400P
	2124-2200F	2124-2200F	2148 -2320	P -30S	1349:30-~1359* FPC-30S		Pr.SW limb		
					1502:30-1728:18*FPC-30S		Pr.SW limb		
					1824:30-1840:30*FPC-30S		Pr.SW limb		
2	1620-1642F	1620-1905FI	1504 -2515 \pm	FP-15S				472	1400-2300PI
	1702-2210F	1925-2210FI							
3									
4	2101-2437F	2101-2437F	2043 -2432	F -15S				473	1400-2350F
5	1800-2332G	1800-2332G	1853 -2156	F -15S				474	1430-2300F
								475	1740-2150FI

See page 51 for Footnotes.

TABLE 2.2 (Continued)

LOCALIZED SMALL-SCALE FILTERGRAM OBSERVATIONS

Date 1973	LOCKHEED FILTERGRAMS			SAC PEAK FILTERGRAMS			
	2.2.2	2.2.3	2.2.4	2.2.5			2.2.6
	H α Multi-Slit Spectrograph 10x7.5 arc min UT	H α Doppler (H α ± 0.6 Å) 10x7.5 arc min UT	Large Scale He I D $_3$ (5876Å) 8x6 arc min UT Rate	Universal Filter 43 λ UBF (H α ±, H β ±, etc.) UT Rate Position	D $_3$, H α , Ca K+0.38Å S0# UT		
Sept. 6	1610-1925F 1950-2307F	1610-2307F	1511-2306 F -15S				476 1650-1850F
7	1645-2205F	1645~2200F	1632-2354 F -30S				477 1520-1930P
8	1709-2100F	1709-2100F	1716-2429 F -30S				477 2120-2340P
9	1737-2155F	1737-2155F	1606-2418 PF-30S				478 1413-1545F
10	1840-2210F	1840-2210F	1805-2224 F -30S				
11							
12	1550-2257F	1550~2045F	1535-2250± F -15S				480 1404-2330PI
13	2035-2224F	2035-2224F	1827-2301 F -15S				
14	1850-2145F	1850-2145F	1908-2233 F -30S				
15	2135-2218F	2135-2218F	1836-2428 F -30S				
16	1945-2025F 2043-2145F	1945-2145F	1703-2245 F -30S				
17	1648-2130F	1648-2130F	1528-2324 F -30S	1607:00-1711:00 F -30S CS Y			
18				1740:30-1850:00 F -30S CS Y			
19				1728:00-1809:00 FP-30S CS Y			
20							
21	1640-1834F	1640-1834F	1855-2334 G -60S	1551 -1740 P -30S			
22							
23			1614-1752 F -60S				
24			1752-1836 P -15S				
25			1836-2330 VB-30S				482 1415-2320P
26				1726 -1742 P -30S (large active region)			
27				1750 -1820 P -30S			
28				1927 -2033# FP-30S Pr.E limb			
29				2224 -2255# FP-30S Pr.E limb			
30			1518-0027 G -30S				
			1533-2240 G -30S				
Oct. 1			1736-0048 F -30S				488 1410-2300F
2							489 1434-2310P
3							490 1457-1808PI
4	2403-2446	2403-2446	2404-2446 F				490 2043
5							490 2047
6							
7							
8							
9							
10				2144 -2212 FP CS			
				2249 -2344 FP CS			
11				1456 -1543* FP ss 64°-304°			
12				1444 -1527* F ss 35°-275°			
				1741:30-1833:55 FP N30 W30			
				1905:00-2007:24 FP N30 W30			
				2212:00-2314:23 FP N30 W30			
				1551:00-1618:26 PF CS			
				1650:00-1750:25 PF CS			
				1827:30-1924:58 PF CS			
				2149:00-2233:57 PF CS			
				2305:00-2359:58 PF CS			

See page 51 for Footnotes.

TABLE 2.2 (Continued)

LOCALIZED SMALL-SCALE FILTERGRAM OBSERVATIONS

Date 1973	LOCKHEED FILTERGRAMS			SAC PEAK FILTERGRAMS			D ₃ , H α , Ca K+0.38Å	
	2.2.2 H α Multi-Slit Spectrograph 10x7.5 arc min UT	2.2.3 H α Doppler (H α ± 0.6 Å) 10x7.5 arc min UT	2.2.4 Large Scale He I D ₃ (5876Å) 8x6 arc min UT Rate	2.2.5 Universal Filter 43 Å UBF (H α ±, H β ±, etc.) UT Rate Position			2.2.6 SO#	UT
Oct. 14 15	No data October 16-24.							
Oct. 25 26 27 28 29 30	1804-2228	1804-2228	1813-2225 30S 1608-1731 15S 1704-2403 G -30S				494 1516-2310F 495 1917-2230P 496 1513-2310P 497 1620-2300P	
Nov. 28 29 30	No data October 31 - November 27.			1747 -1835	F -30S	S10 W10		
Dec. 1 2 3 4 5				1618 -2056 P* 1510 -1518 FP \$ 1827 -1840 FP \$ 2047 -2059 FP \$	S09 W90 K N15 W90 K N15 W90 K M15 W90 K		505 1610-2100P	
6 7 8 9 10	No data December 11-15.			1641-2344 F -30S 1650-2340 F -30S 1954-2345 F -30S	1633:40-1710:30 P 1802:30-1845:00 P		S90 E00 β S90 E00 β	
16 17 18 19	1902-2345F 1710-1915B	1729-2345F 1710-1915B	1935-2320 F -15S 1727-1909 B -30S	1709 -1801	FG	S17 E64		
20	2004-2015VB 2121-2324VB	2004-2015VB 2121-2230VB	1810-2015 VB-15S	1943:26-2008:00 2109:35-2116:15	VPC-2min RV=1 VPC-2min RV=1	PA=76.3° \$ PA=76.3° \$	1562:43-1556:00 P -45S NP \$\$ 1643:47-1700:00 P -45S NP \$\$ 1954:02- ?? P S17 E23	
21 22 23 24 25				1745-1850 VB-30S 2036-2110 VB-30S 1752-2235 VB-30S			508 1700-1840P	
26 27 28 29 30 31	1833-2200VB			1724-2057 VB-30S	1728:52-1803:51 P 2200:53-2248:49 P 2120:03-2159:20 PC		S17 W85 S17 W85 S18 W90 \$\$	
1974 Jan. 1 2 3 4 5				1724 -1809	N15 W90 \$			

See page 51 for Footnotes.

TABLE 2.2 (Continued)

LOCALIZED SMALL-SCALE FILTERGRAM OBSERVATIONS

Date 1974	LOCKHEED FILTERGRAMS			SAC PEAK FILTERGRAMS		
	2.2.2	2.2.3	2.2.4	2.2.5		2.2.6
	H α Multi-Slit Spectrograph 10x7.5 arc min UT	H α Doppler (H α \pm 0.6 \AA) 10x7.5 arc min UT	Large Scale He I D $_3$ (5876 \AA) 8x6 arc min UT Rate	Universal Filter 43 λ UBF (H α \pm , H β \pm , etc.) UT Rate Position		D $_3$, H α , Ca K+0.38 \AA SO# UT
Jan. 10 11 12 13 14 15			2025-2107 FB-15S 1756-2209 F -30S 2224-2400+ F -30S 1706-2110 F -30S 2110-2310 F -10,15S 2310-2410 F -30S	2027:30-2140:00F		
16 17 18 19 20			1945-2226 FP-30S	1717:00-1744:30P 1829:00-1919:00P	S12.1 E61.0 S11.4 W30.3	
21 22 23 24 25			1714-2200+ F -30S 1952-2327 F -30S 1650-2215 F -30S	1730:00-1810:00P-30S S13.4 W36.4 γ 1529:00-1610:00P-30S N 5.9 W73.2 α		
26 27 28 29 30 31	2025-2235VBF 1815-2217FP	1834-2146F 1826-1855F 2025-2235F 1827-2217F	2016-2238 F -30S 1755-2232 VBF-30S 1655-2215 FP-30S			
Feb 1 2 3 4	1844-2205F 1738-1946F	1844-2205F 1735-1946F	1652-2210 F -30S 1652-2135 FP-30S 1846-2308 F -30S			

FOOTNOTES:

2.2.5

Sac Peak UBF:

- α = H α \pm , H β \pm , B $_1$ \pm , D $_2$ \pm
- β = α and 4388 \pm , 4226 \pm
- γ = α and 5230 \pm , 5383 \pm
- δ = H α , some D $_3$
- $\$$ = H α \pm , H β \pm , D $_3$ \pm
- * = H α \pm
- # = H α \pm 1/8 \AA

- CS = Center of Sun
- κ = 180 x 250 arc sec
- NP = North Pole
- PA = Position Angle
- RV = Radius Vector
- ss = spicule survey

2.2.6

Small Scale

Sac Peak - D $_3$, H α , Ca K+0.38 \AA

Flares Observed:

Date	UT	RV	PA
Sept. 1	1830	.7	145 $^\circ$
2	2200	.6	160 $^\circ$
3	1503	.7	100 $^\circ$
	1624	.3	10 $^\circ$
	1720	.7	100 $^\circ$
	2040	.7	100 $^\circ$
	2320	.7	100 $^\circ$
4	1512	.5	88 $^\circ$
	1558	.4	210 $^\circ$
	1645	.5	88 $^\circ$
5	1845	.1	85 $^\circ$
	2019	.6	250 $^\circ$
6	1705	.6	120 $^\circ$
8	2230	.3	180 $^\circ$
9	1454	.6	245 $^\circ$
12	1956	.85	280 $^\circ$
24	1759	.00	CS

Seeing:

- B = Bad
- F = Fair
- FB = Fair to Bad
- FG = Fair to Good
- FI = Fair, Intermittent Observations
- FP = Fair to Poor
- FPC = Fair to Poor, Clouds
- FV = Fair, Variable
- G = Good
- P = Poor
- PC = Poor, Clouds
- PF = Poor to Fair
- PI = Poor, Intermittent Observations
- VB = Very Bad
- VBF = Very Bad to Fair
- VPC = Very Poor, Clouds



Fig. 1. Sample magnetogram of solar active regions taken at Sayan Mountain Observatory (IRKUTSK). Image scale is 2 arcsec/min.

CATEGORY 3.1) MAGNETOGRAMS
Stations Listed by Longitude

3.1.1 STATION: Crimean Astrophysical Observatory N44 E34
PROGRAM: Magnetic field observations

OBSERVING TIMES AND RATES: see Table
MEASUREMENTS: see Table

INVESTIGATOR: Professor A. B. Severny
Crimean Astrophysical Observatory
P/O Nauchny, Crimea, 334413 USSR

3.1.2 STATION: Sayan Mountain Observatory (Irkutsk) N52 E104
PROGRAM: Ground-based sunspot group magnetograms - longitudinal photospheric magnetic fields. Field intensity is represented as negative film with light as negative (-) polarity, gray as neutral, and dark as positive (+). Response is 0-270 G; noise is ± 15 G. (see Figure 1. for example)

OBSERVING TIMES: see Table
WAVELENGTH: Fe II (5233Å), Fe I (5250Å)
MEASUREMENTS: 4x2 arcsec
SPECTRAL DISPERSION: 0.3 Å/mm
IMAGE SCALE OF ORIGINAL: 16.4 cm solar image, 2 arcsec/min
DATA FORMAT AVAILABLE: Duplicate negatives
Direct scientist-to-scientist and to World Data Centers

INVESTIGATORS: V. Stepanov
V. Grigoryev
SibIZMIR
P/B 4, Irkutsk 33 USSR

3.1.3 STATION: Sayan Mountain Observatory (Irkutsk) N52 E104
PROGRAM: Ground-based solar center magnetograms. Field intensity is represented as negative film with light as negative (-) polarity, gray as neutral, and dark as positive (+). Response is 0-270 G; noise is ± 15 G.

OBSERVING TIMES AND RATES: 5 minute rate; for times see Table
WAVELENGTH: Fe I (5250Å)
MEASUREMENTS: 400x600 arcsec
SPECTRAL DISPERSION: 0.3 Å/mm
IMAGE SCALE OF ORIGINAL: 16.4 cm solar image, 2 arcsec/min
DATA FORMAT AVAILABLE: Duplicate negatives
Direct scientist-to-scientist and to World Data Centers

INVESTIGATORS: V. Stepanov
V. Grigoryev
SibIZMIR
P/B 4, Irkutsk 33 USSR

3.1.4 STATION: Big Bear Solar Observatory N34 E243
PROGRAM: Ground-based video magnetograms

OBSERVING TIMES AND RATES: See Table for times; taken continuously of the same region observed by the three chromospheric cameras.
WAVELENGTH: Fe I (5324.191 Å)
MEASUREMENTS: 4.2x5.6 arcmin
DATA FORMAT AVAILABLE: Direct scientist-to-scientist

INVESTIGATOR: Harold Zirin
California Institute of Technology
354-33
Pasadena, California USA 91109

CATEGORY 3.1 continued

3.1.5 STATION: Kitt Peak Observatory N32 E249
PROGRAM: Ground-based magnetograms (polar scans); high sensitivity scans of polar regions for correlation with coronal plumes.

OBSERVING TIMES AND RATES: see Table (UT = 115°WMT + 7 hours)
WAVELENGTHS: Fe I (5233 Å)
MEASUREMENTS: Field of view = 1000x400 arcsec
QUALITY: see Table
DATA FORMAT AVAILABLE: Prints / Digitized (tape)

INVESTIGATORS: J. Harvey, W. C. Livingston
Kitt Peak National Observatory
P.O. Box 26732
950 North Cherry Avenue
Tucson, Arizona USA 85726

3.1.6 STATION: Kitt Peak Observatory N32 E249
PROGRAM: Ground-based magnetograms (area scan reports); high resolution scans of selected areas for correlation with X-ray features.

OBSERVING TIMES AND RATES: see Table (UT = 115°WMT + 7 hours)
WAVELENGTHS: Fe I (5233 Å)
MEASUREMENTS: Active regions unless otherwise noted (see Table)
QUALITY: see Table
OTHER PERTINENT INFORMATION: see Table
DATA FORMAT AVAILABLE: Prints / Digitized (tape)
Direct scientist-to-scientist

INVESTIGATORS: J. Harvey, W. C. Livingston
Kitt Peak National Observatory
P.O. Box 26732
950 North Cherry Avenue
Tucson, Arizona USA 85726

3.1.7 STATION: Sacramento Peak Observatory N33 E254
PROGRAM: Ground-based filtergram / spectra / magnetogram - Magnetic fields in sunspots:
Spectra 5576 Å and 6173 Å; slit jaw filtergrams at 5200 Å and 5800 Å

OBSERVING TIMES AND RATES: 10 sec rate (see Table 3 for observing times)
MEASUREMENTS: see Table 3
SLIT: about 1.0 arc second per slit width
SPECTRAL DISPERSION: 5576 Å (8.7 Å/mm); 6173 Å (7.7 Å/mm)
FILM TYPE: IVE, linagraph drift survey, 649 G H
IMAGE SCALE OF ORIGINAL: 10" image
QUALITY: see Table 3
DATA FORMAT AVAILABLE: Direct scientist-to-scientist
JOPs: 2E

INVESTIGATOR: Dr. Jacques Beckers
Sacramento Peak Observatory
Air Force Cambridge Research Laboratories
Sunspot, New Mexico USA 88349

TABLE 3.1
MAGNETOGRAMS

Date 1973	3.1.1.1 Crimea		3.1.1.2 Sayan		3.1.1.3 Solar Center		3.1.1.4 Big Bear		3.1.1.5 Kitt Peak		3.1.1.6 Fe I 5233 Å		3.1.1.7 Sec Peak	
	Longitudinal Component Position	Region	Sunspot Groups 4 x 2 arcsec UT	Position MM	Mag #	400x600 arcsec UT	Mag #	Fe I 5324.191 Å 4.2x5.6 arcmin UT	Polar Scans 115°WMT	Area Scans (active regions) 115°WMT	Position (arcsec) P-N-T	Area Scans (active regions) 115°WMT	Position (arcsec) P-N-T	Sunspot Groups Spectra 5576, 6173 Å Filtergram 5200, 5800 Å UT SPO# RV PA
May 18														
19														
20														
21														
22														
23														
24														
25														
26														
27														
28														
29														
30														
31														
Jun 1														
2														
3														
4														
5														
6	N15 E40 N14 E26 N06 E08 CS	47 47 48												
7	N15 E65 (0330-0540 UT) CS	50												
8	(0650-0855 UT) (0900-0945 UT) CS	50 50												
9	N14 E52 CS	50												
10	N14 E38 (1050-1230 UT) CS	50												
	(1330-1400 UT)													
11	N16 E25 CS	50												
12	N16 E12 (0620-0730 UT) CS	50												
	(0800-0900 UT)													

Abbreviated headings and symbols deciphered on page 64.

TABLE 3.1 continued

MAGNETOGRAMS

Date 1973	3.1.1 Crimea		3.1.2 Savay		3.1.3 Solar Center		3.1.4 Big Bear		3.1.5 Kitt Peak		3.1.6 Kitt Peak		3.1.7 Sac Peak		
	Longitudinal Component Position	Region	Sunspot Groups 4 x 2 arcsec UT	Position MM Mag #	Center 400X600 arcsec UT Mag #	Fe I 5324.191 Å 4.2x5.6 arcmin UT	Polar Scans 115° WMT	Area Scans (active regions) fov	Area Scans (active regions) fov	Sunspot Groups	Spectra 5576, 6173 Å	Filtergram 5200, 5800 Å	UT	SP0# RV PA	
Jun 13			0618* N15 E00 0649 N15 E00 0327 N11 E59 0600 N11 E59 0605* N11 E59 1042 N11 E45 1055 N11 E45 1110 N11 E45 2300 N11 E45 2308 N11 E45 2332 N11 E45 2340 N11 E45 0913 N15 W25 0002 N12 E35	M379 47 M379 49 M387A 45 M387A 46a M387A 46b M387A 48 M387A 50 M387A 51 M387A 52 M387A 53 M387A 54 M387A 55 M379 74 M387A 56	62 64 66		1129PN	07248Q N00 E00 1010- N15 E25 1525G	250x250 1 500x500 2-32- ~10						
14			0228 N12 E35 0350 N12 E35 0407 N12 E35 0418 N12 E35 0544 N12 E35 0615 N12 E35 0641 N12 E35 0711 N12 E35 0735 N12 E35 0809 N12 E35 0819 N12 E35 0840 N12 E35 0849 N12 E35 0905 N12 E35 0931 N12 E35	M387A 57 M387A 58 M387A 59 M387A 60 M387A 61 M387A 63 M387A 65 M387A 67 M387A 68 M387A 69 M387A 70 M387A 71 M387A 72 M387A 73 M387A 75											
15			0335 N12 W05 2345 S15 E70 2350 S15 E70 0000 N12 W17 0045 N12 W17 0127 N12 W17 0132 N12 W17 0217 N12 W17 0030 S15 E70 0035 S15 E70 0120 S15 E70 0205 S15 E70 0211 S15 E70 0308 S15 E70 0320 S15 E70	M887A 76 M397A 77a M397A 77b M387A 78 M387A 80 M387A 81b M387A 82 M387A 84 M397A 79a M397A 79b M397A 81a M397A 83a M397A 83b M397A 85a M397A 85b											
16			0335 N12 W05 2345 S15 E70 2350 S15 E70 0000 N12 W17 0045 N12 W17 0127 N12 W17 0132 N12 W17 0217 N12 W17 0030 S15 E70 0035 S15 E70 0120 S15 E70 0205 S15 E70 0211 S15 E70 0308 S15 E70 0320 S15 E70	M887A 76 M397A 77a M397A 77b M387A 78 M387A 80 M387A 81b M387A 82 M387A 84 M397A 79a M397A 79b M397A 81a M397A 83a M397A 83b M397A 85a M397A 85b											
17	(0355-0440 UT)														
18	N12 W06 55 CS														
19	N13 W23 55 CS														
20	S08 E53 57 CS														
21	S08 E24 57 CS														
22	S03 E09 58														
23	S08 W06 57 CS														
24															
25															

Abbreviated headings and symbols deciphered on page 64.

TABLE 3.1 continued

MAGNETOGRAMS

Date	3.1.1 Crinia		3.1.2 Sagan		3.1.3 Solar Center		3.1.4 Big Bear		3.1.5 Kitt Peak		3.1.6 Fe I 5233 Å		3.1.7 Sunspot Groups			
	Longitudinal Component Position	Region	Sunspot Groups 4 X 2 arcsec	UT	Position	MM #	Mag #	Fe I 5234, 191 Å	4.2x5.6 arcmin	UT	Polar Scans 115°WMT	Area Scans (active regions) 115°WMT Position (arcsec)	P-N-T	Spectra 5576, 6173 Å	Filtergram 5200, 5600 Å	
Jun 26			0938 S08 W25	M397A 87				Fe I 5234, 191 Å	4.2x5.6 arcmin	UT		S05 W30	375x350	1-12-6		
27	S12 W20	59	0955 S08 W25	M397A 88							0835G	N00 W30	375x250	1		
28	S08 W33	57	1005 S08 W25	M397A 89							0846F	S10 W10	375x250	1		
29	S03 W30	58	1024 S08 W25	M397A 90							0902F	S10 W35	375x250	1		
	S03 W47	58	1036 S08 W25	M397A 91							1158Q	N00 E00	250x100	2		
	S08 W73	57								1319GN	N00 E00	250x100	2			
	S13 W50	59								0753-0757FQ	N00 E00	25x25	½-14-			
30	N12 E70	64								1357GN						
	S08 E63	63								1437GS						
										1514GS						
										1423PS						
Jul 1	N13 E57	64														
2	CS, Poles	64														
3	N13 E44	64														
4	CS, Poles	64														
5	N13 E16	64														
	CS, Poles	64														
6	N12 W08	64														
7	N12 W22	64														
8	N01 W01	65														
9	N12 W33	64														
	N01 W12	65														
	Poles	64														
	N12 W49	64														
	N02 W26	65														

Abbreviated headings and symbols deciphered on page 64.

TABLE 3.1 continued
MAGNETOGRAMS

Date	3.1.1 Crimea		3.1.2 Savan		3.1.3 5250 A		3.1.4 Big Bear		3.1.5 Kitt Peak		3.1.6 Fe I 5233-K		3.1.7 Sac Peak												
	Longitudinal Component Position	Region	Sunspot Groups	4 x 2 arcsec UT Position	MM #	Magn #	Solar Center	400x600 arcsec UT Magn #	Fe I 5324.191 Å	4.2x5.6 arcmin UT	Polar Scans	115°WMT	Area Scans (active regions)	fov	Position (arcsec)	P-N-T	Sunspot Groups	Spectra	Filtergram	5200, 5800 Å	UT	SPO#	RV	PA	
Jul 10	M12 W64	64																							
11																									
12	CS																								
13																									
14	CS, Poles	68																							
15	S11 W45	68																							
16	S11 W58	68																							
17	S12 W28	69																							
18	S06 E09	70																							
19	*S12 W46	69																							
20	S06 W04	70																							
21	N18 E46	72																							
22																									
23																									
24																									
25																									
26																									
27																									
28																									
29																									
30																									
31																									
Aug 1																									
2																									
3																									
4																									
5	N05 E11	79																							
6	N05 W01	79																							
7																									
8																									
9																									
10	N07 W59	79																							

Abbreviated headings and symbols deciphered on page 64.

TABLE 3.1 continued
MAGNETOGRAMS

Date	3.1.1 Crimea		3.1.2 Sayan		3.1.3		3.1.4 Big Bear		3.1.5 Kitt Peak		3.1.6 Fe I 5233 A		3.1.7 Sac Peak													
	Longitude Component Position	Region	Sunspot Groups	UT	4 x 2 arcsec	MM	Mag	Solar Center	400x600 arcsec	UT	Mag	#	Fe I 5234, 191 A	4.2x5.6 arcmin	UT	Area Scans (active regions)	fov	P-N-T	Sunspot Groups	Spectra 576, 6173 A	Filtergram 5200, 5800 A	UT	SPO#	RV	PA	
1973																										
Aug 11																										
12																										
13																										
14																										
15																										
16																										
17																										
18																										
19																										
20																										
21																										
22																										
23																										
24																										
25																										
26																										
27																										
28																										
29																										
30																										

Abbreviated headings and symbols deciphered on page 64.

TABLE 3.1 continued

MAGNETOGRAMS

Date	3.1.1 Crimea		3.1.2 Savan		3.1.3 Solar Center		3.1.4 Big Bear		3.1.5 Kitt Peak		3.1.6 Area Scans		3.1.7 Sac Peak					
	Longitudinal Component Position	Region	Sunspot Groups 4 x 2 arcsec	UT Position	MM #	Mag #	400x600 arcsec	UT	Fe I 5324.191 Å	4.2x5.6 arcmin	UT	Fe I 5233 Å	Area Scans (active regions) fov	115°WMT Position (arcsec)	P-N-T	Sunspot Groups	Spectra 5576, 6173 Å	Filtergram 5200, 5800 Å
1973																		
Aug 30																		
31	N02 W27	86																
Sep 1	S15 E36	90																
2	S15 E23	90																
3																		
4																		
5	N14 E14	92																
	N22 W25	94																
6	N13 W00	92																
7	N14 W13	92																
8																		
9	S13 W14	98																
10	S10 W41	100																
	S12 W26	98																
11	S10 W55	100																

Abbreviated headings and symbols deciphered on page 64.

TABLE 3.1 continued
MAGNETOGRAMS

Date	3.1.1 Crimea Longitude Component Position Region	3.1.2 Sayan		3.1.3 Solar Center		3.1.4 Big Bear Fe I 5324, 191 Å 4.2x5.6 arcmin UT	3.1.5 Kitt Peak Polar Scans 115°WMT	3.1.6 Kitt Peak Area Scans (active regions) Fov 115°WMT Position (arcsec)	3.1.7 Sac Peak Sunspot Groups Spectra 5576, 6173 Å Filtergram 5200, 5800 Å UT SPD# RV PA
		Sunspot Groups 4 x 2 arcsec UT Position	MM #	Mag #	400x600 arcsec UT #				
Sep 11		0044	S12 W36	M513	153				
		0157	S12 W36	M513	155				
		0305	S12 W36	M513	157				
		0928	S12 W36	M513	161				
		0955*	S12 W36	M513	162				
		1005*	S12 W36	M513	163				
		0142	N12 W82	M510	166a				
		0329	N12 W82	M510	165				
		0148	S10 W68	M520	166b				
		0332	S10 W68	M520	168b				
13				0055#	164				
14	CS			0110%	165				
15	CS	0336	N13 E67	M525	171a				
16	N12 W20								
17	CS								
	N14 E55	101							
18		0247	N13 E54	M525	178a				
		0250	N13 E54	M525	178b				
		0329	N13 E54	M525	180				
		0332	N13 E54	M525	180b				
		0413	N13 E54	M525	181a				
		0506	N13 E54	M525	181b				
		0910	N13 E54	M525	182a				
		0913	N13 E54	M525	182b				
		0113	N13 E39	M525	183a				
		0116	N13 E39	M525	183b				
		0140	N13 E39	M525	184a				
		0143	N13 E39	M525	184b				
		0201	N13 E39	M525	185a				
		0206	N13 E39	M525	185b				
		0235	N13 E39	M525	186a				
		0237	N13 E39	M525	186b				
		0244	N13 E39	M525	187a				
		0247	N13 E39	M525	187b				
		0310	N13 E39	M525	188a				
		0313	N13 E39	M525	188b				
		0324	N13 E39	M525	189a				
		0327	N13 E39	M525	189b				
		0421	N13 E39	M525	190b				
		0434	N13 E39	M525	191a				
		0437	N13 E39	M525	191b				
		0504	N13 E39	M525	192b				
		0514	N13 E39	M525	193a				
		0517	N13 E39	M525	193b				
0700	N13 E39	M525	194a						
0704	N13 E39	M525	194b						
0710	N13 E39	M525	196a						
0720	N13 E39	M525	195b						
0740	N13 E39	M525	196a						
0753	N13 E39	M525	196b						
0800	N13 E39	M525	197a						
0803	N13 E39	M525	197b						
0823	N13 E39	M525	198a						
0840	N13 E39	M525	199a						
0852	N13 E39	M525	199b						
0930	N13 E39	M525	200a						
0934	N13 E39	M525	200b						

Abbreviated headings and symbols deciphered on page 64.

TABLE 3.1 continued
MAGNETOGRAMS

Date 1973	3.1.1 Crimea		3.1.2 Sayan		3.1.3 Solar Center		3.1.4 Big Bear		3.1.5 Kitt Peak		3.1.6 Area Scans		3.1.7 Sunspot Groups	
	Longitudinal Component	Position Region	Sunspot Groups 4 x 2 arcsec	UT Position	MM Mag	UT Mag	Fe I 5324.191 Å 4.2x5.6 arcmin	UT	Polar Scans	115°WMT	Position (arcsec)	P-N-T	Spectra	Filtergram
Oct 14	CS													
15		No data	October 16 - 27.											
28													1739:00- 1743:00P	3452 .35 233°
29													1824:20- 1828:40P	3452 .35 233°
30													1523:20- 2220:40F	3452# .65 265°
Nov 28		No data	October 31 - November 27.											
29														
30														
Dec 1														
2														
3														
4														
5														
6														
7														
8														
9														
10		No data	December 11 - 17.											
18		No data	December 19 - 25.											
26														
27														
28														
29														
30														
31														
1974		No data	January 1 - 14, 1974.											
Jan 15														
16														
17														
18														
19														
20														
21														
22														
23														
24														
25														

Abbreviated headings and symbols deciphered on page 64.

Table 3.1 (continued)

FOOTNOTES

Seeing Conditions:

B = Bad
 C = Clouds
 F = Fair
 F+ = Fair (+)
 FG = Fair to Good
 FI = Fair, Intermittent
 G = Good
 GC = Good, some clouds
 I = Intermittent
 M = Mediocre
 P = Poor
 PC = Poor, clouds
 PI = Poor, Intermittent
 VG = Very Good

3.1.5

N = North Pole (geocentric)
 S = South Pole (geocentric)
 * = heliocentric - offset for P-angle
 $\frac{1}{2}$ = 5173 Å, low sensitivity
 tp = only half the normal run
 ch = tracking poor
 W = coronal hole
 = West Limb

3.1.6

\$ = Equipment failure - some problems in the data
 Q = Quiet region
 \$\$ = Many frames lost due to clouds and guiding
 M = Mediocre seeing
 δ = NRL JOP
 fov = field of view
 P-N-T: P = area in arcsec of the probes
 N = number of frames
 T = times between frames

3.1.1

CS = Center of the sun
 * = Transverse component also
 ** = Transverse component only

3.1.2; 3.1.3

MM # = McMath #
 Mag # = Sayan Magnetogram #
 # = 2.5 towards N from solar center
 % = 2.5 towards S from solar center
 * = 5233 Å

3.1.7

= 8 observing periods
 SP0# = Sac Peak Obs. #
 RV = radius vector
 PA = position angle

CATEGORY 4.1) CORONAGRAPHS
Stations Listed by Longitude

4.1.1 STATION: Mauna Loa, Hawaii N21 E204

PROGRAM: Ground-based coronagraph. Two white light coronagraphs (K-coronameter and coronal activity monitor), having spatial resolution of about one arcmin.

OBSERVING TIMES AND RATES: Generally 1700-0300 UT daily, weather permitting (see Table)

WAVELENGTHS: 6200 Å

OTHER PERTINENT INFORMATION: Point-by-point photoelectric scans around the limb of the sun at ten concentric heights (in the range 1.1 to 2 R_{\odot}) to measure the intensity of the white light ("K") corona. A full set, producing a two-dimensional "picture" of the corona, is accomplished in 2-3 hours. Program is repeated throughout day as weather conditions permit.

DATA FORMAT AVAILABLE: Computer plot
Direct scientist-to-scientist

INVESTIGATOR: Richard Hansen
National Center for Atmospheric Research
High Altitude Observatory
P.O. Box 1470
Boulder, Colorado USA 80302

4.1.2 STATION: Sacramento Peak Observatory N33 E254

PROGRAM: Ground-based filtergram / 16 inch coronagraph / photographic spectra - coronal active regions; Graded height spectra of forbidden coronal lines. Fiducial filtergrams at $\lambda\lambda 5303, 6374, 6563$ Å. Absolute photometry of spectra.

OBSERVING TIMES AND RATES: See table for times and the number of different heights at which spectra were taken.

WAVELENGTHS: $\lambda\lambda 3550-9000$ Å if H-alpha loops are observed; $\lambda\lambda 4500-9000$ Å if no H-alpha loops are observed.

MEASUREMENTS: Field of view = 8×6 arcmin
Radius vector = 1.0

SLIT: Position angle (geocentric) - see Table

SLIT: Straight slit parallel to limb
 $100\mu (2\pi) \times 24.5\text{mm} (480\pi)$

SPECTRAL DISPERSION: $\lambda 3900$ (~ 1.64 Å/mm); $\lambda 5300$ (~ 2.5 Å/mm); $\lambda 6400$ (~ 5.4 Å/mm)

FILM TYPE: $\lambda\lambda 3550-6000$ Å 103-aD
 $\lambda\lambda 6000-9000$ Å 2481

IMAGE SCALE OF ORIGINAL: 20 π /mm

QUALITY: see Table

OTHER PERTINENT INFORMATION: see Table

DATA FORMAT AVAILABLE: Direct scientist-to-scientist

JOPs: 2C

INVESTIGATOR: William J. Wagner
Sacramento Peak Observatory
Air Force Cambridge Research Laboratories
Sunspot, New Mexico USA 88349

CATEGORY 4.1 continued

4.1.3 STATION: Sacramento Peak Observatory N33 E254
PROGRAM: Ground-based filtergram / coronagraph / spectra (photographic) 6" coronagraph for 5303 Å filtergrams for complete limb survey and/or movie; 4" coronagraph for 5303 and 6374 Å spectral surveys and/or movie.

OBSERVING TIMES AND RATES: 6" coronagraph 5303 Å limb survey Δ 45° P.A. (see Table 3 for observing times); limb movie at one P.A. (see Table 3 for observing time and rate);
4" coronagraph - spectrograms limb survey 5303 and 6374 Å (see Table 3); limb spectral movie 5303 Å
MEASUREMENTS: 6" coronagraph movies: 60° of P.A. x 0.7 r_{\odot}
4" coronagraph spectra: 60° of P.A. at 15 arc sec above solar limb
SLIT: Curved, tangential; 60° position angle x 2300 km = 3.1 arc sec integrated height in corona
SPECTRAL DISPERSION: about 1.7 Å/mm
FILM TYPE: Filtergram 049-1(4-J); Spectrogram 103aF.
IMAGE SCALE OF ORIGINAL: Filtergram about 1.9" = 48 mm; Spectra 1.5" = 38 mm
QUALITY: see Table 3
DATA FORMAT AVAILABLE: Direct scientist-to-scientist
JOPs: 2C, 6, 8

INVESTIGATOR: Dr. William J. Wagner, and H. DeMastus
Sacramento Peak Observatory
Air Force Cambridge Research Laboratories
Sunspot, New Mexico USA 88349

4.1.4 STATION: Sacramento Peak Observatory N33 E254
PROGRAM: Ground-based coronagraph

OBSERVING TIMES AND RATES: see Table
WAVELENGTHS: 5303 Å
MEASUREMENTS: 1.5 π
SLIT: 1.5 π
SPECTRAL DISPERSION IN Å/mm: 10,000 = $\Delta\lambda/\Delta$
FILM TYPE: photoelectric
IMAGE SCALE OF ORIGINAL: 100 mm
QUALITY: see Table
DATA FORMAT AVAILABLE: Digitized (card)
Direct scientist-to-scientist
JOPs: 6

INVESTIGATOR: Richard R. Fisher
Sacramento Peak Observatory
Air Force Cambridge Research Laboratories
Sunspot, New Mexico USA 88349

4.1.5 STATION: Sacramento Peak Observatory N33 E254
PROGRAM: Ground-based coronagraph / filtergram / spectra
SJC-1 filtergrams: λ 6563 Å
SJC-2 filtergrams: λ 6374, 6563, 6375, 5303 Å
Spectra: λ 8024, 7892, 7059, 6703, 6374, 5694, 5303, 5445, 5411, 4686, 4412, 6563, 5875 Å

OBSERVING TIMES: see Table
MEASUREMENTS: 28° of solar limb;
Radius vector = 1.0+;
for Position Angle (geocentric) see Table
SLIT: 0.86 π
SPECTRAL DISPERSION: 2-7 Å/mm
FILM TYPE: 103-H-alpha, 103-AF, 2481
IMAGE SCALE OF ORIGINAL: 4"
QUALITY: see Table
DATA FORMAT AVAILABLE: Direct scientist-to-scientist
JOPs: 2C

INVESTIGATOR: Richard R. Fisher
Sacramento Peak Observatory
Air Force Cambridge Research Laboratories
Sunspot, New Mexico USA 88349

TABLE 4.1

CORONAGRAPHS

Date 1973	4.1.1 MAUNA LOA 6200Å		4.1.2 SAC PEAK Filtergrams: λλ3550-9000Å (Hα loops) λλ4500-9000Å (No Hα loops)		4.1.3 SAC PEAK 6" filtergram λ5303Å (a) 4" spectrogram λ5303Å (b) 4" spectrogram λ6374Å (c)		4.1.4 SAC PEAK 5303Å R/R ₀ =1.15(a), 1.24(b), 1.55(c)		4.1.5 SAC PEAK Spectra and Filtergrams (SJC-1, SJC-2) RV=1.0+	
	UT	PA	UT	PA	UT	Rate	UT	PA	UT	PA
May 28	1700-0300									
29	1700-0300									
30	No Obs.									
31	1700-0300									
June 1	1700-0300									
2	No Obs.					1518-1522(a) 1553-1605(b) 1517-1533(c) 1413-1420m(a) 1414-1429(b) 1435-1501(c) 1522-1526(a) 1615-1627(b) 1513-1530(c)				
3	No Obs.									
4	1700-0300									
5	1700-0300									
6	No Obs.									
7	No Obs.									
8	1700-0300									
9	1700-0300									
10	1700-0300									
11	1700-0300									1843-2022FG 66° a
12	1700-0300									
13	1700-0300									

See page 81 for Footnotes.

TABLE 4.1 (continued)

CORONAGRAPHS

Date 1973	4.1.1 MAUNA LOA 6200Å		4.1.2 SAC PEAK Filtergrams: λλ3550-9000Å (Hα loops) λλ4500-9000Å (No Hα loops)		4.1.3 SAC PEAK 6" filtergram λ5303Å(a) 4" spectrogram λ5303Å(b) 4" spectrogram λ6374Å(c)		4.1.4 SAC PEAK 5303Å R/Re 1.15(a) 1.35(b), 1.55(c)		4.1.5 SAC PEAK Spectra and Filtergrams (SJC-1, SJC-2) RV=1.0+	
	UT	PA	UT	PA	UT	Rate	UT	UT	UT	PA
June 14	1700-0300									
15	1700-0300									
16	1700-0300									
17	1700-0300									
18	No Obs.									
19	No Obs.									
20	1700-0300									
21	1700-0300									
22	No Obs.									
23	1700-0300									
24	1700-0300									
25	1700-0300									

See page 81 for Footnotes.

TABLE 4.1 (continued)

CORONAGRAPHS

Date 1973	4.1.1.1 MAUNA LOA 6200Å		4.1.1.2 SAC PEAK Filtergrams: λλ3550-9000Å (Hα loops) λλ4500-9000Å (No Hα loops)		4.1.1.3 SAC PEAK 6" filtergram λ5303Å (a) 4" spectrogram λ5303Å (b) 4" spectrogram λ6374Å (c)		4.1.1.4 SAC PEAK 5303Å R/Res=1.15(a), 1.35(b), 1.55(c)		4.1.1.5 SAC PEAK Spectra and Filtergrams (SJC-1, SJC-2) RV=1.0+	
	UT	PA	UT	PA	UT	Rate	UT	UT	UT	PA
June 26	No Obs.									
27	1700-0300									
28	1700-0300									
29	1700-0300									
30	No Obs.									
July 1	1700-0300									
2	1700-0300									
3	1700-0300									
4	1700-0300									
5	1700-0300									
6	1700-0300									
7	1700-0300									
8	1700-0300									
9	1700-0300									
10	1700-0300									
11	1700-0300									
12	1700-0300									
13	1700-0300									
14	No Obs.									
15	No Obs.									

See page 81 for Footnotes.

TABLE 4.1 (continued)

CORONAGRAPHS

Date 1973	4.1.1.1 MAUNA LOA 6200Å		4.1.1.2 SAC PEAK Filtergrams: λλ3550-9000Å (Hα loops) λλ4500-9000Å (No Hα loops)		4.1.1.3 SAC PEAK 6" filtergram λ5303Å(a) 4" spectrogram λ5303Å(b) 4" spectrogram λ6374Å(c)		4.1.1.4 SAC PEAK 5303Å R/Re=1.15(a), 1.24(b), 1.55(c)		4.1.1.5 SAC PEAK Spectra and Filtergrams (SJC-1, SJC-2) RV=1.0+	
	UT	PA	UT	PA	UT	Rate	UT	UT	UT	PA
July 16	1700-0300									
17	1700-0300									
18	1700-0300									
19	1700-0300									
20	1700-0300							1805(a) 1817(b) 1829(c)		
21	1700-0300							1515(a) 1527(b) 1540(c)		
22	1700-0300							1649(a) 1702(b)		
23	No Obs.							1716(c)		
24	1700-0300							1816(a) 1828(b) 1840(c)		
25	1700-0300									
26	1700-0300									
27	1700-0300									
28	1700-0300									
29	1700-0300									
30	1700-0300							1724(a) 1727(b) 1803(c)		
31	1700-0300									
Aug. 1	1700-0300									
2	1700-0300									
3	1700-0300									
4	1700-0300							2017(a) 2029(b) 2042(c)		
5	1700-0300							1412(a) 1424(b) 1436(c)		

See page 81 for Footnotes.

TABLE 4.1 (continued)

CORONAGRAPHS

Date 1973	4.1.1.1 MAUNA LOA 6200Å		4.1.1.2 SAC PEAK Filtergrams: λλ3550-9000Å (H α Loops) λλ4500-9000Å (No H α Loops)		4.1.1.3 SAC PEAK 6" filtergram λ5303Å(a) 4" spectrogram λ5303Å(b) 4" spectrogram λ6374Å(c)		4.1.1.4 SAC PEAK 5303Å R/R ϕ =1.15(a) 1.24(b), 1.55(c)		4.1.1.5 SAC PEAK Spectra and Filtergrams (SJC-1, SJC-2) RV=1.0+	
	UT	PA	UT	Rate	UT	Rate	UT	Rate	UT	PA
Aug. 6	1700-0300				1430-1442(b) 1523-1540(c) 1610-1627(c) 1640-1651(b) 1445-1504(b)					
7	1700-0300									
8	1700-0300									
9	1700-0300									
10	No Obs.									
11	No Obs.				1423-1429(a) 1542-1547(a) 1435-1447(b) 1541-1558(c) 1551-1559:30m(a) 1504-1521(b) 1422-1446(c)			1442(a) 1458(b) 1512(c)		
12	1700-0300	283°	1550-1604F 8h (sky=40x10 ⁻⁶ B θ seeing = 1 5303, 6374Å only) (weak region)					1415(a) 1427(b) 1439(c) 1439(a) 1455(b) 1508(c)		
13	1700-0300				1408-1414(a) 1420-1651:40m(a) 30,35 sec.int. 1413-1428(b) 1505-1650:20m(b)			1457(a) 1509(b) 1521(c)		
14	1700-0300									
15	1700-0300									
16	1700-0300									
17	1700-0300									
18	1700-0300							1520(a) 1531(b) 1545(c) 1447(a) 1459(b) 1611(c) 1417(a) 1428(b) 1441(c)		
19	No Obs.									
20	No Obs.									
21	1700-0300				1659-1706(a) 1706-1852m(a) 1706-1720(b) 1730-1852m(b) 1440-1445(a) 1446-2039m(a) 1434-1450(b) 1505-1939m(b)	2/min		1640(a) 1653(b)		
22	No Obs.									
23	No Obs.						3/min 30,35 sec.			

See page 81 for Footnotes.

TABLE 4.1 (continued)

CORONAGRAPHS

Date 1973	4.1.1 MAUNA LOA 6200Å		4.1.2 SAC PEAK Filtergrams: λλ3550-9000Å (Hα Loops) λλ4500-9000Å (No Hα Loops)		4.1.3 SAC PEAK 6" filtergram λ5303Å(a) 4" spectrogram λ5303Å(b) 4" spectrogram λ6374Å(c)		4.1.4 SAC PEAK 5303Å R/R ₀ =1.15(a), 1.55(c)		4.1.5 SAC PEAK Spectra and Filtergrams (SJC-1, SJC-2) RV=1.0+	
	UT	PA	UT	PA	UT	Rate	UT	PA	UT	PA
Aug. 24	1700-0300				1431-1436(a) 1631-1934m(a) 1431-1446(b) 1630-1934m(b) 1619-1623(a) 1441-1454(b)	35 sec.		1435(a) 1447(b) 1500(c)		
25	1700-0300							1541(a) 1552(b) 1604(c)		
26	1700-0300				1435-1441(a) 1611-1742m(a) 1538-1613(b) 1624-1742m(b)	1/35 sec.		1509(a) 1520(b) 1532(c)		
27	1700-0300									
28	No Obs.									
29	1700-0300									
30	1700-0300									
31	1700-0300									
Sept. 1	1700-0300		1950-2118E, 6h, 98°					1713(a) 1725(b) 1738(c)		
2	No Obs.		(sky=50x10 ⁻⁶ B ^e) seeing=1 Region cool Weak λ5303 see also 6374, 7892.					1518(a) 1529(b) 1543(c) 1535(a) 1547(b) 1559(c) 1529(a) 1542(b) 1713(c) 1639(a) 1647(b) 1700(c)		
3	1700-0300									
4	1700-0300									
5	1700-0300									
6	1700-0300							1545(a) 1588(b) 1610(c)		
7	1700-0300									
8	1700-0300				1709-1723(b) 1736-1753(c)			0008(a) 0019(b) 1540(a) 1552(b) 1605(c)		

See page 81 for Footnotes.

TABLE 4.1 (continued)

CORONAGRAPHS

Date 1973	4.1.1 MAUNA LOA 6200Å		4.1.2 SAC PEAK Filtergrams: λλ3550-9000Å (Hα loops) λλ4500-9000Å (No Hα loops)		4.1.3 SAC PEAK 6" filtergram λ5303Å(a) 4" spectrogram λ5303Å(b) 4" spectrogram λ6374Å(c)		4.1.4 SAC PEAK 5303Å R/R ₀ =1.15(a), 1.24(b), 1.55(c)		4.1.5 SAC PEAK Spectra and Filtergrams (SJC-1, SJC-2) RV=1.0+	
	UT	PA	UT	Rate	UT	Rate	UT	PA	UT	PA
Sept. 9	1700-0300									
10	1700-0300									
11	1700-0300									
12	1700-0300									
13	No Obs.									
14	No Obs.									
15	1700-0300									
16	1700-0300									
17	1700-0300									
18	1700-0300									
19	1700-0300									
20	1700-0300									
21	1700-0300									
22	No Obs.									
23	1700-0300									
24										
25	1700-0300									

See page 81 for Footnotes.

TABLE 4.1 (continued)

CORONAGRAPHS

Date 1973	4.1.1.1 MAUNA LOA 6200Å		4.1.1.2 SAC PEAK Filtergrams: λλ3550-9000Å (Hα loops) λλ4500-9000Å (No Hα loops)		4.1.1.3 SAC PEAK 6" filtergram λ5303Å(a) 4" spectrogram λ5303Å(b) 4" spectrogram λ6374Å(c)		4.1.1.4 SAC PEAK 5303Å R/Ro=1.15(a), 1.24(b), 1.55(c)		4.1.1.5 SAC PEAK Spectra and Filtergrams (SUC-1, SUC-2) RV=1.0+	
	UT	PA	UT	Rate	UT	Rate	UT	PA		
Sept. 26	1700-0300				1654-1658(a) 1700-2120m(a) 1703-2121m(b) 1531-1535(a) 1448-1452(a) 1457-2124m(a) 30,40,50,35 sec. 1501-2122m(b)			1642(a) 1654(b) 1707(c)		
27	1700-0300	133°	1555-1650g. 9h							
28	1700-0300) (good forbidden lines)	sky=18 seeing=1							
29	1700-0300									
30	1700-0300									
Oct. 1	1700-0300				1526-1529(a) 1524-1537(b)			1456(a) 1508(b) 1518(c) 1515(a) 1529(b) 1541(c)		
2	1700-0300									
3	1700-0300) (very weak other lines)	1502-1514F 4h							
4	1700-0300		sky=65x10 ⁻⁶ B ₀ seeing=1 strong λ5303	307°						
5	1700-0300									
6	No Obs.									
7	1700-0300									
8	No Obs.									
9	1700-0300		1537-1707G 8h	281°	1537-1541(a) 1542-2051m(a) 1546-1716m(b)	30,35 sec.		1630(a) 1642(b) 1655(c) 1447(a) 1459(b) 1513(c) 1444(a) 1457(b) 1508(c)		
10	No Obs.		sky=50 seeing=2 Good active corona, many[Lvis] lines, surge (occurred during run)							
11	No Obs.				1505-1509(a) 1513-2129m(a) 1544-2052m(b)	45,50 sec.		1501(a) 1513(b) 1527(c) 1537(a) 1549(b) 1601(c)		
12	1700-0300									

See page 81 for Footnotes.

TABLE 4.1 (continued)

CORONAGRAPHS

Date 1973	4.1.1 MAUNA LOA 6200Å		4.1.2 SAC PEAK Filtergrams λλ3550-9000Å (Hα loops) λλ4500-9000Å (No Hα loops)		4.1.3 SAC PEAK 6" filtergram λ5303Å (a) 4" spectrogram λ5303Å (b) 4" spectrogram λ6374Å (c)		4.1.4 SAC PEAK 5303Å R/Ro=1.15(a), 1.24(b), 1.55(c)		4.1.5 SAC PEAK Spectra and Filtergrams (SJC-1, SJC-2) RV=1.0+ UT PA	
	UT	PA	UT	PA	UT	Rate	UT	UT	UT	PA
Oct. 13	1700-0300									
14	1700-0300							1545 (a) 1558 (b) 1613 (c)		
15	1700-0300				1449-1453 (a) 1622-1949m (a) 1618-1630 (b)	30, 40 sec.		1528 (a) 1541 (b) 1554 (c) 1558 (a) 1611 (b) 1624 (c)		2031-2150VP 130° a
16	No Obs.				1526-1532 (a) 1533-1821m (a) 1535-1821m (b)	35, 45 sec.		1520 (a) 1536 (b) 1548 (c) 1459 (a) 1512 (b) 1523 (c)		
17	1700-0300							1713 (a) 1724 (b) 1737 (c) 1524 (a)		
18	1700-0300				1457-1503 (a) 1502-1508 (a)					
19	1700-0300									
20	No Obs.									
21	No Obs.									
22	1700-0300									
23	1700-0300									
24	No Obs.				1526-1532 (a) 1534-2024m (a) 1540-1830m (b) 1516-1519 (a) 1638-2023m (a) 1526-1538 (b) 1656-2024m (b) 1724-1735 (b)	45, 50 sec. Various				
25	1700-0300									
26	1700-0300				1814-1828 (b)					
27	1700-0300									
28	1700-0300									
29	1700-0300				1551-1556 (a) 1558-1924m (a) 1554-1608 (b) 1620-1637 (c)			1555 (a) 1608 (b) 1621 (c)		

See page 81 for Footnotes.

TABLE 4.1 (continued)

CORONAGRAPHS

Date 1973	4.1.1.1 MAUNA LOA 6200Å		4.1.2 SAC PEAK Filtergrams: λλ3550-9000Å (Hα loops) λλ4500-9000Å (No Hα loops)		4.1.3 SAC PEAK 6" filtergram λ5303Å(a) 4" spectrogram λ5303Å(b) 4" spectrogram λ6374Å(c)		4.1.4 SAC PEAK 5303Å R/Re=1.15(a), 1.24(b), 1.55(c)		4.1.5 SAC PEAK Spectra and Filtergrams (SJC-1, SJC-2) RV=1.0+	
	UT	PA	UT	PA	UT	Rate	UT	Rate	UT	PA
Oct. 30	No Obs.									
31	No Obs.									
Nov. 1	1700-0300									
2	1700-0300									
3	1700-0300									
4	No Obs.									
5	No Obs.									
6	1700-0300									
7	1700-0300									
8	No Obs.									
9	No Obs.									
10	No Obs.									
11	1700-0300									
12	No Obs.									
13	No Obs.									
14	No Obs.									
15	1700-0300									

See page 81 for Footnotes.

TABLE 4.1 (continued)

CORONAGRAPHS

Date 1973	4.1.1 MAUNA LOA 6200Å		4.1.2 SAC PEAK Filtergrams: λλ3550-9000Å (Hα loops) λλ4500-9000Å (No Hα loops)		4.1.3 SAC PEAK 6" filtergram λ5303Å(a) 4" spectrogram λ5303Å(b) 4" spectrogram λ6374Å(c)		4.1.4 SAC PEAK 5303Å R/Re=1.15(a) 1.24(b), 1.55(c)		4.1.5 SAC PEAK Spectra and Filtergrams (SJC-1, SJC-2) RV=1.0+	
	UT	PA	UT	PA	UT	Rate	UT	UT	UT	PA
Nov. 16	1700-0300				1931-1936(a) 1718-1732m(b) 1649-1706(c)					
17	1700-0300							1539(a) 1551(b) 1603(c)		
18	No Obs.									
19	No Obs.									
20	No Obs.									
21	No Obs.				1641-1645(a) 1647-1727m(a) 1650-1727m(b) 1511-1517(a) 1519-1753m(a) 1517-1752m(b) 1821-1827					
22	No Obs.							1708(a) G 1720(b) G 1732(c) G		
23	No Obs.							2045(a) P 2058(b) P 2112(c) P		
24	1700-0300									
25	1700-0300									
26	No Obs.							1552(a) VP 1605(b) VP 1616(c) VP		
27	No Obs.							1600(a) G 1612(b) G 1624(c) G		
28	No Obs.				1534-1542(a) 1543-1551(a) 1552-2123m(a) 1553-2042m(b)			1650(a) G 1702(b) G 1714(c) G 2107(a) G 2120(b) G 2134(c) G		
29	No Obs.									
30	No Obs.								1758-1950F	275° b
Dec. 1	No Obs.							1838(a) F 1853(b) F		

See page 81 for Footnotes.

TABLE 4.1 (continued)

CORONAGRAPHS

Date 1973	4.1.1 MAUNA LOA 6200Å		4.1.2 SAC PEAK Filtergrams: λλ3550-9000Å (H α loops) λλ4500-9000Å (No H α loops)		4.1.3 SAC PEAK 6" filtergram λ5303Å(a) 4" spectrogram λ5303Å(b) 4" spectrogram λ6374Å(c)		4.1.4 SAC PEAK 5303Å R/Re=1.15(a), 1.24(b), 1.55(c)		4.1.5 SAC PEAK Spectra and Filtergrams (SJC-1, SJC-2) RV=1.0+	
	UT	PA	UT	PA	UT	Rate	UT	UT	UT	PA
Dec 2	No Obs.		1810-1850 11h (sky=35x10 ⁻⁶ B ₀ seeing = 1+ Double 5303 regions in fov Weak coronal rain and surges. Weak [VIs] lines, esp. in higher stages.)	289°						
3	1700-0300									
4	1700-0300									
5	1700-0300									
6	1700-0300									
7	1700-0300									
8	No Obs.									
9	1700-0300									
10	No Obs.									
11	No Obs.									
12	1700-0300									
13	1700-0300									
14	1700-0300									
15	1700-0300									
16	1700-0300									
18	1700-0300									
19	1700-0300									
20	1700-0300									
21	1700-0300									

See page 81 for Footnotes.

TABLE 4.1 (continued)

CORONAGRAPHS

Date 1973	4.1.1.1 MAUNA LOA 6200Å UT		4.1.1.2 SAC PEAK Filtergrams: λλ3550-9000Å (Hα loops) λλ4500-9000Å (No Hα loops) UT PA		4.1.1.3 SAC PEAK 6" filtergram λ5303Å (a) 4" spectrogram λ5303Å (b) 4" spectrogram λ6374Å (c) UT Rate		4.1.1.4 SAC PEAK 5303Å R/Re=1.15(a) 1.24(b), 1.55(c) UT		4.1.1.5 SAC PEAK Spectra and Filtergrams (SJC-1, SJC-2) RV=1.0+ UT PA	
	Dec. 22	1700-0300		1528-1534(a) 1536- ? m(a) 1539- ? m(b)	1623(a) G 1635(b) G					
23	1700-0300									
24	No Obs.									
25	1700-0300									
26	1700-0300									
27	1700-0300		1834-1841(a) 1940-2125m(a) 1945- ? m(b) 1736-1742(a) 1746-1930m(a) 1746- ? m(b)	2102(a) G 2113(b) G 2047(a) G 2058(b) G						
28	1700-0300									
29	No Obs.									
30	No Obs.									
31	No Obs.									
1974										
Jan. 1	1700-0300		1632-1636(a)	1835(b) F 1851(c) F 1903(a) F						
2	1700-0300									
3	1700-0300									
4	No Obs.			2051(a) G 2103(b) P 2115(c) P						
5	No Obs.									
6	1700-0300									
7	No Obs.									
8	1700-0300									
9	No Obs.									
10	1700-0300			2241(a) P						
11	1700-0300		1809-1816(a) 1817-2105m(a) 1817- ? m(b)	1759(a) F 1812(b) F 1823(c) F 1838(a) F				1858-2008F+ 112° b		

See page 81 for Footnotes.

TABLE 4.1 (continued)

CORONAGRAPHS

Date 1974	4.1.1.1 MAJINA LOA 6200Å		4.1.1.2 SAC PEAK Filtergrams: λλ3550-9000Å (Hα loops) λλ4500-9000Å (No Hα loops)		4.1.3 SAC PEAK 6" filtergram λ5303Å(a) 4" spectrogram λ5303Å(b) 4" spectrogram λ6374Å(c)		4.1.4 SAC PEAK 5303Å R/Re=1.15(a) 1.24(b), 1.55(c)		4.1.5 SAC PEAK Spectra and Filtergrams (SJC-1, SJC-2) RV=1.0+		
	UT	PA	UT	PA	UT	Rate	UT	UT	UT	PA	
Jan. 12	1700-0300				1614-1620(a) 1621-1715m(a) 1621- ? m(b) 1536-1541(a) 1544-2104m(b) 1544->1953m(b) 1649-1656(a) 1617 (a) G 1852-2127m(a) 1856->1958m(b) 1540-1547(a) 1551-2129m(a) 1555->2013(b) 1532-1539(a) 1541-1919m(a) 1542->1828m(b)			1620(a) G 1632(b) G 1645(c) G 1602(a) G 1614(b) G 1626(c) G 1617 (a) G 1628(b) G 1640(c) G 1923 (a) G 1937 (b) G 1949(c) G			
13	1700-0300										2101-2216F- 104° c
14	1700-0300										
15	No Obs.										1510-1918F- 278° d*
16	1700-0300										
17	1700-0300										
18	1700-0300										
19	1700-0300										
20	1700-0300										
21	No Obs.										
22	1700-0300										
23	1700-0300					1623-1631(a) 1841-2104m(a)					
24	1700-0300										
25	1700-0300					1738-2013m(a) 1745->1844m(b)					1900-2245FC 247° e
26	1700-0300										
27	1700-0300					1527-1533(a) 1534-2052m(a) 1534->2019m(b)					
28	No Obs.										
29	1700-0300					1842-1850(a) 1851-2135m(a) 1846->1956m(b)					
30	1700-0300										

See page 81 for Footnotes.

TABLE 4.1 (continued)

CORONAGRAPHS

Date	4.1.1 MAIWA LOA 6200Å UT	4.1.2 SAC PEAK Filtergrams: λλ3550-9000Å (Hα loops) λλ4500-9000Å (No Hα loops) UT PA	4.1.3 SAC PEAK 6" filtergram λ5303Å(a) 4" spectrogram λ5303Å(b) 4" spectrogram λ6374Å(c) UT Rate	4.1.4 SAC PEAK 5303Å R/R0=1.15(a), 1.24(b), 1.55(c) UT	4.1.5 SAC PEAK Spectra and Filtergrams (SJC-1, SJC-2) RV=1.0+ UT PA
Jan. 31	1700-0300		1517-1523(a) 1525-2157m(a)	1559(a) G 1610(b) G 1622(c) G	
Feb. 1	1700-0300		1543-1549(a)	1558(a) G 1610(b) G 1621(c) G 1524(a) G 1537(b) G 1549(c) G 1610(a) G 1635(a) F 1657(c) F	
2	1700-0300				
3	1700-0300				
4	1700-0300		1519-1529(a) 1530-2212m(a) 1530->2042m(b)	1600(a) F 1627(c) F	
5	1700-0300				
6	1700-0300				
7	1700-0300				
8	1700-0300				
9	No Obs.				
10	No Obs.				
11	No Obs.				
12	No Obs.				
13	No Obs.				
14	1700-0300				
15-30	1700-0300				
31	1700-0300				
Mar. 1	1700-0300				
2	1700-0300				
3	No Obs.				
4	No Obs.				
5	No Obs.				
6	1700-0300				
7	1700-0300				
8	1700-0300				
9	1700-0300				
10	No Obs.				

Footnotes:

4.1.2

h = number of different heights
fov = field of view

4.1.3

m = movie

4.1.5

Spectra only:

a = 8024, 7892, 7059
6703, 6374, 5303Å
b = a + 5694Å
c = b + 5445, 5411,
no 7059Å
d = b + 5445, 5411,
4686, 4412Å
e = d + 6563, 5875Å

* = 5303Å for SJC-1 filtergram

Seeing Conditions:

F = Fair
FG = Fair to Good
G = Good
P = Poor
VP = Very Poor

CATEGORY 5.1) PROMINENCES
Stations Listed by longitude

5.1.1 STATION: Oslo Solar Observatory N60 E11

PROGRAM: Ground-based filtergram / spectra; spectral observations in the Ca II H line and corresponding H-alpha slit jaw pictures.

OBSERVING TIMES AND RATES: Approximately one frame 1-2 minutes

WAVELENGTHS: $\lambda\lambda 3967, 6563 \text{ \AA}$

MEASUREMENTS: Approximately 300x300 arcsec

SLIT: 1.4 arcsec

SPECTRAL DISPERSION: 10.3 mm/Å

FILM TYPE: 103-0 Kodak

IMAGE SCALE OF ORIGINAL: 7.2 arcsec per mm

QUALITY: see Table

OTHER PERTINENT INFORMATION: see Table

DATA FORMAT AVAILABLE: Original film / Prints / Microphotometry / Computer plot
Direct scientist-to-scientist

INVESTIGATOR: Dr. O. Engvold
Institute of Theoretical Astrophysics
University of Oslo
P.O. Box 1029
Blindern, Oslo 3, Norway

5.1.2 STATION: Mauna Loa, Hawaii N21 E204

PROGRAM: Ground-based filtergram / coronagraph. Cinemaphotography of prominences around the sun (full field) to a height of one radius above the solar limb.

OBSERVING TIMES AND RATES: Generally 1700-0300 UT daily (see Table). Normal cadence 5 minutes, but increased to 1 minute or 15 seconds if warranted.

WAVELENGTHS: 6563 \AA (10 Å half width)

MEASUREMENTS: Full limb

FILM TYPE: S0392

IMAGE SCALE OF ORIGINAL: 28 mm diameter solar image on 70 mm film

DATA FORMAT AVAILABLE: Prints

Direct scientist-to-scientist

INVESTIGATOR: Richard Hansen
National Center for Atmospheric Research
High Altitude Observatory
P.O. Box 1470
Boulder, Colorado USA 80302

5.1.3 STATION: Kitt Peak Observatory N32 E249

PROGRAM: Ground-based high-dispersion spectra of bright quiescent prominences taken with slit placed normal to limb at wavelengths H-alpha (6562 \AA), He D₃ (5876 \AA), Ca⁺K (3933 \AA), Ca⁺ (8542 \AA), and possibly H-beta, H-gamma, H-delta, H_δ + He (3889 \AA), Ca⁺ ($8489, 8662 \text{ \AA}$). High dispersion (5 mm/Å) photographic spectra are obtained of selected, dense, quiescent prominences. The spectra are taken with the slit placed normal to the limb and stepped across the prominence in 2.5 or 5.0 arc sec intervals.

OBSERVING TIMES AND RATES: see Table 3

MEASUREMENTS: see Table 3

SPECTRAL DISPERSION: H-alpha (.174 Å/mm); Ca⁺K (.10 Å/mm); Ca⁺ λ8542 (.30 Å/mm)

FILM TYPE: II F, III O, 1 N, 4089 image intensifier

IMAGE SCALE OF ORIGINAL: 2.5 arc sec/mm

QUALITY: see Table 3

DATA FORMAT AVAILABLE: Prints

Direct scientist-to-scientist

INVESTIGATOR: W. C. Livingston
Kitt Peak National Observatory
P.O. Box 4130
950 North Cherry Avenue
Tucson, Arizona USA 85717

CATEGORY 5.1 continued

5.1.4 STATION: Kitt Peak Observatory N32 E249
PROGRAM: Ground-based He I (10830 Å) spectra - Photoelectric spectrum scans taken in a raster pattern covering selected regions. An area of several minutes dimension is raster scanned with an aperture of 2.4 or 4.8 arc sec square. At each point in the raster a short spectrum scan is made covering the helium lines 10829 and 10830 Å. The observations are later reduced to maps of relevant physical parameters as functions of position on the sun.

OBSERVING TIMES AND RATES: see Table 3
MEASUREMENTS: see Table 3
QUALITY: see Table 3
DATA FORMAT AVAILABLE: Digitized (tape)
Direct scientist-to-scientist

INVESTIGATOR: J. Harvey
Kitt Peak National Observatory
P.O. Box 4130
950 North Cherry Avenue
Tucson, Arizona USA 85717

5.1.5 STATION: Sacramento Peak Observatory N33 E254
PROGRAM: Ground-based filtergram / 16-inch coronagraph / photographic spectra; limb prominences, graded height prominence spectra, fiducial filtergrams at $\lambda\lambda 6563, 6374, 5303$ Å. Absolute photometry of spectra.

OBSERVING TIMES AND RATES: see Table for times and number of different heights at which spectra were taken.
WAVELENGTHS: $\lambda\lambda 3550-9000$ Å
MEASUREMENTS: Field of view = 8×6 arcmin
Radius vector = 1.0
Position angle (geocentric) - see Table
SLIT: Straight slit parallel to limb
 $100\mu (2\pi) \times 24.5$ mm (480π)
SPECTRAL DISPERSION: $\lambda 3900$ (~ 1.64 Å/mm); $\lambda 5300$ (~ 2.5 Å/mm); $\lambda 6400$ (~ 5.4 Å/mm)
FILM TYPE: $\lambda\lambda 3550-6000$ Å 103-aD
 $\lambda\lambda 6000-9000$ Å 2481
IMAGE SCALE OF ORIGINAL: 20π /mm
QUALITY: see Table
OTHER PERTINENT INFORMATION: see Table
DATA FORMAT AVAILABLE: Direct scientist-to-scientist
JOPs: 4

INVESTIGATOR: William J. Wagner
Sacramento Peak Observatory
Air Force Cambridge Research Laboratories
Sunspot, New Mexico USA 88349

TABLE 5.1

PROMINENCES

Date	5.1.1 OSLO Ca II and H α UT Position	5.1.2 MAUNA LOA 6563 Å (10Å half width) UT	5.1.3 KITT PEAK High Dispersion Spectra (See Footnotes)	5.1.4 KITT PEAK He I 10830 Å UT Position	5.1.5 SAC PEAK λ 3550-9000 Å UT PA Sky Seeing ($\times 10^{-6} \theta$)
1973					
May 28		1700-0300			
29		1700-0300			
30		No Obs.			
31		1700-0300			
June 1		1700-0300			
2		No Obs.			
3		No Obs.	1-4, 8	1510-1615G S30 W90	1455-1730G 9h 243° 40 1 1455-2014FG m 243° 40 1 (Active and quiescent prominences, bright coronal [VIS] lines.)
4		1700-0300			
5		1700-0300			
6		No Obs.			
7		No Obs.			
8		1700-0300			
9		1700-0300	2323-2341 46° 8		
10	0810F N20 E90	1700-0300			
11		1700-0300			
12		1700-0300			1650-1805G 14h 69° 300 1+ 1442-1805FG m (λ6563)300 1+ (Huge arch prominences)
13		1700-0300			
14		1700-0300			
15		1700-0300			
16		1700-0300	1418-1453 90.8° 1-4 1502-1505 275.5° 1-4 1515-1525 243.7° 1-4	1541-1700 N10 W03 (active region)	
17		1700-0300			
18		No Obs.			
19		No Obs.			
20		1700-0300			
21		1700-0300			
22		No Obs.			
23		1700-0300			
24		1700-0300			
25		1700-0300			
26		No Obs.			

See page 92 for Footnotes.

TABLE 5.1 (continued)

PROMINENCES

Date	5.1.1 OSLO Ca II and He UT Position	5.1.2 MAUNA LOA 6563 Å (10Å half width) UT	5.1.3 KITT PEAK High Dispersion Spectra UT PA λ Key (See Footnotes)	5.1.4 KITT PEAK He I 10830 Å UT Position	5.1.5 SAC PEAK λ 3550-9000 Å UT PA Sky Seeing (x10 ⁻⁶ B _⊙)
1973					
27		1700-0300			
28		1700-0300			
29		1700-0300			
30		No. Obs.			
July					
1		1700-0200			
2		1700-0300			
3		1700-0300			
4		1700-0300			
5		1700-0300			
6		1700-0300			
7		1700-0300			
8		1700-0300			
9		1700-0300			
10		1700-0300			
11		1700-0300			
12		1700-0300			
13		1700-0300			
14		No Obs.			
15		No Obs.			0004-0023F 7h 125° 150 1- (Small vertical prominence, shows few weak lines.)
16		1700-0300			
17		1700-0300			
18		1700-0300			
19		1700-0300			
20		1700-0300			
21		1700-0300			
22		1700-0300			
23		No Obs.			
24		1700-0300			
25		1700-0300			
26		1700-0300			
27		1700-0300	2255C 253° 1,3 2354C 249° 1,3		
28		1700-0300			
29		1700-0300			
30		1700-0300			
31		1700-0300			
Aug					
1		1700-0300			
2		1700-0300			
3		1700-0300			
4		1700-0300			
5		1700-0300			

See page 92 for Footnotes.

TABLE 5.1 (continued)

PROMINENCES

Date	5.1.1 OSLO Ca II and H α		5.1.2 MAUNA LOA 6563 Å (10Å half width)		5.1.3 KITT PEAK High Dispersion Spectra (See Footnotes)		5.1.4 KITT PEAK He I 10830 Å		5.1.5 SAC PEAK $\lambda\lambda$ 3550-9000 Å	
	UT	Position	UT	PA	UT	PA	UT	Position	UT	PA Sky Seeing ($\times 10^{-6} B_0$)
1973										
Aug 6			1700-0300		1420G	225°				
7			1700-0300		1500G	120°				
8			1700-0300		1520G	113°				
9			No Obs.							
10										
11			No Obs.							
12			1700-0300							
13			1700-0300		1420-#	243°				
14			1700-0300		1420-#	243°	1-7,9,10			
15			1700-0300		1530-1600	280°	1-7,9,10			
16			1700-0300		1530C	280°	1,3			
17			1700-0300							
18			1700-0300							
19			No Obs.							
20			No Obs.							
21			1700-0300					1815-1855G	N14 E02 ch	1820-1839FC 1h 29E° 95
22			No Obs.							
23			No Obs.					1755GF	S30 E50 f	
24			1700-0300					1723GF	N12 W13 ch	
25			1700-0300					2228GF	N12 W13 ch	
26			1700-0300							
27			1700-0300							
28			No Obs.							
29			1700-0300		1615-1630G	241°	1-4,8,9,11			
30			1700-0300		1615 #	242°	1-4,9			
31			1700-0300							2208-2310F 4h 266° 25 1632-1731F 4h 265° 56 (rather dense prominence, showing continuum.)
Sept 1			1700-0300							1551-1618G 7h 268° 65 (Quiescent prominence showing continuum.)
2			No Obs.		1540-1720F	255°, 76°	1-5,7,9,10			
3			1700-0300		1540	255°	1-5,7,9,10			
4			1700-0300		1720	76°	1-5,7,9,10			
5			1700-0300							

See page 92 for Footnotes.

TABLE 5.1 (continued)

PROMINENCES

Date	5.1.1 OSLO Ca II and H α		5.1.2 MAUNA LOA 6563 Å (10Å half width)		5.1.3 KITT PEAK High Dispersion Spectra			5.1.4 KITT PEAK He I 10830 Å		5.1.5 SAC PEAK $\lambda\lambda$ 3550-9000 Å		
	UT	Position	UT		UT	PA	λ key (See Footnotes)	UT	Position	UT	PA	Sky Seeing ($\times 10^{-6}\theta$)
1973												
Oct 9			1700-0300									
10			No Obs.									
11			No Obs.									
12			1700-0300									
13			1700-0300									
14			1700-0300									
15			1700-0300									
16			No Obs.									
17			1700-0300									
18			1700-0300									
19			1700-0300									
20			No Obs.									
21			No Obs.									
22			1700-0300									
23			1700-0300									
24			No Obs.									
25			1700-0300									
26			1700-0300									
27			1700-0300									
28			1700-0300									
29			1700-0300									
30			No Obs.									
31			No Obs.									
Nov 1			1700-0300									
2			1700-0300									
3			1700-0300									
4			No Obs.									
5			No Obs.									
6			1700-0300									
7			1700-0300									
8			No Obs.									
9			No Obs.									
10			No Obs.									
11			1700-0300									
12			No Obs.									
13			No Obs.									

See page 92 for Footnotes.

TABLE 5.1 (continued)

PROMINENCES

Date	5.1.1 OSLO Ca II and H α UT Position	5.1.2 MAUNA LOA 6563 Å (10Å half width) UT	5.1.3 KITT PEAK High Dispersion Spectra UT PA λ Key (See Footnotes)	5.1.4 KITT PEAK He I 10830 Å UT Position	5.1.5 SAC PEAK λλ 3550-9000 Å UT PA Sky Seeing (x10 ⁻⁶ B ₀)
1973					
Nov 14		No Obs. 1700-0300			
15					
16		1700-0300			
17		1700-0300			
18		No Obs.			
19		No Obs.			
20		No Obs.			
21		No Obs.			
22		No Obs.			
23		No Obs.			
24		1700-0300			
25		1700-0300			
26		No Obs.			
27		No Obs.			
28		No Obs.			
29		No Obs.			
30		No Obs.			
Dec 1		No Obs.	1605W 303° 1655W 274° 1752W 296°		1530-1630E 15h 318° 15 2 (Large quiescent prominence shows continuum in green region. P35 in NOAA #s.)
2		No Obs.	1-3,6,7 1-3,6,7 1-3,6,7		1615-1730G 11h 333° 31 2 (Bright, dense quiescent (P37 in NOAA #s), may have continuum in blue λ's. 1617-1730E 13h 328° 30 1+ (Tall dense prominence (P37), con- tinuum throughout visible spectrum)
3		1700-0300			
4		1700-0300			
5		1700-0300			2013-2103G 4h 301° 15 1- 2013-2103G 7h 331° 15 1- (2 prominences, continuum λλ 4387, 4686 at 301°, less at 331°.)
6		1700-3000			
7		1700-0300			
8		No Obs.			
9		1700-0300	1555 69° 1708 262° 1730 \$ 255°		
10		No Obs.			
11		No Obs.			
12		1700-0300			

See page 92 for Footnotes.

TABLE 5.1 (continued)

PROMINENCES

Date	5.1.1 OSLO Ca II and H α UT Position	5.1.2 MAUNA LOA 6563 Å (10Å half width) UT	5.1.3 KITT PEAK High Dispersion Spectra UT PA λ Key (See Footnotes)	5.1.4 KITT PEAK He I 10830 Å UT Position	5.1.5 SAC PEAK $\lambda\lambda$ 3550-9000 Å UT PA Sky Seeing ($\times 10^{-6}\beta_0$)
1973					
13		1700-0300			
14		1700-3000			
15		1700-0300			
16		1700-0300			
17		1700-0300			
18		1700-0300	1800 \$\$ $\sim 30^\circ$ 1-3		1530-1644F 12h 65° 170 (Huge prominence, very few weak lines.) 1
19		1700-0300			
20		1700-0300			
21		1700-0300			
22		1700-0300			
23		1700-0300			
24		No Obs.			
25		1700-0300			
26		1700-0300			
27		1700-0300			
28		1700-0300			
29		No Obs.			
30		No Obs.			
31		No Obs.			
1974					
Jan 1		1700-0300			1517-1640GE 14h 286° 50 1+ (Tall dense prominence showed) (continuum weak He lines.)
2		1700-0300			
3		1700-0300			
4		No Obs.			
5		No Obs.			
6		1700-0300			
7		No Obs.			
8		1700-0300			
9		No Obs.			
10		1700-0300			
11		1700-0300			
12		1700-0300			2007-2122GE 11h 58° 15 1 (Coronal and prominence lines, $\lambda\lambda$ 4686, 7281, 4387, trace of continuum)
13		1700-0300			
14		1700-0300			1720-1828FG 7h 44° 14 1
15		No Obs.			1536-1904P 5h 278° 16 1 (Post-flare loops. Coronal line pro- gram run - $\lambda\lambda$ 4686, 4471, 4387, 4713, weak 5303.)

See page 92 for Footnotes.

TABLE 5.1 (continued)

PROMINENCES

Date	5.1.1 OSLO Ca II and H α UT Position	5.1.2 MAUNA LOA 6563 Å (10Å half width) UT	5.1.3 KITT PEAK High Dispersion Spectra UT PA λ Key (See Footnotes)	5.1.4 KITT PEAK He I 10830 Å UT Position	5.1.5 SAC PEAK λλ 3550-9000 Å UT PA Sky Seeing (x10 ⁻⁶ B ₀)
1974					
Jan 16		1700-0300			
17		1700-0300			
18		1700-0300			
19		1700-0300			
20		1700-0300			
21		No Obs.			
22		1700-0300			
23		1700-0300			
24		1700-0300			
25		1700-0300			
26		1700-0300			
27		1700-0300			
28		No Obs.			
29		1700-0300			
30		1700-0300			
31		1700-0300			
Feb 1		1700-0300			1701-1800E 10h 48' 15" 1 1930-2030E 10h 48' 15" 1 (Very dense prominence, visual continuum. Very rich in weak lines in early run, continuum in entire visible region.)
2		1700-0300			1648-1725P 6h 44' 50" 1 (Very low prominence.)
3		1700-0300			
4		1700-0300			
5		1700-0300			
6		1700-0300			
7		1700-0300			
8		1700-0300			
9		No Obs.			
10		No Obs.			
11		No Obs.			
12		No Obs.			
13		No Obs.			
14		1700-0300			
15		1700-0300			
16		1700-0300			
17		1700-0300			
18		1700-0300			
19		1700-0300			
20		1700-0300			

See page 92 for Footnotes.

TABLE 5.1 (continued)

PROMINENCES

Date	5.1.1 OSLO Ca II and H α		5.1.2 MAUNA LOA 6563 Å (10A half width)		5.1.3 KITT PEAK High Dispersion Spectra		5.1.4 KITT PEAK He I 10830 Å		5.1.5 SAC PEAK $\lambda\lambda$ 3550-9000 Å			
	UT	Position	UT	UT	UT	PA	λ Key (See Footnotes)	UT	Position	UT	PA	SKY Seeing ($\times 10^{-6} \theta$)
1974												
Feb 21			1700-0300									
22			1700-0300									
23			1700-0300									
24			1700-0300									
25			1700-0300									
26			1700-0300									
27			1700-0300									
28			1700-0300									
Mar 1			1700-0300									
2			1700-0300									
3			No Obs.									
4			No Obs.									
5			No Obs.									
6			1700-0300									
7			1700-0300									
8			1700-0300									
9			1700-0300									
10			No Obs.									

Footnotes:

= Observed by A. Bean on ATM; also have magnetogram of prominence.

= ATM object.

\$ = Magnetogram also

\$\$ = Large prominence that erupted.

% = Active prominence possibly connected with coronal transient.

m = Movies

h = Number of different heights

(a) = Also Ca II λ 8542 Å

(b) = Ca II K λ 3934 Å

(c) = $\lambda\lambda$ 10830, 8542, 3934 Å

ch = Coronal hole

CS = Center of the sun

F = Filament

Seeing Conditions:

C = Cloudy

E = Excellent

F = Fair

FC = Fair to Cloudy

FG = Fair to Good

G = Good

GE = Good to Excellent

P = Poor

VG = Very Good

W = Windy

5.1.3

Key to Wavelengths:

- 1 = H α (6563 Å)
- 2 = He D $_3$ (5876 Å)
- 3 = Ca⁺ K (3933 Å)
- 4 = Ca⁺ (8542 Å)
- 5 = H β
- 6 = H γ
- 7 = H δ
- 8 = H ϵ + He (3889 Å)
- 9 = Ca⁺ (8498 Å)
- 10 = Ca⁺ (8662 Å)
- 11 = He I (10830 Å)

CATEGORY 6.1) SOLAR RADIO OBSERVATIONS
Stations Listed by Longitude

6.1.1 STATION: Meudon Observatory, Nançay, France N44 E02
PROGRAM: Ground-based 408 and 169 MHz East-West Interferometer. Scale of flux is arbitrary. Shows sources of noise storms (408, 169 MHz) and sources of the slowly varying component (3 cm, 408 MHz, 169 MHz)

OBSERVING TIMES AND RATES: 1030-1300 UT; 1 picture every 4 minutes
DATA FORMAT AVAILABLE: Recording on paper

INVESTIGATOR: Dr. M. Pick
D.A.S.O.P.
Radioastronomie
Observatoire de Paris
92190 Meudon, France

6.1.2 STATION: Dwingeloo Radio Observatory N52 E06
PROGRAM: Ground-based spectra and polarization; 60-channels dynamic spectra, intensity and polarization, for 200-213 MHz, 234-246 MHz, and 282-315 MHz. Resolution: 1 MHz, 0.02 seconds; Range: 15 dB over the quiet sun level, calibrated; Threshold: 1 flux unit (10^{-22} W/m²Hz).

OBSERVING TIMES AND RATES: 0700-1600 UT, occasionally local sunrise-sunset during selected periods.

MEASUREMENTS: Full disk
QUALITY (NOISE LEVEL): 1 flux unit
DATA FORMAT AVAILABLE: Prints

INVESTIGATOR: C. Slottje
Solar Radio Observatory
Netherlands Foundation for Radioastronomy
Dwingeloo, Netherlands

6.1.3 STATION: Crimean Astrophysical Observatory N44 E34
PROGRAM: Ground-based solar radio observations on 1.9, 2.5, and 3.5 cm. Intensity and polarization measurements; also, total flux observations on 10 cm.

OBSERVING TIMES: see Table
MEASUREMENTS: angular resolutions are 3.5 to 6.0 arcmin. For positions, see Table

INVESTIGATOR: Professor A. B. Severny
Crimean Astrophysical Observatory
P/O Nauchny, Crimea, 334413 USSR

CATEGORY 6.1 continued

6.1.4 STATION: Toyokawa Observatory N35 E137
PROGRAM: Ground-based radio scans and total flux
3.2 and 8 cm radio strip scans:

A precise observation is made around local noon (0250 UT average) with 1.1' fan-beam interferometers. Data are punched on a paper tape, processed by a computer, and displayed as corrected scan curves. Two curves corresponding to two frequencies are drawn on a common sheet, but the scale of brightness for 3.2 cm is compressed to a half of that for 8 cm.

Scan curves are taken for each 2 hours before and after local noon. Scans for 3.2 cm are made every 3 minutes by a simple drift of the sun, but scans for 8 cm are made every 10 seconds by a swept-lobe scheme.

A drift scan curve of 0.4 minutes resolution for 8 cm (sometimes also for 3.2 cm) is available when a strong isolated region exists on the sun.

Processed daily scan curves will be sent to WDC-A for the ATM intervals, but other information can be supplied on request.

Total flux observations on 3.2, 8, 15, and 30 cm:

Observations are made on a routine basis. Daily flux values, event tables, and also intensity-time profiles of outstanding events will be sent to WDC-A.

OBSERVING TIMES AND RATES: Radio scans: 0050-0450 UT
Total flux: 2200-0800 UT

MEASUREMENTS: Full disk

DATA FORMAT AVAILABLE: Tabulation / Strip charts
Direct scientist-to-scientist and to World Data Centers

INVESTIGATOR: H. Tanaka, Director
Toyokawa Observatory
Nagoya University
Toyokawa, 442 Japan

Also: S. Enome, M. Ishiguro

6.1.5 STATION: Clark Lake Radio Observatory N33 E244
PROGRAM: Ground-based perpendicular fan beam multi-frequency radio observations.
Angular resolution 3 to 15 arc minutes; 15 to 2.5 m observations.

OBSERVING TIMES AND RATES; 2 sweeps/second 20-120 MHz (see Table 4 for observing times)

MEASUREMENTS: Full disk

SPECTRAL DISPERSION: 7×10^8 Å/mm

DATA FORMAT AVAILABLE: Prints
Direct scientist-to-scientist

JOPs: 3, 6, 8, 9

INVESTIGATOR: Prof. M. R. Kundu
Astronomy Program
University of Maryland
College Park, Maryland USA 20742

CATEGORY 6.1 continued

- 6.1.6 STATION: University of Colorado Radio Astronomy Observatory N40 E255
PROGRAM: Ground-based dynamic radio spectra (interferometric, swept-frequency radio spectrograph); 37.5 m to 3.75 m (8-80 MHz) continuously swept coverage. Occasional special Jupiter tracks during daylight hours have been suspended to support the SKYLAB mission. Real-time spectral data are provided to the Space Environment Services Center of NOAA by means of a remote facsimile machine located at the Forecast Center.

OBSERVING TIMES AND RATES: Sunrise to sunset (local) daily during manned ATM periods (see Table 4 for Off Times)

MEASUREMENTS: Full disk
SPECTRAL DISPERSION: 1.35 m/mm
FILM TYPE: Kodak Plus-X, 35 mm, Type PX 417
IMAGE SCALE OF ORIGINAL: 2.88 MHz/mm average on frequency (transverse) axis;
27.3 sec/mm on time (longitudinal) axis
QUALITY: Normal sky noise unless otherwise noted
DATA FORMAT AVAILABLE: Duplicate negatives / Prints
Scientist-to-scientist and to World Data Centers

INVESTIGATOR: James W. Warwick
Department of Astro-Geophysics
University of Colorado
Boulder, Colorado USA 80302

Also: James C. Dodge

- 6.1.7 STATION: Harvard Radio Astronomy Station, Fort Davis, Texas N30 E257
PROGRAM: Summaries of solar radio bursts recorded in the frequency range 10-4000 MHz. The equipment used at the Station has been described by Thompson (Ap. J., 133, 643, 1961) and by Maxwell (Solar Phys., 16, 224, 1971). At 100 MHz the intensity ranges listed as 1, 2, and 3 correspond approximately to 5-50, 50-500, and $> 500 \times 10^{-22} \text{Wm}^{-2} \text{Hz}^{-1}$.

OBSERVING TIMES AND RATES: continuous sunrise to sunset observations
MEASUREMENTS: Full disk

INVESTIGATOR: Alan Maxwell
Harvard Radio Astronomy Station
Fort Davis, Texas USA 79734

- 6.1.8 STATION: Applied Physics Laboratory, Johns Hopkins University N39 E283
PROGRAM: Swept frequency measurements are made in the frequency range of 565-1000 MHz at a rate of 100 times per second. An instrumental description has been given by Gotwols and Phipps (Solar Phys., 26, 386, 1972). The dynamic spectrum is recorded both on magnetic tape and continuously moving film traveling at 0.8 in min^{-1} . This rate of film travel will allow only 0.2 s to be resolved. The films are inspected for significant events and the corresponding magnetic tapes are permanently saved. All magnetic tapes containing bursts are replayed and rephotographed at an increased film transport rate (14.8 in min^{-1}). This transport rate permits each sweep of the received to be resolved on the film.

The intensity ranges listed as 1, 2, and 3 correspond approximately to 25-65, 65-650, and $> 650 \times 10^{-22} \text{Wm}^{-2} \text{Hz}^{-1}$. The times of observations are listed, but breaks shorter than two minutes are not tabulated. The spectral type follows the notation given in *Solar-Geophysical Data*, Descriptive Text, February 1973. However, Arabic rather than Roman numerals are used. In addition, intermediate drift bursts ($\dot{\nu} = 30-100 \text{ MHz/sec}$) are designated as type 6.

Copies of the spectra may be obtained from B. L. Gotwols.

INVESTIGATOR: B. L. Gotwols
The Johns Hopkins University
Applied Physics Laboratory
8621 Georgia Avenue
Silver Spring, Maryland USA 20910

Table 6.1

SOLAR RADIO OBSERVATIONS

DATE	6.1.1		6.1.2		6.1.3		6.1.4		6.1.5		6.1.6		6.1.7		6.1.8	
	NANÇAY 9400 (3cm), 408 and 169 MHz (UT)	DWINGELOO 200-213 MHz 234-246 MHz 282-315 MHz (UT)	CRIMEA Intensity and Circular Polarization 1.9, 2.5, 3.5 cm 3.5 x 6.0 arcmin (UT) Position	CRIMEA Total Flux 10 cm (UT)	RADIO SCANS 3.2, 8 cm (UT)	TOYOAKAWA TOTAL FLUX 3.2, 8, 15, 30 cm (UT)	CLARK LAKE (20 MHz- 120 MHz) 15-2.5m (UT)	UNIV. OF COLORADO 8-80 MHz (37.5-3.75m) (UT)	HARVARD 10 MHz- 4000 MHz (UT)	APPLIED PHYSICS LAB 565 MHz- 1000 MHz (UT)						
1973																
May 28	1030-1300	0700-1600		Daily Obs.	0050-0450	2200-0800	1600-2400	Sunrise-Sunset 1615-1619 OT	Sunrise-Sunset	1224-1929						
29	"	"		"	"	"	1600-2400	0014-0028 OT	"	1638-1956						
30	"	"		"	"	"	1600-2400	2330-2400 \$	"	1206-1957						
31	"	"		"	"	"	1600-2400	0234-1130 \$ 1616-1705 OT 1909-2323 \$	"							
Jun 1	"	"	0900 1050 1259	"	"	"	1600-2400	Sunrise-Sunset	"	1157-1955						
2	"	"	CS	"	"	"	1600-2400	"	"							
3	"	"	N15M62	"	"	"	0314-0402	"	"							
4	"	"	CS	"	"	"	0414-0502	1341-1349 OT	"	1231-1906 1234-1453 1459-1751 1822-2019						
5	"	"		"	"	"	1512-0208NA	Sunrise-Sunset	"							
6	"	"	0739 0818 0912 1045 1059 0830 1004	"	"	"	1351-0218NA	1616-1617 OTδ 1627-1627 OTδ 1810-1812 OTδ 1813-1815 OTδ	"							
7	"	"	S12M38	"	"	"	1400-2236NA	" ts	"	1231-1926 1156-1918						
8	"	"	S12M38	"	"	"	1603-0218NA	" "	"							
9	"	"	CS	"	"	"	1511-0218**	" "	"							
10	"	"	S12M40	"	"	"	1420-0218NA	" "	"							
11	"	"	S12M55	"	"	"	1518-0218NA	0139-0210 OTδ	"	1219-1955						
12	"	"	CS	"	"	"	1612-0218NA	1130-1205 %	"	1245-1516 1523-2000 2004-2047						
13	"	"		"	"	"	1518-0208	Sunrise-Sunset ts	"	1201-1950*						
14	"	"		"	"	"	1435-0209	" ts	"	1201-1432 1503-1953 1208-1954*						
15	"	"		"	"	"	1445-0218	2051-2142 OT	"							
16	"	"		"	"	"		0800-2400 %	"	1224-1535* 1539-1926*						
17	"	"		"	"	"	1540-0218	0000-1130 %	"	1203-1926						
18	"	"		"	"	"		Sunrise-Sunset	"	1220-1440						
19	"	"		"	"	"		" "	"	1510-1952						
20	"	"		"	"	"		" "	"							
21	"	"		"	"	"		" "	"							
22	"	"		"	"	"		0900-1600 %	"	1226-1507 1510-1952						
23	"	"		"	"	"		" "	"	1159-1930						
24	"	"		"	"	"		" "	"	1238-1852						
25	"	"		"	"	"		" "	"	1214-1356 1433-1746						
26	"	"		"	"	"		" "	"							
27	"	"		"	"	"		" "	"	1858-1920*						
28	"	"		"	"	"		" "	"	1202-1819*						
29	"	"		"	"	"		" "	"	1895-1931*						
30	"	"		"	"	"		" "	"	1214-1918*						

See page 100 for Footnotes.

Table 6.1 continued

DATE	6.1.1.1		6.1.1.2		6.1.1.3		6.1.1.4		6.1.1.5		6.1.1.6		6.1.1.7		6.1.1.8	
	NAVCAY 9400 (3cm), 468 and 169 MHz (UT)	DMITRIELOO 200-213 MIZ 234-246 MIZ 282-315 MIZ (UT)	CRIMEA Intensity and Circular Polarization 1.9, 2.5, 3.5 cm 3.5 x 6.0 arcmin (UT)	CRIMEA Total Flux 10 cm (UT)	RADIO SCANS 3.2, 8 cm (UT)	IOYOKAWA TOTAL FLUX 3.2, 8, 15, 30 cm (UT)	CLARK LAKE (20 MHz- 120 MHz) 15-2.5m (UT)	UNIV. OF COLORADO 8-80 MHz (37.5-3.75m) (UT)	HARVARD 10 MHz- 4000 MHz (UT)	APPLIED PHYSICS LAB 565 MHz- 1000 MHz (UT)						
Jul 1	1030-1300	0700-1600		Daily Obs		2200-0800							Sunrise- Sunset			1210-1925 1238-1530 1600-1953
2	"	"		"		"							"			"
3	"	"		"		"							"			"
4	"	"		"		"							"			"
5	"	"		"		"							"			"
6	"	"		"		"							"			1155-1920
7	"	"		"		"							"			1229-1449
8	"	"		"		"							"			1456-1930
9	"	"		"		"							"			1217-1930
10	"	"		"		"							"			1211-1752 1820-1938
11	"	"		"		"							"			"
12	"	"		"		"							"			1154-1251 1307-1432
13	"	"		"		"							"			1502-1805
14	"	"		"		"							"			1832-1916
15	"	"		"		"							"			1938-1954
16	"	"		"		"							"			1156-1918 1139-1845 1131-1849
17	"	"		"		"							"			1243-1334
18	"	"		"		"							"			1357-1649
19	"	"		"		"							"			1809-1947
20	"	"		"		"							"			"
21	"	"		"		"							"			1129-1725
22	"	"		"		"							"			1126-1237
23	"	"		"		"							"			1250-1855
24	"	"		"		"							"			1226-1314
25	"	"		"		"							"			1352-1544 1547-1731 1825-2000
26	"	"		"		"							"			1209-1458
27	"	"		"		"							"			"
28	"	"		"		"							"			"
29	"	"		"		"							"			1128-1856
30	"	"		"		"							"			1219-1600 1656-1726 1751-1829
31	"	"		"		"							"			1901-1955

See page 100 for Footnotes.

Table 6.1 continued

DATE	6.1.1.1		6.1.2		6.1.3		6.1.4		6.1.5		6.1.6		6.1.7		6.1.8	
	HANCAV 9400 (3cm), 408 and 169 MHz (UT)	1030-1300	0700-1600	CRIMEA Intensity and Circular Polarization 1.9, 2.5, 3.5 cm 3.5 x 6.0 arcmin Position (UT)	CRIMEA Total Flux 10 cm (UT)	RADIO SCANS 3.2, 8 cm (UT)	OTOKAWA TOTAL FLUX 3.2, 8, 15, 30 cm (UT)	CLARK LAKE (20 MHz- 120 MHz) 15-2.5m (UT)	UTV. OF COLORADO 8-80 MHz (37.5-3.75m) (UT)	HARVARD 10 MHz- 4000 MHz (UT)	APPLIED PHYSICS LAB 565 MHz- 1000 MHz (UT)					
Aug 1							2200-0800		Sunrise-Sunset\$	Sunrise-Sunset\$						
2	"	"	"			"	"		"	\$						
3	"	"	"			"	"		"	ts						
4	"	"	"			"	"		"	\$						
5	"	"	"			"	"		2100-2400 OTts\$	Sunrise-Sunset\$						
6	"	"	"			"	"		Sunrise-2100 \$							
7	"	"	"			"	"		Sunrise-Sunset							
8	"	"	"			"	"		"							
9	"	"	"			"	"		"							
10	"	"	"			"	"		"							
11	"	"	"			"	"		"							
12	"	"	"			"	"		"							
13	"	"	"			"	"		"							
14	"	"	"			"	"		"							
15	"	"	"			"	"		"							
16	"	"	"			"	"		"							
17	"	"	"			"	"		"							
18	"	"	"			"	"		"							
19	"	"	"			"	"		"							
20	"	"	"			"	"		"							
21	"	"	"			"	"		"							
22	"	"	"			"	"		"							
23	"	"	"			"	"		"							
24	"	"	"			"	"		"							
25	"	"	"			"	"		"							

See page 100 for Footnotes.

Table 6.1 continued

DATE	6.1.1		6.1.2		6.1.3		6.1.4		6.1.5		6.1.6		6.1.7		6.1.8	
	WANGAY 9400 (3cm), 408 and 169 MHz (UT)	1030-1300	DWINGELOO 200-213 MHz 234-246 MHz 282-315 MHz (UT)	0700-1600	CRIMEA Intensity and Circular Polarization 1.9, 2.5, 3.5 cm 3.5 x 6.0 arcmin (UT)	CRIMEA Total Flux 10 cm (UT)	RADIO SCANS 3.2, 8 cm (UT)	TOYOYAMA TOTAL FLUX 3.2, 8, 15, 30 cm (UT)	CLARK LAKE (20 MHz- 120 MHz) 15-2.5m (UT)	UNIV. OF COLORADO 8-80 MHz (37.5-3.75m) (UT)	Sunrise-Sunset (UT)	HARVARD 10 MHz- 4000 MHz (UT)	APPLIED PHYSICS LAB 565 MHz- 1000 MHz (UT)			
Aug 26	"	"	"	"	"	"	"	"	"	"	"	"	"			
27	"	"	"	"	"	"	"	"	"	"	"	"	"			
28	"	"	"	"	"	"	"	"	"	"	"	"	"			
29	"	"	"	"	"	"	"	"	"	"	"	"	"			
30	"	"	"	"	"	"	"	"	"	"	"	"	"			
31	"	"	"	"	"	"	"	"	"	"	"	"	"			
Sept 1	"	"	"	"	"	"	"	"	"	"	"	"	"			
2	"	"	"	"	"	"	"	"	"	"	"	"	"			
3	"	"	"	"	"	"	"	"	"	"	"	"	"			
4	"	"	"	"	"	"	"	"	"	"	"	"	"			
5	"	"	"	"	"	"	"	"	"	"	"	"	"			
6	"	"	"	"	"	"	"	"	"	"	"	"	"			
7	"	"	"	"	"	"	"	"	"	"	"	"	"			
8	"	"	"	"	"	"	"	"	"	"	"	"	"			
9	"	"	"	"	"	"	"	"	"	"	"	"	"			
10	"	"	"	"	"	"	"	"	"	"	"	"	"			
11	"	"	"	"	"	"	"	"	"	"	"	"	"			
12	"	"	"	"	"	"	"	"	"	"	"	"	"			
13	"	"	"	"	"	"	"	"	"	"	"	"	"			
14	"	"	"	"	"	"	"	"	"	"	"	"	"			
15	"	"	"	"	"	"	"	"	"	"	"	"	"			
16	"	"	"	"	"	"	"	"	"	"	"	"	"			
17	"	"	"	"	"	"	"	"	"	"	"	"	"			
18	"	"	"	"	"	"	"	"	"	"	"	"	"			
19	"	"	"	"	"	"	"	"	"	"	"	"	"			
20	"	"	"	"	"	"	"	"	"	"	"	"	"			
21	"	"	"	"	"	"	"	"	"	"	"	"	"			
22	"	"	"	"	"	"	"	"	"	"	"	"	"			
23	"	"	"	"	"	"	"	"	"	"	"	"	"			
24	"	"	"	"	"	"	"	"	"	"	"	"	"			

See page 100 for Footnotes.

Table 6.1 continued

DATE	6.1.1.1		6.1.2		6.1.3		6.1.4		6.1.5	6.1.6	6.1.7	6.1.8
	NANICAY 9400 (3cm), 408 and 169 MHz (UT)	1030-1300 (UT)	DWINGELLOO 200-213 MHz 234-246 MHz 282-315 MHz (UT)	CRIMEA Intensity and Circular Polarization 1.9, 2.5, 3.5 cm 3.5 x 6.0 arcmin Position (UT)	CRIMEA Total Flux 10 cm (UT)	RADIO SCANS 3.2, 8 cm (UT)	TOYOKAWA TOTAL FLUX 3.2, 8, 15, 30 cm (UT)	CLARK LAKE (20 MHz- 120 MHz) 15-2.5m (UT)	UNIV. OF COLORADO 8-80 MHz (37.5-3.75m) (UT)	HARVARD 10 MHz- 4000 MHz (UT)	APPLIED PHYSICS LAB 565 MHz- 1000 MHz (UT)	
1973												
Sept 25												
26	"	"	"			"	"		"	"		
27	"	"	"			"	"		"	"		
28	"	"	"			"	"		"	"		
29	"	"	"			"	"		"	"		
30	"	"	"			"	"		"	"		
Oct 1	"	"	"			"	"		"	"		1242-1404
2	"	"	"			"	"		"	"		
3	"	"	"			"	"		"	"		
4	"	"	"			"	"		"	"		
5	"	"	"			"	"		"	"		1502-1846 1850-1946
6	"	"	"			"	"		"	"		
7	"	"	"			"	"		"	"		
8	"	"	"			"	"		"	"		
9	"	"	"			"	"		"	"		
10	"	"	"			"	"		"	"		
11	"	"	"			"	"		"	"		For additional data see Table in Section V page 151.
12	"	"	"			"	"		"	"		

Footnotes:

6.1.3

CS = center of the sun, intensity only

6.1.6

NA = No Activity
 01 = Off Time
 ** = 0054-0058 numerous III's
 * = bursts
 ts = thunderstorm activity
 \$ = tracking problems
 % = 5 min. markers incorrect
 δ = 40-80 MHz

NOTE: Similar observations continue through February, 1974, in Categories 6.1.1, 6.1.2, 6.1.4 and 6.1.7.
 Sunrise to sunset observations were made November 16, 1973 - February 8, 1974 in Category 6.1.6.

CATEGORY 7.1) X-RAY AND SFD MEASUREMENTS

7.1.1 STATION: SOLRAD 9 and 10
PROGRAM: Satellite ionization chamber measurements of solar X-ray emission at 0.5-3 Å, 1-5 Å, 1-8 Å, 8-20 Å, and 1-20 Å

OBSERVING TIMES AND RATES: see *Solar-Geophysical Data*, Descriptive Text, February 1973

MEASUREMENTS: Full disk

DATA FORMAT AVAILABLE: Tabulation for specified time intervals / computer plots

INVESTIGATOR: Robert W. Kreplin
Naval Research Laboratory, Code 7125
Washington, D. C. USA 20375

7.1.2 STATION: Sacramento Peak Observatory
PROGRAM: Ground-based SFD measurements of impulsive 10-1030 Å flux enhancements from solar flares. Observing SFDs (Sudden Frequency Deviations) at Sac Peak on the 5, 10, and 15 MHz signals from WWV and computing the 10-1030 Å energy flux enhancement of solar flares from the SFD data.

OBSERVING TIMES AND RATES: Continuous

MEASUREMENTS: Full disk

QUALITY: Fair

DATA FORMAT AVAILABLE: Digitized (card / tape) / Computer plot / Tabulation to World Data Centers

INVESTIGATOR: Richard F. Donnelly
NOAA Space Environment Lab.
Boulder, Colorado USA 80302

Note: SFD data results from Sacramento Peak Observatory; Boulder, Colorado; Leicester, England; Huntsville, Alabama; and Hawaii are available in *Report UAG-36, "An Atlas of Extreme Ultraviolet Flashes of Solar Flares Observed Via Sudden Frequency Deviations during the ATM-SKYLAB Missions."*

III. DESCRIPTIVE PROGRAM INFORMATION SUBMITTED WITHOUT OBSERVING TIME DATA

Big Bear Solar Observatory:

- a.) Full disk white light pictures every 30 minutes.
- b.) Spectra are taken from time to time as well.
- c.) Some filtergrams in $\lambda 10830$ are also planned.

Pasadena: H-alpha cinematograms of about 2/3 of the disk are taken with a 5-inch telescope when Big Bear is cloudy and Pasadena is clear.

INVESTIGATOR: Harold Zirin
California Institute of Technology
354-33
Pasadena, California USA 91109

Sacramento Peak:

Studies of the Physical Properties of Chromospheric Plages by Means of their He I and Ca II Spectra.

In this coordinated observing program observations will be obtained in the He I 584, 537, and 591 Å lines and continuum by the HCO Spectrometer on ATM simultaneous with ground-based observations at Sacramento Peak Observatory of the He I 5876 and 10830 Å lines and several lines of Ca II. These observations will be of rasters centered on chromospheric plages and quiet regions and possibly on quiescent prominences off the limb. The purposes of this program are to understand the mechanism by which the He I spectrum is excited in these structures and to use the He I and Ca II spectra to determine the physical properties of these structures.

INVESTIGATOR: Jeffrey L. Linsky
Joint Institute for Laboratory Astrophysics
University of Colorado
Boulder, Colorado USA 80302

The University of Chicago:

Two rocket experiments will be launched in late August and late November to observe X-ray spectra of active region features with spectral resolving power in the range 1000 to 5000 and spatial resolution of ten arc seconds. The wavelength range from 5 to 25 Å will be covered with calibrated crystal spectrometers.

INVESTIGATOR: Richard L. Blake
The University of Chicago
Department of Astronomy and Astrophysics
1100-14 East 58th Street
Chicago, Illinois USA 60637

Near Infrared Photography of the Outer Corona during 1973 Solar Eclipse:
Site: Loiyengalani, Kenya

The objective of this experiment is to record the total brightness, structural details and polarization of the outer coronal features ($2.5 R_{\odot}$ to $20 R_{\odot}$) at the 1973 Solar Eclipse. Functionally, these observations are carried out with a 200 mm f/2.9 Dallmeyer lens and the following complimentary equipment:

- 1.) External occulting disk 1.5 m in front of the objective that
 - a.) completely occults the bright inner corona ($1.0 R_{\odot}$ to $2.0 R_{\odot}$),
 - and b.) vignets the intermediate corona ($2.0 R_{\odot}$ to $10.0 R_{\odot}$).
- 2.) Wratten 87 and HR polaroids ($P_1, P_2, P_3, \Delta\theta = 60^\circ$) that transmit only Near Infrared ($\lambda > 7500 \text{ \AA}$) thereby filtering out much Rayleigh scattered skylight, and
- 3.) Kodak Aerographic Infrared film exposed in a Beattie 70 mm magazine.

During the 4min57sec of totality, the following exposures will be taken:
48sec: w87; 24 sec: $P_1, P_2, P_3, w87$; 12sec: P_1, P_2, P_3 .

Data are available on magnetic tape; graphs to be published.

	Camera #1	Camera #2
Coronal Coverage	$1 R_{\odot} - 3.5 R_{\odot}$	$2.5 R_{\odot} - 20 R_{\odot}$
Focal length	178 cm	20 cm
Aperture	11.1 cm	6.9 cm
Focal ratio	f/16	f/2.9
Polaroids ($3 \times 60^\circ$)	HN38	HR
Film (70mm)	Linagraph Shellburst	Aerographic IR (2424)
Compensation for Brightness Range	3 exposure sequences	2 exposure sequences + external occulting disk

INVESTIGATOR: Carl G. Lilliequist
High Altitude Observatory
University of Colorado
Boulder, Colorado USA 80302

SECTION IV

OTHER SOURCES OF SKYLAB PERIOD DATA

Data Available: Some SKYLAB period data available in publication form are cited here. A list of solar periodicals is given, along with addresses of the responsible institutions. The WDC-A for Solar-Terrestrial Physics publishes the Toyokawa, Ottawa and Penticton radio data in its monthly publication, *Solar-Geophysical Data*. The WDC-A for Solar-Terrestrial Physics also receives most of the periodicals when they become available:

Periodicals

- Argentina: *Solar Radio Emission 408 MHz Data*,
Observatorio de Fisica Cosmica, 3226 Mitre, San Miguel (FCGSM)
Buenos Aires, Argentina (monthly)
- Belgium: *Observations Photospheriques Solaires - Nombre de Wolf (Uccle, Belgium)*
Observations Chromospheriques Solaires - Eruptions, Protuberances (Uccle)
Bulletin d'Observations: Activite Solaire - Observations Radioelectriques Solaires - 600 MHz
(Humain, Belgium)
Observatoire Royal de Belgique, Ave. Circulaire 3, Brussels, Belgium (monthly)
- Canada: *Solar Noise Observations at 2800 Mc/s (Ottawa - ARO) and 2700 Mc/s (Penticton - DRAO)*
Series C Monthly Report, National Research Council, Radio Astronomy Section
Ottawa 7, Ontario, Canada
- China: *Report on Sunspot Observations*
Taiwan Provincial Weather Bureau Observatory, Taipei, Taiwan, China (quarterly)
- England: *Photoheliographic Results, Greenwich Royal Observatory Bulletins*
Royal Greenwich Observatory, Herstmonceux Castle, Hailsham, Sussex, England (annually)
- France: *Carte Synoptiques de la Chromosphere Solaire*
Observatoire de Paris, 92 Meudon, France (monthly)
- Germany: *Daily Maps of the Sun*
Fraunhofer Institut, Freiburg i/Breisgau, Germany (twice monthly)
Daily Mean Value of Solar Flux Density
Heinrich-Hertz Institut, 1199 Berlin-Adlershof, Rudower Chaussee 5, Germany (monthly)
- Italy: *Osservazione Solari, Solar Flux and Distinctive Events*
Osservatorio Astronomico Di Trieste
Solar Phenomena - Monthly Bulletin and Photographic Supplement
Osservatorio Astronomico di Roma, Monte Mario, Rome, Italy (monthly)
Photographic Journal of the Sun
Osservatorio Astronomico di Roma, Monte Mario, Rome, Italy (monthly) (27 day rotation)
- Japan: *Bulletin of Solar Phenomena*
Tokyo Astronomical Observatory, Tokyo, Japan (quarterly)
Monthly Report of Solar Radio Emission
Radio Astronomy Section, Research Institute of Atmospherics, Nagoya University
Toyokawa, Japan
Solar Radio Emission
Tokyo Astronomical Observatory, University of Tokyo, Mitaka, Japan (monthly)
Solar Activity Chart
WDC-C2, Toyokawa Observatory, Nagoya University, Toyokawa, Japan (annually)
- Lebanon: *Solar Photospheric Observations*
Monthly Bulletin, Astronomical Section, Lee Observatory
American University of Beirut, Lebanon (monthly)
- Netherlands: *Solar Radio Noise Observations - Stations Nera and Paramaribo*
Sonnenborgh Observatory, Servaas Bolwerk 15, Utrecht, Netherlands (monthly)
- Switzerland: *IAU Quarterly Bulletin on Solar Activity*
Eidgen Sternwarte, Zurich, Switzerland
- Union of Soviet Socialist Republics:
СОЛНЕЧНЫЕ ДАННЫЕ (Solar Data)
USSR Academy of Science (monthly)
- United States of America:
AFCRL Geophysics and Space Data Bulletin
AFCRL, L. G. Hanscom Field, Bedford, Massachusetts, USA (quarterly)
Preliminary Report and Forecast of Solar-Geophysical Activity
Space Environment Services Center, NOAA, Boulder, Colorado, 80302 USA (weekly)
Solar Radio Flux Observed at University Park
Pennsylvania Radio Astronomy Observatory, Pennsylvania State University
University Park, Pennsylvania, USA (quarterly)
Solar-Geophysical Data
NOAA, Boulder, Colorado 80302 USA (monthly)

NOAA Data: The Space Environment Forecast Center, NOAA, Boulder, Colorado, 80302, USA, is presently microfilming all available data pertaining to the SKYLAB period received at the Center. Generally, these data will include:

Calcium observations from McMath, Haleakala, Catania, Sac Peak and Kitt Peak Observatories
Solar Magnetic Fields from Aerospace, Big Bear, Sac Peak, Kitt Peak and Mt. Wilson observatories
Coronal intensities from Mauna Loa and Sac Peak observatories
Sweep Frequency Radio Data from Culgoora and Sagamore Hill observatories
Also, OSO-7 X-ray and EUV maps and ATS-1 proton data from GSFC, NRL OSO-7 EUV maps, and SOLRAD X-ray fluxes

All other pertinent data received are also being included. These data are available to interested persons at the cost of producing a copy of the microfilmed data.

Coronal hole maps derived from the OSO-7 GSFC EUV spectroheliograms for the SKYLAB period are expected to be available shortly in a NOAA Technical Report. Also, a 24-hour sun movie is being prepared for SKYLAB period by the Space Environment Laboratory. /.

NOAA Technical Memorandum ERL SEL-33, "A Correlation of Ground-Based Data for 17-21 August 1973", by Joseph M. Kunches became available in October 1974. During the time period covered by this report SKYLAB was conducting a study to determine solar wind parameters.

Report UAG-36, An Atlas of Extreme Ultraviolet Flashes of Solar Flares Observed Via Sudden Frequency Deviations during the ATM SKYLAB Missions, by R. F. Donnelly, E. L. Berger, Lt. J. C. Busman, B. Henson, T. B. Jones, G. M. Lerfald, K. Najita, W. M. Retallack and W. J. Wagner, prepared by the NOAA Space Environment Laboratory and issued through the WDC-A for Solar-Terrestrial Physics, was published in October 1974. Another report, Report UAG-40, H-Alpha Synoptic Charts of Solar Activity for the Period of SKYLAB Observations May, 1973 - March 1974, by Patrick S. McIntosh, was published in February 1975.

ATM Data: It is expected that all SKYLAB/ATM scientific data will be stored at the National Space Science Data Center (NSSDC) by late 1975. These will include the ATM Missions Operation Log. Requests for copies of these data should be made to:

National Space Science Data Center
Code 601.4
Goddard Space Flight Center
Greenbelt, Maryland 20771 USA

Harvard College Observatory is preparing an H α Atlas compiled from data taken by the H α telescopes on board SKYLAB. This Atlas is to be available to the ATM/SKYLAB Principal Investigators. For further information, contact:

Daryl Torgerson
Harvard College Observatory
60 Garden Street
Cambridge, Massachusetts, 02138 USA

SECTION V

SOME SKYLAB PERIOD DATA

Detailed Charts of Flare Patrols and Observations for July 29 and September 7, 1973

We present here graphical representations of the flare patrol data for the two most active days during the SKYLAB mission from data of 33 solar observatories reporting to WDC-A for Solar-Terrestrial Physics.

There is a separate chart for each of the days July 29 and September 7, 1973 and a separate line for each observatory. The observatories are in order of longitude with a numerical code to key to the observatories listed in the Table below.

In the charts, observation times are indicated by an open box, where C, V, and P indicate patrol is cinematographic, visual or visual with some photographs, respectively. Lines with arrows indicate nighttime at each of the stations. Sunrise and sunset are only approximate, depending on where in the 15° time zone the station lies.

Reported flares are shown by a cross-hatched area below the open boxes. Flares with importance $\geq 1F$ are marked with the importance rating. Any second flare reported at the same time is shown with reversed cross-hatched area. Due to lack of space, if there were three flares whose durations overlap, the overlapping period of the second and third is simply blackened in.

The bottom line gives the same information for the flare patrol network as a whole. The flare data are the "Grouped Flare Reports" from *Solar-Geophysical Data*.

Table of Observatories

01	Herstmonceux	N50 E00	18	Abastumani	N41 E42
02	Meudon	N49 E02	19	Tehran	N35 E51
03	Locarno	N46 E08	20	Tashkent	N41 E69
04	Zürich	N47 E08	21	Kodaikana1	N10 E77
05	Arcetri	N34 E11	22	Siberie	N52 E104
06	Monte Mario	N41 E12	23	Carnarvon	S25 E114
07	Wendelstein	N47 E12	24	Manila	E14 E121
08	Capri-F	N40 E14	25	Voroshilov	N43 E132
09	Capri-S	N40 E14	26	Mitaka	N35 E139
10	Ondrejov	N49 E14	27	Culgoora	S30 E147
11	Catania	N37 E15	28	Palehua	N21 E204
12	Upice	N50 E16	29	Boulder	N40 E255
13	Athens 1,2	N37 E23	30	McMath	N42 E277
14	Bucharest	N44 E26	31	Huancayo	S12 E285
15	Istanbul	N41 E28	32	Ramey	N18 E292
16	Kiev	N50 E30	33	Gran Canaria	N28 E345
17	Kharkov	N50 E36			

SOLAR FLARE OBSERVATIONS FOR JULY 29, 1973

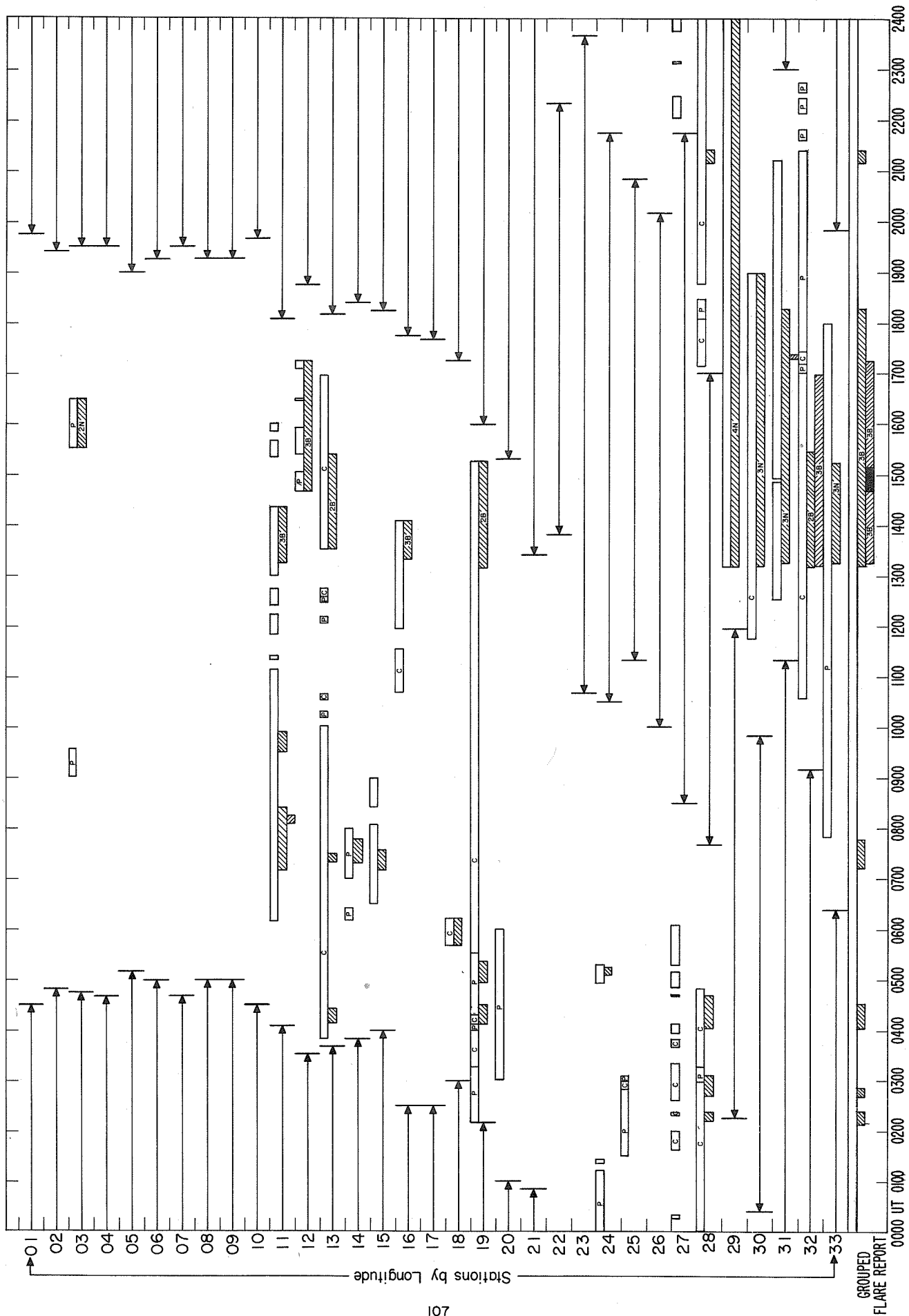

SOLAR FLARE OBSERVATIONS FOR SEPTEMBER 7, 1973

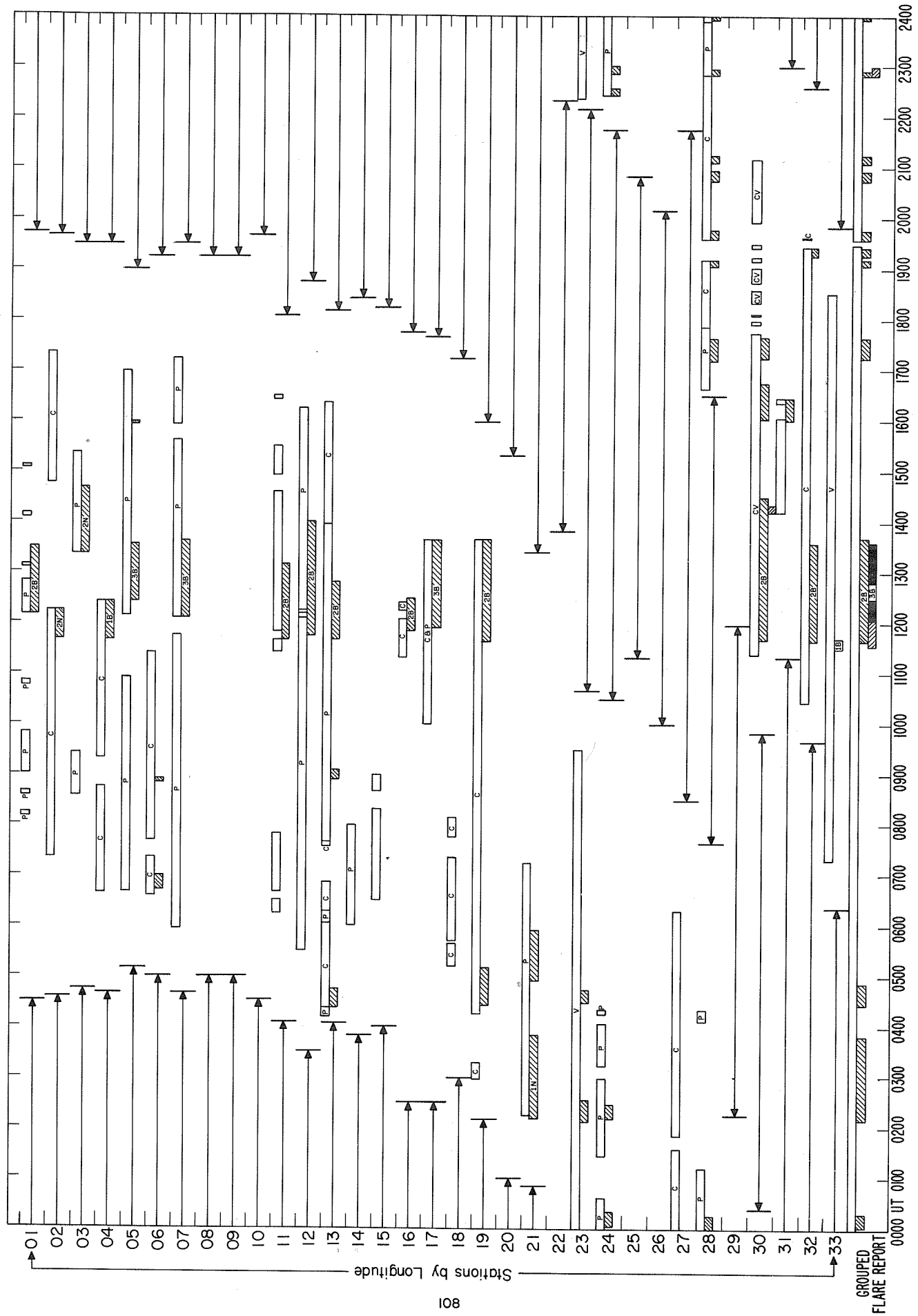

GROUPED
FLARE REPORT

Nancay East-West Solar Scans

East-West solar scans from Nancay covering the SKYLAB period are reproduced on the following pages. The scale of flux is arbitrary. These data permit the identification both of sources of noise-storms (408 MHz and 169 MHz) and of sources of the slowly varying component (9400 MHz, 408 MHz and 169 MHz).

169 MHz data:

The main lobes are parallel to the meridian plane: the half power width is 3.7 minutes of arc in the East-West direction. The main lobes are about 1° apart. The records give the strip intensity distribution from the center of the disk to 30 arcmin to the West and East.

Each noisy region is reported on a chart which is published in *Solar-Geophysical Data*. The broad humps of weak intensity are from thermal origin.

The absolute calibration was difficult to determine during the period May to November 1973. For several days the uncertainty may reach 25%. Anyone who would like to deduce any absolute flux values from these data is kindly requested to contact the radioheliograph group (Mrs. Lantos) at Meudon Observatory.

408 MHz data:

The half power is 1.7 arcmin in the East-West direction. The main lobes are about 50 arcmin apart.

The noisy regions and the sources of thermal emission are both observed.

9400 MHz data:

The half power is 3.5 arcmin in the East-West direction. The main lobes are about 1 degree of arc apart.

NOTE: Data baseline for all frequencies is shown most clearly on the 9400 MHz daily scans.

EAST-WEST SOLAR SCANS
 Nançay, France
 MAY 28, 1973 - FEBRUARY 8, 1974

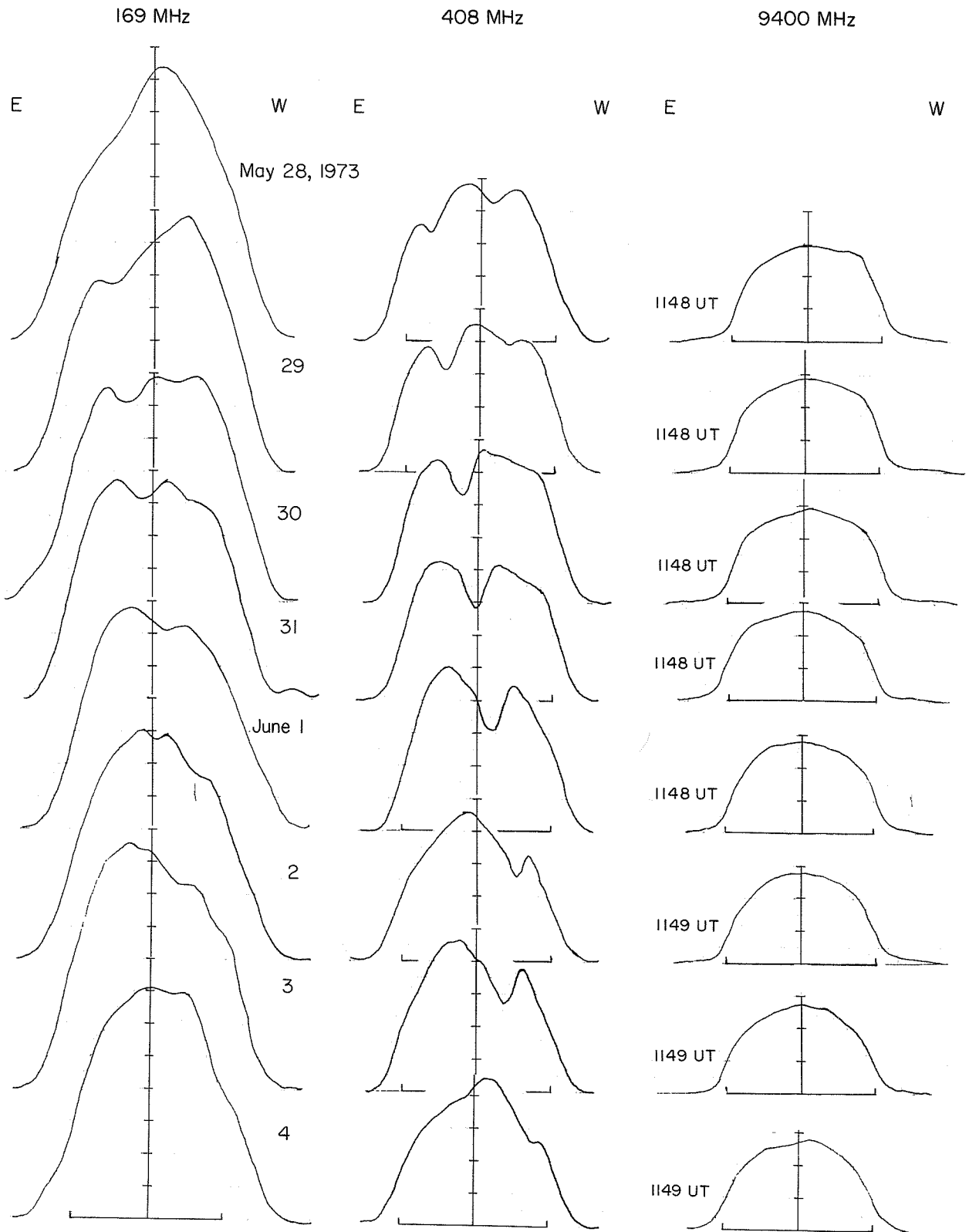

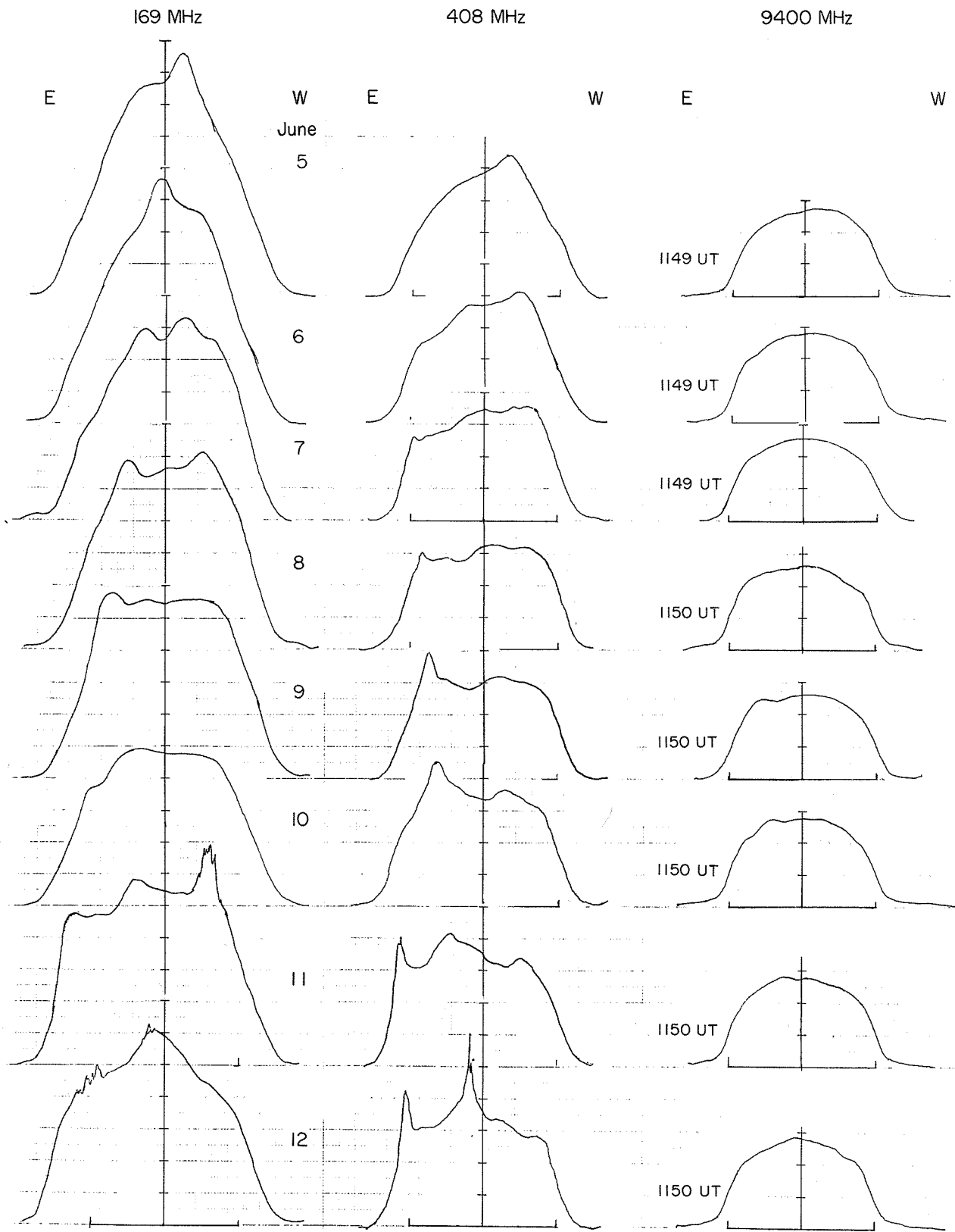

169 MHz.

408 MHz

9400 MHz

E

W

E

W

E

W

June

13

1151 UT

Activity

14

1151 UT

No Data

15

1151 UT

16

1151 UT

17

1151 UT

18

1152 UT

Activity

19

1152 UT

20

1152 UT

Activity

169 MHz

408 MHz

9400 MHz

E

W E

W E

W

June

21

22

23

24

1152 UT

1153 UT

1153 UT

1153 UT

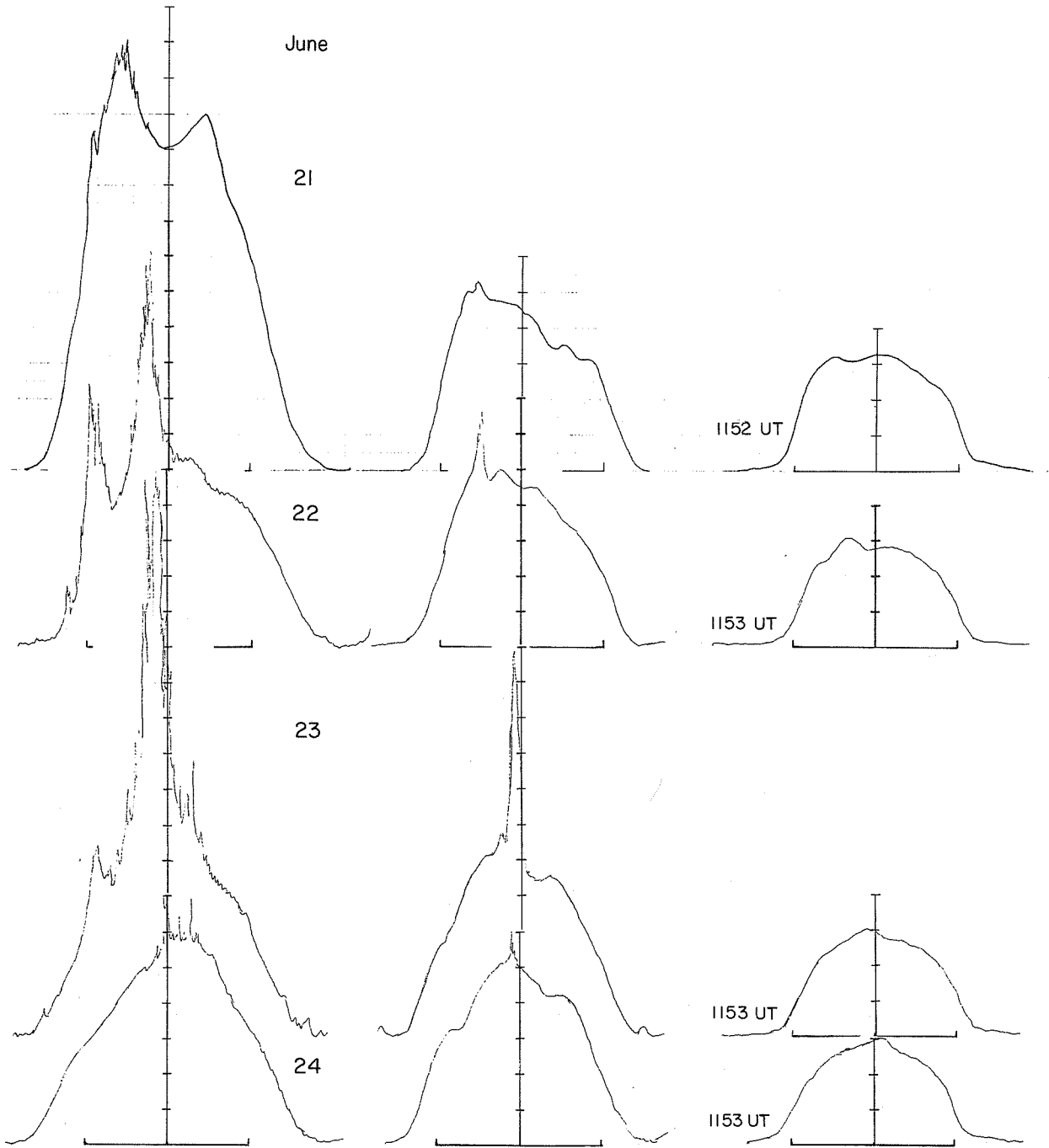

169 MHz

408 MHz

9400 MHz

E

W

E

W

E

W

June

25

26

27

28

29

30

1153 UT

1156 UT

1155 UT

1156 UT

1154 UT

No Data

July 1

No Data

No Data

No Data

169 MHz

408 MHz

9400 MHz

E

W

E

W

E

W

July

2

3

4

Activity

1155 UT

1155 UT

1155 UT

169 MHz

408 MHz

9400 MHz

E

W

E

W

E

W

July

5

6

7

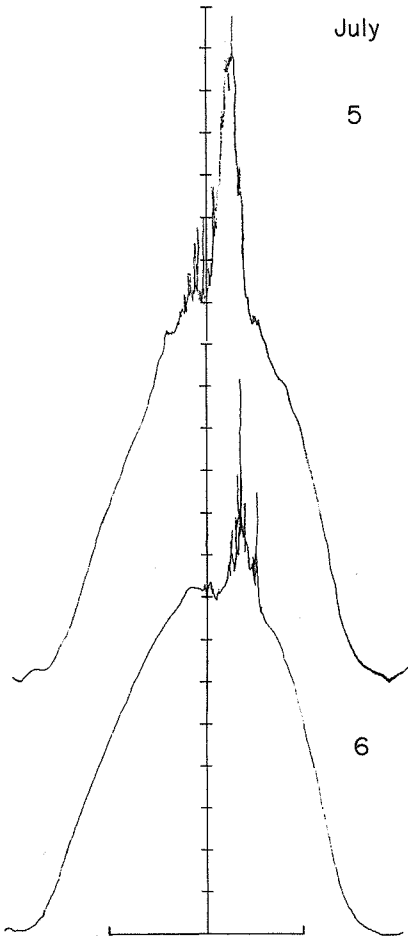

Activity

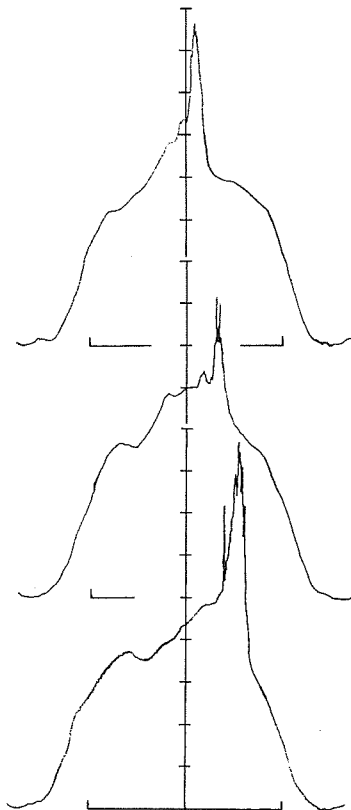

1155 UT

NO TIME

1156 UT

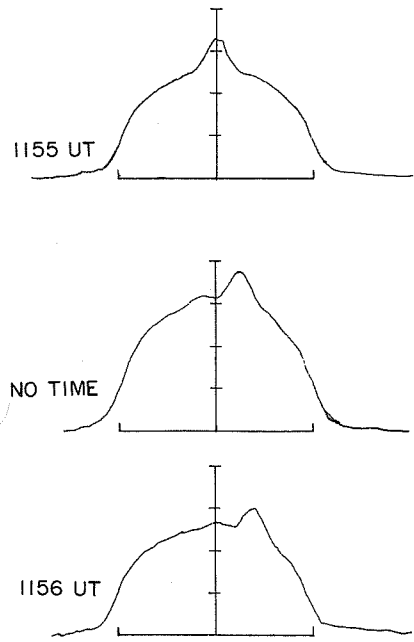

169 MHz

408 MHz

9400 MHz

E

W

E

W

E

W

July

8

No Data

9

1156 UT

10

1156 UT

11

1156 UT

12

1156 UT

13

1156 UT

1156 UT

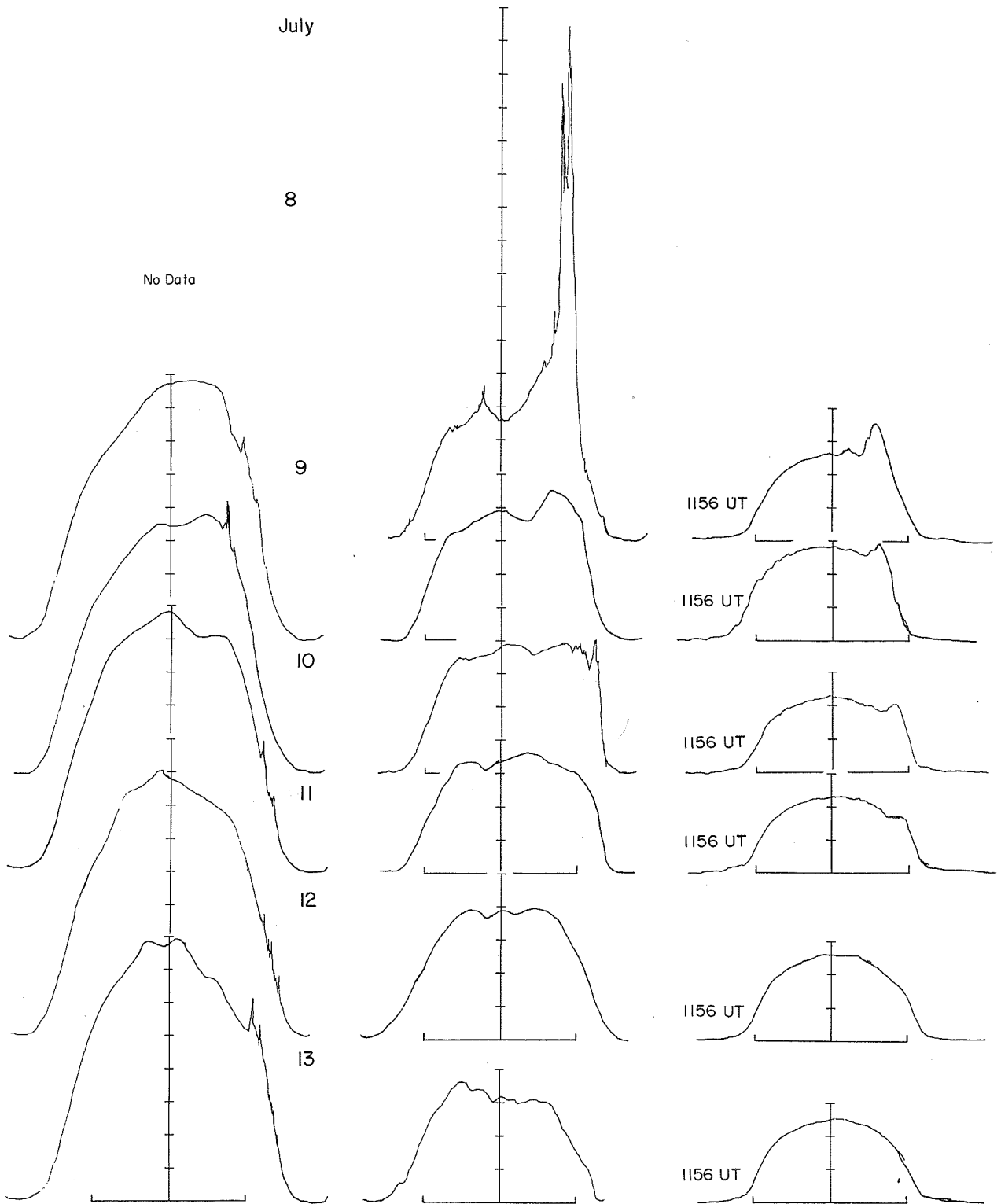

169 MHz

408 MHz

9400 MHz

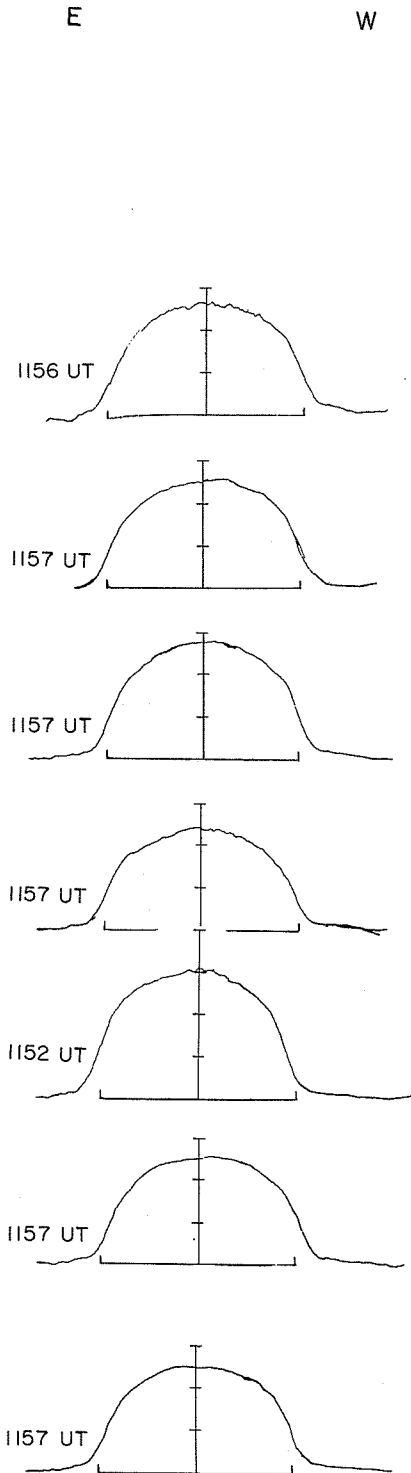
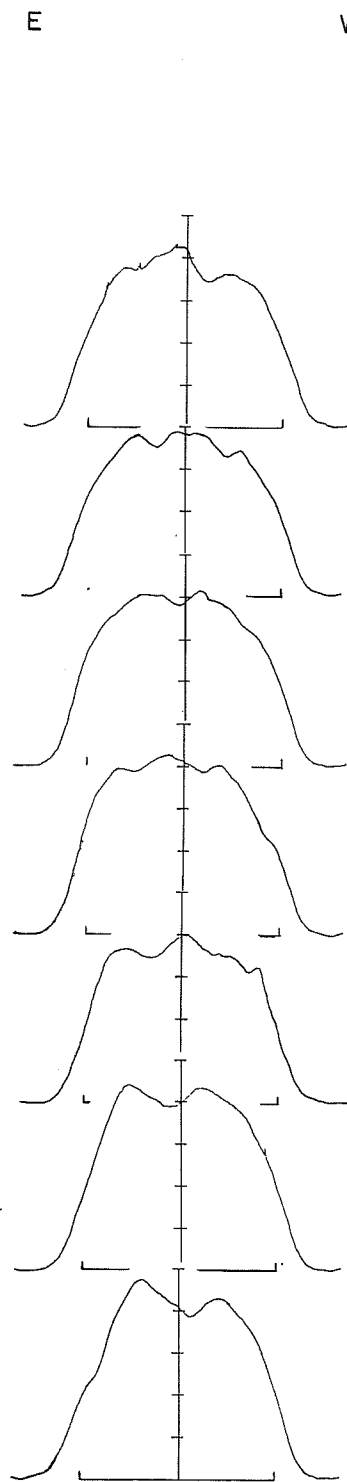
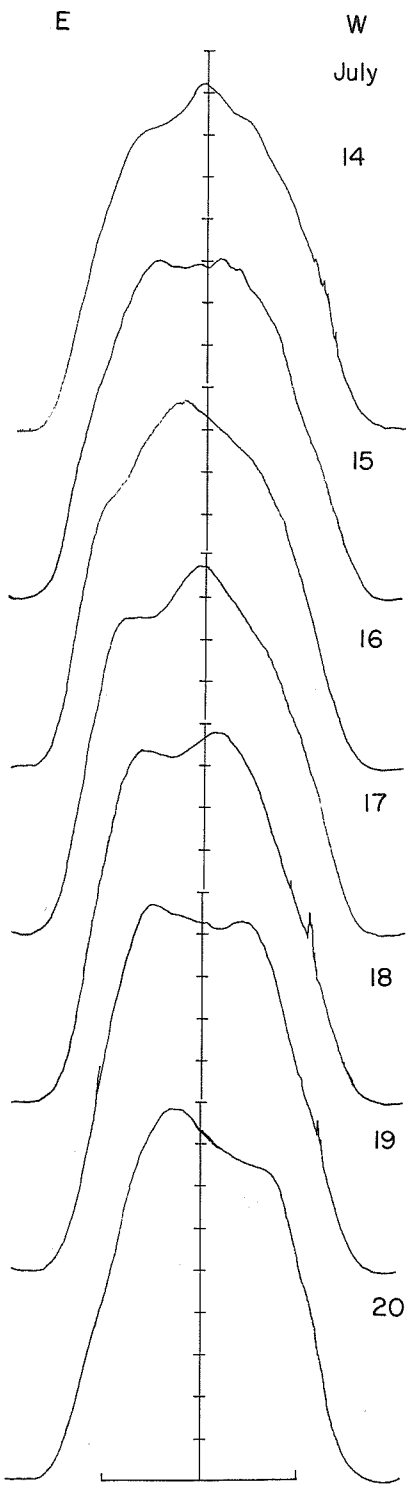

169 MHz

408 MHz

9400 MHz

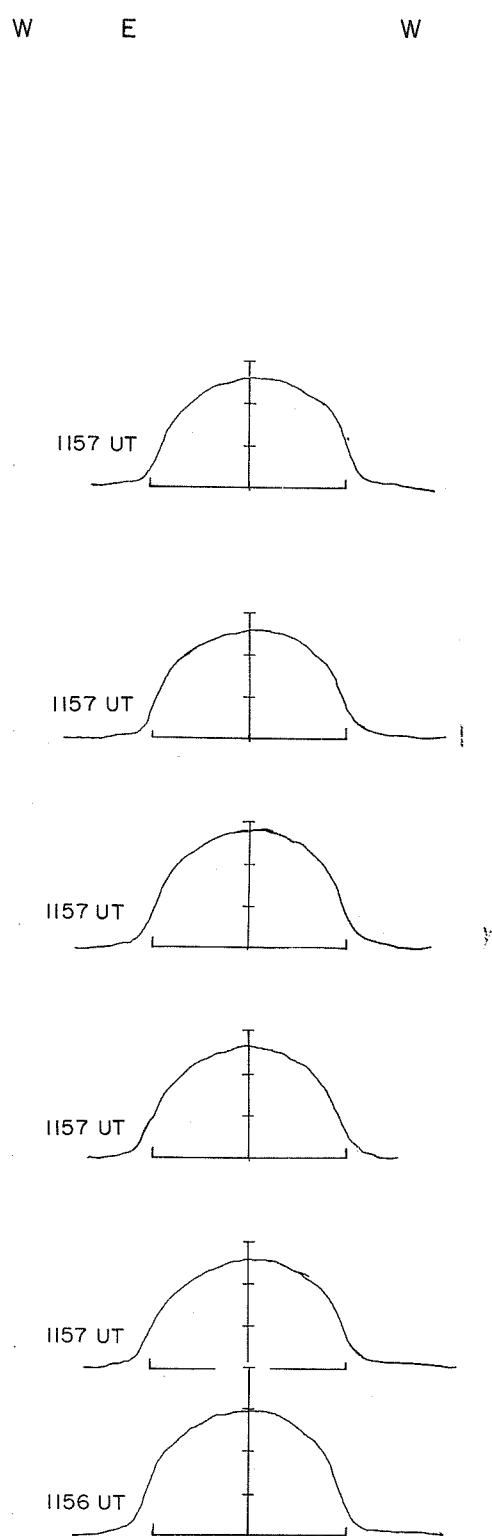
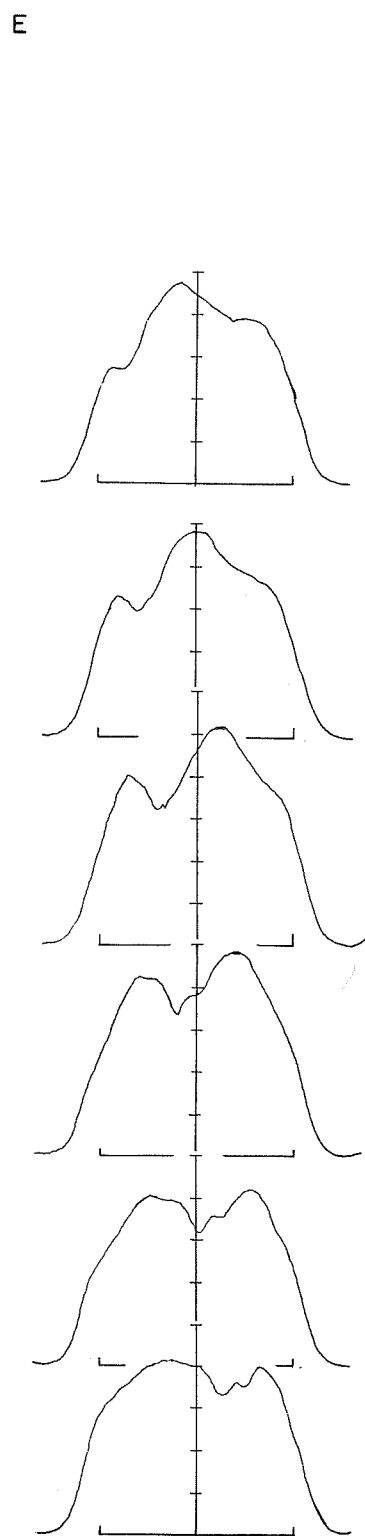
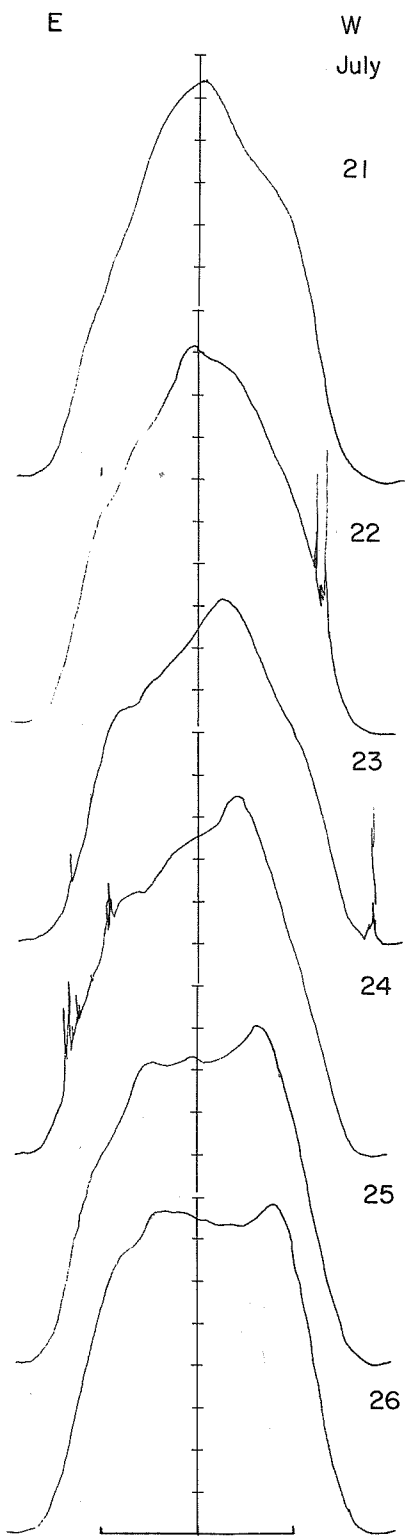

169 MHz

408 MHz

9400 MHz

E

W

E

W

E

W

July

27

28

29

30

31

August 1

1157 UT

1157 UT

1157 UT

1157 UT

1157 UT

1157 UT

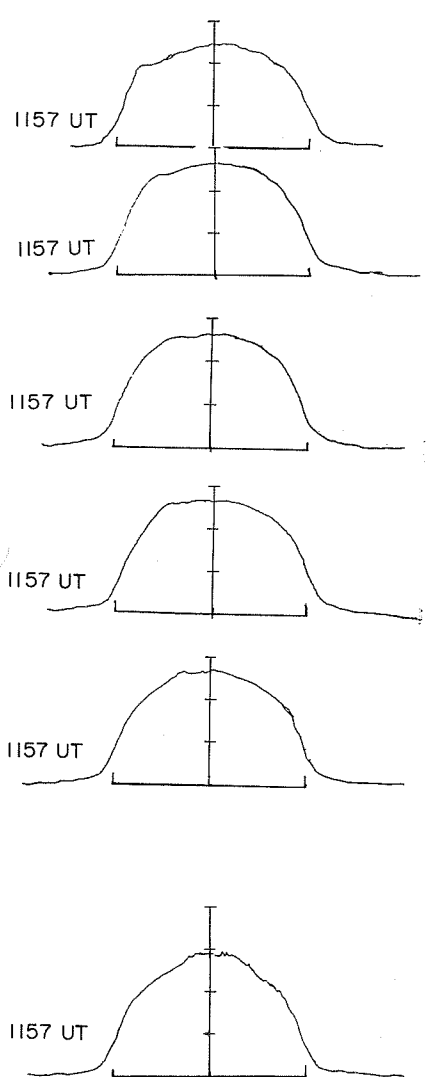
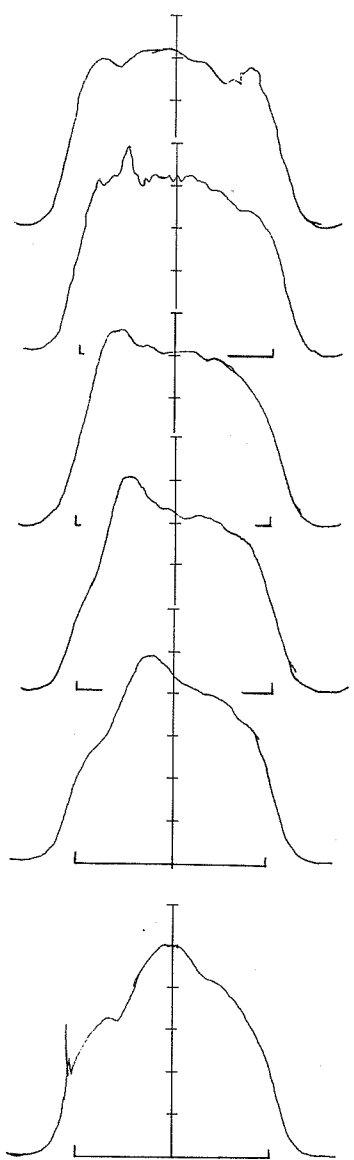
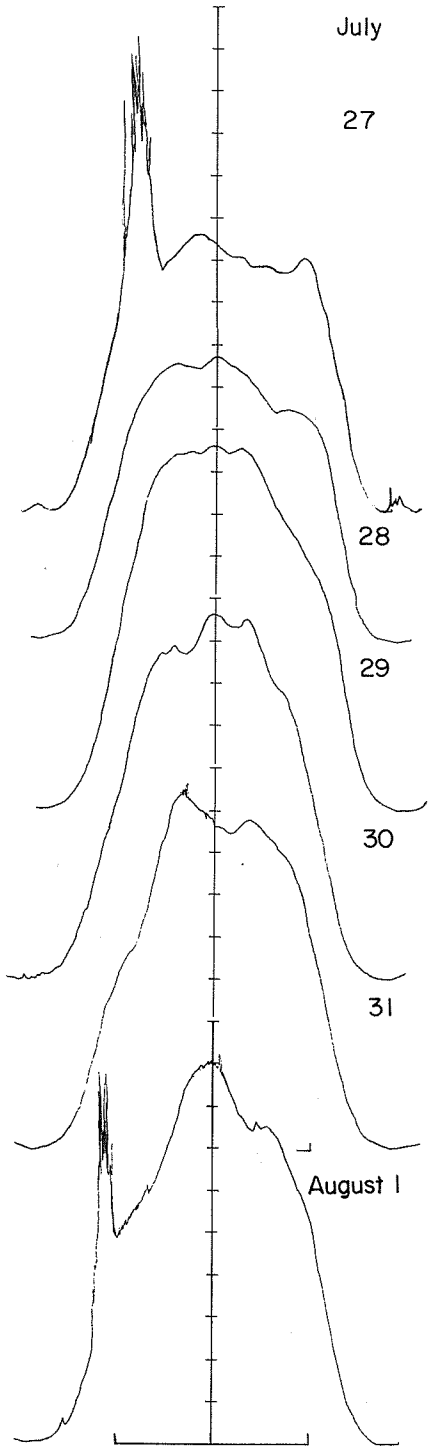

169 MHz

408 MHz

9400 MHz

E

W

E

W

E

W

August

2

3

4

5

6

7

8

9

1157 UT

1157 UT

1158 UT

No Data

1157 UT

1157 UT

1157 UT

1158 UT

1156 UT

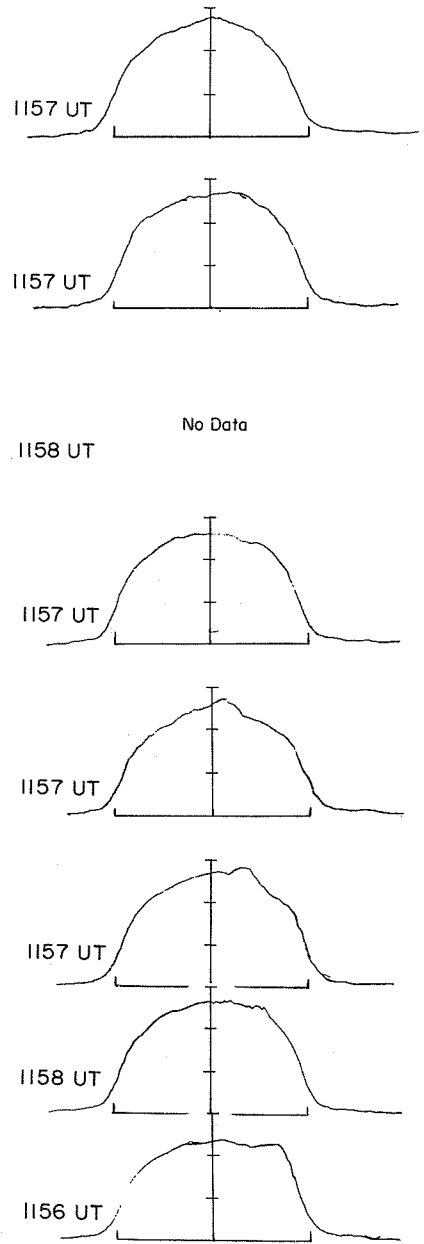
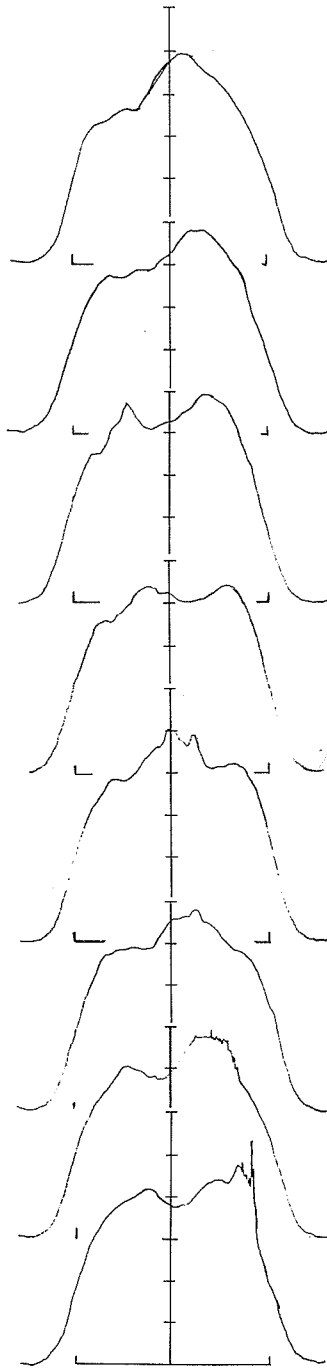
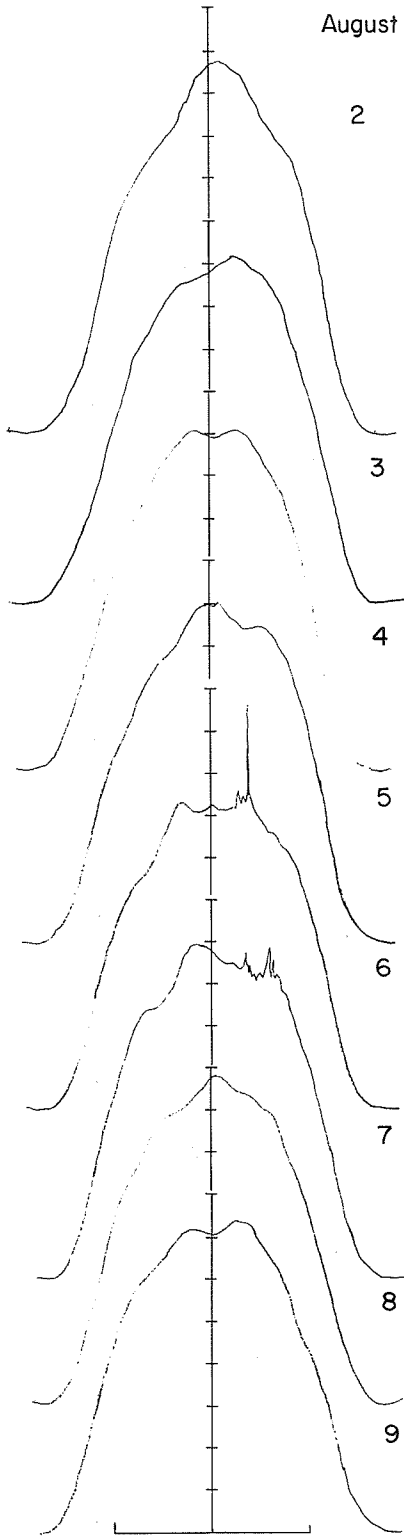

169 MHz

408 MHz

9400 MHz

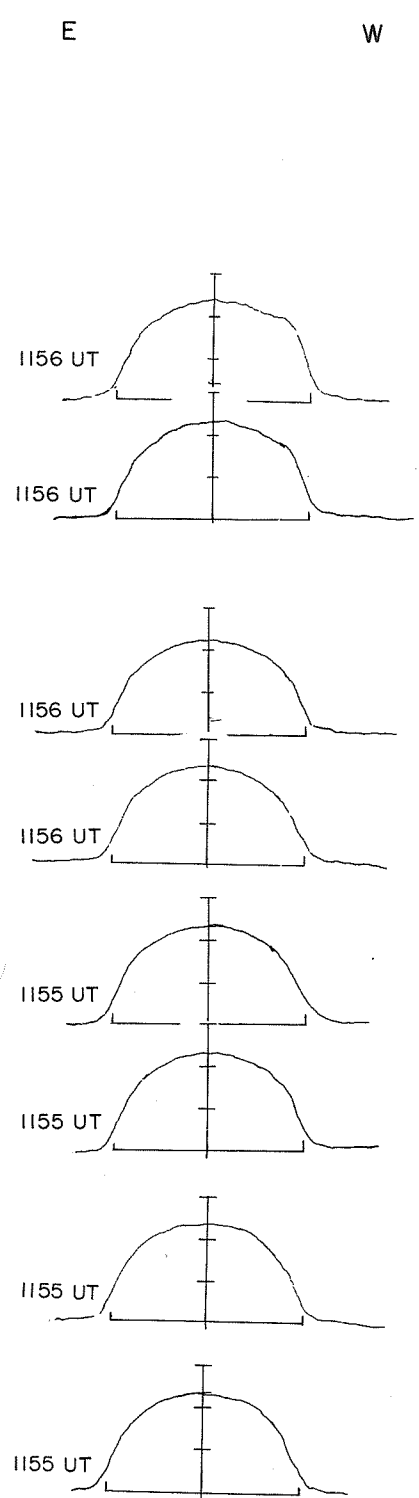
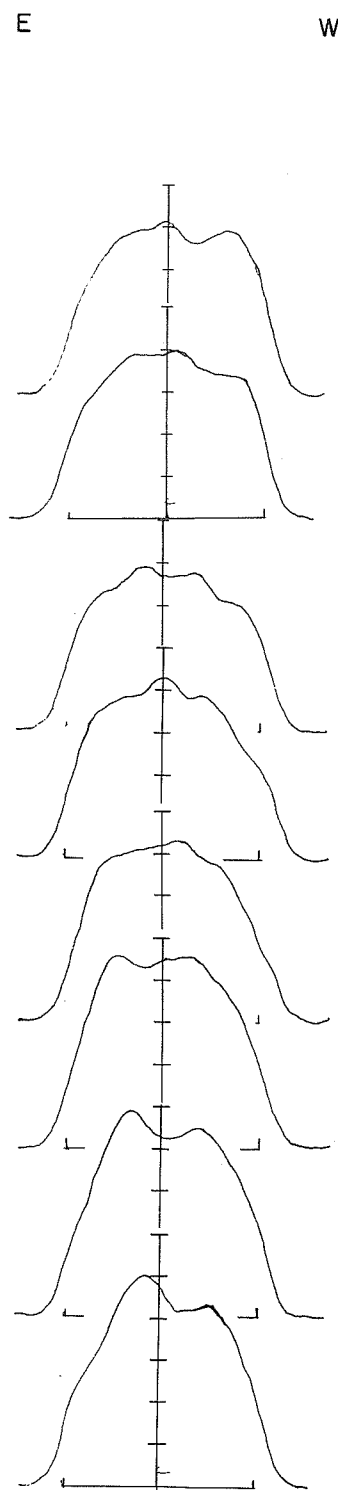
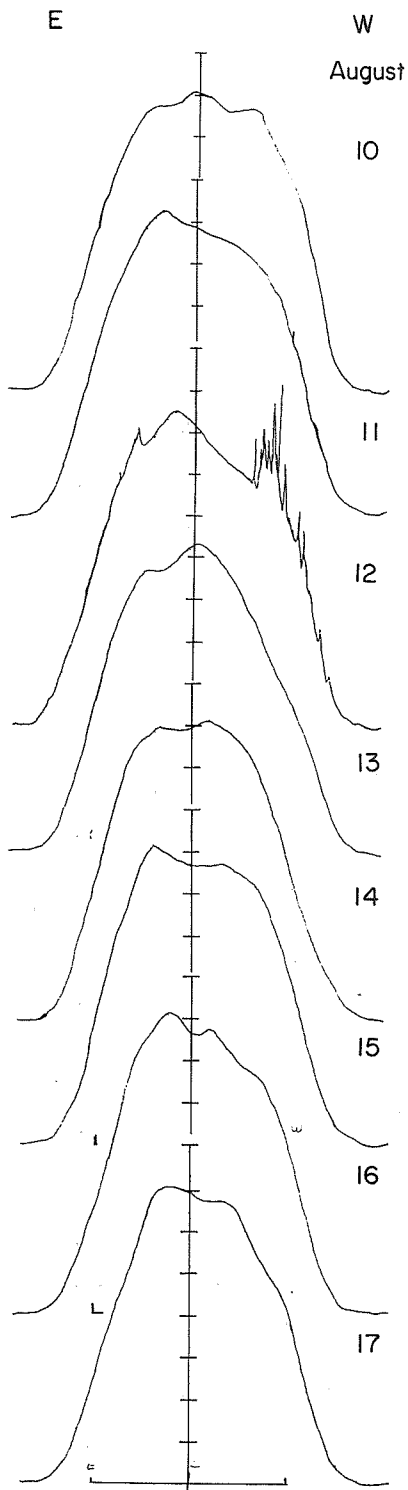

169 MHz

408 MHz

9400 MHz

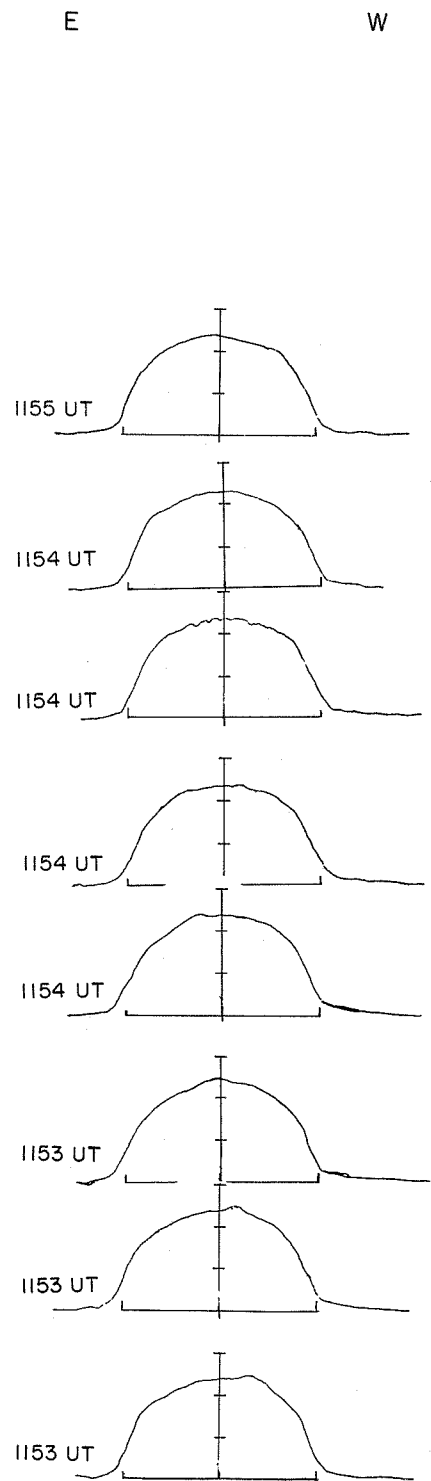
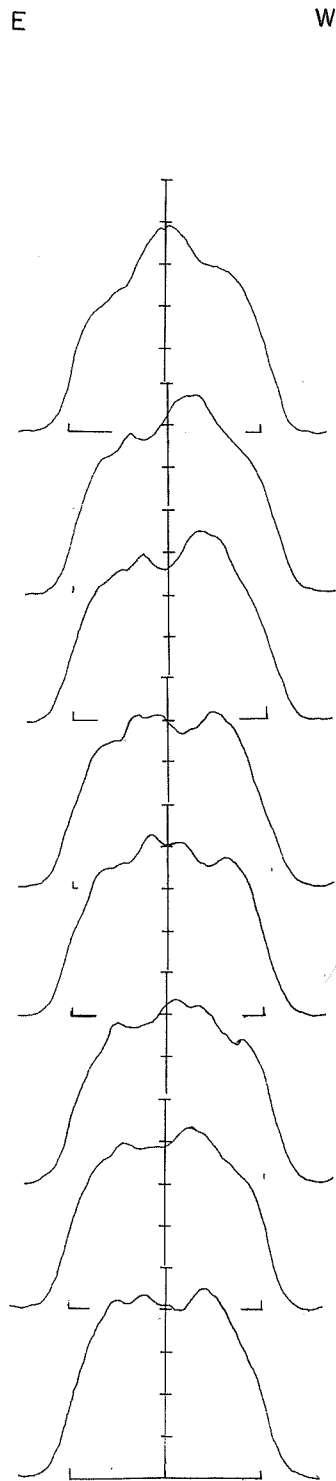
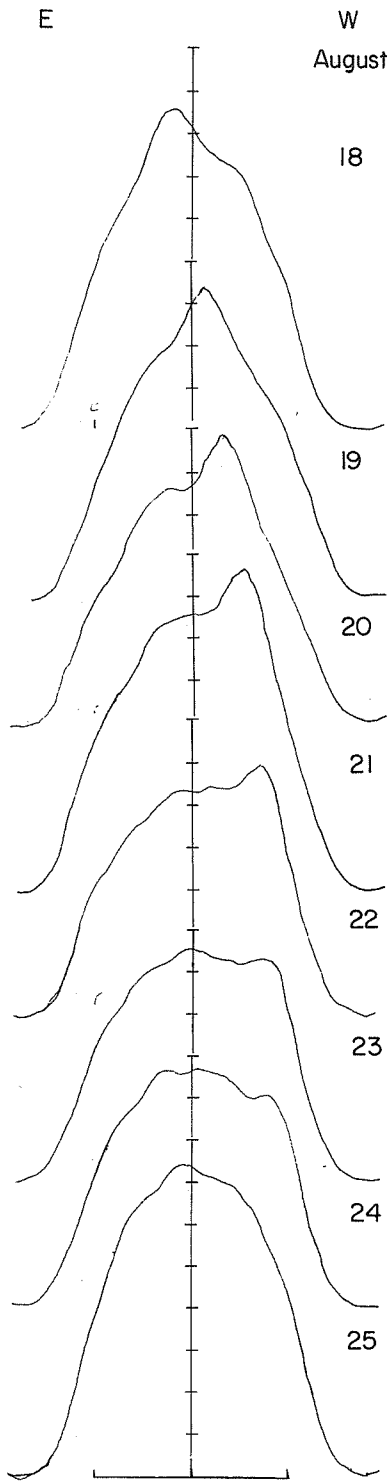

169 MHz

408 MHz

9400 MHz

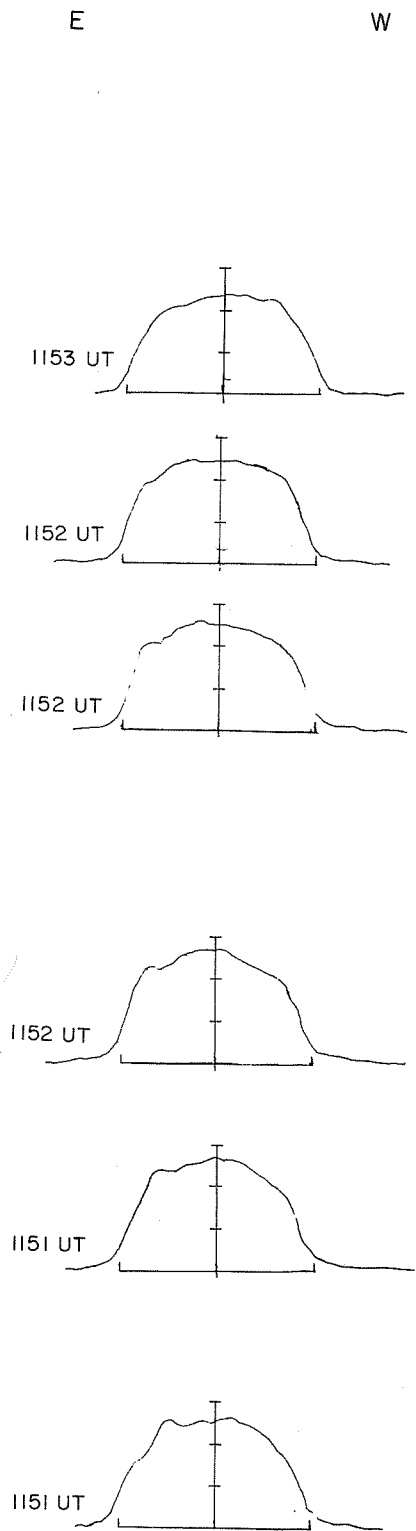
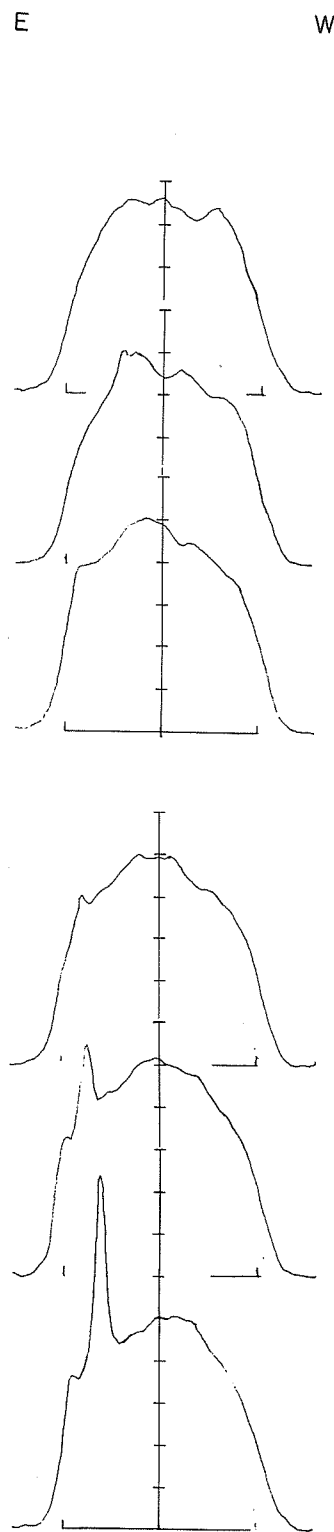
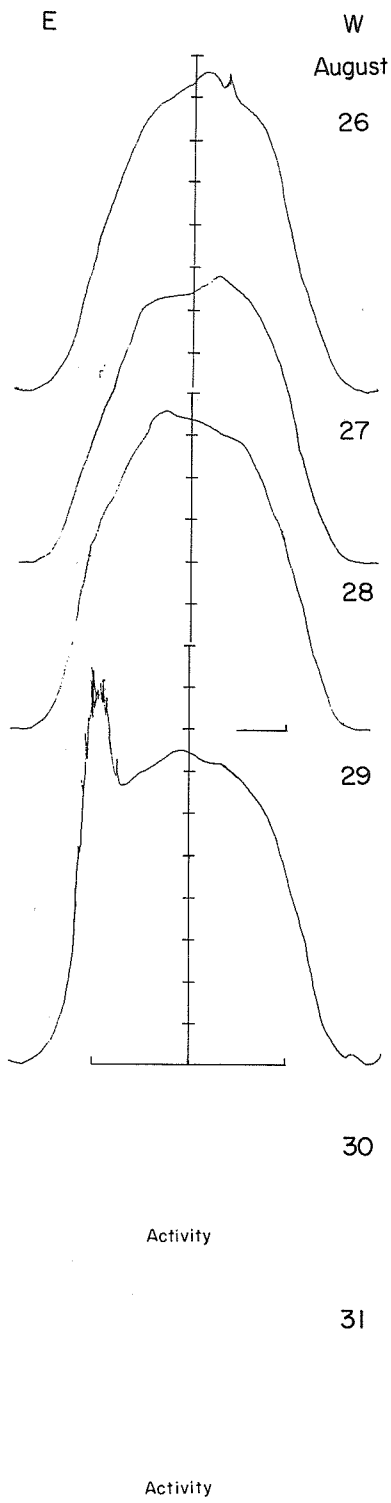

169 MHz

408 MHz

9400 MHz

E

W

E

W

E

W

September 1

Activity

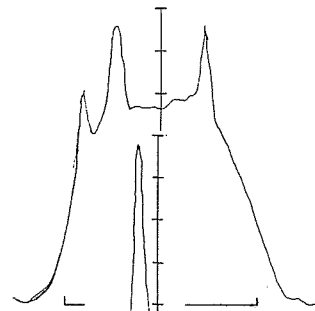

1151 UT

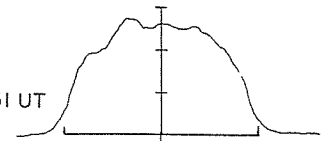

2

Activity

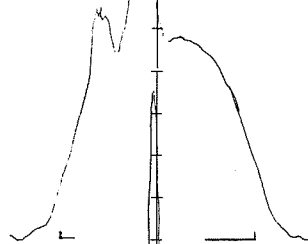

1150 UT

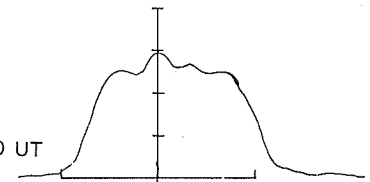

3

Activity

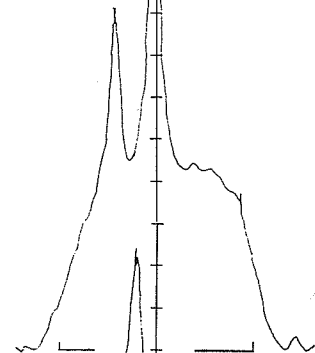

1150 UT

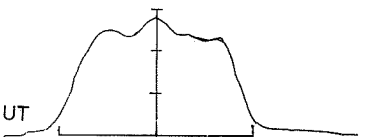

4

Activity

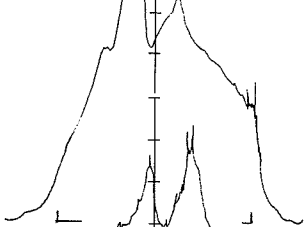
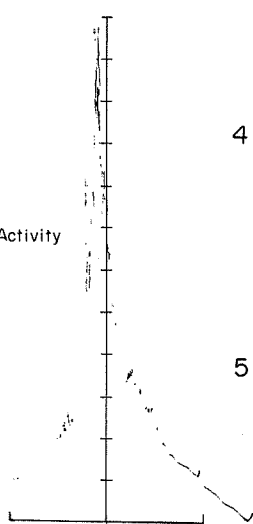

1150 UT

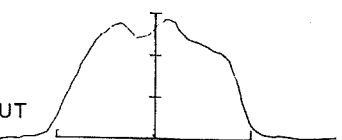

5

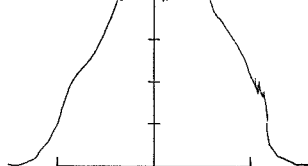

1150 UT

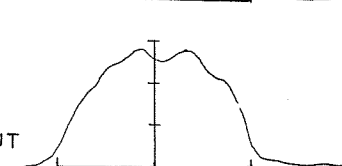

169 MHz

408 MHz

9400 MHz

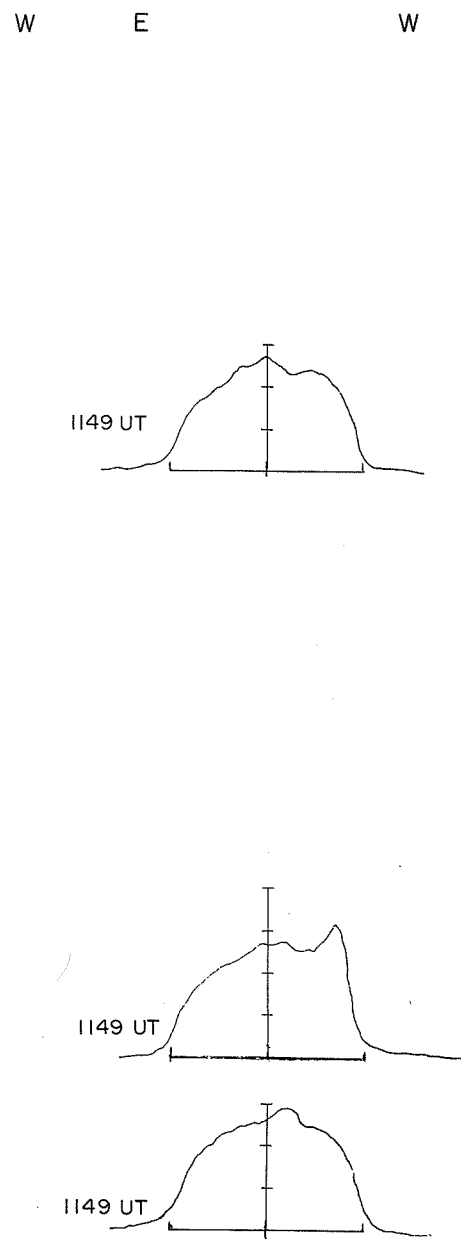
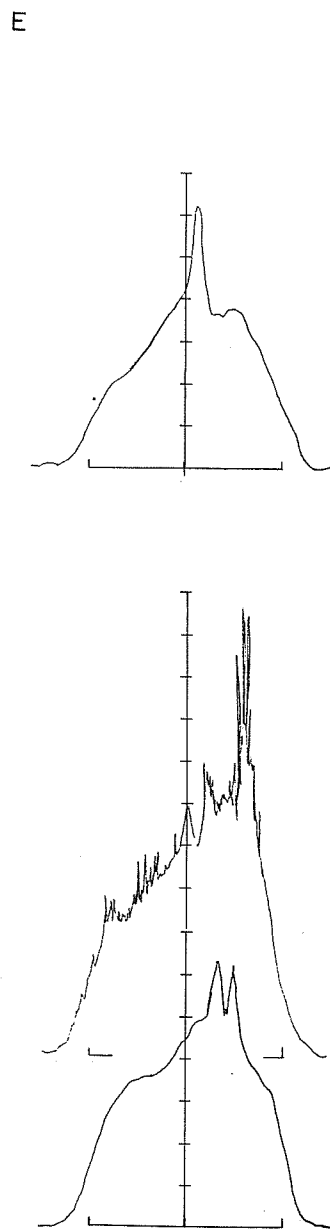
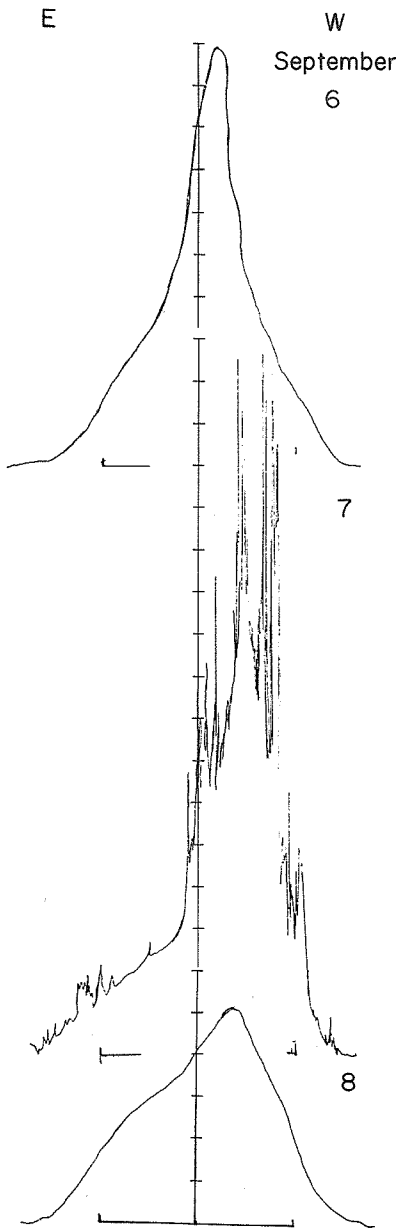

169 MHz

408 MHz

9400 MHz

E

W

E

W

E

W

September

9

No Data

1148 UT

10

1148 UT

11

1147 UT

12

1147 UT

13

1147 UT

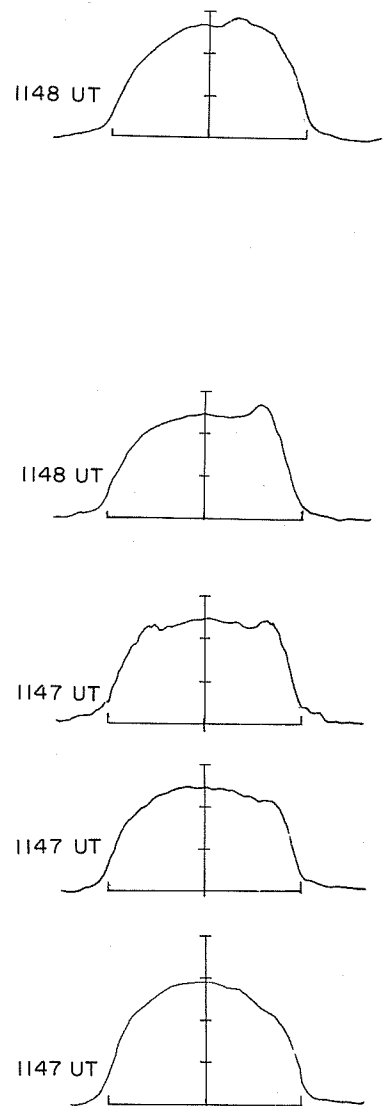
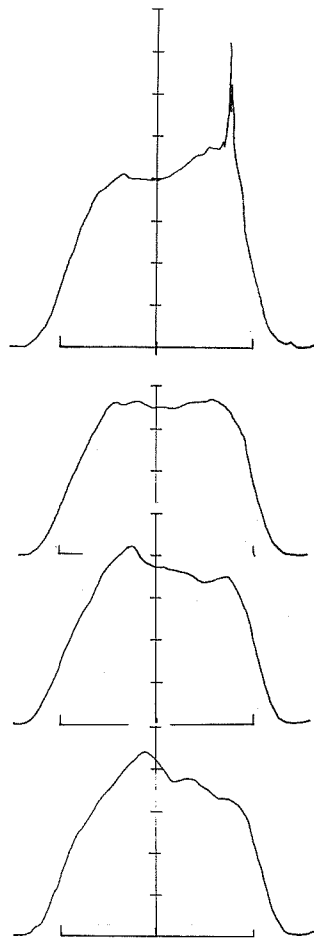
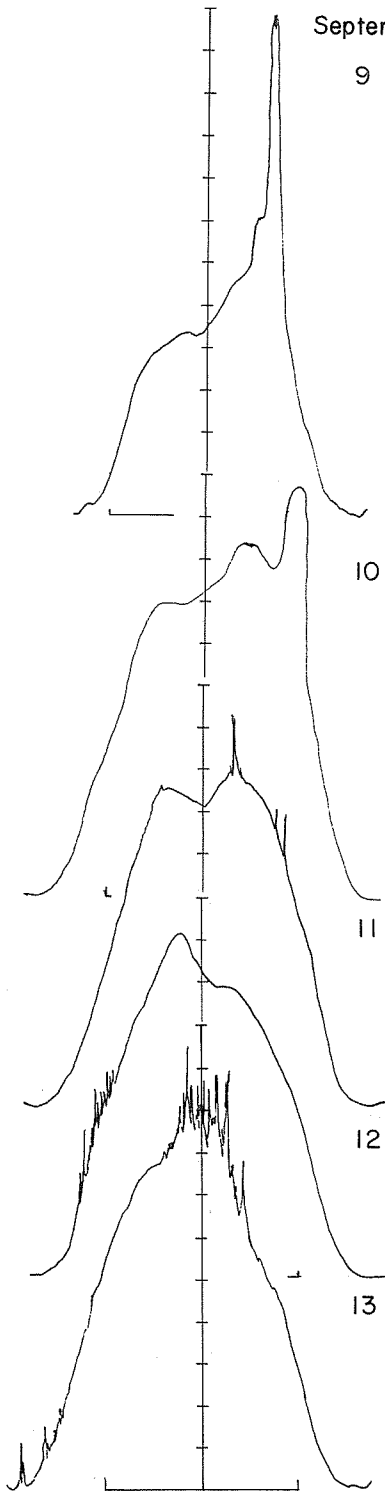

169 MHz

408 MHz

9400 MHz

E

W

E

W

E

W

September

14

15

16

17

18

19

20

1146 UT

1146 UT

1146 UT

1145 UT

1145 UT

1145 UT

1144 UT

169 MHz

408 MHz

9400 MHz

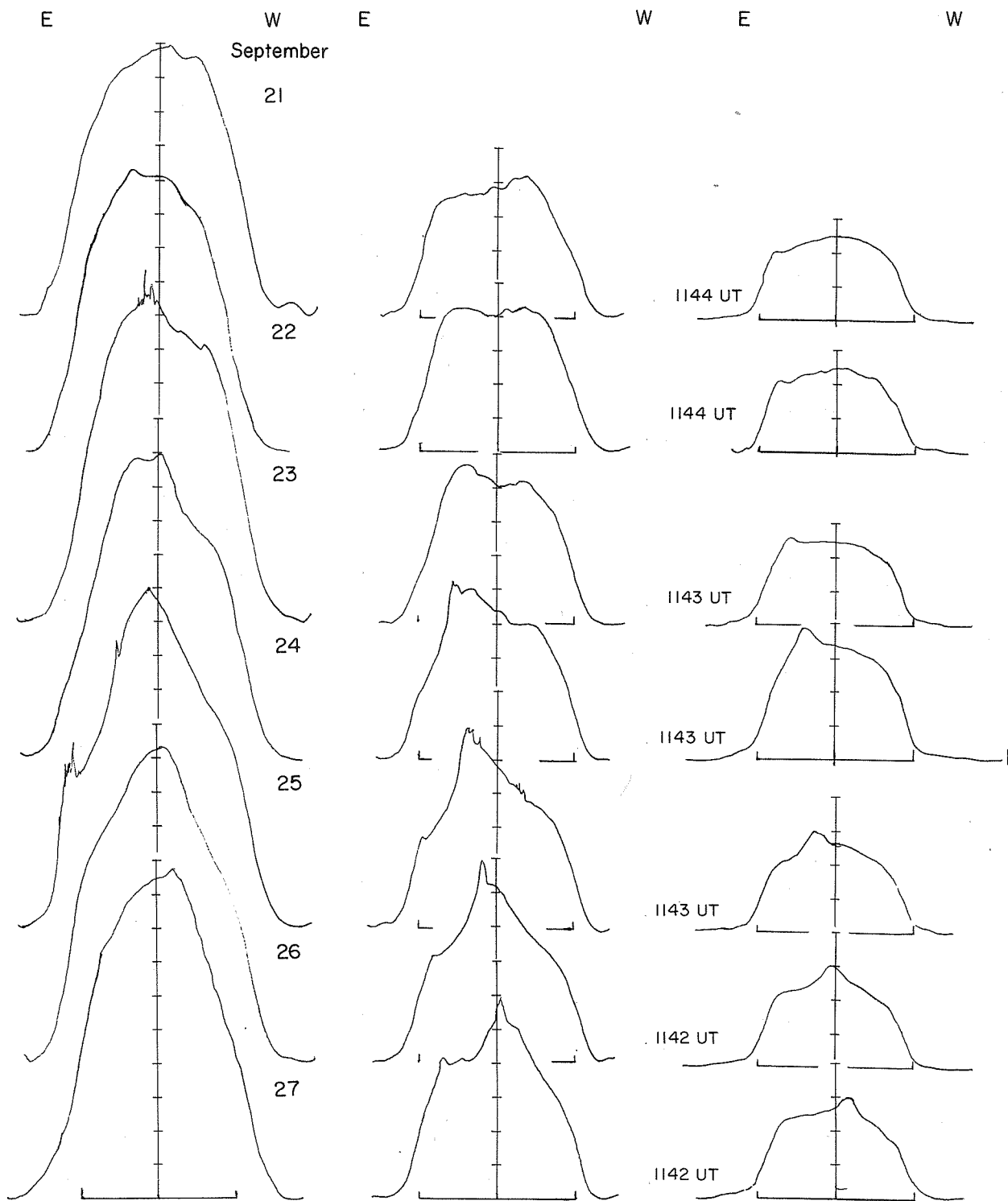

169 MHz

408 MHz

9400 MHz

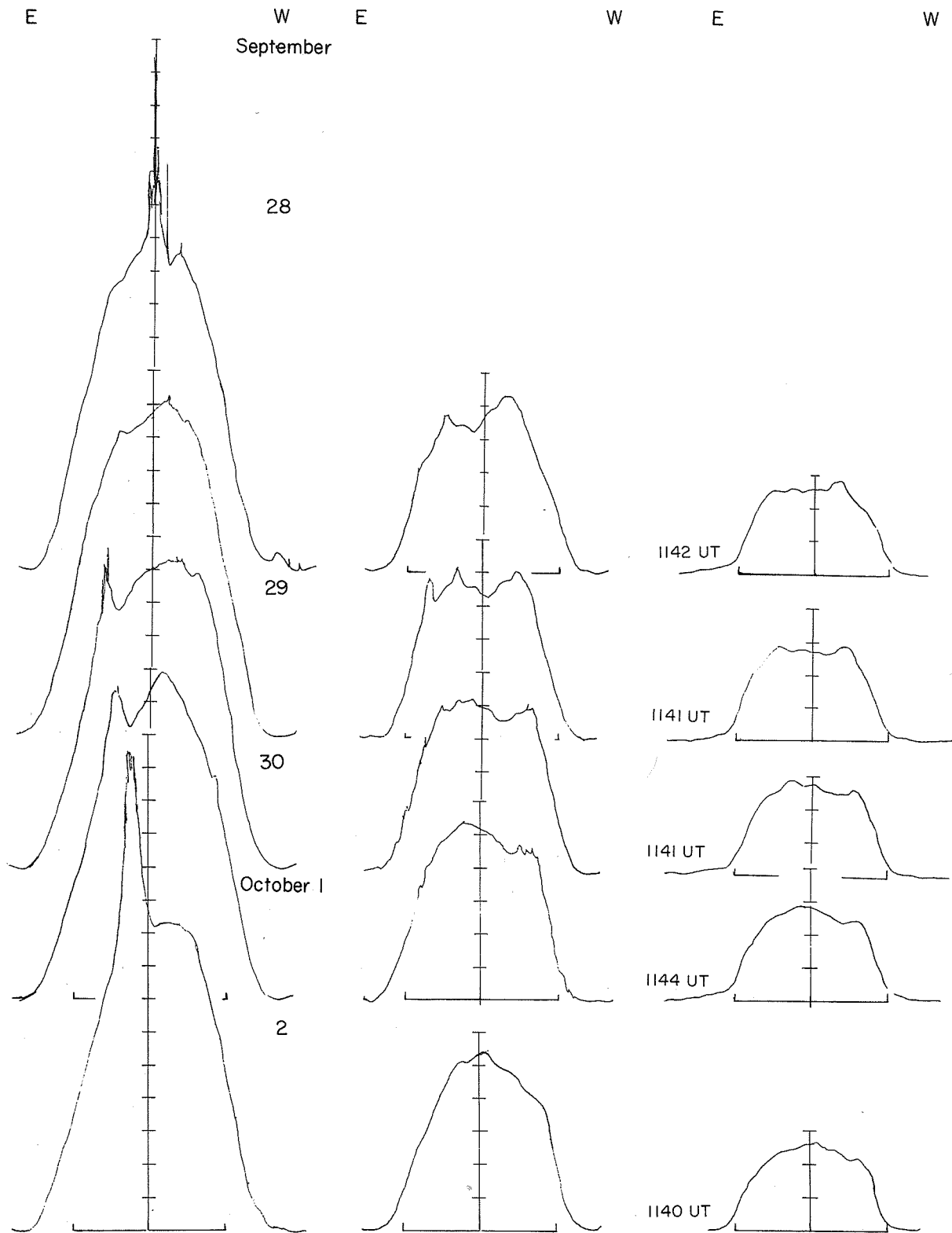

169 MHz

408 MHz

9400 MHz

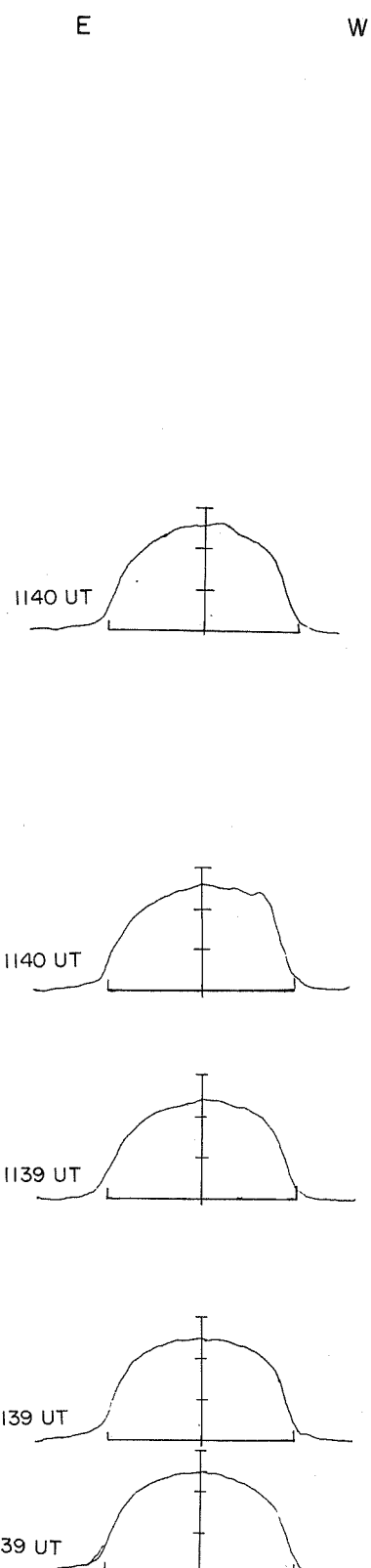
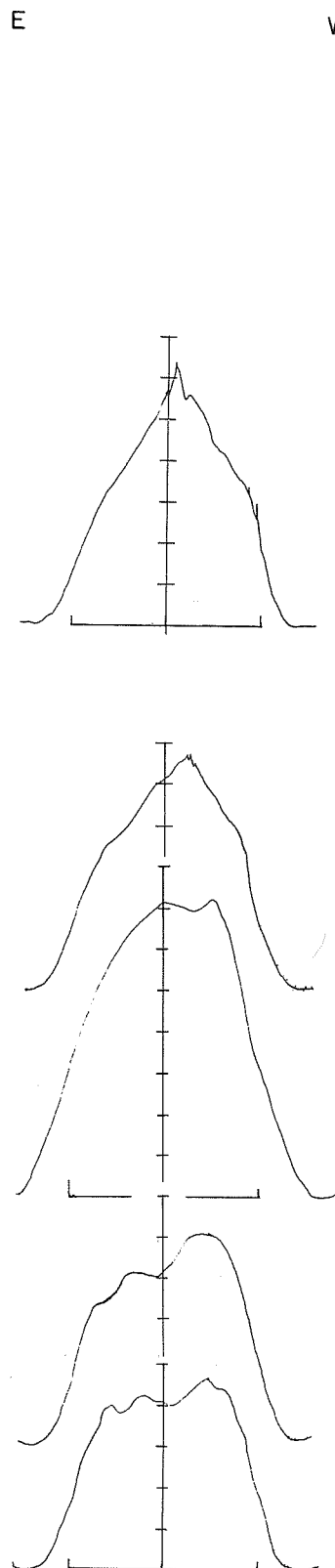
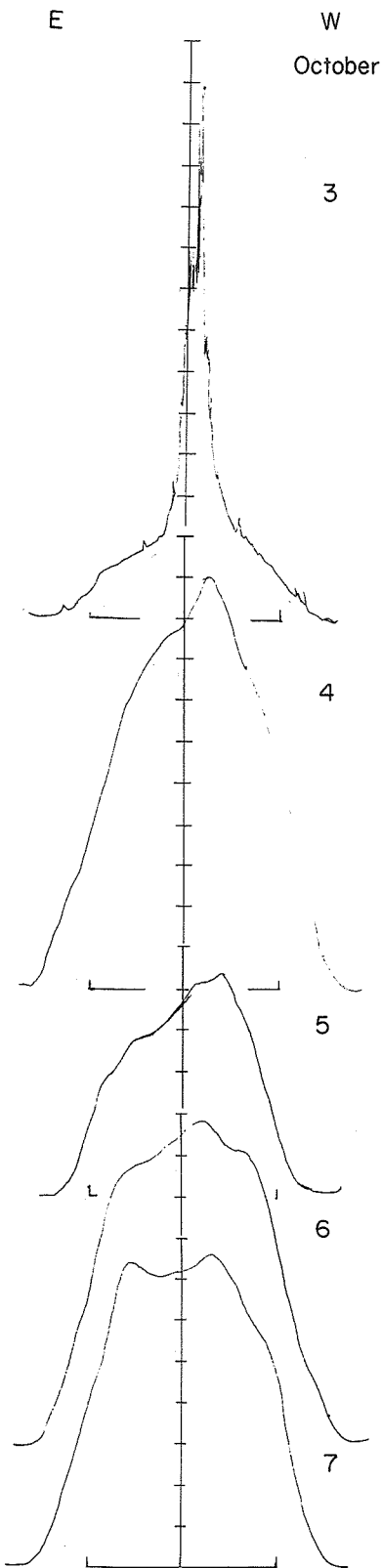

169 MHz

408 MHz

9400 MHz

E

W

E

W

E

W

October

8

9

10

11

12

13

1139 UT

1138 UT

1138 UT

1137 UT

1157 UT

1137 UT

No Data

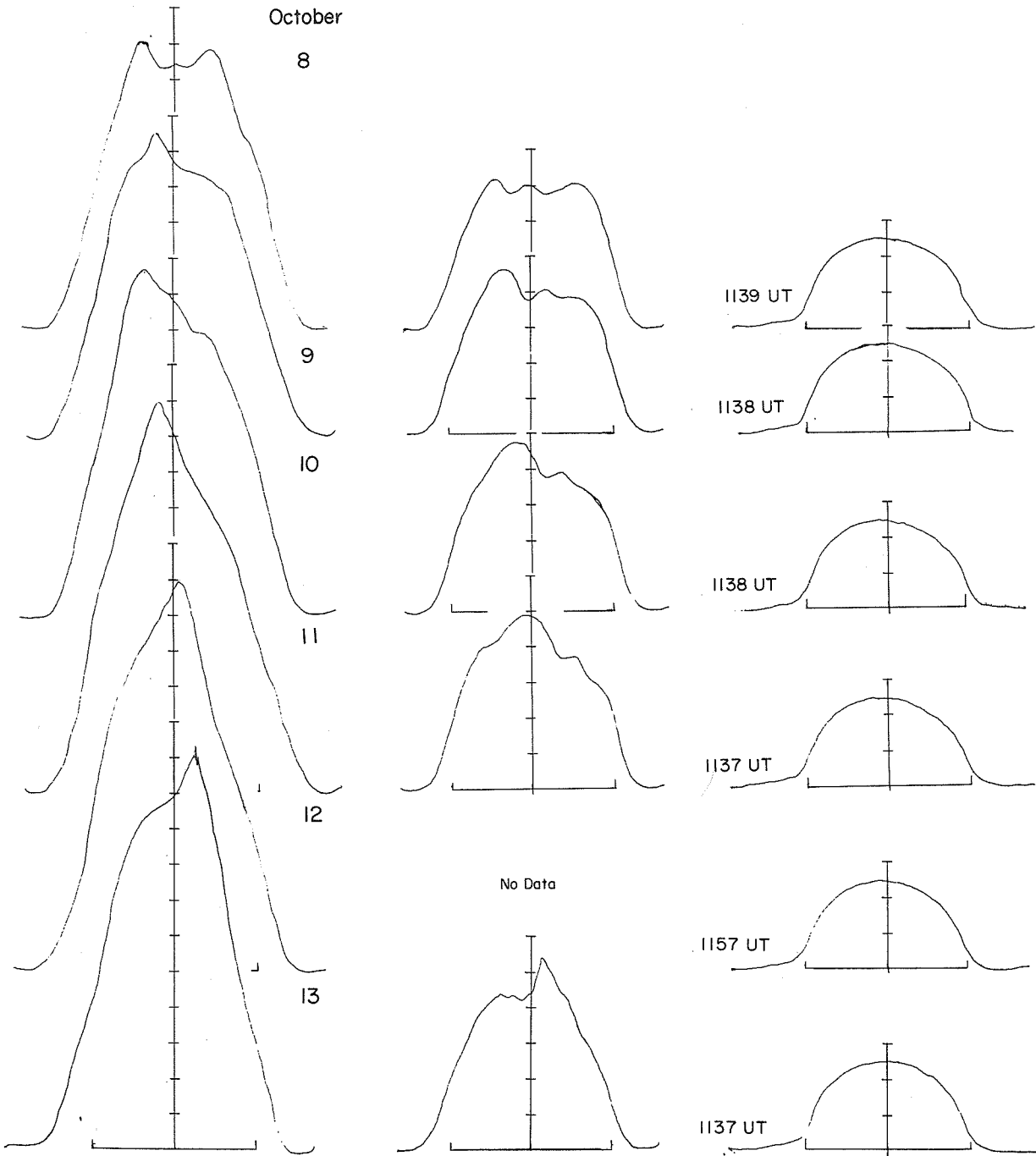

169 MHz

408 MHz

9400 MHz

E

W

E

W

E

W

October

14

15

16

17

18

19

1137 UT

1137 UT

1136 UT

1136 UT

1136 UT

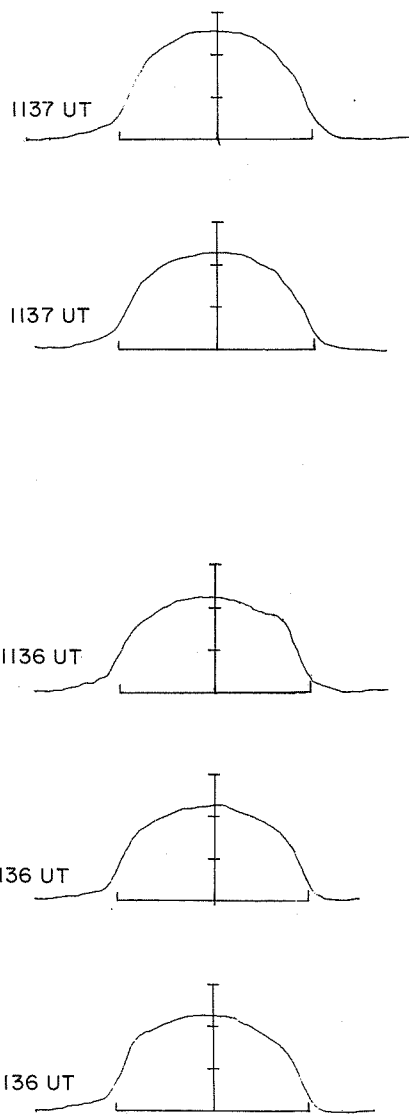
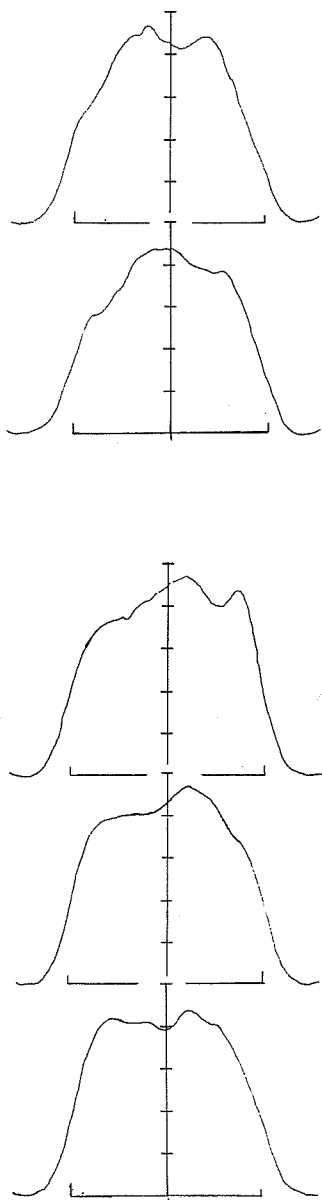
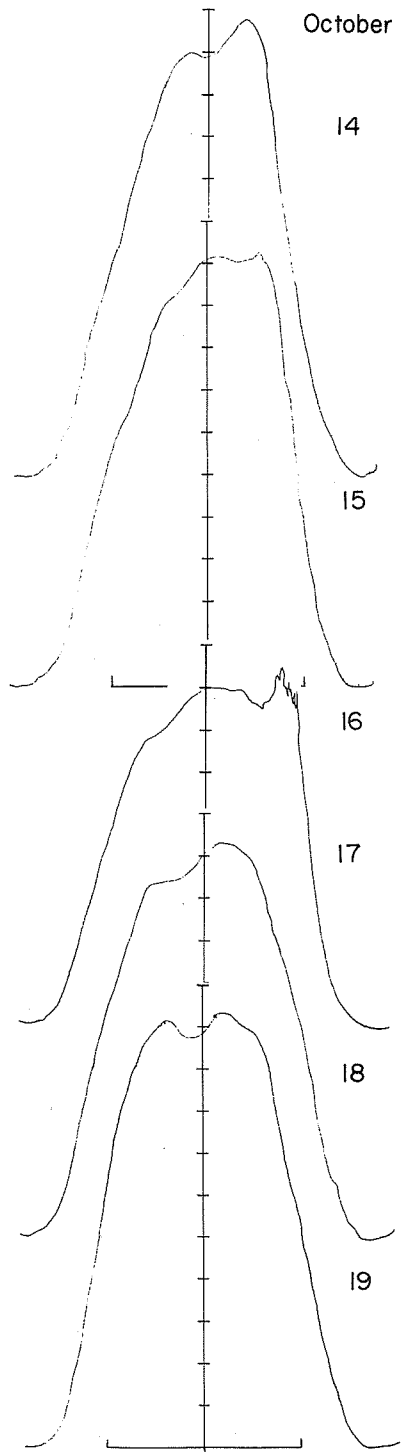

169 MHz

408 MHz

9400 MHz

E

W

E

W

E

W

October

20

21

22

23

24

1136 UT

1136 UT

1135 UT

1135 UT

1135 UT

169 MHz

408 MHz

9400 MHz

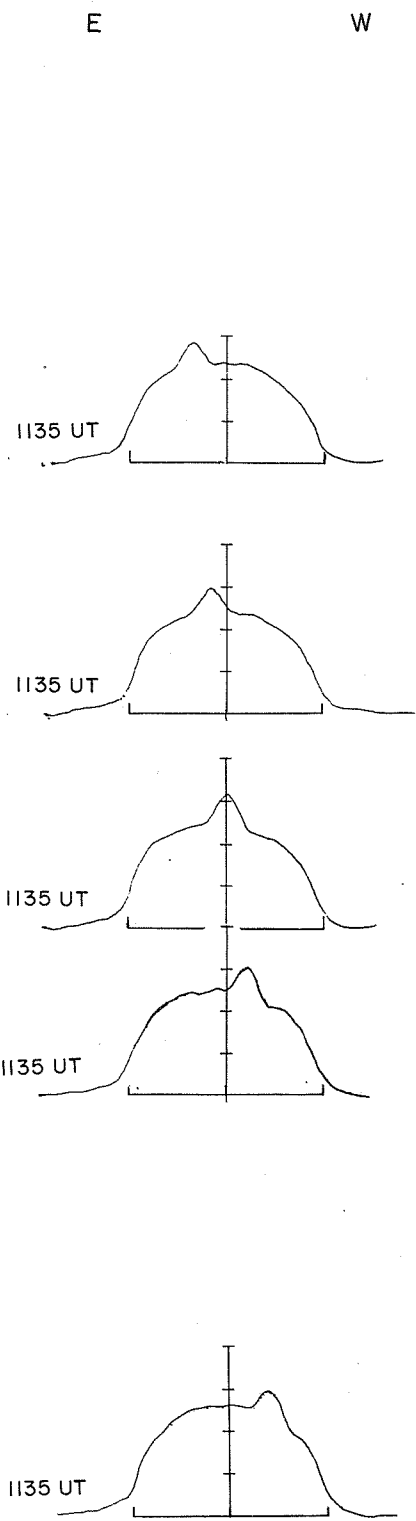
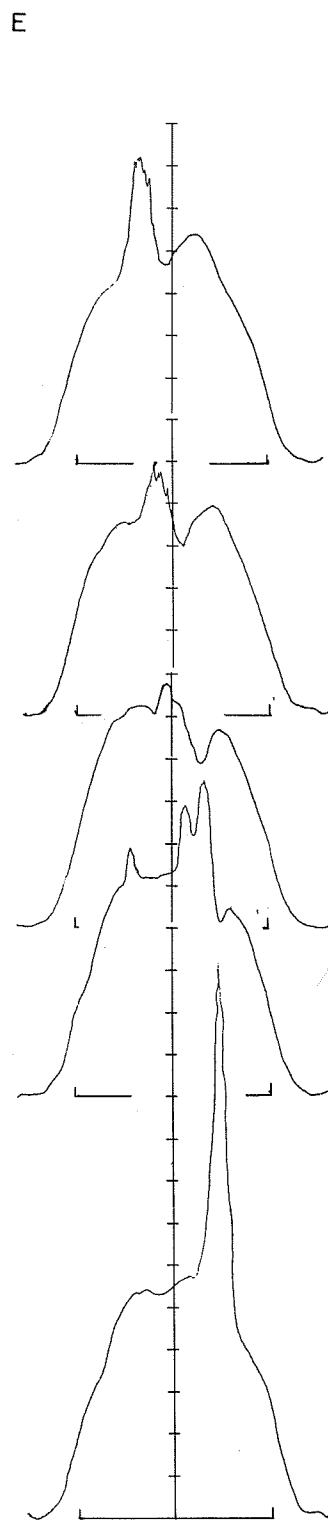
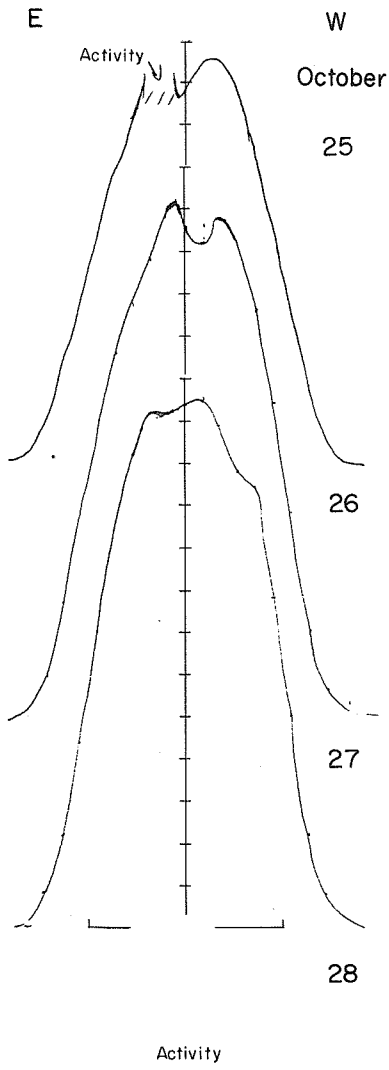

1135 UT

1135 UT

1135 UT

1135 UT

1135 UT

169 MHz

408 MHz

9400 MHz

E

W

E

W

E

W

October

30

Activity

31

Activity

November 1

No Data

2

3

1135 UT

1135 UT

1135 UT

No Data

1135 UT

1135 UT

No Data

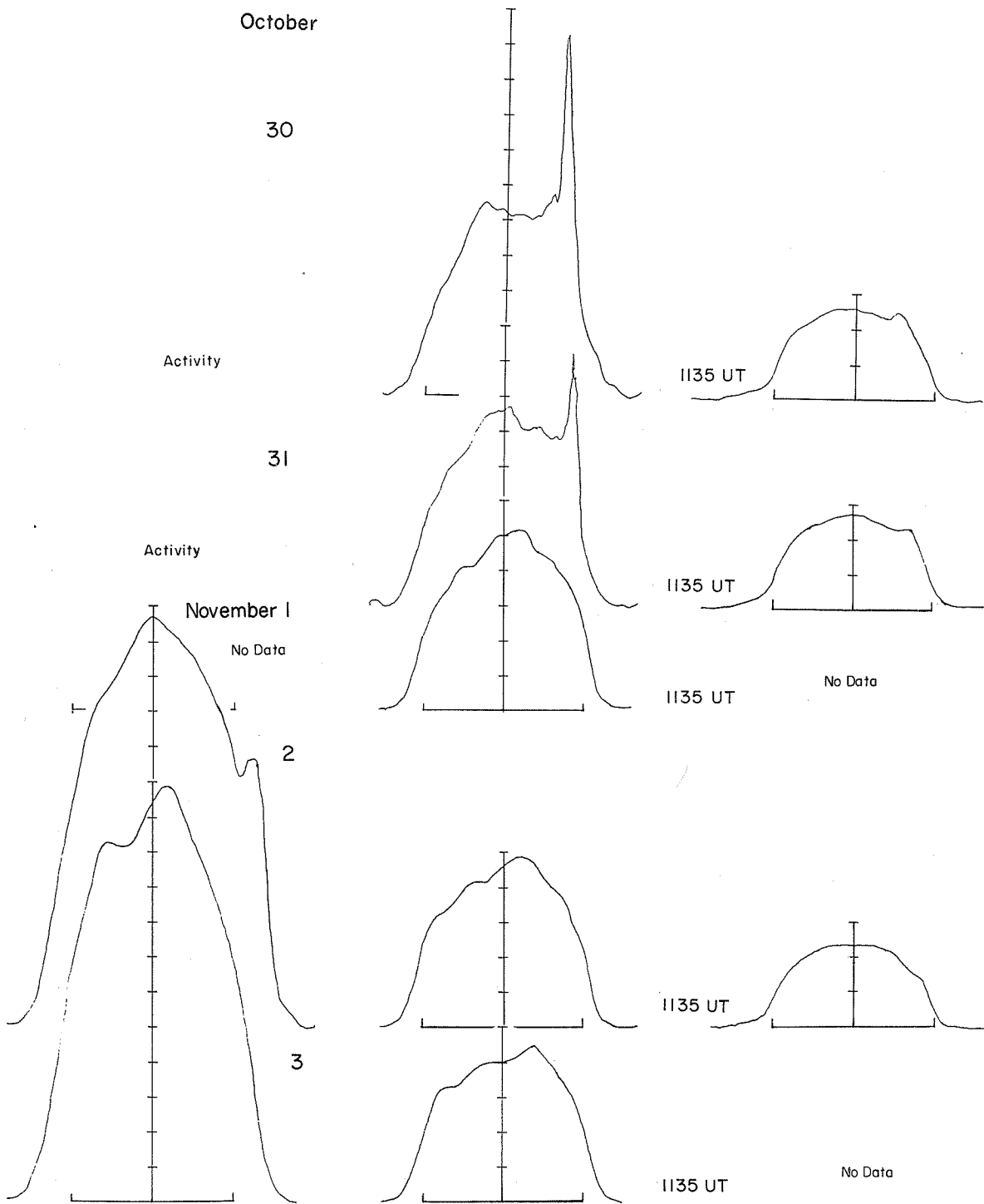

169 MHz

408 MHz

9400 MHz

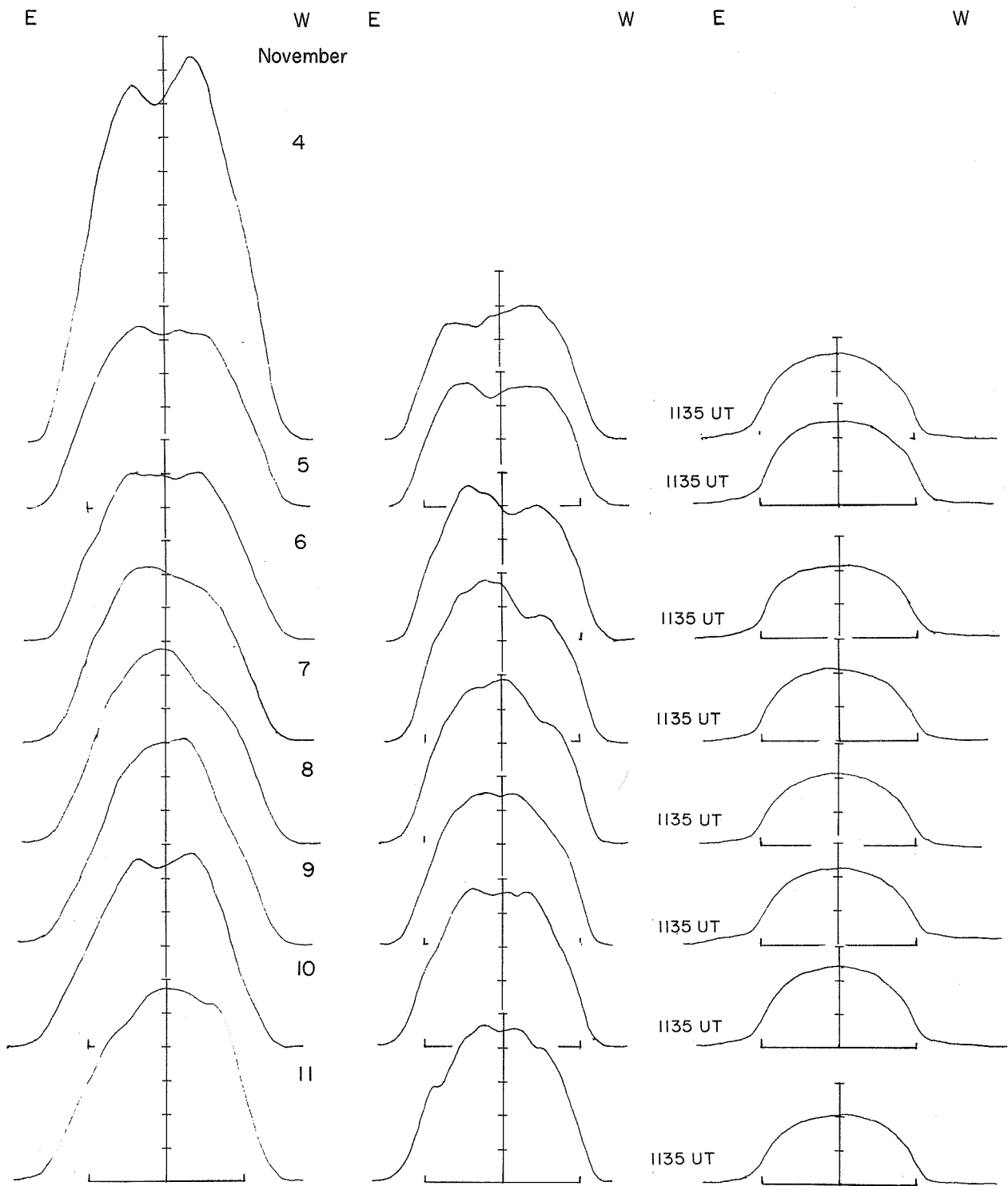

*From November 5 on, change of sensitivity by a factor of 2.

169 MHz

408 MHz

9400 MHz

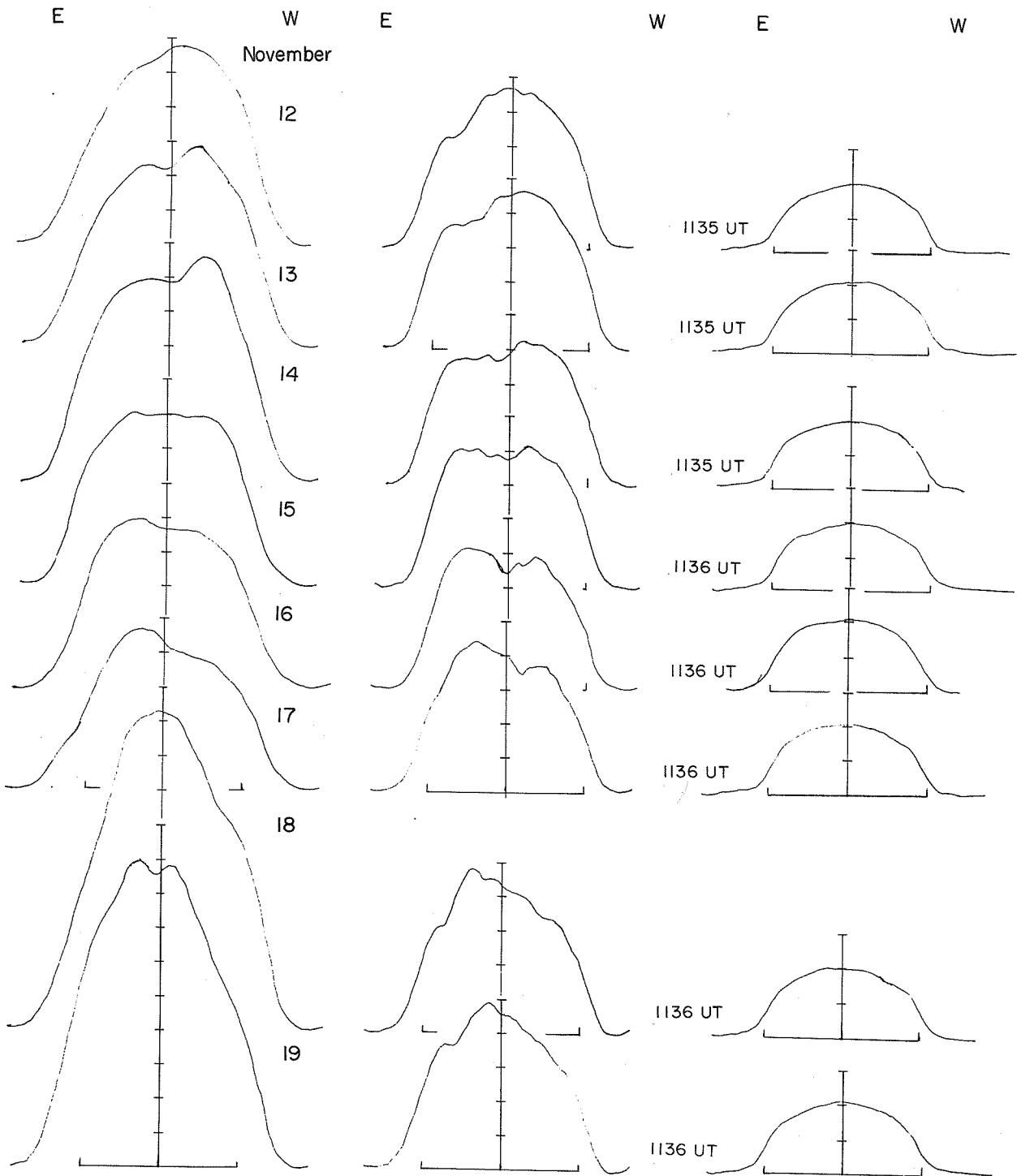

* November 18-20, change of sensitivity by a factor of 2.

169 MHz

408 MHz

9400 MHz

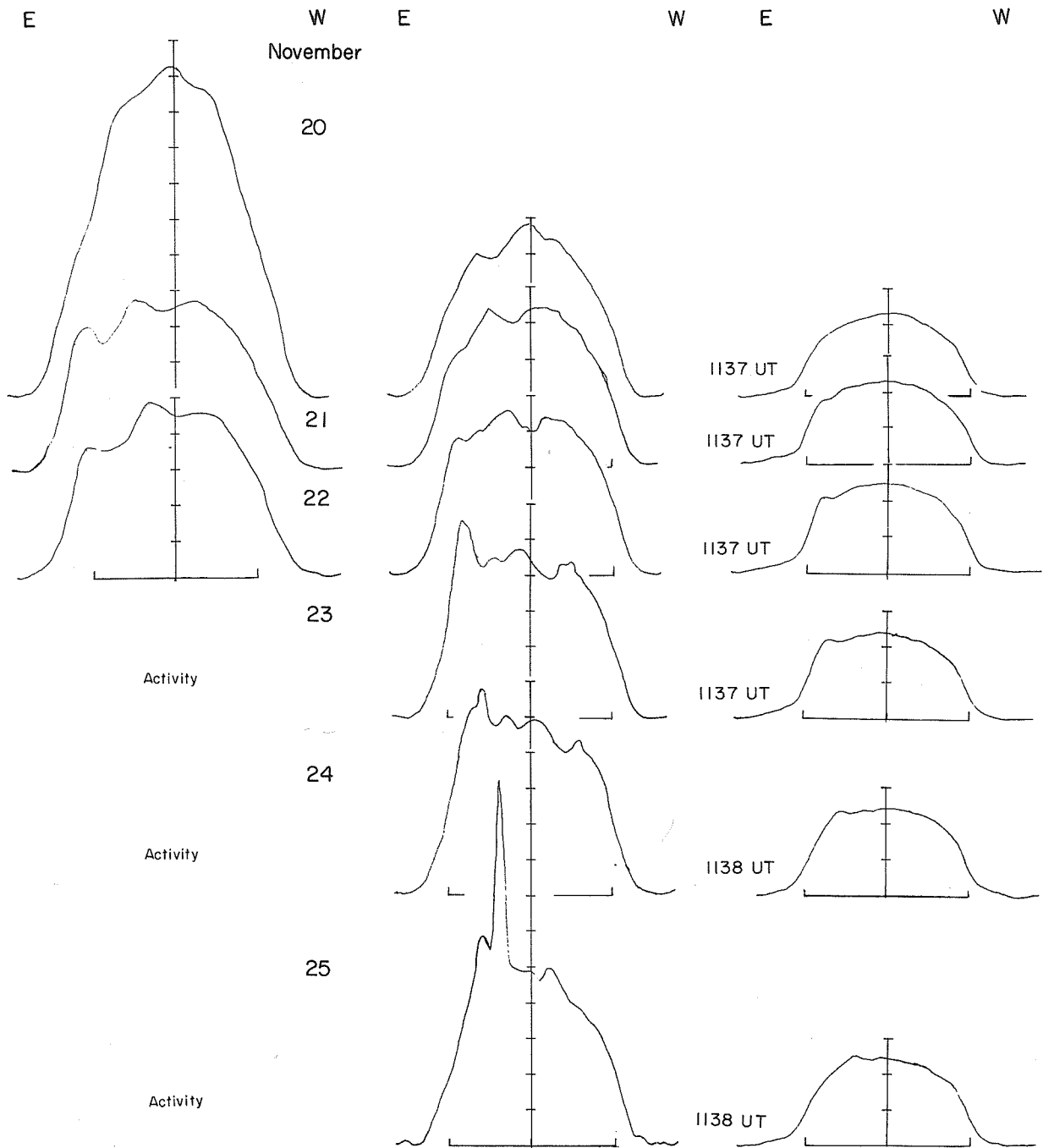

169 MHz

408 MHz

9400 MHz

E W E W E W

November

26

Activity

27

Activity

28

29

30

December 1

1138 UT

1139 UT

1139 UT

1139 UT

1140 UT

1140 UT

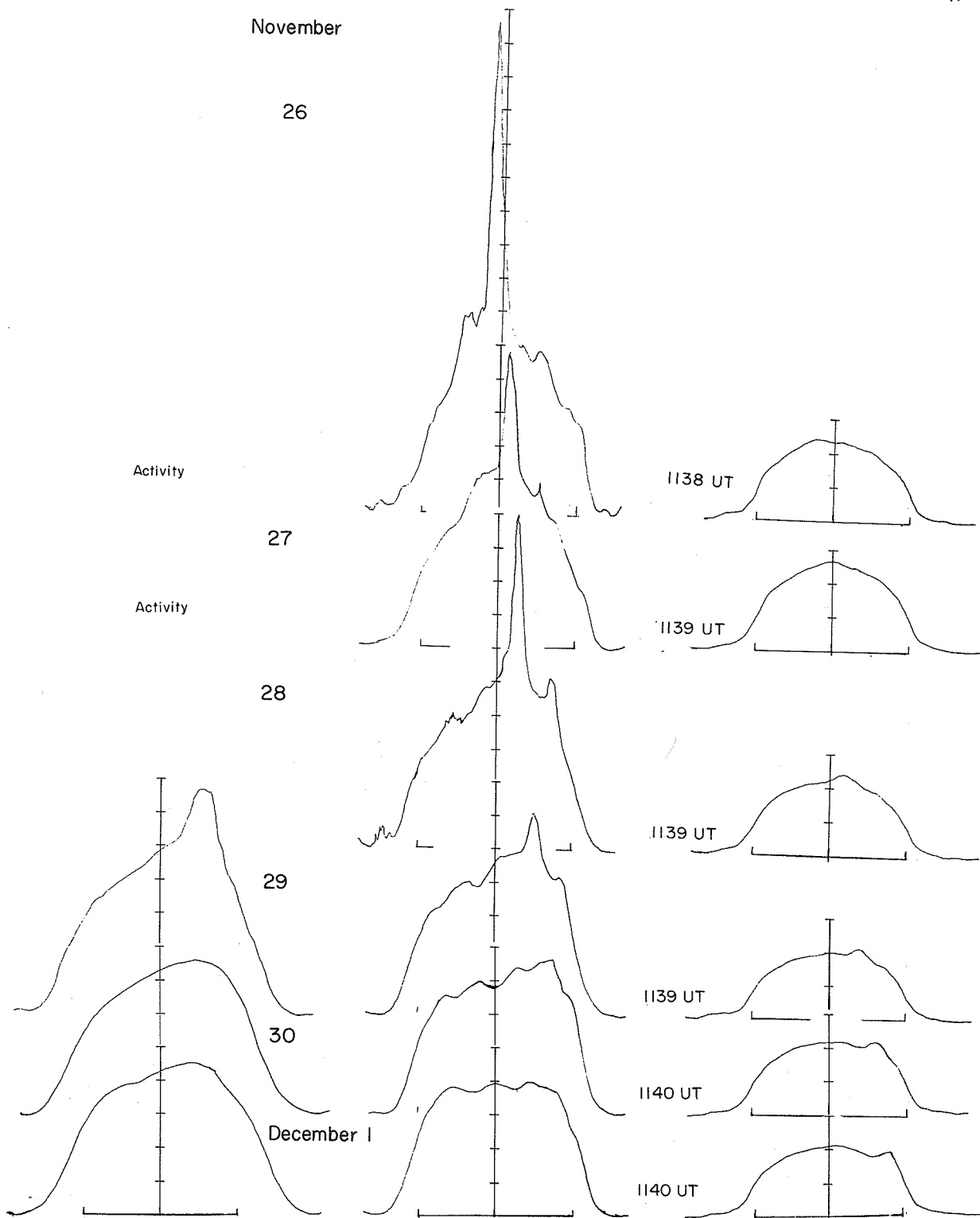

169 MHz

408 MHz

9400 MHz

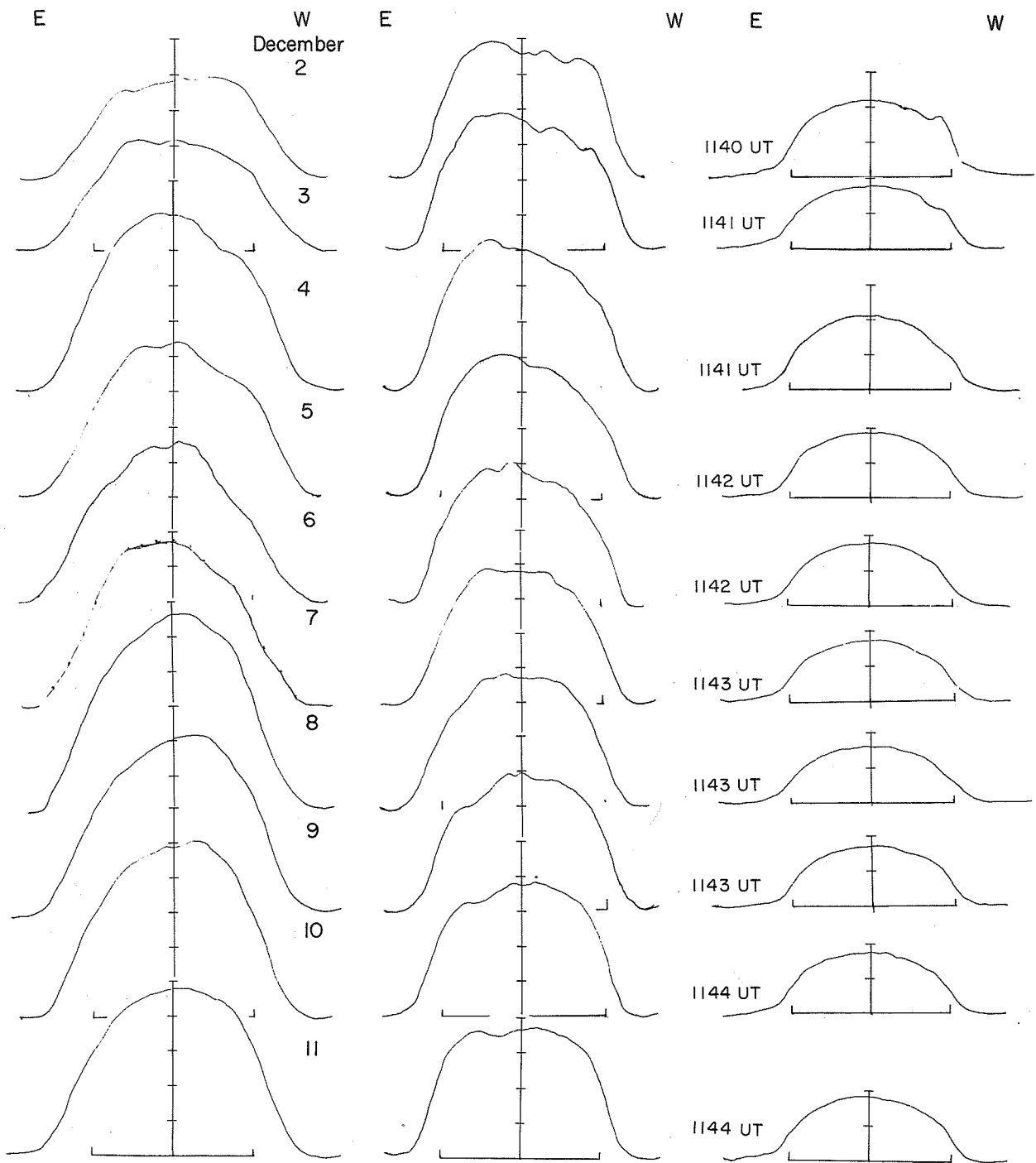

* December 2 and 3, absolute scale is not known for these days.

169 MHz

408 MHz

9400 MHz

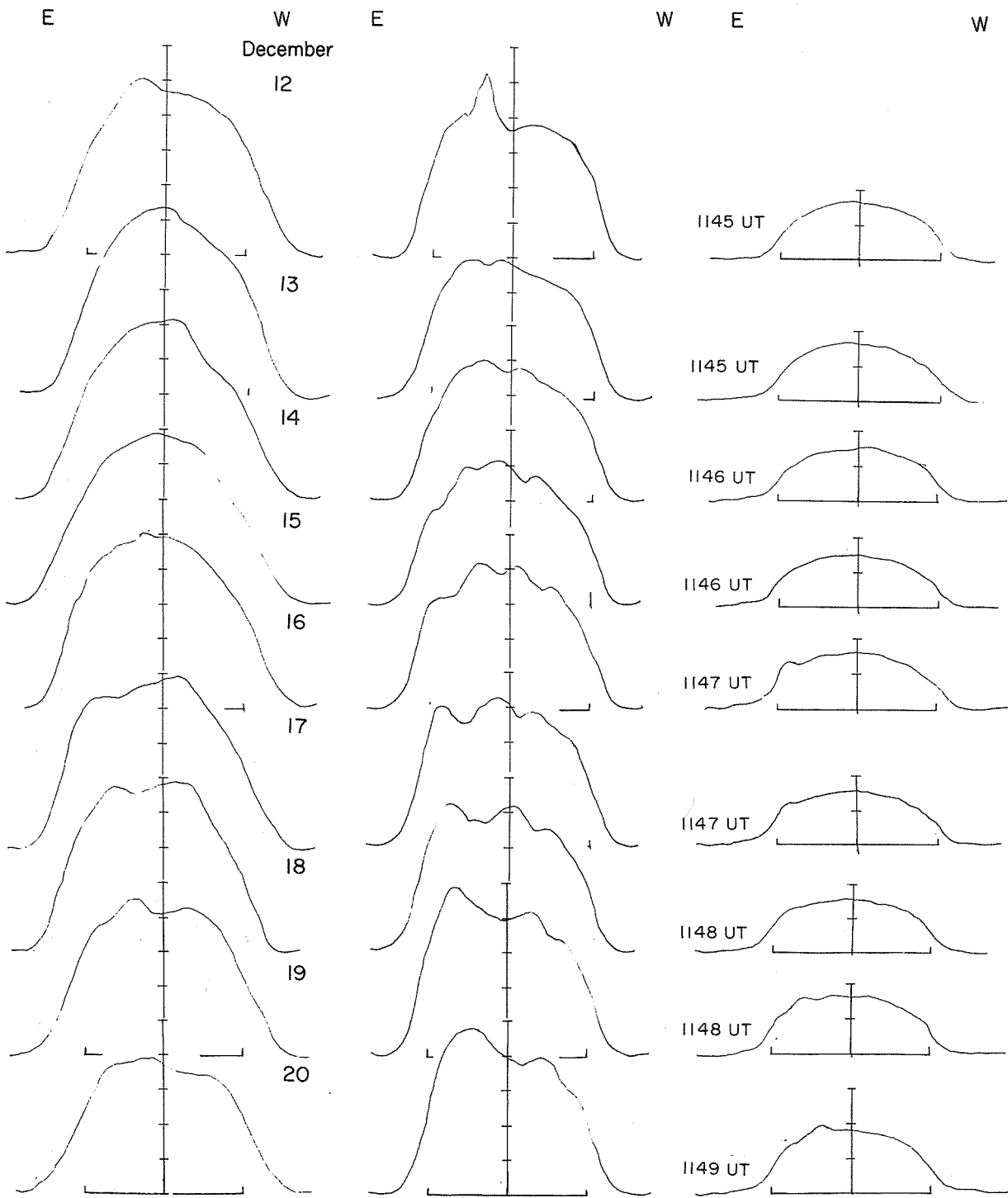

169 MHz

408 MHz

9400 MHz

E

W

E

W

E

W

December

21

22

23

24

25

1149 UT

1150 UT

1150 UT

1150 UT

1151 UT

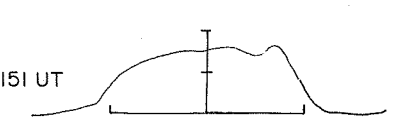
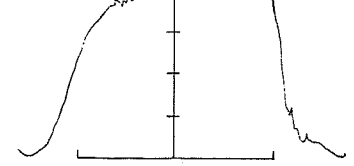
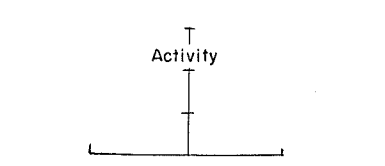
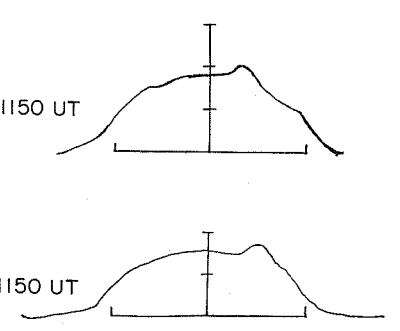
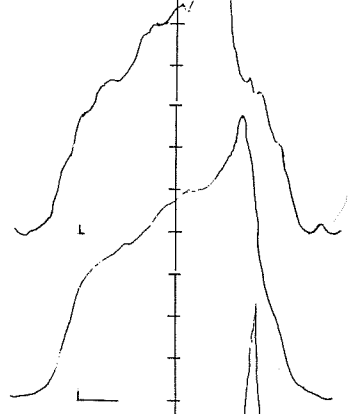
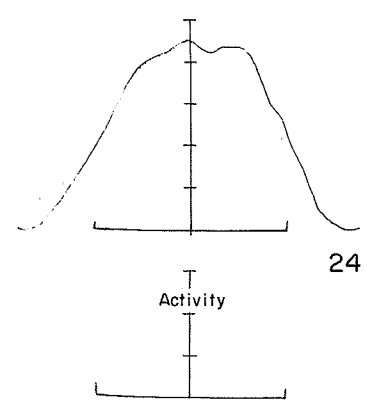
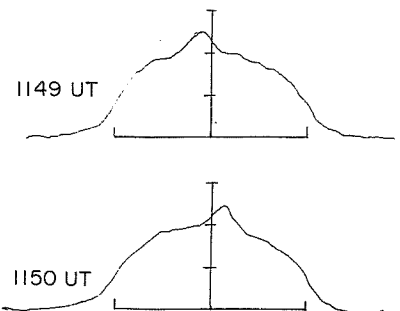
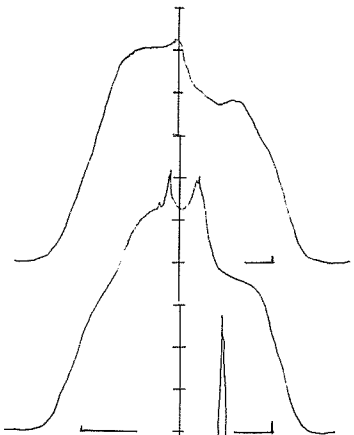
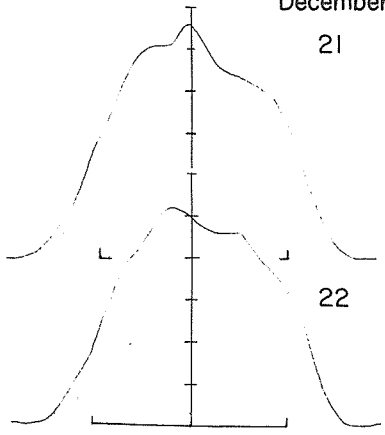

169 MHz

408 MHz

9400 MHz

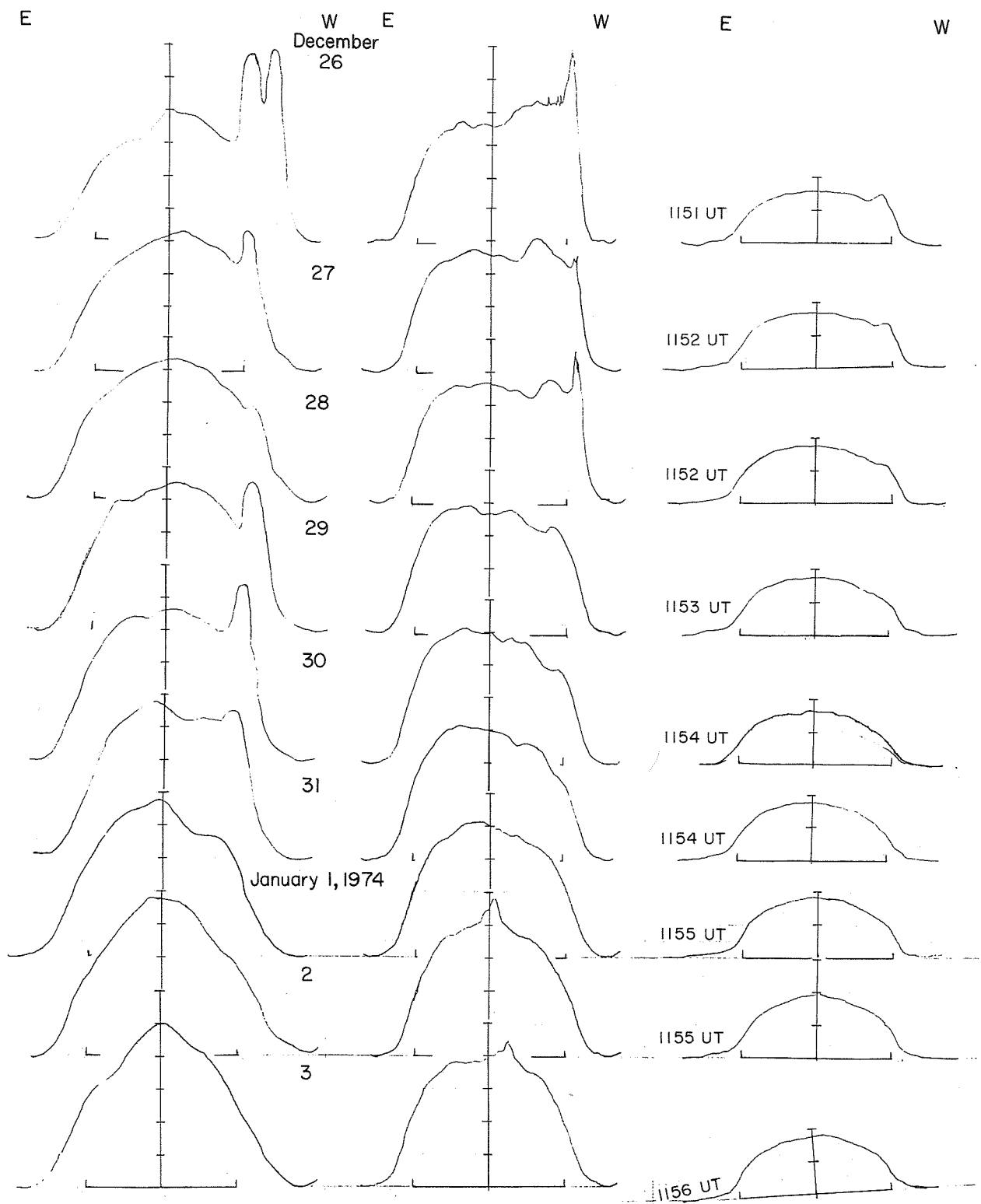

169 MHz

408 MHz

9400 MHz

E

W

E

W

E

W

January
4

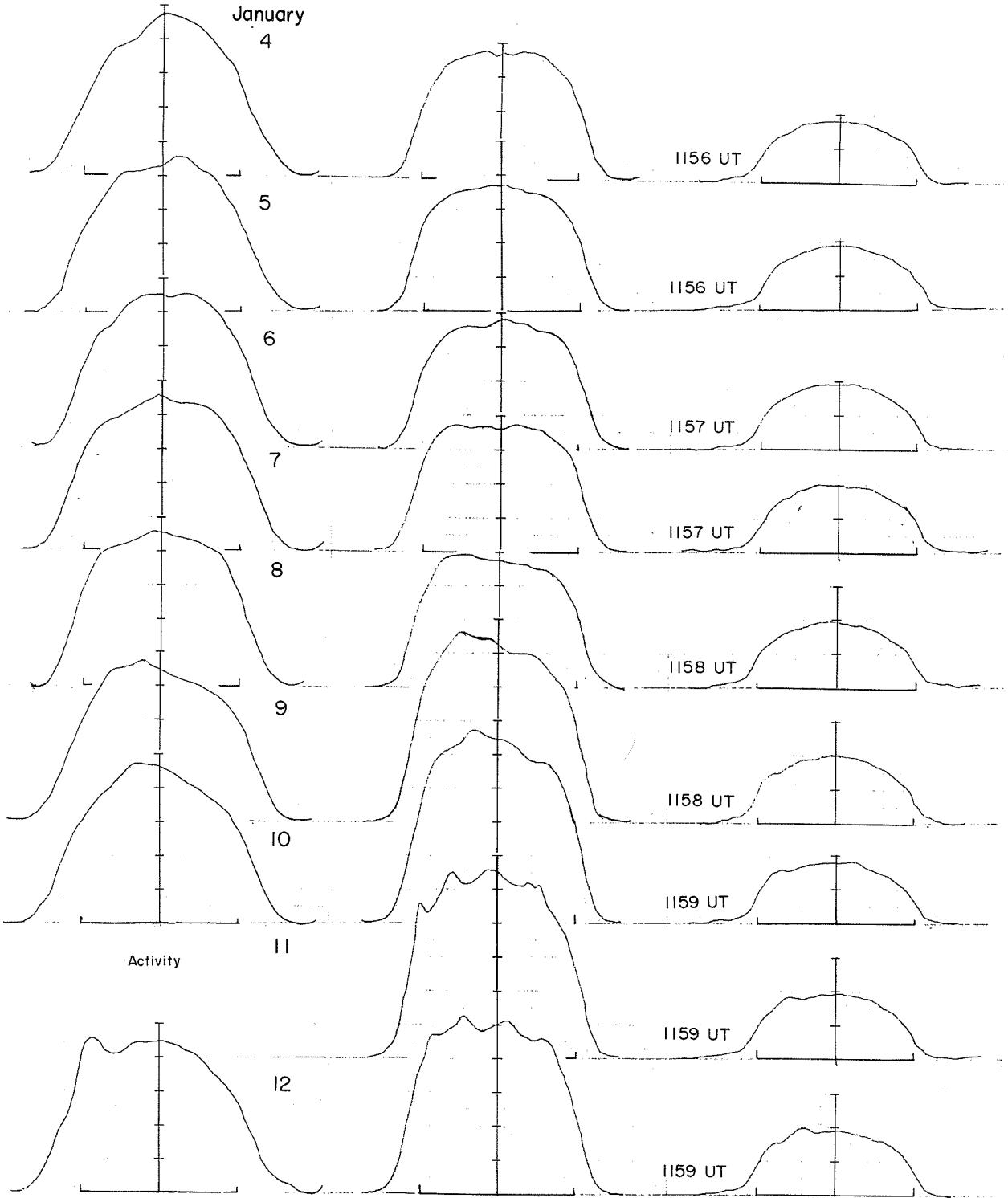

169 MHz

408 MHz

9400 MHz

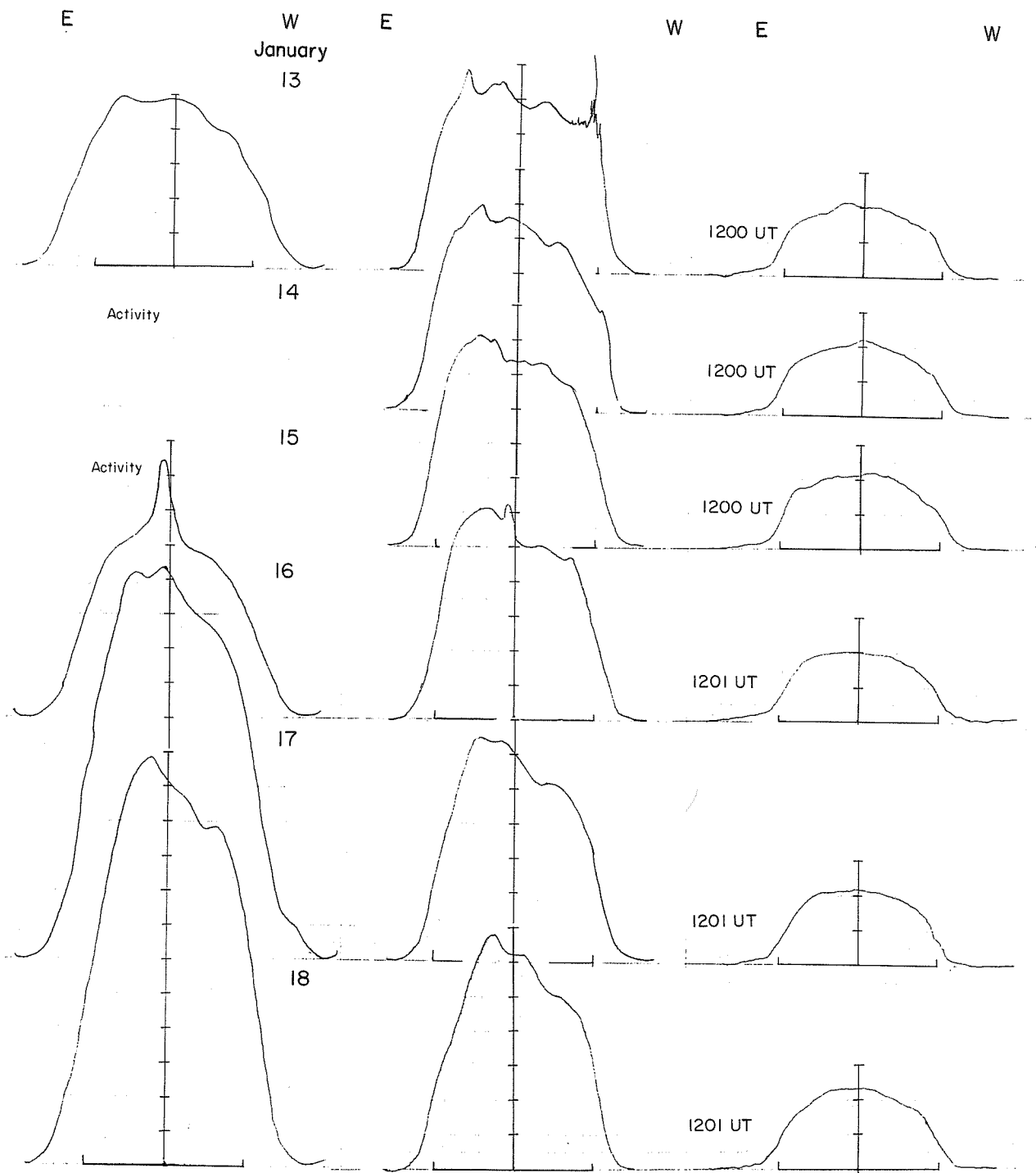

*From January 17, 1974 on, variation of sensitivity by a factor of 2.

169 MHz

408 MHz

9400 MHz

E

W

E

W

E

W

January

19

20

21

22

23

1202 UT

1202 UT

1202 UT

1203 UT

1203 UT

169 MHz

408 MHz

9400 MHz

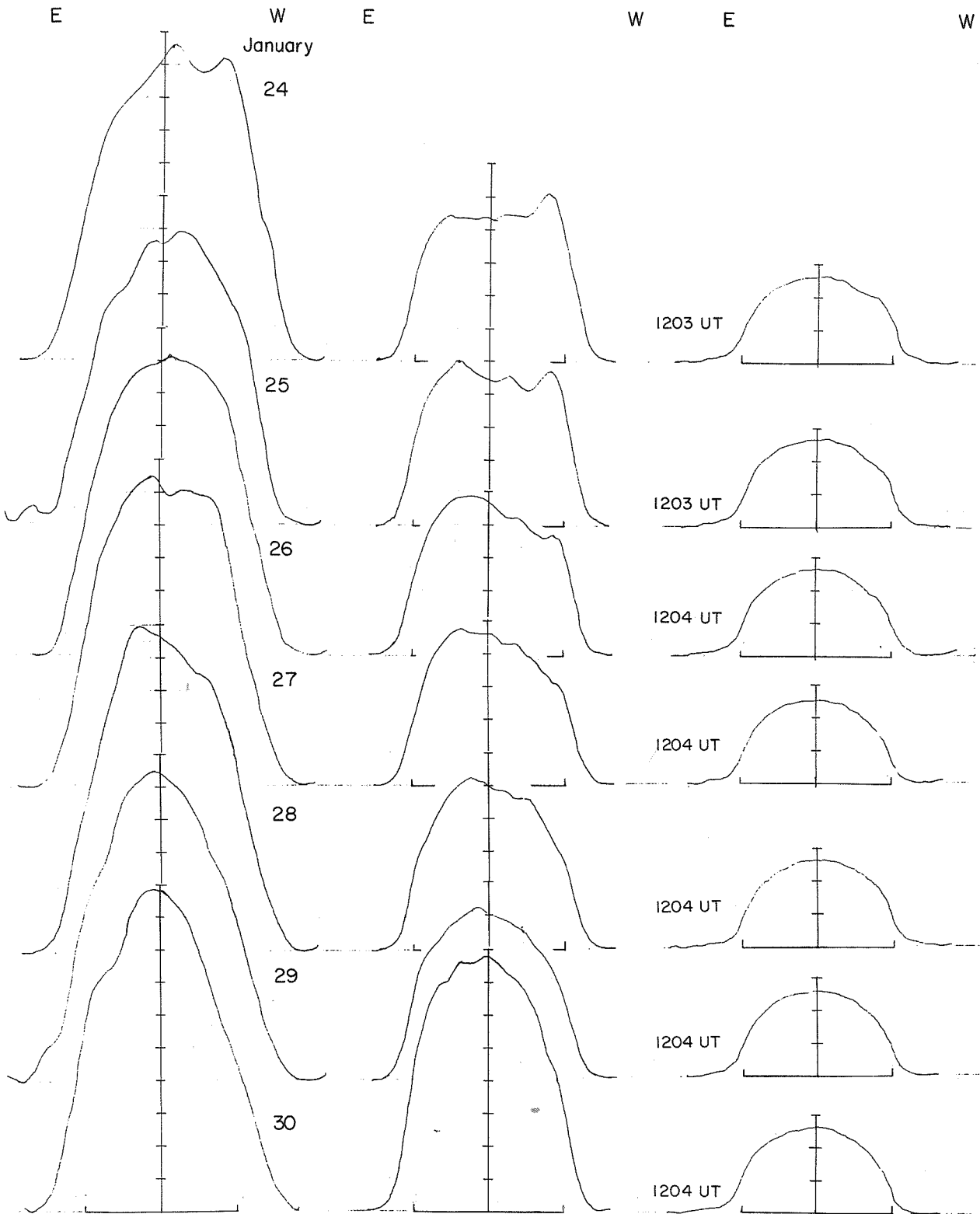

169 MHz

408 MHz

9400 MHz

E

W

E

W

E

W

January

31

February 1

2

3

4

5

6

1204 UT

1205 UT

1205 UT

1205 UT

1205 UT

1205 UT

1205 UT

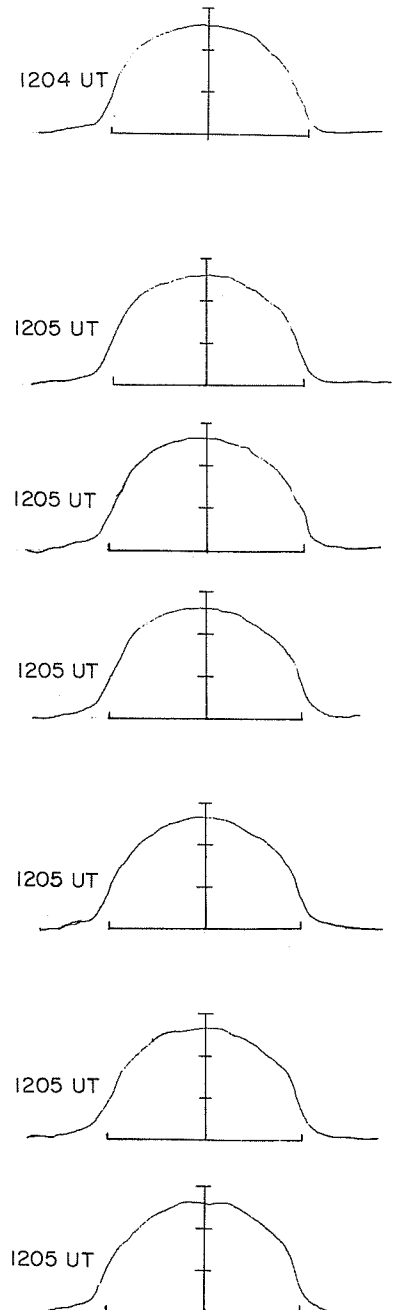
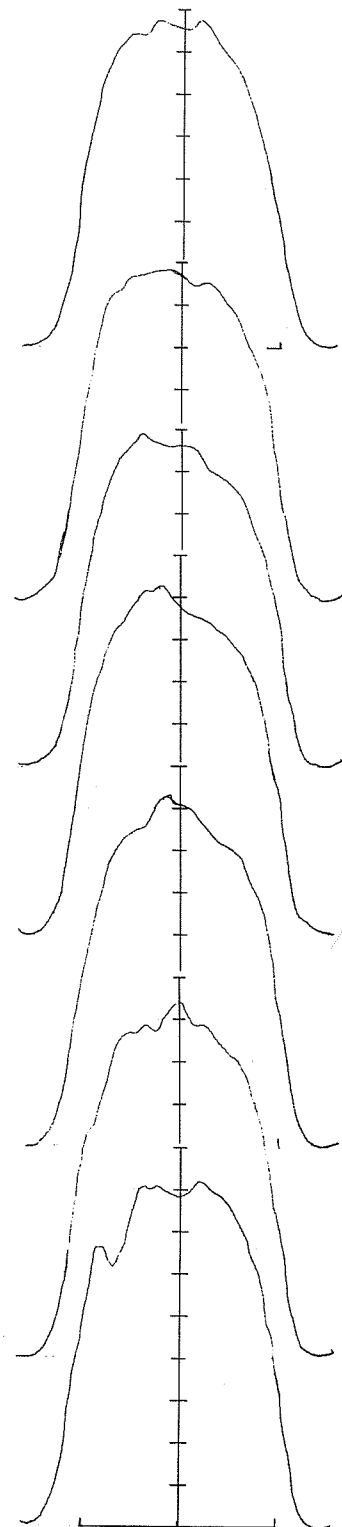
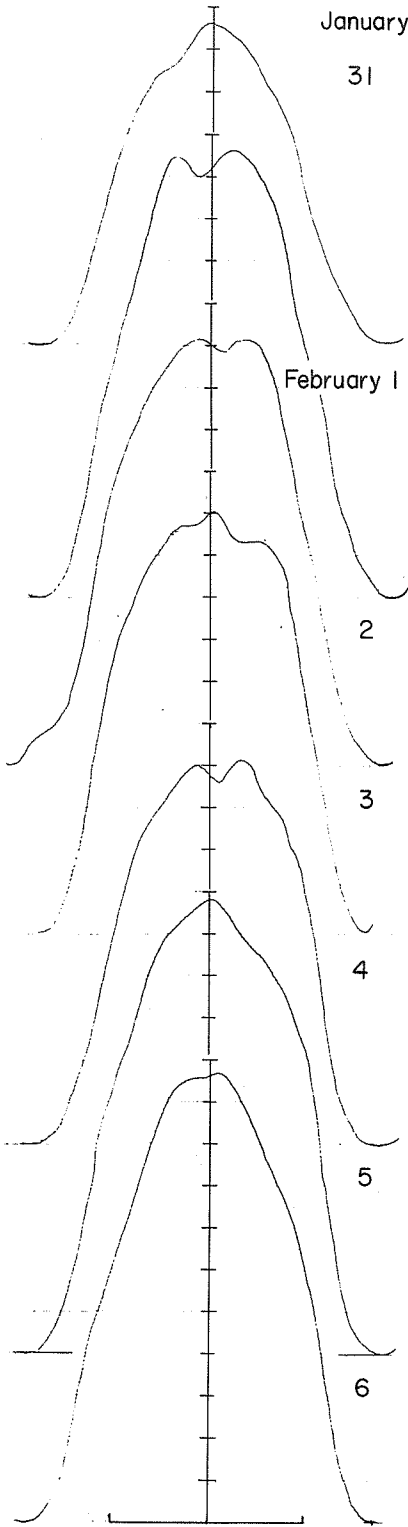

* January 31, 1974, variation of sensitivity by a factor of 2.

169 MHz

408 MHz

9400 MHz

E

W

E

W

E

W

February

7

8

1205 UT

1205 UT

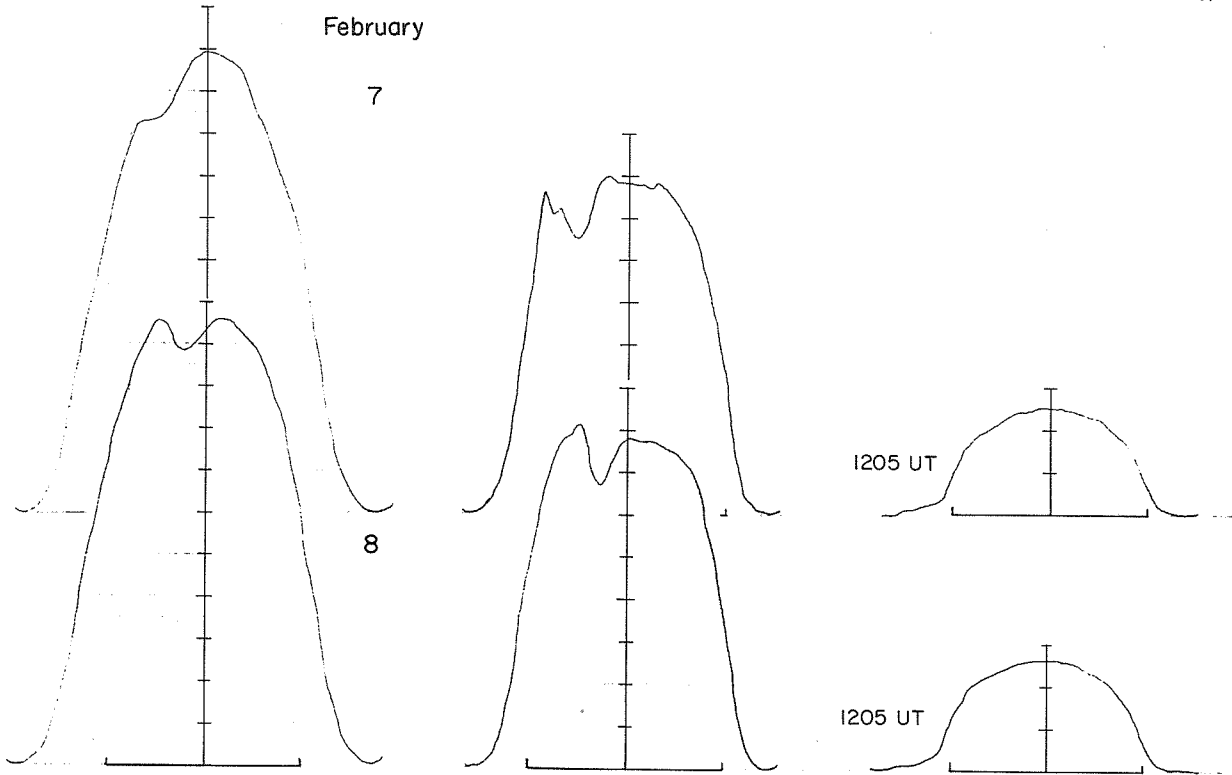

The Johns Hopkins University, Applied Physics Laboratory,
Solar Radio Emission Spectral Observations (565-1000 MHz)

(See Category 6.1.8 in Section II for more information)

A Guide for Classification of Solar Radio Bursts
 Observed with the APL Spectrograph¹ (565-1000 MHz)

TABLE I - Description of the various types of spectra

SPECTRAL TYPE	APL SYMBOL	DESCRIPTION AND COMMENTS
I	1	Storm bursts
II	2	Slow drift bursts
III	3	Fast drift bursts; $\dot{\nu} > 100$ MHz/sec
IV	4	Prolonged continuum
V	5	Brief continuum (normally following type III bursts)
-	6	Intermediate drift bursts; $\dot{\nu} \sim 30-100$ MHz/sec
UNCLF	UNCLF	Unclassified activity.

TABLE II - Symbols appended to the spectral type

SYMBOL	DESCRIPTION
P	Pulsations
G	Small group (< 10) of bursts
GG	Large group (≥ 10) of bursts
C	Underlying continuum
U	U-shaped burst of type III
RS	Reverse-slope burst
DP	Drifting pair
N	Intermittent activity in this period

TABLE III - Intensity Scale

SYMBOL	FLUX DENSITY $\times 10^{-22} \text{ Wm}^{-2} \text{ Hz}^{-1}$
1	25 - 65
2	65 - 650
3	> 650

¹ Gotwols, B. L. and Phipps J., 1972, Solar Phys. 26, 386.

SOLAR RADIO EMISSION
SPECTRAL OBSERVATIONS (565-1000 MHz)

Johns Hopkins University Applied Physics Laboratory

1973								1973									
TIMES OF OBS. (UT)			BURSTS					REMARKS	TIMES OF OBS. (UT)			BURSTS					REMARKS
DATE	START	END	START(UT)	END(UT)	INT.	TYPE	DATE		START	END	START(UT)	END(UT)	INT.	TYPE			
MAY	17	1749	2026	1749.0E	1750.5	2	36G	JULY	01	1210	1925						
				1825.3	1827.1	2	36G		02	1238	1530						
				1827.9	1828.5	1	36G			1600	1953						
				1915.3	1917.9	3	36G		06	1155	1920						
18	1203	1958	1527.4	1531.6	2	4P		07	1229	1449							
19	1210	1926							1456	1930							
20	1211	1936	1654.3	1654.4	1	3G		08	1217	1930							
21	1211	1953						09	1211	1752	1650.3	1650.3	2	3U			
	1714	1749							1820	1938							
	1754	1952						17	1154	1251							
	1855	1955							1307	1432							
24	1345	1415							1502	1805							
	1424	1558							1832	1916							
	1601	1957							1938	1954							
25	1201	1635						13	1156	1918							
	1639	1916						14	1139	1945							
	1823	1959						15	1131	1849							
26	1155	1310						16	1243	1334							
	1322	1619							1357	1649							
	1639	1718							1809	1947							
	1725	1927						21	1129	1725							
27	1205	1543	1331.2	1331.6	1	3G		22	1126	1237							
	1550	1931	1606.2	1607.0	2	36G			1250	1855							
28	1224	1929						23	1226	1314							
29	1638	1956							1352	1544							
31	1206	1957							1547	1731							
JUNE	01	1157	1955						1825	2000							
03	1231	1906						26	1209	1458							
04	1234	1453						29	1128	1856	1309	1353	2	4			
	1459	1751						30	1219	1600							
	1822	2019							1656	1726							
09	1231	1926							1751	1829							
10	1156	1918							1901	1955							
11	1219	1955						AUG.	01	1155	1446						
12	1245	1516							1729	1811							
	1523	2000							1911	1955							
	2004	2047						02	1203	1329							
13	1201	1950	1322.0	1322.0	2	UNCLF	NARROW BANDWIDTH		1554	1732							
14	1201	1432							1801	1955							
	1503	1953						03	1244	1423							
15	1208	1954	1409.3	1409.4	2	3G		04	1130	1842							
16	1224	1535	1422.0	1426.0	3	4P		05	1132	1416							
	1539	1926	1427.9	1428.4	2	3G			1423	1845							
17	1203	1926						06	1214	1712							
									1740	1920							
18	1220	1440						09	1151	1450	1151.0E	1151.8	3	3GU			
	1510	1952							1456	1727	1153.4	1154.1	1	UNCLF			
									1844	1945	1414.9	1415.9	2	3GU			
21	1226	1907									1550.4	1552.6	2	36GU			
	1510	1956						10	1156	1657							
22	1159	1930							1723	1748							
									1805	1826							
23	1238	1852							1855	1943							
25	1214	1356						11	1134	1845							
	1433	1746						12	1137	1847							
28	1858	1920	1858.9	1859.7	2	36G		13	1218	1406							
29	1202	1919	1310.0	1311.5	2	3G			1412	1700							
	1855	1931	1515.4	1517.4	2	4P			1803	1941							
			1908.6	1909.5	1	4		16	1203	1533							
30	1214	1918	1516.3	1518.8	3	36G			1603	1952							

SOLAR RADIO EMISSION
SPECTRAL OBSERVATIONS (565-1000 MHz)

Johns Hopkins University Applied Physics Laboratory

TIMES OF OBS. (UT)		BURSTS				TIMES OF OBS. (UT)		BURSTS					
1973 DATE	START END	START (UT)	END (UT)	INT.	TYPE	REMARKS	1973 DATE	START END	START (UT)	END (UT)	INT.	TYPE	REMARKS
AUG.						OCT.							
17	1157 1429						14	1216 1925					
	1436 1643							15	1631 1755				
	1820 1958							1829 2000					
18	1149 1845						18	1251 1955					
19	1151 1744						19	1219 1332					
	1254 1844							1405 1930					
20	1217 1747						20	1227 1923					
	1318 1449							21	1219 1830				
	1637 1925							22	1243 1945				
23	1156 1418						25	1232 1318	1552.8	1553.0	1	36	
	1450 1524							1352 1605					
	1550 1812							1540 1948					
	1842 1954						26	1224 1447					
24	1201 1454							1450 1945					
	1519 1535						27	1224 1742	1550.0	1550.0	2	UNCLF	
30	1213 1955	1503.5	1503.8	1	36			1555.5	1559.1	2	6GRS		
31	1204 1219							1607	1633	2	4		
	1225 1941						28	1227 1839					
SEP.						NOV.							
01	1204 1526						16	1308 1342					
	1747 1925							1408 1428					
02	1209 1219							1511 1600					
	1422 1535						17	1351 2023					
06	1215 1226						18	1308 1321					
	1346 1359							1324 1336					
	1422 1458						19	1323 1639					
	1622 1647							1737 1838					
	1746 1844							1914 2026					
	1930 1946						20	1333 1345					
07	1211 1320	1218.9	1223.4	2	36G			1405 1423					
	1519 1937	1823.1	1823.3	1	UNCLF			1708 1803					
09	1217 1918							2014 2047					
10	1225 1443	1635.7	1635.7	2	3		24	1324 1351					
	1510 1748							1814 1847					
13	1215 1338							1852 2020					
	1341 1457						25	1303 1340					
	1615 1810						27	1406 1914					
	1818 1944							1917 2106					
14	1208 1423						28	1431 2107					
	1454 1938						29	1308 2031	1750.7	1750.7	1	3	
15	1206 1846						30	1305 1726					
16	1512 1727						DEC.						
17	1217 1422						01	1307 1916					
	1502 1642						02	1318 2004					
	1657 1950						03	1327 1602					
20	1522 1638							1632 2040					
21	1206 1413						04	1319 1431	1349.0	1349.0	2	3	
	1442 1510							1623 2050	1949.6	1950.9	1	36	
	1601 2017								1950.0	1950.1	1	3RS	
22	1216 1404						05	1323 1411					
	1424 1924							1424 1412					
23	1220 1919	1749.9	1750.0	2	36			1620 1655					
24	1339 1425	1759.1	1759.2	1	36			1745 1941					
	1451 1708							2008 2040					
	1730 1813						06	1325 1714					
OCT.						OCT.							
01	1242 1404							1718 1930					
05	1502 1846							2016 2046					
	1850 1946						07	1305 2020					
12	1224 1944	1450.8	1450.9	1	3								
13	1217 1927												

SOLAR RADIO EMISSION
SPECTRAL OBSERVATIONS (565-1000 MHz)

Johns Hopkins University Applied Physics Laboratory

1973								1974									
TIMES OF OBS. (UT)		BURSTS						REMARKS	TIMES OF OBS. (UT)		BURSTS						REMARKS
DATE	START	END	START (UT)	END (UT)	INT.	TYPE	DATE		START	END	START (UT)	END (UT)	INT.	TYPE			
DEC.								JAN.									
08	1313	2015						14	1312	1726							
09	1332	2014							1819	1942							
10	1325	2030							2007	2040							
11	1330	1432						15	1307	1733							
12	1512	1545							1759	1945							
	1938	2110						17	1305	2100							
13	1318	1342						18	1304	1321							
	1521	1907							1935	2054							
	1910	2040						19	1312	1949							
14	1301	1600						20	1320	1606							
	1603	1734							1614	1929							
15	1258	1434						21	1307	1335							
15	1820	2023							1341	1640							
16	1301	1411							1648	1748							
17	1619	1923							1829	1841							
	1927	2020							1859	1921							
18	1328	1949						22	1305	1800							
	2020	2048							1835	1900							
19	1322	1921							1928	2048							
20	1318	2030						23	1344	1522							
21	1314	1619							1526	1702							
	1624	1935							1712	1832							
22	1309	1922							1929	1946							
23	1303	1503							1950	2055							
	1542	1931						24	1310	1340							
24	1322	2110	1521.2	1521.3	3	36			1344	1425							
26	1327	2050							1505	1538							
27	1715	2057							1617	1800							
28	1311	1906							1829	2053							
30	1335	1516						25	1316	1411							
	1553	2027							1417	1548							
31	1310	1540							1702	1729							
	1545	1600							1758	2040							
	1604	1959						26	1309	1937							
JAN. 1974								FEB.									
01	1418	2122						01	1303	1709							
02	1343	2052							1812	2038							
03	1322	1808						02	1308	1552							
04	1316	1422							1558	2033							
	1432	1605						03	1324	2034							
	1620	1818						04	1303	1733							
	2009	2043							1801	2029							
05	1318	1945						05	1302	1411							
06	1330	2027							1428	1654							
07	1313	1935							1729	1845							
09	1429	1746							1849	2039							
10	1504	1957						06	1332	1439							
	2031	2046							1444	1628							
11	1319	1354							1658	2039							
	1449	1712						07	1305	1600							
	1716	1852							1628	2040							
12	1304	1822															
	1826	1947															
13	1311	1945															

APPENDIX

ATM INVESTIGATING TEAMS

Experiment S052, White Light Coronagraph

Dr. Robert M. MacQueen (Principal Investigator)
High Altitude Observatory
National Center for Atmospheric Research
Boulder, Colorado 80302 USA

Also: R. Broussard, A. Csoeke-Poekkh, J. T. Gosling (Co-investigator), E. G. Hildner (Co-investigator),
R. Munro (Co-investigator), A. I. Poland (Co-investigator), and C. Ross

Experiment S054, X-ray Spectrographic Telescope

Dr. Riccardo Giacconi
American Science and Engineering, Inc.
Cambridge, Massachusetts 02139 USA

Also: Giuseppe Vaiana (Principal Investigator), R. Chase, T. Davis, L. Gollub, S. Kahler, A. S. Krieger,
R. Petrasso, K. Silk, and A. Timothy

Experiment S055, UV Scanning Polychromator Spectroheliometer

Dr. E. Edward Reeves (Principal Investigator)
Harvard College Observatory
60 Garden Street
Cambridge, Massachusetts 02138 USA

Also: R. Doyle, A. Dupree, P. Foukal, L. Goldberg, M. C. E. Huber, R. Noyes, W. Parkinson, E. Schmalz,
J. G. Timothy, J. E. Vernazza, and G. L. Withbroe

Experiment S056, Hi-Resolution X-ray Telescopes

Dr. J. Milligan (Principal Investigator)
Marshall Space Flight Center
Huntsville, Alabama 35812 USA

Also: G. Chapman, A. C. deLoach (Co-investigator), E. Frazier, R. Hoover, T. Janssens, J. McGuire,
D. McKencie, J. Underwood (Principal Scientist), A. Walker, and R. Wilson

Experiment S082A, Coronal Spectroheliograph Experiment S082B, Chromospheric Spectrograph

Dr. R. Tousey (Principal Investigator)
U. S. Naval Research Laboratory
4555 Overlook Ave., S. W.
Washington, D. C. 20390 USA

Also: D. Bohlin, G. Brueckner, W. Crockett, T. Makes, R. Mason, O. Moe, K. Nicolas, G. D. Purcell,
V. Scherrer, R. Schumacher, N. Sheeley, M. VanHoosier and K. Widing

Experiment S020, X-ray/UV Solar Photography

Dr. Richard Tousey
U. S. Naval Research Laboratory
4555 Overlook Ave., S. W.
Washington, D. C. 20390 USA

H-Alpha Telescopes

E. Edward Reeves
Harvard College Observatory
60 Garden Street
Cambridge, Massachusetts 02138 USA

COLLABORATORS AFFILIATED WITH EXPERIMENT S052 (HAO WHITE LIGHT CORONAGRAPH)

- M. Altschuler (HAO, NCAR)
Deconvolution of coronal structures
- S. Bame (Los Alamos Scientific Laboratory)
Interplanetary observations of solar wind with IMP 6, IMP 7, and Mariner/Venus/Mercury probes
- H. Bridge (Center for Space Research, MIT)
Interplanetary observations of solar wind with Explorer 47
- H. Courten (Dowling College, New York)
Search for comets at time of the 30 June 1973 eclipse
- A. Dollfus (Paris Observatory)
Balloon-borne coronagraph observations near the eclipse of 30 June 1973
- G. Dulk (University of Colorado/CSIRO, Australia)
Observations of metric radio bursts
- W. Erickson (University of Maryland)
Metric wavelength studies of coronal emission
- R. Fisher (Sacramento Peak Observatory)
Observations of Fe XIV emission in corona
- R. Hansen (HAO, NCAR)
K-coronameter observations of inner corona
- A. Maxwell (Harvard University)
Spectra of metric radio bursts
- Gordon Newkirk (HAO, NCAR)
Density structures of corona and correlation with radio bursts
- G. Pneuman (HAO, NCAR)
Energy balance in coronal structures
- J. Rankin (Iowa State University)
Coronal electron densities determined by observations of pulsar
- B. Rickett (University of California, San Diego)
Interplanetary scintillation measurements
- K. Sheridan (CSIRO, Australia)
Radioheliograph observations of metric solar bursts
- H. Schmidt (Max Planck Institute for Physics and Astrophysics, Munich, Germany)
Perihelion passage of comet Kohoutek
- W. Wagner (Sacramento Peak Observatory)
Coronal cinematography of Fe XIV

COLLABORATORS AFFILIATED WITH EXPERIMENT S054 (MIT X-RAY SPECTROGRAPHIC TELESCOPE)

- L. Acton (Lockheed Research Lab., Palo Alto, CA)
Rocket X-ray spectroscopy
- M. Altschuler (HAO, NCAR, Boulder, Colo.)
Coronal structures
- R. Blake (Univ. of Chicago, Chicago, Ill.)
Rocket X-ray spectroscopy
- R. Bracewell (Stanford Univ., Palo Alto, Calif.)
Radio astronomy
- R. Catura (Lockheed Res. Lab., Palo Alto, Calif.)
Rocket X-ray spectroscopy
- R. T. Hansen (HAO, NCAR, Boulder, Colo.)
White Light Coronal data
- J. Harvey (Kitt Peak Nat'l Obs., Tucson, Ariz.)
Correlation of magnetic field and X-ray structure
- R. Howard (Hale Obs., Pasadena, Calif.)
Correlation of magnetic field and X-ray structure
- W. Livingston (Kitt Peak Nat'l Obs., Tucson Ariz.)
Correlation of magnetic field and X-ray structure
- G. A. Newkirk (HAO, NCAR, Boulder, Colo.)
Coronal structures
- M. Oda (Tokyo Astronomical Obs., Tokyo, Japan)
Solar flare studies
- G. W. Pneuman (HAO, NCAR, Boulder, Colo.)
Coronal structures
- J. A. Pounds and J. H. Parkinson (Univ. of Leicester, Leicester, England)
Rocket X-ray spectroscopy
- G. Righini (Arcetri Astrophysical Obs., Florence, Italy)
Magnetic field separator and chromospheric models of X-ray emitting structures
- E. Roelof (Applied Physics Lab, Johns Hopkins U.)
Interplanetary extension of the corona
- Z. Svestka (American Science and Engineering, Cambridge, Mass.)
Type III Bursts in active regions

COLLABORATORS AFFILIATED WITH EXPERIMENT S054 (MIT X-RAY SPECTROGRAPHIC TELESCOPE) - (Continued)

- | | |
|--|---|
| J. Jeffries (Univ. of Hawaii, Honolulu, Hawaii)
Coronal Observation of active regions/forbidden line intensity ratios | T. Takakura (Tokyo Astronomical Obs., Tokyo, Japan)
Solar flare studies |
| M. Landini (Arcetri Astrophysical Obs., Florence, Italy)
Models of X-ray emission structures | J. Wilcox (Stanford Univ., Palo Alto, Calif.)
Solar sector structure |
| A. Lazarus (MIT, Cambridge, Mass.)
Solar wind studies | J. B. Zirker (Univ. of Hawaii, Honolulu, Hawaii)
Coronal Observation of active regions/forbidden line intensity ratios |

COLLABORATORS AFFILIATED WITH EXPERIMENT S055 (HCO UV SCANNING POLYCHROMATOR SPECTROHELIO METER)

- | | |
|---|---|
| J. M. Beckers (Sacramento Peak Obs., Sunspot, N.M.)
Chromospheric oscillations and quiet sun extension of the network into corona | G. A. Newkirk (HAO, NCAR, Boulder, Colo.)
Coronal transients |
| A. Gabriel (Aru Culham Lab., Abingdon, U.K.)
Line identification and abundances;
1973 eclipse | R. W. Nicholls (York Univ., Canada)
1973 eclipse and lunar observations |
| D. N. Hall (Kitt Peak Nat'l Obs., Tucson, Ariz.)
Chromospheric oscillations; excitation of helium in network; prominences and active regions | R. Norton (NOAA, Boulder, Colo.)
Structure of terrestrial atmosphere |
| R. T. Hansen (HAO, NCAR, Boulder, Colo.)
Coronal transients | F. Q. Orrall (Univ. of Hawaii, Honolulu, Hawaii)
Solar prominences |
| J. W. Harvey (Kitt Peak Nat'l Obs., Tucson, Ariz.)
Excitation of helium in network; prominences and active regions | G. Simon (Sacramento Peak Obs., Sunspot, N. M.)
Chromospheric oscillations; quiet sun extension of network into corona |
| R. D. Hudson (Johnson Space Center, Houston, Tex.)
Structure of terrestrial atmosphere | C. Slaughter (Kitt Peak Nat'l Obs., Tucson, Ariz.)
Chromospheric oscillations |
| J. Jeffries (Univ. of Hawaii, Honolulu, Hawaii)
Solar prominences | R. J. Speer (Aru Culham Lab., Abingdon, U.K.)
1973 solar eclipse |
| C. Jordan (Aru Culham Lab., Abingdon, U.K.)
Line identification and abundances;
1973 eclipse | E. Tandberg-Hanssen (Marshall Space Flight Center, Huntsville, AL.)
Solar prominences |
| W. C. Livingston (Kitt Peak Nat'l Obs., Tucson, Ariz.)
Solar prominences | J. B. Zirker (Univ. of Hawaii, Honolulu, Hawaii)
Solar prominences |

COLLABORATORS AFFILIATED WITH EXPERIMENT S056 (MSFC HI-RESOLUTION X-RAY TELESCOPES)

- | | |
|---|--|
| L. Acton and R. Catura (Lockheed Res. Lab., Palo Alto, Calif.)
Rocket X-ray Spectroscopy of coronal regions | D. S. Intriligator (Calif. Inst. of Tech., Pasadena, Calif.)
Relationship between coronal X-ray structure, interplanetary sector structure and solar wind |
| R. Blake (Univ. of Chicago, Chicago, Ill.)
Rocket X-ray spectroscopy of coronal regions | J. H. Parkinson and J. A. Pounds (Univ. of Leicester, Leicester, England)
Rocket X-ray spectroscopy of coronal regions |
| D. W. Datlowe and L. Peterson (Univ. of California, San Diego, Calif.)
Studies of hard X-ray flares with OSO-7 | D. Rust (American Science and Engineering, Cambridge, Mass.) |
| G. Elwert (Univ. of Tuebingen, Tuebingen, West Germany)
Structure of active regions | J. B. Zirker (Univ. of Hawaii, Honolulu, Hawaii) |
| W. Glencross (Univ. College London, London, England)
Evolution of active regions | A. B. Walker (Aerospace Corp., Los Angeles, Calif.)
Rocket X-ray spectroscopy of coronal regions |

COLLABORATORS AFFILIATED WITH EXPERIMENT S082A and S082B (NRL CORONAL SPECTROHELIOGRAPH AND CHROMOSPHERIC SPECTROGRAPH)

- C. Brown (NRL, Wash., D. C.)
Atmospheric model calculations; distribution of Ozone and NO_x
- G. Doschek (NRL, Wash., D. C.)
Flare studies
- B. Edlén (Lund, Sweden)
Identification of XUV emission lines
- A. Green (Univ. of Florida, Gainesville, Fla.)
Solar spectrum from 2000A to 3000A relating to Ozone
- F. Hudson (Sandia Corp., Albuquerque, N. M.)
Atmospheric model calculations; distribution of Ozone and NO_x
- R. Kelly (Naval Post-Grad. School, Monterey, CA)
Identification of lines of XUV solar spectrum
- R. Kreplin (NRL, Wash., D. C.)
Comparison of SOLRAD and ATM data
- J. Linsky (Univ. of Colo., Boulder, Colo.)
Model solar atmosphere calculations
- M. Longmire (Western Kentucky Univ.)
Distribution of O₂ in earth atmosphere from observations of Schumann-Runge band
- R. Meier (NRL, Wash., D. C.)
Distribution of Hydrogen and Oxygen in earth atmosphere
- D. Prinz (NRL, Wash., D. C.)
Distribution of Hydrogen and Oxygen in earth atmosphere
- G. Simon (Sacramento Peak Obs., Sunspot, New Mexico)
Chromospheric network studies
- R. A. Skrivanek (AFCL, Bedford, Mass.)
Chromospheric network studies, XUV Flare observation studies
- S. Tilford (NRL, Wash., D. C.)
Distribution of Ozone and NO_x and Atmospheric model calculations
- J. Zirker (Univ. of Hawaii, Honolulu, Hawaii)
Flare and active region studies

SKYLAB/ATM

COORDINATED GROUND-BASED OBSERVATIONS

DAILY FORM

Send to:

J. Virginia Lincoln, DF63
World Data Center A
for Solar-Terrestrial Physics
NOAA
Boulder, Colorado 80302

Date _____

1. Station _____ 2. Investigator _____

3. Type: Ground-based / Satellite / Rocket

4. Program: Filtergram / Spectroheliogram / Coronagraph / Spectra /
Magnetogram / Velocity Measurements / Other

Specifics:

A

5. Observing Times and Rates:

M

6. Wavelengths:

7. Measurements: Full disk / Field of view in arc sec and center of field by position angle
and radius vector or by heliocentric coordinates

P

7a. Measurements intended for coordination with JOP(s):

8. Slit (Dimensions in arc sec; Position as in item 7 plus orientation):

9. Spectral Dispersion in A/mm:

L

10. Film Type:

11. Image Scale of Original Film:

12. Data Format Available:

- A. Original film / Duplicate negatives / Prints
Microphotometry / Photoelectric scan / Digitized (card/tape)/
Computer plot / Strip charts / Tabulation / Other
- B. Direct scientist-to-scientist / through World Data Centers

E

13. Quality (Subjective or scattered light or noise level):

14. Equipment Failure Details:

15. Other Pertinent Information:

UAG Series of Reports

Prepared by World Data Center A for Solar-Terrestrial Physics, NOAA, Boulder, Colorado, U.S.A.

These reports are for sale through the National Climatic Center, Federal Building, Asheville, NC 28801, Attn: Publications. Subscription price: \$25.20 a year; \$12.00 additional for foreign mailing; single copy price varies. These reports are issued on an irregular basis with 6 to 12 reports being issued each year. Therefore, in some years the single copy rate will be less than the subscription price, and in some years the single copy rate will be more than the subscription price. Make check or money order payable to: Department of Commerce, NOAA.

Some issues are now out of print and are available only on microfiche as indicated. Requests for microfiche should be sent to World Data Center A for Solar-Terrestrial Physics, NOAA, Boulder, Co 80302, with check or money order made payable to Department of Commerce, NOAA.

- UAG-1 "IQSY Night Airglow Data", price \$1.75.
- UAG-2 "A Reevaluation of Solar Flares, 1964-1966", price 30 cents.
- UAG-3 "Observations of Jupiter's Sporadic Radio Emission in the Range 7.6-41 MHz, 6 July 1966 through 8 September 1968", microfiche only, price 45 cents.
- UAG-4 "Abbreviated Calendar Record 1966-1967", price \$1.25.
- UAG-5 "Data on Solar Event of May 23, 1967 and its Geophysical Effects", price 65 cents.

- UAG-6 "International Geophysical Calendars 1957-1969", price 30 cents.
- UAG-7 "Observations of the Solar Electron Corona: February 1964-January 1968", price 15 cents.
- UAG-8 "Data on Solar-Geophysical Activity October 24-November 6, 1968", price (includes Parts 1 and 2) \$1.75.
- UAG-9 "Data on Cosmic Ray Event of November 18, 1968 and Associated Phenomena", price 55 cents.
- UAG-10 "Atlas of Ionograms", price \$1.50.

- UAG-11 "Catalogue of Data on Solar-Terrestrial Physics" (now obsolete).
- UAG-12 "Solar-Geophysical Activity Associated with the Major Geomagnetic Storm of March 8, 1970", price (includes Parts 1-3) \$3.00.
- UAG-13 "Data on the Solar Proton Event of November 2, 1969 through the Geomagnetic Storm of November 8-10, 1969", price 50 cents.
- UAG-14 "An Experimental, Comprehensive Flare Index and Its Derivation for 'Major' Flares, 1955-1969", price 30 cents.
- UAG-15 "Catalogue of Data on Solar-Terrestrial Physics" (now obsolete).

- UAG-16 "Temporal Development of the Geographical Distribution of Auroral Absorption for 30 Substorm Events in each of IQSY (1964-65) and IASY (1969)", price 70 cents.
- UAG-17 "Ionospheric Drift Velocity Measurements at Jicamarca, Peru (July 1967-March 1970)", microfiche only, price 45 cents.
- UAG-18 "A Study of Polar Cap and Auroral Zone Magnetic Variations", price 20 cents.
- UAG-19 "Reevaluation of Solar Flares 1967", price 15 cents.
- UAG-20 "Catalogue of Data on Solar-Terrestrial Physics" (now obsolete).

- UAG-21 "Preliminary Compilation of Data for Retrospective World Interval July 26 - August 14, 1972", price 70 cents.
- UAG-22 "Auroral Electrojet Magnetic Activity Indices (AE) for 1970", price 75 cents.
- UAG-23 "U.R.S.I. Handbook of Ionogram Interpretation and Reduction", price \$1.75.
- UAG-24 "Data on Solar-Geophysical Activity Associated with the Major Ground Level Cosmic Ray Events of 24 January and 1 September 1971", price (includes Parts 1 and 2) \$2.00.
- UAG-25 "Observations of Jupiter's Sporadic Radio Emission in the Range 7.6-41 MHz, 9 September 1968 through 9 December 1971", price 35 cents.

- UAG-26 "Data Compilation for the Magnetospherically Quiet Periods February 19-23 and November 29 - December 3, 1970", price 70 cents.
- UAG-27 "High Speed Streams in the Solar Wind", price 15 cents.
- UAG-28 "Collected Data Reports on August 1972 Solar-Terrestrial Events", price (includes Parts 1-3) \$4.50.
- UAG-29 "Auroral Electrojet Magnetic Activity Indices AE (11) for 1968", price 75 cents.
- UAG-30 "Catalogue of Data on Solar-Terrestrial Physics", price \$1.75.

- UAG-31 "Auroral Electrojet Magnetic Activity Indices AE (11) for 1969", by Joe Haskell Allen, Carl C. Abston and Leslie D. Morris, National Geophysical and Solar-Terrestrial Data Center, Environmental Data Service, February 1974, 142 pages, price 75 cents.

- UAG-32 "Synoptic Radio Maps of the Sun at 3.3 mm for the Years 1967-1969", by Earle B. Mayfield and Kennon P. White III, San Fernando Observatory, Space Physics Laboratory and Fred I. Shimabukuro, Electronics Research Laboratory, Laboratory Operations, The Aerospace Corporation, El Segundo, California, 90245, April 1974, 26 pages, price 35 cents.
- UAG-33 "Auroral Electrojet Magnetic Activity Indices AE(10) for 1967", by Joe Haskell Allen, Carl C. Abston and Leslie D. Morris, National Geophysical and Solar-Terrestrial Data Center, Environmental Data Service, May 1974, 142 pages, price 75 cents.
- UAG-34 "Absorption Data for the IGY/IGC and IQSY", compiled and edited by A. H. Shapley, National Geophysical and Solar-Terrestrial Data Center, NOAA, Boulder, Colorado, U.S.A., W. R. Piggott, Science Research Council, Slough, U.K., and K. Rawer, Arbeitsgruppe für Physikalische Weltraumforschung, Freiburg, G.F.R., June 1974, 381 pages, price \$2.00.
- UAG-35 "Catalogue of Digital Geomagnetic Variation Data at World Data Center A for Solar-Terrestrial Physics", prepared by Environmental Data Service, NOAA, Boulder, Colorado, July 1974, 20 pages, price 20 cents.
- UAG-36 "An Atlas of Extreme Ultraviolet Flashes of Solar Flares Observed Via Sudden Frequency Deviations During the ATM-SKYLAB Missions", by R. F. Donnelly and E. L. Berger, NOAA Space Environment Laboratory, Lt. J. D. Busman, NOAA Commissioned Corps, B. Henson, NASA Marshall Space Flight Center, T. B. Jones, University of Leicester, UK, G. M. Lerfald, NOAA Wave Propagation Laboratory, K. Najita, University of Hawaii, W. M. Retallack, NOAA Space Environment Laboratory, and W. J. Wagner, Sacramento Peak Observatory, October 1974, 95 pages, price 55 cents.
- UAG-37 "Auroral Electrojet Magnetic Activity Indices AE(10) for 1966", by Joe Haskell Allen, Carl C. Abston and Leslie D. Morris, National Geophysical and Solar-Terrestrial Data Center, Environmental Data Service, December 1974, 142 pages, price 75 cents.
- UAG-38 "Master Station List for Solar-Terrestrial Physics Data at WDC-A for Solar-Terrestrial Physics", by R. W. Buhmann, World Data Center A for Solar-Terrestrial Physics, Juan D. Roederer, University of Denver, Denver, Colorado, M. A. Shea and D. F. Smart, A.F.C.R.L., Hanscom AFB, Massachusetts, December 1974, 110 pages, price \$1.60.
- UAG-39 "Auroral Electrojet Magnetic Activity Indices AE(11) for 1971", by Joe Haskell Allen, Carl C. Abston and Leslie D. Morris, National Geophysical and Solar-Terrestrial Data Center, Environmental Data Service, February 1975, 144 pages, price \$2.05.
- UAG-40 "H-Alpha Synoptic Charts of Solar Activity For the Period of Skylab Observations, May, 1973-March, 1974", by Patrick S. McIntosh, NOAA Environmental Research Laboratory, February 1975, 32 pages, price 56 cents.
- UAG-41 "H-Alpha Synoptic Charts of Solar Activity During the First Year of Solar Cycle 20 October, 1964 - August, 1965", by Patrick S. McIntosh, NOAA Environmental Research Laboratory, and Jerome T. Nolte, American Science and Engineering, Cambridge, Massachusetts, March 1975, 25 pages, price 48 cents.
- UAG-42 "Observations of Jupiter's Sporadic Radio Emission in the Range 7.6-80 MHz 10 December 1971 through 21 March 1975", by James W. Warwick, George A. Dulk, and Anthony C. Riddle, Department of Astro-Geophysics, University of Colorado, Boulder, Colorado 80302, April 1975, 49 pages, price \$1.15.
- UAG-43 "Catalog of Observation Times of Ground-Based Skylab-Coordinated Solar Observing Programs", compiled by Helen E. Coffey, World Data Center A for Solar-Terrestrial Physics, May 1975, 159 pages.